

Weatherly No. 400
Catalog No. 431-2030
Edition 2016
Supersedes 431-2030 [2013]



FLEET + HEAVY DUTY APPLICATIONS

Includes 2001 + Newer Medium/H.D. Trucks + All Buses,
Construction Equipment, Refrigeration + Power Units
For 2000 + Older Medium/H.D. Trucks, See Catalog #431-2030V



IN IT FOR THE LONGEST HAUL

The FleetRunner logo, featuring a green stylized arrow pointing right, followed by the word "FleetRunner" in a bold, green, sans-serif font with a registered trademark symbol.

FLEETRANNER[®] MICRO-V[®] BELTS

Get the lowest cost per mile when you go with Gates. Engineered with an advanced blend of EPDM rubber technology, FleetRunner belts are designed to withstand the harsh environment of modern engine compartments. This makes them an incredible value, reducing fleet operation costs while performing at peak efficiency. With more than 100 years of innovation and excellence under our belts, you know that Gates is in it with you for the longest haul.

Gates.com/FleetRunner

Table of Contents

Table of Contents & Warranty	A1
Product Pages	A2 - A63
Index by Equipment Type and Make	B1 - B2
Model & Manufacturer Index	C1 - C23
Abbreviations	C24
Belts and Coolant Hose for Medium/Heavy-Duty Trucks (2001 & Newer)	1 - 185
Belts for Truck Refrigeration Units	186 - 194
Belts and Coolant Hose for School Buses	195 - 366
Belts and Coolant Hose for Transit Buses	367 - 386
Belts and Coolant Hose for Road & Construction Equipment	387 - 534
Belts and Coolant Hose for Power Units	535 - 557
Belts and Coolant Hoser for Lift & Industrial Trucks	558 - 611
Straight Hose Size List	613 - 614
Green Stripe® Truck and Bus V-Belts	615 - 616
Green Stripe® Truck and Bus PowerBand® Belts	619 - 620
FleetRunner® Heavy-Duty V-Belts	621 - 622
XL® Belts	623 - 626
FleetRunner® Micro-V® Belts	627 - 632
Century Series™ Micro-V® Belts	633 - 642
Special Belts	643 - 644
Hi-Power® II V-Belts	645 - 646
Hi-Power® II PowerBand® Belts	647
Super HC® V-Belts	648
Super HC® PowerBand® Belts	649
Tri-Power® V-Belts	650
Truflex® and PoweRated® Belts	651 - 652
Green Stripe® Vulco-Flex® Coolant Hose	653 - 654
Vulco-Flex® II Coolant Hose (Standard)	655 - 656
Air Vent Hose - Manufacturers' Part Number Listing	657
Air Vent Hose - Competitive Changeover Listing	658
Air Vent Hose Dimensions	659 - 661
Changeover Listing - FleetRunner® to Standard Belts	662 - 663

Warning

Be safe! Do not use Gates belts, pulleys or sprockets on any aircraft propeller or rotor drive systems or in-flight accessory drives. Gates products are not designed or intended for aircraft use.

Caution

Use Gates products only on applications specified in Gates literature. Install and maintain products according to the vehicle manufacturers' recommended procedures and with recommended tools. Failure to follow these instructions could result in injury or property damage. Gates disclaims all liability due to failure to follow these instructions.

Limited Warranty for the Life of the Merchandise

Goods are warranted to be free from defects in material or workmanship for the life of the Goods (or the published recommended replacement interval specified by Gates). Gates will replace or repair, at its option, any Goods proved defective in material or workmanship during the warranty period. This is the sole remedy for breach of warranty. Color fade and color difference is not warranted. This warranty is void if the defect is caused by improper installation, use or maintenance of the Goods, or used for racing or competition. Goods are not warranted to comply with laws that may apply to uses of the Goods not stated in related materials, e.g., use in manned or unmanned aviation or life support applications.

ALL OTHER WARRANTIES, EXPRESS OR IMPLIED, INCLUDING, BUT NOT LIMITED TO WARRANTIES OF MERCHANTABILITY AND FITNESS FOR A PARTICULAR PURPOSE, ARE EXPRESSLY DISCLAIMED. FAILURE TO REPLACE TIMING BELTS OR OTHER GATES PRODUCTS AS SPECIFIED MAY RESULT IN CATASTROPHIC ENGINE OR EQUIPMENT DAMAGE FOR WHICH GATES DISCLAIMS ALL RESPONSIBILITY, TO THE EXTENT PERMITTED BY APPLICABLE LAW.

This publication contains the latest information available to our engineers. If you require additional application or part number information, contact the Automotive Product Application Tech Line at 303-744-5651.

Accessory Belt Drive Systems

FleetRunner® Micro-V® Component Kits

Gates heavy-duty belt and tensioner kits make it easy to service front-end accessory drives. Eliminate customer comebacks by fixing the vehicle the first time by servicing the entire serpentine drive. Neglecting to replace the tensioner and pulley[s] at the same time you replace the belt can ultimately shorten the life of the belt as well as other front-end accessory components.



Kits engineered specifically for school buses contain better-than-OE components for optimal repairs and long-lasting performance. Each kit contains a FleetRunner Micro-V belt and a DriveAlign® tensioner, and is designed for systems with high-operating temperatures and long-idle times.

FleetRunner® Micro-V® Belts

Designed for the toughest applications, FleetRunner construction provides superior flexibility, stability, load capacity and unsurpassed belt life. Patented materials deliver peak performance at extreme prolonged operating temperatures making this belt the ultimate problem solver. An advanced blend of EPDM rubber technology withstands the modern threats of deterioration from increased exposure to ozone and water-based coolants. FleetRunner does this all while providing the lowest cost per mile for fleets, including $\frac{3}{4}$ and 1 ton pickups.

- Belt of choice by fleets, including $\frac{3}{4}$ and 1 ton pickups.
- Lowest cost per mile.
- Consistently outperforms all competitors.
- Outstanding crack resistance at extreme temperatures.
- Problem-solver designed for the toughest applications.

Century™ Series Micro-V® Belts

Import or domestic, car or truck, every vehicle can depend on the superior quality of Gates precision fit Century Series Micro-V belts. With advanced technology that matches the OE size, construction and materials Century Series Micro-V ensures optimal vehicle performance. Micro-V belts provide peak operating performance while delivering the highest value available.

- Meets or exceeds all specifications from the Original Equipment Manufacturer.
- Designed for small diameter pulleys, backside idlers, and for use with [or without] automatic tensioners.
- Special belt constructions eliminate belt noise, reduce tension loss, and solve problem drive applications.
- Utilizes advanced materials like Aramid Fiber found in bullet-proof vests and crack and heat resistant EPDM materials.
- Unique form grinding of each individual belt assures precise dimensional control.
- Meets or exceeds SAE J1459, SAE J2432, and SAE J1596 specifications.

Gates also offers Century™ Series Micro-V® Green Stripe® belts with greater load-carrying capacity designed for demanding, heavy-service drives.

Accessory Belt Drive Systems

Century™ Series Micro-V® Dual-Sided Belts

For replacing original equipment belts on serpentine drives that require a higher degree of efficiency when transmitting power. Designed for small diameter pulleys and for use with or without automatic tensioners.

- V-ribbed on both sides of the belt.
- Specially designed to resist wear and cracking due to overall reduced thickness in construction.
- Broad coverage on unique applications.
- Custom setup for Gates specialized solution kits for Serpentine drives that cause problems from the OEM.

XL® V-Belts

Replacement belt for the most demanding engine drives. Due to thermal forces, this variable notched belt tightens on the drive as it gets hot. This results in improved belt performance by reducing tension decay and noise.

- Fiber-loaded rubber stock puts more flexibility along the length of the belt, yet gives the belt greater lateral stability in the pulley.
- Thermally active tensile cords for maintenance-free performance when properly installed and tensioned.
- Form ground to ensure precise top width and sidewall dimensional control for proper fit in pulley as well as a smoother, quieter running belt.
- Meets or exceeds SAE J636C specifications.

Gates also offers Green Stripe® XL® V-belts as a premium-quality replacement for heavy-duty engines.

FleetRunner® Heavy-Duty V-Belts

Patented EPDM construction with distinct green overcord built specifically for more durability and longer life on heavy-duty drives.

- Outperforms the competition on the most troublesome drives.
- Special compound provides un-matched flexibility, stability, load carrying capacity and belt life.
- Patented material provides peak performance at extreme prolonged operating temperatures.
- Heavy-duty construction resists cracking and wear.
- Oil and heat-resistant.
- Unique undercord notch pattern offers increased flexibility for smaller diameter pulleys.
- Available in over 70 sizes.

Green Stripe® PowerBand® Belts

Designed for problem, heavy-duty, heavily vibrating applications requiring belt sets. Tie-band feature joining belts together ensures stability lacking in ordinary belt sets.

- Even load distribution between strands provides better shock load absorption.
- Belt cannot turn over or slip off drive.
- Unique tensile cord design gives belt extra strength, added flexibility and shock-load resistance.
- Molded notches reduce bending stress, especially on small diameter pulleys, while dissipating heat.
- Meets or exceeds SAE J1459 specifications.

Accessory Belt Drive Systems

Green Stripe® Truck and Bus Series V-Belts

Specifically designed for heavy-duty truck, bus and off-road equipment applications. Absorbs normal shock loads without damage to belt.

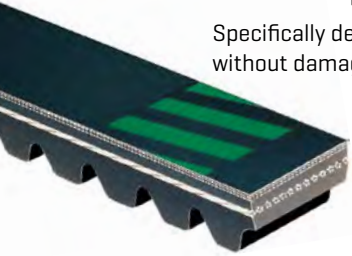

- Special tensile cords give high stretch resistance.
- Special notch design resists cracking while providing tensile member support during operation.
- Oil and heat-resistant construction throughout.
- Meets SAE J636b and SAE J637 specifications.

Gates also offers Green Stripe Truck and Bus Series PowerBand V-belts for problem, heavy-duty, heavily vibrating applications requiring belt sets.

Hi-Power® II V-Belts

Featuring a composite, multi-purpose construction, these belts resist oil and heat, ozone, sunlight, weather and aging. Suitable for all industrial applications, including v-flat drives.



- Gates curves provide proper cord support and full contact with the sheave-groove for uniform loading, uniform wear and increased belt life.
- Flex-bonded cords are strongly bonded to the body of the belt resulting in equal load distribution and the absorption of bending stress without cord deterioration.
- The Flex-Weave® Cover is constructed for longer cover life, providing extended protection to the core of the belt from oil, dirt and heat.
- Meets ARPM/RMA IP-3-2 oil and heat resistance standards.
- Meets ARPM/RMA IP-3-3 static conductivity requirements.

Gates also offers Hi-Power II PowerBand V-belts allowing multiple belts to function as a single unit with even load distribution and each strand fitting securely in the sheave groove.

Tri-Power® V-Belts

Constructed with Gates proprietary construction, this belt has a superior combination of flex and load carrying capacity, as well as less stretch resulting in less maintenance. Suitable for all industrial applications, particularly where small or sub-minimal sheave diameters are required.



- Notches molded into the belt during manufacturing increase flexibility, making this belt well suited for drives with smaller diameter sheaves.
- Belt edge is machined for even sheave groove contact resulting in less slip and wear.
- Flex-bonded cords are strongly bonded to the body of the belt resulting in equal load distribution and the absorption of bending stress without cord deterioration.
- Meets ARPM/RMA IP-3-2 oil and heat resistance standards.
- Meets ARPM/RMA IP-3-3 static conductivity requirements.

Gates also offers Tri-Power II PowerBand V-belts allowing multiple belts to function as a single unit with even load distribution and each strand fitting securely in the sheave groove.

Accessory Belt Drive Systems

DriveAlign® Heavy-Duty Automatic Belt Tensioners

The longest lasting belt tensioners in the industry. Engineered to exceed demanding OEM requirements. In laboratory tests, under extreme peak-to-peak vibration and contamination tests, DriveAlign heavy-duty tensioners lasted up to three times longer than competitive aftermarket tensioners.



- Labyrinth Seal – prevents contamination of internal parts for maximum durability and service life.
- Machined Steel Pulley – reduces surface wear while shielding internal bearing from outside contaminants.
- Double Row Bearings – twin rows of bearings carry more load and last up to three times longer than two individual bearings.
- Optimized Components – engineered for maximum strength and durability.
- Patented Design – provides superior belt alignment and tension for improved drive efficiency and life.
- Round Spring Wire – includes chrome-silicone torsion spring for less flex-fatigue than flat-wire designs.
- Patented Damping Mechanism – provides maximum stability, reducing vibration and increasing the life of belt, tensioner and other accessory drive components.

DriveAlign® Heavy-Duty Idler Pulleys

Long-lasting pulleys built to endure the rigors of today's heavy-duty, fleet and off-road equipment.



- Superior bearings outperform OE idler pulleys.
- Robust and high quality pulley materials to withstand contaminants.
- New hardware included on some popular applications.
- Built with precise dimensional tolerance to ensure proper fit and long-lasting performance.
- Built with corrosive-resistant coating to prevent rust and increase durability.

Fan Pulley Brackets

OE-exact fan pulley brackets are constructed from high-quality materials for maximum durability and strength.



- High-quality bearings and casting materials withstand vibrations and imbalances for maximum service life.
- OE-exact design provides a precise fit to ensure easy installation.
- Designed to provide the proper structure and support for the fan clutch.

Industrial Belts

Super HC® V-Belts

Pioneered by Gates, these “narrow” cross-sections can transmit up to three times the horsepower of the classical cross-sections [A, B, C and D] in the same amount of drive space. Suitable for all industrial applications, particularly where space, weight and horsepower capacity are critical.

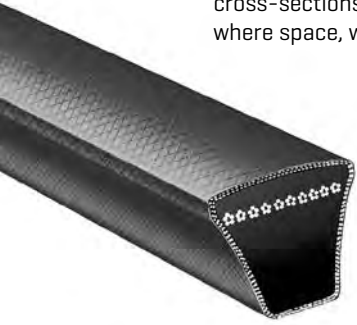

- Gates curves provide proper cord support and full contact with the sheave-groove for uniform loading, uniform wear and increased belt life.
- Flex-bonded cords are strongly bonded to the body of the belt resulting in equal load distribution and the absorption of bending stress without cord deterioration.
- The Flex-Weave® cover is constructed for longer cover life, providing extended protection to the core of the belt from oil, dirt, and heat.
- Meets ARPM/RMA IP-3-2 oil and heat resistance standards.
- Meets ARPM/RMA IP-3-3 static conductivity requirements.

Gates also offers Super HC PowerBand belts allowing multiple belts to function as a single unit with even load distribution and each strand fitting securely in the sheave groove.

Super HC® Molded Notch V-Belts

Constructed with Gates proprietary construction, this belt has a superior combination of flex and load carrying capacity, as well as transmitting more horsepower than the classical cross sections in the same amount of drive space. Suitable for all industrial applications, particularly where space, weight and horsepower capacity are critical.

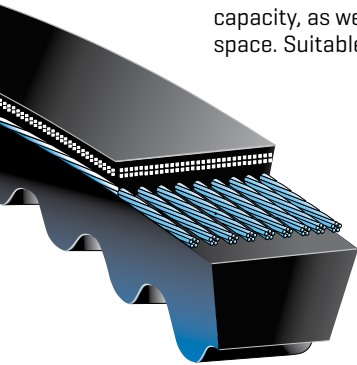

- Notches molded into the belt during manufacturing increase flexibility, making this belt well suited for drives with smaller diameter sheaves.
- Belt edge is machined for even sheave groove contact resulting in smoother running, less slip and wear.
- Flex-bonded cords are strongly bonded to the body of the belt resulting in equal load distribution and the absorption of bending stress without cord deterioration.
- Patented ethylene material construction provides -70°F to +250°F [-57°C to +121°C] temperature range to resist belt cracking.
- Meets ARPM/RMA IP-3-2 oil and heat resistance standards.
- Meets ARPM/RMA IP-3-3 static conductivity requirements.

Gates also offers Super HC Molded Notch PowerBand V-belts allowing multiple belts to function as a single unit with even load distribution and each strand fitting securely in the sheave groove.

Industrial Micro-V® Belts (J, L and M Series)

Exclusive truncated [shortened] profile gives Gates Micro-V belts increased flexibility, reduced heat build-up and allows performance at higher speeds on smaller diameter sheaves. Well suited for applications such as appliances, outdoor power equipment, roller conveyors, machine tools, medical equipment and exercise equipment.



- Fiber reinforced ribs for excellent wear resistance.
- High modulus, low stretch tensile member for added strength and dependability.
- Smooth running for minimal vibration at high speeds.
- Meets ARPM/RMA IP-3-2 oil and heat resistance standards.
- Meets ARPM/RMA IP-3-3 static conductivity requirements.

Lawn & Garden Belt

BladeRunner® Belts

The BladeRunner belt is an aftermarket belt designed to fit specific applications. The BladeRunner belt provides exact OE fit, construction and performance when installed on leading lawn, garden and outdoor power equipment.



- Meets or exceeds the performance of the OE belt on the equipment that it is applied to, which reduces costly downtime and labor associated with belt replacement.
- Utilizes Aramid Cord construction which has a higher tensile strength than steel.
- Exact fit to ensure smooth engagement of clutch and reduced harshness of operation.
- Various constructions (V, Cogged, Synchronous) available in order to meet the needs of the customer.
- Superior performance over standard fractional horsepower belts on recommended applications.

Cooling Systems - Water Pumps

Water Pumps for Heavy-Duty Applications



- Our heavy-duty water pump offering is designed to handle rugged Fleet standards.
- Pumps manufactured to ISO/TS 16949 standards.
- 100% fully tested unitized bearings/seals.
- Gates heavy-duty water pumps, represented as a part number with an HD suffix, carry a warranty of 18 months or 150,000 miles / 5,400 hours, whichever comes first.
- Computerized machined surfaces for proper fit/sealing.

Cooling Systems - Hose

Hose Shelf Life

Storage environment, along with rubber materials, can vary the shelf life limit. Shelf life is difficult to quantify as many variables affect the hose. Proper storage precautions can result in three to five years of shelf life. Beyond this time, there can be a significant service life decrease, depending on storage environment variables.

Some variables include:

Hose should be stored in a cool, dry area never exceeding +100°F [+38°C]. If stored below freezing, pre-warming may be required prior to handling, testing and placing into service. Store hose in original container. Never stack hose too high, as its weight can crush hose at the bottom of the stack. Gates recommends hose in extended storage be visually inspected and tested prior to use. Hose judged marginal should be replaced to avoid potential failure, property damage or bodily injury. Store hose on a first-in/first-out basis. Unusually long storage, or poor storage environment can deteriorate hose, reduce performance and may lead to premature failure.

Molded Coolant Hose

Gates molded coolant hose is manufactured to fit specific applications. Equivalent in design to OEM specifications. Approved for marine applications.



- Recommend for upper, lower, by-pass, heater and other coolant hose applications.
 - Heat and ozone resistant cover.
 - Engineered to resist electrochemical degradation - the leading cause of hose failure.
 - Re-engineered materials resist vacuum collapse, this reduces the need for internal springs in many applications.
 - Meets SAE 20R4 and 20R3 Type EC Class D-1 and D-2 specifications.
 - Temperature rating: -40°F to +275°F [-40°C to +135°C] in coolant hose applications.
- Note:** Gates recommends replacing standard worm drive and spring loaded clamps with Gates PowerGrip® SB clamps each time a new coolant hose is installed.
- Caution:** Do not use for fuel or oil transfer applications.

Branched Radiator Hose

Molded to fit specific applications. Factory quality connections are durable and eliminate coolant leaks.



- Engineered to resist electrochemical degradation - the leading cause of hose failure.
 - Heat and ozone resistant cover.
 - Meets SAE 20R4 and 20R3 Type EC Class D-1 and D-2 specifications.
 - Temperature rating: -40°F to +275°F [-40°C to +135°C] in coolant hose applications.
- Note:** Gates recommends replacing standard worm drive and spring loaded clamps with PowerGrip® SB clamps each time a new coolant hose is installed.
- Caution:** Do not use for fuel or oil transfer applications.

Cooling Systems - Hose

Vulco-Flex® II Coolant Hose

Gates Vulco-Flex II hose will bend in almost any direction. It easily replicates the angles and planes of a wide variety of expensive original equipment coolant hose, for quick, easy replacement.



- Improved sealing surface for greater leak resistance and increased flexibility for easier installation.
- Heat and ozone resistant cover.
- Rated for SAE 20R5 Class D-2 performance.
- High temperature rating up to +257°F [+125°C].

Note: Gates recommends replacing clamps each time a new coolant hose is installed.
Caution: Do not use for fuel or oil transfer applications.

Green Stripe® Vulco-Flex® Coolant Hose

Heavy-duty flexible hose designed to replace straight or curved coolant hoses. The benefit is maximum coverage with minimum inventory. Hose inside diameter remains constant from end to end. No convolutions inside hose so tube is smooth, allowing free coolant flow. Approved for marine applications.



- Excellent flexibility, yet collapse and kink resistant.
- Extra strength fabric reinforcement with helical steel wire spiral molded between tube and cover.
- Heat-resistant construction throughout.
- EPDM tube and neoprene cover for extended service life.
- Performs to SAE 20R5 Type EC Class D-2 specifications.
- Engineered to resist electrochemical degradation – the leading cause of hose failure.
- Temperature rating: -40°F to +257°F [-40°C to +125°C].
- Working pressure 40 psi maximum.

Caution: Do not use for fuel or oil transfer applications.

Vulco Straight Coolant Hose

Specially engineered stick hose is ideal for straight coolant/air connections in automotive, stationary engine, industrial and home applications.

- Heat-resistant cover.
- Meets SAE 20R1 Standard Wall Class D-2 requirements.
- Cover marked in one-inch increments for easy measuring and cutting allows “custom fit” light-duty coolant installations.
- Temperature rating: -40°F to +257°F [-40°C to +125°C].

Caution: Do not use for fuel or oil transfer applications.

Part No.	I.D. [In.]	Work. Press. [psi]	Part No.	I.D. [In.]	Work. Press. [psi]	Part No.	I.D. [In.]	Work. Press. [psi]
24008	1/2	105	24026	1 5/8	55	24042	2 5/8	30
24012	3/4	80	24028	1 3/4	50	24044	2 3/4	30
24014	7/8	80	24030	1 7/8	50	24046	2 7/8	25
24016	1	75	24032	2	50	24048	3	25
24018	1 1/8	75	24034	2 1/8	45	24052	3 1/4	20
24020	1 1/4	65	24036	2 1/4	40	24056	3 1/2	18
24022	1 3/8	65	24038	2 3/8	40	24064	4	12
24024	1 1/2	60	24040	2 1/2	35			

Cooling Systems - Hose

Wire-Inserted Green Stripe® Coolant Hose



Provides the ability to replace many sizes of tailor-made curved hoses. Results in maximum coverage with minimum inventory. Approved for marine applications.



- Heavy-duty fabric reinforcement with helical carbon steel wire.
- Bends easily to make curved connections.
- Cuts easily with knife and wire cutters to reduce installation time.
- Exceeds SAE 20R2 Type EC (Class D2 Tube and cover) except in vacuum applications.
- Engineered to resist electrochemical degradation – the leading cause of hose failure.
- Temperature rating: -40°F to +257°F [-40°C to +125°C].

Note: Long spans must be supported every 3 feet.

Caution: Do not use for fuel or oil transfer applications.

Part No. 5 Ft.	Part No. 10 Ft.	I.D. [In.]	Work. Press. [psi]	Vacuum [In. Hg.]	Min. Bend Radius [In.]	Part No. 5 Ft.	Part No. 10 Ft.	I.D. [In.]	Work. Press. [psi]	Vacuum [In. Hg.]	Min. Bend Radius [In.]
24916	28316	1	100	25	2	24938	—	2 ³ / ₈	50	20	6 ¹ / ₂
24918	—	1 ¹ / ₈	100	25	2 ¹ / ₂	24940	28340	2 ¹ / ₂	50	20	6 ¹ / ₂
24920	28320	1 ¹ / ₄	100	25	2 ¹ / ₂	24942	—	2 ⁵ / ₈	40	15	7 ¹ / ₂
24922	—	1 ³ / ₈	85	25	3	24944	28344	2 ³ / ₄	40	15	7 ¹ / ₂
24924	28324	1 ¹ / ₂	85	20	3 ¹ / ₂	24946	—	2 ⁷ / ₈	40	15	9
24926	28326	1 ⁵ / ₈	75	20	3 ¹ / ₂	24948	28348	3	40	15	9
24928	28328	1 ³ / ₄	75	20	4	24956	28356	3 ¹ / ₂	35	15	12
24930	28330	1 ⁷ / ₈	60	20	4 ¹ / ₂	24964	—	4	30	10	20
24932	28332	2	60	20	4 ¹ / ₂	24980	—	5	15	5	24
24934	—	2 ¹ / ₈	55	20	5 ¹ / ₂	24996	—	6	15	5	30
24936	28336	2 ¹ / ₄	55	20	5 ¹ / ₂						

Green Stripe® 4-Ply Coolant Hose



For severe operating conditions found on stationary engines, construction equipment and off-road vehicle applications. Nitrile tube specially compounded to handle common coolants and additives.



- Four-ply woven, heavy-duty fabric reinforcement.
- Neoprene cover resists heat, abrasion and oil.
- Handles higher temperatures and resists petroleum additives.
- Exceeds SAE 20R1 (Class B Tube, Class C Cover, Heavy Wall).
- Reduces water loss from water permeating the hose wall and cover, a distinct advantage over silicone.
- Engineered to resist electrochemical degradation – the leading cause of hose failure.
- Temperature rating: -40°F to +212°F [-40°C to +100°C], intermittent to +257°F [+125°C].

Caution: Do not use for gasoline or diesel transfer applications.

Part No.	I.D. [In.]	Work. Press. [psi]	Part No.	I.D. [In.]	Work. Press. [psi]	Part No.	I.D. [In.]	Work. Press. [psi]
24428	1 ³ / ₄	100	24440	2 ¹ / ₂	75	24452	3 ¹ / ₄	50
24430	1 ⁷ / ₈	100	24442	2 ⁵ / ₈	75	24456	3 ¹ / ₂	50
24432	2	90	24444	2 ³ / ₄	60	24458	3 ⁵ / ₈	50
24434	2 ¹ / ₈	90	24446	2 ⁷ / ₈	60	24460	3 ³ / ₄	50
24436	2 ¹ / ₄	90	24448	3	60	24464	4	40
24438	2 ³ / ₈	90	24450	3 ¹ / ₈	60	24480	5	40

Cooling Systems - Hose

Green Stripe® 2-Ply Straight Coolant Hose

Stick hose designed for demanding heavy-duty coolant/air applications. Approved for marine applications.

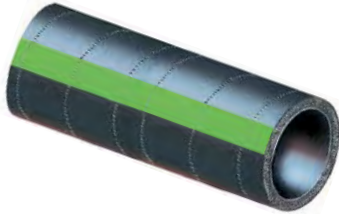

- Two-ply bias fabric construction to maximize flexibility and strength.
- Resists "cold water leaks" due to advanced EPDM tube and cover that stay soft and pliable, even under adverse operating conditions.
- Exceeds SAE 20R1 Type EC (Class D-1 Tube, and cover, Standard Wall).
- Cover marked in one-inch increments to facilitate approximate cut lengths, allows "custom-fit" installations.
- Engineered to resist electrochemical degradation – the leading cause of hose failure.
- Temperature rating: -40°F to +257°F [-40°C to +125°C].



Note: For a maintenance free connection, use PowerGrip® SB clamps.

Caution: Do not use for fuel or oil transfer applications.

Part No.	I.D. [In.]	Work. Press. [psi]	Part No.	I.D. [In.]	Work. Press. [psi]	Part No.	I.D. [In.]	Work. Press. [psi]
24212	3/4	100	24230	1 7/8	75	24248	3	25
24214	7/8	100	24232	2	60	24250	3 3/8	25
24216	1	100	24234	2 1/8	60	24252	3 3/4	20
24218	1 1/8	100	24236	2 1/4	60	24256	3 1/2	18
24220	1 1/4	100	24238	2 3/8	60	24260	3 3/4	18
24222	1 3/8	100	24240	2 1/2	60	24264	4	12
24224	1 1/2	100	24242	2 5/8	60	24272	4 1/2	12
24226	1 5/8	85	24244	2 3/4	60			
24228	1 3/4	75	24246	2 7/8	55			

Green Stripe® Vibraflex® Coolant Hose

For heavy-duty applications requiring short length hose that must absorb vibration and/or fitting misalignment. High flexibility reduces installation time and provides lower cost-per-mile operation.

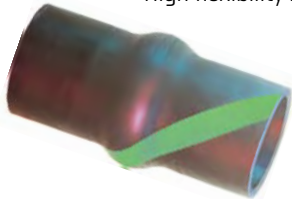

- Oil and heat-resistant nitrile tube.
- Oil, abrasion and heat-resistant neoprene cover.
- Exceeds SAE J20 (Class B Tube and Class C Cover).
- Two-ply fabric reinforced.
- Temperature rating: -40°F to +212°F [-40°C to +100°C].



Caution: Do not use for gasoline or diesel transfer applications.

Part No.	I.D. [In.]	Work. Press. [psi]	Part No.	I.D. [In.]	Work. Press. [psi]	Part No.	I.D. [In.]	Work. Press. [psi]
23505	1 1/4 x 4	70	23547	2 1/4 x 4 1/2	40	23567	2 3/4 x 4 1/2	30
23511	1 3/8 x 5	60	23557	2 3/8 x 5	35	23568	2 3/4 x 5 3/8	30
23515	1 1/2 x 5	60	23559	2 3/8 x 6 1/4	35	23572	3 x 4	25
23520	1 3/4 x 5	55	23562	2 1/2 x 4 1/2	35	23575	3 x 7	25
23531	2 x 3 1/2	50	23550	2 1/2 x 6	35	23585	3 1/2 x 5 1/2	25
23533	2 x 5	50	23566	2 3/4 x 3 1/4	30			

Cooling Systems - Hose

Silicone Coolant Hose



Extra long-lasting hose constructed with silicone rubber. Ideal for extremely high temperature service in radiator, heater and other coolant transfer hose applications.

- Excellent for extreme ambient and radiant temperature conditions.
- Resists weathering, ozone, heat and coolant deterioration.
- Silicone tube and cover resist prolonged exposure to under-hood and coolant heat.
- Use PowerGrip® SB clamps or silicone hose clamps.
- Exceeds SAE 20R1 (Class A Standard Wall).
- Temperature rating: -70°F to +350°F [-56°C to +177°C].

Caution: Do not use for fuel or oil transfer applications.

Part No.	I.D. [In.]	Work. Press. [psi]	Part No.	I.D. [In.]	Work. Press. [psi]	Part No.	I.D. [In.]	Work. Press. [psi]	Part No.	I.D. [In.]	Work. Press. [psi]
24808	1/2	110	24820	1 1/4	85	24836	2 1/4	75	24852	3 3/4	40
24810	5/8	110	24822	1 3/8	85	24838	2 3/8	65	24856	3 1/2	35
24812	3/4	110	24824	1 1/2	85	24840	2 1/2	65	24860	3 3/4	35
24814	7/8	110	24826	1 5/8	80	24844	2 3/4	50	24864	4	35
24816	1	90	24828	1 3/4	80	24848	3	50	24872	4 1/2	25
24818	1 1/8	90	24832	2	75	24850	3 1/8	40			

Cooling Systems - Hose

FleetRunner® Hi-Temp Coolant Hose

Built to excel in the extreme conditions of modern heavy-duty engine compartments, FleetRunner Hi-Temp Straight Coolant Hose is the durable solution for extended use in heavy-duty trucks.



- Advance peroxide-cured EPDM rubber.
- Exceeds SAE 20R1 specifications.
- Resists electrochemical degradation.
- High working pressure rating.
- Temperature rating: -40°F to 300°F [-40°C to +149°C].

Part No.	I.D. [In.]	Work. Press. [psi]	Part No.	I.D. [In.]	Work. Press. [psi]
24614	7/8" X 3'	150	24630	17/8" x 3'	150
24616	1" x 3'	150	24632	2" x 3'	150
24618	1 1/8" x 3'	150	24636	2 1/4" x 3'	125
24620	1 1/4" x 3'	150	24638	2 3/8" x 3'	125
24622	1 3/8" x 3'	150	24640	2 1/2" x 3'	125
24624	1 1/2" x 3'	150	24644	2 3/4" x 3'	125
24626	1 5/8" x 3'	150	24648	3" x 3'	125
24628	1 3/4" x 3'	150			

Molded Silicone Coolant Hose

Heavy-duty engines with advanced emissions systems (from 2007 to current model year) produce higher under-hood temperatures, requiring the use of silicone coolant hose. In these low engine-air-flow and high-heat conditions, Gates Silicone Coolant Hose is the perfect product.



- Premium 4-ply construction.
- High-heat resistance material meets or exceeds OE specifications.
- Industry standard blue cover for easy identification.
- Used when hose routing passes near turbo or hot side of the charged air system.

Gates also offers application-specific molded silicone coolant hose for exact dimensional specifications.

45° Bent [+350°F/+177°C]		90° Elbow [+350°F/+177°C]		Hi-Temp [+500°F/+260°C]	
Part No.	I.D. [In.]	Part No.	I.D. [In.]	Part No.	I.D. [In.]
28205	1 3/4	28217	1 3/4	28225	1
28206	2	28210	2	28226	1 1/4
28207	2 1/4	28211	2 1/4	28227	1 1/2
28200	2 1/2	28212	2 1/2	28228	1 3/4
28201	2 3/4	28213	2 3/4	28229	2
28202	3	28214	3	28230	2 1/4
28203	3 1/2	28215	3 1/2	28231	2 1/2
28204	4	28216	4	28232	2 3/4
				28233	3

Cooling Systems - Hose

90° Molded Heater Hose

Especially designed for difficult heater hose applications requiring sharp 90° bends in the hose. Eliminates the need for extensive inventory of OE type curved heater hose. Just 22 sizes handle thousands of applications.



- Engineered to resist electrochemical degradation – the leading cause of hose failure.
- Resists water permeation.
- Similar to heater SAE 20R3 Type EC Class D-2.
- Use with heater hose connectors and bulk heater hose for virtually complete molded heater hose coverage.
- Temperature rating: -40°F to +275°F [-40°C to +135°C].

Caution: Do not use for fuel or oil transfer applications.

Arm Lengths [In.]	Arm Lengths [mm]	1/4" [6.35mm]	5/16" [7.9mm]	3/8" [9.5mm]	1/2" [12.7mm]	5/8" [15.9mm]	5/8" x 3/4" [15.0 x 19.1mm]	3/4" x 5/8" [19.1 x 15.9mm]	3/4" [19.0mm]
4 x 6	101.6 x 152.4	18010	18020	18030	28460	28466	18079	18070	28474
4 x 12	101.6 x 304.8	18011	18021	18031	28461	28467	—	18071	28475
4 x 18	101.6 x 457.2	—	—	—	28462	28468	18076	—	28476
8 x 18	203.2 x 457.2	—	—	—	28463	28469	—	18072	—
4 x 24	101.6 x 609.6	—	—	—	28464	28470	—	18073	28477
8 x 24	203.2 x 609.6	—	—	—	—	—	—	—	28478
4 x 33	101.6 x 825.0	—	—	—	—	—	18077	—	—
8 x 34	203.2 x 863.6	—	—	—	—	—	—	18078	—
4 x 36	101.6 x 914.4	—	—	—	28465	28471	—	18074	28479
4 x 48	101.6 x 1219.2	—	—	—	—	28472	—	—	28480
4 x 60	101.6 x 1524.0	—	—	—	—	28473	—	18075	28481

Firewall® Heater Hose

Extra heavy-duty hose designed for maximum durability. Easily recognized by its red cover.



- Unaffected by most coolants and non-oil based coolant additives.
- Unaffected by high cooling system pressures.
- Good resistance to high temperatures for extended periods of time.
- Similar to SAE 20R3 Class D-2.
- Temperature rating: -40°F to +257°F [-40°C to +125°C].

Caution: Do not use for fuel or oil transfer applications.

Part No.	I.D. [In.]	Length [Ft.]	Working Pressure [psi]
28430	1/2	50	60
28431	5/8	50	60
28432	3/4	50	50
28433	5/8	250	60
28434	3/4	250	50

Cooling Systems - Hose

Green Stripe® Heater Hose

Heavy-duty construction assures dependable operation in truck, bus and off-road equipment heater systems. For a maintenance free connection, install with PowerGrip® SB clamps. Approved for marine applications.

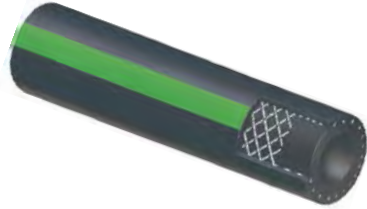

- Green Stripe construction provides best cost-per-mile economics.
- Cover is abrasion resistant.
- Advanced EPDM tube, cover and reinforcement withstand high under-hood and coolant temperatures. Designed for extended use without cracking or hardening.
- Engineered to resist electrochemical degradation – the leading cause of hose failure.
- Exceeds SAE 20R1 Type EC, Standard Wall Class D-1.
- Reduces water loss from water permeating the hose wall and cover, a distinct advantage over silicone.
- Temperature rating: -40°F to +275°F [-40°C to +135°C].

Caution: Do not use for fuel or oil transfer applications.

Part No.	I.D. [In.]	Length [Ft.]	Working Pressure [psi]
28439	1/2	50	105
28441	5/8	50	95
28442	3/4	50	80
28443	7/8	50	80
28444	1	50	75
28445	1 1/4	50	70
28440	1/2	300	105
28447	5/8	300	95
28448	3/4	300	80
28449	1	300	75

Polybagged Safety Stripe® Heater Hose

Ideal self-service package for retail-oriented merchandising. Fits standard pegboard displays.



- Package measures 12" wide x 13" high.
- Hose comes in 6 ft. lengths of Gates Safety Stripe heater hose in 3/8", 1/2", 5/8" and 3/4" I.D.

Part No.	I.D. [In.]
28489	3/8
28490	1/2
28491	5/8
28492	3/4

Cooling Systems - Hose

Silicone Heater Hose

Constructed with silicone rubber. Ideal for extremely high temperature service in radiator, heater and other coolant transfer hose applications. Approved for marine applications.



- Reinforced with tough, high temperature resistant polyester textile cords.
- Exceptionally flexible.
- Highly resistant to weathering, coolant deterioration, ozone and temperature extremes.
- Exceeds SAE 20R3 Class A Tube and Cover.
- Can be used for emission hose applications.
- For proper installation, use Gates PowerGrip® SB clamps or Gates silicone hose clamps.
- Temperature rating: -70°F to +400°F [-57°C to +204°C].

Caution: Do not use for fuel or oil transfer applications.

Part No.	I.D. [In.]	Length [Ft.]	Work. Press. [psi]
26239	3/8	25	60
26240	1/2	25	60
26241	5/8	25	60
26242	3/4	25	50
26244	1	25	45

Heavy-Duty Coolant Tubes

Coolant Tubes can be a challenge to service and are known to fail frequently. Install Gates Coolant Tubes and cut downtime - saving you money in the long run.



- Gates TuffCoat™ plating resists rust at least twice as long as OE coolant tubes.
- 10-15% thicker tube wall to limit tube damage during installation.
- State-of-the-art bending and forming technology for simple and precise installation.
- Silver color tubes allows for easier detection of leaks.
- Manufactured in the U.S.A.

Cooling Systems - Components

Dual I.D. Heater Hose



Specially designed for heater hose applications requiring changes in diameter.

- Engineered to resist electrochemical degradation – the leading cause of hose failure.
- Meets SAE 20R4 Type EC Class D-2.
- Use with hose connectors and bulk heater hose for virtually complete molded heater hose coverage.
- Temperature rating: -40°F to +275°F [-40°C to +135°C].

Caution: Do not use for fuel or oil transfer applications.

Length (In.)	Part No. 1/2" x 5/8" I.D.	Part No. 5/8" x 3/4" I.D.
6	18050	18080
12	18051	18081
18	—	18082
24	—	19351
36	—	18083
60	—	18084

Hose I.D. Reducers

Slip inside current Gates hose to reduce inside diameters, providing maximum coverage with minimum hose inventory. Make it possible to adjust inside diameters of larger hoses for emergency replacements.



- Quality rubber construction assures maximum dependability, no leakage.
- Fits Green Stripe® straight or Green Stripe® Vulco-Flex® hoses.

Caution: Recommended for coolant and air applications only.

Part No.	Size (In.)
26390	1½ to 1¾
26391	1¾ to 1½
26392	2 to 1¾
26393	2¼ to 2
26394	2½ to 2¼
26395	3 to 2½

Cooling Systems - Components

PowerGrip® SB Clamps

Maintenance-free clamps that retain dynamic tension and never need retightening. These clamps stop leaks, even on out-of-round applications. Clamp down better in all conditions and temperature extremes. Environmentally friendly by eliminating antifreeze leaks and ground water contamination.



- Easy to install with ordinary heat gun.
- Wider sealing area entraps connector bead.
- Conform to any shape of hose and housing, even out-of-round fittings.
- Made from a heat-sensitive thermoplastic with a memory to prevent over- or under-tightening.
- Can be used with all brands of silicone hose.
- Temperature rating: -40°F to +302°F [-40°C to +150°C].

Part No.	Size	Nominal Hose I.D. [In.]	Fits Hose O.D. [In.]*	Part No.	Size	Nominal Hose I.D. [In.]	Fits Hose O.D. [In.]*	Part No.	Size	Nominal Hose I.D. [In.]	Fits Hose O.D. [In.]*
32915	SB15	1/4	1/2 to 11/16	32934	SB34	1	1 5/16 to 1 1/2	32967	SB67	2 1/4	2 1/2 to 2 3/4
32919	SB19	3/8	11/16 to 13/16	32941	SB41	1 1/4	1 1/2 to 1 3/4	32973	SB73	2 1/2	2 3/4 to 3
32922	SB22	1/2	13/16 to 15/16	32948	SB48	1 1/2	1 3/4 to 2	32979	SB79	2 3/4	3 to 3 1/4
32925	SB25	5/8	15/16 to 1 1/16	32954	SB54	1 3/4	2 to 2 1/4	32986	SB86	3	3 1/4 to 3 1/2
32929	SB29	3/4	1 1/16 to 1 3/16	32960	SB60	2	2 1/4 to 2 1/2	32990	SB90	3 1/8	3 1/2 to 3 5/8
32932	SB32	7/8	1 3/16 to 1 5/16								

Green Stripe® Stainless Steel Clamps

Ideal for applications where corrosion is a problem, or for industrial use.



- Housing and 9/16" wide band constructed of heavy-gauge stainless steel.
- Screw is 400 series stainless steel.
- Rounded band edges.
- Hex shaped screw with deep slot – tightens with screwdriver, nutdriver or socket wrench.
- Tighten to 35 in./lbs.

SAE Size [In.]	Part No.	Fits Hose I.D. [In.]	Clamping Range [In.]
4	32201	1/16 to 1/2	1/4 to 5/8
7	32207	2/8 to 2/3	1/3 to 7/8
10	32210	3/8 to 5/8	1/2 to 1 1/8
12	32212	5/8 to 3/4	1/2 to 1 1/4
16	32216	3/4 to 1	3/4 to 1 1/2
20	32220	1 to 1 1/4	3/4 to 1 3/4
24	32224	1 1/4 to 1 1/2	1 to 2
28	32228	1 1/4 to 1 3/4	1 1/3 to 2 1/4
32	32232	1 1/2 to 2	1 1/7 to 2 1/2
36	32236	1 3/4 to 2 1/4	7/8 to 2 3/4
48	32248	2 1/2 to 3	1 5/8 to 3 1/2
52	32252	3 to 3 1/4	1 7/8 to 3 3/4
56	32256	2 to 3 1/2	2 1/8 to 4
60	32260	2 1/4 to 3 3/4	2 5/16 to 4 1/4
64	32264	2 1/4 to 4	2 5/8 to 4 1/2
72	32272	3 to 4 1/2	3 3/8 to 5
104	32304	4 to 6 1/2	4 to 7

Strap Clamps



Part No.	Clamp Length	Fits Hose up to
32112	12"	3 1/2" O.D.
32115	15"	4 1/2" O.D.
32124	24"	7 1/2" O.D.

Cooling Systems - Components

Super Hex/Minex Clamps

Top quality clamp with extra-strength construction features. Super Hex features a 1/2" wide band, while the Minex band is 5/16".



- Durable 200 series stainless steel band and screw housing.
- One-piece screw housing is interlocked onto band for extra strength.
- Solid head forged from one piece of steel, cadmium plated.
- Hex shaped screw with deep slot – tightens with screwdriver, nutdriver or socket wrench.
- Tighten to 30 in./lbs.
- Meets SAE J1508.

SAE Size [In.]	Part No.	Fits Hose I.D. [In.]	Clamping Range [In.]	SAE Size [In.]	Part No.	Fits Hose I.D. [In.]	Clamping Range [In.]
4	32001*	1/16 to 1/2	1/4 to 5/8	32	32032	1 1/2 to 2	1 4/7 to 2 1/2
6	32006	1/4 to 3/8	3/8 to 7/8	36	32036	1 3/4 to 2 1/4	7/8 to 2 3/4
7	32007*	2/8 to 2/3	1/3 to 7/8	40	32040	2 to 2 1/2	1 1/8 to 3
8	32008	5/16 to 1/2	4/8 to 1	44	32044	2 1/4 to 2 3/4	1 1/3 to 3 1/4
10	32010	3/8 to 5/8	1/2 to 1 1/8	48	32048	2 1/2 to 3	1 5/8 to 3 1/2
12	32012	5/8 to 3/4	1/2 to 1 1/4	52	32052	3 to 3 1/4	1 7/8 to 3 3/4
16	32016	3/4 to 1	3/4 to 1 1/2	56	32056	2 to 3 1/2	2 1/8 to 4
20	32020	1 to 1 1/4	3/4 to 1 3/4	64	32064	2 1/4 to 4	2 5/8 to 4 1/2
24	32024	1 1/4 to 1 1/2	1 to 2	72	32072	3 to 4 1/2	3 3/8 to 5
28	32028	1 1/4 to 1 3/4	1 1/8 to 2 1/4	104	32104	4 to 6 1/2	4 to 7

*Minex

Type of Clamp	Recommended Installation Torque	Maximum Torque
Minex	14-16 in./lbs.	20 in./lbs.
Super Hex + Charter	25-35 in./lbs.	50 in./lbs.
Green Stripe® Stainless Steel, Silicone + Marine	30-40 in./lbs.	60 in./lbs.

Green Stripe® Marine Clamps

Constructed of 100% marine grade stainless steel. Bands are 9/16" wide with rounded edges. Screws feature 300 series stainless steel construction and deep slotted 5/16" hex heads. Approved for marine applications.

- Saline and corrosion-resistant.



Size No.	Part No.	Size No.	Part No.	Size No.	Part No.	Size No.	Part No.
8M	32508	20M	32520	36M	32536	60M	32560
10M	32510	24M	32524	48M	32548	64M	32564
12M	32512	28M	32528	52M	32552	72M	32572
16M	32516	32M	32532	56M	32556	104M	32604

Cooling Systems - Components

Silicone Hose Clamps

Designed to provide an extra-tight seal on silicone hose and prevent hose cover extrusion.



- 300 series stainless steel band, screw and housing resist corrosion.
- Four-piece construction and 100% mechanical interlock for added strength and torque capability.
- Combination 5/16" hexagon, deep slot screw head makes installation easy-tightens with screwdriver, nutdriver or socket wrench.
- One piece band and liner.
- Inner-liner band eliminates hose cover extrusion.
- Wide 9/16" band gives 12-1/2% more compression than 1/2" band.
- Tighten to 35 in/lbs.

Part No.	Fits Hose I.D. (In.)	Clamping Range
32308	1/3 to 1/2	4/8 to 1
32310	3/8 to 5/8	3/4 to 1 1/8
32312	5/8 to 3/4	7/8 to 1 1/4
32316	3/4 to 1	1 to 1 1/2
32320	1 to 1 1/4	1 1/8 to 1 3/4
32324	1 1/4 to 1 1/2	1 1/4 to 2
32328	1 1/4 to 1 3/4	1 1/3 to 2 1/4
32332	1 1/2 to 2	1 4/7 to 2 1/2
32336	1 3/4 to 2 1/4	1 4/5 to 2 3/4
32340	2 to 2 1/2	2 to 3
32344	2 1/4 to 2 3/4	2 1/3 to 3 1/4
32348	2 1/2 to 3	2 4/7 to 3 1/2
32352	3 to 3 1/4	2 4/5 to 3 3/4
32356	3 1/4 to 3 1/2	3 to 4
32364	3 3/4 to 4	3 4/7 to 4 1/2
32372	4 to 4 1/2	4 to 5

Cooling Systems - Components

Green Stripe® and Green Stripe® Heavy-Duty Constant Tension Clamps

Green Stripe constant tension clamps provide the reusable, self-adjusting band needed for a dependable seal, even in the coldest conditions. Applications include auto, truck and bus cooling systems and turbo chargers. Green Stripe and Green Stripe Heavy-Duty constant tension clamps feature:



- Larger, heavier gauge precision-formed spring washers with higher rates of band tension and adjustability for a more dependable seal.
- All stainless steel construction for maximum corrosion resistance. Band and Housing – 9/16" wide – GSCT 301 and GSHD 304 stainless steel. Hex-Head Screw – 410 stainless steel GSCT 5/16" and GSHD 3/8" wide.
- A uniform 360° seal.
- Clamping diameters – GSCT 9/16" to 3 1/2" and GSHD 1" to 9 1/8".
- Tighten Green Stripe clamps to minimum of 50 in./lbs. and maximum of 85 in./lbs.
- Tighten Green Stripe heavy-duty clamps to minimum of 75 in./lbs. and maximum of 125 in./lbs.

Green Stripe® Constant Tension Clamps

301 Stainless Steel 9/16" Band and Housing

410 Stainless Steel 5/16" Hex-Head Screw

Part Number	Standard Packaging	SAE Size	Clamping Ranges
32710	10	10	9/16" to 1"
32712	10	12	5/8" to 1 1/4"
32716	10	16	13/16" to 1 1/2"
32720	10	20	13/16" to 1 3/4"
32724	10	24	1 1/16" to 2"
32728	10	28	1 5/16" to 2 1/4"
32732	10	32	1 9/16" to 2 1/2"
32736	10	36	1 13/16" to 2 3/4"
32740	10	40	2 1/16" to 3"
32744	10	44	2 5/16" to 3 1/4"
32748	10	48	2 9/16" to 3 1/2"

Green Stripe® HD Constant Tension Clamps

304 Stainless Steel 9/16" Band and Housing

410 Stainless Steel 3/8" Hex-Head Screw

Part Number	Standard Packaging	Clamping Ranges
32617	10	1" to 1 3/4"
32620	10	1 1/4" to 2 1/8"
32625	10	1 3/4" to 2 5/8"
32630	10	2 1/4" to 3 1/8"
32635	10	2 1/4" to 3 5/8"
32640	10	3 1/4" to 4 1/8"
32645	10	3 3/4" to 4 5/8"
32650	10	4 1/4" to 5 1/8"
32655	10	4 3/4" to 5 5/8"
32660	10	5 1/4" to 6 1/8"
32665	10	5 3/4" to 6 5/8"
32670	10	6 1/4" to 7 1/8"
32675	10	6 3/4" to 7 5/8"
32680	10	7 1/4" to 8 1/8"
32685	10	7 3/4" to 8 5/8"
32690	10	8 1/4" to 9 1/8"

Cooling Systems - Components

Green Stripe® Heavy-Duty T-Bolt Clamps and Spring Loaded T-Bolt Clamps

Heavy-Duty T-Bolt and Spring-Loaded T-Bolt Clamps for Light, Medium and Heavy-Duty Trucks, Off-Road Equipment and Industrial applications. Designed for use in high-vibration and large diameter applications common with heavy truck, off-road equipment and industrial machinery.



Green Stripe T-Bolt Clamps

SAE Sizes	Gates Part Numbers	Min. Dia. [Inches]	Max. Dia. [Inches]	Min. Dia. [mm]	Max. Dia. [mm]	Installation Torque
-	32749	1 ³ / ₈	1 ⁴ / ₇	35.1	38.6	75.0 in. lbs. [8.5 Nm]
-	32750	1 ¹ / ₂	1 ⁵ / ₈	38.1	41.7	75.0 in. lbs. [8.5 Nm]
-	32751	1 ⁵ / ₈	1 ⁷ / ₈	41.4	46.0	75.0 in. lbs. [8.5 Nm]
28	32752	1 ³ / ₄	2	44.5	50.8	75.0 in. lbs. [8.5 Nm]
32	32753	1 ⁷ / ₈	2 ¹ / ₅	47.8	55.6	75.0 in. lbs. [8.5 Nm]
36	32754	2	2 ¹ / ₃	50.8	58.7	75.0 in. lbs. [8.5 Nm]
40	32755	2 ¹ / ₈	2 ⁴ / ₈	54.1	62.0	75.0 in. lbs. [8.5 Nm]
44	32756	2 ¹ / ₄	2 ⁴ / ₇	57.2	65.0	75.0 in. lbs. [8.5 Nm]
48	32757	2 ³ / ₈	2 ² / ₅	60.5	68.3	75.0 in. lbs. [8.5 Nm]
52	32758	2 ¹ / ₂	2 ⁴ / ₅	63.5	71.4	75.0 in. lbs. [8.5 Nm]
56	32759	2 ⁵ / ₈	3	66.8	74.7	75.0 in. lbs. [8.5 Nm]
60	32760	2 ³ / ₄	3	69.9	77.7	75.0 in. lbs. [8.5 Nm]
64	32761	2 ⁷ / ₈	3 ¹ / ₅	73.2	81.0	75.0 in. lbs. [8.5 Nm]
68	32762	3	3 ¹ / ₃	76.2	84.1	75.0 in. lbs. [8.5 Nm]
72	32763	3 ¹ / ₈	3 ⁴ / ₈	79.5	87.4	75.0 in. lbs. [8.5 Nm]
76	32764	3 ¹ / ₄	3 ⁴ / ₇	82.6	90.4	75.0 in. lbs. [8.5 Nm]
80	32765	3 ³ / ₈	3 ² / ₃	85.9	93.7	75.0 in. lbs. [8.5 Nm]
84	32766	3 ¹ / ₂	3 ⁴ / ₅	88.9	96.8	75.0 in. lbs. [8.5 Nm]
88	32767	3 ⁵ / ₈	4	92.2	100.1	75.0 in. lbs. [8.5 Nm]
92	32768	3 ³ / ₄	4	95.3	103.1	75.0 in. lbs. [8.5 Nm]
100	32769	4	4 ¹ / ₃	101.6	109.5	75.0 in. lbs. [8.5 Nm]
108	32770	4 ¹ / ₄	4 ⁴ / ₇	108.0	115.8	75.0 in. lbs. [8.5 Nm]
116	32771	4 ¹ / ₂	4 ⁴ / ₅	114.3	122.2	75.0 in. lbs. [8.5 Nm]
124	32772	4 ³ / ₄	5	120.7	128.5	75.0 in. lbs. [8.5 Nm]
132	32773	5	5 ¹ / ₃	127.0	134.9	75.0 in. lbs. [8.5 Nm]
140	32774	5 ¹ / ₄	5 ⁴ / ₇	133.4	141.2	75.0 in. lbs. [8.5 Nm]
148	32775	5 ¹ / ₂	5 ⁴ / ₅	139.7	147.6	75.0 in. lbs. [8.5 Nm]
156	32776	5 ³ / ₄	6	146.1	153.9	75.0 in. lbs. [8.5 Nm]
164	32777	6	6 ¹ / ₃	152.4	160.3	75.0 in. lbs. [8.5 Nm]
172	32778	6 ¹ / ₄	6 ⁴ / ₇	158.8	166.6	75.0 in. lbs. [8.5 Nm]
180	32779	6 ¹ / ₂	6 ⁴ / ₅	165.1	173.0	75.0 in. lbs. [8.5 Nm]
188	32780	6 ³ / ₄	7	171.5	179.3	75.0 in. lbs. [8.5 Nm]
196	32781	7	7 ¹ / ₃	177.8	185.7	75.0 in. lbs. [8.5 Nm]
204	32782	7 ¹ / ₄	7 ⁴ / ₇	184.2	192.0	75.0 in. lbs. [8.5 Nm]
212	32783	7 ¹ / ₂	7 ⁴ / ₅	190.5	198.4	75.0 in. lbs. [8.5 Nm]
220	32784	7 ³ / ₄	8	196.9	204.7	75.0 in. lbs. [8.5 Nm]
228	32785	8	8 ¹ / ₃	203.2	211.1	75.0 in. lbs. [8.5 Nm]
236	32786	8 ¹ / ₄	8 ⁴ / ₇	209.6	217.4	75.0 in. lbs. [8.5 Nm]
244	32787	8 ¹ / ₂	8 ⁴ / ₅	215.9	223.8	75.0 in. lbs. [8.5 Nm]

Green Stripe Spring-Loaded T-Bolt Clamps

SAE Sizes	Gates Part Numbers	Min. Dia. [Inches]	Max. Dia. [Inches]	Min. Dia. [mm]	Max. Dia. [mm]	Installation Torque
70	32861	3	3 ³ / ₈	77.8	85.7	75.0 in. lbs. [8.5 Nm]
86	32862	3 ⁴ / ₇	3 ⁷ / ₈	90.5	98.4	75.0 in. lbs. [8.5 Nm]
102	32863	4	4 ³ / ₈	103.2	.1	75.0 in. lbs. [8.5 Nm]
118	32864	4 ⁴ / ₇	4 ⁷ / ₈	115.9	123.8	75.0 in. lbs. [8.5 Nm]

Cooling Systems - Thermostats

Green Stripe® Heavy-Duty Thermostats

Quality controlled factory calibration assures accurate heat control under extreme variations in temperature, load and engine vibrations. Approved for marine applications.



- Heavy-gauge brass and stainless steel with positive piston heat motor.
- Available in Choke type, Top By-Pass, Bottom By-Pass, Side By-Pass, Normally Open and other types to meet heavy-duty cooling system designs.

Note: Seal should always be changed when new thermostat is installed.

Green Stripe® Heavy-Duty Thermostat Seals

Fits securely around thermostat valve to prevent leakage. Approved for marine applications.



- Corrosion-resistant steel construction.
- Specially constructed to assure accurate fit.

Cooling Systems - H.D. Radiator Caps & Kits

Heavy-Duty Radiator Caps

For use on heavy-duty trucks, buses and tractors.

- Fits applications with 3/4" deep filler necks.



Heavy-Duty Cool Control Caps

Diverts pressurized coolant to reservoir instead of an overflow tube.

- Corrosion-resistant, heavy-gauge metal construction assures long life and accurate control of pressure.
- Atmospheric type valve allows cooling system to pressurize as needed, resulting in less strain on system components.



Radiator Cap and Cooling System Analyzer Kit

Contains all components needed to check cooling systems and radiator caps.

- Lightweight, impact-resistant analyzer.
- Pressure release button on easy-to-read gauge allows for safe venting of system during testing.
- Complete Kit — Includes Part No. 31425, 31413 and carrying case. Kit Part No. 31367 replaces old Part No. 31365.



Fuel System - Hose

Diesel Emission Fluid (DEF) Hose Assemblies

Diesel Emission Fluid (DEF) Hose Assemblies are specially designed and manufactured to convey Diesel Emission Fluid (DEF). Because DEF freezes at +11°F [-12°C], the hose and couplings are electronically heated using Gates revolutionary carbon fiber heating system.



- Patent-pending carbon fiber heating system provides faster thaw times, lower amp draw and more uniform heating than OE heated-wire designs.
- Dense, closed-cell EPDM cover resists cuts and abrasion better than typical OE replacements, for longer life in harsh environments.
- Over-molded quick connects keep dirt and grime out of critical connections to prevent premature system failure.
- Heating and electrical connection per OE specifications.

Diesel Emission Fluid (DEF) Tank Fill Hose

DEF Tank Transfer Hose are manufactured for the specific filling functions of DEF tanks. They feature the highest quality construction to meet the demands of DEF handling and transfer.



- 3/4" and 1" standard I.D. sizes.
- Temperature rating: -40°F to +212°F [-40°C to +100°C].
- Non-zinc, peroxide-cured EPDM.
- Gates DEF hose can be used with PVC fittings and stainless steel clamps, but Gates stainless steel coupling line provides a more durable and permanent solution

Part No.	Description
DEF750025	3/4" DEF Hose 25'
DEF750300	3/4" DEF Hose 300'
DEF100025	1" DEF Hose 25'
DEF100300	1" DEF Hose 300'

Barricade® Fuel Injection Hose (MPI)

Low-permeation, premium hose for use on all fuel systems, including fuel injection (MPI). Approved for use with gasoline, diesel, bio-diesel including soybean methyl ester (SME), rapeseed methyl ester (RME), palm methyl ester (PME) per ASTM D6751, E-85, methanol, ethanol, ethanol extended gasoline, gasohol fuels and 100% alcohol. Patented five-layer Greenshield® barrier technology keeps fuel out of the environment while delivering peak fuel efficiency.



- Exceeds SAE J30R14T2 (except for kink resistance) as well as low-permeation requirements for CARB.
- Aramid reinforcement spiral braid for superior burst strength.
- Thermoplastic barrier layer.
- Oil, heat, ozone and abrasion resistant cover.
- 225 psi working pressure rating.
- Recommended for any fuel injection applications for superior service life.
- Temperature rating: -40°F to +275°F [-40°C to +135°C] continuous, up to +302°F [+150°C] intermittent.

Note: Do not submerge in gasoline.

Fuel System - Hose

Barricade® Carburetion Fuel Line Hose

Low-permeation, premium hose for use on carbureted engines, PCV and EEC systems, and for fuel return hose on fuel injection systems. Not for use on the pressure-side of fuel injection systems or 2-stroke engines. Approved for use with leaded and unleaded gasoline, diesel, bio-diesel, E-85, methanol, ethanol, and gasohol fuels. Patented five-layer Greenshield® barrier technology keeps fuel out of the environment while delivering peak fuel efficiency.



- Meets SAE J30R14T1, EPA 40 CFR 1051.110, and CARB small engine off-road requirements for low permeation [except for kink resistance].
- Textile spiral layer [two spiral].
- Thermoplastic barrier layer.
- Oil, heat, ozone and abrasion resistant cover.
- Recommended for carbureted engines in cars, light trucks, off-road vehicles and small engines.
- Temperature rating: -40°F to +257°F [-40°C to +125°C].

Note: Do not submerge in gasoline.

Caution: Do not use on pressure lines on fuel injection systems or cooling system applications. Use MPI [4219D] or Barricade Fuel Injection [4219BF] hose for Multi-Port Injection systems.

Packaging: I.D. [in.]	Working [psi]	2 Ft. retail Part No.	25 Ft. length Part No.	250 Ft. reel Part No.
3/16	50	27302	27312	27321
1/4	50	27303	27313	27323
5/16	50	27304	27314	27324
3/8	50	27305	27315	27325
1/2	35	27306	27316	27326

Textile Covered Fuel Line Hose

Textile covered fuel line hose features a durable, oil resistant textile cover providing dependable and safe service on fuel circuits in passenger cars and light trucks.



- Braided textile cover reinforces the hose and is resistant to heat, ozone and weathering.
- Working pressure up to 87 psi.
- Temperature rating: -31°F to +212°F [-35°C to +100°C].
- Recommended for clamped hose applications on fuel systems in passenger cars and light trucks.

Fuel System - Hose

Safety Stripe® Return Fuel Line/PCV/Evaporative Emission Control Hose (1986 & older)

Multi-purpose hose for use on return fuel lines, PCV and EEC systems, and for fuel return hose connections on diesel fuel injection systems. Approved for use with leaded and unleaded gasoline, diesel and gasoline blends of ethanol [E85], methanol and ethers [up to the legal limits allowed by the EPA].

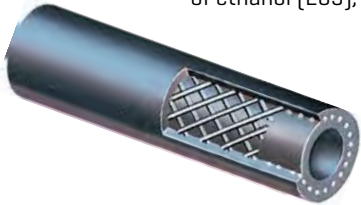

- Spiral reinforced construction.
- Nitrile tube.
- NBR-PVC cover.
- Oil resistant cover resists the effects of high heat and ozone found in engine compartments.
- Meets SAE 30R6 and 30R7.
- Vacuum rating of 24 In./Hg for sizes less than 1/2" I.D., and 10 In./Hg. for sizes 1/2" to 3/4" I.D. at ambient temperatures.
- Temperature rating: -40°F to +257°F [-40°C to +125°C] with gasoline blends.

Caution: Do not use for pressure lines on fuel injected engines or for cooling system applications. Use Barricade® Fuel Injection hose for fuel injection applications.

Intended for use with fuels where MTBE concentrations are no greater than 15% by volume.

I.D. (In.)	Work. Press. (psi)	25	250
		Ft.	Ft.
		Part No.	Part No.
1/8	50	27000	27099
3/16	50	27001	27098
1/4	50	27002	27068
5/16	50	27003	27069
3/8	50	27004	27070
7/16	35	27005	27071
1/2	35	27006	27019
5/8	35	27008	27020
3/4	35	27010	27021

Packaged Safety Stripe® Return Fuel Line/PCV/Evaporative Emission Control Hose (1986 & older)

Convenient, popular two foot lengths of return fuel line, PCV and EEC hose in self-service, reusable, recyclable package. Can be stacked on shelf or hung on a pegboard display.



- Easy to follow instructions in each package.
- Handy hose diameter indicator helps customer select the correct size.

I.D. (In.)	Work. Press. (psi)	Part No.
1/4	50	27027
5/16	50	27028
3/8	50	27029

Fuel System - Hose

Fuel Fill Hose

Designed for transferring fuel from vehicle's filler neck to fuel tank. Works on passenger cars and light trucks, as well as on auxiliary fuel tanks on recreational vehicles. For use with most types of fuels – especially resistant to gasoline and diesel.



- Suitable for use with gasoline, gasohol blends of ethanol, methanol, ethers, diesel and bio-diesel to B20 (up to maximum concentrations allowed by the EPA).
- Features a high quality nitrile tube.
- Meets requirements of SAE 30R5.
- Cuts easily with knife and wire cutters.
- Temperature rating: -40°F to +212°F [-40°C to +100°C] with gasoline blends, -40°F to +125°F [-40°C to +51°C] with bio-diesel [B20].

Note: Use Gates Super Hex clamps for reliable installation.

I.D. [In.]	Work. Press. [psi]	Part No.
1½	20	23924
1¾	20	23930
2	20	23932
2¼	20	23936
2½	20	23940

Fuel Filler Neck Hose

Designed specifically for auxiliary gas tanks on recreational vehicles. Excellent replacement for passenger cars and trucks where a straight hose with a minimal bend is required.

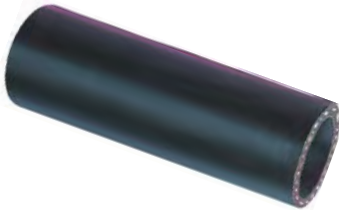

- Suitable for use with gasoline, gasohol blends of ethanol, methanol, ethers, diesel and bio-diesel to B20 (up to maximum concentrations allowed by the EPA).
- Smooth oil resistant cover, tough textile cord reinforcement and petroleum-resistant nitrile tube.
- Non-wire reinforced.
- Meets SAE 30R6 specifications.
- Temperature rating: -40°F to +212°F [-40°C to +100°C].
- Bio-diesel [B20] temperature rating: -40°F to +212°F [-40°C to +51°C].

Caution: Not recommended for marine gasoline applications.

Part No.	I.D. [In.]	Ctr. Length [Ft.]	Work. Press. [psi]
23963	1¼	3	20
24702	1¾	3	20
24703	1½	1.5	20
24704	1¾	1.5	20
24705	2	1.5	20
23964	1½	3	20
23968	1¾	3	20
23972	2	3	20
23976	2¼	3	20
23980	2½	3	20

45° Bend:				90° Bend:			
Part No.	I.D. [In.]	Ctr. Length [in.]	Work. Press. [psi]	Part No.	I.D. [In.]	Ctr. Length [in.]	Work. Press. [psi]
24710	1½	15.9	20	24715	1½	15.1	20
24711	1¾	15.9	20	24716	1¾	15.0	20
24712	2	15.9	20	24717	2	14.9	20
24713	2¼	15.9	20	24718	2¼	14.7	20
24714	2½	15.8	20	24719	2½	14.6	20

Fuel System - Hose

Submersible Fuel Line Hose

Ordinary fuel line hose is designed to handle fuel on the inside only. The Gates Submersible Fuel Line Hose exceeds the SAE 30R10 rating and is capable of handling gasoline, alcohol-extended gasoline or diesel fuel in fully immersed, mobile, stationary and marine applications and E85 fuel.



- Engineered for constant contact with gasoline [and other liquid petroleum distillates] on the inside and the outside.
- Excellent for use on fuel pumps in the gas tank.
- Meets the SAE 30R10 specification for submersible fuel line hose applications.
- Fluoroelastomer [FKM] tubed cover resists gas permeation and retards aging.
- Aramid Fiber reinforcement—the same fiber used in bulletproof vests and is pound-for-pound stronger than steel.
- Maximum temperature rating: +302°F [+150°C].

I.D. [In.]	Work. Press. [psi]	1-Ft. Part No.	10-Ft. Part No.	32.8-Ft. Part No.
1/4	100	27086	27087	27089
5/16	100	27093	27080	27083
3/8	100	27097	27081	27084

Fuel System - Fuel Cap

Heavy-Duty Saddle Tank Caps

Heavy metal construction throughout. Meets I.C.C. requirements.

- Available for side or saddle tanks.
- Locking caps come with two keys. Keyed-alike caps available on special order.



Mechanical Fuel Cap Testers, Adapters and Replacement Parts

Economical, easy-to-use alternative to electronic testers.



- Compact, lightweight design.
- Easy-to-read pass/fail gauge.
- Convenient hand operation - needs no batteries.
- Set of two pass and fail calibration caps to confirm tester accuracy.
- Complete set of nine color-coded adapters with adapter application chart.
- Tester unit and adapters packaged in separate plastic carrying cases.

Part No.	Description	Pkg.	Part No.	Description	Pkg.
12302	Replacement Gauge	1	12417	Pump Oil	1
12403	Blue Tester Adapter	1	12419	Orange Cap Adapter	1
12404	Yellow Tester Adapter	1	12421	Light Blue Cap Adapter	1
12405	Red Tester Adapter	1	12422	Tan Cap Adapter	1
12406	Green Tester Adapter	1	12420	Brown "Dual Thread" Adapter	1
12407	Black Tester Adapter	1	12423	Light Green Adapter	1
12408	Gray Tester Adapter	1	12424	Cream Cap Adapter	1
12410	Threaded Adapter	1	12426	Tester Adapter	1
12411	Green "Pass" Cap	1	12427	Tester Adapter	1
12412	Red "Fail" Cap	1	12556	Replacement Plastic Knob	1

Lubrication System

Transmission Oil Cooler Hose

Provides a safe, heat and oil resistant connecting line between oil cooler and transmission.

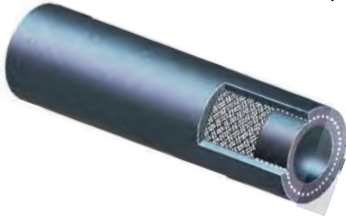

- One fiber braid reinforcement over an oil resistant nitrile rubber tube.
- Oil and abrasion resistant black CSM cover.
- Meets or exceeds SAE J1019 requirements.
- Can be stacked on shelf or hung on pegboard.
- Easy-to-follow instructions in each package.
- Handy hose diameter indicator on package.
- Package is recyclable.
- Maximum temperature rating: +300°F [+150°C].

I.D. (In.)	Work. [psi]	Press. Burst	3 Ft.	25 Ft.	50 Ft.
			Length	Length	Length
5/16	400	1600	Part No. 27056	Part No. 27058	Part No. 27060
3/8	400	1600	Part No. 27057	Part No. 27059	Part No. 27061
1/2	400	1600	Part No. 27065	Part No. 27066	Part No. 27067

PCV Oil Filler Caps

Meets requirements of emission control systems on late model cars and light trucks. Universal design offers maximum coverage with minimum inventory.



- Sealed construction prevents engine crankcase gases from escaping into the atmosphere.
 - Heavy-gauge steel construction resists under-hood heat and corrosion.
- Note:** To assure proper operation of PCV systems, oil filler caps should be cleaned or replaced every 12,000 miles.

Oil Filler Caps

Durable construction assures long service life.



- Special finish resists rust and provides excellent protection against under-hood heat.

Braking System

Air Brake Hose Assemblies

Factory crimped assemblies meet the rigorous demands of the fleet and heavy-duty market.



- Extremely flexible and kink resistant.
- Two spiral construction meets SAE J1402 specifications.
- Complies with DOT FMVSS 106 requirements.
- Couplings meet SAE and DOT minimum pull-off requirements.
- High quality brass male pipe fitting on one end, female air brake swivel with male pipe adapter on other end.
- Temperature rating: -40°F to +212°F [-40°C to +100°C].

3/8" I.D. Hose With 1/4" MPT Fixed + Swivel		3/8" I.D. Hose With 3/8" MPT Fixed + Swivel		1/2" I.D. Hose With 3/8" MPT Fixed + Swivel		1/2" I.D. Hose With 1/2" MPT Fixed + 3/8" Swivel	
Length (In.)	Part No.	Length (In.)	Part No.	Length (In.)	Part No.	Length (In.)	Part No.
14	27242	14	27261	18	27252	18	27286
16	27243	16	27262	20	27253	20	27287
18	27244	18	27263	24	27254	24	27289
20	27245	20	27264	28	27255	28	27291
24	27246	24	27266	30	27256	30	27292
26	27247	26	27267	32	27257	32	27293
30	27248	28	27268	36	27258	34	27294
32	27249	30	27269	42	27259	36	27295
36	27250	32	27270	48	27360	42	27297
42	27251	34	27271	60	27361		
48	27350	36	27272	72	27362		
		42	27275				
		45	27277				
		48	27279				
		60	27281				

Brake Line Abrasion Shields

The Federal Motor Carrier Safety Administration's Compliance Safety Accountability (CSA) program requires abrasion shields on brake lines that fall below the chassis and in circumstances where chafing, kinking or other mechanical damage can occur. Gates provides high-quality products that meet the rules and specifications for brake line protection.



PolySleeve™ High Density Polyethylene Hose Wrap

Protects lines and hoses from chafing, rubbing, crushing, ultraviolet rays and other hazards that cause hose failures. Easy to install before or after assemblies are in place. Effective temperature range from -40°F to +280°F [-40°C to + 138°C].



Nylon Sleeves

Nylon filament mesh forms a self-renewing shield that protects against abrasion for brake lines, hose and hose bundles. Extremely flexible, flame resistant and easy to install.

Braking System

SureLok™ Fittings

Recommended for compressed air connector on all nylon air brake tubing air brake systems at locations other than between chassis frame and axle or between towed and towing vehicle. Also recommended as a connector on all air operated systems as applicable to suspension, steering, engine, transmission and auxiliary mechanisms. Fittings and tubing comply to Department of Transportation Federal Motor Vehicle Safety Standard, [DOT FMVSS 106] [mandatory requirements for inch tube fittings in U.S.A.] Society for Automotive Engineers [SAE] J1131 [inch tube and fittings] and meet DIN 74324 and German TUV requirements [metric tube and fittings].



- Simple tube connection and disconnection.
- Fewer component parts – Internally machined form in body to secure collet.
- All collets marked with tube size.
- Ease of tube insertion in areas of restricted access.
- Total fittings system solution.

Maximum Working Pressure: 0 to 150 psi

Working Temperature: -40°F to +220°F [-40°C to +104°C]

Materials: Body, tube support, Collet – Brass; O-Ring – Buna N [Low Nitrile];

Thread Sealant – Precoat 5

Tubing: Tube should be to SAE J844 or DIN 74324

Small Air Brake Assortment

This small SureLok™ assortment is a basic starter package for the jobber or fleet. The SureLok coupling allows for repairs or replacement of J844 nylon air brake lines without the need of tools. Part No. A33001.

Assortment contains:



- Four sizes of hose.
- 16 coupling configurations.
- 158 individual couplings.

Large Air Brake Assortment

The large SureLok™ assortment is perfect for the jobber or fleet. SureLok couplings allow for repairs or replacement of J844 nylon air brake lines without tools. Along with the SureLok couplings, this assortment features brass field attachable couplings for SAE J1402 DOT All hose. Part No. A33002.

Assortment contains:



- Seven sizes of hose.
- 51 coupling configurations.
- 318 individual couplings.

Braking System

Compression Fittings

Recommended for compressed air connector on all nylon air brake tubing air brake systems at locations other than between chassis frame and axle or between towed and towing vehicle. Also recommended as a connector on all air operated systems as applicable to suspension, steering, engine, transmission and auxiliary mechanisms. Fittings and tubing comply to Department of Transportation Federal Motor Vehicle Safety Standard, [DOT FMVSS571.106] [Mandatory requirements for inch tube fittings in U.S.A.] Society for Automotive Engineers [SAE J246] and [SAE J1131] [inch tube and fittings].

- Maximum Working Pressure: 150 psi
- Working Temperature: -40°F to +200°F [-40°C to +100°C]
- Materials: Brass
- Tubing: SAE J844 or DIN 74324

Component Functions: The Gates compression coupling has four parts:

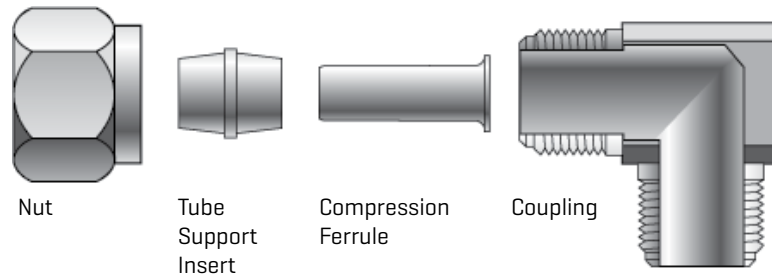

Small Compression Assortment

Handy, small compression assortment is a basic starter package for the jobber or fleet. This assortment features brass compression couplings for J844 nylon air brake hose. Part No. A33003.

Assortment contains:



- Four sizes of hose.
- 31 coupling configurations.
- 211 individual couplings.

Large Compression Assortment

The large compression assortment is perfect for the jobber or fleet. This assortment features both brass compression couplings for J844 nylon air brake hose and brass field attachable couplings for SAE J1402 DOT. Part No. A33004.

Assortment contains:



- Seven sizes of hose.
- 59 coupling configurations.
- 330 individual couplings.

Braking System

AB Series Air Brake Hose

Computer-controlled manufacturing process virtually insures product uniformity.



- Superior EPDM rubber resists damaging effects of ozone and heat, plus harmful grease and oil common to air brake systems.
- Four-spiral polyester construction, meets SAE J1402 specifications. Complies with DOT FMVSS 106 requirements.
- Flexible and kink-resistant.
- Designed to accept all styles of air brake couplings, including conventional brass and plastic couplings.
- Temperature rating: -40°F to +212°F [-40°C to +100°C].

I.D. [In.]	Length [Ft.]	Work. Press. [psi]	Part No.
3/8	50	225	27240
3/8	250	225	28760
1/2	50	225	27241
1/2	250	225	28761

Heavy-Duty Green Stripe® Air Brake Hose

Can be used as flexible connector between frame and axle.

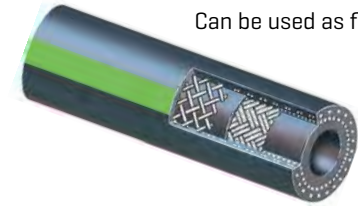

- Compatible with standard air brake couplings.
- Neoprene construction is oil resistant.
- Two-braid rayon reinforced construction with smooth cover.
- Exceeds SAE J1402 and Bendix specifications.
- Complies with DOT FMVSS 106 requirements.

I.D. [In.]	Length [Ft.]	Work. Press. [psi]	Part No.
3/8	50	225	27220
3/8	250	225	28304
1/2	50	225	27221

Note: Federal law requires registration with the Department of Transportation for anyone producing air brake hose assemblies with swaged or crimped fittings.

Braking System

Power Brake Vacuum Hose

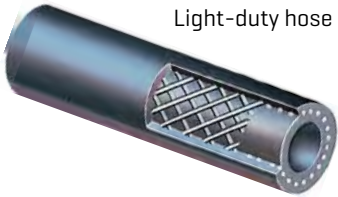

Light-duty hose specially engineered for power brake applications on passenger cars and light trucks.

- Complies with DOT FMVSS 106VL. Meets SAE 1403 Type L.
- Ozone-resistant EPDM cover.
- Textile reinforcement.
- Vacuum rating 30 In. Hg.
- Temperature rating: -40°F to +257°F [-40°C to +125°C].

I.D. (In.)	Work. Press. (psi)	Part No. 3 Foot	Part No. 50 Foot
11/32	85	27232	27230
15/32	85	27233	27231

Green Stripe® Vacuum Brake Hose

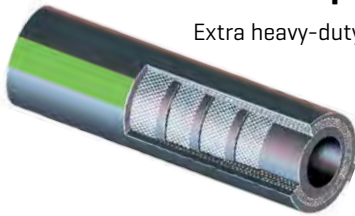

Extra heavy-duty hose designed to fit most air brake systems on trucks, trailers and other heavy equipment.

- Wrapped hose construction with multiple plies of rubber-impregnated fabric.
- Resists collapsing or deforming even under high vacuum at elevated temperatures.
- Rated at 30 In./Hg.
- Exceeds SAE J1403, Type H requirements. Complies with DOT FMVSS 106VH requirements.
- Temperature rating: -40°F to +257°F [-40°C to +125°C].

I.D. (In.)	Work. Press. (psi)	Part No.
3/8	85	27210
1/2	85	27211
5/8	85	27212
3/4	85	27213

Nylon Air Brake Tubing

Recommended for truck, bus and mobile air brake, and service lines where heat and battery acids are not present. Conforms to SAE J844 specifications. Meets DOT FMVSS 106-74.



- Tube: Heat and light stabilized seamless extruded nylon.
- Cover: Nylon. Available in black [NABTA], blue [NABTB], green [NABTG], red [NABTR], yellow [NABTY] and orange [NABTO] colors. Other colors available upon request.
- Temperature rating: -40°F to +200°F [-40°C to +93°C].
- Couplings: Use Gates DOT SureLok™ [G31] or Gates DOT compression. [G32]
- Type A: Non-reinforced in sizes 1/8", 5/32", 3/16", and 1/4".
- Note:** Sizes 1/8" and 5/32" are NOT recognized by DOT for air brake systems. These are for service lines only.
- Type B: Reinforced with one open ply of fibrous nylon in sizes 5/16", 3/8", 1/2", 5/8" and 3/4".

Hydraulics - Hose Products

Gates hydraulic hoses, couplings and accessories beat the competition, and meet or exceed the toughest SAE requirements. By offering a full line of products, Gates can meet your every need. These listings are not an exhaustive list of all Gates has to offer. For all Gates hydraulic products, please see Hydraulic Catalog 431-2080.

Ultra High Pressure

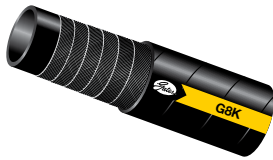

G8K Spiral Wire Hose

Recommended For: Ultra high-pressure, high-impulse applications such as hydrostatic transmissions, for use in the construction, agriculture, forestry, underground or open pit mining, or other industries on applications where extremely high pressure capability is required. G8K hose and couplings offer industry-leading bend radius capability, which leads to ease of routing and installation, longer hose life in flexing applications, and fewer bent tube fitting requirements.

Extremely High Pressure



EFG6K Spiral Wire Hose—SAE 100R15

Recommended For: Extremely high-pressure, high-impulse applications such as hydrostatic transmissions. EFG6K is designed to meet or exceed all requirements of SAE 100R15 specifications and performance requirements of EN 856 4SP [-6, -8, -10 and -12], EN 856 4SH [-12, -16, and -20], and ISO 3862 Type R15 [-6, -8, -10, -12, -16, -24]. Compatible with biodegradable hydraulic fluids like polyolester, polyglycol and vegetable oil as well as standard petroleum-based fluids. Available in 121' through 200' continuous lengths.

Available with unique abrasion-resistant MegaTuff® cover.



EFG5K Spiral Wire Hose—SAE 100R13

Recommended For: Extremely high-pressure high-impulse applications. Exceeds all requirements of ISO 18752 Grade D and SAE 100R13 and performance requirements of EN 856 4SH [-16 and -20], EN 856 4SP [-10, and -12], EN 856 R13, and ISO 3862 Type R13 [-12, -16, -20, -24, -32]. Compatible with biodegradable hydraulic fluids like polyolester, polyglycol and vegetable oil as well as standard petroleum-based fluids. Available in 121' through 200' continuous lengths.

Available with unique abrasion-resistant MegaTuff® cover.



EFG4K Spiral Wire Hose—SAE 100R12

Recommended For: Extremely high-pressure, high-impulse applications. Exceeds all requirements of ISO 18752 Grade D, SAE 100R12, EN 856 R12 and ISO 3862 Type R12. Compatible with biodegradable hydraulic fluids like polyolester, polyglycol and vegetable oil as well as standard petroleum based fluids. Available in 121' through 200' continuous lengths.

Available with unique abrasion-resistant MegaTuff® cover.



EFG3K Spiral Wire Hose—SAE 100R12

Recommended For: Extremely high-pressure, high-impulse applications. Exceeds all requirements for ISO 18752 Grade D, SAE 100R12, EN 856 R12, and performance requirements of EN 856 4SP, and ISO 3862 Type R12. Compatible with biodegradable hydraulic fluids like polyolester, polyglycol and vegetable oil as well as standard petroleum-based fluids. Available in 121' through 200' continuous lengths.

Available with unique abrasion-resistant MegaTuff® cover.

Hydraulics - Hose Products

Fleet Application



C5C Hydraulic Hose—SAE 100R5

Recommended For: Medium pressure hydraulic petroleum-based oil lines in impulse applications, lube oil, air and water in applications such as air brakes, power steering [CAUTION: Intended for heavy-duty commercial vehicle use only], turbocharger oil supplies, tilt cab cylinders, transmission coolant and filtration lines. Meets or exceeds requirements of SAE 100R5 for traditional hydraulic applications, DOT FMVSS 106-74 Type All and SAE J1402 Type All for air brake applications [-4 to -12]. Not recommended for gasoline or diesel fuel.

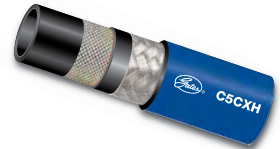

C5CXH Xtreme® Heat Hose—SAE 100R5

Recommended For: Petroleum based or phosphate ester fluids, turbo charger oil supply and hot lube oil lines. Meets the requirements of SAE J1405 performance specifications for high temperature transmission and lubrication oil systems.



C5D High-Temp Multi-Fluid Hose

Recommended For: Petroleum-base or phosphate ester fluids; diesel fuels and filtration lines, transmission coolant lines, hot lube oil lines, power steering [CAUTION: Intended for heavy-duty commercial vehicle use only], gasoline and turbocharger oil supplies. Tilt cab cylinder and air brakes. C5D [-4 to -12] meets or exceeds DOT FMVSS 106-74 Type All, SAE J1402 Type All and SAE J1405 and fuel resistance of SAE J30R2. Not approved for bio-diesel.



C5M Marine Fuel Line Hose

Recommended For: All commercial and recreational vessel fuel line applications. Suitable for marine diesel, gasoline, B100 Bio-diesel, gasohol fuels and hot oil applications.



C5E High-Temp Flexline Hose

Recommended For: Air brake hose, power steering [CAUTION: Intended for heavy-duty commercial vehicle use only], engine and transmission coolant lines, and hot [+300°F] lube oil lines. Not recommended for gasoline or diesel fuel.



MegaTech® 3000 High-Temp Oil/Air Return

Recommended For: Pressurized hot oil return lines and rotary oil lines. Meets the requirements of SAE J1405 performance specifications for high temperature transmission and lubricating oil systems using petroleum base oils.



MegaTech® 1000 High-Temp Oil/Air Return

Recommended For: Air brake, pressurized hot oil return lines and rotary oil/air compressor lines. Meets the requirements of DOT FMVSS 106-74, SAE J1402, for Air Brake Hose [-4, 6, 8, 10], and SAE J1405 performance specifications for high-temperature transmission and lubricating oil systems using petroleum base oils. Not recommended for gasoline or diesel fuel applications.



MegaTech® 500 High-Temp Oil/Air Return

Recommended For: For air brake hose, pressurized hot oil return lines and rotary oil/air compressor lines. Meets the requirements of SAE J1405 performance specifications for high-temperature transmission and lubricating oil systems using petroleum base oils. Not recommended for gasoline or diesel fuel applications.

Hydraulics - Hose Products

Fleet Application - continued



MegaTech® 250 High-Temp Transmission Oil Cooler (TOC) Hose

Recommended For: High-temperature (300°F) transmission oil cooler lines, pressurized hot oil return lines and turbocharger oil supplies. Meets or exceeds SAE J1405 performance specifications for high-temperature transmission and lubricating oil systems using petroleum base oils. Not recommended for gasoline or diesel fuel applications.



MegaTech® G5TB Xtreme® Heat Oil/Air Return

Recommended For: For pressurized hot oil return lines and rotary oil lines. Meets the requirements of SAE J1405 performance specifications for high-temperature transmission and lubricating oil systems using petroleum base oils.



TR500 High-Temp/Air Brake/Engine Hose

Recommended For: Air brake hose, high temperature pressurized oil return lines and rotary oil/air compressor lines, engine and transmission coolant lines and lube oil lines. Meets or exceeds DOT FMVSS 106-74, SAE J1402 for air brake hose [4, 6, 8, 10]. Not recommended for gasoline or diesel fuel applications.

Specialty/Thermoplastic

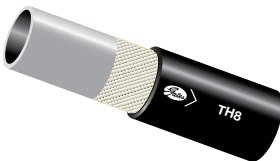

TH8 Hydraulic Hose—SAE 100R8

Recommended For: Use with petroleum, water base and synthetic hydraulic fluids. Applications include: power and telephone mobile equipment (cherry pickers), lubrication lines, blowout preventer control lines, hydraulic lifts and farm and construction machinery. TH8 hose meets or exceeds performance requirements of SAE 100R8 with a significantly tighter bend radius. Multiline available.

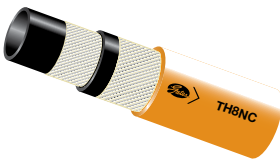

TH8NC Non Conductive Hydraulic Hose—SAE 100R8

Recommended For: Use with petroleum, water base and synthetic hydraulic fluids. Applications include: power and telephone mobile equipment (cherry pickers), lubrication lines, blowout preventer control lines, hydraulic lifts and farm and construction machinery. TH8NC hose (orange cover) meets SAE 100R8 non-conductivity requirements. TH8NC hose meets or exceeds performance requirements of SAE 100R8 with a significantly tighter bend radius. Multiline available.



TH7 Hydraulic Hose—SAE 100R7

Recommended For: Petroleum, water base and synthetic hydraulic fluids. Applications include: power and telephone mobile equipment (cherry pickers), lubrication lines, blowout preventer control lines, hydraulic lifts and farm and construction machinery. TH7 hose meets or exceeds performance requirements of SAE 100R7 with a significantly tighter bend radius.

TH7S Hydraulic Hose - SAE 100R7 coming early 2016.

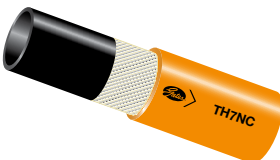

TH7NC Non Conductive Hydraulic Hose—SAE 100R7

Recommended For: Petroleum and synthetic hydraulic fluids. Applications include: power and telephone mobile equipment (cherry pickers), lubrication lines, blowout preventer control lines, hydraulic lifts and farm and construction machinery. Orange color TH7NC meets SAE 100R7 non-conductivity requirements and meets or exceeds performance requirements of SAE 100R7 with a significantly tighter bend radius. Meets ANSI A92.2 for vehicle mounted aerial devices [-4 to -8].

Hydraulics - Hose Products

Specialty/Thermoplastic - continued



TH7DL Dual Line Hydraulic Hose—SAE 100R7

Recommended For: Petroleum, water base and synthetic hydraulic fluids. Applications include: power and telephone mobile equipment (cherry pickers), lubrication lines, blowout preventer control lines, hydraulic lifts and farm and construction machinery. TH7DL hose meets or exceeds performance requirements of SAE 100R7 with significantly tighter bend radius.



TH7NCDL Non Conductive Dual Line Hydraulic Hose—SAE 100R7

Recommended For: Petroleum, water base and synthetic hydraulic fluids. Applications include: power and telephone mobile equipment (cherry pickers), lubrication lines, blowout preventer control lines, hydraulic lifts and farm and construction machinery. Orange color TH7NCDL meets SAE 100R7 non-conductivity requirements and meets or exceeds performance requirements of SAE 100R7 with significantly tighter bend radius. Meets ANSI A92.2 for vehicle mounted aerial devices [-3 and -8].

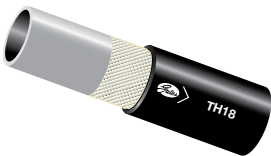

TH18 Constant Pressure Hydraulic Hose—SAE 100R18

Recommended For: TH18 hose meets or exceeds performance requirements of SAE 100R18 with a significantly tighter bend radius. Suitable for petroleum or synthetic-based hydraulic fluids in hydraulic systems. TH18 is ideal for industrial and agricultural applications exposed to low temperatures or cyclic and quick temperature changes. Remains highly flexible in cold weather conditions and is resistant to hydraulic fluids, high temperatures, aging and weathering.



TH18NC Constant Pressure Non Conductive Hydraulic Hose—SAE 100R18

Recommended For: TH18NC hose meets or exceeds performance requirements of SAE 100R18 with a significantly tighter bend radius. Suitable for petroleum or synthetic-based hydraulic fluids in hydraulic systems. TH18NC non-conductive hose are suitable for use in high-voltage applications. Remains highly flexible in cold weather conditions and is resistant to hydraulic fluids, high temperatures, aging and weathering.

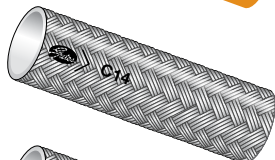

C14 PTFE Hose—SAE 100R14 Type A—Nonconductive

Recommended For: Air compressor discharge, hot oil and fluids, hot and greasy environments.



C14CT PTFE Hose—SAE 100R14 Type B—Conductive

Recommended For: Air compressor discharge, hot oil and fluids, hot and greasy environments.



Power Clean™ Hose

Recommended For: Heavy-duty use on hot and cold water high pressure cleaning equipment where heavy-duty service is required.



LP350 Liquid Hose

Recommended For: Liquid or gaseous propane, butane or any combination of these two mixtures. Can be used for natural gas (not to exceed 50 psi) under certain conditions such as: open/outside areas and well ventilated factory buildings (if local building codes permit).

Note: Not recommended for residential or office buildings. Contact Gates Product Application for inspection and assembly testing information.

Look for CNG hose coming in 2016.

Hydraulics - Couplings & Adapters

Gates couplings and adapters beat the competition, and meet or exceed the toughest SAE requirements. These products offer maximum flexibility and leak prevention on heavy-duty applications, regardless of pressure. By offering a full line of couplings and adapters, Gates can meet your every need. The listing below is not an exhaustive list of all Gates has to offer. For all Gates couplers and adapters, please see Hydraulic Catalog 431-2080.

G8K Couplings

Gates offers a full line of G8K couplings for most every need.



- Caterpillar Style O-Ring Flange
- Caterpillar Style O-Ring Flange - 45° Bent Tube and 90° Bent Tube
- G8K Ferrule for G8K Spiral Hose

GlobalSpiral™ Couplings

A new, no-skive permanent coupling design with superior performance features is now available for extreme high-pressure and high-impulse hydraulic applications. The GlobalSpiral coupling can be used with Gates G6K six- and four-spiral wire hydraulic hoses.



- Can be used on hoses with up to 6,000 psi working pressure in all sizes.
- Available in 30-plus thread/flange configurations.
- Bite the wire crimp.
- Non-lead steel.
- +250°F temperature capability.

Power Crimp® Couplings

Wide variety of couplings available for easy installation.



- Designed to perform with high and medium pressure hose.
- Sizes 3/16" through 2" I.D.
- Zinc plated carbon steel.

MegaCrimp® Couplings

MegaCrimp couplings give you a leak-proof seal that's so innovative, it's patented. In fact, it surpassed one million impulse cycles during design testing. MegaCrimp couplings set a new standard for hydraulic couplings. The unique "C" insert ensures "weep-free" concentric crimping to keep equipment and the environment clean.



- Robust "bite-the-wire" crimp.
- Low profile.
- Full stem insertion.
- Full-length crimp.
- TuffCoat™ plating for 500% better corrosion resistance.
- TuffCoat™ Xtreme™ plating for over 1000% better corrosion resistance.
- Fully qualified EN-performance coupling.

LOC, GL and GLP Couplings

Wide variety of couplings available for easy installation.



- Field Attachable Couplings
- GLP Couplings
- GL Couplings

Hydraulics - Couplings & Adapters

C14 Couplings

Special tools available to make swage type installations easy.



- Designed to perform with C14 Hose.
- Sizes 3/16" through 7/8" O.D.
- Stainless steel, brass or carbon steel.
- 13 thread configurations.

PCTS Thermoplastic Couplings

Swage style couplings make factory quality assemblies.



- Designed to perform with C7 and C8 thermoplastic hose.
- Sizes 3/16" through 1" O.D.
- 21 thread configurations.

Field Attachable C5 Couplings

Makes assemblies without a crimper.



- Designed to perform with Gates C5 hose.
- Sizes 3/16" through 1 13/16" I.D.
- 22 thread configurations.
- Zinc plated carbon steel.
- Meets DOT FMVSS 106-74 Type All.

Field Attachable C5E Couplings

Makes assemblies without a crimper.



- Designed to perform with Gates C5E Hose.
- Sizes 1/4" through 1 1/4" O.D.
- 16 thread configurations.
- Zinc plated carbon steel.
- Meets DOT FMVSS 106 Type A1.

Adapters

For easy assembly on extremely high, very high, high and medium pressure hose.



- Rated to SAE 100R2 pressure maximum.
- 8 flange to MJ adapters for extremely and very high pressure hose.
- 69 thread configurations.

Quick Disconnect Couplers

Features a meaningful part number that makes coupling identification fast and easy.



- Full line of hydraulic quick disconnects.
- Agriculture and Industrial interchange.
- Flush face and wing nut styles.
- Dust caps and plugs.

Hydraulics - Accessories

Small Nylon Tubing Cutter and Replacement Blades

Gives straight, clean, square cuts on J844 tubing from 1/8" to 3/4". Part No. 78015.



- Lightweight and compact size.
- Designed to ensure user's safety.
- "Blade guard" offers more protection against accidental blade contact.
- Ribbed handle ensures improved grip.

Gates also offers replacement blades in a five-pack bag [Part No. 78016].

MegaClean™ System

Used to remove dirt from the inside out with the help of pressurized launchers and compatible nozzles. Gates MegaClean foam projectiles sweep through the inside surface of the hose, taking fine particles of loose dirt and other contaminants with them. At 20-30 percent larger than the hose ID, these projectiles leave nothing behind but a hose that truly is clean from the inside out.



Air Brake Fittings

Female air brake swivels are designed to work exclusively with a male air brake adapter. Federal law requires only this combination to be used on air brake lines from the valve to the air brake diaphragm chamber. The male has straight threads and an inverted seat. The female has straight threads and a corresponding inverted flare. The seal is made on the flare seats of both the male and female.



Nylon Protective Sleeve

Gates Nylon Sleeves perform a dual role: They provide excellent abrasion resistance to protect individual hose; and they can be used to bundle several hose assemblies together for maximum protection. Downtime and maintenance costs are reduced. These Nylon Sleeves are unique because they form an extra protective layer against abrasive forces. Specifically, thousands of tiny Nylon filaments, woven into the texturized yarn, "friz" into a self-renewing shield that is extremely resistant to severe abrasion. This nylon sleeving has MSHA flame-resistance approval. Add 1/8" for installation.



Hydraulics - Accessories

LifeGuard® Line-of-Site Sleeving

The LifeGuard Line-of-Sight Sleeving System is the first true protection in line-of-sight hydraulic applications. It contains bursts up to 10,000 psi and pinhole leaks up to 5,000 psi at 250°F for up to five minutes. After redirecting the explosive force down the length of the hose, the LifeGuard sleeve disperses the energy and fluids at the hose ends via carefully designed “channel” clamps. The leaked fluid then allows for fast hose failure detection. The double-layer sleeve effectively shields against hazards.



Hose Guards

Gates offers a full line of hose guards for most every need.



- Plated Wire Spring Guards
- Plated Flat Armor Spring Guards
- Plastic Protective Coil Sleeves
- PolySleeve™ High Density Polyethylene Hose Wrap - Black and Yellow
- HeatGuard® Protective Sheathing
- HeatGuard® High-Temp Protective Sheathing

Vinyl Bend Restrictor

Gates tapered PVC sleeve reduces bending stress in the hose near the coupling to prevent damage, such as in power wash applications. Installed during hose assembly, this smoothly-finished product withstands temperatures from -40°F to +200°F [-40°C to +93°C].



Features Advantages:

- Friction Fit; no adhesives or clamps required to hold bend restrictor in place on hose assembly.
- Saves assembly cost.
- Smooth finish will not scratch finish on equipment being washed. Attractive appearance enhances look of quality.
- Tapered design reduces bending stress neat the hose-coupling junction so extra-long, more trouble-free hose life can be expected.
- Wide temperature helps give extra-long service life for both hot and cold power wash assemblies.

Air Conditioning & Refrigeration Systems

PolarSeal® Hose

Designed for environmentally safe R134a* refrigerants in automotive air conditioning and industrial systems such as tractors, construction trucks, and mobile and stationary refrigeration units. Can be crimped with current AC die sets on MC4-20, PC707, 3000B and OmniCrimp 21 crimpers, or with the PolarSeal portable crimper.



- Minimizes permeation of both R134a and R12 refrigerants.
- Cover is black synthetic EPDM rubber.
- Nylon barrier inside black chloroprene rubber tube is reinforced with spiraled polyester.
- Meets or exceeds SAE J2064 Type C, Class II.
- Temperature rating: -22°F to +257°F [-30°C to +125°C], Class II.

Note: For a complete listing of PolarSeal Hose and Couplings, see Gates Hydraulic Catalog 431-2080.

* Beginning in 1995, all new air conditioning systems in cars, light trucks and industrial applications manufactured in North America must use R134a refrigerant.

PolarSeal® II Hose

PolarSeal II Hose is designed to be installed with PolarSeal II couplings and clamps. Meets SAE J2064 Type C, Class I - use with R12, R13A and R22 refrigerants. Recommended for air condition systems on school/transit buses, RV's, limos and other heavy equipment that has long run or hard to service AC lines. Elastomeric tube with fabric braid reinforcement. Cover is heat, moisture and ozone resistant.



- Temperature rating: -22°F to +257°F [-30°C to +125°C].
- Coupling Recommendation [See Crimp Data Manual 428-7365 or E.Crimp]: PolarSeal II Coupling.

Note: For a complete listing of PolarSeal II Hose and Couplings, see Gates Hydraulic Catalog 431-2080.

PolarSeal® and PolarSeal® II Couplings and Accessories

OEM quality couplings in 64 configurations to fit most mobile refrigeration and air conditioning applications.

- Available in straight, 45° and 90° styles.
- Comes in male, female, flared, flareless and swivel ends to fit most popular applications.
- Four sizes of "O-Rings" especially compounded for R134a refrigerants.
- Five inline orifice tubes.

Note: For a complete listing of PolarSeal Couplings, see Gates Hydraulic Catalog 431-2080.



Air & Defroster Systems

Turbocharger Hose

Specially compounded for use as a short, flexible connector between the air intake and the turbocharger. Can also be used for turbocharger air discharge. Approved for Marine Applications.

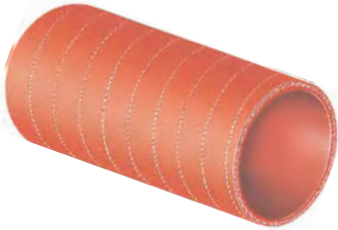

- Silicone elastomer inner liner reinforced with woven fiberglass fabric and coated with orange silicone rubber.
- Resists high temperatures and pressures.
- Resists coolants, weathering and ozone.
- Highly visible orange color helps distinguish this hose from engine coolant hose.

I.D. (In.)	Part No.	Length (In.)	Work Press. (psi)	I.D. (In.)	Part No.	Length (In.)	Work Press. (psi)	I.D. (In.)	Part No.	Length (In.)	Work Press. (psi)
1	26116	36	45	2 ³ / ₄	26144	36	25	3 ¹ / ₂	26156	36	20
1 ¹ / ₂	26124	36	40	3	26001	3	25	3 ³ / ₄	26160	36	15
1 ³ / ₄	26128	36	35	3	26148	36	25	3 ⁷ / ₈	26162	36	15
2	26132	36	35	3 ³ / ₈	26002	3 ¹ / ₂	15	4	26164	36	15
2 ¹ / ₄	26136	36	30	3 ³ / ₈	26003	6	15	4 ¹ / ₂	26166	36	15
2 ³ / ₈	26138	36	30	3 ³ / ₈	26154	36	15	5	26007	3 ¹ / ₂	15
2 ¹ / ₂	26140	36	30	3 ¹ / ₂	26004	3	30	5 ¹ / ₂	26008	3 ¹ / ₂	15
2 ⁵ / ₈	26142	36	15								

Molded Turbocharger Hoses

OE-Exact Turbocharger Hose features multi-layered construction with inner aramid reinforcement for maximum durability and strength.



- Resists high temperatures, high pressures and oil permeation.
- Absorbs and isolates vibrations and shock.

Molded Heavy-Duty Turbocharger Hoses

Cold side CAC curved hose.



- Meets SAE 20R4 Class D1 with M-Aramid reinforcement and .17/.28" wall.
- Temperature rating: -40°F to +257°F [-40°C to +125°C].

Molded Turbocharger Hose Kits

OE Improved Turbocharger Hose Kit for complete replacement in a single kit.



- Specially formulated fluorelastomer liner prevents oil permeation.
- Multiple layers of reinforcement for improved service life.
- High-quality silicone cover provides excellent heat resistance in high- temperature underhood conditions.
- T-bolt clamps with stainless steel band and bridge resist corrosion and provide higher torque for better sealing over traditional worm gear clamps.
- Hose is manufactured in the U.S.A.

Air & Defroster Systems

Green Stripe® Ring Retained Turbocharger Hose

Made for turbocharged Class 8 and heavy-duty diesel engines. Multi-hump design isolates vibration and absorbs rotational shock. Depending on application, hose is engineered with three or four rings to maintain design integrity.



- Four layer silicone construction with aramid fiber reinforcement for maximum durability.
- Meets or exceeds OEM specifications.
- Temperature rating: -60°F to +500°F [-51°C to +260°C].

Part No.	I.D. (In.)	Length (In.)	Work. Press. (psi)
26200	3	6	25
26201	3½	6	25
26203	4	6	25
26204	4	8	25

Defroster/Air Intake Hose

For defrosters, air ducts, air intakes, under-hood applications and other low pressure, low suction applications. Approved for marine applications.



- Flexible, heat-resistant materials and helical steel wire reinforced.
- Easily cut and formed to desired shape and length.
- Tear, abrasion and ozone resistant.
- Complies with DOT FMVSS 302.
- Temperature rating: -40°F to +200°F [-40°C to +93°C].

I.D. (In.)	Part No.	I.D. (In.)	Part No.	I.D. (In.)	Part No.
1¼	23820	2½	23840	4	23864
1½	23824	2¾	23844	4½	23872
1¾	23828	3	23848	5	23880
2	23832	3¼	23850	6	23896
2¼	23836	3½	23856		

Green Stripe® Heavy-Duty Air Vent Hose

Specifically designed for air cleaner-to-engine connections and other ducting applications.



- Heat and oil-resistant tube.
- Flexible, helical wire reinforced.
- Cover is heat, oil and abrasion resistant.
- Smooth interior offers minimum air resistance for maximum efficiency.
- Easily cut with knife and wire cutters.
- Temperature rating: -40°F to +257°F [-40°C to +125°C].

Caution: Not recommended for conveying liquids.

Part No.	I.D. (In.)	Work Press. (psi)	Vacuum Rating (In. /Hg.)
24324	4	10	7
24325	4½	10	7
24326	5	10	6
24327	5½	10	6

Air & Defroster Systems

AV Series Air Vent Hose

Specifically designed for air cleaner-to-engine connections and other ducting applications.



- Available in pre-formed hump (similar to Vibraflex®), straight and curved configurations.
- Heat and oil resistant.
- Temperature rating: -40°F to +225°F.

Style	Part No.	[I.D. x Length] [In.]	Style	Part No.	[I.D. x Length] [In.]
Hump	23002	4 x 5	Molded	23201	3 x 5 1/4 x 90°*
	23004	5 x 6	Elbow	23202	3 1/2 x 5 1/2 x 45°
	23005	5 1/2 x 6		23203	3 1/2 x 5 1/2 x 90°*
	23006	6 x 5	23208	5 x 5 1/4 x 45°	
Reducer	23100	3 1/2 x 3 x 5 1/4	23209	5 x 6 x 90°	
Hump	23101	4 x 3 x 5 1/4	23215	6 x 6 1/2 x 45°*	
	23106	6 x 5 1/2 x 6	23216	6 x 7 1/2 x 45°*	
	23107	7 x 6 x 5	23218	6 x 7 x 90°*	
Straight	23400	4 x 22	23221	7 x 7 1/2 x 90°	
Flexible	23401	6 x 19	Reducer	23300	6 x 5 1/2 x 90°
	23402	6 1/8 x 19	Elbow		

*Ribbed

Emission Control Duct Hose

Connects hot air from exhaust manifold shroud to air cleaner for efficient control of emissions. Helps eliminate carburetor icing and improves engine warm-up.



- Aluminum polyester construction for economy.
- Fiberglass aluminum (black) for greater strength and durability.
- Completely flexible and easily bent, yet retains shape after forming.
- Resists heat, cold, oil and water.
- Cuts with knife for easy installation.
- Install with or without clamps.
- Temperature rating: -40°F to +400°F [-40°C to +204°C].

I.D. [In.]	Length [In.]	Part No.	I.D. [mm]	Length [mm]	Part No.
3/4	36	28092	40	1000	28091
7/8	36	28085	50	1000	28082
1 1/2	18	28093	60	1000	28081
1 1/2	36	28088			
1 3/4	18	28094			
1 3/4	36	28089			
2	18	28095			
2	36	28090			

Service Hose

Safety Stripe® Air Hose

Durable, premium hose for garage and service station air impact tools.



- High strength reinforcement.
- High flexibility is easy on wrists.
- Perforated EPDM red cover that resists ozone and abrasion.
- Bend restrictors for extended life.
- Factory assembled male couplings with 300 lb. minimum coupling pull.
- Temperature rating: -40°F to +200°F [-40°C to +93°C].

Part No.	I.D. (In.)	Length (Ft.)	Working Pressure (psi)	Coupling Thread Size
27485	1/4	25	300	1/4-18NPT
27486	1/4	50	300	1/4-18NPT
27488	3/8	25	300	1/4-18NPT
27489	3/8	50	300	1/4-18NPT
27491	1/2	25	300	1/2-14NPT
27492	1/2	50	300	1/2-14NPT

Charter® Air Hose

Designed for multi-purpose air hose applications. Capable of impact tool use.



- Textile reinforcement.
- Perforated EPDM red cover is ozone and abrasion resistant.
- Factory applied male couplings have 250 lb. minimum coupling pull.
- Temperature rating: -40°F to +200°F [-40°C to +93°C].

Part No.	I.D. (In.)	Length (Ft.)	Working Pressure (psi)	Coupling Thread Size
27475	1/4	25	200	1/4-18NPT
27476	1/4	50	200	1/4-18NPT
28673	1/4	300*	200	—
27478	3/8	25	200	1/4-18NPT
27479	3/8	50	200	1/4-14NPT
28674	3/8	300*	200	—

*300' lengths are not coupled.

Service Hose

Hybrid Air Hose

Gates hybrid polymer air hose combines flexibility and strength together, making it the best hose for air service applications.



- Lightweight, extremely flexible construction.
- Zero memory, allowing hose to lay completely flat.
- Superior bend radius.
- High abrasion and chemical resistance.
- Kink resistant, even under pressure.
- Easy coiling after use.

Fittings:

- Fittings and ferrules are 100% brass.
- Heavy-duty PVC bend restrictors on both ends.

Part No.	Description
27568	1/4" I.D. x 15/32" O.D. x 25 ft. [300 psi, 1/4" NPT Male, 1/4" NPT Male]
27569	1/4" I.D. x 15/32" O.D. x 50 ft. [300 psi, 1/4" NPT, Male]
27570	3/8" I.D. x 19/32" O.D. x 25 ft. [300 psi, 1/4" NPT, Male]
27571	3/8" I.D. x 19/32" O.D. x 50 ft. [300 psi, 1/4" NPT, Male]
27572	1/2" I.D. x 3/4" O.D. x 25 ft. [300 psi, 1/2" NPT, Male]
27573	1/2" I.D. x 3/4" O.D. x 50 ft. [300 psi, 1/2" NPT, Male]
27580	3/8" I.D. x 5/8" O.D. x 2 ft. Whip Hose [300 psi, 1/4" Male Ball Swivel, 1/4" NPT Female]
27582	3/8" I.D. x 5/8" O.D. x 4 ft. Whip Hose [300 psi, 1/4" Male Ball Swivel, 1/4" NPT Female]
27583	3/8" I.D. x 5/8" O.D. x 6 ft. Whip Hose [300 psi, 1/4" Male Ball Swivel, 1/4" NPT Female]

Charter® Multi-Use Air/Water Hose

Ideal for air and water applications. Engineered for heat, abrasion and ozone resistance.



- EPDM rubber tube and cover.
 - Two layers of spiral synthetic reinforcement.
 - Gates Power Crimp® specifications available*
 - Temperature rating: -40°F to +200°F [-40°C to +93°C].
- *Contact your local Gates sales associate for specification information.

Caution: Do not use for oil, grease or fuel transfer.

I.D. (in.)	Work. Press. (psi.)	Part No. 50 Ft.	Part No. Reels	Reel Length Ft.	I.D. (in.)	Work. Press. (psi.)	Part No. 50 Ft.	Part No. Reels	Reel Length Ft.
1/4	200	28823	28800	600	5/8	200	28830	28812	550
5/16	200	28825	28803	600	3/4	200	28832	28815	500
3/8	200	28826	28806	600	1	200	28836	28818	350
1/2	200	28828	28809	600					

Service Hose

Multi-Use Hose

For handling lower pressure air, water, agricultural spraying, oil or grease. Can also be used for air spray painting.

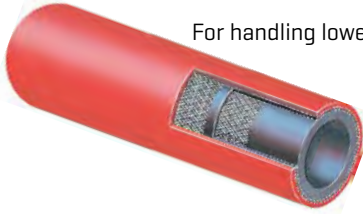

- Nitrile tube and cover provide high oil resistance.
- One braid polyester cord reinforcement.
- Temperature rating: 0°F to +212°F [-18°C to +100°C].

Caution: Not recommended for use as small I.D. by-pass, coolant and heater hose. Do not use for fuel transfer applications.

Part No. 50 Ft.	Part No. 300 Ft.	I.D. [In.]	Work Press. [psi]	Braid
27402	28652	1/4	315	1
27404	28657	5/16	315	1
27406	28661	3/8	315	1
27410	28665	1/2	315	1
27414	28667	5/8	315	1
27418	28671	3/4	315	1
27420	28765	1	315	1

Signal Call Tubing

Designed for driveway signal devices in service stations and garages.

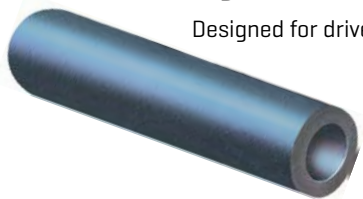

- Long-lasting EPDM rubber tubing specially built to register under the slightest pressure.
- Withstands vehicle weight at temperatures up to +150°F [+66°C].
- Meets SAE J1037, J942b specifications.

Part No.	I.D. [In.]	Length [Ft.]
27539	3/8	50
28681	3/8	100
28686	3/8	300

Hybrid Water Hose

Gates innovative Water Hose featuring premium hybrid polymer material for extreme flexibility.



Features:

- Zero memory, allowing it to lay-flat.
- Superior bend radius.
- High abrasion and chemical resistance.
- Kink resistant, even under pressure.
- Easy coiling after use.

Fittings:

- Heavy-duty nickel plated fittings and spring guard

Service Hose

Service-Master® Water Hose

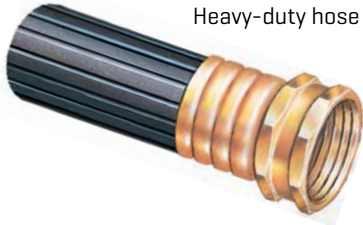

Heavy-duty hose for fleets, service stations and repair shops. Ideal for cement trucks and wash rack use.

- EPDM tube handles hot water up to +200°F [+93°C].
- Two-braid reinforcement.
- Flexible and kink resistant.
- Rugged black EPDM cover with protective rib design resists abrasion, weathering and crushing.
- 250 ft. bales uncoupled.

Part No.	I.D. [In.]	Length Ft.]	Work. Press. [psi]
28692	3/4	250	200

Exhaust System Hose

Exhaust Hose (Hardwall) Wire Reinforced

Heavy-duty fabric-reinforced hose with a helical steel wire reinforcement to meet marine water and wet exhaust hose requirements.



- Features blue layline for easy identification.
- Resists heat and oil.
- Meets SAE J2006 requirements.
- Working pressure 100 psi for water application, 10 psi for exhaust application.
- May be used for engine water circulation, discharge lines, heat exchangers and wet exhaust connections.

I.D. [In.]	12.5 Ft. Length Part No.	I.D. [In.]	12.5 Ft. Length Part No.	I.D. [In.]	12.5 Ft. Length Part No.
1 ¹ / ₈	250-1184	2 ¹ / ₈	250-2184	3 ¹ / ₂	250-3124
1 ¹ / ₄	250-1144	2 ¹ / ₄	250-2144	4	250-4004
1 ³ / ₈	250-1384	2 ³ / ₈	250-2384	4 ¹ / ₂	250-4124
1 ¹ / ₂	250-1124	2 ¹ / ₂	250-2124	5	250-5004
1 ⁵ / ₈	250-1584	2 ⁵ / ₈	250-2584	5 ¹ / ₂	250-5124
1 ³ / ₄	250-1344	2 ³ / ₄	250-2344	6	250-6004
1 ⁷ / ₈	250-1784	2 ⁷ / ₈	250-2784		
2	250-2004	3	250-3004		

Fleet Accessories

Heavy-Duty Hood Latch Kit

Universal hood latch kit for medium- and heavy-duty applications. Part No. 90350.



- Kit includes anti-rattle nub.
- Brackets are made from hot-rolled steel with clear zinc chromate plating for superior corrosion resistance.
- Hood latch is made of EPDM rubber which is specially formulated to resist ozone for long service life.

Splash Guards

Minimizes splashing of rain and settled water from wheels on medium and heavy-duty trucks.



- Tough rubber and fabric-filled construction for maximum service life.
- Special half-round reinforced ridge resists tearing and cracking.
- Body is 1/4" thick and edge is 3/8" thick for extra strength.

Length [In.]	Width [In.]	Part No.
26	24	90335
30	24	90333
36	24	90334
40	24	90332

Static Straps

Discharges potentially dangerous static electricity from equipment when properly grounded, up to 100 ohm-cm (maximum).



- Specially compounded rubber conducts static electricity.
- Resists weathering, abrasion and tearing.
- Meets, military specifications MILR3065C.

Length [In.]	Width [In.]	Depth [In.]	Part No.
25	1 ¹ / ₁₆	³ / ₁₆	90330
30	1 ¹ / ₁₆	³ / ₁₆	90331

Merchandisers & Sales Aids

Barricade® Fuel Line and Vacuum Tubing Merchandiser/Assortment

Attractive, metal cabinet comes assembled. Holds and dispenses 12 reels of fast-selling Gates Barricade Fuel Line, EEC and PCV hoses, or tubing for windshield washers and vacuum-operated accessories. Part No. 91184 and Part No. 91183 - display only.



- Contains 12 fast-selling hose sizes on individually mounted and replaceable reels.
- Handy measuring scale printed on lid makes it easy to measure exact size of hose needed.
- Can be displayed on counter or mounted on wall.
- Attached chain designed to hold hand-held hose cutter.
- Base dimensions are 16"D x 19 1/2"W x 18"H.

Note: Combine this merchandiser with the Heater Hose Merchandiser to create the modular Hose Center.

Fuel Line /PCV / EEC Hose			Vacuum Tubing			Barricade® Carburetion Hose			Barricade® Injection Hose		
I.D. (In.)	Length (Ft.)	Part No.	I.D. (In.)	Length (Ft.)	Part No.	I.D. (In.)	Length (Ft.)	Part No.	I.D. (In.)	Length (Ft.)	Part No.
1/8	25	27000	1/8	50	27041	3/16	25	27312	1/4	25	27339
3/16	25	27001	5/32	50	27042	1/4	25	27313	5/16	25	27340
			7/32	50	27043	5/16	25	27314	3/8	25	27341
			1/4	50	27044	3/8	25	27315			

Heater Hose Merchandiser



Attractive, yet rugged metal cabinet organizes and keeps stock neat. Designed to hold dispensing cartons, making it easy to pull hose out for measuring. Create a "Hose Center" by adding the popular Gates Fuel Line/PCV/EEC and Vacuum Tubing Merchandiser to the top of this unit. Part No. 91160.

- Holds one each 50 ft. cartons of 1/2", 5/8" and 3/4" heater hose.
- Handy 36" measuring scale printed on side makes it easy to measure the exact length of hose needed.
- Assembled unit measures 20 1/8" x 17 1/2" x 43".

Note: Merchandiser does not include hose.

Hybrid Air Hose Display

Gates offers a hybrid air hose display with distinct signage identifying the product..



- Lightweight, extremely flexible.
- Zero memory, allowing it to lay completely flat.
- Superior bend radius, Kink resistant and easy coiling.
- High abrasion and chemical resistance.
- 100% brass fittings and ferrules with heavy-duty PVC bands on both ends.

Part No. 27571B includes: Full corrugated pallet box with opening, sign, [54] 27571.
Part No. 27571H includes: Half corrugated pallet box with opening, sign, [36] 27571.

Merchandisers & Sales Aids

Hose Clamp Merchandiser

Appealing display holding the top 2 fuel line clamps, 2 heater hose clamps and 3 radiator hose clamps. Part No. 91192 and Part No. 91191 - display only.



- Easily mounts to counter, wall or isle
- Dimensions are 15" x 5 1/8" x 17 1/2"
- Includes: Display, [20] 32001, [10] 32007, [10] 32010, [20] 32012, [10] 32020, [20] 32028, [10] 32036

Air Brake Hose Product Merchandiser

This merchandiser holds air brake hose assemblies, PTFE assemblies and is packed with labels for both products. The merchandiser keeps assemblies organized, handy and ready to use. Part No. 91180.



- Mounts to the wall.

Professional-Grade Tools

Belt Wear Gauge

Like tires, EPDM V-ribbed belts wear out gradually, steadily losing rubber material. This unique tool is designed to help inspect serpentine belts for wear. EPDM belts, installed by original equipment manufacturers on new vehicles, typically do not show obvious signs of wear such as cracking. Contact your local Gates representative or visit www.gatesbeltwear.com to request your free tool.



Serpentine Belt Installation Tool

Time-saving tool affords improved control and reach when installing serpentine belts. Also helps install V-belts and timing belts located in difficult-to-reach areas. Part No. 91209.

- Dual-pin design affords convenient belt push/pull capability.
- Tool's handle lends easy twisting control of belt in hard-to-reach places.



Serpentine Ratcheting Wrench Set

Provides fast way of releasing tension on serpentine belt drives. Reversible, 21-tooth ratcheting heads on each end allow for better tool positioning and more swing than standard serpentine belt wrenches. Part No. 91011.

- Wrenches are 21 1/2" long, 6" longer than competitive designs for increased leverage.
- Includes eight sizes for maximum application coverage: 13mm, 14mm, 15mm, 16mm, 17mm, 3/8", 1/2" and 3/4."



Serpentine Belt Tension Relief Tool

Ideal tool for removing and installing serpentine belts. Provides necessary leverage and clearance to release spring pressure and move tensioner pulley arm. Part No. 91015.

- Three-bar design includes seven sockets [13mm, 14mm, 15mm, 16mm, 18mm, 3/8" and 1/2"].



Professional-Grade Tools

DriveAlign® Laser Alignment Device

Exclusive, patented tool is compatible with all automotive serpentine belt drives. Quickly identifies two most common types of pulley misalignment – parallel offset and angular – that reduces belt and pulley service life and produce unwanted noise. Simply position tool within grooves of pulley and aim laser beam at opposite pulley. Part No. 91006.



- Lightweight, easy-to-use tool includes special laser enhancement glasses for easy viewing in all light conditions.
- Comes with high-impact resistant carrying case.

V-Ribbed Belt Strap Pulley Wrench

Revolutionary tool allows technicians to easily remove stubborn drive pulleys. Part No. 910131.



- Specifically designed to grasp and hold automotive SAE V-ribbed belt driven pulleys.
- Simple to use, it is fabricated with a heavy-duty aluminum alloy handle, enabling plenty of gripping force on a pulley via the plastic composite locking head.
- The specially constructed V-ribbed strap, with its high coefficient of friction, settles into pulley grooves or flattens against the smooth surface of a pulley, providing the utmost grasping control and allowing the user to easily remove stubborn drive pulleys from accessories.

Product Grabber (Telescoping Pole)

Allows easy product hanging and retrieval from belt boards that are installed high on walls. Part No. 91233.



- 4' pole, extends to 11'.
- Extra-long 8" hook for extended reaches.

V-Ribbed Belt Length Finder

Handy tool measures every serpentine belt made to help determine replacement belt for cars, light trucks, buses, heavy trucks and other equipment. Part No. 91202.



- Telescopes out to measure up to 120" belts. Compact 3 ft. length when closed.
- Accurate, lightweight and easy to use.
- For specific applications and recommended replacement belt numbers, see Gates Catalogs and Owners' Manuals.

Professional-Grade Tools

V-Belt Number Finder

Versatile 88" device helps determine replacement belt numbers for cars, light trucks, heavy trucks, buses and Truflex®/PoweRated® light-duty belts, when the old belt is available. Part No. 91201.



- For automotive and light-duty belt applications, see Gates Catalogs and Owners' Manuals to verify recommended replacement parts.

Truflex® and PoweRated® Belt Length Finder

Improved belt length finder measures FHP belts up to 107" to determine equivalent Truflex or PoweRated belt numbers. Part No. 91104.



- Instructions for using finder packed with unit.

Kriket V-Belt Tension Gauge

This easy-to-use gauge is designed for tensioning all automotive V-belts up to, and including, 7/8" top widths. Part No. 91107.



- Scale reads in pounds and kilograms. Measures tension from 30 to 160 lbs., and 15 to 75 kg.
 - Die-cast aluminum body, nylon indicator arm and pressure pad.
 - Fits in pocket with stainless steel pocket clip.
- Note:** Not for use on timing belts.

Kriket II Century™ Series [V-Ribbed] Belt Tension Gauge

Designed for tensioning V-ribbed belts on passenger cars, light trucks, heavy trucks and buses. Part No. 91132.



- Bright green pressure pad and indicator arm.
 - Calibrated to measure tension from 100 to 320 lbs., and 50 to 150 kg.
 - Measure belts up to eight ribs in width.
- Note:** Not for use on timing belts.

Coolant and Battery Refractometer

Measures concentration of coolant mixture in engine. Place small sample of coolant on lens, then hold lens up to light source. Light bends through liquid, providing an accurate reading on scale. Part No. 91001.



- Measuring coolant concentrations is essential to cooling system maintenance.
- Most technicians use hydrometers to test coolant concentration via gravity or floating ball scales.
- Hydrometers must be temperature corrected, and may give false readings when testing new, propylene-based coolants.
- Gates refractometer automatically corrects for temperature on both types of coolant [ethylene and propylene glycol] while measuring battery charge levels.

Professional-Grade Tools

PowerClean™ Flush Tool

Cooling systems can be difficult to flush completely due to accumulated debris. Inadequate flushing can ruin a newly installed water pump and result in warranty problems and frustrated customers. Make sure you perform a complete cooling system flush by using clean water and compressed air. The PowerClean Flush Tool “water hammers” accumulated sludge and scale deposits without the use of harsh chemicals or solvents. It cleans radiators, heat exchangers, hoses and engine blocks more effectively than conventional flushes, maintains system integrity and ensures warranty coverage on replacement parts, including water pumps. The PowerClean Flush Tool patented process uses fixed dimensional control of the air and liquid flow paths. The process allows air to pressurize the cleaning fluid to scrub deep into corners and crevices, eliminating trapped debris.



- Pulsating gun assembly with pre-set regulator.
- Water line backflow preventer.
- Large rubber tip for radiator necks and direct flushing of the engine block.
- Small rubber tip on whip hose for direct access to heater core tube stubs.
- 5/8" And 3/4" heater hose barbs for flushing heater cores or engine blocks.
- Durable protective storage case with room for additional items. Part No. 91002.

Part No.	Description
91002-1	Storage Case W/Foam Inserts
91002-2	Patented Flushing Gun
91002-3	Small Tip for Heater Core
91002-4	Large Tip for Radiators
91002-5	5/8" Heater Hose Connector

Part No.	Description
91002-6	3/4" Heater Hose Connector
91002-7	Whip Hose W/Quick Couplers
91002-8	Supply Hose Backflow Preventer
91002-9	4 1/2" Large Tip for Trucks

Hose Clamp Pliers Set

Quickly and easily reach, install, release, or even remove hard-to-reach hose clamps with this handy kit. Part No. 91067.



- Set includes: Remote action flexible hose clip tool with 600mm reach, large flat-band pliers (angled for access), and hose release hook.

Heavy-Duty PowerGrip® SB Clamp Removal Tool

Offers easiest method for removing Gates revolutionary shrink-to-fit PowerGrip SB clamps. Part No. 91215.



- Quickly removes clamps without damaging hose.

Professional-Grade Tools

Quick-Lok® Coupling Removal Tool

For installation and removal of 5/8" and 3/4" heater hose with Quick-Lok connectors. Part No. 91204.



- Allows fast, easy way to connect replacement heater hose assemblies on passenger cars and light trucks.
- Helps retain connector O-rings so they don't fall out or get damaged.

PolarSeal® II Pliers

PolarSeal II Pliers are used to crimp clamps on PolarSeal II couplings. Any one of three pliers will get the job done. Each tool is designed with slightly different features.

Ratcheting Plier – Part No. 77953



- The ratcheting plier features a no-release function. Once a crimp is started the plier does not release until the crimp is complete. This guarantees a proper seal, with no guess work in the crimp.

Straight Jaw Plier – Part No. 77952



- The straight jaw plier is a low cost, no-frills plier. This plier works best when there are no obstructions to hinder gripping the clamp or completing the crimp.

Notched Jaw Plier – Part No. 77951



- The notched jaw plier is designed for the hard-to-reach places. If obstructions prohibit the use of straight jaw pliers this is the tool to use. Use either side or the front of this plier to make the crimp.

Professional-Grade Tools

Hose Cutters (Hand-Held) and Replacement Blades

Makes clean cuts with no ragged edges. Cuts most non-metal reinforced rubber hose. Excellent for cutting textile-reinforced hose.



Features Advantages:

- Blade closes into handle for safety.
- Cutter and blades packaged individually on shrink-wrapped cards.
- Lightweight with nylon handles.

Hose Cutter	Description	Replacement Blade	Cuts to Hose I.D.
91143	Large I.D. Hose Cutter	91144	3"
91153	Small I.D. Hose Cutter	91154	1½"

SureLok™ Quick-Release Pliers

SureLok push-to-connect couplings are the easiest and quickest couplings to install. But disconnecting them can be another matter. Placement near obstructions, as well as age and road debris, can adversely affect your ability to quickly disconnect SureLok couplings. Many times getting hands into an area to remove a coupling is almost impossible. SureLok pliers allow for the quick removal of SureLok couplings from the tubing with just one hand. To help get into those tight spaces, SureLok pliers offer two different heads: one straight and one at a 90° angle. They also come in two sizes: small for tubing from 1/8" to 3/8"; and large for tubing from 3/8" to 3/4".



SureLok Plier Single Packs:

- Small Angle:** Part No. 91021
- Small Straight:** Part No. 91023
- Large Angle:** Part No. 91020
- Large Straight:** Part No. 91022

- SureLok Plier Four-Pack:** Part No. 91017



Sonic Tension Meter

The proper way to check belt tension is to use a tension tester. The Sonic Tension Meter measures the vibration of the belt span and instantly converts the vibration frequency into belt static tension. This is the span vibration method of tensioning belts. Part No. 7420-0508.



Index by Equipment Type and Make

Indexes & Abbrev.

Make	Page Number	Make	Page Number	Make	Page Number
Medium & Heavy-Duty Trucks (2001 & Newer)		Transit Buses - Continued		Road & Construction Equipment - Continued	
American LaFrance.....	1	M.A.N.....	377	Grimmer-Schmidt.....	483
Autocar.....	1-2	Marcopolo.....	377	Grove.....	484
Caterpillar.....	2	MCI.....	377-379	Hamm.....	484
Chevrolet.....	2-7	MCR.....	379	Herc.....	484-485
Crane Carrier Company.....	7	Nabi.....	379	Hitachi.....	485
Dodge.....	7-8	National Coach.....	379	Huber-Warco.....	485-486
Ford.....	8-19	Neoplan.....	379-380	Hughes-Kennan.....	486
Freightliner.....	19-59	New Flyer.....	380-381	Hydra-Mac.....	486
GMC.....	59-64	Nova Bus.....	381	Hyhoe.....	486
Hino.....	64-67	Optare.....	381	Hyster.....	486-488
International/Navistar.....	67-94	Optima Bus Corporation.....	381	ICC.....	488
Isuzu.....	95-97	Orion.....	381-383	Ingersoll.....	488-489
Kenworth.....	97-119	Prevost.....	383	Ingram.....	489
Mack.....	119-131	Setra.....	383-384	Insley.....	489
Mitsubishi Fuso.....	131	Thomas Built.....	384	International.....	489-493
Oshkosh.....	131	TMC.....	384	Jaeger.....	493-494
Peterbilt.....	131-156	Turtle Top.....	384	JCB.....	494
Sterling.....	156-165	U.S. Bus.....	384	John Deere.....	494-508
UD (Nissan).....	165-167	Van Hool.....	385	Joy.....	508-509
Volvo.....	167-176			Kawasaki.....	509
Western Star.....	176-182			Kobelco.....	509
Workhorse.....	182-185			Koehring.....	509-510
				Komatsu.....	510-513
Refrigeration Units		Road & Construction Equipment		Kubota.....	513-514
Arctic Traveler.....	186	Advance Sweeper.....	386	Le Roi.....	514
Carrier.....	186	Allis-Chalmers.....	386-389	Le Tourneau.....	514-515
Thermo King.....	186-192	American Crane Corp.....	389	Liebherr.....	515
Transicold.....	193-194	Arrow-Master, Inc.....	389	Link-Belt.....	515-516
		Austin-Western.....	389-392	Little Giant.....	516
School Buses		Badger.....	392	Long.....	516
Amtran.....	195-196	Bantam.....	392-393	Lorain.....	516
Bluebird.....	196-204	Barber-Greene.....	393-394	Massey Ferguson.....	516-517
Carpenter.....	204	Bay City.....	394-395	MDI/Yutani.....	517-518
Chevrolet.....	204-221	Blaw-Knox.....	395-396	M-R-S.....	518
Collins.....	221	Bobcat-Melroe.....	396-400	Multiho.....	518
Corbell.....	221-222	Bomag.....	400-401	MultiQuip.....	518
Crown Coach.....	222-223	Broderson.....	401	Mustang.....	518
Dodge.....	223-228	BROS.....	401-402	New Holland.....	518
Ford.....	228-253	Brown.....	402	Owatonna.....	519
Freightliner.....	253-256	Bucyrus-Erie.....	402-404	P & H.....	519
GMC.....	256-276	Buffalo Springfield.....	404	Parsons.....	520
International/Navistar.....	276-358	Case.....	404-412	Pettibone.....	520
Mid Bus.....	358	Caterpillar.....	412-448	Poclair.....	520-522
Thomas Built.....	358-365	Cedar Rapids.....	448-449	Pumpmaster.....	522
Ward.....	365	Champion.....	449	Raygo.....	522-523
		Chicago-Pneumatic.....	449-450	Rex.....	523
Transit Buses		Clark-Lima.....	450	Samsung.....	523
ABC Bus Company, Inc.....	366	Clark-Michigan-VME.....	450-458	Smith Co.....	523
Aerocoach.....	366	Cleveland.....	458	Sullair.....	523
Alexander-Dennis.....	366	CMI.....	458	Takeuchi.....	523-524
AM General.....	366	Dart.....	458	Tampo.....	524
Beaver Coach.....	366	Ditch Witch.....	458-459	Tamrock.....	524
Bluebird.....	366-367	Dresser-Dressta.....	459-462	TCI.....	524
Champion Bus.....	367	Dresser-Galion.....	462-466	Terex.....	524-526
Chance Mfg. Co.....	367	Dresser-Hough.....	466-474	Thew Shovel.....	526-527
Chevrolet.....	367	Drott.....	474-476	Thomas.....	528
Eagle.....	367-368	Dynahoe.....	476	Toyota.....	528
El Dorado.....	368	Dynapac.....	476-477	Trojan-Yale.....	528
Flxible.....	368-370	Easi-Doer.....	477	Unimog.....	528
Gillig.....	370-373	Elgin.....	477	Unit Crane & Shovel.....	528
GMC.....	373-377	Elite.....	477	Vermeer.....	529
Goshen Coach.....	377	Euclid.....	477-478	Versa.....	529
Graf & Stift.....	377	Ferguson Shovel Supply.....	478-479	Vibromax.....	529
Ikarus.....	377	Fiat-Allis.....	479-480	Vibro-Plus.....	529
International/Navistar.....	377	FMC.....	480	VME.....	529
LAG.....	377	Ford.....	480-481	Volvo.....	529-530
		Fresia.....	481	Wabco.....	530-532
		Gardner-Denver.....	481-483	Waldon.....	532
		Gehl.....	483		
		Gomaco.....	483		

Index by Equipment Type and Make

Indexes
& Abbrev.

Make	Page Number	Make	Page Number	Make	Page Number
Road & Construction Equipment		Lift & Industrial Equipment		Lift & Industrial Equipment	
- Continued				- Continued	
Warner & Swasey.....	532-533	Allis-Chalmers	557-563	Komatsu	596
Weldon	533	Automatic Transportation.....	563	Lift All	596-597
Zettlemeyer.....	533	Baker	563-570	Lull	597
Power Units		Bobcat	570	Massey Ferguson.....	597
Aggreko	534	Case	570-571	Mercury.....	597
Allis-Chalmers	534-536	Caterpillar	571-577	Mitsubishi.....	597
Amita	536	Champ	577-578	Mobilift	597-599
Bedford	536	Clark	578-580	Namco	599
Caterpillar	536-541	Condor.....	580	Nissan.....	599
Cummins	541-551	Dresser-Dresssta	580	Ottawa	599-600
Deutz-Allis	551-553	Economobile.....	580	Pettibone	600-602
International.....	553-554	Fabtek.....	580	Skytrak.....	602-603
Isuzu	554	Genie.....	580-581	Snorkel Lift.....	603
John Deere	554	Gerlinger.....	581-584	Taylor	603
Lister.....	554	Gradall.....	584	TCI	603
Mkt Mfg. Inc.	554	Gradall-Loed.....	584	TCM-Toyo	603
Northern Lights	554	Grove	584	Teco-Crab	604
Onan	554-555	Herculift	584	Towmotor	604-606
P & H	555-556	Hyster	584-589	Toyota	606
Perkins.....	556	Ingersoll-Rand	589	United Tractor	606-607
Sheppard	556	International.....	589	Walden	607
Universal.....	556	JLG	589	White	607
Wisconsin	556	John Deere	589-590	Yale.....	607-610
		Kalamazoo.....	590	Zetor	610
		Kalmar	590-596		
		K-D Manitou.....	596		

Model and Manufacturer Index

Indexes & Abbrev.

Model	Manufacturer	Model	Manufacturer	Model	Manufacturer
1		1 - Continued		1 - Continued	
1-Step-30.....	Ottawa	110.....	Austin-Western	165.....	Dresser-Dressta
10.....	Bay City	110-9.....	Clark-Michigan-VME	165.....	Hino
10-14 Ton.....	Dresser-Galion	110-11.....	Clark-Michigan-VME	166.....	Koehring
10-14 Ton.....	Huber-Warco	110-11B.....	Clark-Michigan-VME	166-15.....	Parsons
10 Ton.....	Huber-Warco	110-15.....	Clark-Michigan-VME	170.....	John Deere
10 Ton.....	Ingram	110 III-H14.....	Clark-Michigan-VME	170B.....	Case
10B.....	Bucyrus-Erie	110HT.....	Clark-Michigan-VME	170RD2.....	Le Roi
10D.....	Huber-Warco	112E (91G).....	Caterpillar	170RD2.....	Wabco
10R.....	Bucyrus-Erie	112F (89J).....	Caterpillar	175.....	Grimmer-Schmidt
11-5400.....	Ingram	115ZIII.....	Kawasaki	175.....	International
11B.....	Fiat-Allis	118.....	Dresser-Galion	175A.....	Clark-Michigan-VME
11D.....	Huber-Warco	118C.....	Dresser-Galion	175A.....	Jaeger
12+2.....	Case	120 (10R).....	Caterpillar	175A III.....	Clark-Michigan-VME
12B.....	Clark-Michigan-VME	120 (13U).....	Caterpillar	175B.....	Clark-Michigan-VME
12BR Control.....	Clark-Michigan-VME	120 (14K).....	Caterpillar	175B.....	Dresser-Dressta
12E (99E).....	Caterpillar	120 (89G).....	Caterpillar	175B.....	International
12F (13K).....	Caterpillar	120G (87V).....	Caterpillar	175C.....	Clark-Michigan-VME
12F (73G).....	Caterpillar	122.....	Austin-Western	175C.....	Dresser-Dressta
12F (89H).....	Caterpillar	125.....	Dresser-Galion	175C.....	International
12G (61M).....	Caterpillar	125.....	Jaeger	175CTA62.....	Cummins
12RH.....	Gerlinger	125.....	John Deere	175DFBD.....	Onan
12RT.....	Euclid	125.....	Smith Co.	175DGFA.....	Onan
13C.....	Sheppard	125A.....	Dresser-Galion	175RG1.....	Chicago Pneumatic
13D.....	Sheppard	125A I.....	Clark-Michigan-VME	180.....	Bay City
13E.....	Sheppard	125A II.....	Clark-Michigan-VME	180.....	Clark-Michigan-VME
13F.....	Sheppard	125A III.....	Clark-Michigan-VME	180.....	International
14.....	Sheppard	125B.....	Case	180.....	Jaeger
14-20 Ton.....	Dresser-Galion	125B.....	Clark-Michigan-VME	180 I.....	Clark-Michigan-VME
14B (64C).....	Caterpillar	125C.....	Clark-Michigan-VME	180 I.....	Volvo
14C.....	Sheppard	125C.....	Dresser-Dressta	180 II.....	Volvo
14C-VD.....	Hydra-Mac	125C.....	International	180 III.....	Clark-Michigan-VME
14D (96F).....	Caterpillar	125E.....	Dresser-Dressta	185.....	Bay City
14E (12K).....	Caterpillar	125G.....	Dresser-Dressta	185.....	Hino
14E (72G).....	Caterpillar	125RG2.....	Chicago Pneumatic	185.....	Ingersoll
14E (99G).....	Caterpillar	125RO2.....	Chicago Pneumatic	185.....	Sullair
14G (96U).....	Caterpillar	130G (74V).....	Caterpillar	187C.....	P & H
14YD.....	Herc	135HLD.....	Champ	190 4.....	Dynahoe
15.....	Bay City	140.....	Dynahoe	190-T52.....	Bay City
15.....	John Deere	140.....	International	190-T6430.....	Bay City
15-15.....	Namco	140 (11R).....	Caterpillar	195 Road Widener.....	Blaw-Knox
15 (4W).....	Caterpillar	140 (14U).....	Caterpillar	198.....	Hino
15A.....	Bay City	140 (24R).....	Caterpillar	1000A Travelift.....	Drott
15B.....	Bucyrus-Erie	140G (13W).....	Caterpillar	1000AI Travelift.....	Drott
15RH.....	Gerlinger	140G (72V).....	Caterpillar	1001.....	Transcold
15T-MC.....	Thew Shovel	145.....	Allis-Chalmers	1003.....	Transcold
16.....	Sheppard	145.....	Hino	1010C.....	John Deere
16 (49G).....	Caterpillar	145T.....	Allis-Chalmers	1025SK.....	Ditch Witch
16B.....	Fiat-Allis	150.....	Dresser-Dressta	1055.....	P & H
16TDT.....	Euclid	150.....	Dresser-Galion	1085C.....	Badger
17.....	Sheppard	150.....	P & H	1088.....	Case
17A.....	Sheppard	150.....	Sullair	1103.....	Vibromax
19.....	Sheppard	150 Crawler.....	International	1150B Crawler.....	Case
19B.....	Bucyrus-Erie	150A.....	Dresser-Galion	1150E.....	Case
100.....	Champ	150C.....	Fiat-Allis	1150G Crawler.....	Case
100.....	Pettibone	150CTA61.....	Cummins	1155E.....	Case
100 Hauler.....	International	150DGFA.....	Onan	1170.....	Caterpillar
100B.....	International	150F.....	Dresser-Galion	1200.....	Owatonna
100BT62.....	Cummins	150FA.....	Dresser-Galion	1200 Series.....	Brown
100C.....	Dresser-Dressta	150RG1.....	Wabco	1280.....	Case
100C.....	Fiat-Allis	150TC.....	P & H	1280B.....	Case
100E.....	Dresser-Dressta	151-T41.....	Bay City	1500.....	Drott
100E.....	International	160.....	Dresser-Galion	1550.....	Case
100FLW.....	Pettibone	160.....	Dynahoe	1550B.....	JCB
100G.....	Dresser-Dressta	160.....	Jaeger	1652 SC.....	International/Navistar
100H.....	Waldon	160.....	Poclair	1670.....	Caterpillar
101F.....	Wabco	160H.....	Caterpillar	1673 (1L).....	Caterpillar
102.....	Austin-Western	160RF2.....	Dresser-Galion	1673 (69D).....	Caterpillar
104.....	Dresser-Galion	161.....	Fiat-Allis	1673 (70B).....	Caterpillar
105.....	Jaeger	161.....	Transcold	1673B (1L).....	Caterpillar

Model and Manufacturer Index

Model	Manufacturer	Model	Manufacturer	Model	Manufacturer
1 - Continued		2 - Continued		2 - Continued	
1673B (69D).....	Caterpillar	25B.....	Bucyrus-Erie	250.....	Transicold
1673B (70B).....	Caterpillar	25GS4.....	Pettibone	250 Skid Steer.....	John Deere
1673C (1L).....	Caterpillar	28TDT.....	Euclid	250 Travelift.....	Drott
1673C (69D).....	Caterpillar	29.....	Pettibone	250AI Travelift.....	Drott
1673C (70B).....	Caterpillar	200.....	Champ	250B.....	Dresser-Dressta
1676.....	Caterpillar	200.....	Dresser-Dressta	250B.....	International
1680.....	White	200.....	Peterbilt	250C.....	Dresser-Dressta
1693.....	Caterpillar	200.....	Pettibone	250C.....	Ford
1700.....	Owatonna	200.....	Poclair	250C.....	International
1700.....	Trojan-Yale	200.....	Transicold	250C.....	Transicold
1700B.....	JCB	200B.....	Transicold	250CM.....	Transicold
1737.....	Case	200C.....	Fiat-Allis	250D.....	John Deere
1740.....	Case	200DFBD.....	Onan	250DFB6.....	Onan
1740 Wheel Loader.....	Case	200FLW.....	Pettibone	250E.....	Dresser-Dressta
1800.....	Drott	200HL.....	Champ	250FLW.....	Pettibone
1800.....	Ford	200HLD.....	Champ	250NT5.....	Cummins
1816.....	Case	200RF2.....	Dresser-Galion	250RF2.....	Dresser-Galion
1816C.....	Case	200W.....	Pettibone	250RG2.....	Chicago Pneumatic
1818.....	Case	201.....	Transicold	250RO2.....	Chicago Pneumatic
1825.....	Case	202.....	Transicold	250W.....	Pettibone
1825B.....	Case	203.....	Transicold	251.....	Transicold
1835C.....	Case	204.....	Transicold	253.....	Vibromax
1840.....	Case	210.....	Austin-Western	254.....	Transicold
1845.....	Case	210.....	Grimmer-Schmidt	255A.....	Bay City
1845C.....	Case	210.....	Jaeger	255A.....	Koehring
1900.....	Trojan-Yale	210C Backhoe.....	John Deere	255A.....	P & H
10000.....	Allis-Chalmers	210C Wheel Loader.....	John Deere	255ATC.....	P & H
10042.....	Skytrak	210H.....	Clark-Michigan-VME	255L.....	Parsons
11000.....	Allis-Chalmers	210LE.....	John Deere	258ALP.....	Hino
16000.....	Allis-Chalmers	210M.....	Dresser-Dressta	258LP.....	Hino
16000H.....	Allis-Chalmers	210RG2.....	Chicago Pneumatic	260.....	Allis-Chalmers
2		210S.....	JCB	260.....	Transicold
2.....	Barber-Greene	215.....	P & H	260 Skid Steer.....	John Deere
2-36 Romper.....	Raygo	215D (9TF).....	Caterpillar	260A.....	Caterpillar
2-66 Ranger.....	Raygo	220.....	Case	260AE.....	Allis-Chalmers
2-78 Forklift.....	White	220.....	Poclair	260C.....	Ford
2AB.....	Isuzu	220.....	Transicold	260E.....	Allis-Chalmers
2FD.....	Euclid	220B.....	Case	260EA.....	Allis-Chalmers
2FG15.....	Toyota	220B.....	Transicold	261B.....	Fiat-Allis
2FG20.....	Toyota	220DFBE.....	Onan	268.....	Hino
2FG25.....	Toyota	220FF.....	Bedford	270.....	International
2LDT.....	Euclid	220NT5.....	Cummins	270.....	Peterbilt
2SDK7.....	Toyota	220S.....	Dresser-Galion	270.....	Transicold
2SDK8.....	Toyota	221.....	Transicold	270 Skid Steer.....	John Deere
2T551.....	International	222.....	Transicold	275 Articulated.....	Clark-Michigan-VME
20.....	Bay City	222G.....	Wabco	275 III.....	Clark-Michigan-VME
20-15.....	Namco	223.....	Transicold	275A I.....	Clark-Michigan-VME
20-20.....	P & H	224.....	Transicold	275A III.....	Clark-Michigan-VME
20B.....	Bucyrus-Erie	225.....	Bobcat-Melroe	275B.....	Clark-Michigan-VME
20GS4.....	Pettibone	225 (51U).....	Caterpillar	275C.....	Clark-Michigan-VME
20H.....	Bucyrus-Erie	229G.....	Wabco	275DFCB.....	Onan
20H III.....	Bucyrus-Erie	230.....	Transicold	275NTA2.....	Cummins
20R.....	Bucyrus-Erie	230B.....	Transicold	280.....	Clark-Michigan-VME
21H.....	Bucyrus-Erie	230C.....	Transicold	280.....	Volvo
21H IV.....	Bucyrus-Erie	230CM.....	Transicold	280 Articulated.....	Volvo
21LDT.....	Euclid	230CP.....	Transicold	280 I.....	Clark-Michigan-VME
21TD.....	Euclid	230DFBD.....	Onan	280 I.....	Volvo
21TDT.....	Euclid	231.....	Transicold	280 II.....	Volvo
22B.....	Bucyrus-Erie	234.....	Transicold	280 III.....	Clark-Michigan-VME
22BM-2.....	Bucyrus-Erie	235.....	Clark	280 III.....	Volvo
22TD.....	Euclid	235 (64R).....	Caterpillar	280 Skid Steer.....	John Deere
22TDT.....	Euclid	238.....	Hino	280A III.....	Clark-Michigan-VME
24.....	John Deere	240 Skid Steer.....	John Deere	280B.....	Volvo
24TDT.....	Euclid	244J.....	John Deere	280C.....	Volvo
25.....	American Crane Corp.	245 (95V).....	Caterpillar	280CSP.....	Bucyrus-Erie
25.....	Bay City	247.....	Cleveland	287C.....	P & H
25.....	John Deere	250.....	International	295.....	International
25+4XP.....	Case	250.....	Jaeger	295B.....	International
		250.....	Pettibone	2000.....	Bobcat-Melroe

Model and Manufacturer Index

Model	Manufacturer	Model	Manufacturer	Model	Manufacturer
2 - Continued		3 - Continued		3 - Continued	
2000.....	Trojan-Yale	300.....	Smith Co.	340.....	Peterbilt
2005.....	Transcold	300.....	Wabco	344E.....	John Deere
2010 Crawler.....	John Deere	300 Backhoe.....	John Deere	345C.....	Ford
2020.....	Ditch Witch	300 Hydro-Cruiser.....	Warner & Swasey	348.....	Peterbilt
2210.....	Hamm	300 Hydro-Scopic.....	Warner & Swasey	348 (36J).....	Caterpillar
2300.....	Ditch Witch	300 Wheel Loader.....	John Deere	348 (38J).....	Caterpillar
2310.....	Ditch Witch	300A.....	Raygo	350.....	Champ
2500.....	Drott	300B Backhoe.....	John Deere	350.....	International
2500.....	Trojan-Yale	300B Wheel Loader.....	John Deere	350.....	Towmotor
2500 Constructall.....	International	300D.....	John Deere	350 Crawler.....	Case
2500A.....	Kalamazoo	300DFCB.....	Onan	350 Crawler Loader.....	John Deere
2500B.....	Kalamazoo	300FLW.....	Pettibone	350 Crawler Tractor.....	John Deere
2510.....	Drott	300G.....	Pettibone	350C Crawler Loader.....	John Deere
2554.....	International/Navistar	300GT.....	Pettibone	350C Crawler Tractor.....	John Deere
2574.....	International/Navistar	300NTA2.....	Cummins	350DFCC.....	Onan
2654.....	International/Navistar	300P.....	Pettibone	350NTA3.....	Cummins
2674.....	International/Navistar	300TM-C.....	Warner & Swasey	351S.....	Towmotor
2700.....	Nissan	300W.....	Pettibone	352.....	K-D Manitou
21000.....	Allis-Chalmers	301 Backhoe.....	John Deere	355.....	Clark
21000H.....	Allis-Chalmers	301 Wheel Loader.....	John Deere	355.....	K-D Manitou
25000.....	Allis-Chalmers	301A Backhoe.....	John Deere	355PD.....	Clark
25000 Mark II.....	Allis-Chalmers	301A Wheel Loader.....	John Deere	356.....	Clark
3		301S.....	Clark-Michigan-VME	357.....	Peterbilt
3-5 Ton.....	Dresser-Galion	302 Backhoe.....	John Deere	358.....	Hino
3-5 Ton.....	Huber-Warco	302 Wheel Loader.....	John Deere	360.....	Sterling
3FG35.....	Toyota	302A Backhoe.....	John Deere	362.....	Peterbilt
3FGC20.....	Toyota	302A Wheel Loader.....	John Deere	365.....	Jaeger
3FGC25.....	Toyota	303.....	Dresser-Galion	365.....	Peterbilt
3LDT.....	Euclid	304.....	Bantam	365RO2.....	Chicago Pneumatic
3SDK5.....	Toyota	304.....	Koehring	367.....	Peterbilt
3.152.....	Perkins	305.....	Koehring	375.....	John Deere
3.25.....	Nissan	308.....	Hino	375.....	Peterbilt
3.5.....	Nissan	310.....	Clark-Michigan-VME	375A.....	Clark-Michigan-VME
30.....	Bay City	310.....	John Deere	377.....	Peterbilt
30+4.....	Case	310 III.....	Clark-Michigan-VME	378.....	Peterbilt
30DH.....	Drott	310D.....	John Deere	379.....	Peterbilt
30F.....	JLG	310DFCC.....	Onan	380.....	Case
30GA.....	Pettibone	310G.....	John Deere	380.....	John Deere
30GS.....	Pettibone	310NTA3.....	Cummins	380 I.....	Clark-Michigan-VME
30GS4.....	Pettibone	313.....	John Deere	380 I.....	Volvo
30H II.....	Bucyrus-Erie	315.....	Jaeger	380 II.....	Clark-Michigan-VME
30R.....	Gerlinger	315.....	John Deere	380 II.....	Volvo
30RH.....	Gerlinger	315SG.....	John Deere	380 III.....	Clark-Michigan-VME
30S.....	Gerlinger	317 Skid Steer.....	John Deere	380 III.....	Volvo
30SH.....	Gerlinger	319D.....	John Deere	384.....	Peterbilt
30YC.....	Drott	320.....	Peterbilt	385.....	Peterbilt
31TD.....	Euclid	320 Loader Backhoe.....	Case	386.....	Peterbilt
32.....	Bay City	320 Skid Steer.....	John Deere	387.....	Peterbilt
33.....	Bay City	320 Wheel Loader.....	Case	387A.....	P & H
35.....	American Crane Corp.	320A.....	Raygo	387B.....	P & H
35.....	Drott	320B Loader Backhoe.....	Case	387C.....	P & H
35.....	Terex	320B Wheel Loader.....	Case	387H.....	P & H
35.....	Wabco	323D.....	John Deere	388.....	Peterbilt
35A.....	Clark-Michigan-VME	325 Skid Steer.....	John Deere	389.....	Peterbilt
35AWS.....	Clark-Michigan-VME	328 Skid Steer.....	John Deere	390.....	Towmotor
35B.....	Clark-Michigan-VME	329D.....	John Deere	391.....	Towmotor
35C.....	Wabco	330.....	International	391S.....	Towmotor
35D.....	Drott	330.....	Peterbilt	392S.....	Towmotor
35E.....	Terex	330FF.....	Bedford	3000.....	Nissan
35EC.....	Drott	330H.....	Wabco	3000.....	Trojan-Yale
36.....	Pettibone	331.....	Bobcat-Melroe	3023.....	Bobcat-Melroe
37.....	Bay City	332 Skid Steer.....	John Deere	3145 (65P).....	Caterpillar
37B.....	Bucyrus-Erie	333D.....	John Deere	3150 (97M).....	Caterpillar
38B.....	Bucyrus-Erie	335.....	Bobcat-Melroe	3208 (79V).....	Caterpillar
38D.....	Barber-Greene	335.....	Peterbilt	3304 (2B).....	Caterpillar
38TC.....	Bucyrus-Erie	337.....	Peterbilt	3304 (66D).....	Caterpillar
300.....	Champ	338.....	Hino	3305.....	Terex
300.....	Pettibone	340.....	Ford	3306 (2B).....	Caterpillar
		340.....	International	3306 (66D).....	Caterpillar

Model and Manufacturer Index

Model	Manufacturer	Model	Manufacturer	Model	Manufacturer
3 - Continued		4 - Continued		4 - Continued	
3307.....	Terex	45.....	Bay City	440C Skidder.....	John Deere
3309.....	Terex	45.....	Clark-Michigan-VME	441.....	Towmotor
3315.....	Terex	45A.....	Clark-Michigan-VME	442.....	International
3375.....	John Deere	45B.....	Clark-Michigan-VME	442B.....	International
3400A.....	International	45BP.....	Clark-Michigan-VME	444.....	International
3406 (90V).....	Caterpillar	45C.....	Clark-Michigan-VME	444B.....	International
3408 (67U).....	Caterpillar	45CIIB100.....	Bucyrus-Erie	444C.....	John Deere
3412 (38S).....	Caterpillar	45R.....	Bucyrus-Erie	444E.....	John Deere
3412 Generator.....	Caterpillar	46.....	Ferguson Shovel Supply	445.....	Owatonna
3444.....	International	400.....	Pettibone	445 Skid Steer.....	Case
3500.....	Ditch Witch	400.....	Wabco	445C Backhoe.....	Ford
3500.....	Nissan	400 Backhoe.....	John Deere	445C Wheel.....	Ford
3514.....	International	400 Wheel Loader.....	John Deere	450.....	Bay City
3600.....	International	400G.....	Pettibone	450.....	Gardner-Denver
3600A.....	International	400GT.....	Pettibone	450 Crawler.....	Case
3600A.....	Kalamazoo	400P.....	Pettibone	450 Crawler Loader.....	John Deere
3616.....	International	400P.....	Towmotor	450 Crawler Tractor.....	John Deere
3700 Series.....	Western Star	401 Backhoe.....	John Deere	450 Skid Steer.....	Case
3800.....	International	401 Wheel Loader.....	John Deere	450B Crawler.....	Case
3800 Series.....	Western Star	401B.....	John Deere	450B Crawler Tractor.....	John Deere
3820.....	International	401B Backhoe.....	John Deere	450C.....	Case
3820A.....	International	401C Backhoe.....	John Deere	450C Crawler Loader.....	John Deere
3850.....	International	401C Wheel Loader.....	John Deere	450C Crawler Tractor.....	John Deere
3964.....	International	402.....	Pettibone	452.....	K-D Manitou
3984.....	International	402C.....	Pettibone	455A.....	P & H
4		403.....	Pettibone	455C.....	Case
4-6 TON.....	Dresser-Galion	404.....	Pettibone	455G.....	John Deere
4-6 TON.....	Huber-Warco	405-2A.....	Koehring	460.....	Allis-Chalmers
4-78 Forklift.....	White	406.....	JCB	460.....	Towmotor
4.0.....	Nissan	406.....	Unimog	460B.....	Allis-Chalmers
4B153.....	Allis-Chalmers	410.....	Austin-Western	460C.....	Allis-Chalmers
4B182.....	Allis-Chalmers	410.....	John Deere	461.....	Towmotor
4BD153.....	Allis-Chalmers	410.....	Towmotor	462S.....	Towmotor
4BD182.....	Allis-Chalmers	410 Skid Steer.....	Case	465 Skid Steer.....	Case
4DA153.....	Allis-Chalmers	410B.....	John Deere	475 Articulated.....	Clark-Michigan-VME
4DA182.....	Allis-Chalmers	410C.....	John Deere	475A III.....	Clark-Michigan-VME
4DC645.....	Allis-Chalmers	410D.....	John Deere	475B.....	Clark-Michigan-VME
4FD.....	Euclid	410G.....	John Deere	480.....	Case
4FGC20.....	Toyota	411.....	Towmotor	480.....	Clark-Michigan-VME
4L.....	Gerlinger	412.....	International	480.....	John Deere
4MH.....	Gerlinger	412B.....	Dresser-Dressta	480 I.....	Volvo
4MO645.....	Allis-Chalmers	414E.....	Caterpillar	480A.....	John Deere
4N.....	Gerlinger	414MC.....	Thew Shovel	480B.....	Case
4.192.....	Perkins	416 (5PC).....	Caterpillar	480B.....	John Deere
4.203.....	Perkins	420.....	Ford	480CK.....	Case
4.270D.....	Perkins	420.....	Towmotor	480D.....	Case
4.99.....	Perkins	420 Skid Steer.....	Case	480E.....	Case
40.....	Austin-Western	421.....	Towmotor	480ELL.....	Case
40.....	Pettibone	422S.....	Towmotor	480F.....	Case
40-0.....	JLG	424.....	Bantam	480FLL.....	Case
40-45.....	JLG	425.....	Bay City	480G.....	John Deere
40 Crawler.....	Drott	425.....	Bobcat-Melroe	480P.....	Towmotor
40 Cruz-Air.....	Drott	428.....	Koehring	482C.....	John Deere
40C.....	Drott	430.....	Bobcat-Melroe	487C.....	P & H
40F.....	JLG	430 Scatback.....	Case	487H.....	P & H
40GA.....	Pettibone	430 Skid Steer.....	Case	490D.....	John Deere
40GS.....	Pettibone	430CK Loader Backhoe.....	Case	495.....	International
40R.....	Drott	430H.....	Bobcat-Melroe	4000.....	Dresser-Dressta
40R.....	Gerlinger	431.....	International	4000.....	Nissan
40RH.....	Gerlinger	431B.....	International	4000.....	Pumpmaster
40S.....	Gerlinger	433.....	International	4000.....	Trojan-Yale
40SH.....	Gerlinger	433B.....	International	4010.....	Ditch Witch
40XT.....	Case	435 Skid Steer.....	Case	4030.....	Skytrak
40YR.....	Drott	440.....	Bay City	4039D.....	John Deere
41B.....	Fiat-Allis	440.....	Towmotor	4040.....	Ford
44.....	Barber-Greene	440.....	Wabco	4066.....	Terex
44HL.....	Champ	440 Skid Steer.....	Case	4100.....	International/Navistar
45.....	Allis-Chalmers	440 Skidder.....	John Deere	4100.....	Walden
		440B Skidder.....	John Deere	4100.....	Waldon

Model and Manufacturer Index

Model	Manufacturer	Model	Manufacturer	Model	Manufacturer
4 - Continued		5 - Continued		5 - Continued	
4200.....	International/Navistar	502C.....	Pettibone	561C (85H) Pipelayer.....	Caterpillar
4300.....	International/Navistar	502P.....	Towmotor	570.....	Dresser-Dressta
4400.....	International/Navistar	502S.....	Towmotor	570.....	Dresser-Hough
4420G.....	Grove	503A.....	Dresser-Galion	570.....	John Deere
4475.....	John Deere	503L.....	Dresser-Galion	570A.....	John Deere
4500A.....	Dresser-Dressta	510.....	Allis-Chalmers	571E PS (64A) Pipelayer...	Caterpillar
4500B.....	Dresser-Dressta	510.....	Allis-Chalmers	571F (95N) Pipelayer.....	Caterpillar
4700.....	International/Navistar	510.....	John Deere	571G (16W) Pipelayer.....	Caterpillar
4800.....	International/Navistar	510B.....	Dresser-Dressta	572C (21A) Pipelayer.....	Caterpillar
4800 Series.....	Western Star	510B.....	Dresser-Hough	572D (21A) Pipelayer.....	Caterpillar
4900.....	International/Navistar	510B.....	John Deere	572E (65A) Pipelayer.....	Caterpillar
4900 Series.....	Western Star	510C.....	Dresser-Dressta	572F PS (96N) Pipelayer...	Caterpillar
4900EX.....	Western Star	510C.....	Dresser-Hough	572G Pipelayer.....	Caterpillar
4900FA.....	Western Star	510P.....	Towmotor	579.....	Peterbilt
4900SA.....	Western Star	512.....	Allis-Chalmers	580.....	Case
5		515.....	Dresser-Hough	580.....	Dresser-Hough
5-6 Ton.....	Huber-Warco	515B.....	Dresser-Dressta	580B.....	Case
5-8 Ton.....	Dresser-Galion	515B.....	Dresser-Hough	580BCK.....	Case
5-8 Ton.....	Huber-Warco	520B.....	Dresser-Dressta	580C.....	Case
5-8A.....	Ferguson Shovel Supply	520B.....	Dresser-Hough	580CK.....	Case
5 KW.....	Universal	524K.....	John Deere	580CK Forklift.....	Case
5 Ton.....	Dresser-Galion	530.....	Dresser-Dressta	580D.....	Case
5 Ton.....	Huber-Warco	530.....	Dresser-Hough	580E.....	Case
5FD.....	Euclid	530CK.....	Case	580K.....	Case
5GO.....	Onan	534.....	Gradall-Loed	583H (61A) Pipelayer.....	Caterpillar
5LDT.....	Euclid	534B.....	Gradall	584.....	Case
5N1.....	Long	535.....	Bay City	584C.....	Case
50.....	Drott	540.....	Dresser-Dressta	584D.....	Case
50.....	Hyster	540.....	Dresser-Hough	584E.....	Case
50BEC.....	Drott	540.....	John Deere	585.....	Case
50GA.....	Pettibone	540.....	Towmotor	585C.....	Case
50GS.....	Pettibone	540A.....	John Deere	585D.....	Case
50J.....	Thew Shovel	540B.....	John Deere	585E.....	Case
50K.....	Thew Shovel	540D.....	John Deere	586.....	Case
51B.....	Bucyrus-Erie	542.....	Gradall-Loed	586C.....	Case
54B.....	Bucyrus-Erie	544 Skidder.....	John Deere	586D.....	Case
55.....	Austin-Western	544 Wheel Loader.....	John Deere	586E.....	Case
55.....	Clark-Michigan-VME	544B Skidder.....	John Deere	587.....	Peterbilt
55.....	International	544B Wheel Loader.....	John Deere	590.....	Towmotor
55 III.....	Clark-Michigan-VME	544C.....	John Deere	590S.....	Towmotor
55A I.....	Clark-Michigan-VME	544E.....	John Deere	594 (62H) Pipelayer.....	Caterpillar
55A II.....	Clark-Michigan-VME	544G.....	John Deere	597C.....	American Crane Corp.
55A III.....	Clark-Michigan-VME	545.....	Allis-Chalmers	5000.....	International/Navistar
55B.....	Clark-Michigan-VME	545.....	Mustang	5000.....	Nissan
55C.....	Clark-Michigan-VME	545.....	Owatonna	5000.....	Walden
500.....	Pettibone	545C.....	Ford	5000.....	Waldon
500.....	Towmotor	545C Backhoe.....	Ford	5010.....	Ditch Witch
500.....	Wabco	545D Backhoe.....	Ford	5010 Scraper.....	John Deere
500 Backhoe.....	John Deere	545D Wheel.....	Ford	5028.....	Skytrak
500 Travelift.....	Case	545H.....	Allis-Chalmers	5028HT.....	Skytrak
500 Wheel Loader.....	John Deere	550.....	Case	5100.....	Walden
500 Wheel Tractor.....	John Deere	550.....	Dresser-Dressta	5100.....	Waldon
500A Travelift.....	Drott	550.....	Dresser-Hough	5500i.....	International/Navistar
500AI Travelift.....	Drott	550.....	Ford	5530.....	American Crane Corp.
500B Travelift.....	Case	552.....	Barber-Greene	5575.....	John Deere
500C.....	Dresser-Dressta	552.....	Gradall-Loed	5600G.....	Advance Sweeper
500C Backhoe.....	John Deere	554.....	Gradall-Loed	5600i.....	International/Navistar
500E.....	Dresser-Dressta	555.....	Dresser-Dressta	5800 Series.....	Western Star
500G.....	Pettibone	555.....	Dresser-Hough	5900 Series.....	Western Star
500GT.....	Pettibone	555.....	John Deere	5900i.....	International/Navistar
500H.....	Bucyrus-Erie	555.....	Wabco	6	
500P.....	Pettibone	555C.....	Ford	6-33.....	Pettibone
500P.....	Towmotor	560.....	Allis-Chalmers	6B230.....	Allis-Chalmers
500TC.....	Clark-Lima	560.....	Champion	6B273.....	Allis-Chalmers
501.....	Towmotor	560.....	Dresser-Dressta	6BD230.....	Allis-Chalmers
501P.....	Towmotor	560.....	Dresser-Hough	6BD273.....	Allis-Chalmers
501S.....	Clark-Michigan-VME	560B.....	Dresser-Dressta	6C.....	Sheppard
502.....	Pettibone	560B.....	Dresser-Hough	6CTA 8.3 L GST.....	Cummins
		561B (62A) Pipelayer.....	Caterpillar		

Model and Manufacturer Index

Model	Manufacturer	Model	Manufacturer	Model	Manufacturer
6 - Continued		6 - Continued		6 - Continued	
6D.....	Sheppard	610-T8445.....	Bay City	645.....	Allis-Chalmers
6D2.....	Huber-Warco	613.....	Caterpillar	645.....	Dresser-Dressta
6DA230.....	Allis-Chalmers	613A (71M).....	Caterpillar	645.....	Transcold
6DA273.....	Allis-Chalmers	613B (38W).....	Caterpillar	645B.....	Allis-Chalmers
6DA779.....	Allis-Chalmers	613C.....	Caterpillar	645B.....	Fiat-Allis
6DA844.....	Allis-Chalmers	613C (92X).....	Caterpillar	645C.....	John Deere
6DA970.....	Allis-Chalmers	614.....	Allis-Chalmers	650.....	Case
6DAS510.....	Allis-Chalmers	615 (46Z).....	Caterpillar	650.....	Transcold
6DAS516.....	Allis-Chalmers	615 Backhoe.....	Allis-Chalmers	650A Travelift.....	Drott
6DAS844.....	Allis-Chalmers	615 Wheel Loader.....	Allis-Chalmers	650G Crawler.....	Case
6DC844.....	Allis-Chalmers	619C (61F).....	Caterpillar	651 (33G).....	Caterpillar
6DC970.....	Allis-Chalmers	620.....	Economobile	651 (44M).....	Caterpillar
6DCB879.....	Allis-Chalmers	620B.....	Economobile	651B (67K).....	Caterpillar
6DCS844.....	Allis-Chalmers	620KTA31.....	Cummins	655.....	Transcold
6DCS1879.....	Allis-Chalmers	620.750DFJA.....	Onan	655A.....	P & H
6DH691.....	Allis-Chalmers	621.....	Allis-Chalmers	655B.....	P & H
6DH909.....	Allis-Chalmers	621.....	Case	655D.....	Ford
6DT389.....	Allis-Chalmers	621 (23H).....	Caterpillar	657 (19G).....	Caterpillar
6DT488.....	Allis-Chalmers	621B.....	Case	657 (31G).....	Caterpillar
6DTS468.....	Allis-Chalmers	621B (45P).....	Caterpillar	657 (46M).....	Caterpillar
6E.....	Sheppard	623 (52U).....	Caterpillar	657B (47M).....	Caterpillar
6F.....	Sheppard	623B (46P).....	Caterpillar	657B (68K).....	Caterpillar
6GO.....	Onan	623E (5SG).....	Caterpillar	657E (86Z).....	Caterpillar
6MO672.....	Allis-Chalmers	623E (6CB).....	Caterpillar	660.....	Transcold
6MO779.....	Allis-Chalmers	623E (6DB).....	Caterpillar	660B (58K).....	Caterpillar
6MO893.....	Allis-Chalmers	623E (6YF).....	Caterpillar	660DFJB.....	Onan
6MO970.....	Allis-Chalmers	624E.....	John Deere	660KTA32.....	Cummins
6.305.....	Perkins	624G.....	John Deere	662.....	Clark-Michigan-VME
6.354.....	Perkins	624GH.....	John Deere	664.....	Clark-Michigan-VME
60.....	Austin-Western	624H.....	John Deere	664B.....	Clark-Michigan-VME
60.....	Bay City	627 (54K).....	Caterpillar	664C.....	Clark-Michigan-VME
60.....	Hyster	627 (68M).....	Caterpillar	666.....	Clark-Michigan-VME
60.....	Jaeger	627B (14S).....	Caterpillar	666.....	Le Tourneau
60AS.....	Gerlinger	627B (15S).....	Caterpillar	666.....	Wabco
60AV.....	Gerlinger	627B (38V).....	Caterpillar	666 (77F).....	Caterpillar
60BR.....	JLG	630.....	Dresser-Dressta	666 Power Flow.....	Wabco
60L.....	Bucyrus-Erie	630B (14G).....	Caterpillar	666B.....	Clark-Michigan-VME
60XT.....	Case	630W.....	Dresser-Dressta	666B.....	Wabco
62.....	Bay City	631B (13G).....	Caterpillar	666B (66K).....	Caterpillar
63.....	Bay City	632 (14G).....	Caterpillar	666C.....	Clark-Michigan-VME
64-18.....	Grove	633.....	Caterpillar	666C.....	Wabco
65.....	Fiat-Allis	633 (44J).....	Caterpillar	666D.....	Koehring
65.....	International	633C (66M).....	Caterpillar	670.....	Towmotor
65B.....	Fiat-Allis	635.....	Dresser-Dressta	670.....	Transcold
65BT61.....	Cummins	635B.....	Dresser-Dressta	670 Grader.....	John Deere
65C.....	International	635E.....	Dresser-Dressta	670A.....	John Deere
66.....	Austin-Western	635W.....	Dresser-Dressta	672B.....	John Deere
66 (4D).....	Caterpillar	637 (79P).....	Caterpillar	675.....	Clark-Michigan-VME
68.....	Grove	637D (23W).....	Caterpillar	675.....	John Deere
600.....	Allis-Chalmers	637D (27W).....	Caterpillar	675B.....	John Deere
600.....	Bay City	640.....	Dresser-Dressta	680C.....	Case
600.....	Champ	640.....	Economobile	680E.....	Case
600.....	Champion	640.....	John Deere	680G.....	Case
600.....	Jaeger	640.....	Transcold	680H.....	Case
600.....	Towmotor	641.....	Bobcat-Melroe	680L.....	Case
600 Backhoe.....	John Deere	641 (41M).....	Caterpillar	680P.....	Towmotor
600 Skid Steer.....	Case	641 (50G).....	Caterpillar	685.....	Clark
600 Wheel Loader.....	John Deere	641 (64F).....	Caterpillar	687B.....	P & H
600A Travelift.....	Drott	641 (70G).....	Caterpillar	687C.....	P & H
600GTC.....	Pettibone	641 (80F).....	Caterpillar	687H.....	P & H
600GTF.....	Pettibone	641B (65K).....	Caterpillar	688.....	Case
600RO2.....	Chicago Pneumatic	642.....	Bobcat-Melroe	690.....	John Deere
600WD.....	Koehring	642B.....	Bobcat-Melroe	690A.....	John Deere
601P.....	Towmotor	643.....	Bobcat-Melroe	690B.....	John Deere
602.....	Vibromax	644 Wheel Loader.....	John Deere	690DLC.....	John Deere
605B.....	Fiat-Allis	644B Wheel Loader.....	John Deere	695.....	Hyhoe
610 Super Skytrak.....	Skytrak	644C Wheel Loader.....	John Deere	6000.....	Nissan
610B.....	John Deere	644EH.....	John Deere	6000.....	Trojan-Yale
610-T6435.....	Bay City	644J.....	John Deere	6000.....	Walden

Model and Manufacturer Index

Indexes & Abbrev.

Model	Manufacturer	Model	Manufacturer	Model	Manufacturer
6 - Continued		7 - Continued		8	
6000.....	Waldon	712.....	Dresser-Galion	8.....	Sheppard
6000A.....	Transcold	714.....	Austin-Western	8-10 Ton.....	Dresser-Galion
6000W.....	ICC	714.....	Dresser-Galion	8-10 Ton.....	Huber-Warco
6004A.....	Transcold	715 Backhoe.....	Allis-Chalmers	8-12 Ton.....	Dresser-Galion
6007.....	Transcold	715 Wheel Loader.....	Allis-Chalmers	8-12 Ton.....	Ferguson Shovel Supply
6007A.....	Transcold	715D.....	Allis-Chalmers	8-12 Ton.....	Huber-Warco
6008.....	Transcold	720.....	Austin-Western	8-33.....	Pettibone
6008A.....	Transcold	720.....	Bay City	8DA1125.....	Allis-Chalmers
6036.....	Skytrak	720.....	Clark-Lima	8DA1290.....	Allis-Chalmers
6200LC.....	Dresser-Dressta	720A.....	Champion	8DAS1125.....	Allis-Chalmers
6220LC.....	Dresser-Dressta	721D.....	Case	8DAS1290.....	Allis-Chalmers
6300.....	Versa	724J.....	John Deere	8DC1125.....	Allis-Chalmers
6500.....	Ford	730A.....	Champion	8DC1290.....	Allis-Chalmers
6619A.....	John Deere	740.....	John Deere	8DCS1125.....	Allis-Chalmers
6620.....	Koehring	742.....	Bobcat-Melroe	8DCS1290.....	Allis-Chalmers
6675.....	John Deere	743.....	Bobcat-Melroe	8DCS2505.....	Allis-Chalmers
6900XD.....	Western Star	743B.....	Bobcat-Melroe	8MO1290.....	Allis-Chalmers
7		744E.....	John Deere	8MOS1290.....	Allis-Chalmers
7D.....	Sheppard	745.....	Allis-Chalmers	8N.....	Ford
7D2.....	Huber-Warco	745B.....	Fiat-Allis	8PC2505.....	Allis-Chalmers
7E.....	Sheppard	745HB.....	Fiat-Allis	80.....	Dresser-Galion
70 (8C).....	Caterpillar	747.....	TCI	80.....	Hyster
70XT.....	Case	750.....	Ford	80 (5W).....	Caterpillar
71B.....	Bucyrus-Erie	750KTA31.....	Cummins	80 Cruz-Air.....	Drott
72.....	Bay City	750S.....	Towmotor	80BT61.....	Cummins
72-20.....	Terex	753.....	Bobcat-Melroe	80D.....	Lift All
72-21.....	Terex	755.....	Ford	82-30.....	Terex
72-31.....	Terex	755D.....	John Deere	82-40.....	Terex
72-31B.....	Terex	760.....	Case	82-40 Crawler.....	Euclid
72-40.....	Terex	760.....	John Deere	82A.....	Barber-Greene
72-41.....	Terex	760A.....	John Deere	82AG.....	Barber-Greene
72-51.....	Terex	762 Scaper.....	John Deere	83.....	Austin-Western
72-51B.....	Terex	762A.....	John Deere	84.....	John Deere
72-61.....	Terex	763H.....	Bobcat-Melroe	85.....	Sullair
72-71.....	Terex	764HSD Dozer.....	John Deere	85A.....	Jaeger
72-81.....	Terex	768C (02X).....	Caterpillar	85A I.....	Clark-Michigan-VME
75.....	Clark-Michigan-VME	769 (99F).....	Caterpillar	85A II.....	Clark-Michigan-VME
75.....	International	770 Grader.....	John Deere	85A III.....	Clark-Michigan-VME
75.....	Jaeger	770B.....	John Deere	85B.....	Jaeger
75.....	Parsons	770BH.....	John Deere	85BT61.....	Cummins
75 III.....	Clark-Michigan-VME	772A.....	John Deere	85C.....	Clark-Michigan-VME
75A.....	Jaeger	772AH.....	John Deere	85RGH1.....	Chicago Pneumatic
75A II.....	Clark-Michigan-VME	773 (63G).....	Caterpillar	85RM2.....	Dresser-Galion
75A III.....	Clark-Michigan-VME	774.....	Barber-Greene	85XT.....	Case
75B.....	Clark-Michigan-VME	777.....	Barber-Greene	88B.....	Bucyrus-Erie
75B.....	Jaeger	777.....	Massey Ferguson	800 Skid Steer.....	Case
75C.....	Clark-Michigan-VME	777.....	Wabco	800AC Travelift.....	Drott
75XT.....	Case	777 Power Flow.....	Wabco	800DFJB.....	Onan
77.....	Austin-Western	777B.....	Wabco	800DFJC.....	Onan
77 (4D).....	Caterpillar	780.....	Case	800KTA32.....	Cummins
700.....	Champ	780B.....	Case	800KTA33.....	Cummins
700GTC.....	Pettibone	780C.....	Case	814 (90P).....	Caterpillar
700TC.....	Clark-Lima	780D.....	Case	815 (91P).....	Caterpillar
703SC.....	Clark-Lima	790D.....	John Deere	815T.....	Toyota
705.....	Barber-Greene	7000.....	Dresser-Dressta	816 (57U).....	Caterpillar
705C.....	Allis-Chalmers	7300.....	International/Navistar	816 Backhoe.....	Allis-Chalmers
705D.....	Allis-Chalmers	7400.....	International/Navistar	816 Wheel Loader.....	Allis-Chalmers
706.....	Allis-Chalmers	7500.....	Ford	820KS.....	Thew Shovel
706B.....	Allis-Chalmers	7500.....	International/Navistar	820MC.....	Thew Shovel
706C.....	Allis-Chalmers	7500.....	Trojan-Yale	824.....	Caterpillar
706D.....	Allis-Chalmers	7600.....	International/Navistar	824 (29G).....	Caterpillar
708.....	Dresser-Galion	7700.....	International/Navistar	824B.....	Caterpillar
708C.....	Allis-Chalmers	7753.....	Bobcat-Melroe	824B (36H).....	Caterpillar
708D.....	Allis-Chalmers	7760.....	Case	825.....	Case
710.....	Dresser-Galion	7760.....	Drott	825B (43N).....	Caterpillar
710B.....	John Deere	7760.....	Drott	830.....	Dresser-Galion
710C.....	John Deere	7775.....	John Deere	834.....	Caterpillar
710D.....	John Deere			834 (43E).....	Caterpillar
				835.....	Barber-Greene

Model and Manufacturer Index

Indexes
& Abbrev.

Model	Manufacturer	Model	Manufacturer	Model	Manufacturer
8 - Continued		9 - Continued		9 - Continued	
835 (44N).....	Caterpillar	922B (88J).....	Caterpillar	980.....	Case
837.....	Barber-Greene	922B (94A).....	Caterpillar	980 (42H).....	Caterpillar
838.....	Barber-Greene	926 (4NB).....	Caterpillar	980B.....	Case
840 Articulated.....	Allis-Chalmers	926 (4TC).....	Caterpillar	980B (89P).....	Caterpillar
840B Articulated.....	Allis-Chalmers	926 (7TC).....	Caterpillar	980C.....	Caterpillar
843.....	Bobcat-Melroe	926 (8NB).....	Caterpillar	980C (63X).....	Caterpillar
843B.....	Bobcat-Melroe	926 (94Z).....	Caterpillar	983 (38K).....	Caterpillar
844.....	John Deere	926E (94Z).....	Caterpillar	988 (87A).....	Caterpillar
844 Highlander.....	Lull	930 (8CB).....	Caterpillar	988B (50W).....	Caterpillar
845.....	Barber-Greene	930 (17B).....	Caterpillar	990 Excavator.....	John Deere
847.....	Barber-Greene	930 (41K).....	Caterpillar	990TC.....	Drott
848A.....	Barber-Greene	930 (57Z).....	Caterpillar	992 (25K).....	Caterpillar
850.....	Barber-Greene	930 (60G).....	Caterpillar	9000.....	International
850.....	Dresser-Galion	930 (71H).....	Caterpillar	9010.....	Case
850B Crawler.....	Case	930 (73U).....	Caterpillar	9010B.....	Case
850B Crawler Tractor.....	John Deere	930 (79J).....	Caterpillar	9020.....	Case
850D Crawler.....	Case	930G.....	Caterpillar	9020B.....	Case
850G Crawler.....	Case	933C (11A).....	Caterpillar	9030.....	Case
850K Crawler Dozer.....	John Deere	933E (11A).....	Caterpillar	9030B.....	Case
852.....	Barber-Greene	933G (42A).....	Caterpillar	9040.....	Case
853.....	Bobcat-Melroe	936 (2ZB).....	Caterpillar	9040B.....	Case
855.....	P & H	936 (4SB).....	Caterpillar	9050.....	Case
855D.....	Case	936 (5GC).....	Caterpillar	9050B.....	Case
857.....	Barber-Greene	936 (33Z).....	Caterpillar	9060.....	Case
860.....	John Deere	936 (45Z).....	Caterpillar	9060B.....	Case
860A.....	John Deere	936E (33Z).....	Caterpillar	9100.....	International/Navistar
862.....	John Deere	938G.....	Caterpillar	9100i.....	International/Navistar
870.....	Dresser-Galion	940 Articulated.....	Allis-Chalmers	9125TC.....	P & H
880.....	Case	941 (80H).....	Caterpillar	9200.....	International/Navistar
880.....	Owatonna	941B (80H).....	Caterpillar	9200i.....	International/Navistar
880B.....	Case	943 (19Z).....	Caterpillar	9254.....	P & H
880C.....	Case	944 (87J).....	Caterpillar	9300.....	International/Navistar
880D.....	Case	945B.....	Fiat-Allis	9400.....	International/Navistar
888.....	Case	950 (58H).....	Caterpillar	9400i.....	International/Navistar
895.....	Hyhoe	950 (81J).....	Caterpillar	9600.....	International/Navistar
8000-42.....	Teco-Crab	950 (90A).....	Caterpillar	9700.....	International/Navistar
8020.....	Ditch Witch	950B (22Z).....	Caterpillar	9800.....	International/Navistar
8031.05.....	Aggreko	951B (69H).....	Caterpillar	9900.....	International/Navistar
8061.25R.....	Aggreko	951B (79H).....	Caterpillar	9900i.....	International/Navistar
8100.....	International/Navistar	951C (69H).....	Caterpillar	9900ix.....	International/Navistar
8200.....	International/Navistar	951C (86J).....	Caterpillar		
8435G.....	Grove	953 (76Y).....	Caterpillar	A	
8500.....	International/Navistar	955A.....	P & H	A4D.....	Gerlinger
8500.....	Waldon	955C (12A).....	Caterpillar	A10.....	Gerlinger
8600.....	International/Navistar	955E (12A).....	Caterpillar	A10.....	Towmotor
8875.....	John Deere	955H (60A).....	Caterpillar	A12.....	Gerlinger
9		955K (61H).....	Caterpillar	A12.....	Towmotor
9.....	Sheppard	955L (85J).....	Caterpillar	A15.....	Gerlinger
9-2800.....	Ingram	966A (33A).....	Caterpillar	A15.....	Towmotor
9D.....	Huber-Warco	966B (75A).....	Caterpillar	A16.....	Gerlinger
90XT.....	Case	966C (9KC).....	Caterpillar	A16.....	Towmotor
95.....	International	966C (18B).....	Caterpillar	A18.....	Gerlinger
95XT.....	Case	966C (25U).....	Caterpillar	A18.....	Towmotor
99SW.....	Austin-Western	966C (30K).....	Caterpillar	A20.....	Gerlinger
900.....	Jaeger	966C (42J).....	Caterpillar	A20.....	Towmotor
900.....	Sullair	966C (76J).....	Caterpillar	A22.....	Gerlinger
900.....	Towmotor	966C (78G).....	Caterpillar	A22.....	Towmotor
900DFJC.....	Onan	966D (99Y).....	Caterpillar	A24.....	Gerlinger
900KTA33.....	Cummins	970.....	Dresser-Dressta	A24.....	Towmotor
900RO2.....	Chicago Pneumatic	970 Turbo Articulated.....	Dresser-Dressta	A25C.....	Volvo
910 (80U).....	Caterpillar	970C.....	Dresser-Dressta	A42.....	Snorkel Lift
915.....	Clark	973 (66G).....	Caterpillar	A60.....	Snorkel Lift
918.....	Allis-Chalmers	973 (86G).....	Caterpillar	A61.....	Onan
920 (41J).....	Caterpillar	975.....	Bobcat-Melroe	A62.....	Ford
920 (62K).....	Caterpillar	977D (20A).....	Caterpillar	A64.....	Ford
920 (75J).....	Caterpillar	977E (20A).....	Caterpillar	A66.....	Ford
922A (59A).....	Caterpillar	977H (53A).....	Caterpillar	A66A.....	Hyster
922A (63A).....	Caterpillar	977K (11K).....	Caterpillar	A150E Thru A225E.....	Hyster
		977L (11K).....	Caterpillar	A219-89.....	Le Roi

Model and Manufacturer Index

Indexes & Abbrev.

Model	Manufacturer	Model	Manufacturer	Model	Manufacturer
A - Continued		A - Continued		C	
A300	Bobcat-Melroe	AJ	Onan	C	Thermo King
A400E	Dresser-Galion	A-Line	Sterling	C	Wabco
A440	Mercury	AM	Gerlinger	C9A	International
A450E	Dresser-Galion	AMP	Gerlinger	C40	Champ
A452	Mercury	AMZ40	Grove	C40E	Allis-Chalmers
A460	Mercury	AMZ50	Grove	C40X	Allis-Chalmers
A500	Dresser-Galion	AMZ56	Grove	C48	Little Giant
A550	Dresser-Galion	AMZ66	Grove	C50	Kalmar
A560E	Dresser-Galion	AMZ66XT	Grove	C61	Euclid
A600	Dresser-Galion	AP206	Grove	C62	Euclid
A606	Dresser-Galion	Argosy	Freightliner	C63	Freightliner
A930	Mercury	AT	Allis-Chalmers	C64	Euclid
A940	Mercury	AT20	Yale	C65	Euclid
A950	Mercury	AT30X	Yale	C80A	Champion
A960	Mercury	ATB46N	Snorkel Lift	C166	Bantam
AAG	Gardner-Denver	ATD	Allis-Chalmers	C175	New Holland
ACC20	Kalmar	ATM	Allis-Chalmers	C200	Pettibone
ACC20L	Kalmar	ATMD	Allis-Chalmers	C201	Isuzu
ACC25	Kalmar	Autocar	Volvo	C221	Isuzu
ACC25L	Kalmar	Autohailer	Volvo	C240	Isuzu
ACC30	Kalmar	B		C266	Bantam
ACC30L	Kalmar	B	Arctic Traveler	C330A	Hyster
ACC35	Kalmar	B	Mobilift	C330B	Hyster
ACC40	Kalmar	B1	Thermo King	C340A	Hyster
ACC45	Kalmar	B10	Towmotor	C350	Hyster
ACC50	Kalmar	B12	Towmotor	C350A	Hyster
ACC55	Kalmar	B15	Gerlinger	C350AD	Hyster
ACC60	Kalmar	B15	Towmotor	C350D	Hyster
ACC60C	Kalmar	B16	Gerlinger	C366	Bantam
ACC70	Kalmar	B16	Towmotor	C450A	Hyster
ACC80	Kalmar	B17	Gerlinger	C451	Bantam
ACC100	Kalmar	B18	Gerlinger	C475	Bantam
ACP20	Kalmar	B18	Towmotor	C500	Hyster
ACP20L	Kalmar	B19	Gerlinger	C500	Kenworth
ACP25	Kalmar	B20	Gerlinger	C500A	Hyster
ACP25L	Kalmar	B20	Towmotor	C530	Hyster
ACP30	Kalmar	B21	Gerlinger	C530A	Hyster
ACP30L	Kalmar	B22	Gerlinger	C610B	Hyster
ACP30PS	Kalmar	B22	Towmotor	C612B	Hyster
ACP35	Kalmar	B23	Gerlinger	C615A	Hyster
ACP40	Kalmar	B24	Gerlinger	C615B	Hyster
ACP45	Kalmar	B24	Towmotor	C617B	Hyster
ACP50	Kalmar	B25	Towmotor	C624B	Hyster
ACP55	Kalmar	B70	Le Tourneau	C625B	Hyster
ACP60	Kalmar	B80PD	Baker	C627B	Hyster
ACP60D	Kalmar	B125	Allis-Chalmers	C727A	Hyster
ACP60DX	Kalmar	B140PC	Baker	C748A	Hyster
ACP60L	Kalmar	B224	Mobilift	C832A	Hyster
ACP70	Kalmar	Badger Shovel	Austin-Western	C852A	Hyster
ACP70D	Kalmar	BD	Allis-Chalmers	C852B	Hyster
ACP70L	Kalmar	BD2	Allis-Chalmers	C4500	Chevrolet
ACP80	Kalmar	BD3	Allis-Chalmers	C4500	GMC
ACP80D	Kalmar	BF12L 714	Deutz-Allis	C5500	Chevrolet
ACP80DX	Kalmar	BF43	Wabco	C5500	GMC
ACP100	Allis-Chalmers	BFA6	Wabco	C6500	Chevrolet
ACP100	Kalmar	BFA9	Wabco	C6500	GMC
ACP100C	Kalmar	BH700	Vermeer	C7500	Chevrolet
ACP110	Kalmar	BSF2	Cedar Rapids	C7500	GMC
Acterra	Sterling	BSF2H	Cedar Rapids	C8500	Chevrolet
ACX Xpedito	Autocar	BSF3R	Cedar Rapids	C8500	GMC
AD	Allis-Chalmers	BSF4	Cedar Rapids	C-90-B	Cummins
AD3	Allis-Chalmers	BT	Gerlinger	C-90-BI	Cummins
AD4	Allis-Chalmers	Bullet	Sterling	C-90-I	Cummins
AD30	Allis-Chalmers	Business Class M2	Freightliner	C-90-IP	Cummins
AD40	Allis-Chalmers	BW142PD	Bomag	C-105-B	Cummins
AFE1	Wabco	BW161AD	Bomag	C-105-BI	Cummins
AFE5	Wabco	BW210AVA	Bomag	C-105-I	Cummins
AFE6	Wabco	BW213D	Bomag	C-105-IP	Cummins
AG65	CMI			C-140-B	Cummins

Model and Manufacturer Index

Indexes
& Abbrev.

Model	Manufacturer	Model	Manufacturer	Model	Manufacturer
C - Continued		C - Continued		D - Continued	
C-145.....	Cummins	CGS1250.....	Thermo King	D3C.....	Caterpillar
C-160.....	Cummins	CH Series.....	Mack	D3 (79U).....	Caterpillar
C-160-B.....	Cummins	Challenger.....	Arctic Traveler	D3B (27Y).....	Caterpillar
C-160-BI.....	Cummins	Challenger.....	Champ	D4D.....	Caterpillar
C-160-CI.....	Cummins	CHIEF.....	Dresser-Galion	D4E.....	Caterpillar
C-160-IP.....	Cummins	CHN Series.....	Mack	D4 (6U).....	Caterpillar
C-175-B.....	Cummins	CHU Series.....	Mack	D4 (7J).....	Caterpillar
C-175-BI.....	Cummins	CK35-1.....	Komatsu	D4 (7U).....	Caterpillar
C-175-CI.....	Cummins	CL40.....	Ford	D4C (39A).....	Caterpillar
C-175-IP.....	Cummins	CL65.....	Ford	D4C (40A).....	Caterpillar
C-180.....	Cummins	CL Series.....	Mack	D4D (22C).....	Caterpillar
C-180-B.....	Cummins	Clarklift C20B.....	Clark	D4D (78A).....	Caterpillar
C-180-BI.....	Cummins	Clarklift C25B.....	Clark	D4D (82J).....	Caterpillar
C-180-CI.....	Cummins	Clarklift CFY20B.....	Clark	D4D (83J).....	Caterpillar
C-180-IP.....	Cummins	Clarklift CFY25B.....	Clark	D4D LGP (7R).....	Caterpillar
C-190.....	Cummins	Classic.....	Freightliner	D4D LGP (61J).....	Caterpillar
C-464-B160.....	Cummins	Classic XL.....	Freightliner	D4D SA (20J).....	Caterpillar
C-464-C160.....	Cummins	CM.....	Thermo King	D4D SA (84J).....	Caterpillar
C-464-P160.....	Cummins	CM695D.....	Ingersoll	D4E (28X).....	Caterpillar
CA.....	Thermo King	Columbia.....	Freightliner	D4E (29X).....	Caterpillar
CA12PD.....	Dynapac	Commando 30.....	Ottawa	D4E (70X).....	Caterpillar
CA12PDB.....	Dynapac	Commando 30A.....	Ottawa	D4H (8PB).....	Caterpillar
CA15PD.....	Dynapac	Commando 50.....	Ottawa	D4M1.....	Thermo King
CA20.....	Vibro-Plus	Commando 60T.....	Ottawa	D4P60.....	TCI
CA25.....	Vibro-Plus	Condor.....	Freightliner	D4P80.....	TCI
CA25PD.....	Dynapac	Condor.....	Sterling	D4P100.....	TCI
CADET.....	Austin-Western	Coronado.....	Freightliner	D5B.....	Caterpillar
Cary-All Super 8.....	Pettibone	CPS130.....	Chicago Pneumatic	D5 (21J).....	Caterpillar
Cary-Lift 6.....	Pettibone	CPS270.....	Chicago Pneumatic	D5 (81H).....	Caterpillar
Cary-Lift 8.....	Pettibone	CR.....	Le Tourneau	D5 (82H).....	Caterpillar
Cary-Lift 54H.....	Pettibone	CR331.....	Cedar Rapids	D5 (83H).....	Caterpillar
Cary-Lift 150.....	Pettibone	CR461.....	Cedar Rapids	D5 (84H).....	Caterpillar
Cary-Lift 204D.....	Pettibone	CR-160-CI.....	Cummins	D5B LGP (46X).....	Caterpillar
Cary-Lift Super 4.....	Pettibone	CR-D.....	Dresser-Galion	D6.....	Caterpillar
Cary-Lift Super 5.....	Pettibone	Crown 500.....	Thermo King	D6 (8U).....	Caterpillar
Cary-Lift Super 6.....	Pettibone	CS70.....	Clark-Michigan-VME	D6 (9U).....	Caterpillar
Cary-Lift Super 7.....	Pettibone	CS-195.....	Cummins	D6B (37A).....	Caterpillar
Cary-Lift Super 8.....	Pettibone	CS-195-B.....	Cummins	D6B (44A).....	Caterpillar
Cary-Lift Super 10.....	Pettibone	CS-195-CI.....	Cummins	D6C (10K).....	Caterpillar
Cary-Lift Super 15.....	Pettibone	CS-464-B180.....	Cummins	D6C (71A).....	Caterpillar
Cary-Lift Super 20.....	Pettibone	CS-464-C160.....	Cummins	D6C (73A).....	Caterpillar
Cary-Lift Super 25.....	Pettibone	CS-464-C180.....	Cummins	D6C (74A).....	Caterpillar
Cary-Lift Super 30.....	Pettibone	CS-464-C195.....	Cummins	D6C (76A).....	Caterpillar
Cary-Lift Super 40.....	Pettibone	CS-464-P180.....	Cummins	D6C (99J).....	Caterpillar
Cary-Lift Super 60.....	Pettibone	CS Series.....	Mack	D6C LGP (69U).....	Caterpillar
Cary-Lift Super 70.....	Pettibone	CT25.....	Dynapac	D6D (3X).....	Caterpillar
Cascadia.....	Freightliner	CT315.....	John Deere	D6D (4X).....	Caterpillar
CB3 Chore Boy.....	United Tractor	CT-464-B175.....	Cummins	D6D SA (5X).....	Caterpillar
CB40.....	Champ	CT-464-C175.....	Cummins	D6H (3ZF).....	Caterpillar
CB50.....	Champ	CT-464-P175.....	Cummins	D6H (4RC).....	Caterpillar
CB50 Chore Boy.....	United Tractor	CT Series.....	Mack	D7.....	Caterpillar
CB514 (6YD).....	Caterpillar	CTA61.....	Cummins	D7F.....	Caterpillar
CBCI.....	Thermo King	CTA62.....	Cummins	D7G.....	Caterpillar
CB-I.....	Thermo King	CTP Series.....	Mack	D7C (17A).....	Caterpillar
CB-II.....	Thermo King	CV Series.....	Mack	D7D (17A).....	Caterpillar
CB-III.....	Thermo King	CX Series.....	Mack	D7E (47A).....	Caterpillar
CCK.....	Onan	CXN Series.....	Mack	D7E (48A).....	Caterpillar
Centurion.....	Crane Carrier Company	CXP Series.....	Mack	D7E (93N).....	Caterpillar
Century Class.....	Freightliner	CXT.....	International/Navistar	D7F (93N).....	Caterpillar
CF500.....	International/Navistar	CXU Series.....	Mack	D7F (94N).....	Caterpillar
CF600.....	International/Navistar	D		D7G (92V).....	Caterpillar
CF7000.....	Ford	D.....	Barber-Greene	D7H (79Z).....	Caterpillar
CF8000.....	Ford	D1.....	Mobilift	D8.....	Caterpillar
CF-160.....	Cummins	D1 Series.....	Thermo King	D8L.....	Caterpillar
CF-160-B.....	Cummins	D2 (4U).....	Caterpillar	D8 (14A).....	Caterpillar
CFA19.....	Wabco	D2 (5U).....	Caterpillar	D8E (14A).....	Caterpillar
CFA20B.....	Wabco	D2M2.....	Thermo King	D8G (15A).....	Caterpillar
CFT8000.....	Ford	D3 Series.....	Thermo King	D8H (22A).....	Caterpillar
CG.....	Thermo King			D8H (35A).....	Caterpillar

Model and Manufacturer Index

Model	Manufacturer	Model	Manufacturer	Model	Manufacturer
D - Continued		D - Continued		D - Continued	
D8H (36A)	Caterpillar	D230	Allis-Chalmers	D342 (31B)	Caterpillar
D8H (46A)	Caterpillar	D250	Gardner-Denver	D342 (49B)	Caterpillar
D8H (52A)	Caterpillar	D262	Allis-Chalmers	D342 (71B)	Caterpillar
D8H (68A)	Caterpillar	D300	Gardner-Denver	D342C (5A)	Caterpillar
D8K (77V)	Caterpillar	D311	Caterpillar	D342C (31B)	Caterpillar
D8L (53Y)	Caterpillar	D311 (4V)	Caterpillar	D342C (49B)	Caterpillar
D8N (9TC)	Caterpillar	D311 (7S)	Caterpillar	D342C (71B)	Caterpillar
D9	Caterpillar	D311 (51B)	Caterpillar	D343 (33B)	Caterpillar
D9G (66A)	Caterpillar	D315 (4V)	Caterpillar	D343 (62B)	Caterpillar
D9G (90J)	Caterpillar	D315 (9S)	Caterpillar	D344	Allis-Chalmers
D9H (90V)	Caterpillar	D315 (48B)	Caterpillar	D346 (39J)	Caterpillar
D9L (14Y)	Caterpillar	D315 (52B)	Caterpillar	D346 (40J)	Caterpillar
D10A	Komatsu	D315C (4V)	Caterpillar	D346 (77F)	Caterpillar
D20A3	Komatsu	D315C (9S)	Caterpillar	D353 (46B)	Caterpillar
D20P3	Komatsu	D315C (48B)	Caterpillar	D353 (77B)	Caterpillar
D20PL3	Komatsu	D315C (52B)	Caterpillar	D353C (46B)	Caterpillar
D20Q3	Komatsu	D318	Caterpillar	D353C (77B)	Caterpillar
D20S3	Komatsu	D318 (3V)	Caterpillar	D355A	Komatsu
D21A3	Komatsu	D318 (5V)	Caterpillar	D355A1	Komatsu
D21P3	Komatsu	D318 (6V)	Caterpillar	D355A3	Komatsu
D21Q3	Komatsu	D318 (45B)	Caterpillar	D364 (19B)	Caterpillar
D21S3	Komatsu	D318 (53B)	Caterpillar	D364 (21B)	Caterpillar
D30	Allis-Chalmers	D318G (3V)	Caterpillar	D375	Caterpillar
D30A15	Komatsu	D318G (5V)	Caterpillar	D375A	Komatsu
D30P15	Komatsu	D318G (6V)	Caterpillar	D375 (16B)	Caterpillar
D30Q15	Komatsu	D319G (45B)	Caterpillar	D375 (18B)	Caterpillar
D30S15	Komatsu	D319G (53B)	Caterpillar	D375 (43B)	Caterpillar
D31A	Komatsu	D320 (63B)	Caterpillar	D375D (16B)	Caterpillar
D37E2	Komatsu	D326 (25B)	Caterpillar	D375D (18B)	Caterpillar
D40	Allis-Chalmers	D326 (39B)	Caterpillar	D375D (43B)	Caterpillar
D40P1	Komatsu	D326F (25B)	Caterpillar	D379 (68B)	Caterpillar
D45P1	Komatsu	D326F (39B)	Caterpillar	D379 (76B)	Caterpillar
D50A15	Komatsu	D330 (2B)	Caterpillar	D386 (10B)	Caterpillar
D50P15	Komatsu	D330 (4B)	Caterpillar	D386 (12B)	Caterpillar
D50S15	Komatsu	D330 (5B)	Caterpillar	D386 (15B)	Caterpillar
D53A1	Komatsu	D330 (56B)	Caterpillar	D397	Caterpillar
D53S1	Komatsu	D330 (81B)	Caterpillar	D397 (10B)	Caterpillar
D55S	Komatsu	D330 (82B)	Caterpillar	D397 (12B)	Caterpillar
D55S3	Komatsu	D330 (85B)	Caterpillar	D397 (15B)	Caterpillar
D60P	Komatsu	D330A (2B)	Caterpillar	D397D (10B)	Caterpillar
D60A6	Komatsu	D330A (4B)	Caterpillar	D397D (12B)	Caterpillar
D60P6	Komatsu	D330A (5B)	Caterpillar	D397D (15B)	Caterpillar
D60PL6	Komatsu	D330A (56B)	Caterpillar	D398 (66B)	Caterpillar
D65E	Komatsu	D330A (81B)	Caterpillar	D398 (75B)	Caterpillar
D65EX	Komatsu	D330A (82B)	Caterpillar	D399 (91B)	Caterpillar
D65P	Komatsu	D330A (85B)	Caterpillar	D400	Dresser-Dressta
D65S	Komatsu	D333 (23C)	Caterpillar	D400	Dresser-Hough
D65A6	Komatsu	D333 (58B)	Caterpillar	D424	Mobilift
D65E6	Komatsu	D333 (59B)	Caterpillar	D500	Dresser-Dressta
D65S6	Komatsu	D333 (66D)	Caterpillar	D500	Dresser-Hough
D66S1	Komatsu	D333 (67D)	Caterpillar	D516	Allis-Chalmers
D75S	Komatsu	D333 (79B)	Caterpillar	D600B	Dart
D80A	Komatsu	D333 (79C)	Caterpillar	D779	Allis-Chalmers
D85E	Komatsu	D333 (80B)	Caterpillar	D825	Gardner-Denver
D85A12	Komatsu	D333 (87B)	Caterpillar	D844	Allis-Chalmers
D90C	Dresser-Dressta	D333A (23C)	Caterpillar	D1402	Caterpillar
D90C	Dresser-Hough	D333A (58B)	Caterpillar	D1700	Huber-Warco
D95S1	Komatsu	D333A (59B)	Caterpillar	D2551	Dart
D100B	Dresser-Dressta	D333A (66D)	Caterpillar	D2552	Dart
D100B	Dresser-Hough	D333A (67D)	Caterpillar	D2561	Dart
D120C	Dresser-Dressta	D333A (79B)	Caterpillar	D2562	Dart
D120C	Dresser-Hough	D333A (79C)	Caterpillar	D2661	Dart
D125	Gardner-Denver	D333A (80B)	Caterpillar	D2662	Dart
D135A	Komatsu	D333A (87B)	Caterpillar	D3400 (1T)	Caterpillar
D135A2	Komatsu	D334 (92B)	Caterpillar	D3400 (3R)	Caterpillar
D153	Allis-Chalmers	D334 (93B)	Caterpillar	D3400 (3S)	Caterpillar
D155A	Komatsu	D337F (37B)	Caterpillar	D3400 (9J)	Caterpillar
D155A1	Komatsu	D339 (34B)	Caterpillar	D4400 (1S)	Caterpillar
D175	Allis-Chalmers	D342 (5A)	Caterpillar	D4400 (3R)	Caterpillar

Model and Manufacturer Index

Model	Manufacturer	Model	Manufacturer	Model	Manufacturer
D - Continued		F		F - Continued	
D4400 (5S)	Caterpillar	F	Allis-Chalmers	FD	Allis-Chalmers
D4400 (6S)	Caterpillar	F	Mobilift	FD10	Arctic Traveler
D4600 (1S)	Caterpillar	F	Wabco	FD30	Baker
D4600 (3R)	Caterpillar	F1L 310	Deutz-Allis	FD35	TCM-Toyo
D4600 (5S)	Caterpillar	F1L 410	Deutz-Allis	FD40	Baker
D4600 (6S)	Caterpillar	F1L 712	Deutz-Allis	FD60	Baker
D5000	Ingersoll	F1L 714	Deutz-Allis	FD2218	Hino
D6000	ICC	F1L 812	Deutz-Allis	FD2220	Hino
D6000	Ingersoll	F2L 310	Deutz-Allis	FD2320	Hino
D7505	Ingersoll	F2L 410	Deutz-Allis	FDS	Allis-Chalmers
D8800 (3V)	Caterpillar	F2L 514	Deutz-Allis	FDX	Allis-Chalmers
D13000	Caterpillar	F2L 712	Deutz-Allis	FE	Mitsubishi Fuso
D13000 (1N)	Caterpillar	F2L 812	Deutz-Allis	FE2618	Hino
D13000 (2V)	Caterpillar	F2L 812S	Deutz-Allis	FE2620	Hino
D13000 (3R)	Caterpillar	F2L 912	Deutz-Allis	FE Series	Volvo
D13000 (3S)	Caterpillar	F03	Nissan	FF3018	Hino
D13000 (4S)	Caterpillar	F3L 514	Deutz-Allis	FF3020	Hino
D17000	Caterpillar	F3L 712	Deutz-Allis	FG	Mitsubishi Fuso
D17000 (2V)	Caterpillar	F3L 812	Deutz-Allis	FG005	Nissan
D17000 (3S)	Caterpillar	F3L 911	Deutz-Allis	FG10 II	TCM-Toyo
D17000 (8S)	Caterpillar	F3L 912	Deutz-Allis	FG14 II	TCM-Toyo
DA40	Ingersoll	F4L 514	Deutz-Allis	FG15	Komatsu
DA120	Isuzu	F4L 712	Deutz-Allis	FG15	TCM-Toyo
DA220	Isuzu	F4L 812	Deutz-Allis	FG15	Toyota
DA640	Isuzu	F4L 912	Deutz-Allis	FG20	Komatsu
DD6	Elite	F4M 716	Deutz-Allis	FG20	TCM-Toyo
DD8	Elite	F6L 413	Deutz-Allis	FG20	Toyota
DD10	Elite	F6L 514	Deutz-Allis	FG20 III	TCM-Toyo
DE2772	Dart	F6L 712	Deutz-Allis	FG25	Komatsu
DFEB	Onan	F6L 714	Deutz-Allis	FG25	Toyota
DFFA	Onan	F6L 812	Deutz-Allis	FG25N3	TCM-Toyo
DFFB	Onan	F6L 911	Deutz-Allis	FG28	Toyota
DFLB	Onan	F6L 912	Deutz-Allis	FG30	Baker
DFLC	Onan	F6M 716	Deutz-Allis	FG30	Toyota
DFLD	Onan	F8L 413	Deutz-Allis	FG30M	TCM-Toyo
DH4B	Case	F8L 714	Deutz-Allis	FG30ZU	TCM-Toyo
DH5	Case	F8M 716	Deutz-Allis	FG35	Toyota
DH100	Isuzu	F10L 714	Deutz-Allis	FG40	Komatsu
DL6000	ICC	F12M 716	Deutz-Allis	FG40	Toyota
DL7000	ICC	F40	Allis-Chalmers	FG60	Baker
DM Series	Mack	F48	Barber-Greene	FG101	Nissan
DMM Series	Mack	F50	Allis-Chalmers	FG102	Nissan
DPS-90SS	Multiquip	F60	Allis-Chalmers	FG103	Nissan
DPS-180SST	Multiquip	F90	Fresia	FG104	Nissan
DRP	Onan	F235	Clark	FG105	Nissan
DS844	Allis-Chalmers	F450 Super Duty	Ford	FG106	Nissan
DuraStar 4300	International/Navistar	F550 Super Duty	Ford	FG107	Nissan
DuraStar 4400	International/Navistar	F602B	Le Tourneau	FGA030	Baker
DuraStar Hybrid	International/Navistar	F650 Super Duty	Ford	FGA050	Baker
DZB	Onan	F700	Ford	FGA070	Baker
DZC	Onan	F750 Super Duty	Ford	FGC10	Toyota
DZD	Onan	F800	Ford	FGC15	Toyota
E		F802A	Le Tourneau	FGC20	Mitsubishi
E	Mobilift	F804A	Le Tourneau	FGC20	Toyota
E200	International	F1204	Le Tourneau	FGC25	Mitsubishi
E211	International	F1500	Huber-Warco	FGC25	Toyota
E270	International	F Super Duty	Ford	FGD020	Baker
E450 Super Duty	Ford	FA1415	Hino	FGD025	Baker
E550 Super Duty	Ford	FA1517	Hino	FGD030	Baker
EC	Onan	FB2	Thermo King	FGD040	Baker
ED	Onan	FB2-M5	Thermo King	FGD050	Baker
EF	Onan	FB1715	Hino	FGD060	Baker
EL240B (5WG)	Caterpillar	FB1817	Hino	FGD070	Baker
ER	Mobilift	FC	Allis-Chalmers	FGD080	Baker
EUBH	International	FC	Poclair	FGF020	Baker
EW	Mobilift	FC70	Freightliner	FGF025	Baker
		FC80	Freightliner	FGF030	Baker
		FC100	Fresia	FGF040	Baker
		FCG25	TCM-Toyo	FGF050	Baker

Model and Manufacturer Index

Indexes
& Abbrev.

Model	Manufacturer	Model	Manufacturer	Model	Manufacturer
F - Continued		F - Continued		F - Continued	
FGU40	Baker	FMF050	Baker	FTL60 Thru 100	Allis-Chalmers
FGU60	Baker	Forward W4	GMC	FTL70	Allis-Chalmers
FH	Mitsubishi Fuso	Forward W5	GMC	FTL75	Allis-Chalmers
FIA030	Baker	Forward W6	GMC	FTL80	Allis-Chalmers
FIA050	Baker	Forward W7	GMC	FTL100	Allis-Chalmers
FIA070	Baker	FP	Allis-Chalmers	FTLB50	Allis-Chalmers
FID020	Baker	FPD	Allis-Chalmers	FTOH	Allis-Chalmers
FID025	Baker	FPD60	Allis-Chalmers	FTOHL	Allis-Chalmers
FID030	Baker	FPD70	Allis-Chalmers	FTP	Allis-Chalmers
FID040	Baker	FPD80	Allis-Chalmers	FTP20	Allis-Chalmers
FID050	Baker	FPDX	Allis-Chalmers	FTP30	Allis-Chalmers
FID060	Baker	FPDX60	Allis-Chalmers	FTP40	Allis-Chalmers
FID070	Baker	FPDX70	Allis-Chalmers	FTPD	Allis-Chalmers
FID080	Baker	FPDX80	Allis-Chalmers	FTPD30	Allis-Chalmers
FIF020	Baker	FPL	Allis-Chalmers	FTPD40	Allis-Chalmers
FIF025	Baker	FPL20	Allis-Chalmers	FTPDX	Allis-Chalmers
FIF030	Baker	FPL25	Allis-Chalmers	FTPL	Allis-Chalmers
FIF040	Baker	FPL50	Allis-Chalmers	FTPL20	Allis-Chalmers
FIF050	Baker	FR12B	Fiat-Allis	FTPL30	Allis-Chalmers
FJA020	Baker	FR15B	Fiat-Allis	FTPL40	Allis-Chalmers
FJA025	Baker	FRH20	Baker	FTPL60	Allis-Chalmers
FJA030	Baker	FRR	Isuzu	FTR	Isuzu
FJA050	Baker	FRT80	Baker	FTS	Allis-Chalmers
FJA070	Baker	FS	Allis-Chalmers	FTSD	Allis-Chalmers
FJC030	Baker	FSD	Allis-Chalmers	FTSL60	Allis-Chalmers
FJD020	Baker	FSL	Allis-Chalmers	FTXB50	Allis-Chalmers
FJD025	Baker	FSL20 Thru 120 Series	Allis-Chalmers	FU40	Allis-Chalmers
FJD030	Baker	FSR	Isuzu	FVR	Isuzu
FJD040	Baker	FT	Allis-Chalmers	FXR	Isuzu
FJD050	Baker	FT20	Allis-Chalmers	FY	Poclair
FJD060	Baker	FT25	Allis-Chalmers	FY235	Clark
FJD070	Baker	FT30-15	Allis-Chalmers	G	
FJD080	Baker	FT30-24	Allis-Chalmers	G3 Series	Yale
FJF020	Baker	FT40	Allis-Chalmers	G5 Series	Yale
FJF025	Baker	FT50	Allis-Chalmers	G10P	Yale
FJF030	Baker	FT100	Allis-Chalmers	G12	Austin-Western
FJF040	Baker	FT900	Ford	G12	Gerlinger
FJF050	Baker	FT PL40	Allis-Chalmers	G15	Gerlinger
FK	Mitsubishi Fuso	FTB	Allis-Chalmers	G15	Pettibone
FL	Allis-Chalmers	FTB30	Allis-Chalmers	G15B	Pettibone
FL50	Freightliner	FTB50	Allis-Chalmers	G16	Gerlinger
FL60	Freightliner	FTBL	Allis-Chalmers	G18	Gerlinger
FL70	Freightliner	FTBL30	Allis-Chalmers	G20	Gerlinger
FL80	Freightliner	FTBL50	Allis-Chalmers	G20	Pettibone
FL106	Freightliner	FTD	Allis-Chalmers	G20B	Pettibone
FL112	Freightliner	FTD020	Baker	G22	Gerlinger
FL120	Allis-Chalmers	FTD025	Baker	G25	Amita
FLB	Freightliner	FTD30-15	Allis-Chalmers	G25	Pettibone
FLC	Freightliner	FTD30-24	Allis-Chalmers	G25B	Pettibone
FLD	Freightliner	FTD40	Allis-Chalmers	G30	Pettibone
FLS	Allis-Chalmers	FTD50	Allis-Chalmers	G30A	Pettibone
FLS112	Freightliner	FTD70	Allis-Chalmers	G30H	Pettibone
FM	Mitsubishi Fuso	FTDB	Allis-Chalmers	G40	Pettibone
FMA030	Baker	FTDB50	Allis-Chalmers	G40H	Pettibone
FMA050	Baker	FTDOA	Allis-Chalmers	G50	Pettibone
FMA070	Baker	FTDOH	Allis-Chalmers	G51C	Yale
FMC030	Baker	FTDX	Allis-Chalmers	G51C Series	Yale
FMD020	Baker	FTDX30-15	Allis-Chalmers	G51CN Series	Yale
FMD025	Baker	FTDX30-24	Allis-Chalmers	G51NC	Yale
FMD030	Baker	FTDX40	Allis-Chalmers	G51P Series	Yale
FMD040	Baker	FTDXB	Allis-Chalmers	G52 Series	Yale
FMD050	Baker	FTDXB50	Allis-Chalmers	G54C Series	Yale
FMD060	Baker	FTL	Allis-Chalmers	G54P Series	Yale
FMD070	Baker	FTL20	Allis-Chalmers	G60	Pettibone
FMD080	Baker	FTL25	Allis-Chalmers	G81	Yale
FMF020	Baker	FTL30-15	Allis-Chalmers	G83C	Yale
FMF025	Baker	FTL30-24	Allis-Chalmers	G83P	Yale
FMF030	Baker	FTL40	Allis-Chalmers	G86	Yale
FMF040	Baker	FTL50	Allis-Chalmers		

Model and Manufacturer Index

Model	Manufacturer	Model	Manufacturer	Model	Manufacturer
G - Continued		G - Continued		H - Continued	
G138.....	Allis-Chalmers	GS30A.....	Pettibone	H65G.....	Dresser-Hough
G149.....	Allis-Chalmers	GS30H.....	Pettibone	H70.....	Dresser-Hough
G226.....	Allis-Chalmers	GS40.....	Pettibone	H70B.....	Dresser-Hough
G262.....	Allis-Chalmers	GS50.....	Pettibone	H70B.....	Hyster
G357A.....	Yale	GS60.....	Pettibone	H70C.....	Dresser-Hough
G660.....	Warner & Swasey	GSS15.....	Pettibone	H70C.....	Hyster
GA.....	Thermo King	GSS15B.....	Pettibone	H70D.....	Dresser-Hough
GA30H.....	Pettibone	GSS20A.....	Pettibone	H80.....	Lift All
GA40.....	Pettibone	GSS20B.....	Pettibone	H80A.....	Dresser-Hough
GA40H.....	Pettibone	GSS25.....	Pettibone	H80B.....	Dresser-Hough
GA50.....	Pettibone	GSS25B.....	Pettibone	H80B.....	Hyster
GA60.....	Pettibone	GSS30.....	Pettibone	H80C.....	Hyster
GA70.....	Pettibone	GSS30A.....	Pettibone	H80XL.....	Hyster
GA80.....	Pettibone	GT6000-66.....	Gomaco	H90B.....	Dresser-Hough
GATOR.....	Raygo	GT6000-78.....	Gomaco	H90C.....	Dresser-Hough
GC.....	Poclair	GTC Series.....	Yale	H90D.....	Dresser-Hough
GC100.....	Yale	GTP50R.....	Yale	H90E.....	Dresser-Hough
GC120.....	Poclair	GU Series.....	Mack	H100.....	Dresser-Hough
GC150.....	Yale	GY.....	Poclair	H100.....	Lift All
GC Series.....	Yale	H		H100A.....	Dresser-Hough
GCS20.....	Clark	H.....	Jaeger	H100B.....	Dresser-Hough
GD22H-1.....	Komatsu	H.....	Mobilift	H100B.....	Hyster
GD30-5M.....	Komatsu	H4M32G.....	Herculift	H100C.....	Dresser-Hough
GD31-5H.....	Komatsu	H4M50.....	TCI	H100C.....	Hyster
GD37-5H.....	Komatsu	H4M60.....	TCI	H100XL.....	Hyster
GD615A.....	Komatsu	H4M80.....	TCI	H110F.....	Hyster
GD655-3.....	Komatsu	H12.....	Dresser-Hough	H120.....	Dresser-Hough
GD705A.....	Komatsu	H20E.....	Hyster	H120.....	Lift All
Genesis TM1000.....	Transcold	H25.....	Dresser-Hough	H120A.....	Dresser-Hough
GL.....	Thermo King	H25B.....	Dresser-Hough	H120B.....	Dresser-Hough
GLC050.....	Yale	H25E.....	Hyster	H120B.....	Hyster
GLC Series.....	Yale	H30.....	Clark	H120C.....	Dresser-Hough
GLF30.....	Automatic Transportation	H30.....	Dresser-Hough	H120C.....	Hyster
GLF40.....	Automatic Transportation	H30A.....	Dresser-Hough	H130F.....	Hyster
GLF50.....	Automatic Transportation	H30B.....	Dresser-Hough	H140C.....	Hyster
GLF60.....	Automatic Transportation	H30E.....	Hyster	H150.....	Lift All
GLF70.....	Automatic Transportation	H30F.....	Dresser-Hough	H150C.....	Hyster
GLF80.....	Automatic Transportation	H30F.....	Hyster	H150E.....	Hyster
GLF100.....	Automatic Transportation	H30FB.....	Dresser-Hough	H150F.....	Hyster
GLFP30.....	Automatic Transportation	H30H.....	Hyster	H165E.....	Hyster
GLFP40.....	Automatic Transportation	H30R.....	Dresser-Hough	H173.....	Allis-Chalmers
GLFP50.....	Automatic Transportation	H30RB.....	Dresser-Hough	H180E.....	Hyster
GLFP60.....	Automatic Transportation	H32.....	Gerlinger	H199.....	Allis-Chalmers
GLFP70.....	Automatic Transportation	H35XL.....	Hyster	H200E.....	Hyster
GLFP80.....	Automatic Transportation	H36.....	Gerlinger	H200ES.....	Hyster
GMF150.....	Automatic Transportation	H40F.....	Hyster	H202C.....	Unit Crane & Shovel
GMF160.....	Automatic Transportation	H40H.....	Hyster	H205.....	Allis-Chalmers
GMF180.....	Automatic Transportation	H40XL.....	Hyster	H217.....	Allis-Chalmers
GMF200.....	Automatic Transportation	H40.....	Dresser-Hough	H225E.....	Hyster
GP040.....	Yale	H40.....	Gerlinger	H225ES.....	Hyster
GP050R.....	Yale	H48.....	Ford	H250A.....	Hyster
GP52 Series.....	Yale	H50.....	Clark	H250E.....	Hyster
GP060L.....	Yale	H50.....	Dresser-Hough	H260.....	Allis-Chalmers
GP080L.....	Yale	H50B.....	Dresser-Hough	H275H.....	Hyster
GP100.....	Yale	H50C.....	Dresser-Hough	H298.....	Allis-Chalmers
GP150.....	Yale	H50F.....	Hyster	H300.....	Hyster
GPR52 Series.....	Yale	H50H.....	Hyster	H300A.....	Hyster
GPS15.....	Clark	H50XL.....	Hyster	H312.....	P & H
GPS30.....	Clark	H60.....	Dresser-Hough	H326.....	Allis-Chalmers
GR52 Series.....	Yale	H60B.....	Dresser-Hough	H330.....	Hyster
GS4-20.....	Pettibone	H60B.....	Hyster	H350B.....	Hyster
GS4-25.....	Pettibone	H60C.....	Hyster	H355.....	Clark
GS15.....	Pettibone	H60E.....	Dresser-Hough	H355PD.....	Clark
GS15B.....	Pettibone	H60F.....	Hyster	H360A.....	Hyster
GS20.....	Pettibone	H60H.....	Hyster	H400.....	Dresser-Hough
GS20B.....	Pettibone	H65.....	Dresser-Hough	H400A.....	Hyster
GS25.....	Pettibone	H65B.....	Dresser-Hough	H400B.....	Dresser-Hough
GS25B.....	Pettibone	H65C.....	Dresser-Hough	H400C.....	Dresser-Hough
GS30.....	Pettibone			H418.....	P & H

Model and Manufacturer Index

Indexes
& Abbrev.

Model	Manufacturer	Model	Manufacturer	Model	Manufacturer
H - Continued		H - Continued		J	
H460A.....	Hyster	HR-6-B.....	Cummins	J.....	Thermo King
H550.....	Warner & Swasey	HR-6-BI.....	Cummins	J36HD.....	Cleveland
H560.....	Dresser-Hough	HR-6-CI.....	Cummins	J-4.....	Cummins
H560B.....	Insley	HR-6-G.....	Cummins	J-6.....	Cummins
H685.....	Clark	HR-6-I.....	Cummins	J-6-BI.....	Cummins
H875.....	Insley	HR-6-IP.....	Cummins	J-6-CI.....	Cummins
H900A.....	Warner & Swasey	HR-6-P.....	Cummins	J-6-I.....	Cummins
H915.....	Clark	HRC-4-B.....	Cummins	J-6-IP.....	Cummins
H1500.....	Insley	HRC-4-BI.....	Cummins	J-6-P.....	Cummins
H-6-B.....	Cummins	HRC-4-G.....	Cummins	J-70-B.....	Cummins
H-6-BI.....	Cummins	HRC-4-I.....	Cummins	J-70-BI.....	Cummins
H-6-CI.....	Cummins	HRC-4-IP.....	Cummins	J-70-I.....	Cummins
H-6-G.....	Cummins	HRC-4-P.....	Cummins	J-70-IP.....	Cummins
H-6-I.....	Cummins	HRF-6-B.....	Cummins	J-80-B.....	Cummins
H-6-IF.....	Cummins	HRF-6-BI.....	Cummins	J-80-BI.....	Cummins
H-6-IP.....	Cummins	HRF-6-CI.....	Cummins	J-80-I.....	Cummins
H-6-P.....	Cummins	HRF-6-G.....	Cummins	J-80-IP.....	Cummins
H-135-CI.....	Cummins	HRF-6-I.....	Cummins	J-120-B.....	Cummins
H-743-C.....	Cummins	HRF-6-IP.....	Cummins	JC.....	Onan
H-743-L.....	Cummins	HRF-6-P.....	Cummins	JD646.....	John Deere
HA.....	Thermo King	HRS-6-B.....	Cummins	JD646B.....	John Deere
HC.....	Poclair	HRS-6-BI.....	Cummins	JD-I 30.....	Thermo King
HC18.....	Link-Belt	HRS-6-CI.....	Cummins	JD-I 50.....	Thermo King
HC78B.....	Link-Belt	HRS-6-G.....	Cummins	JF-6-B.....	Cummins
HC100.....	Hamm	HRS-6-I.....	Cummins	JF-6-BI.....	Cummins
HC108C.....	Link-Belt	HRS-6-IP.....	Cummins	JF-6-CI.....	Cummins
HC120.....	Hamm	HRS-6-P.....	Cummins	JF-6-I.....	Cummins
HC218.....	Link-Belt	HS-6-B.....	Cummins	JF-6-IP.....	Cummins
HC300.....	Poclair	HS-6-BI.....	Cummins	JF-6-P.....	Cummins
HD16DP.....	Fiat-Allis	HS-6-CI.....	Cummins	JN-6-B.....	Cummins
HD180-4.....	Komatsu	HS-6-G.....	Cummins	JN-6-BI.....	Cummins
HD320-2.....	Komatsu	HS-6-I.....	Cummins	JN-6-CI.....	Cummins
HD344.....	Allis-Chalmers	HS-6-IP.....	Cummins	JN-6-I.....	Cummins
HD516.....	Allis-Chalmers	HS-6-P.....	Cummins	JN-6-IP.....	Cummins
HD680.....	Komatsu	HSP8018.....	Link-Belt	JN-6-P.....	Cummins
HDR12EH.....	Le Roi	HSP8028S.....	Link-Belt	JN-130.....	Cummins
HE50.....	Hyster	HSP8040.....	Link-Belt	JNF-130.....	Cummins
Herculift 40.....	TCI	HT4.....	Caterpillar	JNR-6-BI.....	Cummins
HF.....	Dresser-Hough	HT80.....	Lift All	JNR-100.....	Cummins
HF.....	Gerlinger	HT100.....	Lift All	JNS-6-B.....	Cummins
HG1250.....	Arrow-Master, Inc.	HT120.....	Lift All	JNS-6-BI.....	Cummins
HH.....	Dresser-Hough	HT150.....	Lift All	JNS-6-CI.....	Cummins
HJ1250R.....	Arrow-Master, Inc.	HT450.....	Link-Belt	JNS-6-IP.....	Cummins
HK.....	Onan	HT3100.....	Gardner-Denver	JNS-6-P.....	Cummins
HK 30.....	Thermo King	HT4418.....	Warner & Swasey	JS-6-B.....	Cummins
HK 60.....	Thermo King	HTR.....	Isuzu	JS-6-BI.....	Cummins
HK 100.....	Thermo King	HVR.....	Isuzu	JS-6-CI.....	Cummins
HL644-22.....	Pettibone	HW.....	Mobilift	JS-6-IP.....	Cummins
HM.....	Dresser-Hough	HXR.....	Isuzu	JS-6-P.....	Cummins
HM.....	Thermo King	HY40.....	Clark	JT-6-B.....	Cummins
HM250.....	Rex	HY50.....	Clark	JT-6-BI.....	Cummins
HN.....	Onan	HY355PD.....	Clark	JT-6-CI.....	Cummins
HO.....	Dresser-Hough	HY685.....	Clark	JT-6-I.....	Cummins
HP175.....	Mkt Mfg. Inc.	HY1425.....	Clark	JT-6-IP.....	Cummins
HP205.....	Allis-Chalmers	HY1625.....	Clark	JT-6-P.....	Cummins
HP217.....	Allis-Chalmers	HY1830.....	Clark		
HP234.....	Allis-Chalmers	HY2030.....	Clark	K	
HP260.....	Allis-Chalmers			K.....	Buffalo Springfield
HP298.....	Allis-Chalmers	I		K.....	Mobilift
HP326.....	Allis-Chalmers	I105S.....	M-R-S	K1D.....	Dresser-Galion
HP351.....	Allis-Chalmers	I110S.....	M-R-S	K5-30.....	Towmotor
HR.....	Mobilift	IC701A.....	Broderson	K5-33.....	Towmotor
HR3.....	Lister	IT12B (1KF).....	Caterpillar	K5-36.....	Towmotor
HR-4-B.....	Cummins	IT14B (3NJ).....	Caterpillar	K5-40.....	Towmotor
HR-4-BI.....	Cummins	IT28B (1HF).....	Caterpillar	K45.....	Bomag
HR-4-G.....	Cummins	IT355.....	Clark	K45A.....	Kalamazoo
HR-4-I.....	Cummins	IT581.....	Clark	K100.....	Kenworth
HR-4-IP.....	Cummins			K300.....	Bomag
HR-4-P.....	Cummins			K300.....	Kenworth

Model and Manufacturer Index

Model	Manufacturer	Model	Manufacturer	Model	Manufacturer
K - Continued		K - Continued		L - Continued	
K360	Kenworth	KTTA19	Cummins	L555	New Holland
K360B	Hyster	KTTA19G	Cummins	L565	New Holland
K400	Kubota	KTTA38	Cummins	L634	Onan
K428	Allis-Chalmers	KTTA50	Cummins	L775	New Holland
K907LC Mark II	Kobelco	KTTT12	Cummins	L781	New Holland
K909LC Mark II	Kobelco	KW	Mobilift	L785	New Holland
K935	P & H	KX41	Kubota	L8000	Ford
K-6	Cummins	KX71	Kubota	L8500	Ford
KB	Onan	KX101	Kubota	L9000	Ford
KD-I	Thermo King	KX151	Kubota	L9500	Ford
KD-II	Thermo King			LA8000	Ford
KE	Hyster	L		LA9000	Ford
KF30	Buffalo Springfield	L	Cummins	LB90	New Holland
KG51 Series 10	Yale	L	Elgin	LC	Poclair
KG51 Series 15	Yale	L	Mobilift	LC	Thermo King
KG51 Series 20H	Yale	L4	Perkins	LC790	Lorain
KG51 Series 30	Yale	L12	Gerlinger	LCF	Ford
KG51 Series 30X	Yale	L15	Gerlinger	LE Series	Mack
KG51 Series 40	Yale	L16	Gerlinger	LEU Series	Mack
KG51 Series 50	Yale	L18	Gerlinger	LK	Onan
KG51 Series 60	Yale	L20	Gerlinger	LK350 Mark II	Kobelco
KG51 Series 70	Yale	L20	VME	LK700A	Kobelco
KG51 Series 80	Yale	L22	Gerlinger	LL9000	Ford
KG51 Series 100	Yale	L27	Thew Shovel	LLA9000	Ford
KGA51 Series	Yale	L30	Thew Shovel	L-Line	Sterling
KGP51 Series	Yale	L30	VME	LLS9000	Ford
KGP Series	Yale	L30	Volvo	LM	Cummins
KGPA51 Series	Yale	L35	New Holland	LM200	Fresia
KH007	Kubota	L35 Backhoe	Kubota	LN7000	Ford
KH10D	Kubota	L37	Thew Shovel	LN8000	Ford
KH18L	Kubota	L40	Lift All	LN9000	Ford
KH28L	Kubota	L40	Thew Shovel	LND 30	Thermo King
KH35	Kubota	L41	Thew Shovel	LND 30 PEG	Thermo King
KH41	Kubota	L41MC	Thew Shovel	LND 50	Thermo King
KH60	Kubota	L45	Thew Shovel	LND 50 PEG	Thermo King
KH90	Kubota	L50	Lift All	LNT8000	Ford
KH91	Kubota	L50	Thew Shovel	LNT9000	Ford
KH170L	Kubota	L50	Volvo	LO525	Allis-Chalmers
KH191	Kubota	L50B	Volvo	LoneStar	International/Navistar
KH191L	Kubota	L51 Series 30	Yale	LR	Cummins
KL 10	Thermo King	L51 Series 40	Yale	LR	Thermo King
KL 20	Thermo King	L51 Series 50	Yale	LR-I	Thermo King
KL 30	Thermo King	L51 Series 60	Yale	LRM	Cummins
KL 40	Thermo King	L51 Series 70	Yale	LRT	Cummins
KL 40S	Thermo King	L51 Series 80	Yale	LRT18U	Koehring
KL 50	Thermo King	L51 Series 100	Yale	LRT180	Koehring
KL 62	Thermo King	L52 Series	Yale	LRT275	Koehring
KL A	Thermo King	L56	Thew Shovel	LRT1600	Koehring
Kodiak C5500	Chevrolet	L60	Lift All	LRTM	Cummins
Kodiak C6500	Chevrolet	L64MH	Ingersoll	LS78	Link-Belt
Kodiak C7500	Chevrolet	L66	Thew Shovel	LS98	Link-Belt
Kodiak C8500	Chevrolet	L70	Volvo	LS98H	Link-Belt
KR	Onan	L70B	Volvo	LS108B	Link-Belt
KR	Thermo King	L83C	Yale	LS128DLC	Link-Belt
KT7B	Bomag	L83P	Yale	LS190	New Holland
KT8	Bomag	L85A	Thew Shovel	LS2700	Link-Belt
KT15	Bomag	L87	Thew Shovel	LS2800CII	Link-Belt
KT19G	Cummins	L90	Volvo	LS4000	Link-Belt
KT38	Cummins	L90B	Volvo	LS4300CII	Link-Belt
KTA12	Cummins	L95	Thew Shovel	LS5800	Link-Belt
KTA19	Cummins	L120	Volvo	LS5800CII	Link-Belt
KTA19G	Cummins	L150	Volvo	LS7400	Link-Belt
KTA38	Cummins	L175	New Holland	LS8000	Ford
KTA38G1	Cummins	L185	New Holland	LS9000	Ford
KTA50	Cummins	L225	New Holland	LSPRM8A	Bros
KTA52	Cummins	L423	Onan	LSPRM84A	Bros
KTA53	Cummins	L501	Thew Shovel	LT8000	Ford
KTT11	Cummins	L524	Mobilift	LT9000	Ford
KTT12	Cummins	L553	New Holland	LTA9000	Ford

Model and Manufacturer Index

Indexes
& Abbrev.

Model	Manufacturer	Model	Manufacturer	Model	Manufacturer
L - Continued		M - Continued		M - Continued	
LTL9000.....	Ford	MC530W.....	Thew Shovel	MWC 30.....	Thermo King
LTLA9000.....	Ford	MC540A.....	Lorain	MWC 40.....	Thermo King
LTLS9000.....	Ford	MC660.....	Thew Shovel	MWC 50.....	Thermo King
LTS8000.....	Ford	MC794.....	Thew Shovel	MWCL 25.....	Thermo King
LTS9000.....	Ford	MC875.....	Thew Shovel	MWCT.....	Thermo King
LX665.....	New Holland	MD140.....	MDI/Yutani	MXT.....	International/Navistar
LX985.....	New Holland	MD200.....	MDI/Yutani	MY40.....	Mobilift
LY.....	Poclair	MD240.....	MDI/Yutani	MY40B.....	Mobilift
M		MD320.....	MDI/Yutani	MY50.....	Mobilift
M.....	Elgin	MD Series.....	Bering Truck Corp.	MY50B.....	Mobilift
M.....	Mobilift	MDA.....	Multihoe	MY60.....	Mobilift
M.....	Poclair	MD-I.....	Thermo King	MY60B.....	Mobilift
M4K.....	Case	MD-II.....	Thermo King	MY70.....	Mobilift
M13.....	Thermo King	MF11.....	Massey Ferguson	MY70B.....	Mobilift
M15.....	Thermo King	MF20C.....	Massey Ferguson	MY80B.....	Mobilift
M22.....	Thermo King	MF30B.....	Massey Ferguson	MZ48B.....	Grove
M24.....	Gerlinger	MF44B.....	Massey Ferguson	MZ66.....	Grove
M26.....	Gerlinger	MF50A.....	Massey Ferguson	MZ116D.....	Grove
M28.....	Gerlinger	MF66.....	Massey Ferguson	N	
M30.....	Gerlinger	MF70.....	Massey Ferguson	N.....	Elgin
M40.....	Mobilift	MF77C.....	Massey Ferguson	N-495-B130.....	Cummins
M50.....	Mobilift	MF80.....	Massey Ferguson	N-495-C130.....	Cummins
M60.....	Lift All	MF202.....	Massey Ferguson	N-495-P130.....	Cummins
M70.....	Allis-Chalmers	MF202 Forklift.....	Massey Ferguson	N-927.....	Cummins
M70.....	Lift All	MF203.....	Massey Ferguson	ND9031.....	Zetor
M80.....	Lift All	MF204.....	Massey Ferguson	NDB40.....	Transcold
M100.....	Allis-Chalmers	MF204 Forklift.....	Massey Ferguson	NDE40.....	Transcold
M100.....	Lift All	MF205.....	Massey Ferguson	NDJ40.....	Transcold
M100B.....	Allis-Chalmers	MF220.....	Massey Ferguson	NDS40.....	Transcold
M120.....	Huber-Warco	MF300 Backhoe.....	Massey Ferguson	NDT40.....	Transcold
M150.....	Huber-Warco	MF320.....	Massey Ferguson	NFD.....	Thermo King
M180.....	Huber-Warco	MF450.....	Massey Ferguson	NH250-B.....	Cummins
M324.....	Mobilift	MF450S.....	Massey Ferguson	NH250-BI.....	Cummins
M600D.....	Bobcat-Melroe	MF470.....	Massey Ferguson	NH250-C.....	Cummins
M620.....	Bobcat-Melroe	MF811.....	Massey Ferguson	NH250-CI.....	Cummins
M643.....	Northern Lights	MF2500.....	Massey Ferguson	NH-6-IF.....	Cummins
M700.....	Bobcat-Melroe	MF4500.....	Massey Ferguson	NH-180-B.....	Cummins
M753.....	Northern Lights	MF6500.....	Massey Ferguson	NH-195-B.....	Cummins
M843N.....	Northern Lights	MH42A.....	Broderson	NH-220.....	Cummins
M964.....	Northern Lights	MH42B.....	Broderson	NH-220-B.....	Cummins
M970.....	Bobcat-Melroe	ML153.....	Thew Shovel	NH-220-BI.....	Cummins
M4276T.....	Northern Lights	MPH100S.....	Bomag	NH-220-CI.....	Cummins
MA20.....	Mobilift	MPH-1.....	Koehring	NH-220-G.....	Cummins
MA25.....	Mobilift	MR Series.....	Mack	NH-220-I.....	Cummins
MA30.....	Mobilift	MRU Series.....	Mack	NH-220-IP.....	Cummins
MA30 II.....	Mobilift	MS20.....	Mobilift	NH-220-P.....	Cummins
MA30S.....	Mobilift	MS25.....	Mobilift	NH-230.....	Cummins
MA35.....	Mobilift	MS30.....	Mobilift	NH-230-B.....	Cummins
MA40.....	Mobilift	MS35.....	Mobilift	NH-250.....	Cummins
MA40 II.....	Mobilift	MS Series.....	Mack	NH-250-IP.....	Cummins
MA45.....	Mobilift	MSB20.....	Mobilift	NH-250-P.....	Cummins
MA50.....	Mobilift	MSB25.....	Mobilift	NHC-4-B.....	Cummins
MA50 II.....	Mobilift	MSB30.....	Mobilift	NHC-4-BI.....	Cummins
MA55.....	Mobilift	MSB35.....	Mobilift	NHC-4-G.....	Cummins
MA60.....	Mobilift	MT35.....	Freightliner	NHC-4-I.....	Cummins
MA60 II.....	Mobilift	MT45.....	Freightliner	NHC-4-IP.....	Cummins
Maintainer.....	Huber-Warco	MT52.....	Bobcat-Melroe	NHC-4-P.....	Cummins
MC2.....	Thew Shovel	MT55.....	Freightliner	NHC-250.....	Cummins
MC3.....	Thew Shovel	MT60.....	Lift All	NHCT-270-B.....	Cummins
MC4.....	Thew Shovel	MT70.....	Lift All	NHD-180-B.....	Cummins
MC30H.....	Lorain	MT80.....	Lift All	NHE-180-B.....	Cummins
MC107.....	Thew Shovel	MT100.....	Lift All	NHE-180-CI.....	Cummins
MC320.....	Lorain	MTS20.....	Mobilift	NHE-180-I.....	Cummins
MC430.....	Thew Shovel	MTS25.....	Mobilift	NHE-195-B.....	Cummins
MC504.....	Thew Shovel	MTS30.....	Mobilift	NHE-220-B.....	Cummins
MC504W.....	Thew Shovel	MTS35.....	Mobilift	NHE-225.....	Cummins
MC520.....	Thew Shovel	MW.....	Thermo King	NHE-225-B.....	Cummins
MC524.....	Thew Shovel	MWC 10.....	Thermo King	NHR-195-CI.....	Cummins
		MWC 20.....	Thermo King		

Model and Manufacturer Index

Model	Manufacturer	Model	Manufacturer	Model	Manufacturer
N - Continued		N - Continued		P	
NHRS-6-B.....	Cummins	NTA-370-B.....	Cummins	P3.....	Nissan
NHRS-6-BI.....	Cummins	NTA-380.....	Cummins	P3.....	Perkins
NHRS-6-CI.....	Cummins	NTA-400.....	Cummins	P4.....	Perkins
NHRS-6-G.....	Cummins	NTA-420.....	Cummins	P5.....	Nissan
NHRS-6-I.....	Cummins	NTA-420-C.....	Cummins	P6.....	Perkins
NHRS-6-IP.....	Cummins	NTC-290.....	Cummins	P6S042.....	Chevrolet
NHRS-6-P.....	Cummins	NTC-335.....	Cummins	P6S042.....	GMC
NHS-6-B.....	Cummins	NTC-335-B.....	Cummins	P8.....	Nissan
NHS-6-BI.....	Cummins	NTC-350.....	Cummins	P30.....	Chevrolet
NHS-6-CI.....	Cummins	NTE-235-B.....	Cummins	P40A.....	Hyster
NHS-6-I.....	Cummins	NTE-235-BI.....	Cummins	P50.....	Allis-Chalmers
NHS-6-IP.....	Cummins	NTO-6-B.....	Cummins	P50A.....	Hyster
NHS-6-P.....	Cummins	NTO-6-BI.....	Cummins	P60A.....	Hyster
NPR.....	Isuzu	NTO-6-CI.....	Cummins	P80A.....	Hyster
NQR.....	Isuzu	NTO-6-I.....	Cummins	P125A.....	Hyster
NRR.....	Isuzu	NTO-6-IP.....	Cummins	P150A.....	Hyster
NRT-6-B.....	Cummins	NTO-6-P.....	Cummins	P150B.....	Hyster
NRT-6-BI.....	Cummins	NTO-262.....	Cummins	P165A.....	Hyster
NRT-6-CI.....	Cummins	NTO-262-B.....	Cummins	P180A.....	Hyster
NRT-6-I.....	Cummins	NTO-262-BI.....	Cummins	P200B.....	Hyster
NRT-6-IP.....	Cummins	NTO-262-CI.....	Cummins	P3500.....	GMC
NRT-6-P.....	Cummins	NTO-262-I.....	Cummins	P Series.....	Workhorse
NRTO-6-B.....	Cummins	NTO-262-IP.....	Cummins	Pacer 100.....	Austin-Western
NRTO-6-BI.....	Cummins	NTO-262-P.....	Cummins	Pacer 200.....	Austin-Western
NRTO-6-CI.....	Cummins	NTO-280-B.....	Cummins	Pacer 300.....	Austin-Western
NRTO-6-I.....	Cummins	NTO-280-CI.....	Cummins	Pacer 301.....	Austin-Western
NRTO-6-IP.....	Cummins	NTRO-6-P.....	Cummins	Pacer 400.....	Austin-Western
NSD1-1012.....	Thermo King	NVH12-450.....	Cummins	Pacer 500.....	Austin-Western
NT-6-B.....	Cummins	NVH-12.....	Cummins	Pactor.....	Rex
NT-6-BI.....	Cummins	NWD.....	Thermo King	PayStar 5500i.....	International/Navistar
NT-6-CI.....	Cummins	NWD 30 3000.....	Thermo King	PayStar 5600i.....	International/Navistar
NT-6-I.....	Cummins	NWD 30 3005.....	Thermo King	PayStar 5900i.....	International/Navistar
NT-6-IP.....	Cummins	NWD 30 3006.....	Thermo King	PC.....	Gerlinger
NT-6-P.....	Cummins	NWD 30 3100 Series.....	Thermo King	PC05-5.....	Komatsu
NT-165-BI.....	Cummins	NWD 30 AM4.....	Thermo King	PC120.....	Komatsu
NT-180-B.....	Cummins	NWD 30 AM6.....	Thermo King	PC180LC.....	Komatsu
NT-180-BI.....	Cummins	NWD 30 AM7.....	Thermo King	PC200LC.....	Komatsu
NT-200-B.....	Cummins	NWD 30 M4.....	Thermo King	PC220LC.....	Komatsu
NT-200-BI.....	Cummins	NWD 30 M10A.....	Thermo King	PC300LC.....	Komatsu
NT-270-CT.....	Cummins	NWD 30 M20.....	Thermo King	PC360LC.....	Komatsu
NT-280.....	Cummins	NWD 30 M22.....	Thermo King	PC400LC3.....	Komatsu
NT-280-B.....	Cummins	NWD 30 M30.....	Thermo King	PC650.....	Komatsu
NT-280-BI.....	Cummins	NWD 30 M35.....	Thermo King	PF25.....	Blaw-Knox
NT-280-CI.....	Cummins	NWD 30 M46.....	Thermo King	PF30.....	Gerlinger
NT-300-B.....	Cummins	NWD 30 M50.....	Thermo King	PF65.....	Blaw-Knox
NT-300-BI.....	Cummins	NWD 30 M100.....	Thermo King	PF120.....	Blaw-Knox
NT-300-CI.....	Cummins	NWD 30 M1212.....	Thermo King	PF500.....	Blaw-Knox
NT-310.....	Cummins	NWD 35 AM6.....	Thermo King	PFH30.....	Gerlinger
NT-310-CI.....	Cummins	NWD 35 AM7.....	Thermo King	PH462.....	Gerlinger
NT-335.....	Cummins	NWD 35 AM8.....	Thermo King	PH562.....	Gerlinger
NT-335-B.....	Cummins	NWD 35 M4.....	Thermo King	PH662.....	Gerlinger
NT-335-BI.....	Cummins	NWD 35 M5.....	Thermo King	PH862.....	Gerlinger
NT-335-CI.....	Cummins	NWD 35 M21.....	Thermo King	PH962.....	Gerlinger
NT-335-G.....	Cummins	NWD 50.....	Thermo King	Pneumatic Tire Roller.....	Dresser-Galion
NT-380-B.....	Cummins	NWD 50 3000.....	Thermo King	PR11.....	Austin-Western
NT-380-BI.....	Cummins	NWD 50 3011.....	Thermo King	PRO126.....	Snorkel Lift
NT-380-G.....	Cummins	NWD 50 3100 Series.....	Thermo King	ProStar Series.....	International/Navistar
NT-380-I.....	Cummins	NWD 50 M207.....	Thermo King	PSR9.....	Bomag
NT-380-IP.....	Cummins	NWD 62.....	Thermo King	PSR30.....	Bomag
NT-855-B335.....	Cummins	NWD 62 30M5.....	Thermo King	PSRC10.....	Bomag
NT-855-B380.....	Cummins	NWD 62 50.....	Thermo King	PW.....	Gerlinger
NT-855-C310.....	Cummins	NWD 622 30M10A.....	Thermo King		
NT-855-C335.....	Cummins	NWD (Super & Crown).....	Thermo King	Q	
NT-855-C380.....	Cummins	NWD-AM1.....	Thermo King	Q125DJE.....	Le Roi
NT-855-G5.....	Cummins	NWD-AM3.....	Thermo King	Quicksilver QS-5.0G.....	Lister
NT-855-P280.....	Cummins	NWD-AM4.....	Thermo King	Quicksilver QS-7.5G 0.9 L.....	Lister
NT-855-P335.....	Cummins	NWD-AM8.....	Thermo King	Quicksilver QS-8.0D 1.0 L.....	Lister
NT-855-P380.....	Cummins	NWE MAX.....	Thermo King	Quicksilver QS-8.0G 0.9 L.....	Lister
NTA-370.....	Cummins	NWG.....	Thermo King	Quicksilver QS-10.G 1.2 L.....	Lister

Model and Manufacturer Index

Indexes & Abbrev.

Model	Manufacturer	Model	Manufacturer	Model	Manufacturer
R		R - Continued		S - Continued	
R6.....	Perkins	RP250G31.....	Joy	S40.....	Genie
R15 (91FD).....	Euclid	RP365.....	Gardner-Denver	S46.....	Bomag
R18 (91FD).....	Euclid	RP600.....	Gardner-Denver	S60.....	Genie
R22 (59TD).....	Euclid	RP600D.....	Gardner-Denver	S60E.....	Hyster
R22 (63TD).....	Euclid	RP600DB.....	Gardner-Denver	S65.....	Genie
R30.....	Ditch Witch	RP900.....	Gardner-Denver	S70E.....	Hyster
R30 (71TD).....	Euclid	RPS185.....	Joy	S80.....	Genie
R35 (74TD).....	Euclid	RPS750.....	Joy	S80E.....	Hyster
R35 (201TD).....	Euclid	RPS900DB30.....	Joy	S85.....	Genie
R40.....	Caterpillar	RPS1050.....	Joy	S100E.....	Hyster
R40 (9FFD).....	Euclid	RPS1200.....	Joy	S125A.....	Hyster
R45 (9FFD).....	Euclid	RPS1300.....	Joy	S130.....	Bobcat-Melroe
R50 (201LD).....	Euclid	RPV100GA20.....	Joy	S135 (4V).....	Caterpillar
R65.....	Ditch Witch	RPV160DA23.....	Joy	S150A.....	Hyster
R80.....	Caterpillar	RPV160GA20.....	Joy	S220.....	International
R100D.....	Ditch Witch	RS16A.....	Tampo	S240.....	International
R310.....	Kubota	RS28.....	Tampo	S300.....	Bobcat-Melroe
R372.....	International	RS425.....	CMI	S318 (3V).....	Caterpillar
R406.....	International	RSP750.....	Joy	S588 Telekruiser.....	Bantam
R410.....	Kubota	RT.....	Allis-Chalmers	S626 Telekruiser.....	Bantam
R450.....	International	RT.....	Thermo King	S628 Telekruiser.....	Bantam
R510.....	Kubota	RT48.....	Grove	SA41.....	Barber-Greene
R911LC.....	Liebherr	RT48A.....	Condor	SB68.....	Pettibone
R925.....	Liebherr	RT59S.....	Grove	SB-I 30.....	Thermo King
R961LC.....	Liebherr	RT400.....	Grove	SB-I 50.....	Thermo King
Ram 30.....	Raygo	RT500C.....	Grove	SB-I 1000.....	Thermo King
Ram 4500HD.....	Dodge	RT500DXL.....	Grove	SB-I 1200.....	Thermo King
Ram 5500HD.....	Dodge	RT522.....	Grove	SB-I 2000.....	Thermo King
Ranger 500.....	Tamrock	RT625.....	Grove	SB-I 5300.....	Thermo King
Rascal 220B.....	Raygo	RT630.....	Grove	SB-II 30.....	Thermo King
Rascal 300A.....	Raygo	RT745.....	Grove	SB-II 30 DELTA.....	Thermo King
Rascal 320A.....	Raygo	RTD.....	Allis-Chalmers	SB-II 30 PEG.....	Thermo King
Rascal 400A.....	Raygo	RTL40.....	Allis-Chalmers	SB-II 30 1500 AC.....	Thermo King
Rascal 420B.....	Raygo	Rubber Tire Compactor.....	Dresser-Galion	SB-II 30 1500 PEG.....	Thermo King
Rascal 600A.....	Raygo	Rustler 304A.....	Raygo	SB-II 50.....	Thermo King
Razor 350.....	Raygo	Rustler 404B.....	Raygo	SB-II 50 TC.....	Thermo King
RB Series.....	Mack	RW181.....	Clark-Michigan-VME	SB-II C201.....	Thermo King
RC.....	Poclair	RXT.....	International/Navistar	SB-II Convertible.....	Thermo King
RC8.....	Sullair	S		SB-II HP.....	Thermo King
RC60.....	Caterpillar	S.....	Elgin	SB-II Max.....	Thermo King
RC60.....	Gerlinger	S4AG9A.....	Massey Ferguson	SB-II Max 30.....	Thermo King
RC200.....	Poclair	S5-8A.....	Dresser-Galion	SB-II Max 50 EEC.....	Thermo King
RCD.....	Thermo King	S5H9A.....	Massey Ferguson	SB-II Max Plus.....	Thermo King
RD Series.....	Mack	S7.....	Dresser-Dressta	SB-II PE.....	Thermo King
RD-I 30.....	Thermo King	S7.....	Terex	SB-II Reverse Air.....	Thermo King
RD-I 50.....	Thermo King	S8.....	Dresser-Dressta	SB-II TC.....	Thermo King
RD-I SSIV.....	Thermo King	S8.....	Gerlinger	SB-II Tracker.....	Thermo King
RD-II.....	Thermo King	S8.....	International	SB-III 30 TC.....	Thermo King
RDJC.....	Onan	S8N.....	Gerlinger	SB-III Max 30.....	Thermo King
RJC.....	Onan	S8-10.5A.....	Dresser-Galion	SB-III Max 50.....	Thermo King
RL.....	Thermo King	S8-12A.....	Dresser-Galion	SB-III SR.....	Thermo King
RL 20.....	Thermo King	S10N.....	Gerlinger	SB-III SRMP Plus.....	Thermo King
RL 50.....	Thermo King	S10.....	Gerlinger	SB-III TC Max.....	Thermo King
RLA.....	Thermo King	S10-14A.....	Dresser-Galion	SC.....	Poclair
RLD.....	Thermo King	S11E.....	Terex	SC60.....	Gerlinger
Roadster 120.....	Raygo	S12.....	Gerlinger	SC7000.....	Sterling
Roadster C.....	Le Tourneau	S12.....	Terex	SC8000.....	Sterling
Roadster D.....	Le Tourneau	S12 (77FDT).....	Euclid	SD70.....	Ingersoll
ROL 30.....	Thermo King	S12 (78FDT).....	Euclid	SD-I 1012.....	Thermo King
ROL 40.....	Thermo King	S15.....	Gerlinger	SD-I 1013.....	Thermo King
ROL 50.....	Thermo King	S16.....	Gerlinger	Sentry 30.....	Thermo King
RP16D.....	Tampo	S18.....	Gerlinger	Sentry 30 PEG.....	Thermo King
RP60.....	Dresser-Galion	S18.....	Gerlinger	Sentry 30 1000.....	Thermo King
RP125DA.....	Gardner-Denver	S18.....	Terex	Sentry 30 1200.....	Thermo King
RP125G.....	Gardner-Denver	S23E.....	Terex	Sentry 30 2000.....	Thermo King
RP125G51.....	Joy	S24.....	Terex	Sentry 50 Convertible.....	Thermo King
RP210DA.....	Gardner-Denver	S28.....	Terex	Sentry 50 1000.....	Thermo King
RP210GA.....	Gardner-Denver	S32.....	Terex	Sentry 50 1200.....	Thermo King
RP250D31.....	Joy	S35E.....	Terex	Sentry 50 2000.....	Thermo King

Model and Manufacturer Index

Model	Manufacturer	Model	Manufacturer	Model	Manufacturer
S - Continued		S - Continued		S - Continued	
Sentry DI 30.....	Thermo King	SPQDC.....	Gardner-Denver	Super XMT.....	Thermo King
Sentry DI 30 PE.....	Thermo King	SPQDD.....	Gardner-Denver	Supra 550.....	Carrier
Sentry DI 30 PEG.....	Thermo King	SPTDA.....	Gardner-Denver	Supra 622.....	Carrier
Sentry DI 50.....	Thermo King	SPTDB.....	Gardner-Denver	Supra 644.....	Carrier
Sentry DI Convertible.....	Thermo King	SPTDC.....	Gardner-Denver	Supra 922.....	Carrier
Sentry DI Convertible PE...	Thermo King	SPTDD.....	Gardner-Denver	Supra 944.....	Carrier
Sentry DI TC.....	Thermo King	SPV627.....	Bros	SW77.....	Easi-Doer
Sentry TC Convertible.....	Thermo King	SPV627VA.....	Bros	Sweepmaster.....	Weldon
SG3320.....	Hino	SPV735.....	Bros	T	
SG3323.....	Hino	SPV735VA.....	Bros	T.....	Elgin
SG3325.....	Hino	SPV850.....	Bros	T3M43.....	Thermo King
SG5523.....	Hino	SPWDA.....	Gardner-Denver	T4.....	Ingersoll
Silver Star.....	Sterling	SPWDB.....	Gardner-Denver	T25.....	Caterpillar
SK60.....	Champ	SPWDC.....	Gardner-Denver	T25D.....	Caterpillar
SK70.....	Champ	SR4.....	Lister	T30.....	Caterpillar
SK80.....	Champ	SRH (4H Series).....	Gerlinger	T30B.....	Caterpillar
SK100.....	Champ	SRL.....	Thermo King	T30B.....	Towmotor
SK815-5.....	Komatsu	SRL-50.....	Thermo King	T30C.....	Caterpillar
SK820-5.....	Komatsu	SROL.....	Thermo King	T30D.....	Caterpillar
SK1020-5.....	Komatsu	SS12 (77FDT).....	Euclid	T30D.....	Caterpillar
SK1026-5.....	Komatsu	SS12 (78FDT).....	Euclid	T35B.....	Caterpillar
SKF.....	Thermo King	SS18 (23TDT).....	Euclid	T35B.....	Towmotor
SL150-2.....	Samsung	SS24 (33LOT).....	Euclid	T35D.....	Caterpillar
SL180-2.....	Samsung	SS24 (33LOT).....	Terex	T40.....	Caterpillar
SL6625.....	Gehl	SS40 (49LDT).....	Terex	T40.....	Fabtek
SLH3280HG.....	Snorkel Lift	SSPRIN1-7.....	Bros	T40B.....	Caterpillar
SLH3284HD.....	Snorkel Lift	SSPRN7.....	Bros	T40B.....	Towmotor
SM20.....	Gerlinger	STB-I.....	Thermo King	T40C.....	Caterpillar
SM26 Shop Mule.....	United Tractor	STB-II.....	Thermo King	T40D.....	Caterpillar
SM30.....	Gerlinger	STB-III.....	Thermo King	T40DSA.....	Caterpillar
SM30 Shop Mule.....	United Tractor	Super 100.....	Austin-Western	T45B.....	Caterpillar
SM40 Shop Mule.....	United Tractor	Super 200.....	Austin-Western	T45B.....	Towmotor
SM50 Shop Mule.....	United Tractor	Super 250/270.....	Cummins	T50.....	Caterpillar
SM80 Shop Mule.....	United Tractor	Super 300.....	Austin-Western	T50B.....	Caterpillar
SM160 Shop Mule.....	United Tractor	Super 400.....	Austin-Western	T50B.....	Towmotor
SM710.....	Peltibone	Super 500.....	Austin-Western	T50C.....	Caterpillar
SM4688XT.....	Grove	Super C.....	Le Tourneau	T50D.....	Caterpillar
SMH.....	Gerlinger	Super C Tournadozer.....	Le Tourneau	T50DSA.....	Caterpillar
SP42.....	Ingersoll	Super GS.....	Thermo King	T53.....	Austin-Western
SP54.....	Ingersoll	Super II 30.....	Thermo King	T55B.....	Caterpillar
SP54C.....	Bros	Super II 30 Dehumidifier....	Thermo King	T60.....	Caterpillar
SP75D.....	Ferguson Shovel Supply	Super II 30 Max.....	Thermo King	T60B.....	Caterpillar
SP107.....	Thew Shovel	Super II 30 TC.....	Thermo King	T60B.....	Towmotor
SP120B.....	Ferguson Shovel Supply	Super II 50.....	Thermo King	T60C.....	Caterpillar
SP255.....	Bros	Super MAX.....	Thermo King	T60C.....	Towmotor
SP524.....	Thew Shovel	Super NWD.....	Thermo King	T70C.....	Towmotor
SP530.....	Thew Shovel	Super NWD 30.....	Thermo King	T80C.....	Caterpillar
SP600.....	Rex	Super NWD 30 5154 BP.....	Thermo King	T80C.....	Towmotor
SP600DK.....	Gardner-Denver	Super NWD 30 5200 AMG.....	Thermo King	T84.....	Austin-Western
SP700.....	Rex	Super NWD 30 5237 ESP.....	Thermo King	T90C.....	Towmotor
SP730B.....	Bros	Super NWD 30 5300.....	Thermo King	T100C.....	Caterpillar
SP735.....	Bros	Super NWD 30 5300 AMG.....	Thermo King	T100C.....	Towmotor
SP1200DE.....	Gardner-Denver	Super NWD 30 PE 1000....	Thermo King	T104.....	Austin-Western
SP1200DF.....	Gardner-Denver	Super NWD 30 PE 1200....	Thermo King	T110C.....	Caterpillar
SP4000.....	Bros	Super NWD 30 PE 5000....	Thermo King	T120C.....	Caterpillar
SP6000.....	Bros	Super NWD 30 PE 5100....	Thermo King	T120C.....	Towmotor
SP6000B.....	Bros	Super NWD 30 PE 5200....	Thermo King	T165.....	Caterpillar
SPCGA.....	Gardner-Denver	Super NWD 50.....	Thermo King	T170.....	Kenworth
SPFGA.....	Gardner-Denver	Super NWD 50 SS TV.....	Thermo King	T180.....	Caterpillar
SPFGB.....	Gardner-Denver	Super NWD 50 5000.....	Thermo King	T180F.....	International
SPFGC.....	Gardner-Denver	Super NWD 50 5100.....	Thermo King	T180FB.....	International
SPHDA.....	Gardner-Denver	Super NWD 50 5200.....	Thermo King	T183HD.....	Thomas
SPHGA.....	Gardner-Denver	Super NWD 50 5200 AMG.....	Thermo King	T200.....	Caterpillar
SPHGC.....	Gardner-Denver	Super NWD 50 5237 ESP.....	Thermo King	T225.....	International
SPKDB.....	Gardner-Denver	Super NWD 50 5300.....	Thermo King	T225SL.....	International
SPNDA.....	Gardner-Denver	Super NWD 50 5300 AMG.....	Thermo King	T270.....	Kenworth
SPNDB.....	Gardner-Denver	Super NWD 5137.....	Thermo King	T300.....	Caterpillar
SPODA.....	Gardner-Denver	Super NWD 5137 AMG.....	Thermo King	T300.....	International
SPQDB.....	Gardner-Denver	Super NWD LR.....	Thermo King	T300.....	Kenworth

Model and Manufacturer Index

Indexes & Abbrev.

Model	Manufacturer	Model	Manufacturer	Model	Manufacturer
T - Continued		T - Continued		T - Continued	
T300SL	International	TD7E	International	TL545	Allis-Chalmers
T330	New Holland	TD7E Crawler	Dresser-Dressta	TM2500	Grove
T370	Kenworth	TD7G Crawler	Dresser-Dressta	Topkick C5500	GMC
T400	Caterpillar	TD8C	Dresser-Dressta	Topkick C6500	GMC
T400	Kenworth	TD8C	International	Topkick C7500	GMC
T400A	Dresser-Galion	TD8E	International	Topkick C8500	GMC
T440	Kenworth	TD8E Crawler	Dresser-Dressta	Tornadozer	Le Tourneau
T450	Kenworth	TD8G Crawler	Dresser-Dressta	Tournapull	Le Tourneau
T470	Kenworth	TD12	International	Tournapull B	Le Tourneau
T470H	Kenworth	TD12 Crawler	Dresser-Dressta	Tournapull C	Le Tourneau
T500	Dresser-Galion	TD12B	Dresser-Dressta	Tournapull D	Le Tourneau
T500A	Dresser-Galion	TD15B	Dresser-Dressta	Tournatractor B	Le Tourneau
T500C	Dresser-Galion	TD15B	International	Tournatractor C	Le Tourneau
T500L	Dresser-Galion	TD15C	International	TR225	CMI
T500S	International	TD15C Articulated Crawler	Dresser-Dressta	TR260	Allis-Chalmers
T550	New Holland	TD15C Crawler	Dresser-Dressta	TranStar 8500	International/Navistar
T600	Dresser-Galion	TD15E Crawler	Dresser-Dressta	TranStar 8600	International/Navistar
T600	Kenworth	TD20B	Dresser-Dressta	TS14	Terex
T644 Teleskoop	Bantam	TD20B	International	TS14B	Terex
T660	Kenworth	TD20C	Dresser-Dressta	TS18	Terex
T680	Kenworth	TD20C	International	TS18 (29LOT)	Terex
T700	Dresser-Galion	TD20E	International	TS24	Terex
T700	Kenworth	TD20E Crawler	Dresser-Dressta	TS32	Terex
T725A Teleskoop	Bantam	TD20G Crawler	Dresser-Dressta	TS160	Allis-Chalmers
T750	Parsons	TD25B	Dresser-Dressta	TS200	Allis-Chalmers
T800	Kenworth	TD25B	International	TS260	Allis-Chalmers
T800S	International	TD25C	Dresser-Dressta	TS360	Allis-Chalmers
T1386	Austin-Western	TD25C	International	TWD	Thermo King
T2000	Kenworth	TD25E	International	TX	Poclair
T5500	Chevrolet	TD25E Crawler	Dresser-Dressta	TY	Poclair
T5500	GMC	TD25G Crawler	Dresser-Dressta	TY45	Poclair
T6500	Chevrolet	TD40 Crawler	Dresser-Dressta	TYS	Poclair
T6500	GMC	TD40B Crawler	Dresser-Dressta	U	
T7500	Chevrolet	TD180FB	International	U1	International
T7500	GMC	TD225SL	International	U2	International
T8500	Chevrolet	TD300SL	International	U2A	International
T8500	GMC	TD588 Telekrane	Bantam	U4	International
TA77	Barber-Greene	TD Series	Mack	U6	International
TA341	Tamrock	TDB	Transcold	U6	Towmotor
TB025	Takeuchi	TD-II	Thermo King	U8	Gerlinger
TB37	Snorkel Lift	TDS	Transcold	U8	Towmotor
TB68S	Takeuchi	TE4	Bros	U9	International
TB650S	Takeuchi	TE750	Arctic Traveler	U14	International
TB800	Takeuchi	TerraStar	International/Navistar	U21	International
TC	Poclair	TGS	Transcold	U123	International
TC12	Euclid	TH8-12D	Dresser-Galion	U164	International
TC30	Barber-Greene	TH8-12G	Dresser-Galion	U169	International
TC30	Caterpillar	The Articulator	Brown	U175	International
TC30C	Caterpillar	Three Wheel	Huber-Warco	U220	International
TC40C	Caterpillar	Tiltmaster W4	Chevrolet	U240	International
TC44H	John Deere	Tiltmaster W5	Chevrolet	U264	International
TC50C	Caterpillar	Tiltmaster W6	Chevrolet	U281	International
TC54H	John Deere	Tiltmaster W7	Chevrolet	U350	International
TC60	Dresser-Hough	TL10	Allis-Chalmers	U372	International
TC60C	Caterpillar	TL11	Allis-Chalmers	U406	International
TC60D	Caterpillar	TL12	Allis-Chalmers	U450	International
TC60DSA	Caterpillar	TL14	Allis-Chalmers	U501	International
TC62H	John Deere	TL14A	Allis-Chalmers	U1091	International
TC80C	Caterpillar	TL16	Allis-Chalmers	U1200	Unimog
TC100C	Caterpillar	TL16A	Allis-Chalmers	UB220	International
TC110C	Caterpillar	TL20	Allis-Chalmers	UB240	International
TC120C	Caterpillar	TL25K	Thew Shovel	UB264	International
TCB	Poclair	TL26	Takeuchi	UC60	International
TCS	Poclair	TL30	Allis-Chalmers	UC135	International
TCS-M1	Poclair	TL40	Allis-Chalmers	UC221	International
TCS-M2	Poclair	TL40	Champ	UC263	International
TD	Thermo King	TL40C	Champ	UD6	International
TD7C	Dresser-Dressta	TL50	Champ	UD6A	International
TD7C	International	TL254W	Thew Shovel		

Model and Manufacturer Index

Model	Manufacturer	Model	Manufacturer	Model	Manufacturer
U - Continued		V - Continued		V - Continued	
UD9	International	V12-525	Cummins	V200	Caterpillar
UD9A	International	V25D	Caterpillar	V200	Towmotor
UD14	International	V30	Caterpillar	V200B	Caterpillar
UD14A	International	V30	Ditch Witch	V200ES	Caterpillar
UD16	International	V30B	Caterpillar	V200HF	Caterpillar
UD18	International	V30B	Towmotor	V225	Caterpillar
UD18A	International	V30C	Caterpillar	V225	Towmotor
UD24	International	V30D	Caterpillar	V225B	Caterpillar
UD236	International	V35B	Caterpillar	V225HF	Caterpillar
UD264	International	V35B	Towmotor	V250B	Caterpillar
UD281	International	V35C	Caterpillar	V300	Caterpillar
UD282	International	V35D	Caterpillar	V300B	Caterpillar
UD350	International	V40	Caterpillar	V330B	Caterpillar
UD370	International	V40B	Caterpillar	V785-B235	Cummins
UD525	International	V40B	Towmotor	V785-B265	Cummins
UD554	International	V40C	Caterpillar	V785-C220	Cummins
UD691	International	V40D	Caterpillar	V785-C265	Cummins
UD817	International	V40DSA	Caterpillar	V785-P265	Cummins
UD1091	International	V41	Caterpillar	V-155	Cummins
UDE	Transcold	V41B	Caterpillar	V-352-C140	Cummins
UDG	Transcold	V45B	Caterpillar	V-378	Cummins
UDT817	International	V45B	Towmotor	V-470	Cummins
UDT1091	International	V45C	Caterpillar	V-504	Cummins
UH20	Hitachi	V50	Caterpillar	V-555C	Cummins
UH30	Hitachi	V50B	Caterpillar	V-588-B195	Cummins
UH062	Hitachi	V50B	Towmotor	V-588-B200	Cummins
UH119	Parsons	V50C	Caterpillar	V-588-C180	Cummins
UH122	Hitachi	V50D	Caterpillar	V-588-C200	Cummins
UH172	Hitachi	V50DSA	Caterpillar	V-903	Cummins
UK	Thermo King	V51	Caterpillar	V-903-C	Cummins
US	Thermo King	V51B	Caterpillar	V-1710-B500	Cummins
US-50	Thermo King	V55B	Caterpillar	V-1710-C500	Cummins
UT40	Baker	V55B	Towmotor	V-1710-P500	Cummins
UV345	International	V60	Caterpillar	Vanguard 4000SP	FMC
UV401	International	V60B	Caterpillar	Vanguard V3000SP	FMC
UV461	International	V60B	Towmotor	VC40D	Caterpillar
UV549	International	V60C	Caterpillar	VC60D	Caterpillar
UWD	Thermo King	V60C	Towmotor	VC60DSA	Caterpillar
UWTD	Thermo King	V60D	Caterpillar	VH10 Roustabout	Hughes-Keenan
V		V60DSA	Caterpillar	VH20 Roustabout	Hughes-Keenan
V6 Roustabout	Hughes-Keenan	V60E	Caterpillar	VHD	Volvo
V6-B	Cummins	V70C	Caterpillar	VM33	Bomag
V6-CI	Cummins	V70C	Towmotor	VN Series	Volvo
V6-SVC-B	Cummins	V70D	Caterpillar	VOS2-42A	Dresser-Galion
V6-SVC-CI	Cummins	V70E	Caterpillar	VOS2-66B	Dresser-Galion
V6-140	Cummins	V80C	Caterpillar	VOS66A	Dresser-Galion
V6-155	Cummins	V80C	Towmotor	VOS84A	Dresser-Galion
V6-200-B	Cummins	V80D	Caterpillar	VOSA66A	Dresser-Galion
V6-200-CI	Cummins	V80E	Caterpillar	VOSA84A	Dresser-Galion
V6-378	Cummins	V100	Caterpillar	VOSD66A	Dresser-Galion
V6E-195-B	Cummins	V100	Towmotor	VOSD84A	Dresser-Galion
V6E-195-BI	Cummins	V110	Caterpillar	VOSPD66A	Dresser-Galion
V6R-180-CI	Cummins	V120	Caterpillar	VOSPD84A	Dresser-Galion
V8-185	Cummins	V120	Towmotor	VOST2-42A	Dresser-Galion
V8-210	Cummins	V130	Caterpillar	VR84H	Dresser-Galion
V8-265	Cummins	V140	Caterpillar	VR642	Ingersoll-Rand
V8-265-B	Cummins	V140	Towmotor	VT8-430-B	Cummins
V8-265-C	Cummins	V150	Caterpillar	VT8-430-BI	Cummins
V8-265-P	Cummins	V160	Caterpillar	VT8-430-CI	Cummins
V8-350-B	Cummins	V160	Towmotor	VT8-460-BI	Cummins
V8-350-BI	Cummins	V160B	Caterpillar	VT12-600	Cummins
V8-350-CI	Cummins	V160D	Caterpillar	VT12-700	Cummins
V8-350-IP	Cummins	V160E	Caterpillar	VT28	Cummins
V8E-170	Cummins	V160HF	Caterpillar	VT48	Bomag
V8E-235	Cummins	V180	Caterpillar	VT1710-C635	Cummins
V8E-235-B	Cummins	V180	Towmotor	VT-12	Cummins
V8R-220-C	Cummins	V180B	Caterpillar	VT-903	Cummins
V10 Roustabout	Hughes-Keenan	V180E	Caterpillar	VT-1710-P635	Cummins
		V180HF	Caterpillar	VT Series	Volvo

Model and Manufacturer Index

Indexes
& Abbrev.

Model	Manufacturer	Model	Manufacturer	Model	Manufacturer
V - Continued		W - Continued		X	
VTA28.....	Cummins	WA150.....	Komatsu	XKL 10.....	Thermo King
VTA-1710-B700.....	Cummins	WA180.....	Komatsu	XKL 10LT.....	Thermo King
VTA-1710-C700.....	Cummins	WA250.....	Komatsu	XKL 20.....	Thermo King
VTA-1710-C800.....	Cummins	WA250-5.....	Komatsu	XKL 20LT.....	Thermo King
VTA-1710-P700.....	Cummins	WA320.....	Komatsu	XKL 30.....	Thermo King
VTA-1710-P800.....	Cummins	WA320-5.....	Komatsu	XKL 30LT.....	Thermo King
W		WA350.....	Komatsu	XKL 50.....	Thermo King
W5.....	Case	WA380.....	Komatsu	XKL 50LT.....	Thermo King
W5A.....	Case	WA380-6.....	Komatsu	XKW.....	Thermo King
W7.....	Case	WA600.....	Komatsu	XMD.....	Thermo King
W7E.....	Case	Warrior.....	Dresser-Galion	XMD 30.....	Thermo King
W8B.....	Case	WB140-2N.....	Komatsu	XMD 50.....	Thermo King
W8C.....	Case	WB146PS.....	Komatsu	XMD 50D.....	Thermo King
W8E.....	Case	WB156PS.....	Komatsu	XMD-I.....	Thermo King
W9.....	Case	WBD.....	Gardner-Denver	XMT.....	Thermo King
W9A.....	Case	WBG.....	Gardner-Denver	XNWD.....	Thermo King
W9B.....	Case	WBH.....	Gardner-Denver	XNWD 30.....	Thermo King
W9E.....	Case	WBK.....	Gardner-Denver	XNWE 100.....	Thermo King
W10.....	Case	WC20.....	Mobilift	XP750.....	Ingersoll
W10B.....	Case	WC25.....	Mobilift	XP750WJD.....	Ingersoll
W10E.....	Case	WC30.....	Mobilift	Xpeditor.....	Volvo
W11B.....	Case	WC35.....	Mobilift	XROL 10.....	Thermo King
W12.....	Case	WC40.....	Mobilift	XROL 10HT.....	Thermo King
W12.....	Gerlinger	WC45.....	Mobilift	XROL 20.....	Thermo King
W14.....	Case	WC50.....	Mobilift	XROL 20HT.....	Thermo King
W14B.....	Case	WC55.....	Mobilift	XROL 30.....	Thermo King
W15.....	Gerlinger	WC60.....	Mobilift	XROL 30HT.....	Thermo King
W16.....	Gerlinger	WCA Series.....	Volvo	XROL 30 M5.....	Thermo King
W18.....	Case	WG Series.....	Volvo	XROL 50.....	Thermo King
W18.....	Gerlinger	WGH.....	Gardner-Denver	XROL 50HT.....	Thermo King
W18B.....	Case	WH105GB.....	Gardner-Denver	XROL 50 M5.....	Thermo King
W20.....	Case	WH105GC.....	Gardner-Denver	XRW.....	Thermo King
W20.....	Gerlinger	WH105GJ.....	Gardner-Denver	XRW 20D.....	Thermo King
W20B.....	Case	WH105GK.....	Gardner-Denver	XRWL.....	Thermo King
W20C.....	Case	WH105GP.....	Gardner-Denver	XUK 50 M4.....	Thermo King
W22.....	Gerlinger	WH105GQ.....	Gardner-Denver	Y	
W22.....	Workhorse	WH315G.....	Gardner-Denver	Y20WO.....	Taylor
W24B.....	Case	WH600.....	Gardner-Denver	Y30.....	Clark
W24C.....	Case	WHD.....	Gardner-Denver	Y40.....	Clark
W26B.....	Case	WHF.....	Gardner-Denver	Y50.....	Clark
W30.....	Case	WHHDA.....	Gardner-Denver	Y235.....	Clark
W36.....	Case	WHHDB.....	Gardner-Denver	Y355.....	Clark
W42.....	Workhorse	WHHDC.....	Gardner-Denver	Y355PD.....	Clark
W62.....	Workhorse	WHHDD.....	Gardner-Denver	Y685.....	Clark
W201.....	Allis-Chalmers	WHK.....	Gardner-Denver	Y1425.....	Clark
W226.....	Allis-Chalmers	WHL.....	Gardner-Denver	Y1625.....	Clark
W900.....	Kenworth	WHX.....	Gardner-Denver	Y1830.....	Clark
W3500.....	Chevrolet	WIA Series.....	Volvo	Y2030.....	Clark
W3500.....	GMC	Windjammer 500.....	Thermo King	YC38.....	Link-Belt
W4500.....	Chevrolet	WN300.....	P & H	YT30.....	Ottawa
W4500.....	GMC	WorkStar 7300.....	International/Navistar	YT50.....	Ottawa
W5500.....	Chevrolet	WorkStar 7400.....	International/Navistar	Z	
W5500.....	GMC	WorkStar 7500.....	International/Navistar	Z90A.....	Hyster
W5500HD.....	Chevrolet	WorkStar 7600.....	International/Navistar	ZL602.....	Zettlemeyer
W5500HD.....	GMC	WorkStar 7700.....	International/Navistar		
WA30.....	Komatsu	WPI430.....	Wisconsin		
WA40.....	Komatsu	WT5500.....	Chevrolet		
WA70.....	Komatsu	WT5500.....	GMC		
WA100.....	Komatsu	WX.....	Autocar		
WA120.....	Komatsu	WXLL.....	Autocar		

Abbreviations

A.	Amperes	Exc.	Except	Nom.	Nominal
A.C.	Air Conditioning	Exch.	Exchanger	O.C.	Outside Circumference
A.P.	Air Pump	Ext.	External	O.D.	Outside Diameter
A.T.F.	Automatic Transmission Fluid	F.	Fahrenheit	O.H.C.	Overhead Cam
ABDS	Accessory Belt Drive System	Fed.	Federal	O.H.V.	Overhead Valve
Accy.	Accessory	FHP	Fractional Horse Power	OE	Original Equipment
Adj.	Adjustable	FWD	Front Wheel Drive	OEM	Original Equipment Manufacturer
Adjmt.	Adjustment	Ft.	Foot (Feet)	P.S.	Power Steering
ADP	Alternator Decoupler Pulley	G.V.W.	Gross Vehicle Weight	P.T.O.	Power Take-Off
Air-Hyd.	Air Over Hydraulic	Gal.	Gallon	Pass.	Passenger
Almm.	Aluminum	Gas	Gasoline	PCV	Positive Crankcase Ventilation
Alt.	Alternator	Gen.	Generator	Perf.	Performance
Assy.	Assembly	GM	General Motors	Pkg.	Package
Auto.	Automatic	GMC	General Motors Corporation	Prod.	Production
Aux.	Auxiliary	Gov.	Governor	Pt. No.	Part Number
AWD	All Wheel Drive	H.D.	Heavy Duty	R.P.M.	Revolutions per Minute
B.B.C.	Bumper To Back Of Cab	H.O.	High Output	Rad. (Rads.)	Radiator(s)
Bbl.	Barrel	H.P.	Horsepower	Rec.	Recreational
Brkt	Bracket	Hemi.	Hemispherical	Repl.	Replacement
C.	Celsius	Hi Perf.	High Performance	RWD	Rear Wheel Drive
C.I.D.	Cubic Inch Displacement	Horiz.	Horizontal	S.P.	Steering Pump
C.O.E.	Cab Over Engine	Hyd.	Hydraulic	SBDS	Synchronous Belt Drive System
C.S.	Crankshaft	Hydra.	Hydramatic	Ser.	Serial
Calif.	California	Hydro.	Hydrostatic	SHO	Super High Output
Cam.	Camshaft	Hz	Hertz	SOHC	Single Overhead Cam
Carb.	Carburetor	I.C.	Inside Circumference	Spec.	Special
Cat.	Caterpillar	I.D.	Inside Diameter	Sq.	Square
CC (cc)	Cubic Centimeter(s)	ID	Identification	Std.	Standard
CDC	Consolidated Diesel Corporation	In.	Inch (Inches)	Stg.	Steering
Chry.	Chrysler	Inc.	Increased	Strt.	Straight
Circ.	Circumference	Incl.	Includes	Susp.	Suspension
CNG	Compressed Natural Gas	Ind.	Industrial	SVT	Special Vehicle Teams
Co.	Company	Inj.	Injection	T.W.	Top Width
Comm.	Commercial	Inst.	Installed	Temp.	Temperature
Compr.	Compressor	Install.	Installation	Trans.	Transmission
Cond.	Conditioning(er)	J.S.	Jack Shaft	Trlr.	Trailer
Conv.	Conventional	L	Litre	Trk.	Truck
Cool.	Cooling	L.C.F.	Low Cab Forward	TSB	Technical Service Bulletin
Corp.	Corporation	L.C.I.	Low Cut-In	Turbo	Turbocharged
Cu.	Cubic	L.D.	Light Duty	V.	Volts
Cust.	Custom	Lb. (Lbs.)	Pound(s)	V.P.	Vacuum Pump
CVT	Continuously Variable Transmission	Limo	Limousine	V.S.	Variable Speed
Cyl.	Cylinder	LPG	Liquid Petroleum Gas	Vac.	Vacuum
DEF	Diesel Emissions Fluid	m	Meters	Vert.	Vertical
Deg.	Degree	M.D.	Medium Duty	VIN	Vehicle Identification Number
Dia.	Diameter	Mach.	Machine	VIO	Vehicles in Operation
Dlr.	Dealer	Man.	Manual	VTEC	Variable Valve Timing & Lift Electronic Control
DOHC	Dual Overhead Cam	Max.	Maximum	W/	With
DOT	Department of Transportation	Mech.	Mechanical	W/O	Without
DPFE	Differential Pressure Feedback EGR	Mfg.	Manufacturing	W.	Watts
E.E.C.	Evaporative Emission Control	Mfr.	Manufacturer	W.B.	Wheelbase
E.G.R.	Exhaust Gas Recirculation	MHz	Megahertz	W.P.	Water Pump
EBS	Electronic Braking System	Min.	Minimum	X.C. (XC)	Extra Cooling
Elec.	Electric	mm	Millimeter	2WD	2 Wheel Drive
Eng.	Engine	MPI	Multi-Port Injection	4WD	4 Wheel Drive
EPDM	Ethylene Propylene Diene Monomer	Mtd.	Mounted	4WS	4 Wheel Steering
Equip.	Equipped, Equipment	Mtr.	Motor		
Evap.	Evaporative	No.	Number		

Belts and Coolant Hose for Medium/Heavy-Duty Trucks (2001 & Newer)

Order Belts and Hose by Our Number. Manufacturers' Part Number is shown for reference only.

Application	Mfr. Part No.	Our No.	Application	Mfr. Part No.	Our No.
American LaFrance			Autocar		
2009			2009		
Cummins ISL Diesel			Cummins ISL Diesel		
Condor			WXLL		
Tensioner Assy.	3973819	38627	Tensioner Assy. - Fan	3973819	38627
Idler Pulley	3970945	36283	Idler Pulley	3970945	36283
Hose - Lower - Rad. To Cooler		24210	Cummins ISM Diesel		
2008			ACX Xpeditor; WX; WXLL		
Cummins ISL Diesel			Belt - A.C.		
Condor			Belt - Fan & Alt.		
Hose - Lower - Rad. To Cooler		24210	Tensioner Assy. - A.C.	4004824	▲K060539HD
Cummins ISM Diesel			Tensioner Assy. - Fan & Alt.		
Condor			Tensioner Assy. - Fan & Alt.		
Belt - Alt.	4941258	K080661A	Idler Pulley - A.C.	3102888	38505
Tensioner Assy.	4920105	38622	Idler Pulley - Fan & Alt.	4920105	38622
Idler Pulley - Alt.	3400883	36308	Idler Pulley - A.C.	3104139	36225
Detroit Diesel 6-Cyl. 14.0 L Diesel			Idler Pulley - Fan & Alt.		
Eagle			Hose - Upper - Eng. To Pipe		
Belt - Serpentine - Fan	0124894009	K100529HD	Hose - Upper - Pipe To Rad.	3400883	36308
Belt - Serpentine - Alt. & A.C.	0124587006	▲K080570HD	Hose - Lower - Eng. To Pipe		≈24640
Tensioner Assy. - Alt.	0127425000	38501	Hose - Lower - Pipe To Heat Exch.		≈24636
Tensioner Assy. - Fan	0127846000	38503	Hose - Lower - Eng. To Pipe		≈24640
Hose - Lower - Pipe To Eng.		24257	Hose - Lower - Pipe To Heat Exch.		≈21194
Hose - Lower - Rad. To Cooler		24210	Hose - Lower - Heat Exch. To Rad.		≈21194
Hose - Cold Side	0129021000	29002	2008		
2007			Cummins ISL Diesel		
Cummins ISL Diesel			WX		
Condor			Belt - Serpentine - Accessory Drive		
Tensioner Assy.	3976831	38516	Tensioner Assy.	A2080106-001	▲K080926HD
Hose - Lower - Rad. To Cooler		24210	Idler Pulley	3973819	38627
Eagle			Idler Pulley		
Belt - Serpentine - Alt. & W.P.	3290018	▲K080716HD	Hose - Upper - Eng. To Pipe	3970945	36283
Tensioner Assy.	3976831	38516	Hose - Lower - Eng. To Pipe		23547
Detroit Diesel 6-Cyl. 14.0 L Diesel			Hose - Lower - Eng. To Pipe		
Eagle			Cummins ISM Diesel		
Belt - Serpentine - Fan	0124894009	K100529HD	WX; WXLL		
Tensioner Assy. - Alt.	0127425000	38501	Belt - Fan, Alt. & W.P.		
Tensioner Assy. - Fan	0127846000	38503	Belt - Fan, Alt. & W.P.		
Hose - Lower - Rad. To Cooler		24210	Tensioner Assy. - Fan, W.P. & Alt.		
Hose - Lower - Pipe To Eng.		24257	Tensioner Assy. - A.C.		
Hose - Cold Side	0129021000	29002	Idler Pulley - A.C.		
2006 - 2005			Idler Pulley - Fan & Alt.		
Detroit Diesel 6-Cyl. 14.0 L Diesel			Hose - Upper - Eng. To Pipe		
Eagle			Hose - Upper - Pipe To Rad.		
Belt - Serpentine - Fan	0124894009	K100529HD	Hose - Lower - Eng. To Pipe		
Tensioner Assy. - Alt.	0127425000	38501	Hose - Lower - Pipe To Heat Exch.		
Tensioner Assy. - Fan	0127846000	38503	Hose - Lower - Heat Exch. To Rad.		
Hose - Lower - Rad. To Cooler		24210	2007		
Hose - Lower - Pipe To Eng.		24257	Cummins ISL Diesel		
Hose - Cold Side	0129021000	29002	WX		
2004 - 2003			Belt - Fan, Alt. & A.C.		
Detroit Diesel 6-Cyl. 14.0 L Diesel			Tensioner Assy. - Fan, Alt. & A.C.		
Eagle			Hose - Upper - Eng. To Pipe		
Hose - Cold Side			Hose - Lower - Eng. To Pipe		
	0129021000	29002	Hose - Lower - Rad. To Pipe; 90 Deg. Bend Hose		
			21194		
			2006		
			Cummins ISC Diesel		
			WX		
			Belt - Fan To Alt. & A.C.		
			Tensioner Assy. - Alt. & A.C.		
			Cummins ISL Diesel		
			WX		
			Belt - Fan, Alt. & A.C.		
			Tensioner Assy. - Fan, Alt. & A.C.		
			Hose - Upper - Eng. To Pipe		
			Hose - Lower - Eng. To Pipe		
			Hose - Lower - Rad. To Pipe; 90 Deg. Bend Hose		
			21194		

Medium & Heavy-Duty Trucks
(2001 & Newer)

▲Standard Belt Available.

≈Cut to Fit.

Belts and Coolant Hose for Medium/Heavy-Duty Trucks (2001 & Newer)

Medium & Heavy-Duty Trucks (2001 & Newer)

Application	Mfr. Part No.	Our No.	Application	Mfr. Part No.	Our No.
Autocar - Continued			Chevrolet - Continued		
2006 - Continued			2010 - Continued		
Cummins ISM Diesel			GM V-8 6.6 L Diesel - Continued		
WX			Express 4500 - Continued		
Belt - Fan, Alt. & W.P.	3401283	♣K060516HD	Idler Pulley - Smooth; W/A.C.; W/Dual Alts.	98072072	Ⓢ36310
Belt - A.C.	4004824	♣K060539HD	Idler Pulley - Grooved; W/O A.C.	12634218	36177
Tensioner Assy. - Fan, W.P. & Alt.	4920105	38622	Hose - Upper		23141
Tensioner Assy. - A.C.	3102888	38505	Hose - Lower		23259
2003			Hose - Heater To Valve; Cut at 11"		28411
Cummins ISM Diesel			Hose - Valve To Lower Rad. Hose		19493
WX			Hose - Valve To Pipe-1		19492
Belt - Fan	3081862	♣K080585HD	Hose - Pipe-1 To Tee		≈18081
Belt - Hub & Alt.	3020251	♣K050345HD	Hose - Valve To Heater; Cut at 9"		28412
Belt - Hub & A.C.	800347	♣9560HD	Hose - Rad. To Reservoir; Cut at 9"		28409
Hose - Upper - Eng. To Rad.		24240	Isuzu 4HK1-TC Diesel		
Hose - Upper - Rad. To Pipe		24240	W3500; W5500; W5500HD		
Hose - Lower - Eng. To Pipe		24240	Belt - Fan & Alt.	8980031870	K070404HD
Hose - Lower - Rad. To Pipe		24248	Belt - A.C.	8980108410	♣9650HD
Caterpillar			2009		
2013			Caterpillar C7 Diesel		
Caterpillar CT13 Diesel			C6500; C7500; C8500		
CT660			Belt - Fan, A.C., Alt. & W.P.	12605194	♣K080810HD
Belt - Fan		♣K080733HD	Tensioner Assy. - Fan, A.C., Alt. & W.P.	15170283	38586
Hose - Upper - Rad. To Pipe		≈24640	GM V-8 6.0 L		
Chevrolet			W3500; W4500		
2013			Belt - A.C.; Installation Tool Required	12603509	K040355SF
GM V-8 6.0 L			Belt - Fan, Alt. & P.S.	8980361660	♣K061010HD
Express 4500			Belt - Stretch Fit Belt Installation Tool		91030
Belt - Serpentine - Fan	12637204	♣K060930HD	Tensioner Assy. - Fan, Alt. & P.S.	12609719	39083
Belt - A.C.; Installation Tool Required	19210691	K040355SF	GM V-8 6.6 L Diesel		
Tensioner Assy.	12609719	39083	C4500; C5500		
Idler Pulley	12580771	36299	Belt - Fan, Alt., P.S. & A.C.	98035629	♣K061203HD
Hose - Upper		23383	Tensioner Assy. - Fan, Alt., P.S. & A.C.	97329062	38172
Hose - Lower		23127	Idler Pulley - Lower (Smooth)	98072072	36310
2012 - 2011			Idler Pulley - Upper (Smooth)	98072072	36310
GM V-8 6.6 L Diesel			GM V-8 8.1 L		
Express 4500			C4500; C5500		
Belt - Serpentine; W/Single Alt.	98064080	♣K061177HD	Belt - Fan, Alt., P.S. & A.C.	12617797	♣K061000HD
Belt - Serpentine; W/Dual Alts.	98064079	♣K061360HD	Tensioner Assy. - Fan, Alt., P.S. & A.C.	12581203	38258
Tensioner Assy.; Plastic Pulley	98094201	39159	Idler Pulley - Fan, Alt. & A.C.	12580771	36299
Tensioner Assy.; Steel Pulley; Improved Design		39242	Hose - Upper		22769
Idler Pulley - Smooth; W/A.C.; W/Single			Hose - Lower		22770
Alt.	98072072	Ⓢ36310	C6500; C7500; C8500		
Idler Pulley - Smooth; W/A.C.; W/Dual Alts.	98072072	Ⓢ36310	Belt - Fan, Alt., P.S. & A.C.	12617797	♣K061000HD
Idler Pulley - Grooved; W/O A.C.	12634218	36177	Tensioner Assy. - Fan, Alt., P.S. & A.C.	12581203	38258
Hose - Upper		23141	Idler Pulley - Fan, Alt. & A.C.	12580771	36299
Hose - Lower		23259	Isuzu 4HK1-TC Diesel		
Hose - Heater To Valve; Cut at 11"		28411	W3500; W5500; W5500HD		
Hose - Valve To Lower Rad. Hose		19493	Belt - Fan & Alt.	8980031870	K070404HD
Hose - Valve To Pipe-1		19492	Belt - A.C.	8980108410	♣9650HD
Hose - Pipe-1 To Tee		≈18081	Isuzu 6HK1-TC Diesel		
Hose - Valve To Heater; Cut at 9"		28412	C6500; C7500; C8500		
Hose - Rad. To Reservoir; Cut at 9"		28409	Belt - Fan, Alt. & A.C.	15020893	♣K070786HD
2010			Belt - W.P.	1136714641	TR22461
GM V-8 6.6 L Diesel			Tensioner Assy. - Fan, Alt. & A.C.	12597859	38548
Express 4500			Idler Pulley - Fan, Alt. & A.C.	89022559	36096
Belt - Serpentine; W/Single Alt.	98064080	♣K061177HD	Hose - Upper - Eng. To Rad.		22767
Belt - Serpentine; W/Dual Alts.	98064079	♣K061360HD	Hose - Lower - Eng. To Rad.		22768
Tensioner Assy.; Plastic Pulley	98094201	39159	2008		
Tensioner Assy.; Steel Pulley; Improved Design		39242	Caterpillar C7 Diesel		
Idler Pulley - Smooth; W/A.C.; W/Single			C6500; C7500; C8500		
Alt.	98072072	Ⓢ36310	Belt - Fan, A.C., Alt. & W.P.	12605194	♣K080810HD

♣Standard Belt Available.
ⓈTwo Required.

≈Cut to Fit.
ⓈThree Required.

Belts and Coolant Hose for Medium/Heavy-Duty Trucks (2001 & Newer)

Application	Mfr. Part No.	Our No.	Application	Mfr. Part No.	Our No.
Chevrolet - Continued			Chevrolet - Continued		
2008 - Continued			2007 - Continued		
Caterpillar C7 Diesel - Continued			GM V-8 6.0 L - Continued		
C6500; C7500; C8500 - Continued			W3500; W4500 - Continued		
Tensioner Assy. - Fan, A.C., Alt. & W.P.	15170283	38586	Belt - A.C.	12576447	▲K040378HD
GM V-8 6.6 L Diesel			Tensioner Assy. - Alt. & P.S.	12580162	38158
C4500			Tensioner Assy. - A.C.	12580196	38159
Belt - Fan, Alt., P.S. & A.C.; W/Single Alt. ...	98035629	▲K061203HD	Tensioner Pulley - Alt. & P.S.	12580162	38009
Belt - Fan, Alt., P.S. & A.C.; W/Dual Alts.;			Tensioner Pulley - A.C.	12580196	36169
OE Exact; Aramid	98034045	K061380A	Hose - Upper - Eng. To Rad.		23098
Belt - Fan, Alt., P.S. & A.C.; W/Dual Alts.;			Hose - Lower - Eng. To Rad.		23097
Optional Belt	98034045	K061380	GM V-8 6.6 L Diesel		
Tensioner Assy. - W/Dual 105A. Alts.	8973290620	38172	C4500; C5500		
Idler Pulley; W/Dual 105A. Alts.	98072072	36310	Belt - Fan, Alt., P.S. & A.C.; W/105A. Alt. ...	97300654	▲K061187HD
Idler Pulley; W/Flat Idler Pulley	97209546	36310	Belt - Fan, Alt., P.S. & A.C.; W/150A. Alt. ...	97300656	▲K061195HD
Idler Pulley; W/O A.C.	14102597	36177	Belt - Fan, Alt., P.S. & A.C.; W/Dual 105A.		
Tensioner Pulley	8973290620	36239	Alts.	97300655	▲K061360HD
C5500			Tensioner Assy.	8973290620	38172
Belt - Fan, Alt., P.S. & A.C.	98035629	▲K061203HD	Idler Pulley; W/Flat Idler Pulley	97209546	36310
Tensioner Assy.	8973290620	38172	Idler Pulley; W/O A.C.	14102597	36177
Idler Pulley; W/Flat Idler Pulley	97209546	36310	Tensioner Pulley	8973290620	36239
Idler Pulley; W/O A.C.	14102597	36177	Hose - Upper - Eng. To Rad.		22763
Tensioner Pulley	8973290620	36239	GM V-8 8.1 L		
GM V-8 8.1 L			C4500; C5500		
C4500; C5500			Belt - Fan, Alt., P.S. & A.C.; W/105A. Alt. ...	12576755	▲K061140HD
Belt - Fan, Alt., P.S. & A.C.	12576754	▲K060994HD	Belt - Fan, Alt., P.S. & A.C.; W/150A. Alt. ...	12576754	▲K060994HD
Tensioner Assy. - Fan, Alt., P.S. & A.C.	12581203	38258	Belt - Fan, Alt. & P.S.; W/105A. Alt.; W/O		
Idler Pulley	12580771	36299	A.C.	12576752	▲K061058HD
Tensioner Pulley	12581203	38006	Belt - Fan, Alt. & P.S.; W/150A. Alt.; W/O		
Hose - Upper		22769	A.C.	12576751	▲K060910HD
Hose - Lower		22770	Tensioner Assy.	12581203	38258
C6500; C7500; C8500			Idler Pulley - Smooth	12580771	36299
Belt - Fan, Alt., P.S. & A.C.	15768485	▲K071247HD	Idler Pulley - Grooved; W/O A.C.	12580774	38008
Belt - Fan, Alt. & P.S.; W/O A.C.	15021740	▲K071056HD	Tensioner Pulley	12581203	38006
Belt - Air Compr.	15074400	▲K040745HD	Hose - Upper - Eng. To Rad.		22769
Tensioner Assy. - Fan, Alt., P.S. & A.C.	15021742	38256	Hose - Lower - Eng. To Rad.		22770
Tensioner Pulley - Fan, Alt., P.S. & A.C.	15021742	38033	C6500		
Tensioner Pulley - Fan & Air Compr.	15001551	38006	Belt - Fan, Alt., P.S. & A.C.	15021740	▲K071056HD
Hose - Upper		22769	Belt - Fan, Alt. & P.S.; W/O A.C.	15021740	▲K071056HD
Isuzu 4HK1-TC Diesel			Belt - Air Compr.	15074400	▲K040745HD
W3500; W4500; W5500; W5500HD			Tensioner Assy. - Fan, Alt., P.S. & A.C.	15021742	38256
Belt - Fan & Alt.	98003187	K070404HD	Tensioner Pulley - Fan, Alt., P.S. & A.C.	15021742	38033
Belt - A.C.	8980108410	▲9650HD	Tensioner Pulley - Fan & Air Compr.	15001551	38006
Isuzu 6HK1-TC Diesel			Hose - Upper - Eng. To Rad.		22854
C6500; C7500; C8500			Hose - Lower - Eng. To Rad.		22771
Belt - Fan, Alt. & A.C.	15020893	▲K070786HD	C7500; C8500		
Belt - W.P.	1136714641	TR22461	Belt - Fan, Alt., P.S. & A.C.	15768485	▲K071247HD
Tensioner Assy. - Fan, Alt. & A.C.	12597859	38548	Belt - Fan, Alt. & P.S.; W/O A.C.	15021740	▲K071056HD
Idler Pulley - Fan, Alt. & A.C.	89022559	36096	Belt - Air Compr.	15074400	▲K040745HD
Hose - Upper - Eng. To Rad.		22767	Tensioner Assy. - Fan, Alt., P.S. & A.C.	15021742	38256
Hose - Lower - Eng. To Rad.		22768	Tensioner Pulley - Fan, Alt., P.S. & A.C.	15021742	38033
T6500; T7500; T8500			Tensioner Pulley - Fan & Air Compr.	15001551	38006
Belt - Fan, Alt. & A.C.	15065874	▲K080726HD	Hose - Upper - Eng. To Rad.		22854
Tensioner Assy. - Fan, Alt. & A.C.	15098394	38579	Hose - Lower - Eng. To Rad.		22771
Hose - Upper - Eng. To Rad.		22855	Isuzu 4HK1-TC Diesel		
2007			W3500; W4500; W5500; W5500HD		
Caterpillar C7 Diesel			Belt - Fan & Alt.	8971801811	②▲9420HD
C6500; C7500; C8500			Belt - Alt. & A.C.	8971801832	▲9620HD
Belt - Fan, Alt. & A.C.	15170173	▲K080806HD	Hose - Upper - Eng. To Rad.		23096
Tensioner Assy. - Fan, Alt. & A.C.	15170283	38586	Hose - Lower - Eng. To Rad.		23095
Idler Pulley	89022559	36096	Isuzu 6HK1-TC Diesel		
GM V-8 6.0 L			C6500; C7500; C8500		
W3500; W4500			Belt - Fan, Alt. & A.C.	15020893	▲K070786HD
Belt - Fan, Alt. & P.S.	12576754	▲K060994HD	Belt - P.S. & W.P.	97730199	TR22461
			Hose - Upper - Eng. To Rad.		22767
			Hose - Lower - Eng. To Rad.		22768

▲Standard Belt Available.

②Two Required.

Medium & Heavy-Duty Trucks
(2001 & Newer)

Belts and Coolant Hose for Medium/Heavy-Duty Trucks (2001 & Newer)

**Medium & Heavy-Duty Trucks
(2001 & Newer)**

Application	Mfr. Part No.	Our No.	Application	Mfr. Part No.	Our No.
Chevrolet - Continued			Chevrolet - Continued		
2007 - Continued			2006 - Continued		
Isuzu 6HK1-TC Diesel - Continued			Isuzu 4HK1-TC Diesel - Continued		
T6500; T7500; T8500			W3500; W4500; W5500; W5500HD - Continued		
Belt - Fan, Alt. & A.C.	15065874	♣K080726HD	Belt - Alt. & A.C.	8971801832	♣9620HD
Belt - Fan & Alt.	15065875	♣K080550HD	Hose - Upper - Eng. To Rad.		23096
Tensioner Assy. - Fan, Alt. & A.C.	15098394	38579	Hose - Lower - Eng. To Rad.		23095
Hose - Upper - Eng. To Rad.		22855			
Hose - Lower - Eng. To Rad.		22856			
2006			Isuzu 6HK1-TC Diesel		
Caterpillar C7 Diesel			C6500; C7500; C8500		
C6500; C7500; C8500			Belt - Fan, Alt. & A.C.	15020893	♣K070786HD
Belt - Fan, Alt. & A.C.	15170173	♣K080806HD	Belt - P.S. & W.P.	97730199	TR22461
Tensioner Assy. - Fan, Alt. & A.C.	15170283	38586	Tensioner Assy.	15008841	38548
Idler Pulley	89022559	36096	Hose - Upper - Eng. To Rad.		22767
Hose - Upper - Eng. To Rad.		23087	Hose - Lower - Eng. To Rad.		22768
Hose - Lower - Eng. To Rad.		23088			
GM V-8 6.0 L			T6500; T7500; T8500		
W3500; W4500			Belt - Fan, Alt. & A.C.	15065874	♣K080726HD
Belt - Fan, Alt. & P.S.	12576754	♣K060994HD	Belt - Fan & Alt.	15065875	♣K080550HD
Belt - A.C.	12576447	♣K040378HD	Tensioner Assy. - Fan, Alt. & A.C.	15098394	38579
Tensioner Assy. - Alt. & P.S.	12580162	38158	Hose - Upper - Eng. To Rad.		22855
Tensioner Assy. - A.C.	12580196	38159	Hose - Lower - Eng. To Rad.		22856
Idler Pulley	12580771	36299			
Tensioner Pulley - Alt. & P.S.	12580162	38009			
Tensioner Pulley - A.C.	12580196	36169			
Hose - Upper - Eng. To Rad.		23098			
Hose - Lower - Eng. To Rad.		23097			
GM V-8 6.6 L Diesel			2005		
C4500; C5500			Caterpillar C7 Diesel		
Belt - Fan, Alt., P.S. & A.C.; W/105A. Alt. ...	97300654	♣K061187HD	C6500; C7500; C8500		
Belt - Fan, Alt., P.S. & A.C.; W/150A. Alt. ...	97300656	♣K061195HD	Belt - Fan, Alt. & A.C.	15170173	♣K080806HD
Belt - Fan, Alt., P.S. & A.C.; W/Dual 105A. Alts.	97300655	♣K061360HD	Tensioner Assy. - Fan, Alt. & A.C.	15170283	38586
Tensioner Assy.	97288625	38172	Idler Pulley	89022559	36096
Idler Pulley; W/Flat Idler Pulley	97209546	36310	Hose - Upper - Eng. To Rad.; W/O H.D. Cool.		23087
Idler Pulley; W/O A.C.	14102597	36177	Hose - Upper - Eng. To Rad.; W/H.D. Cool.		23099
Tensioner Pulley	97288625	36239	Hose - Lower - Eng. To Rad.		23088
Hose - Upper - Eng. To Rad.		22763			
Hose - Lower - Eng. To Rad.		22771			
GM V-8 8.1 L			GM V-8 6.0 L		
C4500; C5500			W3500; W4500		
Belt - Fan, Alt. & P.S.; W/O A.C.; W/Dual 105A. Alts.	12563074	♣K061058HD	Belt - Fan, Alt. & P.S.	12576754	♣K060994HD
Belt - Fan, Alt., P.S. & A.C.; W/Single 150A. Alt.	12563076	♣K060994HD	Belt - A.C.	12576447	♣K040378HD
Tensioner Assy.	12581203	38258	Tensioner Assy. - Alt. & P.S.	12580162	38158
Idler Pulley; W/A.C.	12580771	36299	Tensioner Assy. - A.C.	12580196	38159
Idler Pulley - Smooth; W/O A.C.	12580771	36299	Idler Pulley	12580771	36299
Idler Pulley - Grooved; W/O A.C.	12580774	38008	Tensioner Pulley - Alt. & P.S.	12580162	38009
Tensioner Pulley	12581203	38006	Tensioner Pulley - A.C.	12580196	36169
Hose - Upper - Eng. To Rad.		22769	Hose - Upper - Eng. To Rad.		23098
Hose - Lower - Eng. To Rad.		22770	Hose - Lower - Eng. To Rad.		23097
C6500; C7500; C8500			GM V-8 6.6 L Diesel		
Belt - Fan, Alt., P.S. & A.C.	15768485	♣K071247HD	C4500; C5500		
Belt - Fan, Alt. & P.S.; W/O A.C.	15021740	♣K071056HD	Belt - Fan, Alt., P.S. & A.C.; W/105A. Alt. ...	97300654	♣K061187HD
Belt - Air Compr.	15074400	♣K040745HD	Belt - Fan, Alt., P.S. & A.C.; W/150A. Alt. ...	97300656	♣K061195HD
Tensioner Assy. - Fan, Alt., P.S. & A.C.	15021742	38256	Belt - Fan, Alt., P.S. & A.C.; W/Dual 105A. Alts.	97300655	♣K061360HD
Tensioner Pulley - Fan, Alt., P.S. & A.C.	15021742	38033	Tensioner Assy.	97288625	38172
Tensioner Pulley - Fan & Air Compr.	15001551	38006	Idler Pulley; W/Flat Idler Pulley	97209546	36310
Hose - Upper - Eng. To Rad.		22854	Idler Pulley; W/O A.C.	14102597	36177
Hose - Lower - Eng. To Rad.		22771	Tensioner Pulley	97288625	36239
			Hose - Upper - Eng. To Rad.		22763
			Hose - Lower - Eng. To Rad.		22771
Isuzu 4HK1-TC Diesel			GM V-8 8.1 L		
W3500; W4500; W5500; W5500HD			C4500; C5500		
Belt - Fan & Alt.	8971801811	②♣9420HD	Belt - Fan, Alt., P.S. & A.C.; W/Single 105A. Alt.	12563075	♣K060988HD
			Belt - Fan, Alt. & P.S.; W/O A.C.; W/Single 105A. Alt.	12563072	♣K060905HD
			Belt - Fan, Alt., P.S. & A.C.; W/Dual 105A. Alts.	12563077	♣K061140HD
			Belt - Fan, Alt. & P.S.; W/O A.C.; W/Dual 105A. Alts.	12563074	♣K061058HD
			Belt - Fan, Alt., P.S. & A.C.; W/Single 150A. Alt.	12563076	♣K060994HD
			Tensioner Assy.	12581203	38258
			Idler Pulley; W/A.C.	12580771	36299

♣Standard Belt Available.

②Two Required.

Belts and Coolant Hose for Medium/Heavy-Duty Trucks (2001 & Newer)

Application	Mfr. Part No.	Our No.	Application	Mfr. Part No.	Our No.
Chevrolet - Continued			Chevrolet - Continued		
2005 - Continued			2004 - Continued		
GM V-8 8.1 L - Continued			GM V-8 6.6 L Diesel - Continued		
C4500; C5500 - Continued			C4500; C5500 - Continued		
Idler Pulley - Smooth; W/O A.C.	12580771	36299	Idler Pulley; W/O A.C.	14102597	36177
Idler Pulley - Grooved; W/O A.C.	12580774	38008	Tensioner Pulley	97288625	36239
Tensioner Pulley	12581203	38006	Hose - Upper - Eng. To Rad.		22763
Hose - Upper - Eng. To Rad.		22769	Hose - Lower - Eng. To Rad.		22771
Hose - Lower - Eng. To Rad.		22770	GM V-8 8.1 L		
C6500; C7500; C8500			C4500; C5500		
Belt - Fan, Alt., P.S. & A.C.	15768485	♣K071247HD	Belt - Fan, Alt., P.S. & A.C.; W/Single		
Belt - Fan, Alt. & P.S.; W/O A.C.	15021740	♣K071056HD	105A. Alt.	12563075	♣K060988HD
Belt - Air Compr.	15074400	♣K040745HD	Belt - Fan, Alt., P.S. & A.C.; W/Single		
Tensioner Assy. - Fan, Alt., P.S. & A.C.	15021742	38256	150A. Alt.	12563076	♣K060994HD
Tensioner Pulley - Fan, Alt., P.S. & A.C.	15021742	38033	Belt - Fan, Alt., P.S. & A.C.; W/Dual 105A.		
Tensioner Pulley - Fan & Air Compr.	15001551	38006	Alts.	12563077	♣K061140HD
Hose - Upper - Eng. To Rad.		22854	Belt - Fan, Alt. & P.S.; W/O A.C.; W/Single		
Hose - Lower - Eng. To Rad.		22771	105A. Alt.	12563072	♣K060905HD
Isuzu 4HK1-TC Diesel			Belt - Fan, Alt. & P.S.; W/O A.C.; W/Dual		
W3500; W4500; W5500; W5500HD			105A. Alts.	12563074	♣K061058HD
Belt - Fan & Alt.	8971801811	②♣9420HD	Tensioner Assy.	12581203	38258
Belt - Alt. & A.C.	8971801832	♣9620HD	Idler Pulley; W/A.C.	12580771	36299
Hose - Upper - Eng. To Rad.		23096	Idler Pulley - Smooth; W/O A.C.	12580771	36299
Hose - Lower - Eng. To Rad.		23095	Idler Pulley - Grooved; W/O A.C.	12580774	38008
Isuzu 6HK1-TC Diesel			Tensioner Pulley	12581203	38006
C6500; C7500; C8500			Hose - Upper - Eng. To Rad.		22769
Belt - Fan, Alt. & A.C.	15020893	♣K070786HD	Hose - Lower - Eng. To Rad.		22770
Belt - P.S. & W.P.	97730199	TR22461	C6500; C7500; C8500		
Tensioner Assy.	15008841	38548	Belt - Fan, Alt., P.S. & A.C.	15768485	♣K071247HD
Hose - Upper - Eng. To Rad.		22767	Belt - Fan, Alt. & P.S.; W/O A.C.	15021740	♣K071056HD
Hose - Lower - Eng. To Rad.		22768	Belt - Air Compr.	15074400	♣K040745HD
T6500; T7500; T8500			Tensioner Assy. - Fan, Alt., P.S. & A.C.	15021742	38256
Belt - Fan, Alt. & A.C.	15065874	♣K080726HD	Tensioner Pulley - Fan, Alt., P.S. & A.C.	15021742	38033
Belt - Fan & Alt.	15065875	♣K080550HD	Tensioner Pulley - Fan & Air Compr.	15001551	38006
Tensioner Assy. - Fan, Alt. & A.C.	15098394	38579	Hose - Upper - Eng. To Rad.		22854
Hose - Upper - Eng. To Rad.		22855	Hose - Lower - Eng. To Rad.		22771
Hose - Lower - Eng. To Rad.		22856	Isuzu 4HE1-TC Diesel		
2004			W3500; W4500; W5500		
Caterpillar C7 Diesel			Belt - Fan & Alt.	8971801811	②♣9420HD
C6500; C7500; C8500			Belt - Alt. & A.C.	8971801832	♣9620HD
Belt - Fan, Alt. & A.C.	15170173	♣K080806HD	Hose - Upper - Eng. To Rad.		23096
Tensioner Assy. - Fan, Alt. & A.C.	15170283	38586	Hose - Lower - Eng. To Rad.		23095
Idler Pulley	89022559	36096	Isuzu 6HK1-TC Diesel		
Hose - Upper - Eng. To Rad.; W/O H.D. Cool.		23087	C6500; C7500; C8500		
Hose - Upper - Eng. To Rad.; W/H.D. Cool.		23099	Belt - Fan, Alt. & A.C.	15020893	♣K070786HD
Hose - Lower - Eng. To Rad.		23088	Belt - P.S. & W.P.	97730199	TR22461
GM V-8 6.0 L			Tensioner Assy.	15008841	38548
W3500; W4500			Hose - Upper - Eng. To Rad.		22767
Belt - Fan, Alt. & P.S.		♣K060994HD	Hose - Lower - Eng. To Rad.		22768
Belt - A.C.	12576447	♣K040378HD	T6500; T7500; T8500		
Tensioner Assy. - Alt. & P.S.	12580162	38158	Belt - Fan, Alt. & A.C.	15065874	♣K080726HD
Tensioner Assy. - A.C.	12580196	38159	Belt - Fan & Alt.	15065875	♣K080550HD
Idler Pulley	12580771	36299	Tensioner Assy. - Fan, Alt. & A.C.	15098394	38579
Tensioner Pulley - Alt. & P.S.	12580162	38009	Hose - Upper - Eng. To Rad.		22855
Tensioner Pulley - A.C.	12580196	36169	Hose - Lower - Eng. To Rad.		22856
Hose - Upper - Eng. To Rad.		23098	W4500; W5500; WT5500		
Hose - Lower - Eng. To Rad.		23097	Belt - Fan & Alt.	1136714641	②TR22461
GM V-8 6.6 L Diesel			Belt - A.C.	8943951720	TR22434
C4500; C5500			Hose - Upper - Eng. To Rad.		22733
Belt - Fan, Alt., P.S. & A.C.; W/105A. Alt. ...	97300654	♣K061187HD	Hose - Lower - Eng. To Rad.		22734
Belt - Fan, Alt., P.S. & A.C.; W/150A. Alt. ...	97300656	♣K061195HD	2003		
Belt - Fan, Alt., P.S. & A.C.; W/Dual 105A.			Caterpillar 3126 Diesel		
Alts.	97300655	♣K061360HD	C6500		
Tensioner Assy.	97288625	38172	Belt - W.P.	0618384	♣9335HD
Idler Pulley; W/Flat Idler Pulley	97209546	36310	Tensioner Assy.	15083306	38557
			Idler Pulley	89022559	36096

♣Standard Belt Available.

②Two Required.

Belts and Coolant Hose for Medium/Heavy-Duty Trucks (2001 & Newer)

Medium & Heavy-Duty Trucks
(2001 & Newer)

Application	Mfr. Part No.	Our No.	Application	Mfr. Part No.	Our No.
Chevrolet - Continued			Chevrolet - Continued		
2003 - Continued			2003 - Continued		
Caterpillar 3126 Diesel - Continued			GM V-8 8.1 L - Continued		
C6500 - Continued			C4500; C5500 - Continued		
Tensioner Pulley	15083306	36091	Belt - Fan, Alt. & P.S.; W/O A.C.; W/Dual 105A. Alts.	12563074	▲K061058HD
Hose - Upper - Eng. To Rad.; W/H.D. Cool.		22764	Tensioner Assy.	12581203	38258
Hose - Upper - Eng. To Rad.; W/O H.D. Cool.		22765	Idler Pulley; W/A.C.	12580771	36299
Hose - Lower - Eng. To Rad.		22766	Idler Pulley - Smooth; W/O A.C.	12580771	36299
C7500; C8500			Idler Pulley - Grooved; W/O A.C.	12580774	38008
Belt - Fan, Alt. & A.C.	15008836	▲K070835HD	Tensioner Pulley	12581203	38006
Belt - Fan & Alt.; W/O A.C.	15043146	▲K070709HD	Hose - Upper - Eng. To Rad.		22769
Belt - W.P.	0618384	▲9335HD	Hose - Lower - Eng. To Rad.		22770
Tensioner Assy.	15083306	38557	C6500; C7500; C8500		
Idler Pulley	89022559	36096	Belt - Fan, Alt., P.S. & A.C.	15768485	▲K071247HD
Tensioner Pulley	15083306	36091	Belt - Fan, Alt. & P.S.; W/O A.C.	15021740	▲K071056HD
Hose - Upper - Eng. To Rad.; W/H.D. Cool.		22764	Belt - Air Compr.	15074400	▲K040745HD
Hose - Upper - Eng. To Rad.; W/O H.D. Cool.		22765	Tensioner Assy. - Fan, Alt., P.S. & A.C.	15021742	38256
Hose - Lower - Eng. To Rad.		22766	Tensioner Pulley - Fan, Alt., P.S. & A.C.	15021742	38033
T5500; T6500; T7500; T8500			Tensioner Pulley - Fan & Air Compr.	15001551	38006
Belt - Hub & W.P.	0366775	▲9341HD	Hose - Upper - Eng. To Rad.		22854
Belt - Fan & Alt.	15149560	▲K070553HD	Isuzu 4HE1-TC Diesel		
Belt - Fan, Alt. & A.C.	15985715	▲K070677HD	W3500; W4500; W5500		
Tensioner Assy.	15999618	38578	Belt - Fan & Alt.	8971801811	②▲9420HD
Tensioner Pulley	15999618	36091	Belt - Alt. & A.C.	8971801832	▲9620HD
Hose - Upper - Eng. To Rad.		22706	Hose - Upper - Eng. To Rad.		23096
Hose - Lower - Eng. To Rad.		22705	Hose - Lower - Eng. To Rad.		23095
GM V-8 5.7 L			Isuzu 6HK1-TC Diesel		
W3500; W4500			C6500; C7500; C8500		
Belt - Fan, Alt., P.S. & A.C.	8971106400	▲K061010HD	Belt - Fan, Alt. & A.C.	15020893	▲K070786HD
Tensioner Assy. - Fan, Alt., P.S. & A.C.	8971619590	38528	Belt - P.S. & W.P.	97730199	TR22461
Hose - Upper - Eng. To Rad.		22731	Tensioner Assy.	15008841	38548
Hose - Lower - Eng. To Rad.		22732	Hose - Upper - Eng. To Rad.		22767
GM V-8 6.0 L			Hose - Lower - Eng. To Rad.		22768
W4500			T5500; T6500; T7500; T8500; W5500; WT5500		
Belt - Fan, Alt. & P.S.		▲K060994HD	Belt - Fan & Alt.	94395171	②TR22461
Belt - A.C.	12576447	▲K040378HD	Belt - A.C.	94395172	TR22434
Tensioner Assy. - Alt. & P.S.	12580162	38158	Hose - Upper - Eng. To Rad.		22733
Tensioner Assy. - A.C.	12580196	38159	Hose - Lower - Eng. To Rad.		22734
Idler Pulley	12580771	36299	2002		
Tensioner Pulley - Alt. & P.S.	12580162	38009	Caterpillar 3126 Diesel		
Tensioner Pulley - A.C.	12580196	36169	C5500; C6500; C7500; C8500		
Hose - Upper - Eng. To Rad.		23098	Belt - W.P.	0366775	▲9341HD
Hose - Lower - Eng. To Rad.		23097	Belt - Fan & Alt.; W/O A.C.	15670937	▲K070705HD
GM V-8 6.6 L Diesel			Belt - Fan, Alt. & A.C.	15690236	▲K070733HD
C4500; C5500			Tensioner Assy.	7E3999	38509
Belt - Fan, Alt., P.S. & A.C.; W/105A. Alt. ...	97300654	▲K061187HD	Idler Pulley	89022559	36096
Belt - Fan, Alt., P.S. & A.C.; W/150A. Alt. ...	97300656	▲K061195HD	Tensioner Pulley	7E3999	36091
Belt - Fan, Alt., P.S. & A.C.; W/Dual 105A. Alts.	97300655	▲K061360HD	Hose - Upper - Eng. To Rad.; W/Conventional Hood		22032
Tensioner Assy.	97288625	38172	Hose - Upper - Eng. To Rad.; W/High Visibility Hood		22664
Idler Pulley; W/Flat Idler Pulley	97209546	36310	Hose - Lower - Eng. To Rad.		21985
Idler Pulley; W/O A.C.	14102597	36177	Hose - Heater Inlet		28442
Tensioner Pulley	97288625	36239	Hose - Heater Outlet		28441
Hose - Upper - Eng. To Rad.		22763	T5500; T6500; T7500; T8500		
Hose - Lower - Eng. To Rad.		22771	Belt - Hub & W.P.	0366775	▲9341HD
GM V-8 8.1 L			Belt - Fan & Alt.	15149560	▲K070553HD
C4500; C5500			Belt - Fan, Alt. & A.C.	15985715	▲K070677HD
Belt - Fan, Alt., P.S. & A.C.; W/Single 105A. Alt.	12563075	▲K060988HD	Tensioner Assy.	15999618	38578
Belt - Fan, Alt., P.S. & A.C.; W/Single 150A. Alt.	12563076	▲K060994HD	Tensioner Pulley	15999618	36091
Belt - Fan, Alt., P.S. & A.C.; W/Dual 105A. Alts.	12563077	▲K061140HD	Hose - Upper - Eng. To Rad.		22706
Belt - Fan, Alt. & P.S.; W/O A.C.; W/Single 105A. Alt.	12563072	▲K060905HD	Hose - Lower - Eng. To Rad.		22705
Belt - Fan, Alt. & P.S.; W/O A.C.; W/Single 150A. Alt.	12563073	▲K060910HD	GM V-8 5.7 L		
▲Standard Belt Available.			W3500; W4500		
			Belt - Fan, Alt., P.S. & A.C.	8971106400	▲K061010HD
			Tensioner Assy. - Fan, Alt., P.S. & A.C.	8971619590	38528
			Hose - Upper - Eng. To Rad.		22731
			②Two Required.		

Belts and Coolant Hose for Medium/Heavy-Duty Trucks (2001 & Newer)

Application	Mfr. Part No.	Our No.	Application	Mfr. Part No.	Our No.
Chevrolet - Continued			Chevrolet - Continued		
2002 - Continued			2001 - Continued		
GM V-8 5.7 L - Continued			GM V-8 8.1 L - Continued		
W3500; W4500 - Continued			C5500; C6500; C7500; C8500 - Continued		
Hose - Lower - Eng. To Rad.		22732	Tensioner Pulley - Fan & Air Compr.	15001551	38006
GM V-8 8.1 L			Hose - Upper - Eng. To Rad.		22678
C5500; C6500; C7500; C8500			Hose - Lower - Eng. To Rad.		22679
Belt - Fan, Alt., P.S. & A.C.	15768485	▲K071247HD	Isuzu 4HE1-TC Diesel		
Belt - Fan, Alt. & P.S.; W/O A.C.	15021740	▲K071056HD	W3500; W4500; W5500		
Belt - Fan & Air Compr.	15060753	▲K040762HD	Belt - Fan & Alt.	8971801810	②▲9415HD
Tensioner Assy. - Fan, Alt., P.S. & A.C.	15021742	38256	Belt - Alt. & A.C.	8971801830	▲9610HD
Tensioner Assy. - Fan & Air Compr.	15001551	38261	Hose - Upper - Eng. To Rad.		23096
Tensioner Pulley - Fan, Alt., P.S. & A.C.	15021742	38033	Hose - Lower - Eng. To Rad.		23095
Tensioner Pulley - Fan & Air Compr.	15001551	38006	Isuzu 6HK1-TC Diesel		
Hose - Upper - Eng. To Rad.		22678	T5500; T6500; T7500; T8500; W5500; WT5500		
Hose - Lower - Eng. To Rad.		22679	Belt - Fan & Alt.	94395171	②TR22461
Isuzu 4HE1-TC Diesel			Belt - A.C.	94395172	TR22434
W3500; W4500; W5500			Hose - Upper - Eng. To Rad.		22733
Belt - Fan & Alt.	8971801810	②▲9415HD	Hose - Lower - Eng. To Rad.		22734
Belt - Alt. & A.C.	8971801830	▲9610HD	Crane Carrier Company		
Hose - Upper - Eng. To Rad.		23096	2007		
Hose - Lower - Eng. To Rad.		23095	Caterpillar C11 Diesel		
Isuzu 6HK1-TC Diesel			Centurion		
T5500; T6500; T7500; T8500; W5500; WT5500			Belt - Fan, Alt. & A.C.		
Belt - Fan & Alt.	94395171	②TR22461			
Belt - A.C.	94395172	TR22434	Belt - Fan, Alt. & A.C.		
Hose - Upper - Eng. To Rad.		22733	Belt - Fan, Alt. & A.C.		
Hose - Lower - Eng. To Rad.		22734	Idler Pulley - Grooved		
2001			Idler Pulley - Smooth		
Caterpillar 3126 Diesel			Idler Pulley - Smooth		
C5500; C6500; C7500; C8500			Idler Pulley - Smooth		
Belt - W.P.	0366775	▲9341HD	Idler Pulley - Smooth		
Belt - Fan, Alt. & A.C.	15690236	▲K070733HD	Idler Pulley - Smooth		
Belt - Fan & Alt.; W/O A.C.	15670937	▲K070705HD	Idler Pulley - Smooth		
Tensioner Assy.	7E3999	38509	Idler Pulley - Smooth		
Idler Pulley	89022559	36096	Idler Pulley - Smooth		
Tensioner Pulley	7E3999	36091	Idler Pulley - Smooth		
Hose - Upper - Eng. To Rad.; W/Conventional Hood		22032	Idler Pulley - Smooth		
Hose - Upper - Eng. To Rad.; W/High Visibility Hood		22664	Idler Pulley - Smooth		
Hose - Lower - Eng. To Rad.		21985	Idler Pulley - Smooth		
Hose - Heater Inlet		28442	Idler Pulley - Smooth		
Hose - Heater Outlet		28441	Idler Pulley - Smooth		
T5500; T6500; T7500; T8500			Idler Pulley - Smooth		
Belt - Hub & W.P.	0366775	▲9341HD	Idler Pulley - Smooth		
Belt - Fan, Alt. & A.C.	15985715	▲K070677HD	Idler Pulley - Smooth		
Belt - Fan & Alt.; W/O A.C.	15149560	▲K070553HD	Idler Pulley - Smooth		
Tensioner Assy.	15999618	38578	Idler Pulley - Smooth		
Tensioner Pulley	15999618	36091	Idler Pulley - Smooth		
Hose - Upper - Eng. To Rad.		22706	Idler Pulley - Smooth		
Hose - Lower - Eng. To Rad.		22705	Idler Pulley - Smooth		
GM V-8 5.7 L			Idler Pulley - Smooth		
W3500; W4500			Idler Pulley - Smooth		
Belt - Fan, Alt., P.S. & A.C.	8971106400	▲K061010HD	Idler Pulley - Smooth		
Tensioner Assy. - Fan, Alt., P.S. & A.C.	8971619590	38528	Idler Pulley - Smooth		
Hose - Upper - Eng. To Rad.		22731	Idler Pulley - Smooth		
Hose - Lower - Eng. To Rad.		22732	Idler Pulley - Smooth		
GM V-8 8.1 L			Idler Pulley - Smooth		
C5500; C6500; C7500; C8500			Idler Pulley - Smooth		
Belt - Fan, Alt., P.S. & A.C.	15768485	▲K071247HD	Idler Pulley - Smooth		
Belt - Fan, Alt. & P.S.; W/O A.C.	15021740	▲K071056HD	Idler Pulley - Smooth		
Belt - Fan & Air Compr.	15060753	▲K040762HD	Idler Pulley - Smooth		
Tensioner Assy. - Fan, Alt., P.S. & A.C.	15021742	38256	Idler Pulley - Smooth		
Tensioner Assy. - Fan & Air Compr.	15001551	38261	Idler Pulley - Smooth		
Tensioner Pulley - Fan, Alt., P.S. & A.C.	15021742	38033	Idler Pulley - Smooth		

▲Standard Belt Available.

②Two Required.

Medium & Heavy-Duty Trucks
(2001 & Newer)

Belts and Coolant Hose for Medium/Heavy-Duty Trucks (2001 & Newer)

Medium & Heavy-Duty Trucks
(2001 & Newer)

Application	Mfr. Part No.	Our No.	Application	Mfr. Part No.	Our No.
Dodge - Continued			Ford		
2012 - 2011 - Continued			2016		
Cummins 6-Cyl. 6.7 L Diesel - Continued			Ford V-8 6.7 L Diesel		
Ram 4500HD; Ram 5500HD - Continued			F450 Super Duty; F550 Super Duty		
Belt - Serpentine; W/O A.C.	53041139AC	♣K081102HD	Belt - Serpentine; W/Single Alt.	CC3Z 8620 A	♣K081348HD
Tensioner Assy.	5086958AA	38285	Belt - Serpentine; W/Dual Alts.	BC3Z 8620 B	DK081403
Idler Pulley	68000833AD	36315	Tensioner Assy.	BC3Z 6B209 A	39153
Hose - Upper		23955	Fan Bracket	BC3Z 8678 D	FB1012
Hose - Lower		23956	2015		
Hose - Heater Inlet		23957	Ford V-8 6.2 L		
Hose - Heater Outlet		18641	F550 Super Duty		
Hose - Turbo To Pipe (Hot Side)	55056903AB	26235	Belt - Serpentine	BC3Z 8620 A	♣K061058HD
Hose - Pipe To Intercooler (Hot Side)		26235	Tensioner Assy.	AL3Z 6B209 A	39179
Hose - Intercooler To Pipe (Cold Side)	55056904AA	26233	Idler Pulley	AL3Z 8678 A	36491
Hose - Pipe To Engine (Cold Side)		26234	Hose - Lower - Oil Cooler To Eng.		24396
2010			Ford V-8 6.7 L Diesel		
Cummins 6-Cyl. 6.7 L Diesel			F450 Super Duty		
Ram 4500HD; Ram 5500HD			Belt - Serpentine; W/Single Alt.		
Belt - Accessory Belt Drive Kit; W/A.C.		ACK081264HD	Belt - Serpentine; W/Dual Alts.	BC3Z 8620 B	DK081403
Belt - Serpentine; W/A.C.	53041138AA	♣K081264HD	Tensioner Assy.	BC3Z 6B209 A	39153
Belt - Serpentine; W/O A.C.	53041139AA	♣K081102HD	Fan Bracket	BC3Z 8678 D	FB1012
Tensioner Assy.	5086958AA	38285	Hose - Upper		23981
Idler Pulley	68000833AD	36315	F550 Super Duty		
Hose - Upper		22892	Belt - Serpentine; W/Single Alt.		
Hose - Lower		22893	Belt - Serpentine; W/Dual Alts.		
Hose - Heater Inlet		18774	Tensioner Assy.		
Hose - Heater Outlet		♣K18710	Fan Bracket		
Hose - Turbo To Pipe (Hot Side)	55056903AB	26235	Ford V-10 6.8 L		
Hose - Pipe To Intercooler (Hot Side)		26235	F-53; F450 Super Duty; F550 Super Duty		
Hose - Intercooler To Pipe (Cold Side)	55056904AA	26233	Belt - Serpentine; W/A.C.		
Hose - Pipe To Engine (Cold Side)		26234	Belt - Serpentine; W/O A.C.		
2009			Belt - Serpentine; W/A.C.		
Cummins 6-Cyl. 6.7 L Diesel			1L2Z 6B209 AA		
Ram 4500HD; Ram 5500HD			Tensioner Assy.; W/O A.C.		
Belt - Accessory Belt Drive Kit; W/A.C.		ACK081264HD	Idler Pulley		
Belt - Serpentine; W/A.C.	53041138AA	♣K081264HD	2L3Z 6B209 CA		
Belt - Serpentine; W/O A.C.	53041139AA	♣K081102HD	1L2Z 8678 AB		
Tensioner Assy.	5086958AA	38285	2014		
Idler Pulley	68000833AD	36315	Ford V-8 5.4 L		
Hose - Upper		22892	E450 Super Duty		
Hose - Lower		22893	Belt - Serpentine; W/Factory Inst. A.C.		
Hose - Heater Inlet		18774	Belt - Serpentine; W/O A.C.		
Hose - Heater Outlet		♣K18710	Belt - Accessory Drive; W/Aftermarket A.C.		
Hose - Turbo To Pipe (Hot Side)	55056720AB	26224	Tensioner Assy.; W/A.C.		
Hose - Pipe To Intercooler (Hot Side)		26230	Idler Pulley		
Hose - Intercooler To Pipe (Cold Side)	55056696AE	26230	Hose - Upper		
Hose - Pipe To Engine (Cold Side)		26230	Hose - Lower		
2008			Hose - Heater Inlet		
Cummins 6-Cyl. 6.7 L Diesel			22614		
Ram 4500HD; Ram 5500HD			Ford V-8 6.2 L		
Belt - Accessory Belt Drive Kit; W/A.C.		ACK081264HD	F450 Super Duty		
Belt - Serpentine; W/A.C.	53041138AA	♣K081264HD	Belt - Serpentine; W/Single Alt.		
Belt - Serpentine; W/O A.C.	53041139AA	♣K081102HD	Belt - Serpentine; W/Dual Alts.		
Tensioner Assy.	5086958AA	38285	Tensioner Assy.		
Idler Pulley	68000833AD	36315	Idler Pulley		
Hose - Upper		22892	Hose - Lower - Oil Cooler To Eng.		
Hose - Lower		22893	F550 Super Duty		
Hose - Heater Inlet		18774	Belt - Serpentine		
Hose - Heater Outlet		♣K18710	Tensioner Assy.		
Hose - Turbo To Pipe (Hot Side)	55056720AB	26224	Idler Pulley		
Hose - Pipe To Intercooler (Hot Side)		26230	Hose - Lower - Oil Cooler To Eng.		
Hose - Intercooler To Pipe (Cold Side)	55056696AE	26230	Ford V-8 6.7 L Diesel		
Hose - Pipe To Engine (Cold Side)		26230	F450 Super Duty; F550 Super Duty		
2007			Belt - Serpentine; W/Single Alt.		
Cummins 6-Cyl. 6.7 L Diesel			CC3Z 8620 A		
Ram 4500HD; Ram 5500HD			DK081403		
Belt - Accessory Belt Drive Kit; W/A.C.		ACK081264HD	39179		
Belt - Serpentine; W/A.C.	53041138AA	♣K081264HD	39153		
Belt - Serpentine; W/O A.C.	53041139AA	♣K081102HD	FB1012		
Tensioner Assy.	5086958AA	38285	Ford V-8 6.7 L Diesel		
Idler Pulley	68000833AD	36315	F450 Super Duty; F550 Super Duty		
Hose - Upper		22892	Belt - Serpentine; W/Single Alt.		
Hose - Lower		22893	Belt - Serpentine; W/Dual Alts.		
Hose - Heater Inlet		18774	Tensioner Assy.		
Hose - Heater Outlet		♣K18710	Fan Bracket		
Hose - Turbo To Pipe (Hot Side)	55056720AB	26224	Belt - Serpentine; W/Single Alt.		
Hose - Pipe To Intercooler (Hot Side)		26230	Belt - Serpentine; W/Dual Alts.		
Hose - Intercooler To Pipe (Cold Side)	55056696AE	26230	Tensioner Assy.		
Hose - Pipe To Engine (Cold Side)		26230	Fan Bracket		

♣Standard Belt Available.

♣Cut to Fit.

Belts and Coolant Hose for Medium/Heavy-Duty Trucks (2001 & Newer)

Application	Mfr. Part No.	Our No.	Application	Mfr. Part No.	Our No.
Ford - Continued			Ford - Continued		
2014 - Continued			2012		
Ford V-10 6.8 L			Ford V-8 5.4 L		
E450 Super Duty			E450 Super Duty		
Belt - Serpentine; W/A.C.	BC3Z 8620 A	♣K061058HD	Belt - Serpentine; W/Factory Inst. A.C.	BC3Z 8620 A	♣K061058HD
Belt - Serpentine; W/O A.C.	BC3Z 8620 D	K060810	Belt - Serpentine; W/O A.C.	BC3Z 8620 D	K060810
Tensioner Assy.; W/A.C.	1L2Z 6B209 AA	38274	Belt - Serpentine - Solution Kit; W/Aftermarket Hybrid Drive System; W/A.C.		38274K1
Tensioner Assy.; W/O A.C.	2L3Z 6B209 CA	38329	Belt - Accessory Drive; W/Aftermarket A.C.		K061230
Idler Pulley	1L2Z 8678 AB	38001	Tensioner Assy.; W/A.C.	1L2Z 6B209 AA	38274
Hose - Upper		22315	Idler Pulley	1L2Z 8678 AB	38001
F-53			Hose - Upper		22315
Belt - Serpentine; W/A.C.	BC2Z 8620 A	♣K060997HD	Hose - Lower		23667
Belt - Serpentine; W/O A.C.	BC3Z 8620 D	K060810	Hose - Heater Inlet		22614
Tensioner Assy.; W/A.C.	1L2Z 6B209 AA	38274			
Tensioner Assy.; W/O A.C.	2L3Z 6B209 CA	38329	Ford V-8 6.7 L Diesel		
Idler Pulley	1L2Z 8678 AB	38001	F450 Super Duty; F550 Super Duty		
F450 Super Duty; F550 Super Duty			Belt - Serpentine; W/Single Alt.	CC3Z 8620 A	♣K081348HD
Belt - Serpentine; W/A.C.	BC2Z 8620 A	♣K060997HD	Belt - Serpentine; W/Dual Alts.	BC3Z 8620 B	DK081403
Belt - Serpentine; W/O A.C.	BC3Z 8620 D	K060810	Tensioner Assy.	BC3Z 6B209 A	39153
Belt - Accessory Drive; W/Deweze Hyd. Pump	740280	♣K080716HD	Fan Bracket	BC3Z 8678 C	FB1012
Tensioner Assy.; W/A.C.	1L2Z 6B209 AA	38274	Hose - Upper		23981
Tensioner Assy.; W/O A.C.	2L3Z 6B209 CA	38329			
Idler Pulley	1L2Z 8678 AB	38001	Ford V-10 6.8 L		
			E450 Super Duty		
2013			Belt - Serpentine; W/A.C.	BC3Z 8620 A	♣K061058HD
Ford V-8 5.4 L			Belt - Serpentine; W/O A.C.	BC3Z 8620 D	K060810
E450 Super Duty			Tensioner Assy.; W/A.C.	1L2Z 6B209 AA	38274
Belt - Serpentine; W/Factory Inst. A.C.	BC3Z 8620 A	♣K061058HD	Tensioner Assy.; W/O A.C.	2L3Z 6B209 CA	38329
Belt - Serpentine; W/O A.C.	BC3Z 8620 D	K060810	Idler Pulley	1L2Z 8678 AB	38001
Belt - Serpentine - Solution Kit; W/Aftermarket Hybrid Drive System; W/A.C.		38274K1	Hose - Upper		22315
Belt - Accessory Drive; W/Aftermarket A.C.		K061230	F-53; F450 Super Duty		
Tensioner Assy.; W/A.C.	1L2Z 6B209 AA	38274	Belt - Serpentine; W/A.C.	BC2Z 8620 A	♣K060997HD
Idler Pulley	1L2Z 8678 AB	38001	Belt - Serpentine; W/O A.C.	BC3Z 8620 D	K060810
Hose - Upper		22315	Belt - Accessory Drive; W/Deweze Hyd. Pump	740280	♣K080716HD
Hose - Lower		23667	Tensioner Assy.; W/A.C.	1L2Z 6B209 AA	38274
Hose - Heater Inlet		22614	Tensioner Assy.; W/O A.C.	2L3Z 6B209 CA	38329
			Idler Pulley	1L2Z 8678 AB	38001
Ford V-8 6.2 L			F550 Super Duty		
F450 Super Duty			Belt - Serpentine; W/A.C.	BC2Z 8620 A	♣K060997HD
Belt - Serpentine	BC3Z 8620 A	♣K061058HD	Belt - Serpentine; W/O A.C.	BC3Z 8620 D	K060810
Tensioner Assy.	AL3Z 6B209 A	39179	Belt - Accessory Drive; W/Deweze Hyd. Pump	740280	♣K080716HD
Idler Pulley	AL3Z 8678 A	36491	Tensioner Assy.; W/A.C.	1L2Z 6B209 AA	38274
Hose - Lower - Oil Cooler To Eng.		24396	Tensioner Assy.; W/O A.C.	2L3Z 6B209 CA	38329
			Idler Pulley	1L3Z 8678 AB	38001
Ford V-8 6.7 L Diesel			2011		
F450 Super Duty; F550 Super Duty			Cummins ISB-07 Diesel		
Belt - Serpentine; W/Single Alt.	CC3Z 8620 A	♣K081348HD	F650 Super Duty; F750 Super Duty		
Belt - Serpentine; W/Dual Alts.	BC3Z 8620 B	DK081403	Belt - Accessory Drive	BC4Z 8620 BA	♣K080830HD
Tensioner Assy.	BC3Z 6B209 A	39153			
Fan Bracket	BC3Z 8678 D	FB1012	Ford V-8 5.4 L		
			E450 Super Duty		
Ford V-10 6.8 L			Belt - Serpentine; W/Factory Inst. A.C.	BC2Z 8620 A	♣K060997HD
E450 Super Duty			Belt - Serpentine; W/O A.C.	BC3Z 8620 D	K060810
Belt - Serpentine; W/A.C.	BC3Z 8620 A	♣K061058HD	Belt - Serpentine - Solution Kit; W/Aftermarket Hybrid Drive System; W/A.C.		38274K1
Belt - Serpentine; W/O A.C.	BC3Z 8620 D	K060810	Belt - Accessory Drive; W/Aftermarket A.C.		K061230
Tensioner Assy.; W/A.C.	1L2Z 6B209 AA	38274	Tensioner Assy.; W/A.C.	1L2Z 6B209 AA	38274
Tensioner Assy.; W/O A.C.	2L3Z 6B209 CA	38329	Idler Pulley	1L2Z 8678 AB	38001
Idler Pulley	1L2Z 8678 AB	38001	Hose - Upper		22316
Hose - Upper		22315	Hose - Lower		23667
F-53; F450 Super Duty; F550 Super Duty			Hose - Heater Inlet		22614
Belt - Serpentine; W/A.C.	BC2Z 8620 A	♣K060997HD			
Belt - Serpentine; W/O A.C.	BC3Z 8620 D	K060810	Ford V-8 6.7 L Diesel		
Belt - Accessory Drive; W/Deweze Hyd. Pump	740280	♣K080716HD	F450 Super Duty; F550 Super Duty		
Tensioner Assy.; W/A.C.	1L2Z 6B209 AA	38274	Belt - Serpentine; W/Single Alt.	BC3Z 8620 C	DK081254
Tensioner Assy.; W/O A.C.	2L3Z 6B209 CA	38329	Belt - Serpentine; W/Dual Alts.	BC3Z 8620 B	DK081403
Idler Pulley	1L2Z 8678 AB	38001			

♣Standard Belt Available.

Medium & Heavy-Duty Trucks
(2001 & Newer)

Belts and Coolant Hose for Medium/Heavy-Duty Trucks (2001 & Newer)

Medium & Heavy-Duty Trucks
(2001 & Newer)

Application	Mfr. Part No.	Our No.	Application	Mfr. Part No.	Our No.
Ford - Continued			Ford - Continued		
2011 - Continued			2010 - Continued		
Ford V-8 6.7 L Diesel - Continued			Ford V-8 6.0 L Diesel - Continued		
F450 Super Duty; F550 Super Duty - Continued			E450 Super Duty - Continued		
Tensioner Assy.	BC3Z 6B209 A	39153	Hose - Pipe To Engine (Cold Side)	3C3Z 6C640 BA	26223
Fan Bracket	BC3Z 8678 C	FB1012	Ford V-8 6.4 L Diesel		
Ford V-10 6.8 L			F450 Super Duty; F550 Super Duty		
E450 Super Duty			Belt - Serpentine - Accessory Drive;		
Belt - Serpentine; W/A.C.	BC2Z 8620 A	▲K060997HD	W/Single Alt.	7C3Z 8620 E	▲K080865HD
Belt - Serpentine; W/O A.C.	BC3Z 8620 D	K060810	Belt - Serpentine - Accessory Drive;		
Tensioner Assy.	1L2Z 6B209 AA	38274	W/Dual Alts.	7C3Z 8620 F	▲K080956HD
Idler Pulley	1L2Z 8678 AB	38001	Belt - Serpentine - A.C.	7C3Z 8620 C	▲K060393HD
Hose - Upper		22315	Tensioner Assy. - Accessory Drive	7C3Z 6B209 A	39051
Hose - Lower		23667	Tensioner Assy. - A.C.	7C3Z 6B209 B	39052
Hose - Heater Inlet		22614	Idler Pulley - Alt. Brkt.	3C2Z 8678 AA	36354
F450 Super Duty			Idler Pulley - P.S. Brkt.	3C3Z 8678 BB	36492
Belt - Serpentine; W/A.C.	BC2Z 8620 A	▲K060997HD	Hose - Upper		23815
Belt - Serpentine; W/O A.C.	BC3Z 8620 D	K060810	Hose - Lower - Rad. To Pipe		23817
Belt - Accessory Drive; W/Deweze Hyd.			Hose - Lower - Pipe To Eng.		23816
Pump	740280	▲K080716HD	Hose - Reservoir To Rad.		23818
Tensioner Assy.; W/O A.C.	2L3Z 6B209 CA	38329	Hose - Intercooler To Pipe (Cold Side)	8C3Z 6N651 A	26218
Tensioner Assy.; W/A.C.	1L2Z 6B209 AA	38274	Hose - Pipe To Engine (Cold Side)	8C3Z 6N650 A	26219
Idler Pulley	1L2Z 8678 AB	38001	Hose - Eng. To Pipe (Hot Side)	8C3Z 6W650 A	26216
F550 Super Duty			Hose - Pipe To Intercooler (Hot Side)	8C3Z 6W651 A	26217
Belt - Accessory Drive; W/Deweze Hyd.			Hose - Turbo To Pipe (Hot Side)	8C3Z 6W650 A	26216
Pump	740280	▲K080716HD	Ford V-10 6.8 L		
2010			E450 Super Duty		
Cummins ISB-07 Diesel			Belt - Serpentine; Jan. 28, 2010 & Newer;		
F650 Super Duty; F750 Super Duty			W/A.C.	9C2Z 8620 C	K060995
Belt - Accessory Drive	BC4Z 8620 BA	▲K080830HD	Belt - Serpentine; Jan. 27, 2010 & Older;		
Ford V-8 5.4 L			W/A.C.	9C2Z 8620 A	▲K060994HD
E450 Super Duty			Belt - Serpentine; Jan. 28, 2010 & Newer;		
Belt - Serpentine; Jan. 28, 2010 & Newer;			W/O A.C.	9C2Z 8620 D	K060804
W/A.C.	9C2Z 8620 C	K060995	Belt - Serpentine; Jan. 27, 2010 & Older;		
Belt - Serpentine; Jan. 27, 2010 & Older;			W/O A.C.	9C2Z 8620 B	K060602
W/A.C.	9C2Z 8620 A	▲K060994HD	Tensioner Assy.; W/A.C.	1L2Z 6B209 AA	38274
Belt - Serpentine - Solution Kit; W/Aftermarket Hybrid			Tensioner Assy.; W/O A.C.	2L3Z 6B209 CA	38329
Drive System; W/A.C.		38274K1	Idler Pulley	1L2Z 8678 AB	38001
Belt - Serpentine; Jan. 28, 2010 & Newer;			Tensioner Pulley; W/A.C.		38006
W/O A.C.	9C2Z 8620 D	K060804	Hose - Upper		22315
Belt - Serpentine; Jan. 27, 2010 & Older;			F450 Super Duty; F550 Super Duty		
W/O A.C.	9C2Z 8620 B	K060602	Belt - Serpentine; W/A.C.; W/Ambient Air		
Tensioner Assy.; W/A.C.	1L2Z 6B209 AA	38274	Pkg.	2L3Z 8620 DB	▲K060990HD
Tensioner Assy.; W/O A.C.	2L3Z 6B209 CA	38329	Belt - Serpentine; W/A.C.; W/O Ambient		
Idler Pulley	1L2Z 8678 AB	38001	Air Pkg.	7C3Z 8620 D	▲K061005HD
Hose - Upper		22316	Belt - Serpentine; W/O A.C.	5C3Z 8620 BA	▲K060806HD
Hose - Lower; W/O Trlr. Tow. Pkg.		22372	Belt - Accessory Drive; W/Deweze Hyd.		
Hose - Lower; W/Trlr. Tow. Pkg.		23667	Pump	740280	▲K080716HD
Ford V-8 6.0 L Diesel			Tensioner Assy.; W/A.C.	1L2Z 6B209 AA	38274
E450 Super Duty			Tensioner Assy.; W/O A.C.	2L3Z 6B209 CA	38329
Belt - Serpentine; W/Single Alt.	8C2Z 8620 A	K081304HD	Idler Pulley	1L2Z 8678 AB	38001
Belt - Serpentine; W/Dual Alts.;			Tensioner Pulley; W/A.C.		38006
W/6-Ribbed Belt	3C2Z 8620 HB	▲K060658HD	2009		
Belt - Serpentine; W/Dual Alts.;			Caterpillar C7 Diesel		
W/8-Ribbed Belt	8C2Z 8620 B	K081369HD	F650 Super Duty; F750 Super Duty		
Tensioner Assy. - Alt.; W/Dual Alts.	3C3Z 6B209 BA	38321	Belt - Accessory Drive	4C4Z 8620 GA	▲K080774HD
Tensioner Assy. - Accessory Drive	3C2Z 6B209 CA	38257	Cummins ISB-07 Diesel		
Idler Pulley - Accessory Drive (Grooved)	3C3Z 8678 EB	36324	F650 Super Duty; F750 Super Duty		
Idler Pulley - Accessory Drive (Smooth)	3C3Z 8678 BB	36492	Belt - Fan, Alt. & A.C.	3289963	K080834HD
Idler Pulley - Alt. Drive	3C2Z 8678 CB	②36329	Tensioner Assy. - Fan, Alt. & A.C.	4937433	38631
Hose - Upper		23077	Ford V-6 4.5 L Diesel		
Hose - Lower		23076	LCF		
Hose - By Pass		23569	Belt - Serpentine; W/O Prestolite Alt.	1846055C1	▲K081331HD
Hose - Turbo To Pipe (Hot Side)	9C2Z 6C640 A	26278	Tensioner Assy.	1844538C1	38257
Hose - Pipe To Intercooler (Hot Side)	6C2Z 6C640 A	26279			
Hose - Intercooler To Pipe (Cold Side)	6C2Z 6C640 DA	26217			

▲Standard Belt Available.

②Two Required.

Belts and Coolant Hose for Medium/Heavy-Duty Trucks (2001 & Newer)

Application	Mfr. Part No.	Our No.	Application	Mfr. Part No.	Our No.
Ford - Continued			Ford - Continued		
2009 - Continued			2009 - Continued		
Ford V-8 5.4 L			Ford V-10 6.8 L - Continued		
E450 Super Duty			F450 Super Duty; F550 Super Duty - Continued		
Belt - Serpentine; W/A.C.	5C3Z 8620 AA	♣K060997HD	Belt - Serpentine; W/A.C.; W/O Ambient Air Pkg.	7C3Z 8620 D	♣K061005HD
Belt - Serpentine; W/O A.C.	2C3Z 8620 DA	♣K060806HD	Belt - Serpentine; W/O A.C.	5C3Z 8620 BA	♣K060806HD
Belt - Serpentine - Solution Kit; W/Aftermarket Hybrid Drive System; W/A.C.		38274K1	Belt - Accessory Drive; W/Deweze Hyd. Pump	740280	♣K080716HD
Tensioner Assy.; W/A.C.	1L2Z 6B209 AA	38274	Tensioner Assy.; W/A.C.	1L2Z 6B209 AA	38274
Tensioner Assy.; W/O A.C.	2L3Z 6B209 CA	38329	Tensioner Assy.; W/O A.C.	2L3Z 6B209 CA	38329
Idler Pulley - Grooved	1L2Z 6C348 AA	36157	Idler Pulley	1L2Z 8678 AB	38001
Idler Pulley - Smooth	1L3Z 8678 AB	38001	Tensioner Pulley; W/A.C.		38006
Tensioner Pulley; W/A.C.		38006			
Hose - Upper		22315			
Hose - Lower		23667			
Ford V-8 6.0 L Diesel			2008		
E450 Super Duty			Caterpillar C7 Diesel		
Belt - Serpentine; W/Single Alt.	8C2Z 8620 A	K081304HD	F650 Super Duty; F750 Super Duty		
Belt - Serpentine; W/Dual Alts.; W/6-Ribbed Belt	3C2Z 8620 HB	♣K060658HD	Belt - Accessory Drive		
Belt - Serpentine; W/Dual Alts.; W/8-Ribbed Belt	8C2Z 8620 B	K081369HD	4C4Z 8620 GA		
Tensioner Assy. - Alt.; W/Dual Alts.	3C3Z 6B209 BA	38321	♣K080774HD		
Tensioner Assy. - Accessory Drive	3C2Z 6B209 CA	38257	Cummins ISB-07 Diesel		
Idler Pulley - Accessory Drive (Grooved)	3C3Z 8678 EB	36324	F650 Super Duty; F750 Super Duty		
Idler Pulley - Accessory Drive (Smooth)	3C3Z 8678 BB	36492	Belt - Fan, Alt. & A.C.		
Idler Pulley - Alt. Drive	3C2Z 8678 CB	②36329	Tensioner Assy. - Fan, Alt. & A.C.		
Hose - Upper		23077	3289963		
Hose - Lower		23076	4937433		
Hose - By Pass		23569	K080834HD		
Hose - Turbo To Pipe (Hot Side)	9C2Z 6C640 A	26278	38631		
Hose - Pipe To Intercooler (Hot Side)	6C2Z 6C640 A	26279	Ford V-6 4.5 L Diesel		
Hose - Intercooler To Pipe (Cold Side)	6C2Z 6C640 DA	26217	LCF		
Hose - Pipe To Engine (Cold Side)	3C3Z 6C640 BA	26223	Belt - Serpentine; W/O Prestolite Alt.		
			1846055C1		
			Tensioner Assy.		
			1844538C1		
			38257		
			Ford V-8 5.4 L		
			E450 Super Duty		
			Belt - Serpentine; W/A.C.		
			5C3Z 8620 AA		
			♣K060997HD		
			Belt - Serpentine; W/O A.C.		
			5C3Z 8620 BA		
			♣K060806HD		
			Belt - Serpentine - Solution Kit; W/Aftermarket Hybrid Drive System; W/A.C.		
			38274K1		
			Tensioner Assy.; W/A.C.		
			1L2Z 6B209 AA		
			38274		
			Tensioner Assy.; W/O A.C.		
			2L3Z 6B209 CA		
			38329		
			Idler Pulley - Smooth		
			1L2Z 8678 AB		
			38001		
			Idler Pulley - Grooved		
			1L2Z 6C348 AA		
			36157		
			Tensioner Pulley; W/A.C.		
			38006		
			Idler Pulley		
			1L2E 19A216 AC		
			38001		
			Hose - Upper		
			22315		
			Hose - Lower		
			23667		
			Ford V-8 6.0 L Diesel		
			E450 Super Duty		
			Belt - Serpentine; W/Single Alt.		
			8C2Z 8620 A		
			K081304HD		
			Belt - Serpentine; W/Dual Alts.; W/8-Ribbed Belt		
			8C2Z 8620 B		
			K081369HD		
			Belt - Serpentine; W/Dual Alts.; W/6-Ribbed Belt		
			3C2Z 8620 HB		
			♣K060658HD		
			Tensioner Assy. - Alt.; W/Dual Alts.		
			3C3Z 6B209 BA		
			38321		
			Tensioner Assy. - Accessory Drive		
			3C2Z 6B209 CA		
			38257		
			Idler Pulley - Accessory Drive (Smooth)		
			3C3Z 8678 BB		
			36492		
			Idler Pulley - Accessory Drive (Grooved)		
			3C3Z 8678 EB		
			36324		
			Idler Pulley - Alt. Drive		
			3C2Z 8678 CB		
			②36329		
			Hose - Upper		
			23077		
			Hose - Lower		
			23076		
			Hose - By Pass		
			23569		
			Hose - Turbo To Pipe (Hot Side)		
			6C2Z 6C640 AA		
			26278		
			Hose - Pipe To Intercooler (Hot Side)		
			6C2Z 6C640 A		
			26279		
			Hose - Intercooler To Pipe (Cold Side)		
			6C2Z 6C640 DA		
			26217		
			Hose - Pipe To Engine (Cold Side)		
			3C3Z 6C640 BA		
			26223		
			Ford V-8 6.4 L Diesel		
			F450 Super Duty; F550 Super Duty		
			Belt - Accessory Belt Drive Kit; W/Single Alt.		
			ACK080865HD		
			Belt - Serpentine - Accessory Drive; W/Single Alt.		
			7C3Z 8620 E		
			♣K080865HD		
			Belt - Serpentine - Accessory Drive; W/Dual Alts.		
			7C3Z 8620 F		
			♣K080956HD		

♣Standard Belt Available.

②Two Required.

Medium & Heavy-Duty Trucks (2001 & Newer)

Belts and Coolant Hose for Medium/Heavy-Duty Trucks (2001 & Newer)

Medium & Heavy-Duty Trucks
(2001 & Newer)

Application	Mfr. Part No.	Our No.	Application	Mfr. Part No.	Our No.
Ford - Continued			Ford - Continued		
2008 - Continued			2007 - Continued		
Ford V-8 6.4 L Diesel - Continued			Ford V-6 4.5 L Diesel		
F450 Super Duty; F550 Super Duty - Continued			LCF		
Belt - A.C.	7C3Z 8620 C	♣K060393HD	Belt - Serpentine; W/O Prestolite Alt.	1846055C1	♣K081331HD
Tensioner Assy. - Accessory Drive	7C3Z 6B209 A	39051	Tensioner Assy.	1844538C1	38257
Hose - Lower - Rad. To Pipe	7C3Z 6B209 B	39052	Ford V-8 5.4 L		
Idler Pulley - Alt. Brkt.	3C2Z 8678 AA	36354	E450 Super Duty		
Idler Pulley - P.S. Brkt.	3C3Z 8678 BB	36492	Belt - Serpentine; W/A.C.	5C3Z 8620 AA	♣K060997HD
Hose - Upper		23815	Belt - Serpentine; W/O A.C.	5C3Z 8620 BA	♣K060806HD
Hose - Lower - Rad. To Pipe		23817	Tensioner Assy.; W/A.C.	1L2Z 6B209 AA	38274
Hose - Lower - Pipe To Eng.		23816	Tensioner Assy.; W/O A.C.	2L3Z 6B209 CA	38329
Hose - Reservoir To Rad.		23818	Idler Pulley - Grooved	1L2Z 6C348 AA	36157
Hose - Intercooler To Pipe (Cold Side)	8C3Z 6N651 A	26218	Idler Pulley - Smooth	1L2Z 8678 AB	38001
Hose - Pipe To Engine (Cold Side)	8C3Z 6N650 A	26219	Tensioner Pulley; W/A.C.		38006
Hose - Eng. To Pipe (Hot Side)	8C3Z 6W650 A	26216	Hose - Upper		22315
Hose - Pipe To Intercooler (Hot Side)	8C3Z 6W651 A	26217	Hose - Lower		23667
Hose - Turbo To Pipe (Hot Side)	8C3Z 6W650 A	26216	Ford V-8 6.0 L Diesel		
Ford V-10 6.8 L			E450 Super Duty		
E450 Super Duty			Belt - Serpentine - Accessory Drive;		
Belt - Serpentine; W/A.C.	5C3Z 8620 AA	♣K060997HD	W/Single Alt.	3C2Z 8620 AA	♣K081298HD
Belt - Serpentine; W/O A.C.	2C3Z 8620 DA	♣K060806HD	Belt - Serpentine - Accessory Drive;		
Tensioner Assy.; W/A.C.	1L2Z 6B209 AA	38274	W/Dual Alts.	3C2Z 8620 BB	♣K081362HD
Tensioner Assy.; W/O A.C.	2L3Z 6B209 CA	38329	Belt - Serpentine - Alt.; W/Dual Alts.	3C2Z 8620 HB	♣K060658HD
Idler Pulley - Grooved	1L2Z 6C348 AA	36157	Tensioner Assy. - Accessory Drive	3C2Z 6B209 CA	38257
Idler Pulley - Smooth	1L3Z 8678 AB	38001	Tensioner Assy. - Alt.; W/Dual Alts.	3C3Z 6B209 BA	38321
Tensioner Pulley; W/A.C.		38006	Idler Pulley - Accessory Drive (Grooved)	3C3Z 8678 EB	36324
Hose - Upper		22315	Idler Pulley - Accessory Drive (Smooth)	3C3Z 8678 BB	36354
F450 Super Duty			Idler Pulley - Alt. Drive	3C2Z 8678 CB	Ⓞ36329
Belt - Serpentine; W/A.C.; W/Ambient Air			Hose - Upper		23077
Pkg.	2L3Z 8620 DB	♣K060990HD	Hose - Lower		23076
Belt - Serpentine; W/A.C.; W/O Ambient			Hose - By Pass		23569
Air Pkg.	7C3Z 8620 D	♣K061005HD	Hose - Turbo To Pipe (Hot Side)	6C2Z 6C640 AA	26278
Belt - Serpentine; W/O A.C.	5C3Z 8620 BA	♣K060806HD	Hose - Pipe To Intercooler (Hot Side)	6C2Z 6C640 A	26279
Belt - Accessory Drive; W/Deweze Hyd.			Hose - Intercooler To Pipe (Cold Side)	6C2Z 6C640 DA	26217
Pump	740280	♣K080716HD	Hose - Pipe To Engine (Cold Side)	3C3Z 6C640 BA	26223
Tensioner Assy.; W/A.C.	1L2Z 6B209 AA	38274	F450 Super Duty; F550 Super Duty		
Tensioner Assy.; W/O A.C.	2L3Z 6B209 CA	38329	Belt - Fan, Alt., P.S. & A.C.; W/Single Alt. ...	3C3E 8620 DA	♣K081265HD
Idler Pulley; W/A.C.	1L2Z 8678 AB	38001	Belt - Fan, Alt., P.S. & A.C.; W/Dual Alts.	3C3Z 8620 BC	♣K081325HD
Tensioner Pulley		38006	Belt - Alt.; W/Dual Alts.	3C2Z 8620 HA	♣K060658HD
F550 Super Duty			Tensioner Assy. - Accessory Drive	3C2Z 6B209 CA	38257
Belt - Serpentine; W/A.C.; W/Ambient Air			Tensioner Assy. - Alt.; W/Dual Alts.	3C3Z 6B209 BA	38321
Pkg.	2L3Z 8620 DB	♣K060990HD	Idler Pulley - Accessory Drive (Grooved)	3C3Z 8678 EB	36324
Belt - Serpentine; W/A.C.; W/O Ambient			Idler Pulley - Accessory Drive (Smooth)	3C3Z 8678 BB	36354
Air Pkg.	7C3Z 8620 D	♣K061005HD	Idler Pulley - Alt. Drive	3C2Z 8678 CB	Ⓞ36329
Belt - Serpentine; W/O A.C.	5C3Z 8620 BA	♣K060806HD	Hose - Upper		22779
Belt - Accessory Drive; W/Deweze Hyd.			Hose - Lower; W/Twin I-Beam Suspension		24204
Pump	740280	♣K080716HD	Hose - Lower; W/Monobeam Suspension		23513
Tensioner Assy.; W/A.C.	1L2Z 6B209 AA	38274	Hose - Reservoir To Eng.		22953
Tensioner Assy.; W/O A.C.	2L3Z 6B209 CA	38329	Hose - Turbo To Pipe (Hot Side)	6C3Z 6C640 A	26222
Idler Pulley; W/A.C.	1L2Z 8678 AB	38001	Hose - Pipe To Intercooler (Hot Side)	YC3Z 6C640 KA	26221
Tensioner Pulley; W/A.C.		38006	Hose - Intercooler To Pipe (Cold Side);		
2007			W/Metal Pipe	3C3Z 6C640 AA	26282
Caterpillar C7 Diesel			Hose - Pipe To Engine (Cold Side);		
F650 Super Duty; F750 Super Duty			W/Metal Pipe	3C3Z 6C640 BA	26223
Belt - Fan, Alt. & A.C.	3586467C1	♣K080774HD	F650 Super Duty; F750 Super Duty		
Tensioner Assy. - Fan, Alt. & A.C.	2201209	38550	Belt - Fan, Alt. & A.C.	1839963C1	♣K080830HD
Hose - Upper - Pipe To Eng.		21571	Belt - Fan & Air Compr.	1843218C1	♣K060509HD
Hose - Upper - Pipe To Rad.		24232	Tensioner Assy. - Fan, Alt. & A.C.	1833688C2	38556
Cummins ISB Diesel			Hose - Upper - Eng. To Rad.		22774
F650 Super Duty; F750 Super Duty			Hose - Lower - Eng. To Rad.		22775
Belt - W.P., Fan, Alt. & A.C.	3289809	♣K080797HD	Ford V-10 6.8 L		
Tensioner Assy. - W.P., Alt. & A.C.	3976833	38517	E450 Super Duty		
Hose - Upper - Eng. To Pipe		20206	Belt - Serpentine; W/A.C.	5C3Z 8620 AA	♣K060997HD
Hose - Upper - Rad. To Pipe		24236	Belt - Serpentine; W/O A.C.	2C3Z 8620 DA	♣K060806HD
			Tensioner Assy.; W/A.C.	1L2Z 6B209 AA	38274
			Tensioner Assy.; W/O A.C.	2L3Z 6B209 CA	38329

♣Standard Belt Available.

ⓄTwo Required.

Belts and Coolant Hose for Medium/Heavy-Duty Trucks (2001 & Newer)

Application	Mfr. Part No.	Our No.	Application	Mfr. Part No.	Our No.
Ford - Continued			Ford - Continued		
2007 - Continued			2006 - Continued		
Ford V-10 6.8 L - Continued			Ford V-8 6.0 L Diesel - Continued		
E450 Super Duty - Continued			F450 Super Duty		
Idler Pulley - Grooved	1L2Z 6C348 AA	36157	Belt - Fan, Alt., P.S. & A.C.; W/Single Alt. ...	3C3E 8620 DA	▲K081265HD
Idler Pulley - Smooth	1L3Z 8678 AB	38001	Belt - Fan, Alt., P.S. & A.C.; W/Dual Alts.	3C3Z 8620 BC	▲K081325HD
Tensioner Pulley; W/A.C.		38006	Belt - Alt.; W/Dual Alts.	3C2Z 8620 HA	▲K060658HD
Hose - Upper		22315	Tensioner Assy. - Accessory Drive	3C2Z 6B209 CA	38257
F450 Super Duty; F550 Super Duty			Tensioner Assy. - Alt.; W/Dual Alts.	3C3Z 6B209 BA	38321
Belt - Serpentine; W/A.C.	5C3Z 8620 AA	▲K060997HD	Idler Pulley - Accessory Drive (Grooved) ...	3C3Z 8678 EB	36324
Belt - Serpentine; W/O A.C.	5C3Z 8620 BA	▲K060806HD	Idler Pulley - Accessory Drive (Smooth)	3C3Z 8678 BB	36354
Belt - Accessory Drive; W/Deweze Hyd. Pump	740280	▲K080716HD	Idler Pulley - Alt. Drive	3C2Z 8678 CB	②36329
Tensioner Assy.; W/O A.C.	2L3Z 6B209 CA	38329	Hose - Upper - Eng. To Rad.		22779
Idler Pulley - Grooved	1L2Z 6C348 AA	36157	Hose - Lower - Eng. To Rad.; W/Twin I-Beam Suspension		24204
Idler Pulley - Smooth	1L3Z 8678 AB	38001	Hose - Lower; W/Monobeam Suspension		23513
Tensioner Pulley; W/A.C.		38006	Hose - Heater To Pipe-1		19832
Hose - Upper		23275	Hose - Heater To Pipe-2		19834
Hose - Lower		23266	Hose - Pipe-2 To Tee		19833
2006			Hose - Reservoir To Eng.		22953
Caterpillar C7 Diesel			Hose - Turbo To Pipe (Hot Side)	6C3Z 6C640 A	26222
F650 Super Duty; F750 Super Duty			Hose - Pipe To Intercooler (Hot Side)	YC3Z 6C640 KA	26221
Belt - Fan, Alt. & A.C.	3586467C1	▲K080774HD	Hose - Intercooler To Pipe (Cold Side); W/Metal Pipe	3C3Z 6C640 AA	26282
Tensioner Assy. - Fan, Alt. & A.C.	2201209	38550	Hose - Pipe To Engine (Cold Side); W/Metal Pipe	3C3Z 6C640 BA	26223
Hose - Upper - Pipe To Eng.		21571	F550 Super Duty		
Hose - Upper - Pipe To Rad.		24232	Belt - Fan, Alt., P.S. & A.C.; W/Single Alt. ...	3C3E 8620 DA	▲K081265HD
Cummins ISB Diesel			Belt - Fan, Alt., P.S. & A.C.; W/Dual Alts.	3C3Z 8620 BC	▲K081325HD
F650 Super Duty; F750 Super Duty			Belt - Alt.; W/Dual Alts.	3C2Z 8620 HA	▲K060658HD
Belt - W.P., Fan, Alt. & A.C.	3289809	▲K080797HD	Tensioner Assy. - Alt.; W/Dual Alts.	3C3Z 6B209 BA	38321
Tensioner Assy. - W.P., Alt. & A.C.	3957433	38517	Tensioner Assy. - Accessory Drive	3C2Z 6B209 CA	38257
Hose - Upper - Eng. To Pipe		20206	Idler Pulley - Accessory Drive (Smooth)	3C3Z 8678 BB	36354
Hose - Upper - Rad. To Pipe		24236	Idler Pulley - Accessory Drive (Grooved) ...	3C3Z 8678 EB	36324
Hose - Lower - Rad. To Pipe		②20611	Idler Pulley - Alt. Drive	3C2Z 8678 CB	②36329
Ford V-6 4.5 L Diesel			Hose - Upper - Eng. To Rad.		22779
LCF			Hose - Lower - Eng. To Rad.; W/Twin I-Beam Suspension		24204
Belt - Serpentine; W/O Prestolite Alt.	1846055C1	▲K081331HD	Hose - Lower; W/Monobeam Suspension		23513
Tensioner Assy.	1844538C1	38257	Hose - Turbo To Pipe (Hot Side)	6C3Z 6C640 A	26222
Ford V-8 5.4 L			Hose - Pipe To Intercooler (Hot Side)	YC3Z 6C640 KA	26221
E450 Super Duty			Hose - Intercooler To Pipe (Cold Side); W/Metal Pipe	3C3Z 6C640 AA	26282
Belt - Serpentine; W/A.C.	5C3Z 8620 AA	▲K060997HD	Hose - Pipe To Engine (Cold Side); W/Metal Pipe	3C3Z 6C640 BA	26223
Belt - Serpentine; W/O A.C.	5C3Z 8620 BA	▲K060806HD	F650 Super Duty; F750 Super Duty		
Tensioner Assy.; W/A.C.	1L2Z 6B209 AA	38274	Belt - Fan, Alt. & A.C.	1839963C1	▲K080830HD
Tensioner Assy.; W/O A.C.	2L3Z 6B209 CA	38329	Belt - Fan & Air Compr.	1843218C1	▲K060509HD
Idler Pulley - Grooved	1L2Z 6C348 AA	36157	Tensioner Assy. - Fan, Alt. & A.C.	1833688C2	38556
Idler Pulley - Smooth	1L2Z 8678 AB	38001	Hose - Upper - Eng. To Rad.		22774
Tensioner Pulley; W/A.C.		38006	Hose - Lower - Eng. To Rad.		22775
Hose - Upper		22315	Ford V-10 6.8 L		
Hose - Lower		23667	E450 Super Duty		
Ford V-8 6.0 L Diesel			Belt - Serpentine; W/A.C.	2C2Z 8620 DB	K060984
E450 Super Duty			Belt - Serpentine; W/O A.C.	2C3Z 8620 DA	▲K060806HD
Belt - Fan, Alt., P.S. & A.C.; W/Single Alt. ...	3C2E 8620 AC	▲K081298HD	Belt - Fan, Alt., P.S. & A.C.	5C2E 8620 AA	K060984
Belt - Fan, Alt., P.S. & A.C.; W/Dual Alts.	3C2Z 8620 BB	▲K081362HD	Tensioner Assy.; W/A.C.	1L2Z 6B209 AA	38274
Belt - Alt.; W/Dual Alts.	3C2Z 8620 HB	▲K060658HD	Tensioner Assy.; W/O A.C.	2L3Z 6B209 CA	38329
Tensioner Assy. - Accessory Drive	3C2Z 6B209 CA	38257	Idler Pulley - Grooved	1L2Z 6C348 AA	36157
Tensioner Assy. - Alt.; W/Dual Alts.	3C3Z 6B209 BA	38321	Idler Pulley - Smooth	1L3Z 8678 AB	38001
Idler Pulley - Accessory Drive (Grooved) ...	3C3Z 8678 EB	36324	Tensioner Pulley; W/A.C.		38006
Idler Pulley - Accessory Drive (Smooth)	3C3Z 8678 BB	36354	Hose - Upper		22315
Idler Pulley - Alt. Drive	3C2Z 8678 CB	②36329	F450 Super Duty; F550 Super Duty		
Hose - Upper - Eng. To Rad.		23077	Belt - Serpentine; W/A.C.	5C3Z 8620 AA	▲K060997HD
Hose - Lower - Eng. To Rad.		23076	Belt - Serpentine; W/O A.C.	2C3Z 8620 DA	▲K060806HD
Hose - By Pass		23569	Belt - Accessory Drive; W/Deweze Hyd. Pump	740280	▲K080716HD
Hose - Turbo To Pipe (Hot Side)	6C2Z 6C640 AA	26278	Tensioner Assy.; W/A.C.	1L2Z 6B209 AA	38274
Hose - Pipe To Intercooler (Hot Side)	6C2Z 6C640 A	26279	Tensioner Assy.; W/O A.C.	2L3Z 6B209 CA	38329
Hose - Intercooler To Pipe (Cold Side)	6C2Z 6C640 DA	26271	Ford V-10 6.8 L		
Hose - Pipe To Engine (Cold Side)	3C3Z 6C640 BA	26223	E450 Super Duty		

▲Standard Belt Available.
②Two Required.

③Cut to Fit.

Medium & Heavy-Duty Trucks
(2001 & Newer)

Belts and Coolant Hose for Medium/Heavy-Duty Trucks (2001 & Newer)

 Medium & Heavy-Duty Trucks
(2001 & Newer)

Application	Mfr. Part No.	Our No.	Application	Mfr. Part No.	Our No.
Ford - Continued			Ford - Continued		
2006 - Continued			2005 - Continued		
Ford V-10 6.8 L - Continued			Ford V-8 6.0 L Diesel - Continued		
F450 Super Duty; F550 Super Duty - Continued			F450 Super Duty; F550 Super Duty - Continued		
Idler Pulley - Grooved	1L2Z 6C348 AA	36157	Belt - Serpentine - Alt.; W/Dual Alts.; W/O F53 Stripped Chassis	3C2Z 8620 HB	♣K060658HD
Idler Pulley - Smooth	1L3Z 8678 AB	38001	Belt - Serpentine; W/F53 Stripped Chassis	3C3Z 8620 CA	♣K081331HD
Tensioner Pulley; W/A.C.		38006	Belt - Accessory Drive; W/P.T.O.		K081490
Hose - Upper		23275	Tensioner Assy. - Accessory Drive	3C2Z 6B209 CA	38257
Hose - Lower		23266	Tensioner Assy. - Alt.; W/Dual Alts.	3C3Z 6B209 BA	38321
2005			Idler Pulley - Accessory Drive (Grooved)	3C3Z 8678 EB	36324
Caterpillar C7 Diesel			Idler Pulley - Accessory Drive (Smooth)	3C3Z 8678 BB	36354
F650 Super Duty			Idler Pulley - Alt. Drive	3C2Z 8678 CB	②36329
Belt - Fan, Alt. & A.C.	1514968C1	♣K080774HD	Hose - Upper		22779
Tensioner Assy. - Fan, Alt. & A.C.	2201209	38550	Hose - Lower; W/Twin I-Beam Suspension		24204
Hose - Upper - Pipe To Eng.		21571	Hose - Lower; W/Monobeam Suspension		23513
Hose - Upper - Pipe To Rad.		24232	Hose - Heater To Pipe-1		19832
F750 Super Duty			Hose - Heater To Pipe-2		19834
Belt - Fan, Alt. & A.C.; W/P.T.O.	4C4Z 8620 EA	♣K080839HD	Hose - Pipe-2 To Tee		19833
Belt - Fan, Alt. & A.C.; W/O P.T.O.	1514968C1	♣K080774HD	Hose - Reservoir To Eng.		22953
Tensioner Assy. - Fan, Alt. & A.C.	2201209	38550	Hose - Turbo To Pipe (Hot Side); May 16, 2005 & Newer	6C3Z 6C640 A	26222
Hose - Upper - Pipe To Eng.		21571	Hose - Turbo To Pipe (Hot Side); May 15, 2005 & Older	6C3Z 6C640 C	26220
Hose - Upper - Pipe To Rad.		24232	Hose - Pipe To Intercooler (Hot Side)	YC3Z 6C640 KA	26221
Cummins ISB Diesel			Hose - Intercooler To Pipe (Cold Side); W/Metal Pipe	3C3Z 6C640 AA	26282
F650 Super Duty; F750 Super Duty			Hose - Pipe To Engine (Cold Side); W/Metal Pipe	3C3Z 6C640 BA	26223
Belt - W.P., Fan, Alt. & A.C.	3289809	♣K080797HD	F650 Super Duty; F750 Super Duty		
Tensioner Assy. - W.P., Alt. & A.C.	3957433	38517	Belt - Fan, Alt. & A.C.	1839963C1	♣K080830HD
Hose - Upper - Eng. To Pipe		20206	Tensioner Assy. - Fan, Alt. & A.C.	1833688C1	38556
Hose - Upper - Rad. To Pipe		24236	Hose - Upper - Eng. To Rad.		22774
Hose - Lower - Rad. To Pipe		≈20611	Hose - Lower - Eng. To Rad.		22775
Ford V-8 5.4 L			Ford V-10 6.8 L		
E450 Super Duty			E450 Super Duty		
Belt - Serpentine; W/Factory Inst. A.C.	2C2Z 8620 DB	K060984	Belt - Serpentine; W/A.C.	2C2Z 8620 DB	K060984
Belt - Serpentine; W/O A.C.	2C3Z 8620 DA	♣K060806HD	Belt - Serpentine; W/O A.C.	2C3Z 8620 DA	♣K060806HD
Belt - Accessory Drive; W/Aftermarket A.C.		K061230	Belt - Fan, Alt., P.S. & A.C.	2C2E 8620 DC	K060984
Belt - Accessory Drive; W/Deweze Hyd. Pump	740280	♣K080716HD	Tensioner Assy.; W/A.C.	1L3Z 6B209 AA	38133
Tensioner Assy.; W/A.C.	1L2Z 6B209 AA	38274	Tensioner Assy.; W/O A.C.	F75Z 6B209 EA	38330
Tensioner Assy.; W/O A.C.	2L3Z 6B209 CA	38329	Idler Pulley - Grooved	1L2Z 6C348 AA	36157
Idler Pulley - Grooved	1L2Z 6C348 AA	36157	Idler Pulley - Smooth	1L3Z 8678 AB	38001
Idler Pulley - Smooth	1L3Z 8678 AB	38001	Idler Pulley	1L2Z 8678 AB	38001
Tensioner Pulley; W/A.C.		38006	Tensioner Pulley; W/A.C.		38006
Hose - Upper		22315	Hose - Upper		22315
Hose - Lower		23667	F450 Super Duty; F550 Super Duty		
Ford V-8 6.0 L Diesel			Belt - Serpentine; W/A.C.	2C3Z 8620 EB	♣K061000HD
E450 Super Duty			Belt - Serpentine; W/O A.C.	2C3Z 8620 DA	♣K060806HD
Belt - Fan, Alt., P.S. & A.C.; W/Single Alt. ...	3C2E 8620 AC	♣K081298HD	Belt - Accessory Drive; W/Deweze Hyd. Pump	740280	♣K080716HD
Belt - Fan, Alt., P.S. & A.C.; W/Dual Alts.	3C2Z 8620 BB	♣K081362HD	Tensioner Assy.; W/A.C.	1L2Z 6B209 AA	38274
Belt - Alt.; W/Dual Alts.	3C2Z 8620 HB	♣K060658HD	Tensioner Assy.; W/O A.C.	2L3Z 6B209 CA	38329
Tensioner Assy. - Accessory Drive	3C2Z 6B209 CA	38257	Idler Pulley - Grooved	1L2Z 6C348 AA	36157
Tensioner Assy. - Alt.; W/Dual Alts.	3C3Z 6B209 BA	38321	Idler Pulley - Smooth	1L3Z 8678 AB	38001
Idler Pulley - Accessory Drive (Grooved)	3C3Z 8678 EB	36324	Tensioner Pulley; W/A.C.		38006
Idler Pulley - Accessory Drive (Smooth)	3C3Z 8678 BB	36354	Hose - Upper		22431
Idler Pulley - Alt. Drive	3C2Z 8678 CB	②36329	Hose - Lower		22432
Hose - Upper - Eng. To Rad.		23077	2004		
Hose - Lower - Eng. To Rad.		23076	Caterpillar 3126 Diesel		
Hose - By Pass		23569	F650 Super Duty; F750 Super Duty		
Hose - Turbo To Pipe (Hot Side)	4C2Z 6C640 BA	26278	Belt - Fan, Alt. & A.C.	YC35 8620 BA	♣K080816HD
Hose - Pipe To Intercooler (Hot Side)	4C2Z 6C640 EA	26279	Tensioner Assy. - Fan, Alt. & A.C.	1352142	38506
Hose - Intercooler To Pipe (Cold Side)	4C2Z 6C640 CA	26217	Tensioner Pulley - Fan, Alt. & A.C.	1352142	36091
Hose - Pipe To Engine (Cold Side)	3C3Z 6C640 BA	26223	Hose - Upper - Eng. To Pipe		20611
F450 Super Duty; F550 Super Duty			Hose - Upper - Pipe To Rad.		24232
Belt - Serpentine; W/Single Alt.; W/O F53 Stripped Chassis	3C3Z 8620 DB	♣K081265HD	Hose - Lower - Eng. To Pipe		20611
Belt - Serpentine; W/Dual Alts.; W/O F53 Stripped Chassis	3C3Z 8620 BC	♣K081325HD	Hose - Lower - Pipe To Rad.		24232

 ♣Standard Belt Available.
 ②Two Required.

≈Cut to Fit.

Belts and Coolant Hose for Medium/Heavy-Duty Trucks (2001 & Newer)

Application	Mfr. Part No.	Our No.	Application	Mfr. Part No.	Our No.
Ford - Continued			Ford - Continued		
2004 - Continued			2004 - Continued		
Caterpillar C7 Diesel			Ford V-8 6.0 L Diesel - Continued		
F650 Super Duty; F750 Super Duty			F450 Super Duty; F550 Super Duty - Continued		
Belt - Fan, Alt. & A.C.	1514968C1	▲K080774HD	Hose - Turbo To Pipe (Hot Side)	6C3Z 6C640 C	26220
Tensioner Assy. - Fan, Alt. & A.C.	2201209	38550	Hose - Pipe To Intercooler (Hot Side)	YC3Z 6C640 KA	26221
Hose - Upper - Pipe To Eng.		21571	Hose - Intercooler To Pipe (Cold Side);		
Hose - Upper - Pipe To Rad.		24232	W/Metal Pipe	3C3Z 6C640 AA	26282
Cummins ISB Diesel			Hose - Pipe To Engine (Cold Side);		
F650 Super Duty; F750 Super Duty			W/Metal Pipe	3C3Z 6C640 BA	26223
Belt - Fan, W.P. & Alt.	3943214	▲K080726HD	F650 Super Duty; F750 Super Duty		
Belt - Fan & A.C.	YC3Z 8620 AB	▲9375HD	Belt - Fan, Alt. & A.C.	1839963C1	▲K080830HD
Tensioner Assy. - Fan, W.P. & Alt.	3936213	38516	Tensioner Assy. - Fan, Alt. & A.C.	1833688C1	38556
Tensioner Pulley - Fan, W.P. & Alt.	3936213	36093	Hose - Upper - Eng. To Rad.		22774
Hose - Upper - Eng. To Pipe		24232	Hose - Lower - Eng. To Rad.		22775
Hose - Upper - Pipe To Rad.		24232	Ford V-8 7.3 L Diesel		
Hose - Lower - Eng. To Pipe		24232	F550 Super Duty		
Hose - Lower - Pipe To Rad.		24232	Belt - Serpentine; W/Ambulance Prep.		
Ford V-8 5.4 L			Pkg.; W/Dual Alts.	F8TZ 8620 GC	▲K081377HD
E450 Super Duty			Belt - Serpentine; W/Single Alt.; W/Cold		
Belt - Serpentine; W/Factory Inst. A.C.	2C2Z 8620 DB	K060984	Weather Pkg.	1C2Z 8620 NA	▲K081213HD
Belt - Serpentine; W/O A.C.	2C3Z 8620 DA	▲K060806HD	Belt - Serpentine; W/Single Alt.; W/O Cold		
Belt - Accessory Drive; W/Aftermarket A.C.		K061230	Weather Pkg.	1C2Z 8620 LA	▲K081223HD
Tensioner Assy.; W/A.C.	1L2Z 6B209 AA	38274	Tensioner Assy.	F8TZ 6B209 BA	38191
Tensioner Assy.; W/O A.C.	2L3Z 6B209 CA	38329	Tensioner Pulley - Grooved		38053
Idler Pulley - Grooved	1L2Z 6C348 AA	36157	Tensioner Pulley - Smooth		38028
Idler Pulley - Smooth	1L3Z 8678 AB	38001	Idler Pulley - Smooth	F8TZ 8678 FA	36234
Tensioner Pulley		38006	Hose - Upper; Preferred Hose; Upper hose routes		
Hose - Upper		22315	around serpentine belt		22433
Hose - DPFE Hose Kit		27079	Hose - Upper; Optional Hose; Routes through serpentine		
Ford V-8 6.0 L Diesel			belt		22542
E450 Super Duty			Hose - Lower		22690
Belt - Serpentine - Accessory Drive;			Hose - Heater To Eng.		19200
W/Single Alt.	3C2Z 8620 AA	▲K081298HD	Hose - Heater To W.P.		19201
Belt - Serpentine - Accessory Drive;			Hose - Rad. To Reservoir; W/3/8" I.D. Hose; Cut at 16" ...		28409
W/Dual Alts.	3C2Z 8620 BB	▲K081362HD	Hose - Reservoir To Rad.; W/1" I.D. Hose		19812
Belt - Serpentine - Alt.; W/Dual Alts.	3C2Z 8620 HB	▲K060658HD	Hose - Connector - Heater Hose		②28500
Tensioner Assy. - Accessory Drive	3C2Z 6B209 CA	38257	F650 Super Duty; F750 Super Duty		
Tensioner Assy. - Alt.; W/Dual Alts.	3C3Z 6B209 BA	38321	Belt - W.P., Fan & Alt.; W/Air Brakes	YC3Z 8620 FA	▲K081153HD
Idler Pulley - Accessory Drive (Grooved)	3C3Z 8678 EB	36324	Belt - W.P., Fan & Alt.; W/Hyd. Brakes	YC3Z 8620 HA	▲K080820HD
Idler Pulley - Accessory Drive (Smooth)	3C3Z 8678 BB	36354	Belt - W.P., Fan, Alt. & A.C.; W/Air Brakes ..	YC3Z 8620 EA	▲K081223HD
Idler Pulley - Alt. Drive	3C2Z 8678 CB	②36329	Belt - W.P., Fan, Alt. & A.C.; W/Hyd.		
Hose - Upper		23077	Brakes	YC3Z 8620 GA	▲K080893HD
Hose - Lower		23076	Tensioner Assy.	F8TZ 6B209 BA	38191
Hose - Turbo To Pipe (Hot Side)	4C2Z 6C640 BA	26278	Tensioner Pulley - Grooved		38053
Hose - Pipe To Intercooler (Hot Side)	4C2Z 6C640 EA	26279	Tensioner Pulley - Smooth		38028
Hose - Intercooler To Pipe (Cold Side)	4C2Z 6C640 CA	26217	Hose - Upper - Eng. To Pipe		③<20611
Hose - Pipe To Engine (Cold Side)	3C3Z 6C640 BA	26223	Hose - Upper - Pipe To Rad.		24232
F450 Super Duty; F550 Super Duty			Hose - Lower - Eng. To Pipe		③<20611
Belt - Serpentine; W/Single Alt.; W/O F53			Hose - Lower - Pipe To Rad.		24232
Stripped Chassis	3C3Z 8620 DB	▲K081265HD	Ford V-10 6.8 L		
Belt - Serpentine; W/Dual Alts.; W/O F53			E450 Super Duty		
Stripped Chassis	3C3Z 8620 BC	▲K081325HD	Belt - Fan, Alt., P.S. & A.C.	2C2E 8620 DC	K060984
Belt - Serpentine - Alt.; W/Dual Alts.; W/O			Tensioner Assy.; W/A.C.	1L3Z 6B209 AA	38133
F53 Stripped Chassis	3C2Z 8620 HB	▲K060658HD	Tensioner Assy.; W/O A.C.	F75Z 6B209 EA	38330
Belt - Serpentine; W/F53 Stripped Chassis .	3C3Z 8620 CA	▲K081331HD	Idler Pulley	1L2Z 8678 AB	38001
Belt - Accessory Drive; W/P.T.O.		K081490	Tensioner Pulley; W/A.C.		38006
Tensioner Assy. - Accessory Drive	3C2Z 6B209 CA	38257	Hose - Upper		22431
Tensioner Assy. - Alt.; W/Dual Alts.	3C3Z 6B209 BA	38321	Hose - Lower		22432
Idler Pulley - Accessory Drive (Grooved)	3C3Z 8678 EB	36324	Hose - Heater To Intake Manifold; Re-use existing flow		
Idler Pulley - Accessory Drive (Smooth)	3C3Z 8678 BB	36354	restrictor.		19218
Idler Pulley - Alt. Drive	3C2Z 8678 CB	②36329	Hose - Heater To Pipe-1		19306
Hose - Upper		22779	Hose - Reservoir To Rad.; W/1" I.D. Hose		19812
Hose - Lower		22780	Hose - Emission Hose - Hose Connector		
Hose - Heater To Pipe-1		19832	To Throttle Body	F7UZ 6A664 AA	EMH160
Hose - Heater To Pipe-2		19834	Hose - DPFE Hose Kit		27079
Hose - Pipe-2 To Tee		19833	F450 Super Duty; F550 Super Duty		
Hose - Reservoir To Eng.		22953	Belt - Serpentine; W/A.C.	2C3Z 8620 EB	▲K061000HD
			Belt - Serpentine; W/O A.C.	2C3Z 8620 DA	▲K060806HD

▲Standard Belt Available.
③<Cut to Fit.

②Two Required.

Medium & Heavy-Duty Trucks
(2001 & Newer)

Belts and Coolant Hose for Medium/Heavy-Duty Trucks (2001 & Newer)

Medium & Heavy-Duty Trucks
(2001 & Newer)

Application	Mfr. Part No.	Our No.	Application	Mfr. Part No.	Our No.
Ford - Continued			Ford - Continued		
2004 - Continued			2003 - Continued		
Ford V-10 6.8 L - Continued			Ford V-8 6.0 L Diesel - Continued		
F450 Super Duty; F550 Super Duty - Continued			F450 Super Duty; F550 Super Duty - Continued		
Tensioner Assy.; W/A.C.	1L2Z 6B209 AA	38274	Belt - Alt.; W/Dual Alts.	3C2Z 8620 HA	♣K060658HD
Tensioner Assy.; W/O A.C.	2L3Z 6B209 CA	38329	Tensioner Assy. - Alt.; W/Dual Alts.	3C3Z 6B209 BA	38321
Idler Pulley - Grooved	1L2Z 6C348 AA	36157	Tensioner Assy. - Accessory Drive	3C2Z 6B209 CA	38257
Idler Pulley - Smooth	1L3Z 8678 AB	38001	Idler Pulley - Accessory Drive (Smooth)	3C3Z 8678 BB	36354
Tensioner Pulley; W/A.C.		38006	Idler Pulley - Accessory Drive (Grooved)	3C3Z 8678 EB	36324
Hose - Upper		22431	Idler Pulley - Alt. Drive	3C2Z 8678 CB	②36329
Hose - Lower		22432	Hose - Upper - Eng. To Rad.		22779
Hose - Heater To Intake Manifold; Re-use existing flow restrictor.		19218	Hose - Lower - Eng. To Rad.		22780
Hose - Heater To Pipe-1		19306	Hose - Heater To Pipe-1		19832
Hose - Reservoir To Rad.; W/1" I.D. Hose		19812	Hose - Heater To Pipe-2		19834
Hose - Emission Hose - Hose Connector To Throttle Body	F7UZ 6A664 AA	EMH160	Hose - Pipe-2 To Tee		19833
Hose - DPFE Hose Kit		27079	Hose - Reservoir To Eng.		22953
2003			Hose - Turbo To Pipe (Hot Side)	6C3Z 6C640 C	26220
Caterpillar 3126 Diesel			Hose - Pipe To Intercooler (Hot Side)	YC3Z 6C640 KA	26221
F650 Super Duty; F750 Super Duty			Hose - Intercooler To Pipe (Cold Side); W/Metal Pipe	3C3Z 6C640 AA	26282
Belt - Fan, Alt. & A.C.	YC35 8620 BA	♣K080816HD	Hose - Pipe To Engine (Cold Side); W/Metal Pipe	3C3Z 6C640 BA	26223
Tensioner Assy. - Fan, Alt. & A.C.	1352142	38506	F650 Super Duty; F750 Super Duty		
Tensioner Pulley - Fan, Alt. & A.C.	1352142	36091	Belt - Fan, Alt. & A.C.	1839963C1	♣K080830HD
Hose - Upper - Eng. To Pipe		20611	Tensioner Assy. - Fan, Alt. & A.C.	1833688C1	38556
Hose - Upper - Pipe To Rad.		24232	Hose - Upper - Eng. To Rad.		22774
Hose - Lower - Eng. To Pipe		20611	Hose - Lower - Eng. To Rad.		22775
Hose - Lower - Pipe To Rad.		24232	Ford V-8 7.3 L Diesel		
Cummins ISB Diesel			E450 Super Duty		
F650 Super Duty; F750 Super Duty			Belt - W.P., Fan, Alt., A.C. & Air Compr.	F8UE 8620 DB	♣K081213HD
Belt - Fan, W.P. & Alt.	3943214	♣K080726HD	Belt - W.P., Fan, Alt. & A.C.; W/Dual Alts. ...	F8UZ 8620 EB	♣K081359HD
Belt - Fan & A.C.	YC3Z 8620 AB	♣9375HD	Belt - W.P., Fan, Alt. & A.C.; W/Single Alt. ...	1C2Z 8620 JA	♣K081207HD
Tensioner Assy. - Fan, W.P. & Alt.	3936213	38516	Tensioner Assy.	F8UZ 6B209 CA	38191
Tensioner Pulley - Fan, W.P. & Alt.	3936213	36093	Tensioner Pulley - Smooth		38028
Hose - Upper - Eng. To Pipe		24232	Tensioner Pulley - Grooved		38053
Hose - Upper - Pipe To Rad.		24232	Idler Pulley - Smooth	F8TZ 8678 FA	36234
Hose - Lower - Eng. To Pipe		24232	Hose - Upper		23308
Hose - Lower - Pipe To Rad.		24232	Hose - Lower		23073
Ford V-8 5.4 L			E550 Super Duty		
E450 Super Duty			Belt - W.P., Fan, Alt., A.C. & Air Compr.	F8UE 8620 DB	♣K081213HD
Belt - Serpentine; W/A.C.	2C2Z 8620 DB	K060984	Belt - W.P., Fan, Alt. & A.C.	2C2Z 8620 GA	♣K081223HD
Belt - Serpentine; W/O A.C.	2C3Z 8620 DA	♣K060806HD	Tensioner Assy.	F8UZ 6B209 CA	38191
Tensioner Assy.; W/A.C.	1L2Z 6B209 AA	38274	Tensioner Pulley - Smooth		38028
Tensioner Assy.; W/O A.C.	2L3Z 6B209 CA	38329	Tensioner Pulley - Grooved		38053
Idler Pulley - Smooth	1L3Z 8678 AB	38001	Hose - Upper		23308
Idler Pulley - Grooved	1L2Z 6C348 AA	36157	Hose - Lower		23073
Tensioner Pulley; W/A.C.		38006	F450 Super Duty; F550 Super Duty		
Hose - Upper		22315	Belt - Serpentine - Enhancement Kit; W/O Ambulance Prep. Pkg.; W/Single Alt.; Upper hose routes around serpentine belt; Apr. 29, 2001 & After		22690K
Hose - DPFE Hose Kit		27079	Belt - Serpentine; W/Ambulance Prep. Pkg.; W/Dual Alts.	F8TZ 8620 GC	♣K081377HD
Ford V-8 6.0 L Diesel			Belt - Serpentine; W/Single Alt.; W/Cold Weather Pkg.	1C2Z 8620 NA	♣K081213HD
E450 Super Duty			Belt - Serpentine; W/Single Alt.; W/O Cold Weather Pkg.	1C2Z 8620 LA	♣K081223HD
Belt - Fan, Alt., P.S. & A.C.; W/Single Alt. ...	3C2E 8620 AC	♣K081298HD	Tensioner Assy.	F8TZ 6B209 BA	38191
Belt - Fan, Alt., P.S. & A.C.; W/Dual Alts.	3C2Z 8620 BB	♣K081362HD	Tensioner Pulley - Smooth		38028
Belt - Alt.; W/Dual Alts.	3C2Z 8620 HB	♣K060658HD	Tensioner Pulley - Grooved		38053
Tensioner Assy. - Alt.; W/Dual Alts.	3C3Z 6B209 BA	38321	Idler Pulley - Smooth	F8TZ 8678 FA	36234
Tensioner Assy. - Accessory Drive	3C2Z 6B209 CA	38257	Hose - Upper; Preferred Hose; Upper hose routes around serpentine belt		22433
Idler Pulley - Accessory Drive (Smooth)	3C3Z 8678 BB	36354	Hose - Upper; Optional Hose; Routes through serpentine belt.		22542
Idler Pulley - Accessory Drive (Grooved)	3C3Z 8678 EB	36324	Hose - Lower		22690
Idler Pulley - Alt. Drive	3C2Z 8678 CB	②36329	Hose - Heater To Eng.		19200
Hose - Turbo To Pipe (Hot Side)	4C2Z 6C640 BA	26278	Hose - Heater To W.P.		19201
Hose - Pipe To Intercooler (Hot Side)	4C2Z 6C640 EA	26279	Hose - Rad. To Reservoir; W/3/8" I.D. Hose; Cut at 16" ...		28409
Hose - Intercooler To Pipe (Cold Side)	4C2Z 6C640 CA	26217	Hose - Reservoir To Rad.; W/1" I.D. Hose		19812
Hose - Pipe To Engine (Cold Side)	3C3Z 6C640 BA	26223	F450 Super Duty; F550 Super Duty		
Belt - Fan, Alt., P.S. & A.C.; W/Single Alt. ...	3C3E 8620 DA	♣K081265HD			
Belt - Fan, Alt., P.S. & A.C.; W/Dual Alts.	3C3Z 8620 BC	♣K081325HD			

♣Standard Belt Available.

②Two Required.

Belts and Coolant Hose for Medium/Heavy-Duty Trucks (2001 & Newer)

Application	Mfr. Part No.	Our No.	Application	Mfr. Part No.	Our No.
Ford - Continued			Ford - Continued		
2003 - Continued			2002 - Continued		
Ford V-8 7.3 L Diesel - Continued			Cummins ISB Diesel		
F450 Super Duty; F550 Super Duty - Continued			F650 Super Duty; F750 Super Duty		
Hose - Connector - Heater Hose		②28500	Belt - W.P., Fan & Alt.	3943214	▲K080726HD
Hose - Pipe To Intercooler (Hot Side)	YC3Z 6C640 KA	26221	Belt - Fan & A.C.	YC3Z 8620 AB	▲9375HD
Hose - Manifold To Pipe (Hot Side)	1C3Z 6C640 LA	26223	Tensioner Assy. - Fan, W.P. & Alt.	3936213	38516
Hose - Turbo To Engine	F81Z 6C640 CA	②26213	Tensioner Pulley - Fan, W.P. & Alt.	3936213	36093
Hose - Manifold To Pipe (Cold Side)	1C3Z 6C640 LA	26223	Hose - Upper - Eng. To Pipe		24232
Hose - Pipe To Intercooler (Cold Side)	YC3Z 6C640 KA	26221	Hose - Upper - Pipe To Rad.		24232
F650 Super Duty; F750 Super Duty			Ford V-8 5.4 L		
Belt - W.P., Fan & Alt.; W/Air Brakes	YC3Z 8620 FA	▲K081153HD	E450 Super Duty		
Belt - W.P., Fan & Alt.; W/Hyd. Brakes	YC3Z 8620 HA	▲K080820HD	Belt - Serpentine; W/A.C.	2C2Z 8620 DA	▲K060990HD
Belt - W.P., Fan, Alt. & A.C.; W/Air Brakes ..	YC3Z 8620 EA	▲K081223HD	Belt - Serpentine; W/O A.C.	2C3Z 8620 DA	▲K060806HD
Belt - W.P., Fan, Alt. & A.C.; W/Hyd. Brakes ..	YC3Z 8620 GA	▲K080893HD	Tensioner Assy.; W/A.C.	1L2Z 6B209 AA	38274
Tensioner Assy.	F8TZ 6B209 BA	38191	Tensioner Assy.; W/O A.C.	2L3Z 6B209 CA	38329
Tensioner Pulley - Smooth		38028	Idler Pulley - Smooth	1L3Z 8678 AB	38001
Tensioner Pulley - Grooved		38053	Idler Pulley - Grooved	1L2Z 6C348 AA	36157
Hose - Upper - Eng. To Pipe		≧20611	Tensioner Pulley; W/A.C.		38006
Hose - Upper - Pipe To Rad.		24232	Hose - Upper		22315
Hose - Lower - Eng. To Pipe		≧20611	Hose - Heater To Intake Manifold; W/O Aux. Heater;		
Hose - Lower - Pipe To Rad.		24232	Re-use existing flow restrictor.		19277
Ford V-10 6.8 L			Hose - Heater To Pipe-1; W/O Aux. Heater		19191
E450 Super Duty; E550 Super Duty			Hose - Connector - Heater To Intake Manifold		28501
Belt - Serpentine; W/A.C.	2C2Z 8620 DB	K060984	Hose - Connector - Heater To Pipe-1		28500
Belt - Serpentine; W/O A.C.	2C3Z 8620 DA	▲K060806HD	Hose - Reservoir To Rad.; Cut at 16"		28409
Tensioner Assy.; W/A.C.	1L3Z 6B209 AA	38133	Ford V-8 7.3 L Diesel		
Tensioner Assy.; W/O A.C.	F75Z 6B209 EA	38330	E450 Super Duty		
Idler Pulley	1L2Z 8678 AB	38001	Belt - W.P., Fan, Alt., A.C. & Air Compr.	F8UE 8620 DB	▲K081213HD
Tensioner Pulley; W/A.C.		38006	Belt - W.P., Fan, Alt. & A.C.; W/Dual Alts. ...	F8UZ 8620 EB	▲K081359HD
Hose - Upper		22315	Belt - W.P., Fan, Alt. & A.C.; W/Single Alt. ..	1C2Z 8620 JA	▲K081207HD
Hose - Heater To Intake Manifold; W/O Aux. Heater;			Tensioner Assy.	F8UZ 6B209 CA	38191
Re-use existing flow restrictor.		19277	Tensioner Pulley - Smooth		38028
Hose - Heater To Pipe-1; W/O Aux. Heater		19191	Tensioner Pulley - Grooved		38053
Hose - Emission Hose - Hose Connector			Idler Pulley - Smooth	F8TZ 8678 FA	36234
To Throttle Body	F7UZ 6A664 AA	EMH160	Hose - Upper		23308
Hose - DPFE Hose Kit		27079	Hose - Lower		23073
F450 Super Duty; F550 Super Duty			E550 Super Duty		
Belt - Serpentine; W/A.C.	2C3Z 8620 EB	▲K061000HD	Belt - W.P., Fan, Alt., A.C. & Air Compr.	F8UE 8620 DB	▲K081213HD
Belt - Serpentine; W/O A.C.	2C3Z 8620 DA	▲K060806HD	Belt - W.P., Fan, Alt. & A.C.	2C2Z 8620 GA	▲K081223HD
Tensioner Assy.; W/A.C.	1L2Z 6B209 AA	38274	Tensioner Pulley - Smooth		38028
Tensioner Assy.; W/O A.C.	2L3Z 6B209 CA	38329	Tensioner Pulley - Grooved		38053
Idler Pulley - Smooth	1L3Z 8678 AB	38001	Hose - Upper		23308
Idler Pulley - Grooved	1L2Z 6C348 AA	36157	Hose - Lower		23073
Tensioner Pulley; W/A.C.		38006	F450 Super Duty; F550 Super Duty		
Hose - Upper		22431	Belt - Serpentine - Enhancement Kit; W/O Ambulance		
Hose - Lower		22432	Prep. Pkg.; W/Single Alt.; Upper hose routes around		
Hose - Heater To Intake Manifold; Re-use existing flow			serpentine belt; Apr. 29, 2001 & After		
restrictor.		19218			
Hose - Heater To Pipe-1		19306	Belt - Serpentine; W/Ambulance Prep.		
Hose - Reservoir To Rad.; W/1" I.D. Hose		19812	Pkg.; W/Dual Alts.	F8TZ 8620 GC	▲K081377HD
Hose - Emission Hose - Hose Connector			Belt - Serpentine; W/Single Alt.; W/Cold		
To Throttle Body	F7UZ 6A664 AA	EMH160	Weather Pkg.	1C2Z 8620 NA	▲K081213HD
Hose - DPFE Hose Kit		27079	Belt - Serpentine; W/Single Alt.; W/O Cold		
F650 Super Duty; F750 Super Duty			Weather Pkg.	1C2Z 8620 LA	▲K081223HD
Hose - Emission Hose - Hose Connector			Tensioner Assy.	F8TZ 6B209 BA	38191
To Throttle Body	F7UZ 6A664 AA	EMH160	Tensioner Pulley - Smooth		38028
2002			Tensioner Pulley - Grooved		38053
Caterpillar 3126 Diesel			Idler Pulley - Smooth	F8TZ 8678 FA	36234
F650 Super Duty; F750 Super Duty			Hose - Upper; Preferred Hose; Upper hose routes		
Belt - Fan, Alt. & A.C.	YC35 8620 BA	▲K080816HD	around serpentine belt		22433
Tensioner Assy. - Fan, Alt. & A.C.	1352142	38506	Hose - Upper; Optional Hose; Routes through serpentine		
Tensioner Pulley - Fan, Alt. & A.C.	1352142	36091	belt		22542
Hose - Upper - Eng. To Pipe		20611	Hose - Lower		22690
Hose - Upper - Pipe To Rad.		24232	Hose - Heater To Eng.		19200
Hose - Lower - Eng. To Pipe		20611	Hose - Heater To W.P.		19201
Hose - Lower - Pipe To Rad.		24232	Hose - Rad. To Reservoir; W/3/8" I.D. Hose; Cut at 16" ...		28409
			Hose - Reservoir To Rad.; W/1" I.D. Hose		19812

②Two Required.
≧Cut to Fit.

▲Standard Belt Available.

Medium & Heavy-Duty Trucks
(2001 & Newer)

Belts and Coolant Hose for Medium/Heavy-Duty Trucks (2001 & Newer)

Medium & Heavy-Duty Trucks
(2001 & Newer)

Application	Mfr. Part No.	Our No.	Application	Mfr. Part No.	Our No.
Ford - Continued			Ford - Continued		
2002 - Continued			2001 - Continued		
Ford V-8 7.3 L Diesel - Continued			Cummins ISB Diesel		
F450 Super Duty; F550 Super Duty - Continued			F650 Super Duty; F750 Super Duty		
Hose - Connector - Heater Hose		②28500	Belt - W.P., Fan & Alt.	3943214	♣K080726HD
Hose - Pipe To Intercooler (Hot Side)	YC3Z 6C640 KA	26221	Belt - Fan & A.C.	YC3Z 8620 AB	♣9375HD
Hose - Manifold To Pipe (Hot Side)	1C3Z 6C640 LA	26223	Tensioner Assy. - Fan & A.C.	3936213	38516
Hose - Turbo To Engine	F81Z 6C640 CA	②26213	Tensioner Pulley - Fan & A.C.	3936213	36093
Hose - Manifold To Pipe (Cold Side)	1C3Z 6C640 LA	26223	Hose - Upper - Eng. To Pipe		24232
Hose - Pipe To Intercooler (Cold Side)	YC3Z 6C640 KA	26221	Hose - Upper - Pipe To Rad.		24232
F650 Super Duty; F750 Super Duty			Hose - Lower - Eng. To Pipe		
Belt - W.P., Fan & Alt.; W/Air Brakes	YC3Z 8620 FA	♣K081153HD	Hose - Lower - Pipe To Rad.		
Belt - W.P., Fan & Alt.; W/Hyd. Brakes	YC3Z 8620 HA	♣K080820HD	Ford V-8 5.4 L		
Belt - W.P., Fan, Alt. & A.C.; W/Air Brakes ..	YC3Z 8620 EA	♣K081223HD	E450 Super Duty		
Belt - W.P., Fan, Alt. & A.C.; W/Hyd. Brakes ..	YC3Z 8620 GA	♣K080893HD	Belt - Accessory Belt Drive Kit; W/A.C.		
Tensioner Assy.	F8TZ 6B209 BA	38191	Belt - Serpentine; W/A.C.		
Tensioner Pulley - Smooth		38028	Belt - Serpentine; W/O A.C.		
Tensioner Pulley - Grooved		38053	Tensioner Assy.; W/A.C.		
Hose - Upper - Eng. To Pipe		≈20611	Tensioner Assy.; W/O A.C.		
Hose - Upper - Pipe To Rad.		24232	F75Z 6B209 EA		
Hose - Lower - Eng. To Pipe		≈20611	Idler Pulley		
Hose - Lower - Pipe To Rad.		24232	Tensioner Pulley; W/A.C.		
Ford V-10 6.8 L			Tensioner Pulley; W/O A.C.		
E450 Super Duty; E550 Super Duty			Hose - Upper		
Belt - Serpentine; W/A.C.	2C2Z 8620 DB	K060984	Hose - Lower		
Belt - Serpentine; W/O A.C.	2C3Z 8620 DA	♣K060806HD	Hose - Heater To Intake Manifold; W/O Aux. Heater;		
Tensioner Assy.; W/A.C.	1L2Z 6B209 AA	38274	Re-use existing flow restrictor.		
Tensioner Assy.; W/O A.C.	2L3Z 6B209 CA	38329	Hose - Heater To Pipe-1; W/O Aux. Heater		
Idler Pulley - Smooth	1L3Z 8678 AB	38001	Hose - Emission Hose - Hose Connector		
Idler Pulley - Grooved	1L2Z 6C348 AA	36157	To Throttle Body		
Tensioner Pulley; W/A.C.		38006	F7UZ 6A664 AA		
Hose - Upper		22315	EMH160		
Hose - Heater To Intake Manifold; W/O Aux. Heater;		19277	27079		
Re-use existing flow restrictor.		19191			
Hose - Heater To Pipe-1; W/O Aux. Heater		19191			
Hose - Emission Hose - Hose Connector					
To Throttle Body	F7UZ 6A664 AA	EMH160			
Hose - DPFE Hose Kit		27079			
F450 Super Duty; F550 Super Duty			Ford V-8 7.3 L Diesel		
Belt - Serpentine; W/A.C.	2C3Z 8620 EB	♣K061000HD	E450 Super Duty		
Belt - Serpentine; W/O A.C.	2C3Z 8620 DA	♣K060806HD	Belt - Serpentine; W/Single Alt.		
Tensioner Assy.; W/A.C.	1L2Z 6B209 AA	38274	Belt - Serpentine; W/Dual Alts.;		
Tensioner Assy.; W/O A.C.	2L3Z 6B209 CA	38329	W/Ambulance Prep. Pkg.		
Idler Pulley - Smooth	1L3Z 8678 AB	38001	1C2Z 8620 PA		
Idler Pulley - Grooved	1L2Z 6C348 AA	36157	♣K081362HD		
Idler Pulley; W/A.C.		38006	Tensioner Assy.		
Hose - Upper		22431	F8UZ 6B209 CA		
Hose - Lower		22432	38191		
Hose - Heater To Intake Manifold; Re-use existing flow		19218	Tensioner Pulley - Smooth		
restrictor.		19306	38028		
Hose - Heater To Pipe-1		19812	Tensioner Pulley - Grooved		
Hose - Reservoir To Rad.; W/1" I.D. Hose		19812	38053		
Hose - Emission Hose - Hose Connector			Idler Pulley - Smooth		
To Throttle Body	F7UZ 6A664 AA	EMH160	F8TZ 8678 FA		
Hose - DPFE Hose Kit		27079	36234		
2001			Hose - Upper		
Caterpillar 3126 Diesel			Hose - Lower		
F650 Super Duty; F750 Super Duty			Hose - Heater To Eng.		
Belt - Fan, Alt. & A.C.	YC35 8620 BA	♣K080816HD	19202		
Tensioner Assy. - Fan, Alt. & A.C.	1352142	38506	28409		
Tensioner Pulley - Fan, Alt. & A.C.	1352142	36091	28501		
Hose - Upper - Eng. To Pipe		20611	28500		
Hose - Upper - Pipe To Rad.		24232			
Hose - Lower - Eng. To Pipe		24232			
Hose - Lower - Pipe To Rad.		24232			
			F450 Super Duty; F550 Super Duty		
			Belt - Serpentine - Enhancement Kit; W/O Ambulance		
			Prep. Pkg.; W/Single Alt.; Upper hose routes around		
			serpentine belt; Apr. 28, 2001 & Before		
			22434K		
			Belt - Serpentine - Enhancement Kit; W/O Ambulance		
			Prep. Pkg.; W/Single Alt.; Upper hose routes around		
			serpentine belt; Apr. 29, 2001 & After		
			22690K		
			Belt - Serpentine; W/Ambulance Prep.		
			Pkg.; W/Dual Alts.		
			F8TZ 8620 GC		
			♣K081377HD		
			Belt - Serpentine; W/Single Alt.; W/Cold		
			Weather Pkg.		
			1C2Z 8620 NA		
			♣K081213HD		
			Belt - Serpentine; W/Single Alt.; W/O Cold		
			Weather Pkg.		
			1C2Z 8620 LA		
			♣K081223HD		
			Tensioner Assy.		
			F8TZ 6B209 BA		
			38191		
			Tensioner Pulley - Smooth		
			38028		
			Tensioner Pulley - Grooved		
			38053		
			Idler Pulley - Smooth		
			F8TZ 8678 FA		
			36234		
			Hose - Upper; Preferred Hose; Upper hose routes		
			around serpentine belt		
			22433		
			Hose - Upper; Optional Hose; Routes through serpentine		
			belt.		
			22542		
			Hose - Lower; Apr. 29, 2001 & After		
			22690		
			Hose - Lower; Apr. 28, 2001 & Before		
			22434		
			Hose - Heater To Eng.		
			19200		
			Hose - Heater To W.P.		
			19201		
			Hose - Rad. To Reservoir; W/3/8" I.D. Hose; Cut at 16" ...		
			28409		

②Two Required.
≈Cut to Fit.

♣Standard Belt Available.

Belts and Coolant Hose for Medium/Heavy-Duty Trucks (2001 & Newer)

Application	Mfr. Part No.	Our No.	Application	Mfr. Part No.	Our No.
Ford - Continued			Freightliner - Continued		
2001 - Continued			2015 - Continued		
Ford V-8 7.3 L Diesel - Continued			Cummins ISB Diesel - Continued		
F450 Super Duty; F550 Super Duty - Continued			Business Class M2 - Continued		
Hose - Reservoir To Rad.; W/1" I.D. Hose		19812	Hose - Lower - Rad. To Pipe		20206
Hose - Connector - Heater Hose		Ⓜ28500	Hose - Lower - Pipe To Eng.		Ⓜ20206
Hose - Pipe To Intercooler (Hot Side)	YC3Z 6C640 KA	26221	Hose - Suction - Tank To Pump	0430404000	DEF7063
Hose - Manifold To Pipe (Hot Side)	1C3Z 6C640 LA	26223	Hose - Return - Pump To Tank	0430405000	DEF7064
Hose - Turbo To Engine	F81Z 6C640 CA	Ⓜ26213	Hose - Turbo To Pipe (Hot Side)		26200
Hose - Manifold To Pipe (Cold Side)	1C3Z 6C640 LA	26223	Hose - Pipe To Intercooler (Hot Side)		26200
Hose - Pipe To Intercooler (Cold Side)	YC3Z 6C640 KA	26221	Cummins ISL Diesel		
F650 Super Duty; F750 Super Duty			Business Class M2		
Belt - W.P., Fan & Alt.; W/Air Brakes	YC3Z 8620 FA	♣K081153HD	Belt - Serpentine	0132241146	K080845HD
Belt - W.P., Fan & Alt.; W/Hyd. Brakes	YC3Z 8620 HA	♣K080820HD	Tensioner Assy.	3973819	38627
Belt - W.P., Fan, Alt. & A.C.; W/Air Brakes ..	YC3Z 8620 EA	♣K081223HD	Idler Pulley	3970945	36283
Belt - W.P., Fan, Alt. & A.C.; W/Hyd. Brakes ..	YC3Z 8620 GA	♣K080893HD	Hose - Lower - Rad. To Pipe		Ⓜ28210
Tensioner Assy.	F8T2 6B209 BA	38191	Hose - Lower - Pipe To Eng.		Ⓜ28210
Tensioner Pulley - Smooth		38028	Hose - Return - Pump To Tank	0428919000	DEF7003
Tensioner Pulley - Grooved		38053	Hose - Turbo To Pipe (Hot Side)		26200
Hose - Upper - Eng. To Pipe		Ⓜ20611	Hose - Pipe To Intercooler (Hot Side)		26200
Hose - Upper - Pipe To Rad.		24232	Cummins ISL G CNG		
Hose - Lower - Eng. To Pipe		Ⓜ20611	Business Class M2		
Hose - Lower - Pipe To Rad.		24232	Belt - Serpentine	0132241101	♣K080825HD
Ford V-10 6.8 L			Detroit Diesel DD13 Diesel		
E450 Super Duty			114SD; 122SD; Business Class M2		
Belt - Accessory Belt Drive Kit; W/A.C.		ACK080991	Tensioner Assy.	EA4722000570	38667
Belt - Serpentine; W/A.C.		♣K080991HD	Cascadia		
Belt - Serpentine; W/O A.C.		♣K080806HD	Belt - Serpentine - Fan	0132731635	K100643HD
Tensioner Assy.; W/A.C.		38133	Belt - Serpentine - Alt., W.P. & A.C.	0132732671	♣K081051HD
Tensioner Assy.; W/O A.C.	F75Z 6B209 EA	38330	Tensioner Assy.	EA4722000570	38667
Idler Pulley		38022	Coronado		
Tensioner Pulley; W/A.C.		38023	Tensioner Assy.	EA4722000570	38667
Tensioner Pulley; W/O A.C.		38053	Detroit Diesel DD15 Diesel		
Hose - Upper		22316	122SD		
Hose - Lower		22371	Tensioner Assy.	EA4722000570	38667
Hose - Heater To Intake Manifold; W/O Aux. Heater;			Cascadia		
Re-use existing flow restrictor.		19277	Belt - Serpentine - Fan	0132731635	K100643HD
Hose - Heater To Pipe-1; W/O Aux. Heater		19191	Belt - Serpentine - Alt., W.P. & A.C.	0132732691	♣K081059HD
Hose - Connector - Heater To Intake Manifold		28501	Tensioner Assy.	EA4722000570	38667
Hose - Connector - Heater To Pipe-1		28500	Hose - Upper		23928
Hose - Connector - Aux. Heater		28500	Hose - Turbo To Pipe (Hot Side)	0133096000	26203
Hose - Emission Hose - Hose Connector			Hose - Pipe To Intercooler (Hot Side)	0133096000	26203
To Throttle Body	F7UZ 6A664 AA	EMH160	Coronado		
Hose - DPFE Hose Kit		27079	Tensioner Assy.	EA4722000570	38667
F450 Super Duty; F550 Super Duty			Detroit Diesel DD16 Diesel		
Belt - Fan, Alt., P.S. & A.C.	F81Z 8620 JA	♣K081000HD	122SD; Cascadia; Coronado		
Belt - Fan, Alt. & P.S.	F7UZ 8620 FA	♣K080806HD	Tensioner Assy.	EA4722000570	38667
Tensioner Assy.; W/A.C.	F75Z 6B209 DA	38133	2014		
Tensioner Assy.; W/O A.C.	F75Z 6B209 EA	38330	Cummins ISB Diesel		
Idler Pulley		38022	Business Class M2		
Tensioner Pulley; W/A.C.		38023	Belt - Serpentine	0132241065	K080813HD
Tensioner Pulley - Smooth	F75Z 6B209 DA	38023	Hose - Lower - Rad. To Pipe		Ⓜ20206
Hose - Upper		22431			or
Hose - Lower		22432			Ⓜ28210
Hose - Heater To Intake Manifold; Re-use existing flow			Hose - Lower - Pipe To Eng.		Ⓜ20206
restrictor.		19218	Hose - Suction - Tank To Pump	0430404000	DEF7063
Hose - Heater To Pipe-1		19306	Hose - Return - Pump To Tank	0430405000	DEF7064
Hose - Reservoir To Rad.; W/1" I.D. Hose		19812	Hose - Turbo To Pipe (Hot Side)		26200
Hose - Emission Hose - Hose Connector			Hose - Pipe To Intercooler (Hot Side)		26200
To Throttle Body	F7UZ 6A664 AA	EMH160	MT45		
Hose - DPFE Hose Kit		27079	Belt - Alt. & W.P.	3972263	♣K080830HD
Freightliner			Cummins ISL Diesel		
2015			Business Class M2		
Cummins ISB Diesel			Business Class M2		
Belt - Serpentine	0132241065	K080813HD	Belt - Serpentine	0132241146	K080845HD

Medium & Heavy-Duty Trucks
(2001 & Newer)

ⓂTwo Required.
ⓂCut to Fit.

♣Standard Belt Available.

Belts and Coolant Hose for Medium/Heavy-Duty Trucks (2001 & Newer)

Medium & Heavy-Duty Trucks
(2001 & Newer)

Application	Mfr. Part No.	Our No.	Application	Mfr. Part No.	Our No.
Freightliner - Continued			Freightliner - Continued		
2014 - Continued			2013		
Cummins ISL Diesel - Continued			Cummins ISB Diesel		
Business Class M2 - Continued			Business Class M2		
Tensioner Assy.	3973819	38627	Belt - Serpentine	0132241065	K080813HD
Idler Pulley	3970945	36283	Hose - Lower - Rad. To Pipe		≈20206
Hose - Lower - Rad. To Pipe		≈28210		or	≈28210
Hose - Lower - Pipe To Eng.		≈28210	Hose - Lower - Pipe To Eng.		≈20206
Hose - Return - Pump To Tank	0428919000	DEF7003	Hose - Suction - Tank To Pump	0430404000	DEF7063
Hose - Turbo To Pipe (Hot Side)		26200	Hose - Return - Pump To Tank	0430405000	DEF7064
Hose - Pipe To Intercooler (Hot Side)		26200	Hose - Turbo To Pipe (Hot Side)		26200
			Hose - Pipe To Intercooler (Hot Side)		26200
Cummins ISL G CNG			MT45		
Business Class M2			Belt - Serpentine		
Tensioner Assy.	3973819	38627		5264021	K080907
Idler Pulley	3970945	36283	MT55		
Cummins ISL9 Diesel			Tensioner Assy.		
108SD				3947574	38285
Belt - Serpentine	0132241605	K081025HD	Cummins ISC Diesel		
Tensioner Assy.	3973819	38627	108SD		
Idler Pulley	3970945	36283	Belt - Fan	0132241605	K081025HD
Hose - Return - Pump To Tank	0428919000	DEF7003	Tensioner Assy.	3973819	38627
Hose - Turbo To Pipe (Hot Side)		26200	Idler Pulley	3970945	36283
Hose - Pipe To Intercooler (Hot Side)		26200	Business Class M2		
Hose - Intercooler To Pipe (Cold Side)		26200	Belt - Serpentine	0132241146	K080845HD
Hose - Pipe To Engine (Cold Side)		26200	Tensioner Assy.	3973819	38627
Cummins ISX15 Diesel			Idler Pulley	3970945	36283
Coronado			Hose - Turbo To Pipe (Hot Side)		26200
Belt - Serpentine - Fan	0132161200	K120866HD	Hose - Pipe To Intercooler (Hot Side)		26200
Belt - Serpentine - A.C.	0132162674	♣K060658HD	Hose - Intercooler To Pipe (Cold Side)		26200
Tensioner Assy. - Fan	4299051	38587	Hose - Pipe To Engine (Cold Side)		26200
Tensioner Assy. - A.C.	2891940	38610	Cummins ISL G CNG		
Idler Pulley - A.C.	3682229	36223	Business Class M2		
Hose - Return - Pump To Tank	0428919000	DEF7003	Tensioner Assy.		
Hose - Turbo To Pipe (Hot Side)		26204		3973819	38627
Hose - Pipe To Intercooler (Hot Side)		26204	Idler Pulley		
Detroit Diesel DD13 Diesel				3970945	36283
114SD; 122SD; Business Class M2			Cummins ISL9 Diesel		
Tensioner Assy.	EA4722000570	38667	114SD		
Cascadia			Belt - Fan		
Belt - Serpentine - Fan	0132731635	K100643HD		0132241525	K080994HD
Belt - Serpentine - Alt., W.P. & A.C.	0132732671	♣K081051HD	Cummins ISX15 Diesel		
Tensioner Assy.	EA4722000570	38667	Cascadia		
Coronado			Belt - Fan		
Tensioner Assy.	EA4722000570	38667		0132161200	K120866HD
Detroit Diesel DD15 Diesel			Belt - A.C.		
122SD				0132162674	♣K060658HD
Tensioner Assy.	EA4722000570	38667	Tensioner Assy. - Fan		
Cascadia				2871292	38587
Belt - Serpentine - Fan	0132731635	K100643HD	Tensioner Assy. - A.C.		
Belt - Serpentine - Alt. & A.C.	0132732691	♣K081059HD		2891940	38610
Tensioner Assy.	EA4722000570	38667	Idler Pulley - A.C.		
Hose - Turbo To Pipe (Hot Side)	0133096000	26203		3682229	36223
Hose - Pipe To Intercooler (Hot Side)	0133096000	26203	Hose - Upper - Eng. To Rad.		
Coronado					24440
Belt - Fan	0132731635	K100643HD	Hose - Lower - Eng. To Pipe		
Belt - Alt. & A.C.	0132732700	K081065HD			≈21891
Tensioner Assy.	EA4722000570	38667	Hose - Lower - Pipe To Pipe		
Hose - Return - Pump To Tank	0428651000	DEF7003			≈24440
Hose - Suction - Tank To Pump	0428650000	DEF7004	Hose - Lower - Pipe To Rad.		
Hose - Pressure - Pump To Injector	0428841180	DEF7006			21891
Detroit Diesel DD16 Diesel			Coronado		
122SD; Cascadia; Coronado			Tensioner Assy. - Fan		
Tensioner Assy.	EA4722000570	38667		3682946	38587

≈Cut to Fit.

♣Standard Belt Available.

Belts and Coolant Hose for Medium/Heavy-Duty Trucks (2001 & Newer)

Application	Mfr. Part No.	Our No.	Application	Mfr. Part No.	Our No.
Freightliner - Continued			Freightliner - Continued		
2013 - Continued			2012 - Continued		
Detroit Diesel DD15 Diesel			Cummins ISX15 Diesel - Continued		
Cascadia			Cascadia - Continued		
Belt - Fan	0131893635	K100643HD	Tensioner Assy. - Fan	2871292	38587
Belt - A.C. & Alt.	0132732700	K081065HD	Tensioner Assy. - A.C.	2891940	38610
Tensioner Assy.	EA4722000570	38667	Idler Pulley - A.C.	3682229	36223
Hose - Upper - Eng. To Rad.		23928	Hose - Upper - Eng. To Rad.		≈24640
Hose - Lower - Eng. To Pipe		≈21891	Hose - Lower - Eng. To Pipe		≈21891
Hose - Lower - Pipe To Rad.		≈21891	Hose - Lower - Pipe To Pipe		≈24640
Hose - Return - Pump To Tank	0428651000	DEF7003	Hose - Lower - Pipe To Rad.		21891
Hose - Suction - Tank To Pump	0428650000	DEF7004	Coronado		
Hose - Pressure - Pump To Injector	0428841200	DEF7006	Belt - Fan	0132161200	K120866HD
Coronado			Belt - A.C.	0132162674	♣K060658HD
Belt - Fan	0132731635	K100643HD	Tensioner Assy. - Fan	2871292	38587
Belt - Alt. & A.C.	0132732700	K081065HD	Tensioner Assy. - A.C.	3104149	38610
Tensioner Assy.	A4722000570	38667	Idler Pulley - A.C.	3682229	36223
Hose - Return - Pump To Tank	0428651000	DEF7003	Hose - Lower - Rad. To Pipe		≈21891
Hose - Suction - Tank To Pump	0428650000	DEF7004	Hose - Lower - Pipe To Pipe		≈21135
Hose - Pressure - Pump To Injector	0428841180	DEF7006	Hose - Lower - Pipe To Eng.		≈21891
Detroit Diesel DD16 Diesel			Detroit Diesel DD13 Diesel		
Cascadia			114SD		
Tensioner Assy.	A4722000570	38667	Tensioner Assy.	A4722000570	38667
Coronado			Business Class M2		
Belt - Fan	0132731635	K100643HD	Belt - Alt. & A.C.	0132732680	K081055HD
Belt - A.C. & Alt.	0132732700	K081065HD	Belt - Fan	0132731635	K100643HD
Tensioner Assy.	A4722000570	38667	Tensioner Assy.	A4722000570	38667
Hose - Turbo To Pipe (Hot Side)		26203	Cascadia		
Hose - Pipe To Intercooler (Hot Side)		26203	Belt - Fan	0132731635	K100643HD
Westport ISL G			Belt - Alt. & A.C.	0132732680	K081055HD
Business Class M2			Tensioner Assy.	A4722000570	38667
Tensioner Assy.	3973819	38627	Hose - Lower - Rad. To Pipe		≈21891
Idler Pulley	3970945	36283	Hose - Pressure - Pump To Injector	0428841200	DEF7006
2012			Hose - Suction - Tank To Pump	0428650000	DEF7004
Cummins ISB Diesel			Hose - Return - Pump To Tank	0428651000	DEF7003
Business Class M2			Coronado		
Belt - Fan	0132241065	K080813HD	Belt - Alt. & A.C.	0132732680	K081055HD
Hose - Lower - Rad. To Pipe		≈20206	Belt - Fan	0132731635	K100643HD
or		≈28210	Tensioner Assy.	A4722000570	38667
Hose - Lower - Pipe To Eng.		≈20206	Detroit Diesel DD15 Diesel		
Hose - Suction - Tank To Pump	0430404000	DEF7063	Cascadia		
Hose - Return - Pump To Tank	0430405000	DEF7064	Belt - Fan	0131893635	K100643HD
Hose - Turbo To Pipe (Hot Side)		26200	Belt - A.C. & Alt.	0132732700	K081065HD
Hose - Pipe To Intercooler (Hot Side)		26200	Tensioner Assy.	EA4722000570	38667
Cummins ISC Diesel			Hose - Upper - Eng. To Rad.		23928
Business Class M2			Hose - Lower - Eng. To Pipe		≈21891
Belt - Serpentine	0132241146	K080845HD	Hose - Lower - Pipe To Rad.		≈21891
Tensioner Assy.	3973819	38627	Hose - Return - Pump To Tank	0428651000	DEF7003
Idler Pulley	3970945	36283	Hose - Suction - Tank To Pump	0428650000	DEF7004
Hose - Upper		24035	Hose - Pressure - Pump To Injector	0428841200	DEF7006
Hose - Lower - Rad. To Pipe		≈21379	Coronado		
Hose - Lower - Pipe To Rad.		≈21194	Belt - Fan	0131893635	K100643HD
or		≈28211	Belt - Alt. & A.C.	0132732700	K081065HD
Hose - Turbo To Pipe (Hot Side)		26200	Tensioner Assy.	EA4722000570	38667
Hose - Pipe To Intercooler (Hot Side)		26200	Hose - Upper - Rad. To Pipe		≈24640
Hose - Intercooler To Pipe (Cold Side)		26200	Hose - Upper - Pipe To Eng.		≈24640
Hose - Pipe To Engine (Cold Side)		26200	Detroit Diesel DD16 Diesel		
Cummins ISL-G CNG			Cascadia; Coronado		
Business Class M2			Tensioner Assy.	A4722000570	38667
Tensioner Assy.	3973819	38627	2011		
Cummins ISX15 Diesel			Cummins ISB Diesel		
Cascadia			Business Class M2		
Belt - Fan	0132161200	K120866HD	Belt - Fan	0132241065	K080813HD
Belt - A.C.	0132162674	♣K060658HD	Hose - Lower - Rad. To Pipe		≈20206
			or		≈28210

Medium & Heavy-Duty Trucks (2001 & Newer)

≈Cut to Fit.

♣Standard Belt Available.

Belts and Coolant Hose for Medium/Heavy-Duty Trucks (2001 & Newer)

Medium & Heavy-Duty Trucks
(2001 & Newer)

Application	Mfr. Part No.	Our No.	Application	Mfr. Part No.	Our No.
Freightliner - Continued			Freightliner - Continued		
2011 - Continued			2011 - Continued		
Cummins ISB Diesel - Continued			Detroit Diesel 6-Cyl. 14.0 L Diesel - Continued		
Business Class M2 - Continued			Columbia - Continued		
Hose - Lower - Pipe To Eng.		≈20206	Tensioner Pulley - Hub, Alt. & A.C.	0127425000	38075
Hose - Suction - Tank To Pump	0430404000	DEF7063	Hose - Upper - Rad. To Pipe		≈24640
Hose - Return - Pump To Tank	0430405000	DEF7064	Hose - Upper - Pipe To Eng.		≈24640
Hose - Turbo To Pipe (Hot Side)		26200	Hose - Lower - Rad. To Pipe		≈20987
Hose - Pipe To Intercooler (Hot Side)		26200	Hose - Lower - Pipe To Eng.		≈20987
MT45			Hose - Oil Cooler To Heater; W/Beaded End		CT103
Belt - Alt. & W.P.	3972263	▲K080830HD	Hose - Oil Cooler To Heater; W/Threaded End		CT105
MT55			Hose - Oil Cooler To Aux. Heater; W/Beaded End		CT104
Hose - Upper		23928	Hose - Oil Cooler To Aux. Heater; W/Threaded End		CT106
Cummins ISC Diesel			Hose - W.P. Rear To Heater; W/Beaded End		
Business Class M2			Hose - W.P. Rear To Heater; W/Threaded End		
Belt - Serpentine	0132241146	K080845HD	Hose - W.P. Front To Aux. Heater; W/Beaded End		
Tensioner Assy. - Fan	3973819	38627	Hose - W.P. Front To Aux. Heater; W/Threaded End		
Idler Pulley - Fan	3970945	36283	Hose - W.P. To Reservoir		
Hose - Upper		24035	Detroit Diesel DD13 Diesel		
Hose - Lower - Pipe To Eng.		20412	Business Class M2		
Hose - Lower - Rad. To Pipe		≈21379	Belt - Fan	0131893635	K100643HD
Hose - Turbo To Pipe (Hot Side)		26200	Belt - Alt.	0132732680	K081055HD
Hose - Pipe To Intercooler (Hot Side)		26200	Tensioner Assy.	EA4722000570	38667
Hose - Intercooler To Pipe (Cold Side)		26200	Hose - Upper		24041
Hose - Pipe To Engine (Cold Side)		26200	Cascadia		
Cummins ISX15 Diesel			Belt - Fan		
Cascadia			Belt - Alt.		
Belt - A.C. - From W.P.	0132162674	▲K060658HD	Tensioner Assy.		
Belt - Fan, Alt. & W.P.	0132161200	K120866HD	Hose - Upper		
Tensioner Assy. - A.C.	3104149	38610	Hose - Lower		
Tensioner Assy. - Fan, W.P. & Alt.	2871292	38587	Columbia		
Idler Pulley - A.C.	3682229	36223	Tensioner Assy.		
Hose - Upper - Eng. To Rad.		≈24640	Coronado		
Hose - Lower - Eng. To Pipe		≈21891	Belt - Alt. & A.C.		
Hose - Lower - Pipe To Pipe		≈24440	Belt - Fan		
Hose - Lower - Pipe To Rad.		21891	Tensioner Assy.		
Coronado			Detroit Diesel DD15 Diesel		
Belt - Fan	0132161200	K120866HD	Cascadia		
Belt - A.C.	0132162674	▲K060658HD	Belt - Fan		
Tensioner Assy. - A.C.	3104149	38610	Belt - A.C. & Alt.		
Tensioner Assy. - Fan	2871292	38587	Tensioner Assy.		
Idler Pulley - A.C.	3682229	36223	Hose - Upper - Eng. To Rad.		
Hose - Lower - Rad. To Pipe		≈21891	Hose - Lower - Eng. To Pipe		
Hose - Lower - Pipe To Pipe		≈21135	Hose - Lower - Pipe To Rad.		
Hose - Lower - Pipe To Eng.		≈21891	Century Class; Columbia		
Detroit Diesel 6-Cyl. 14.0 L Diesel			Tensioner Assy.		
Argosy			Coronado		
Belt - Fan	0131893416	K100557HD	Belt - Fan		
Belt - Alt. & A.C.	0129859445	▲K080570HD	Belt - Alt. & A.C.		
Tensioner Assy. - Fan	0127846000	38503	Tensioner Assy.		
Tensioner Assy. - Alt. & A.C.	0127425000	38501	Hose - Upper - Rad. To Pipe		
Cascadia; Century Class			Hose - Upper - Pipe To Eng.		
Hose - Oil Cooler To Heater; W/Beaded End		CT103	Detroit Diesel DD16 Diesel		
Hose - Oil Cooler To Heater; W/Threaded End		CT105	Cascadia; Coronado		
Hose - Oil Cooler To Aux. Heater; W/Beaded End		CT104	Tensioner Assy.		
Hose - Oil Cooler To Aux. Heater; W/Threaded End		CT106	Mercedes-Benz MBE 4000 Diesel		
Hose - W.P. Rear To Heater; W/Beaded End		CT102	Cascadia		
Hose - W.P. Rear To Heater; W/Threaded End		CT108	Belt - A.C.		
Hose - W.P. Front To Aux. Heater; W/Beaded End		CT100	Belt - Fan		
Hose - W.P. Front To Aux. Heater; W/Threaded End		CT107	Tensioner Assy. - Fan		
Hose - W.P. To Reservoir		CT101	Tensioner Assy. - A.C.		
Columbia			Tensioner Pulley - A.C.		
Belt - Fan	0124894004	▲K100502HD	Hose - Upper - Eng. To Pipe		
Belt - Hub, Alt. & A.C.	0129859445	K100557HD	Hose - Upper - Pipe To Rad.		
Tensioner Assy. - Fan	0127846000	38503	Hose - Lower - Eng. To Pipe		
Tensioner Assy. - Hub, Alt. & A.C.	0127425000	38501	Hose - Lower - Pipe To Rad.		
Tensioner Pulley - Fan	0127846000	38076			

▲Standard Belt Available.

≈Cut to Fit.

Belts and Coolant Hose for Medium/Heavy-Duty Trucks (2001 & Newer)

Application	Mfr. Part No.	Our No.	Application	Mfr. Part No.	Our No.
Freightliner - Continued			Freightliner - Continued		
2010			2010 - Continued		
Cummins ISB CNG			Detroit Diesel 6-Cyl. 14.0 L Diesel - Continued		
MT55			Cascadia; Century Class; Classic XL - Continued		
Belt - Alt	3288812	♣K080575HD	Hose - W.P. Front To Aux. Heater; W/Threaded End		CT107
Tensioner Assy. - Alt	3938022	38504	Hose - W.P. To Reservoir		CT101
Cummins ISB Diesel			Columbia		
Business Class M2			Belt - Fan		
Belt - Accessory Drive	0132241065	K080813HD	Belt - Hub, Alt. & A.C.	0124894004	♣K100502HD
Tensioner Assy.	5264111	38631	Tensioner Assy. - Fan	0124587006	♣K080570HD
Hose - Upper		22743	Tensioner Assy. - Hub, Alt. & A.C.	0127846000	38503
Hose - Lower - Rad. To Pipe		≈20206	Tensioner Pulley - Fan	0127425000	38501
		≈28210	Tensioner Pulley - Hub, Alt. & A.C.	0127846000	38076
		or	Tensioner Pulley - Hub, Alt. & A.C.	0127425000	38075
Hose - Lower - Pipe To Eng.		≈20206	Hose - Upper - Rad. To Pipe		≈24640
Hose - Lower		≈24832	Hose - Upper - Pipe To Eng.		≈24640
Hose - Suction - Tank To Pump	0430404000	DEF7063	Hose - Lower - Rad. To Pipe		≈20987
Hose - Return - Pump To Tank	0430405000	DEF7064	Hose - Lower - Pipe To Eng.		≈20987
Hose - Turbo To Pipe (Hot Side)		26200	Hose - Oil Cooler To Heater; W/Beaded End		CT103
Hose - Pipe To Intercooler (Hot Side)		26200	Hose - Oil Cooler To Heater; W/Threaded End		CT105
MT45			Hose - Oil Cooler To Aux. Heater; W/Beaded End		
Belt - Fan, A.C., Alt. & W.P.	3289952	♣K080751HD	Hose - Oil Cooler To Aux. Heater; W/Threaded End		CT106
Tensioner Assy. - Fan, A.C., Alt. & W.P.	3976834	38516	Hose - W.P. Rear To Heater; W/Beaded End		CT102
Tensioner Pulley - Fan, A.C., Alt. & W.P.		36093	Hose - W.P. Rear To Heater; W/Threaded End		CT108
Hose - Upper - Rad. To Pipe		≈24632	Hose - W.P. Front To Aux. Heater; W/Beaded End		CT100
Hose - Upper - Pipe To Eng.		≈24628	Hose - W.P. Front To Aux. Heater; W/Threaded End		CT107
Hose - Lower - Rad. To Pipe		≈24632	Hose - W.P. To Reservoir		CT101
Hose - Lower - Pipe To Rad.		≈24632	Detroit Diesel DD13 Diesel		
MT55			Business Class M2		
Hose - Upper		23114	Tensioner Assy.	A4722000570	38667
Cummins ISC Diesel			Cascadia		
Business Class M2			Belt - Fan		
Belt - Fan, A.C., Alt. & W.P.; W/82" Belt			Belt - Alt.	0132731635	K100643HD
O.C.	0123415100	♣K080820HD	Tensioner Assy.	0131894622	K081032HD
Belt - Fan, A.C., Alt. & W.P.; W/84" Belt O.C.		K080845HD	Hose - Upper	A4722000570	38667
Tensioner Assy. - Fan, A.C., Alt. & W.P.	3973819	38627	Hose - Lower - Rad. To Pipe		≈24037
Idler Pulley - Fan, A.C., Alt. & W.P.	3970945	36283			≈20987
Hose - Upper - Rad. To Pipe		≈24640	Columbia; Coronado		
Hose - Upper - Pipe To Eng.		24043	Tensioner Assy.		
Hose - Lower - Eng. To Pipe		≈21135	A4722000570		
Hose - Turbo To Pipe (Hot Side)		26200	38667		
Hose - Pipe To Intercooler (Hot Side)		26200	Detroit Diesel DD15 Diesel		
Hose - Intercooler To Pipe (Cold Side)		26200	Cascadia		
Hose - Pipe To Engine (Cold Side)		26200	Belt - Alt., P.S., A.C. & Air Compr.		
Cummins ISX15 Diesel			Belt - Fan		
Cascadia			Tensioner Assy.		
Belt - A.C. - From W.P.	0132162619	♣K060637HD	A4722000570		
Belt - Fan, Alt. & W.P.	0132161200	K120866HD	38667		
Tensioner Assy. - A.C.	3104149	38610	23928		
Tensioner Assy. - Fan, W.P. & Alt.	2871292	38587	≈21891		
Idler Pulley - A.C.	3682229	36223	≈21891		
Hose - Upper - Eng. To Rad.		≈24640	Century Class		
Hose - Lower - Eng. To Pipe		≈21891	Belt - Fan		
Hose - Lower - Pipe To Pipe		≈24440	Belt - Hub, Alt. & A.C.		
Hose - Lower - Pipe To Rad.		21891	Tensioner Assy.		
Detroit Diesel 6-Cyl. 14.0 L Diesel			A4722000570		
Argosy			38667		
Tensioner Assy. - Fan	0127846000	38503	Detroit Diesel DD16 Diesel		
Tensioner Assy. - Alt. & A.C.	0127425000	38501	Cascadia; Coronado		
Cascadia; Century Class; Classic XL			Tensioner Assy.		
Hose - Oil Cooler To Heater; W/Beaded End		CT103	A4722000570		
Hose - Oil Cooler To Heater; W/Threaded End		CT105	38667		
Hose - Oil Cooler To Aux. Heater; W/Beaded End		CT104	Mercedes-Benz MBE 4000 Diesel		
Hose - Oil Cooler To Aux. Heater; W/Threaded End		CT106	Business Class M2; Cascadia		
Hose - W.P. Rear To Heater; W/Beaded End		CT102	Belt - W.P., Alt. & A.C.		
Hose - W.P. Rear To Heater; W/Threaded End		CT108	Belt - Fan		
Hose - W.P. Front To Aux. Heater; W/Beaded End		CT100	Tensioner Assy. - W.P., Alt. & A.C.		
			Tensioner Assy. - Fan		
			Tensioner Pulley - W.P., Alt. & A.C.		
			Idler Pulley - W.P., Alt. & A.C.		
			Hose - Upper - Eng. To Pipe		
			Hose - Upper - Pipe To Rad.		

≈Cut to Fit.

♣Standard Belt Available.

Medium & Heavy-Duty Trucks
(2001 & Newer)

Belts and Coolant Hose for Medium/Heavy-Duty Trucks (2001 & Newer)

Medium & Heavy-Duty Trucks
(2001 & Newer)

Application	Mfr. Part No.	Our No.	Application	Mfr. Part No.	Our No.
Freightliner - Continued			Freightliner - Continued		
2010 - Continued			2009 - Continued		
Mercedes-Benz MBE 4000 Diesel - Continued			Cummins ISB Diesel - Continued		
Business Class M2; Cascadia - Continued			MT45 - Continued		
Hose - Lower - Eng. To Pipe		24045	Hose - Lower - Pipe To Eng.		≈<24632
Hose - Lower - Pipe To Rad.		24047	MT55		
Classic; Classic XL			Belt - Fan		
Belt - A.C.	0124587002	♣K080855HD	Belt - Fan	3289963	K080834HD
Belt - Fan	0127116013	♣K080505HD	Tensioner Assy. - Alt. & W.P.	4937433	38631
Tensioner Assy. - Fan		38597	Hose - Upper		23114
Tensioner Assy. - A.C.		38501	Cummins ISC Diesel		
Tensioner Pulley - A.C.		38075	Business Class M2		
Hose - Upper - Eng. To Pipe		≈<24640	Belt - Fan, A.C., Alt. & W.P.		
Hose - Upper - Pipe To Rad.		21891	Belt - Fan, A.C., Alt. & W.P.	0123415100	♣K080820HD
Hose - Lower - Eng. To Pipe		24045	Tensioner Assy. - Fan, A.C., Alt. & W.P.	3973819	38627
Hose - Lower - Pipe To Rad.		24047	Idler Pulley - Fan, A.C., Alt. & W.P.	3970945	36283
Columbia			Hose - Upper - Rad. To Pipe		
Belt - W.P., Alt. & A.C.	0124587002	♣K080855HD	Hose - Upper - Pipe To Eng.		≈<24640
Belt - Fan	0127116013	♣K080505HD	Hose - Upper - Pipe To Eng.		24043
Tensioner Assy. - Fan	0127427001	38597	Hose - Lower - Eng. To Pipe		≈<21135
Tensioner Assy. - Alt.	0127425000	38501	Cummins ISX Diesel		
Idler Pulley	0127426000	36302	Cascadia		
2009			Belt - Fan, Alt. & W.P.		
Caterpillar C13 Diesel			Belt - A.C. - From W.P.		
Business Class M2			Tensioner Assy. - Fan, W.P. & Alt.		
Belt - Alt.	0130884175	♣K060858HD	Tensioner Assy. - Fan, W.P. & Alt.	2871292	38587
Belt - Fan & A.C.	0130883420	K100953HD	Tensioner Assy. - A.C.	3104149	38610
Tensioner Assy. - Alt.	2756558	38635	Idler Pulley - A.C.	3682229	36223
Tensioner Assy. - Fan & A.C.	2873203	38646	Hose - Upper - Eng. To Rad.		≈<24640
Idler Pulley - Alt. (Upper)	2790251	36227	Hose - Lower - Eng. To Pipe		≈<21891
Idler Pulley - Alt. (Lower)	2790251	36227	Hose - Lower - Pipe To Pipe		≈<24640
Idler Pulley - Accessory Drive (Grooved)	2850276	36164	Hose - Lower - Pipe To Rad.		21891
Idler Pulley - Accessory Drive (Smooth)	2850273	36164	Detroit Diesel 6-Cyl. 12.7 L Diesel		
Hose - Lower - Eng. To Pipe		≈<24640	Century Class; Columbia		
Hose - Lower - Pipe To Rad.		≈<21891	Hose - Oil Cooler To Heater; W/Beaded End		
Caterpillar C15 Diesel			Hose - Oil Cooler To Heater; W/Threaded End		
Argosy			Hose - Oil Cooler To Aux. Heater; W/Beaded End		
Tensioner Assy. - Fan & Alt.	2002279	38569	Hose - Oil Cooler To Aux. Heater; W/Threaded End		
Tensioner Assy. - Fan To A.C.	2178938	38511	Hose - W.P. Rear To Heater; W/Beaded End		
Idler Pulley - Smooth	1979641	36091	Hose - W.P. Rear To Heater; W/Threaded End		
Idler Pulley - Grooved	1979642	36341	Hose - W.P. Front To Aux. Heater; W/Beaded End		
Idler Pulley - Fan To A.C.	2178938	36091	Hose - W.P. Front To Aux. Heater; W/Threaded End		
Hose - Upper - Eng. To Rad.		23229	Hose - W.P. To Reservoir		
Hose - Lower - Eng. To Rad.		23015	CT107		
FLD			CT101		
Belt - Fan	0130882000	K120985HD	Coronado		
Belt - A.C.	0131165840	K060723HD	Belt - Fan		
Tensioner Assy. - Fan	2790253	38636	Belt - Hub, Alt. & A.C.		
Tensioner Assy. - A.C.	3368955	38609	Belt - Hub, Alt. & A.C.		
Idler Pulley - Fan (Upper)	2790252	36230	Tensioner Assy. - Fan		
Idler Pulley - Fan (Lower)	2790252	36230	Tensioner Assy. - Hub, Alt. & A.C.		
Idler Pulley - A.C. (Lower)	2850277	36282	Tensioner Pulley - Fan		
Cummins ISB Diesel			Tensioner Pulley - Hub, Alt. & A.C.		
Business Class M2			Hose - Upper - Eng. To Pipe		
Belt - Fan, A.C., Alt. & W.P.	0123415077	K080813HD	Hose - Upper - Pipe To Rad.		
Tensioner Assy. - Fan, A.C., Alt. & W.P.	4937433	38631	Hose - Lower - Eng. To Pipe		
Hose - Upper - Eng. To Pipe		≈<22743	Hose - Lower - Pipe To Rad.		
Hose - Lower - Eng. To Pipe		≈<24632	MT45		
Hose - Lower - Pipe To Rad.		≈<24632	Belt - Fan, A.C., Alt. & W.P.		
MT45			Belt - Fan, A.C., Alt. & W.P.		
Belt - Fan, A.C., Alt. & W.P.	3289952	♣K080751HD	Tensioner Assy. - Fan, A.C., Alt. & W.P.		
Tensioner Assy. - Fan, A.C., Alt. & W.P.	3976834	38516	Tensioner Pulley - Fan, A.C., Alt. & W.P.		
Tensioner Pulley - Fan, A.C., Alt. & W.P.		36093	Hose - Upper - Rad. To Pipe		
Hose - Upper - Rad. To Pipe		≈<24632	Hose - Upper - Pipe To Eng.		
Hose - Upper - Pipe To Eng.		≈<24628	Hose - Lower - Eng. To Pipe		
Hose - Lower - Eng. To Pipe		≈<24632	Detroit Diesel 6-Cyl. 14.0 L Diesel		
Argosy			Argosy		
Tensioner Assy. - Fan			Tensioner Assy. - Fan		
Tensioner Assy. - Alt. & A.C.			Tensioner Assy. - Alt. & A.C.		
Cascadia			Cascadia		
Belt - W.P., Alt. & A.C.; W/58 3/8" Belt			Belt - W.P., Alt. & A.C.; W/58 3/8" Belt		
O.C.			O.C.		
Belt - W.P., Alt. & A.C.; W/56 7/8" Belt			Belt - W.P., Alt. & A.C.; W/56 7/8" Belt		
O.C.			O.C.		
Belt - Fan - From C.S.			Belt - Fan - From C.S.		
Tensioner Assy. - W.P., Alt. & A.C.			Tensioner Assy. - W.P., Alt. & A.C.		
Tensioner Assy. - Fan			Tensioner Assy. - Fan		
Hose - Oil Cooler To Heater; W/Beaded End			Hose - Oil Cooler To Heater; W/Beaded End		
Hose - Oil Cooler To Heater; W/Threaded End			Hose - Oil Cooler To Heater; W/Threaded End		
Hose - Oil Cooler To Aux. Heater; W/Beaded End			Hose - Oil Cooler To Aux. Heater; W/Beaded End		
Hose - Oil Cooler To Aux. Heater; W/Threaded End			Hose - Oil Cooler To Aux. Heater; W/Threaded End		

♣Standard Belt Available.

≈<Cut to Fit.

Belts and Coolant Hose for Medium/Heavy-Duty Trucks (2001 & Newer)

Application	Mfr. Part No.	Our No.	Application	Mfr. Part No.	Our No.
Freightliner - Continued			Freightliner - Continued		
2009 - Continued			2009 - Continued		
Detroit Diesel 6-Cyl. 14.0 L Diesel - Continued			Detroit Diesel DD15 Diesel - Continued		
Cascadia - Continued			Cascadia - Continued		
Hose - W.P. Rear To Heater; W/Beaded End		CT102	Hose - Lower - Eng. To Pipe		≈<21891
Hose - W.P. Rear To Heater; W/Threaded End		CT108	Hose - Lower - Pipe To Rad.		≈<21891
Hose - W.P. Front To Aux. Heater; W/Beaded End		CT100	Century Class		
Hose - W.P. Front To Aux. Heater; W/Threaded End		CT107	Tensioner Assy.	A4722000570	38667
Hose - W.P. To Reservoir		CT101	Columbia		
Century Class; Classic XL			Belt - Alt., P.S., A.C. & Air Compr.	A4729930496	♣K081035HD
Hose - Oil Cooler To Heater; W/Beaded End		CT103	Belt - Fan	0131893635	K100643HD
Hose - Oil Cooler To Heater; W/Threaded End		CT105	Tensioner Assy.	A4722000570	38667
Hose - Oil Cooler To Aux. Heater; W/Beaded End		CT104	Hose - Upper - Eng. To Rad.		23928
Hose - Oil Cooler To Aux. Heater; W/Threaded End		CT106	Hose - Lower - Eng. To Pipe		≈<21891
Hose - W.P. Rear To Heater; W/Beaded End		CT102	Hose - Lower - Pipe To Rad.		≈<21891
Hose - W.P. Rear To Heater; W/Threaded End		CT108	Mercedes-Benz MBE 900 Diesel		
Hose - W.P. Front To Aux. Heater; W/Beaded End		CT100	Business Class M2		
Hose - W.P. Front To Aux. Heater; W/Threaded End		CT107	Belt - Fan - From C.S.	0127116013	♣K080505HD
Hose - W.P. To Reservoir		CT101	Belt - W.P., Fan, Alt. & A.C.	0124587002	♣K080855HD
Columbia			Tensioner Assy. - Alt. & A.C.	0127425000	38501
Belt - Fan	0124894004	♣K100502HD	Tensioner Assy. - Fan	0127427001	38597
Belt - Hub, Alt. & A.C.	0124587006	♣K080570HD	Idler Pulley - Alt. & A.C.	0127426000	36302
Tensioner Assy. - Fan	0127846000	38503	Hose - Upper - Pipe To Rad.		21891
Tensioner Assy. - Hub, Alt. & A.C.	0127425000	38501	Hose - Lower - Eng. To Pipe		24045
Tensioner Pulley - Fan	0127846000	38076	Hose - Lower - Pipe To Rad.		24047
Tensioner Pulley - Hub, Alt. & A.C.	0127425000	38075	MT55		
Hose - Upper - Rad. To Pipe		≈<24640	Hose - Intercooler To Engine (Cold Side) ...	0129982000	29001
Hose - Upper - Pipe To Eng.		≈<24640	Mercedes-Benz MBE 4000 Diesel		
Hose - Lower - Rad. To Pipe		≈<20987	Business Class M2		
Hose - Lower - Pipe To Eng.		≈<20987	Belt - W.P., Alt. & A.C.	0124587002	♣K080855HD
Hose - Oil Cooler To Heater; W/Beaded End		CT103	Belt - Fan	0127116013	♣K080505HD
Hose - Oil Cooler To Heater; W/Threaded End		CT105	Tensioner Assy. - W.P., Alt. & A.C.	0127425000	38501
Hose - Oil Cooler To Aux. Heater; W/Beaded End		CT104	Tensioner Assy. - Fan	0127427001	38597
Hose - Oil Cooler To Aux. Heater; W/Threaded End		CT106	Idler Pulley - Alt. & W.P.	0127426000	36302
Hose - W.P. Rear To Heater; W/Beaded End		CT102	Hose - Upper - Eng. To Pipe		≈<24640
Hose - W.P. Rear To Heater; W/Threaded End		CT108	Hose - Upper - Pipe To Rad.		21891
Hose - W.P. Front To Aux. Heater; W/Beaded End		CT100	Hose - Lower - Eng. To Pipe		24045
Hose - W.P. Front To Aux. Heater; W/Threaded End		CT107	Hose - Lower - Pipe To Rad.		24047
Hose - W.P. To Reservoir		CT101	Cascadia; Century Class; Classic; Classic XL		
Coronado			Belt - A.C.	0124587002	♣K080855HD
Belt - Fan	0124894004	♣K100502HD	Belt - Fan	0127116013	♣K080505HD
Belt - Hub, Alt. & A.C.	0124587004	♣K080565HD	Tensioner Assy. - Fan		38597
Tensioner Assy. - Fan	0127846000	38503	Tensioner Assy. - A.C.		38501
Tensioner Assy. - Hub, Alt. & A.C.	0127425000	38501	Tensioner Pulley - A.C.		38075
Tensioner Pulley - Fan	0127846000	38076	Hose - Upper - Eng. To Pipe		≈<24640
Tensioner Pulley - Hub, Alt. & A.C.	0127425000	38075	Hose - Upper - Pipe To Rad.		21891
Hose - Upper - Eng. To Pipe		21135	Hose - Lower - Eng. To Pipe		24045
Hose - Upper - Pipe To Rad.		≈<24640	Hose - Lower - Pipe To Rad.		24047
Hose - Lower - Eng. To Pipe		≈<24640	Columbia		
Hose - Lower - Pipe To Rad.		24031	Belt - W.P., Alt. & A.C.	0127116004	♣K080855HD
FLD			Belt - Fan	0127116013	♣K080505HD
Belt - Fan	0124587006	♣K080570HD	Tensioner Assy. - Fan	0127427001	38597
Belt - A.C.	0124587000	♣K080580HD	Tensioner Assy. - Hub, Alt. & A.C.	0127425000	38501
Tensioner Assy. - Fan	0127846000	38503	Tensioner Pulley - Hub, Alt. & A.C.	0127425000	38075
Tensioner Assy. - A.C.	0127425000	38501	FLD		
Detroit Diesel DD13 Diesel			Belt - A.C.	0124587002	♣K080855HD
Cascadia			Belt - Fan	0127116013	♣K080505HD
Belt - Fan	0132731635	K100643HD	Tensioner Assy. - Fan		38597
Belt - Alt.	0131894642	♣K081035HD	Tensioner Assy. - A.C.		38501
Tensioner Assy.	A4722000570	38667	Tensioner Pulley - A.C.		38075
Hose - Upper		24037	Hose - Upper - Eng. To Pipe		≈<24640
Hose - Lower - Rad. To Pipe		≈<20987	Hose - Upper - Pipe To Rad.		21891
Detroit Diesel DD15 Diesel			Hose - Lower - Eng. To Pipe		24045
Cascadia			Hose - Lower - Pipe To Rad.		24047
Belt - Fan	0131893635	K100643HD			
Belt - Alt., P.S., A.C. & Air Compr.	0131894642	♣K081035HD			
Tensioner Assy.	A4722000570	38667			
Hose - Upper - Eng. To Rad.		23928			

♣Standard Belt Available.

≈<Cut to Fit.

Medium & Heavy-Duty Trucks
(2001 & Newer)

Belts and Coolant Hose for Medium/Heavy-Duty Trucks (2001 & Newer)

Medium & Heavy-Duty Trucks
(2001 & Newer)

Application	Mfr. Part No.	Our No.	Application	Mfr. Part No.	Our No.
Freightliner - Continued			Freightliner - Continued		
2008			2008 - Continued		
Caterpillar C13 Diesel			Detroit Diesel 6-Cyl. 12.7 L Diesel - Continued		
Columbia			Century Class - Continued		
Belt - Fan, Alt. & A.C.	0123415055	♣K080952HD	Hose - W.P. Rear To Heater; W/Beaded End		CT102
Tensioner Assy. - Fan, Alt. & A.C.	2117895	38590	Hose - W.P. Rear To Heater; W/Threaded End		CT108
Tensioner Pulley - Fan, Alt. & A.C.	2117895	36164	Hose - W.P. Front To Aux. Heater; W/Beaded End		CT100
Idler Pulley - Smooth	2078118	36269	Hose - W.P. Front To Aux. Heater; W/Threaded End		CT107
Idler Pulley - Grooved	1979642	36341	Hose - W.P. To Reservoir		CT101
Hose - Upper - Eng. To Rad.		22950	Columbia		
Hose - Lower - Eng. To Pipe		≈<24640	Belt - Fan	0124894004	♣K100502HD
Hose - Lower - Rad. To Pipe		≈<24640	Belt - Hub To Alt. & A.C.	0124587004	♣K080565HD
Caterpillar C15 Diesel			Tensioner Assy. - Fan	0127846000	38503
Columbia			Tensioner Assy. - Hub, Alt. & A.C.	0127425000	38501
Belt - Fan	0130882000	K120985HD	Tensioner Pulley - Fan	0127846000	38076
Belt - A.C.	0131165840	K060723HD	Tensioner Pulley - Hub, Alt. & A.C.	0127425000	38075
Tensioner Assy. - Alt.	2790253	38636	Hose - Upper - Eng. To Rad.		≈<24640
Tensioner Assy. - A.C.	2362301	38609	Hose - Upper - Rad. To Pipe		≈<24640
Idler Pulley - Alt. (Upper)	2790252	36230	Hose - Lower - Eng. To Rad.		22877
Idler Pulley - Alt. (Lower)	2790252	36230	Hose - Oil Cooler To Heater; W/Beaded End		CT103
Idler Pulley - A.C. (Lower)	2850277	36282	Hose - Oil Cooler To Heater; W/Threaded End		CT105
Coronado			Hose - Oil Cooler To Aux. Heater; W/Beaded End		CT104
Belt - Fan To Alt.	0131165048	K060723HD	Hose - Oil Cooler To Aux. Heater; W/Threaded End		CT106
Idler Pulley - Alt.	2790252	36230	Hose - W.P. Rear To Heater; W/Beaded End		CT102
Idler Pulley - A.C.; W/V-Groove Idler Pulley ..	2850277	36282	Hose - W.P. Rear To Heater; W/Threaded End		CT108
Hose - Lower - Rad. To Pipe		21891	Hose - W.P. Front To Aux. Heater; W/Beaded End		CT100
FLD			Hose - W.P. Front To Aux. Heater; W/Threaded End		CT107
Belt - Fan & Alt.	0123415079	♣K080991HD	Hose - W.P. To Reservoir		CT101
Belt - Fan To A.C.	0127177010	♣K060586HD	Coronado		
Tensioner Assy. - Fan & Alt.	2002279	38569	Belt - Fan	0124894004	♣K100502HD
Tensioner Assy. - Fan To A.C.	2178938	38511	Belt - Hub, Alt. & A.C.	0124587004	♣K080565HD
Idler Pulley - Smooth	1979641	36091	Tensioner Assy. - Fan	0127846000	38503
Idler Pulley - Grooved	1979642	36341	Tensioner Assy. - Hub, Alt. & A.C.	0127425000	38501
Tensioner Pulley - Fan To A.C.	2178938	36091	Tensioner Pulley - Fan	0127846000	38076
Hose - Upper - Eng. To Rad.		23229	Tensioner Pulley - Hub, Alt. & A.C.	0127425000	38075
Hose - Lower - Eng. To Rad.		23015	Hose - Upper - Eng. To Pipe		21135
Cummins ISB Diesel			Hose - Upper - Pipe To Rad.		≈<24640
Business Class M2			Hose - Lower - Eng. To Pipe		≈<24640
Belt - Fan, Alt. & A.C.	0123415077	K080813HD	Hose - Lower - Pipe To Rad.		24031
Tensioner Assy. - Fan, Alt. & A.C.	4937433	38631	FLD		
Idler Pulley - Fan, Alt. & A.C.	4991240	36093	Belt - Fan	0124894000	♣K100579HD
Hose - Upper - Eng. To Rad.		22743	Belt - Hub To Alt. & A.C.	0124587004	♣K080565HD
Hose - Lower - Eng. To Pipe		≈<24632	Tensioner Assy. - Fan	0127846000	38503
Hose - Lower - Rad. To Pipe		≈<24632	Tensioner Assy. - Hub, Alt. & A.C.	0127425000	38501
MT55			Tensioner Pulley - Fan	0127846000	38076
Belt - Alt. & W.P.	3289963	K080834HD	Tensioner Pulley - Hub, Alt. & A.C.	0127425000	38075
Tensioner Assy. - Alt. & W.P.	5264111	38631	Hose - Upper - Eng. To Pipe		≈<24640
Hose - Upper		23114	Hose - Upper - Rad. To Pipe		≈<21115
Cummins ISC Diesel			Hose - Lower - Eng. To Pipe		≈<24640
Business Class M2			Hose - Lower - Rad. To Pipe		21135
Belt - Fan, Alt. & A.C.	0123415100	♣K080820HD	Detroit Diesel 6-Cyl. 14.0 L Diesel		
Tensioner Assy.	3973819	38627	Argosy		
Idler Pulley	3970945	36283	Tensioner Assy. - Fan	0127846000	38503
Hose - Upper - Eng. To Pipe		≈<24636	Tensioner Assy. - Alt. & A.C.	0127425000	38501
Hose - Upper - Rad. To Pipe		≈<24632	Cascadia		
Hose - Lower - Eng. To Pipe		≈<24636	Belt - Fan	0124894004	♣K100502HD
Hose - Lower - Rad. To Pipe		≈<24632	Belt - Alt. & A.C.	0124587000	♣K080580HD
Detroit Diesel 6-Cyl. 12.7 L Diesel			Tensioner Assy. - Fan	0127846000	38503
Argosy			Tensioner Assy. - Alt. & A.C.	0127425000	38501
Tensioner Assy. - Fan	0127846000	38503	Tensioner Pulley - Fan	0127846000	38076
Tensioner Assy. - Alt. & A.C.	0127425000	38501	Tensioner Pulley - Alt. & A.C.	0127425000	38075
Century Class			Hose - Upper - Eng. To Pipe		≈<24640
Hose - Oil Cooler To Heater; W/Beaded End		CT103	Hose - Upper - Rad. To Pipe		≈<24640
Hose - Oil Cooler To Heater; W/Threaded End		CT105	Hose - Lower - Eng. To Pipe		≈<24640
Hose - Oil Cooler To Aux. Heater; W/Beaded End		CT104	Hose - Lower - Rad. To Pipe		21891
Hose - Oil Cooler To Aux. Heater; W/Threaded End		CT106	Hose - Oil Cooler To Heater; W/Beaded End		CT103
			Hose - Oil Cooler To Heater; W/Threaded End		CT105
			Hose - Oil Cooler To Aux. Heater; W/Beaded End		CT104

≈<Cut to Fit.

♣Standard Belt Available.

Belts and Coolant Hose for Medium/Heavy-Duty Trucks (2001 & Newer)

Application	Mfr. Part No.	Our No.	Application	Mfr. Part No.	Our No.
Freightliner - Continued			Freightliner - Continued		
2008 - Continued			2008 - Continued		
Detroit Diesel 6-Cyl. 14.0 L Diesel - Continued			Detroit Diesel 6-Cyl. 14.0 L Diesel - Continued		
Cascadia - Continued			Columbia - Continued		
Hose - Oil Cooler To Aux. Heater; W/Threaded End		CT106	Hose - W.P. Rear To Heater; W/Beaded End		CT102
Hose - W.P. Rear To Heater; W/Beaded End		CT102	Hose - W.P. Rear To Heater; W/Threaded End		CT108
Hose - W.P. Rear To Heater; W/Threaded End		CT108	Hose - W.P. Front To Aux. Heater; W/Beaded End		CT100
Hose - W.P. Front To Aux. Heater; W/Beaded End		CT100	Hose - W.P. Front To Aux. Heater; W/Threaded End		CT107
Hose - W.P. Front To Aux. Heater; W/Threaded End		CT107	Hose - W.P. To Reservoir		CT101
Hose - W.P. To Reservoir		CT101			
Century Class			Coronado		
Belt - Alt.	0124587006	♣K080570HD	Belt - Fan	0124894004	♣K100502HD
Belt - Fan	GT4100502DF	♣K100502HD	Belt - Hub, Alt. & A.C.	0124587004	♣K080565HD
Tensioner Assy.	0127425000	38501	Tensioner Assy. - Fan	0127846000	38503
Hose - Oil Cooler To Heater; W/Beaded End		CT103	Tensioner Assy. - Hub, Alt. & A.C.	0127425000	38501
Hose - Oil Cooler To Heater; W/Threaded End		CT105	Tensioner Pulley - Fan	0127846000	38076
Hose - Oil Cooler To Aux. Heater; W/Beaded End		CT104	Tensioner Pulley - Hub, Alt. & A.C.	0127425000	38075
Hose - Oil Cooler To Aux. Heater; W/Threaded End		CT106	Hose - Upper - Eng. To Pipe		21135
Hose - W.P. Rear To Heater; W/Beaded End		CT102	Hose - Upper - Pipe To Rad.		≈<24640
Hose - W.P. Rear To Heater; W/Threaded End		CT108	Hose - Lower - Eng. To Pipe		≈<24640
Hose - W.P. Front To Aux. Heater; W/Beaded End		CT100	Hose - Lower - Pipe To Rad.		24031
Hose - W.P. Front To Aux. Heater; W/Threaded End		CT107			
Hose - W.P. To Reservoir		CT101	FLD		
Classic			Belt - Fan	0124894004	♣K100502HD
Belt - Fan	0124894004	♣K100502HD	Belt - Hub, Alt. & A.C.	0124587006	♣K080570HD
Belt - Hub, Alt. & A.C.	0124587006	♣K080570HD	Tensioner Assy. - Fan	0127846000	38503
Tensioner Assy. - Fan	0127846000	38503	Tensioner Assy. - Hub, Alt. & A.C.	0127425000	38501
Tensioner Assy. - Hub, Alt. & A.C.	0127425000	38501	Tensioner Pulley - Fan	0127846000	38076
Tensioner Pulley - Fan	0127846000	38076	Tensioner Pulley - Hub, Alt. & A.C.	0127425000	38075
Tensioner Pulley - Hub, Alt. & A.C.	0127425000	38075	Hose - Upper - Eng. To Pipe		≈<24640
Hose - Upper - Eng. To Pipe		≈<24640	Hose - Upper - Rad. To Pipe		≈<24640
Hose - Upper - Rad. To Pipe		≈<24640	Hose - Lower - Eng. To Pipe		≈<24640
Hose - Lower - Eng. To Pipe		≈<24640	Hose - Lower - Pipe To Rad.		≈<24640
Hose - Lower - Rad. To Pipe		21891			
Classic XL			Detroit Diesel DD15 Diesel		
Belt - Fan	0124894004	♣K100502HD	Cascadia		
Belt - Hub, Alt. & A.C.	0124587006	♣K080570HD	Belt - Fan	0131893635	K100643HD
Tensioner Assy. - Fan	0127846000	38503	Belt - Alt., P.S., A.C. & Air Compr.	0131894642	♣K081035HD
Tensioner Assy. - Hub, Alt. & A.C.	0127425000	38501	Tensioner Assy. - W.P., Alt. & A.C.	A4722000170	38667
Tensioner Pulley - Fan	0127846000	38076	Hose - Upper - Eng. To Rad.		23928
Tensioner Pulley - Hub, Alt. & A.C.	0127425000	38075	Hose - Lower - Eng. To Pipe		≈<21891
Hose - Upper - Eng. To Pipe		≈<24640	Hose - Lower - Pipe To Rad.		≈<21891
Hose - Upper - Rad. To Pipe		≈<24640	Century Class; Columbia		
Hose - Lower - Eng. To Pipe		≈<24640	Tensioner Assy.	A4722000570	38667
Hose - Lower - Rad. To Pipe		21891	Mercedes-Benz MBE 900 Diesel		
Hose - Oil Cooler To Heater; W/Beaded End		CT103	Business Class M2		
Hose - Oil Cooler To Heater; W/Threaded End		CT105	Belt - Fan, Alt. & A.C.	0129866094	♣K080825HD
Hose - Oil Cooler To Aux. Heater; W/Beaded End		CT104	Tensioner Assy. - Alt. & A.C.	9062003170	38567
Hose - Oil Cooler To Aux. Heater; W/Threaded End		CT106	Hose - Upper - Eng. To Pipe		≈<24632
Hose - W.P. Rear To Heater; W/Beaded End		CT102	Hose - Upper - Rad. To Pipe		≈<24632
Hose - W.P. Rear To Heater; W/Threaded End		CT108	Hose - Lower - Eng. To Pipe		20206
Hose - W.P. Front To Aux. Heater; W/Beaded End		CT100	Hose - Lower - Rad. To Pipe		20206
Hose - W.P. Front To Aux. Heater; W/Threaded End		CT107	Mercedes-Benz MBE 4000 Diesel		
Hose - W.P. To Reservoir		CT101	Business Class M2		
Columbia			Belt - Fan	0127116013	♣K080505HD
Belt - Fan	0124894004	♣K100502HD	Cascadia		
Belt - Hub, Alt. & A.C.	0124587006	♣K080570HD	Belt - A.C.	0124587002	♣K080855HD
Tensioner Assy. - Fan	0127846000	38503	Belt - Fan	0127116013	♣K080505HD
Tensioner Assy. - Hub, Alt. & A.C.	0127425000	38501	Tensioner Assy. - Fan		38597
Tensioner Pulley - Fan	0127846000	38076	Tensioner Assy. - A.C.		38501
Tensioner Pulley - Hub, Alt. & A.C.	0127425000	38075	Tensioner Pulley - A.C.		38075
Hose - Upper - Eng. To Pipe		≈<24640	Hose - Upper - Eng. To Pipe		≈<24640
Hose - Upper - Rad. To Pipe		≈<24640	Hose - Upper - Pipe To Rad.		21891
Hose - Lower - Eng. To Pipe		≈<24640	Hose - Lower - Eng. To Pipe		24045
Hose - Lower - Rad. To Pipe		≈<21115	Hose - Lower - Pipe To Rad.		24047
Hose - Oil Cooler To Heater; W/Beaded End		CT103	Columbia		
Hose - Oil Cooler To Heater; W/Threaded End		CT105	Belt - Fan	0127116013	♣K080505HD
Hose - Oil Cooler To Aux. Heater; W/Beaded End		CT104	Belt - Hub, Alt. & A.C.	0127116004	♣K080855HD
Hose - Oil Cooler To Aux. Heater; W/Threaded End		CT106	Tensioner Assy. - Fan	0127427001	38597
			Tensioner Assy. - Hub, Alt. & A.C.	0127425000	38501
			Tensioner Pulley - Hub, Alt. & A.C.	0127425000	38075

♣Standard Belt Available.

≈<Cut to Fit.

Medium & Heavy-Duty Trucks
(2001 & Newer)

Belts and Coolant Hose for Medium/Heavy-Duty Trucks (2001 & Newer)

Medium & Heavy-Duty Trucks
(2001 & Newer)

Application	Mfr. Part No.	Our No.	Application	Mfr. Part No.	Our No.
Freightliner - Continued			Freightliner - Continued		
2007			2007 - Continued		
Caterpillar 3126 Diesel			Caterpillar C13 Diesel - Continued		
Business Class M2			Business Class M2 - Continued		
Belt - Fan, Alt. & A.C.; W/145A. Alt.	0123415040	♣K080774HD	Idler Pulley - Grooved	1979642	36341
Belt - Fan, Alt. & A.C.; W/130A. Alt.	0123415058	♣K080780HD	Hose - Upper - Eng. To Rad.		23086
Tensioner Assy. - Fan, Alt. & A.C.	2201209	38550	Hose - Lower - Eng. To Rad.		22952
Idler Pulley - Smooth	1979641	36091	Century Class; Classic; Classic XL		
Idler Pulley	2534525	36096	Belt - Accessory Drive	0123415080	♣K081005HD
Hose - Upper - Eng. To Rad.		22745	Tensioner Assy.	2117895	38590
Hose - Lower - Eng. To Pipe		≈<24632	Idler Pulley - Smooth	2078118	36269
Hose - Lower - Rad. To Pipe		≈<24640	Idler Pulley - Grooved	1979642	36341
Hose - Lower - Pipe To Cooler		21128	Columbia		
Hose - Lower - Cooler To Pipe		21128	Belt - Fan, Alt. & A.C.	0123415055	♣K080952HD
Caterpillar C7 Diesel			Tensioner Assy. - Fan, Alt. & A.C.	2117895	38590
Business Class M2			Tensioner Pulley - Fan, Alt. & A.C.	2117895	36164
Belt - Fan, Alt. & A.C.; W/145A. Alt.	0123415040	♣K080774HD	Idler Pulley - Smooth	2078118	36269
Belt - Fan, Alt. & A.C.; W/130A. Alt.	0123415058	♣K080780HD	Idler Pulley - Grooved	1979642	36341
Tensioner Assy. - Fan, Alt. & A.C.	2201209	38550	Hose - Upper - Eng. To Rad.		22950
Idler Pulley - Upper	1979641	36091	Hose - Lower - Eng. To Pipe		≈<24640
Idler Pulley - Lower	2534525	36096	Hose - Lower - Rad. To Pipe		≈<24640
Hose - Upper - Eng. To Rad.		22745	FLD		
Hose - Lower - Eng. To Pipe		≈<24632	Belt - Fan, Alt. & A.C.	0123415080	♣K081005HD
Hose - Lower - Rad. To Pipe		≈<24640	Tensioner Assy. - Fan, Alt. & A.C.	2117895	38590
Hose - Lower - Pipe To Cooler		21128	Tensioner Pulley - Fan, Alt. & A.C.	2117895	36164
Hose - Lower - Cooler To Pipe		21128	Idler Pulley - Smooth	2078118	36269
Caterpillar C9 Diesel			Idler Pulley - Grooved	1979642	36341
Business Class M2			Hose - Upper - Eng. To Pipe		≈<24640
Belt - Fan, Alt. & A.C.	0123415069	♣K080785HD	Hose - Upper - Rad. To Pipe		≈<24640
Tensioner Assy. - Fan, Alt. & A.C.	2201209	38550	Hose - Lower - Eng. To Pipe		≈<24640
Idler Pulley - Smooth	2078118	36269	Hose - Lower - Rad. To Pipe		21135
Hose - Upper - Eng. To Rad.		23085	Caterpillar C15 Diesel		
Hose - Lower - Eng. To Rad.		23173	Century Class; Classic		
Caterpillar C11 Diesel			Idler Pulley - Smooth	1979641	36091
Business Class M2			Idler Pulley - Grooved	1979642	36341
Belt - Fan, Alt. & A.C.	0123415080	♣K081005HD	Classic XL		
Tensioner Assy. - Fan, Alt. & A.C.	2117895	38590	Belt - Fan & Alt.	0123415079	♣K080991HD
Tensioner Pulley - Fan, Alt. & A.C.	2117895	36164	Belt - Fan To A.C.	0127177010	♣K060586HD
Idler Pulley - Smooth	2078118	36269	Tensioner Assy. - Fan & Alt.	2002279	38569
Idler Pulley - Grooved	1979642	36341	Tensioner Assy. - Fan To A.C.	2178938	38511
Hose - Upper - Eng. To Rad.		23086	Idler Pulley - Smooth	1979641	36091
Hose - Lower - Eng. To Rad.		22952	Idler Pulley - Grooved	1979642	36341
Columbia			Tensioner Pulley - Fan To A.C.	2178938	36091
Belt - Fan, Alt. & A.C.	0123415080	♣K081005HD	Hose - Upper - Eng. To Rad.		23229
Tensioner Assy. - Fan, Alt. & A.C.	2117895	38590	Hose - Lower - Eng. To Rad.		23015
Tensioner Pulley - Fan, Alt. & A.C.	2117895	36164	Columbia		
Idler Pulley - Smooth	2078118	36269	Belt - Fan: W/93" Belt O.C.	0123415078	♣K080926HD
Idler Pulley - Grooved	1979642	36341	Belt - Fan: W/69 5/8" Belt O.C.	0123415098	♣K080694HD
Hose - Upper - Eng. To Rad.		23086	Belt - A.C. & Alt.	0129729610	♣K060635HD
Hose - Lower - Eng. To Rad.		22952	Tensioner Assy. - Fan	2002279	38569
FLD			Idler Pulley - Smooth	1979641	36091
Belt - Fan, Alt. & A.C.	0123415080	♣K081005HD	Idler Pulley - Grooved	1979642	36341
Tensioner Assy. - Fan, Alt. & A.C.	2117895	38590	Hose - Upper - Eng. To Pipe		≈<24640
Tensioner Pulley - Fan, Alt. & A.C.	2117895	36164	Hose - Upper - Pipe To Rad.		≈<21891
Idler Pulley - Smooth	2078118	36269	Hose - Lower - Pipe To Pipe		≈<24640
Idler Pulley - Grooved	1979642	36341	Coronado		
Hose - Upper - Eng. To Pipe		≈<24640	Belt - Fan & Alt.	5080990	♣K080991HD
Hose - Upper - Rad. To Pipe		≈<24640	Belt - A.C.	0129730485	♣K060586HD
Hose - Lower - Eng. To Pipe		≈<24640	Tensioner Assy. - Fan & Alt.	2002279	38569
Hose - Lower - Rad. To Pipe		21135	Tensioner Assy. - A.C.	2178938	38511
Caterpillar C13 Diesel			Idler Pulley - Smooth	1979641	36091
Business Class M2			Idler Pulley - Grooved	1979642	36341
Belt - Hub, Fan, Alt. & A.C.	0123415055	♣K080952HD	Hose - Lower		23084
Tensioner Assy. - Hub, Fan, Alt. & A.C.	2117895	38590	FLD		
Tensioner Pulley - Hub, Fan, Alt. & A.C.	2117895	36164	Belt - Fan & Alt.	0123415079	♣K080991HD
Idler Pulley - Smooth	2078118	36269	Belt - Fan To A.C.	0127177010	♣K060586HD
			Tensioner Assy. - Fan & Alt.	2002279	38569
			Tensioner Assy. - A.C.	2178938	38511
			Idler Pulley - Smooth	1979641	36091
			Idler Pulley - Grooved	1979642	36341
			Hose - Lower		23084
			FLD		
			Belt - Fan & Alt.	0123415079	♣K080991HD
			Belt - Fan To A.C.	0127177010	♣K060586HD
			Tensioner Assy. - Fan & Alt.	2002279	38569
			Tensioner Assy. - Fan To A.C.	2178938	38511

♣Standard Belt Available.

≈<Cut to Fit.

Belts and Coolant Hose for Medium/Heavy-Duty Trucks (2001 & Newer)

Application	Mfr. Part No.	Our No.	Application	Mfr. Part No.	Our No.
Freightliner - Continued			Freightliner - Continued		
2007 - Continued			2007 - Continued		
Caterpillar C15 Diesel - Continued			Detroit Diesel 6-Cyl. 12.7 L Diesel - Continued		
FLD - Continued			Argosy - Continued		
Idler Pulley - Smooth	1979641	36091	Hose - Lower - Cooler To Pipe		≈24644
Idler Pulley - Grooved	1979642	36341	Hose - Lower - Rad. To Pipe		≈21891
Tensioner Pulley - Fan To A.C.	2178938	36091	Century Class		
Hose - Upper - Eng. To Rad.		23229	Belt - Fan	0124894004	▲K100502HD
Hose - Lower - Eng. To Rad.		23015	Belt - Hub To Alt. & A.C.	0124587004	▲K080565HD
Cummins ISB CNG			Tensioner Assy. - Fan	0127846000	38503
MT45			Tensioner Assy. - Hub, Alt. & A.C.	0127425000	38501
Belt - Alt.	3288812	▲K080575HD	Tensioner Pulley - Fan	0127846000	38076
Tensioner Assy. - Alt.	3978022	38504	Tensioner Pulley - Hub, Alt. & A.C.	0127425000	38075
Cummins ISB Diesel			Hose - Upper - Eng. To Pipe		≈24640
Business Class M2			Hose - Upper - Rad. To Pipe		≈24640
Belt - Fan, Alt. & A.C.	0123415077	K080813HD	Hose - Lower - Eng. To Rad.		22877
Tensioner Assy. - Fan, Alt. & A.C.	4937433	38631	Hose - Oil Cooler To Heater; W/Beaded End		CT103
Hose - Upper - Eng. To Pipe		≈24632	Hose - Oil Cooler To Heater; W/Threaded End		CT105
Hose - Upper - Rad. To Pipe		≈24632	Hose - Oil Cooler To Aux. Heater; W/Beaded End		CT104
Hose - Lower - Eng. To Pipe		≈24632	Hose - Oil Cooler To Aux. Heater; W/Threaded End		CT106
Hose - Lower - Rad. To Pipe		≈24632	Hose - W.P. Rear To Heater; W/Beaded End		CT102
FC80			Hose - W.P. Rear To Heater; W/Threaded End		CT108
Belt - Fan & W.P.	3290073	▲K080605HD	Hose - W.P. Front To Aux. Heater; W/Beaded End		CT100
Tensioner Assy. - Alt. & W.P.	3957433	38517	Hose - W.P. Front To Aux. Heater; W/Threaded End		CT107
MT45; MT55			Hose - W.P. To Reservoir		CT101
Belt - Fan, Alt. & A.C.	3289864	▲K080825HD	Classic		
Tensioner Assy. - Fan, Alt. & A.C.	3976831	38516	Belt - Fan	0124894000	▲K100579HD
Hose - Upper - Eng. To Rad.		23114	Belt - Hub, Alt. & A.C.	0124587004	▲K080565HD
Hose - Lower - Eng. To Pipe		≈24636	Tensioner Assy. - Fan	0127846000	38503
Hose - Lower - Rad. To Pipe		≈24636	Tensioner Assy. - Hub, Alt. & A.C.	0127425000	38501
Cummins ISC Diesel			Tensioner Pulley - Fan	0127846000	38076
Business Class M2			Tensioner Pulley - Hub, Alt. & A.C.	0127425000	38075
Belt - Fan, Alt. & A.C.	0123415100	▲K080820HD	Hose - Upper - Eng. To Pipe		≈24640
Tensioner Assy.	3973819	38627	Hose - Upper - Rad. To Pipe		≈21115
Idler Pulley	3970945	36283	Hose - Lower - Eng. To Pipe		≈24640
Hose - Upper - Eng. To Pipe		≈24636	Hose - Lower - Rad. To Pipe		21135
Hose - Upper - Rad. To Pipe		≈24632	Classic XL		
Hose - Lower - Eng. To Pipe		≈24636	Belt - Fan	0124894000	▲K100579HD
Hose - Lower - Rad. To Pipe		≈24632	Belt - Hub, Alt. & A.C.	0124587004	▲K080565HD
Cummins ISL Diesel			Tensioner Assy. - Fan	0127846000	38503
Condor			Tensioner Assy. - Hub, Alt. & A.C.	0127425000	38501
Belt - Fan		▲K080765HD	Tensioner Pulley - Fan	0127846000	38076
Belt - A.C.		▲9412HD	Tensioner Pulley - Hub, Alt. & A.C.	0127425000	38075
Tensioner Assy.	3976831	38516	Hose - Upper - Eng. To Pipe		≈24640
Hose - Upper - Rad. To Pipe		≈24232	Hose - Upper - Rad. To Pipe		≈21115
or		≈24832	Hose - Lower - Eng. To Pipe		≈24640
Hose - Upper - Pipe To Eng.		≈24636	Hose - Lower - Rad. To Pipe		21135
Hose - Lower - Rad. To Cooler		24210	Hose - Oil Cooler To Heater; W/Beaded End		CT103
Hose - Lower - Cooler To Pipe		≈21891	Hose - Oil Cooler To Heater; W/Threaded End		CT105
Hose - Lower - Pipe To Eng.		≈24636	Hose - Oil Cooler To Aux. Heater; W/Beaded End		CT104
Cummins ISM Diesel			Hose - Oil Cooler To Aux. Heater; W/Threaded End		CT106
Columbia			Hose - W.P. Rear To Heater; W/Beaded End		CT102
Belt - Alt.	0127110006	▲K080730HD	Hose - W.P. Rear To Heater; W/Threaded End		CT108
Belt - A.C.	0126709009	▲K060575HD	Hose - W.P. Front To Aux. Heater; W/Beaded End		CT100
Detroit Diesel 6-Cyl. 12.7 L Diesel			Hose - W.P. Front To Aux. Heater; W/Threaded End		CT107
Argosy			Hose - W.P. To Reservoir		CT101
Belt - Fan	0124894000	▲K100579HD	Columbia		
Belt - Alt. & A.C.	0124587000	▲K080580HD	Belt - Fan	0124894004	▲K100502HD
Tensioner Assy. - Fan		38503	Belt - Hub To Alt. & A.C.	0124587004	▲K080565HD
Tensioner Assy. - Alt. & A.C.	23520317	38501	Tensioner Assy. - Fan	0127846000	38503
Tensioner Pulley - Fan		38076	Tensioner Assy. - Hub, Alt. & A.C.	0127425000	38501
Tensioner Pulley - Alt. & A.C.		38075	Tensioner Pulley - Fan	0127846000	38076
Hose - Upper - Eng. To Pipe		≈24640	Tensioner Pulley - Hub, Alt. & A.C.	0127425000	38075
Hose - Upper - Rad. To Pipe		≈24640	Hose - Upper - Eng. To Pipe		≈24640
Hose - Lower - Eng. To Cooler		≈24644	Hose - Upper - Rad. To Pipe		≈24640
			Hose - Lower - Eng. To Rad.		22877
			Hose - Oil Cooler To Heater; W/Beaded End		CT103
			Hose - Oil Cooler To Heater; W/Threaded End		CT105
			Hose - Oil Cooler To Aux. Heater; W/Beaded End		CT104

▲Standard Belt Available.

≈Cut to Fit.

Medium & Heavy-Duty Trucks
(2001 & Newer)

Belts and Coolant Hose for Medium/Heavy-Duty Trucks (2001 & Newer)

Medium & Heavy-Duty Trucks
(2001 & Newer)

Application	Mfr. Part No.	Our No.	Application	Mfr. Part No.	Our No.
Freightliner - Continued			Freightliner - Continued		
2007 - Continued			2007 - Continued		
Detroit Diesel 6-Cyl. 12.7 L Diesel - Continued			Detroit Diesel 6-Cyl. 14.0 L Diesel - Continued		
Columbia - Continued			Classic - Continued		
Hose - Oil Cooler To Aux. Heater; W/Threaded End		CT106	Tensioner Assy. - Hub, Alt. & A.C.	0127425000	38501
Hose - W.P. Rear To Heater; W/Beaded End		CT102	Tensioner Pulley - Fan	0127846000	38076
Hose - W.P. Rear To Heater; W/Threaded End		CT108	Tensioner Pulley - Hub, Alt. & A.C.	0127425000	38075
Hose - W.P. Front To Aux. Heater; W/Beaded End		CT100	Hose - Upper - Eng. To Pipe		≈<24640
Hose - W.P. Front To Aux. Heater; W/Threaded End		CT107	Hose - Upper - Rad. To Pipe		≈<21115
Hose - W.P. To Reservoir		CT101	Hose - Lower - Eng. To Pipe		≈<24640
Coronado			Classic XL		
Belt - Fan	0124894004	♣K100502HD	Belt - Fan	0124894000	♣K100579HD
Belt - Hub, Alt. & A.C.	0124587004	♣K080565HD	Belt - Hub, Alt. & A.C.	0124587004	♣K080565HD
Tensioner Assy. - Fan	0127846000	38503	Tensioner Assy. - Fan	0127846000	38503
Tensioner Assy. - Hub, Alt. & A.C.	0127425000	38501	Tensioner Assy. - Hub, Alt. & A.C.	0127425000	38501
Tensioner Pulley - Fan	0127846000	38076	Tensioner Pulley - Fan	0127846000	38076
Tensioner Pulley - Hub, Alt. & A.C.	0127425000	38075	Tensioner Pulley - Hub, Alt. & A.C.	0127425000	38075
Hose - Upper - Eng. To Pipe		21135	Tensioner Pulley - Fan	0127846000	38076
Hose - Upper - Pipe To Rad.		≈<24640	Tensioner Pulley - Hub, Alt. & A.C.	0127425000	38075
Hose - Lower - Eng. To Pipe		≈<24640	Hose - Upper - Eng. To Pipe		≈<24640
Hose - Lower - Pipe To Rad.		24031	Hose - Upper - Rad. To Pipe		≈<21115
FLD			Classic XL		
Belt - Fan	0124894000	♣K100579HD	Hose - Lower - Eng. To Pipe		≈<24640
Belt - Hub To Alt. & A.C.	0124587004	♣K080565HD	Hose - Lower - Rad. To Pipe		21135
Tensioner Assy. - Fan	0127846000	38503	Hose - Oil Cooler To Heater; W/Beaded End		CT103
Tensioner Assy. - Hub, Alt. & A.C.	0127425000	38501	Hose - Oil Cooler To Heater; W/Threaded End		CT105
Tensioner Pulley - Fan	0127846000	38076	Hose - Oil Cooler To Aux. Heater; W/Threaded End		CT106
Tensioner Pulley - Hub, Alt. & A.C.	0127425000	38075	Hose - W.P. Rear To Heater; W/Beaded End		CT102
Hose - Upper - Eng. To Pipe		≈<24640	Hose - W.P. Rear To Heater; W/Threaded End		CT108
Hose - Upper - Rad. To Pipe		≈<21115	Hose - W.P. Front To Aux. Heater; W/Beaded End		CT100
Hose - Lower - Eng. To Pipe		≈<24640	Hose - W.P. Front To Aux. Heater; W/Threaded End		CT107
Hose - Lower - Rad. To Pipe		21135	Hose - W.P. To Reservoir		CT101
Detroit Diesel 6-Cyl. 14.0 L Diesel			Columbia		
Argosy			Classic XL		
Belt - Fan	0124894000	♣K100579HD	Belt - Fan	0124894004	♣K100502HD
Belt - Alt. & A.C.	0124587000	♣K080580HD	Belt - Hub To Alt. & A.C.	0124587004	♣K080565HD
Tensioner Assy. - Fan		38503	Tensioner Assy. - Fan	0127846000	38503
Tensioner Assy. - Alt. & A.C.	23520317	38501	Tensioner Assy. - Hub, Alt. & A.C.	0127425000	38501
Tensioner Pulley - Fan		38076	Tensioner Pulley - Fan	0127846000	38076
Tensioner Pulley - Alt. & A.C.		38075	Tensioner Pulley - Hub, Alt. & A.C.	0127425000	38075
Hose - Upper - Eng. To Pipe		≈<24640	Hose - Upper - Eng. To Rad.		≈<24640
Hose - Upper - Rad. To Pipe		≈<24640	Hose - Upper - Rad. To Pipe		≈<24640
Hose - Lower - Eng. To Cooler		≈<24644	Hose - Lower - Eng. To Rad.		22877
Hose - Lower - Cooler To Pipe		≈<24644	Hose - Oil Cooler To Heater; W/Beaded End		CT103
Hose - Lower - Rad. To Pipe		≈<21891	Hose - Oil Cooler To Heater; W/Threaded End		CT105
Century Class			Classic XL		
Belt - Fan	0124894004	♣K100502HD	Hose - Oil Cooler To Aux. Heater; W/Beaded End		CT104
Belt - Hub To Alt. & A.C.	0124587004	♣K080565HD	Hose - Oil Cooler To Aux. Heater; W/Threaded End		CT106
Tensioner Assy. - Fan	0127846000	38503	Hose - W.P. Rear To Heater; W/Beaded End		CT102
Tensioner Assy. - Hub, Alt. & A.C.	0127425000	38501	Hose - W.P. Rear To Heater; W/Threaded End		CT108
Tensioner Pulley - Fan	0127846000	38076	Hose - W.P. Front To Aux. Heater; W/Beaded End		CT100
Tensioner Pulley - Hub, Alt. & A.C.	0127425000	38075	Hose - W.P. Front To Aux. Heater; W/Threaded End		CT107
Hose - Upper - Eng. To Pipe		≈<24640	Hose - W.P. To Reservoir		CT101
Hose - Upper - Rad. To Pipe		≈<24640	Coronado		
Hose - Lower - Eng. To Rad.		22877	Belt - Fan	0124894004	♣K100502HD
Hose - Oil Cooler To Heater; W/Beaded End		CT103	Belt - Hub, Alt. & A.C.	0124587004	♣K080565HD
Hose - Oil Cooler To Heater; W/Threaded End		CT105	Tensioner Assy. - Fan	0127846000	38503
Hose - Oil Cooler To Aux. Heater; W/Beaded End		CT104	Tensioner Assy. - Hub, Alt. & A.C.	0127425000	38501
Hose - Oil Cooler To Aux. Heater; W/Threaded End		CT106	Tensioner Pulley - Fan	0127846000	38076
Hose - W.P. Rear To Heater; W/Beaded End		CT102	Tensioner Pulley - Hub, Alt. & A.C.	0127425000	38075
Hose - W.P. Rear To Heater; W/Threaded End		CT108	Hose - Upper - Eng. To Pipe		21135
Hose - W.P. Front To Aux. Heater; W/Beaded End		CT100	Hose - Upper - Pipe To Rad.		≈<24640
Hose - W.P. Front To Aux. Heater; W/Threaded End		CT107	Hose - Lower - Eng. To Pipe		≈<24640
Hose - W.P. To Reservoir		CT101	Hose - Lower - Pipe To Rad.		24031
Classic			FLD		
Belt - Fan	0124894000	♣K100579HD	Belt - Fan	0124894000	♣K100579HD
Belt - Hub, Alt. & A.C.	0124587004	♣K080565HD	Belt - Hub To Alt. & A.C.	0124587004	♣K080565HD
Tensioner Assy. - Fan	0127846000	38503	Tensioner Assy. - Fan	0127846000	38503
Tensioner Assy. - Hub, Alt. & A.C.	0127425000	38501	Tensioner Assy. - Hub, Alt. & A.C.	0127425000	38501
Tensioner Pulley - Fan	0127846000	38076	Tensioner Pulley - Fan	0127846000	38076
Tensioner Pulley - Hub, Alt. & A.C.	0127425000	38075	Tensioner Pulley - Hub, Alt. & A.C.	0127425000	38075
Hose - Upper - Eng. To Pipe		≈<24640	Hose - Upper - Eng. To Pipe		21135
Hose - Upper - Pipe To Rad.		≈<24640	Hose - Upper - Pipe To Rad.		≈<24640
Hose - Lower - Eng. To Pipe		≈<24640	Hose - Lower - Eng. To Pipe		≈<24640
Hose - Lower - Pipe To Rad.		24031	Hose - Lower - Pipe To Rad.		24031

♣Standard Belt Available.

≈<Cut to Fit.

Belts and Coolant Hose for Medium/Heavy-Duty Trucks (2001 & Newer)

Application	Mfr. Part No.	Our No.	Application	Mfr. Part No.	Our No.
Freightliner - Continued			Freightliner - Continued		
2007 - Continued			2007 - Continued		
Detroit Diesel 6-Cyl. 14.0 L Diesel - Continued			Mercedes-Benz MBE 4000 Diesel - Continued		
FLD - Continued			Columbia - Continued		
Hose - Upper - Rad. To Pipe		≡21115	Tensioner Pulley - Hub, Alt. & A.C.	0127425000	38075
Hose - Lower - Eng. To Pipe		≡24640	Hose - Upper - Eng. To Rad.		22959
Hose - Lower - Rad. To Pipe		21135	Hose - Lower - Eng. To Rad.		23171
Mercedes-Benz MBE 900 Diesel			FLD		
Business Class M2			Belt - Fan		
Belt - Fan, Alt. & A.C.; W/O P.T.O.	0129866094	♣K080825HD	Belt - Hub, Alt. & A.C.	0127116013	♣K080505HD
Belt - Fan; W/P.T.O.	0127116011	♣K080615HD	Tensioner Assy. - Hub, Alt. & A.C.	0127116004	♣K080855HD
Belt - W.P., Alt. & A.C.; W/P.T.O.	0129866094	♣K080825HD	Tensioner Assy. - Fan	0127425000	38501
Belt - Fan, Alt. & A.C.; W/84" Belt O.C.	0129866118	♣K080830HD	Tensioner Assy. - Fan	0127427001	38597
Tensioner Assy. - Fan; W/P.T.O.	0129079000	38598	2006		
Tensioner Assy. - Alt. & A.C.	9062003170	38567	Caterpillar C7 Diesel		
Hose - Upper - Eng. To Rad.; W/O P.T.O.		21378	Business Class M2		
Hose - Upper - Eng. To Pipe; W/P.T.O.		≡24632	Belt - Fan, Alt. & A.C.; W/145A. Alt.		
Hose - Upper - Rad. To Pipe; W/P.T.O.		≡24640	Belt - Fan, Alt. & A.C.; W/130A. Alt.		
Hose - Lower - Eng. To Pipe		20206	Tensioner Assy. - Fan, Alt. & A.C.		
Hose - Lower - Pipe To Cooler; W/P.T.O.		20206	Idler Pulley - Upper		
Hose - Lower - Rad. To Pipe; W/O P.T.O.		≡24632	Hose - Upper - Eng. To Rad.		
Hose - Lower - Rad. To Pipe; W/P.T.O.		≡24640	Hose - Lower - Eng. To Pipe		
Hose - Lower - Cooler To Pipe; W/P.T.O.		≡24632	Hose - Lower - Rad. To Pipe		
MT45			Hose - Lower - Pipe To Cooler		
Belt - Serpentine; W/82 1/2" Belt O.C.	0129866094	♣K080825HD	Hose - Lower - Cooler To Pipe		
Belt - Serpentine; W/67" Belt O.C.	0129859699	♣K080670HD	Caterpillar C9 Diesel		
Tensioner Assy.	A9062003170	38567	Business Class M2		
Hose - Upper		20611	Belt - Fan, Alt. & A.C.		
Hose - Lower - Eng. To Pipe		21571	Tensioner Assy. - Fan, Alt. & A.C.		
Hose - Lower - Pipe To Rad.		20206	Idler Pulley - Smooth		
Hose - Intercooler To Engine (Cold Side) ...	0129982000	29001	Hose - Upper - Eng. To Rad.		
Hose - Pipe To Intercooler (Hot Side)		26201	Hose - Lower - Eng. To Rad.		
MT55			Caterpillar C11 Diesel		
Belt - Serpentine; W/67" Belt O.C.	0129859699	♣K080670HD	Century Class		
Belt - Serpentine; W/82 1/2" Belt O.C.	0129866094	♣K080825HD	Belt - Fan, Alt. & A.C.		
Tensioner Assy. - Fan & Alt.	9062003170	38567	Tensioner Assy. - Fan, Alt. & A.C.		
Hose - Upper		20611	Tensioner Pulley - Fan, Alt. & A.C.		
Hose - Lower - Eng. To Pipe		21571	Idler Pulley - Smooth		
Hose - Lower - Pipe To Rad.		20206	Idler Pulley - Grooved		
Hose - Intercooler To Engine (Cold Side) ...	0129982000	29001	Hose - Upper - Eng. To Pipe		
Hose - Pipe To Intercooler (Hot Side)		26201	Hose - Upper - Rad. To Pipe		
Mercedes-Benz MBE 4000 Diesel			Hose - Lower - Eng. To Pipe		
Business Class M2			Hose - Lower - Rad. To Pipe		
Belt - Fan	0127116013	♣K080505HD	Classic; Classic XL		
Belt - Hub, Alt. & A.C.	0127116004	♣K080855HD	Idler Pulley - Smooth		
Tensioner Assy. - Fan	0127427001	38597	Idler Pulley - Grooved		
Tensioner Assy. - Hub, Alt. & A.C.	0127425000	38501	Hose - Upper - Eng. To Pipe		
Tensioner Pulley - Hub, Alt. & A.C.	0127425000	38075	Hose - Upper - Rad. To Pipe		
Hose - Upper - Eng. To Rad.		22959	Hose - Lower - Eng. To Pipe		
Hose - Lower - Eng. To Rad.		23171	Hose - Lower - Rad. To Pipe		
Century Class			Century Class		
Belt - Fan	0127116013	♣K080505HD	Belt - Fan, Alt. & A.C.		
Belt - Hub, Alt. & A.C.	0127116004	♣K080855HD	Tensioner Assy. - Fan, Alt. & A.C.		
Tensioner Assy. - A.C.	0127425000	38501	Tensioner Pulley - Fan, Alt. & A.C.		
Tensioner Assy. - Fan	0127427001	38597	Idler Pulley - Smooth		
Idler Pulley	0127426000	36302	Idler Pulley - Grooved		
Classic			Hose - Upper - Eng. To Pipe		
Belt - Fan	0127116017	♣K080570HD	Hose - Upper - Rad. To Pipe		
Belt - A.C.	0127116000	♣K080580HD	Hose - Lower - Eng. To Pipe		
Tensioner Assy. - Fan	0127427001	38597	Hose - Lower - Rad. To Pipe		
Tensioner Assy. - A.C.	0127425000	38501	FLD		
Idler Pulley - Alt.	0127426000	36302	Belt - Fan, Alt. & A.C.		
Columbia			Tensioner Assy. - Fan, Alt. & A.C.		
Belt - Fan	0127116013	♣K080505HD	Tensioner Pulley - Fan, Alt. & A.C.		
Belt - Hub, Alt. & A.C.	0127116004	♣K080855HD	Idler Pulley - Smooth		
Tensioner Assy. - Fan	0127427001	38597	Idler Pulley - Grooved		
Tensioner Assy. - Hub, Alt. & A.C.	0127425000	38501	Hose - Upper - Eng. To Pipe		
		38501	Hose - Upper - Rad. To Pipe		
		38501	Hose - Lower - Eng. To Pipe		
		38501	Hose - Lower - Rad. To Pipe		

Medium & Heavy-Duty Trucks (2001 & Newer)

≡Cut to Fit.

♣Standard Belt Available.

Belts and Coolant Hose for Medium/Heavy-Duty Trucks (2001 & Newer)

Medium & Heavy-Duty Trucks
(2001 & Newer)

Application	Mfr. Part No.	Our No.	Application	Mfr. Part No.	Our No.
Freightliner - Continued			Freightliner - Continued		
2006 - Continued			2006 - Continued		
Caterpillar C13 Diesel			Caterpillar C15 Diesel - Continued		
Business Class M2			Columbia - Continued		
Belt - Hub, Fan, Alt. & A.C.	0123415055	♣K080952HD	Tensioner Assy.	2002279	38569
Tensioner Assy. - Hub, Fan, Alt. & A.C.	2117895	38590	Idler Pulley - Smooth	1979641	36091
Tensioner Pulley - Hub, Fan, Alt. & A.C.	2117895	36164	Idler Pulley - Grooved	1979642	36341
Idler Pulley - Smooth	2078118	36269	Hose - Upper - Eng. To Pipe		≈<24240
Idler Pulley - Grooved	1979642	36341	Hose - Upper - Pipe To Rad.		21891
Hose - Upper - Eng. To Rad.		23086	Hose - Lower - Rad. To Pipe		≈<24240
Hose - Lower - Eng. To Rad.		22952	Coronado		
Century Class			Belt - Fan & Alt.	0128415078	♣K080926HD
Belt - Fan, Alt. & A.C.	0123415080	♣K081005HD	Belt - Fan To A.C.	0129730485	♣K060586HD
Tensioner Assy. - Fan, Alt. & A.C.	2117895	38590	Tensioner Assy. - Fan & Alt.	2002279	38569
Tensioner Pulley - Fan, Alt. & A.C.	2117895	36164	Tensioner Assy. - Fan To A.C.	2178938	38511
Idler Pulley - Smooth	2078118	36269	Idler Pulley - Smooth	1979641	36091
Idler Pulley - Grooved	1979642	36341	Idler Pulley - Grooved	1979642	36341
Hose - Upper - Eng. To Pipe		24240	Tensioner Pulley - Fan To A.C.	2178938	36091
Hose - Upper - Rad. To Pipe		24240	Hose - Upper - Eng. To Pipe		21891
Hose - Lower - Eng. To Pipe		24240	Hose - Upper - Rad. To Pipe		24240
Hose - Lower - Rad. To Pipe		21135	Hose - Lower - Eng. To Pipe		23084
Classic; Classic XL			FLD		
Idler Pulley - Smooth	2078118	36269	Belt - Fan & Alt.	0123415078	♣K080926HD
Idler Pulley - Grooved	1979642	36341	Belt - Fan To A.C.	0126709018	♣K060635HD
Columbia			Tensioner Assy. - Fan & Alt.	2002279	38569
Belt - Fan, Alt. & A.C.	0123415080	♣K081005HD	Tensioner Assy. - Fan To A.C.	2178938	38511
Tensioner Assy. - Fan, Alt. & A.C.	2117895	38590	Idler Pulley - Smooth	1979641	36091
Tensioner Pulley - Fan, Alt. & A.C.	2117895	36164	Idler Pulley - Grooved	1979642	36341
Idler Pulley - Smooth	2078118	36269	Tensioner Pulley - Fan To A.C.	2178938	36091
Idler Pulley - Grooved	1979642	36341	Hose - Upper - Eng. To Rad.		24240
Hose - Upper - Eng. To Rad.		23086	Hose - Upper - Rad. To Pipe		21891
Hose - Lower - Eng. To Rad.		22952	Hose - Lower - Eng. To Pipe		24240
FLD			Hose - Lower - Rad. To Pipe		24240
Belt - Fan, Alt. & A.C.	0123415080	♣K081005HD	Cummins ISB Diesel		
Tensioner Assy. - Fan, Alt. & A.C.	2117895	38590	MT35; MT45; MT55		
Tensioner Pulley - Fan, Alt. & A.C.	2117895	36164	Belt - Fan & Alt.	3926856	♣K080694HD
Idler Pulley - Smooth	2078118	36269	Belt - Fan To A.C.		♣9430HD
Idler Pulley - Grooved	1979642	36341	Tensioner Assy. - Fan & Alt.	3936213	38516
Hose - Upper - Eng. To Pipe		24240	Tensioner Pulley - Fan & Alt.	3936213	36093
Hose - Upper - Rad. To Pipe		24240	Hose - Upper		23114
Hose - Lower - Eng. To Pipe		24240	Hose - Lower - Eng. To Pipe		24236
Hose - Lower - Rad. To Pipe		21135	Hose - Lower - Pipe To Rad.		24232
Caterpillar C15 Diesel			Cummins ISC Diesel		
Century Class			Business Class M2		
Belt - Fan & Alt.	0123415078	♣K080926HD	Belt - Hub, Fan, Alt. & A.C.	0123415100	♣K080820HD
Belt - Fan To A.C.	0126709018	♣K060635HD	Tensioner Assy. - Hub, Fan, Alt. & A.C.	3976831	38516
Tensioner Assy. - Fan & Alt.	2002279	38569	Idler Pulley	3970945	36283
Tensioner Assy. - Fan To A.C.	2178938	38511	Hose - Upper - Eng. To Rad.		23170
Idler Pulley - Smooth	1979641	36091	Hose - Lower - Eng. To Pipe		24240
Idler Pulley - Grooved	1979642	36341	Hose - Lower - Rad. To Pipe		21135
Tensioner Pulley - Fan To A.C.	2178938	36091	Condor		
Hose - Upper - Eng. To Rad.		24240	Belt - Alt.	3944838	♣K080755HD
Hose - Upper - Rad. To Pipe		21891	Tensioner Assy. - Alt.	3936213	38516
Hose - Lower - Eng. To Pipe		24240	Cummins ISL Diesel		
Hose - Lower - Rad. To Pipe		24240	Condor		
Classic; Classic XL			Belt - Fan		♣K080765HD
Belt - Fan & Alt.	0123415079	♣K080991HD	Belt - A.C.		♣9412HD
Belt - Fan To A.C.	0127177010	♣K060586HD	Tensioner Assy. - Alt.	3976831	38516
Tensioner Assy. - Fan & Alt.	1900649	38506	Hose - Upper - Rad. To Pipe		≈<24232
Tensioner Assy. - Fan To A.C.	1382514	38508		or	≈<24832
Idler Pulley - Smooth	1979641	36091	Hose - Upper - Pipe To Eng.		≈<24236
Idler Pulley - Grooved	1979642	36341	Hose - Lower - Rad. To Cooler		24210
Tensioner Pulley - Fan & Alt.	1900649	36091	Hose - Lower - Cooler To Pipe		≈<21891
Tensioner Pulley - Fan To A.C.	1382514	36091	Hose - Lower - Pipe To Eng.		≈<24236
Hose - Upper - Eng. To Rad.		23229			
Hose - Lower - Eng. To Rad.		23015			
Columbia					
Belt - Fan, Alt. & A.C.	0123415078	♣K080926HD			

♣Standard Belt Available.

≈<Cut to Fit.

Belts and Coolant Hose for Medium/Heavy-Duty Trucks (2001 & Newer)

Application	Mfr. Part No.	Our No.	Application	Mfr. Part No.	Our No.
Freightliner - Continued			Freightliner - Continued		
2006 - Continued			2006 - Continued		
Detroit Diesel 6-Cyl. 12.7 L Diesel			Detroit Diesel 6-Cyl. 12.7 L Diesel - Continued		
Argosy			Columbia - Continued		
Belt - Fan	0124894000	♣K100579HD	Tensioner Assy. - Hub, Alt. & A.C.	0127425000	38501
Belt - Alt. & A.C.	0124587000	♣K080580HD	Tensioner Pulley - Fan	0127846000	38076
Tensioner Assy. - Fan		38503	Tensioner Pulley - Hub, Alt. & A.C.	0127425000	38075
Tensioner Assy. - Alt. & A.C.	23520317	38501	Hose - Upper - Eng. To Rad.		21135
Tensioner Pulley - Fan		38076	Hose - Upper - Rad. To Pipe		24240
Tensioner Pulley - Alt. & A.C.		38075	Hose - Lower - Eng. To Rad.		22877
Hose - Upper - Eng. To Pipe		24240	Hose - Oil Cooler To Heater; W/Beaded End		CT103
Hose - Upper - Rad. To Pipe		24240	Hose - Oil Cooler To Heater; W/Threaded End		CT105
Hose - Lower - Eng. To Cooler		24244	Hose - Oil Cooler To Aux. Heater; W/Beaded End		CT104
Hose - Lower - Cooler To Pipe		24244	Hose - Oil Cooler To Aux. Heater; W/Threaded End		CT106
Hose - Lower - Rad. To Pipe		≧21891	Hose - W.P. Rear To Heater; W/Beaded End		CT102
Century Class			Hose - W.P. Rear To Heater; W/Threaded End		CT108
Belt - Fan	0124894004	♣K100502HD	Hose - W.P. Front To Aux. Heater; W/Beaded End		CT100
Belt - Hub To Alt. & A.C.	0124587004	♣K080565HD	Hose - W.P. Front To Aux. Heater; W/Threaded End		CT107
Tensioner Assy. - Fan	0127846000	38503	Hose - W.P. To Reservoir		CT101
Tensioner Assy. - Hub, Alt. & A.C.	0127425000	38501	Coronado		
Tensioner Pulley - Fan	0127846000	38076	Belt - Fan	0124894004	♣K100502HD
Tensioner Pulley - Hub, Alt. & A.C.	0127425000	38075	Belt - Hub, Alt. & A.C.	0124587004	♣K080565HD
Hose - Upper - Eng. To Pipe		24240	Tensioner Assy. - Fan	0127846000	38503
Hose - Upper - Rad. To Pipe		24240	Tensioner Assy. - Hub, Alt. & A.C.	0127425000	38501
Hose - Lower - Eng. To Rad.		22877	Tensioner Pulley - Fan	0127846000	38076
Hose - Oil Cooler To Heater; W/Beaded End		CT103	Tensioner Pulley - Hub, Alt. & A.C.	0127425000	38075
Hose - Oil Cooler To Heater; W/Threaded End		CT105	Hose - Upper - Eng. To Pipe		21135
Hose - Oil Cooler To Aux. Heater; W/Beaded End		CT104	Hose - Upper - Pipe To Rad.		24240
Hose - Oil Cooler To Aux. Heater; W/Threaded End		CT106	Hose - Lower - Eng. To Pipe		24240
Hose - W.P. Rear To Heater; W/Beaded End		CT102	Hose - Lower - Pipe To Rad.		24031
Hose - W.P. Rear To Heater; W/Threaded End		CT108	FLD		
Hose - W.P. Front To Aux. Heater; W/Beaded End		CT100	Belt - Fan	0124894000	♣K100579HD
Hose - W.P. Front To Aux. Heater; W/Threaded End		CT107	Belt - Hub To Alt. & A.C.	0124587004	♣K080565HD
Hose - W.P. To Reservoir		CT101	Tensioner Assy. - Fan	0127846000	38503
Classic			Tensioner Assy. - Hub, Alt. & A.C.	0127425000	38501
Belt - Fan	0124894000	♣K100579HD	Tensioner Pulley - Fan	0127846000	38076
Belt - Hub, Alt. & A.C.	0124587004	♣K080565HD	Tensioner Pulley - Hub, Alt. & A.C.	0127425000	38075
Tensioner Assy. - Fan	0127846000	38503	Hose - Upper - Eng. To Pipe		24240
Tensioner Assy. - Hub, Alt. & A.C.	0127425000	38501	Hose - Upper - Rad. To Pipe		≧21115
Tensioner Pulley - Fan	0127846000	38076	Hose - Lower - Eng. To Pipe		24240
Tensioner Pulley - Hub, Alt. & A.C.	0127425000	38075	Hose - Lower - Rad. To Pipe		21135
Hose - Upper - Eng. To Pipe		24240	Detroit Diesel 6-Cyl. 14.0 L Diesel		
Hose - Upper - Rad. To Pipe		≧21115	Argosy		
Hose - Lower - Eng. To Pipe		24240	Belt - Fan	0124894000	♣K100579HD
Hose - Lower - Rad. To Pipe		21135	Belt - Alt. & A.C.	0124587000	♣K080580HD
Classic XL			Tensioner Assy. - Fan		38503
Belt - Fan	0124894000	♣K100579HD	Tensioner Assy. - Alt. & A.C.	23520317	38501
Belt - Hub, Alt. & A.C.	0124587004	♣K080565HD	Tensioner Pulley - Fan		38076
Tensioner Assy. - Fan	0127846000	38503	Tensioner Pulley - Alt. & A.C.		38075
Tensioner Assy. - Hub, Alt. & A.C.	0127425000	38501	Hose - Upper - Eng. To Pipe		24240
Tensioner Pulley - Fan	0127846000	38076	Hose - Upper - Rad. To Pipe		24240
Tensioner Pulley - Hub, Alt. & A.C.	0127425000	38075	Hose - Lower - Eng. To Cooler		24244
Hose - Upper - Eng. To Pipe		24240	Hose - Lower - Cooler To Pipe		24244
Hose - Upper - Rad. To Pipe		≧21115	Hose - Lower - Rad. To Pipe		≧21891
Hose - Lower - Eng. To Pipe		24240	Century Class		
Hose - Lower - Rad. To Pipe		21135	Belt - Fan	0124894004	♣K100502HD
Hose - Oil Cooler To Heater; W/Beaded End		CT103	Belt - Hub To Alt. & A.C.	0124587004	♣K080565HD
Hose - Oil Cooler To Heater; W/Threaded End		CT105	Tensioner Assy. - Fan	0127846000	38503
Hose - Oil Cooler To Aux. Heater; W/Beaded End		CT104	Tensioner Assy. - Hub, Alt. & A.C.	0127425000	38501
Hose - Oil Cooler To Aux. Heater; W/Threaded End		CT106	Tensioner Pulley - Fan	0127846000	38076
Hose - W.P. Rear To Heater; W/Beaded End		CT102	Tensioner Pulley - Hub, Alt. & A.C.	0127425000	38075
Hose - W.P. Rear To Heater; W/Threaded End		CT108	Hose - Upper - Eng. To Pipe		24240
Hose - W.P. Front To Aux. Heater; W/Beaded End		CT100	Hose - Upper - Rad. To Pipe		24240
Hose - W.P. Front To Aux. Heater; W/Threaded End		CT107	Hose - Lower - Eng. To Rad.		22877
Hose - W.P. To Reservoir		CT101	Hose - Oil Cooler To Heater; W/Beaded End		CT103
Columbia			Hose - Oil Cooler To Heater; W/Threaded End		CT105
Belt - Fan	0124894004	♣K100502HD	Hose - Oil Cooler To Aux. Heater; W/Beaded End		CT104
Belt - Hub To Alt. & A.C.	0124587004	♣K080565HD	Hose - Oil Cooler To Aux. Heater; W/Threaded End		CT106
Tensioner Assy. - Fan	0127846000	38503			

♣Standard Belt Available.

≧Cut to Fit.

Medium & Heavy-Duty Trucks
(2001 & Newer)

Belts and Coolant Hose for Medium/Heavy-Duty Trucks (2001 & Newer)

Medium & Heavy-Duty Trucks
(2001 & Newer)

Application	Mfr. Part No.	Our No.	Application	Mfr. Part No.	Our No.
Freightliner - Continued			Freightliner - Continued		
2006 - Continued			2006 - Continued		
Detroit Diesel 6-Cyl. 14.0 L Diesel - Continued			Detroit Diesel 6-Cyl. 14.0 L Diesel - Continued		
Century Class - Continued			Coronado - Continued		
Hose - W.P. Rear To Heater; W/Beaded End		CT102	Hose - Lower - Pipe To Rad.		24031
Hose - W.P. Rear To Heater; W/Threaded End		CT108	FLD		
Hose - W.P. Front To Aux. Heater; W/Beaded End		CT100	Belt - Fan	0124894000	♣K100579HD
Hose - W.P. Front To Aux. Heater; W/Threaded End		CT107	Belt - Hub, Alt. & A.C.	0124587004	♣K080565HD
Hose - W.P. To Reservoir		CT101	Tensioner Assy. - Fan	0127846000	38503
Classic			Tensioner Assy. - Hub, Alt. & A.C.	0127425000	38501
Belt - Fan	0124894000	♣K100579HD	Tensioner Pulley - Fan	0127846000	38076
Belt - Hub, Alt. & A.C.	0124587004	♣K080565HD	Tensioner Pulley - Hub, Alt. & A.C.	0127425000	38075
Tensioner Assy. - Fan	0127846000	38503	Hose - Upper - Eng. To Pipe		24240
Tensioner Assy. - Hub, Alt. & A.C.	0127425000	38501	Hose - Upper - Rad. To Pipe		♣21115
Tensioner Pulley - Fan	0127846000	38076	Hose - Lower - Eng. To Pipe		24240
Tensioner Pulley - Hub, Alt. & A.C.	0127425000	38075	Hose - Lower - Rad. To Pipe		21135
Hose - Upper - Eng. To Pipe		24240	Mercedes-Benz MBE 900 Diesel		
Hose - Upper - Rad. To Pipe		♣21115	Business Class M2		
Hose - Lower - Eng. To Pipe		24240	Belt - Fan, Alt. & A.C.; W/O P.T.O.	0129866094	♣K080825HD
Hose - Lower - Rad. To Pipe		21135	Belt - Fan; W/P.T.O.	0127116011	♣K080615HD
Classic XL			Belt - W.P., Alt. & A.C.; W/P.T.O.	0129866094	♣K080825HD
Belt - Fan	0124894000	♣K100579HD	Tensioner Assy. - Fan; W/P.T.O.	0129079000	38598
Belt - Hub, Alt. & A.C.	0124587004	♣K080565HD	Tensioner Assy. - Alt. & A.C.	9062003170	38567
Tensioner Assy. - Fan	0127846000	38503	Hose - Upper - Eng. To Rad.; W/O P.T.O.		21378
Tensioner Assy. - Hub, Alt. & A.C.	0127425000	38501	Hose - Upper - Eng. To Pipe; W/P.T.O.		24232
Tensioner Pulley - Fan	0127846000	38076	Hose - Upper - Rad. To Pipe; W/P.T.O.		24240
Tensioner Pulley - Hub, Alt. & A.C.	0127425000	38075	Hose - Lower - Eng. To Pipe		20206
Hose - Upper - Eng. To Pipe		24240	Hose - Lower - Pipe To Cooler; W/P.T.O.		20206
Hose - Upper - Rad. To Pipe		♣21115	Hose - Lower - Rad. To Pipe; W/O P.T.O.		24032
Hose - Lower - Eng. To Pipe		24240	Hose - Lower - Rad. To Pipe; W/P.T.O.		24240
Hose - Lower - Rad. To Pipe		21135	Hose - Lower - Cooler To Pipe; W/P.T.O.		24232
Hose - Oil Cooler To Heater; W/Beaded End		CT103	MT45		
Hose - Oil Cooler To Heater; W/Threaded End		CT105	Belt - Fan, Alt. & A.C.	0127110048	♣K080839HD
Hose - Oil Cooler To Aux. Heater; W/Beaded End		CT104	Tensioner Assy.	A9062003170	38567
Hose - Oil Cooler To Aux. Heater; W/Threaded End		CT106	Hose - Upper - Eng. To Rad.		20611
Hose - W.P. Rear To Heater; W/Beaded End		CT102	Hose - Lower - Eng. To Pipe		21571
Hose - W.P. Rear To Heater; W/Threaded End		CT108	Hose - Lower - Pipe To Rad.		20206
Hose - W.P. Front To Aux. Heater; W/Beaded End		CT100	Hose - Intercooler To Engine (Cold Side) ...	0129159000	29003
Hose - W.P. Front To Aux. Heater; W/Threaded End		CT107	Hose - Pipe To Intercooler (Hot Side)		26201
Hose - W.P. To Reservoir		CT101	MT55		
Columbia			Belt - Serpentine	0129866094	♣K080825HD
Belt - Fan	0124894004	♣K100502HD	Tensioner Assy.	A9062003170	38567
Belt - Hub To Alt. & A.C.	0124587004	♣K080565HD	Hose - Upper		20611
Tensioner Assy. - Fan	0127846000	38503	Hose - Lower - Eng. To Pipe		21571
Tensioner Assy. - Hub, Alt. & A.C.	0127425000	38501	Hose - Lower - Pipe To Rad.		20206
Tensioner Pulley - Fan	0127846000	38076	Hose - Intercooler To Engine (Cold Side) ...	0129982000	29001
Tensioner Pulley - Hub, Alt. & A.C.	0127425000	38075	Hose - Pipe To Intercooler (Hot Side)		26201
Hose - Upper - Eng. To Rad.		21135	Mercedes-Benz MBE 4000 Diesel		
Hose - Upper - Rad. To Pipe		24240	Business Class M2		
Hose - Lower - Eng. To Rad.		22877	Belt - Fan	0127116013	♣K080505HD
Hose - Oil Cooler To Heater; W/Beaded End		CT103	Belt - Hub, Alt. & A.C.	0127116004	♣K080855HD
Hose - Oil Cooler To Heater; W/Threaded End		CT105	Tensioner Assy. - Fan	0127427001	38597
Hose - Oil Cooler To Aux. Heater; W/Beaded End		CT104	Tensioner Assy. - Hub, Alt. & A.C.	0127425000	38501
Hose - Oil Cooler To Aux. Heater; W/Threaded End		CT106	Tensioner Pulley - Hub, Alt. & A.C.	0127425000	38075
Hose - W.P. Rear To Heater; W/Beaded End		CT102	Hose - Upper - Eng. To Rad.		22959
Hose - W.P. Rear To Heater; W/Threaded End		CT108	Hose - Lower - Eng. To Rad.		23171
Hose - W.P. Front To Aux. Heater; W/Beaded End		CT100	Classic		
Hose - W.P. Front To Aux. Heater; W/Threaded End		CT107	Belt - Fan	0127116017	♣K080570HD
Hose - W.P. To Reservoir		CT101	Belt - A.C.	0127116000	♣K080580HD
Coronado			Tensioner Assy. - Fan	0127427001	38597
Belt - Fan	0124894004	♣K100502HD	Tensioner Assy. - A.C.	0127425000	38501
Belt - Hub, Alt. & A.C.	0124587004	♣K080565HD	Idler Pulley - Alt.	0127426000	36302
Tensioner Assy. - Fan	0127846000	38503	Columbia		
Tensioner Assy. - Hub, Alt. & A.C.	0127425000	38501	Belt - Fan	0127116013	♣K080505HD
Tensioner Pulley - Fan	0127846000	38076	Belt - Hub, Alt. & A.C.	0127116004	♣K080855HD
Tensioner Pulley - Hub, Alt. & A.C.	0127425000	38075	Tensioner Assy. - Fan	0127427001	38597
Hose - Upper - Eng. To Pipe		21135	Tensioner Assy. - Hub, Alt. & A.C.	0127425000	38501
Hose - Upper - Pipe To Rad.		24240			
Hose - Lower - Eng. To Pipe		24240			

♣Standard Belt Available.

♣Cut to Fit.

Belts and Coolant Hose for Medium/Heavy-Duty Trucks (2001 & Newer)

Application	Mfr. Part No.	Our No.	Application	Mfr. Part No.	Our No.
Freightliner - Continued			Freightliner - Continued		
2006 - Continued			2005 - Continued		
Mercedes-Benz MBE 4000 Diesel - Continued			Caterpillar C11 Diesel - Continued		
Columbia - Continued			Condor - Continued		
Tensioner Pulley - Hub, Alt. & A.C.	0127425000	38075	Idler Pulley - Grooved	1979642	36341
Hose - Upper - Eng. To Rad.		22959	FLD		
Hose - Lower - Eng. To Rad.		23171	Belt - Fan, Alt. & A.C.	0123415080	♣K081005HD
FLD			Tensioner Assy. - Fan, Alt. & A.C.	2117895	38590
Belt - Alt.	0127116004	♣K080855HD	Tensioner Pulley - Fan, Alt. & A.C.	2117895	36164
Tensioner Assy. - Alt.	0127425000	38501	Idler Pulley - Smooth	2078118	36269
Mercedes-Benz OM906 Diesel			Idler Pulley - Grooved	1979642	36341
Business Class M2			Hose - Upper - Eng. To Pipe		24240
Belt - Serpentine		♣K080675HD	Hose - Upper - Rad. To Pipe		24240
Hose - Turbo To Pipe (Hot Side)		26230	Hose - Lower - Eng. To Pipe		24240
			Hose - Lower - Rad. To Pipe		21135
2005			Caterpillar C13 Diesel		
Caterpillar 3126 Diesel			Business Class M2		
FL80			Belt - Hub, Fan, Alt. & A.C.	0123415080	♣K081005HD
Belt - Fan, Alt. & A.C.; W/Delco Alt.	0123415000	♣K080702HD	Tensioner Assy. - Hub, Fan, Alt. & A.C.	2117895	38590
Belt - Fan, Alt. & A.C.; W/Leece Neville Alt.	0127110003	♣K080708HD	Tensioner Pulley - Hub, Fan, Alt. & A.C.	2117895	36164
Belt - W.P.		♣9341HD	Idler Pulley - Smooth	2078118	36269
Tensioner Assy. - Fan, Alt. & A.C.	1352151	38511	Idler Pulley - Grooved	1979642	36341
Idler Pulley	1445612	36096	Hose - Upper - Eng. To Rad.		23086
Tensioner Pulley - Fan, Alt. & A.C.	1352151	36091	Hose - Lower - Eng. To Rad.		22952
Hose - Upper - Eng. To Rad.		22668	Century Class		
Hose - Lower - Eng. To Pipe; W/2 1/4" I.D. Hose		20748	Idler Pulley - Smooth	2078118	36269
Hose - Lower - Eng. To Pipe; W/2" I.D. Hose		21571	Idler Pulley - Grooved	1979642	36341
Hose - Lower - Rad. To Pipe; W/2 1/4" I.D. Hose		21194	Classic; Classic XL		
Hose - Lower - Rad. To Pipe; W/2" I.D. Hose		♣20611	Belt - Accessory Drive	0123415080	♣K081005HD
			Tensioner Assy.	2117895	38590
			Idler Pulley - Smooth	2078118	36269
			Idler Pulley - Grooved	1979642	36341
			Columbia		
			Belt - Fan, Alt. & A.C.	0123415055	♣K080952HD
			Tensioner Assy. - Fan, Alt. & A.C.	2117895	38590
			Tensioner Pulley - Fan, Alt. & A.C.	2117895	36164
			Idler Pulley - Smooth	2078118	36269
			Idler Pulley - Grooved	1979642	36341
			Hose - Upper - Eng. To Pipe		22950
			Hose - Lower - Eng. To Pipe		24240
			Hose - Lower - Rad. To Pipe		24240
			Condor		
			Belt - Hub, Fan, Alt. & A.C.	0127110055	♣K081020HD
			Tensioner Assy. - Hub, Fan, Alt. & A.C.	2117895	38590
			Tensioner Pulley - Hub, Fan, Alt. & A.C.	2117895	36164
			Idler Pulley - Smooth	2078118	36269
			Idler Pulley - Grooved	1979642	36341
			FLD		
			Belt - Fan, Alt. & A.C.	0123415080	♣K081005HD
			Tensioner Assy. - Fan, Alt. & A.C.	2117895	38590
			Tensioner Pulley - Fan, Alt. & A.C.	2117895	36164
			Idler Pulley - Smooth	2078118	36269
			Idler Pulley - Grooved	1979642	36341
			Hose - Upper - Eng. To Pipe		24240
			Hose - Upper - Rad. To Pipe		24240
			Hose - Lower - Eng. To Pipe		24240
			Hose - Lower - Rad. To Pipe		21135
			Caterpillar C15 Diesel		
			Century Class		
			Belt - Fan & Alt.	0123415078	♣K080926HD
			Belt - Fan To A.C.	0126709018	♣K060635HD
			Tensioner Assy. - Fan & Alt.	2002279	38569
			Tensioner Assy. - Fan To A.C.	2178938	38511
			Idler Pulley - Smooth	1979641	36091
			Idler Pulley - Grooved	1979642	36341
			Tensioner Pulley - Fan To A.C.	2178938	36091
			Hose - Upper - Eng. To Rad.		24240

♣Standard Belt Available.

♣Cut to Fit.

Medium & Heavy-Duty Trucks
(2001 & Newer)

Belts and Coolant Hose for Medium/Heavy-Duty Trucks (2001 & Newer)

Medium & Heavy-Duty Trucks
(2001 & Newer)

Application	Mfr. Part No.	Our No.	Application	Mfr. Part No.	Our No.
Freightliner - Continued			Freightliner - Continued		
2005 - Continued			2005 - Continued		
Caterpillar C15 Diesel - Continued			Cummins ISC Diesel - Continued		
Century Class - Continued			FL50; FL70; FL80		
Hose - Upper - Rad. To Pipe		21891	Belt - Fan, Alt. & Hub	3289404	♣K080716HD
Hose - Lower - Eng. To Pipe		24240	Belt - Fan To A.C.	2310001067	♣9480HD
Hose - Lower - Rad. To Pipe		24240	Tensioner Assy. - Fan, Alt. & Hub	3936213	38516
Classic			Tensioner Pulley - Fan, Alt. & Hub	3936213	36093
Belt - Fan & Alt.	0123415079	♣K080991HD	Hose - Upper - Eng. To Pipe		24236
Belt - Fan To A.C.	0127177010	♣K060586HD	Hose - Upper - Pipe To Rad.		24232
Tensioner Assy. - Fan & Alt.	1900649	38506	Hose - Lower - Eng. To Pipe		20206
Tensioner Assy. - Fan To A.C.	1382514	38508	Hose - Lower - Pipe To Cooler		21194
Idler Pulley - Smooth	1979641	36091	Cummins ISL Diesel		
Idler Pulley - Grooved	1979642	36341	Condor		
Tensioner Pulley - Fan & Alt.	1900649	36091	Belt - Fan		♣K080765HD
Tensioner Pulley - Fan To A.C.	1382514	36091	Belt - A.C.		♣9412HD
Hose - Upper - Eng. To Pipe		21194	Tensioner Assy.	3936213	38516
Hose - Upper - Pipe To Rad.		24240	Hose - Upper - Rad. To Pipe		≈24232
Hose - Lower - Eng. To Rad.		23015			or ≈24832
Classic XL; Columbia			Hose - Upper - Pipe To Eng.		≈24236
Belt - Fan & Alt.	0123415078	♣K080926HD	Hose - Lower - Rad. To Cooler		24210
Belt - Fan To A.C.	0126709018	♣K060635HD	Hose - Lower - Oil Cooler To Pipe		≈21891
Tensioner Assy. - Fan & Alt.	2002279	38569	Hose - Lower - Pipe To Eng.		≈24236
Tensioner Assy. - Fan To A.C.	2178938	38511	XC		
Idler Pulley - Smooth	1979641	36091	Belt - Alt.	3911567	♣K080670HD
Idler Pulley - Grooved	1979642	36341	Tensioner Assy. - Alt.	3936213	38516
Tensioner Pulley - Fan To A.C.	2178938	36091	Detroit Diesel 6-Cyl. 12.7 L Diesel		
Hose - Upper - Eng. To Rad.		24240	Argosy		
Hose - Upper - Rad. To Pipe		21891	Belt - Fan	0124894000	♣K100579HD
Hose - Lower - Eng. To Pipe		24240	Belt - Alt. & A.C.	0124587000	♣K080580HD
Hose - Lower - Rad. To Pipe		24240	Tensioner Assy. - Fan		38503
Coronado			Tensioner Assy. - Alt. & A.C.	23520317	38501
Belt - Fan & Alt.	0128415078	♣K080926HD	Tensioner Pulley - Fan		38076
Belt - Fan To A.C.	0129730485	♣K060586HD	Tensioner Pulley - Alt. & A.C.		38075
Tensioner Assy. - Fan & Alt.	2002279	38569	Hose - Upper - Eng. To Pipe		24240
Tensioner Assy. - Fan To A.C.	2178938	38511	Hose - Upper - Rad. To Pipe		24240
Idler Pulley - Smooth	1979641	36091	Hose - Lower - Eng. To Cooler		24244
Idler Pulley - Grooved	1979642	36341	Hose - Lower - Cooler To Pipe		24244
Tensioner Pulley - Fan To A.C.	2178938	36091	Hose - Lower - Rad. To Pipe		≈21891
Hose - Upper - Eng. To Pipe		21891	Century Class		
Hose - Upper - Rad. To Pipe		24240	Belt - Fan	0124894004	♣K100502HD
Hose - Lower - Eng. To Rad.		23084	Belt - Hub To Alt. & A.C.	0124587004	♣K080565HD
FLD			Tensioner Assy. - Fan	0127846000	38503
Belt - Fan & Alt.	0123415078	♣K080926HD	Tensioner Assy. - Hub, Alt. & A.C.	0127425000	38501
Belt - Fan To A.C.	0126709018	♣K060635HD	Tensioner Pulley - Fan	0127846000	38076
Tensioner Assy. - Fan & Alt.	2002279	38569	Tensioner Pulley - Hub, Alt. & A.C.	0127425000	38075
Tensioner Assy. - Fan To A.C.	2178938	38511	Hose - Upper - Eng. To Pipe		24240
Idler Pulley - Smooth	1979641	36091	Hose - Upper - Rad. To Pipe		24240
Idler Pulley - Grooved	1979642	36341	Hose - Lower - Eng. To Rad.		22877
Tensioner Pulley - Fan To A.C.	2178938	36091	Hose - Oil Cooler To Heater; W/Beaded End		CT103
Hose - Upper - Eng. To Rad.		24240	Hose - Oil Cooler To Heater; W/Threaded End		CT105
Hose - Upper - Rad. To Pipe		21891	Hose - Oil Cooler To Aux. Heater; W/Beaded End		CT104
Hose - Lower - Eng. To Pipe		24240	Hose - Oil Cooler To Aux. Heater; W/Threaded End		CT106
Hose - Lower - Rad. To Pipe		24240	Hose - W.P. Rear To Heater; W/Beaded End		CT102
Cummins ISB Diesel			Hose - W.P. Rear To Heater; W/Threaded End		CT108
FC80			Hose - W.P. Front To Aux. Heater; W/Beaded End		CT100
Belt - Fan & Alt.	3290073	♣K080605HD	Hose - W.P. Front To Aux. Heater; W/Threaded End		CT107
MT35; MT45; MT55			Hose - W.P. To Reservoir		CT101
Belt - Fan, Alt. & A.C.	3289864	♣K080825HD	Classic		
Tensioner Assy. - Fan, Alt. & A.C.	3976831	38516	Belt - Fan	0124894000	♣K100579HD
Hose - Upper - Eng. To Rad.		23114	Belt - Hub, Alt. & A.C.	0124587004	♣K080565HD
Hose - Lower - Eng. To Pipe		24236	Tensioner Assy. - Fan	0127846000	38503
Hose - Lower - Rad. To Pipe		24236	Tensioner Assy. - Hub, Alt. & A.C.	0127425000	38501
Cummins ISC Diesel			Tensioner Pulley - Fan	0127846000	38076
Condor			Tensioner Pulley - Hub, Alt. & A.C.	0127425000	38075
Belt - Alt.	3944838	♣K080755HD	Hose - Upper - Eng. To Pipe		24240
Tensioner Assy. - Alt.	3936213	38516	Hose - Upper - Rad. To Pipe		≈21115
			Hose - Lower - Eng. To Pipe		24240

♣Standard Belt Available.

≈Cut to Fit.

Belts and Coolant Hose for Medium/Heavy-Duty Trucks (2001 & Newer)

Application	Mfr. Part No.	Our No.	Application	Mfr. Part No.	Our No.
Freightliner - Continued			Freightliner - Continued		
2005 - Continued			2005 - Continued		
Detroit Diesel 6-Cyl. 12.7 L Diesel - Continued			Detroit Diesel 6-Cyl. 14.0 L Diesel		
Classic - Continued			Argosy		
Hose - Lower - Rad. To Pipe		21135	Belt - Fan	0124894000	▲K100579HD
Classic XL			Belt - Alt. & A.C.	0124587000	▲K080580HD
Belt - Fan	0124894000	▲K100579HD	Tensioner Assy. - Fan		38503
Belt - Hub, Alt. & A.C.	0124587004	▲K080565HD	Tensioner Assy. - Alt. & A.C.	23520317	38501
Tensioner Assy. - Fan	0127846000	38503	Tensioner Pulley - Fan		38076
Tensioner Assy. - Hub, Alt. & A.C.	0127425000	38501	Tensioner Pulley - Alt. & A.C.		38075
Tensioner Pulley - Fan	0127846000	38076	Hose - Upper - Eng. To Pipe		24240
Tensioner Pulley - Hub, Alt. & A.C.	0127425000	38075	Hose - Upper - Rad. To Pipe		24240
Hose - Upper - Eng. To Pipe		24240	Hose - Lower - Eng. To Cooler		24244
Hose - Upper - Rad. To Pipe	≧21150		Hose - Lower - Cooler To Pipe		24244
Hose - Lower - Eng. To Pipe		24240	Hose - Lower - Rad. To Pipe		≧21891
Hose - Lower - Rad. To Pipe		21135	Century Class		
Hose - Oil Cooler To Heater; W/Beaded End		CT103	Belt - Fan	0124894004	▲K100502HD
Hose - Oil Cooler To Heater; W/Threaded End		CT105	Belt - Hub To Alt. & A.C.	0124587004	▲K080565HD
Hose - Oil Cooler To Aux. Heater; W/Beaded End		CT104	Tensioner Assy. - Fan	0127846000	38503
Hose - Oil Cooler To Aux. Heater; W/Threaded End		CT106	Tensioner Assy. - Hub, Alt. & A.C.	0127425000	38501
Hose - W.P. Rear To Heater; W/Beaded End		CT102	Tensioner Pulley - Fan	0127846000	38076
Hose - W.P. Rear To Heater; W/Threaded End		CT108	Tensioner Pulley - Hub, Alt. & A.C.	0127425000	38075
Hose - W.P. Front To Aux. Heater; W/Beaded End		CT100	Hose - Upper - Eng. To Pipe		24240
Hose - W.P. Front To Aux. Heater; W/Threaded End		CT107	Hose - Upper - Rad. To Pipe		24240
Hose - W.P. To Reservoir		CT101	Hose - Lower - Eng. To Rad.		22877
Columbia			Hose - Oil Cooler To Heater; W/Beaded End		CT103
Belt - Fan	0124894004	▲K100502HD	Hose - Oil Cooler To Heater; W/Threaded End		CT105
Belt - Hub To Alt. & A.C.	0124587004	▲K080565HD	Hose - Oil Cooler To Aux. Heater; W/Beaded End		CT104
Tensioner Assy. - Fan	0127846000	38503	Hose - Oil Cooler To Aux. Heater; W/Threaded End		CT106
Tensioner Assy. - Hub, Alt. & A.C.	0127425000	38501	Hose - W.P. Rear To Heater; W/Beaded End		CT102
Tensioner Pulley - Fan	0127846000	38076	Hose - W.P. Rear To Heater; W/Threaded End		CT108
Tensioner Pulley - Hub, Alt. & A.C.	0127425000	38075	Hose - W.P. Front To Aux. Heater; W/Beaded End		CT100
Hose - Upper - Eng. To Rad.		21135	Hose - W.P. Front To Aux. Heater; W/Threaded End		CT107
Hose - Upper - Rad. To Pipe		24240	Hose - W.P. To Reservoir		CT101
Hose - Lower - Eng. To Rad.		22877	Classic		
Hose - Oil Cooler To Heater; W/Beaded End		CT103	Belt - Fan	0124894000	▲K100579HD
Hose - Oil Cooler To Heater; W/Threaded End		CT105	Belt - Hub, Alt. & A.C.	0124587004	▲K080565HD
Hose - Oil Cooler To Aux. Heater; W/Beaded End		CT104	Tensioner Assy. - Fan	0127846000	38503
Hose - Oil Cooler To Aux. Heater; W/Threaded End		CT106	Tensioner Assy. - Hub, Alt. & A.C.	0127425000	38501
Hose - W.P. Rear To Heater; W/Beaded End		CT102	Tensioner Pulley - Fan	0127846000	38076
Hose - W.P. Rear To Heater; W/Threaded End		CT108	Tensioner Pulley - Hub, Alt. & A.C.	0127425000	38075
Hose - W.P. Front To Aux. Heater; W/Beaded End		CT100	Hose - Upper - Eng. To Pipe		24240
Hose - W.P. Front To Aux. Heater; W/Threaded End		CT107	Hose - Upper - Rad. To Pipe		≧21115
Hose - W.P. To Reservoir		CT101	Hose - Lower - Eng. To Pipe		24240
Coronado			Hose - Lower - Rad. To Pipe		21135
Belt - Fan	0124894004	▲K100502HD	Classic XL		
Belt - Hub, Alt. & A.C.	0124587004	▲K080565HD	Belt - Fan	0124894000	▲K100579HD
Tensioner Assy. - Fan	0127846000	38503	Belt - Hub, Alt. & A.C.	0124587004	▲K080565HD
Tensioner Assy. - Hub, Alt. & A.C.	0127425000	38501	Tensioner Assy. - Fan	0127846000	38503
Tensioner Pulley - Fan	0127846000	38076	Tensioner Assy. - Hub, Alt. & A.C.	0127425000	38501
Tensioner Pulley - Hub, Alt. & A.C.	0127425000	38075	Tensioner Pulley - Fan	0127846000	38076
Hose - Upper - Eng. To Pipe		21135	Tensioner Pulley - Hub, Alt. & A.C.	0127425000	38075
Hose - Upper - Pipe To Rad.		24240	Hose - Upper - Eng. To Pipe		24240
Hose - Lower - Eng. To Pipe		24240	Hose - Upper - Rad. To Pipe		≧21115
Hose - Lower - Pipe To Rad.		24240	Hose - Lower - Eng. To Pipe		24240
FLD			Hose - Lower - Rad. To Pipe		21135
Belt - Fan	0124894000	▲K100579HD	Hose - Oil Cooler To Heater; W/Beaded End		CT103
Belt - Hub To Alt. & A.C.	0124587004	▲K080565HD	Hose - Oil Cooler To Heater; W/Threaded End		CT105
Tensioner Assy. - Fan	0127846000	38503	Hose - Oil Cooler To Aux. Heater; W/Beaded End		CT104
Tensioner Assy. - Hub, Alt. & A.C.	0127425000	38501	Hose - Oil Cooler To Aux. Heater; W/Threaded End		CT106
Tensioner Pulley - Fan	0127846000	38076	Hose - W.P. Rear To Heater; W/Beaded End		CT102
Tensioner Pulley - Hub, Alt. & A.C.	0127425000	38075	Hose - W.P. Rear To Heater; W/Threaded End		CT108
Hose - Upper - Eng. To Pipe		24240	Hose - W.P. Front To Aux. Heater; W/Beaded End		CT100
Hose - Upper - Rad. To Pipe	≧21115		Hose - W.P. Front To Aux. Heater; W/Threaded End		CT107
Hose - Lower - Eng. To Pipe		24240	Hose - W.P. To Reservoir		CT101
Hose - Lower - Rad. To Pipe		21135	Columbia		
			Belt - Fan	0124894004	▲K100502HD
			Belt - Hub To Alt. & A.C.	0124587004	▲K080565HD
			Tensioner Assy. - Fan	0127846000	38503

▲Standard Belt Available.

≧Cut to Fit.

Medium & Heavy-Duty Trucks
(2001 & Newer)

Belts and Coolant Hose for Medium/Heavy-Duty Trucks (2001 & Newer)

Medium & Heavy-Duty Trucks
(2001 & Newer)

Application	Mfr. Part No.	Our No.	Application	Mfr. Part No.	Our No.
Freightliner - Continued			Freightliner - Continued		
2005 - Continued			2005 - Continued		
Detroit Diesel 6-Cyl. 14.0 L Diesel - Continued			Mercedes-Benz MBE 900 Diesel - Continued		
Columbia - Continued			MT55 - Continued		
Tensioner Assy. - Hub, Alt. & A.C.	0127425000	38501	Hose - Upper - Eng. To Rad.		20611
Tensioner Pulley - Fan	0127846000	38076	Hose - Lower - Eng. To Pipe		21571
Tensioner Pulley - Hub, Alt. & A.C.	0127425000	38075	Hose - Lower - Pipe To Rad.		20206
Hose - Upper - Eng. To Rad.		21135	Hose - Intercooler To Engine (Cold Side) ...	0129982000	29001
Hose - Upper - Rad. To Pipe		24240	Hose - Pipe To Intercooler (Hot Side)		26201
Hose - Lower - Eng. To Rad.		22877			
Hose - Oil Cooler To Heater; W/Beaded End		CT103	Mercedes-Benz MBE 4000 Diesel		
Hose - Oil Cooler To Heater; W/Threaded End		CT105	Business Class M2		
Hose - Oil Cooler To Aux. Heater; W/Beaded End		CT104	Belt - Fan	0127116013	♣K080505HD
Hose - Oil Cooler To Aux. Heater; W/Threaded End		CT106	Belt - Hub, Alt. & A.C.	0127116004	♣K080855HD
Hose - W.P. Rear To Heater; W/Beaded End		CT102	Tensioner Assy. - Fan	0127427001	38597
Hose - W.P. Rear To Heater; W/Threaded End		CT108	Tensioner Assy. - Hub, Alt. & A.C.	0127425000	38501
Hose - W.P. Front To Aux. Heater; W/Beaded End		CT100	Tensioner Pulley - Hub, Alt. & A.C.	0127425000	38075
Hose - W.P. Front To Aux. Heater; W/Threaded End		CT107	Hose - Upper - Eng. To Rad.		22959
Hose - W.P. To Reservoir		CT101	Hose - Lower - Eng. To Rad.		23171
Coronado			Century Class		
Belt - Fan	0124894004	♣K100502HD	Belt - Fan	0127116007	♣K080575HD
Belt - Hub, Alt. & A.C.	0124587004	♣K080565HD	Belt - W.P., Alt. & A.C.	0127116004	♣K080855HD
Tensioner Assy. - Fan	0127846000	38503	Tensioner Assy. - Fan	0127427001	38597
Tensioner Assy. - Hub, Alt. & A.C.	0127425000	38501	Tensioner Assy. - Hub, Alt. & A.C.	0127425000	38501
Tensioner Pulley - Fan	0127846000	38076	Tensioner Pulley - Fan	0127425000	38075
Tensioner Pulley - Hub, Alt. & A.C.	0127425000	38075	Hose - Upper - Eng. To Rad.		24240
Hose - Upper - Eng. To Pipe		21135	Hose - Upper - Rad. To Pipe		24240
Hose - Upper - Pipe To Rad.		24240	Hose - Lower - Eng. To Rad.		21891
Hose - Lower - Eng. To Pipe		24240	Hose - Lower - Rad. To Pipe		24240
Hose - Lower - Pipe To Rad.		24240	Columbia		
FLD			Belt - Fan	0127116007	♣K080575HD
Belt - Fan	0124894000	♣K100579HD	Belt - Hub, Alt. & A.C.	0127116004	♣K080855HD
Belt - Hub To Alt. & A.C.	0124587004	♣K080565HD	Tensioner Assy. - Fan	0127427001	38597
Tensioner Assy. - Fan	0127846000	38503	Tensioner Assy. - Hub, Alt. & A.C.	0127425000	38501
Tensioner Assy. - Hub, Alt. & A.C.	0127425000	38501	Tensioner Pulley - Hub, Alt. & A.C.	0127425000	38075
Tensioner Pulley - Fan	0127846000	38076	Hose - Upper - Eng. To Rad.		22959
Tensioner Pulley - Hub, Alt. & A.C.	0127425000	38075	Hose - Lower - Eng. To Rad.		23013
Hose - Upper - Eng. To Pipe		24240	2004		
Hose - Upper - Rad. To Pipe		♠<21115	Caterpillar 3126 Diesel		
Hose - Lower - Eng. To Pipe		24240	Business Class M2		
Hose - Lower - Rad. To Pipe		21135	Belt - Fan, Alt. & A.C.; W/145A. Alt.	0123415040	♣K080774HD
Mercedes-Benz MBE 900 Diesel			Belt - Fan, Alt. & A.C.; W/130A. Alt.	0123415058	♣K080780HD
Business Class M2			Tensioner Assy. - Fan, Alt. & A.C.	2201209	38550
Belt - Fan, Alt. & A.C.	0127110016	♣K080830HD	Hose - Upper - Eng. To Rad.		22745
Tensioner Assy.	9062002470	38567	Hose - Lower - Eng. To Rad.		22744
Hose - Upper - Eng. To Rad.		♠<21378	FL50		
Hose - Lower - Eng. To Pipe		20206	Belt - Fan, Alt. & A.C.; W/Delco Alt.	0123415000	♣K080702HD
Hose - Lower - Rad. To Pipe		24232	Belt - Fan, Alt. & A.C.; W/Leece Neville Alt. .	0127110003	♣K080708HD
FL70; FL80			Belt - W.P.		♣9341HD
Belt - Fan, Alt. & A.C.	0127110016	♣K080830HD	Tensioner Assy. - Fan, Alt. & A.C.	1352151	38511
Hose - Upper - Eng. To Rad.		22701	Idler Pulley - Alt. & A.C.	1445612	36096
Hose - Lower - Eng. To Pipe		20611	Tensioner Pulley - Fan, Alt. & A.C.	1352151	36091
Hose - Lower - Pipe To Rad.		22702	Hose - Upper - Eng. To Rad.		22668
MT35			Hose - Lower - Eng. To Pipe; W/2 1/4" I.D. Hose		20748
Belt - Fan, Alt. & A.C.	0127110048	♣K080839HD	Hose - Lower - Eng. To Pipe; W/2" I.D. Hose		21571
Hose - Upper - Eng. To Rad.		20611	Hose - Lower - Rad. To Pipe; W/2 1/4" I.D. Hose		21194
Hose - Lower - Eng. To Rad.		21571	Hose - Lower - Rad. To Pipe; W/2" I.D. Hose		♠<20611
MT45			FL60; FL70; FL80		
Belt - Fan, Alt. & A.C.	0127110048	♣K080839HD	Belt - Fan, Alt. & A.C.; W/Delco Alt.	0123415000	♣K080702HD
Tensioner Assy.	A9062003170	38567	Belt - Fan, Alt. & A.C.; W/Leece Neville Alt. .	0127110003	♣K080708HD
Hose - Upper - Eng. To Rad.		20611	Belt - W.P.		♣9341HD
Hose - Lower - Eng. To Pipe		21571	Tensioner Assy. - Fan, Alt. & A.C.	1352151	38511
Hose - Lower - Pipe To Rad.		20206	Idler Pulley	1445612	36096
Hose - Intercooler To Engine (Cold Side) ...	0129159000	29003	Tensioner Pulley - Fan, Alt. & A.C.	1352151	36091
Hose - Pipe To Intercooler (Hot Side)		26201	Hose - Upper - Eng. To Rad.		22668
MT55			Hose - Lower - Eng. To Pipe; W/2 1/4" I.D. Hose		20748
Belt - Fan, Alt. & A.C.	0127110048	♣K080839HD	Hose - Lower - Eng. To Pipe; W/2" I.D. Hose		21571
Tensioner Assy.	A9062003170	38567	Hose - Lower - Rad. To Pipe; W/2 1/4" I.D. Hose		21194

♣Standard Belt Available.

♠<Cut to Fit.

Belts and Coolant Hose for Medium/Heavy-Duty Trucks (2001 & Newer)

Application	Mfr. Part No.	Our No.	Application	Mfr. Part No.	Our No.
Freightliner - Continued			Freightliner - Continued		
2004 - Continued			2004 - Continued		
Caterpillar 3126 Diesel - Continued			Caterpillar C10 Diesel - Continued		
FL60; FL70; FL80 - Continued			FLD - Continued		
Hose - Lower - Rad. To Pipe; W/2" I.D. Hose		≋20611	Tensioner Assy. - Fan To A.C.	DCO568	38524
Caterpillar C7 Diesel			Idler Pulley - Fan & Alt.; W/Flat Idler Pulley .	1337023	36091
Business Class M2			Idler Pulley - Fan & Alt.; W/Multi-Grooved		
Belt - Fan, Alt. & A.C.; W/145A. Alt.	0123415040	♣K080774HD	Idler Pulley	1731498	36231
Belt - Fan, Alt. & A.C.; W/130A. Alt.	0123415058	♣K080780HD	Tensioner Pulley - Fan To A.C.	DCO568	36091
Tensioner Assy. - Fan, Alt. & A.C.	2201209	38550	Hose - Upper - Eng. To Pipe		24240
Idler Pulley - Upper	1979641	36091	Hose - Upper - Rad. To Pipe		21891
Hose - Upper - Eng. To Rad.		22745	Hose - Lower - Eng. To Pipe		24240
Hose - Lower - Eng. To Rad.		22744	Hose - Lower - Rad. To Pipe		21891
FL50			Caterpillar C11 Diesel		
Belt - Fan & Alt.	0123415045	♣K080740HD	Century Class: Classic; Classic XL		
Belt - W.P.	0366775	♣9341HD	Idler Pulley - Smooth	2078118	36269
Tensioner Assy. - Fan & Alt.	1382514	38508	Idler Pulley - Grooved	1979642	36341
Idler Pulley - Upper	1979641	36091	Columbia		
Hose - Upper - Eng. To Rad.		22668	Belt - Fan, Alt. & A.C.	0123415055	♣K080952HD
Hose - Lower - Rad. To Cooler		21891	Tensioner Assy. - Fan, Alt. & A.C.	2117895	38590
Hose - Lower - Pipe To Cooler		22951	Tensioner Pulley - Fan, Alt. & A.C.	2117895	36164
FL60; FL70; FL80			Idler Pulley - Smooth	2078118	36269
Belt - Fan & Alt.	0123415045	♣K080740HD	Idler Pulley - Grooved	1979642	36341
Belt - W.P.	0366775	♣9341HD	Hose - Upper - Eng. To Pipe		22950
Tensioner Assy. - Fan & Alt.	1382514	38508	Hose - Lower - Eng. To Pipe		24240
Tensioner Assy. - Fan, Alt. & A.C.	1352151	38511	Hose - Lower - Rad. To Pipe		24240
Idler Pulley - Upper	1979641	36091	Condor; FLD		
Tensioner Pulley - Fan, Alt. & A.C.	1352151	36091	Idler Pulley - Smooth	2078118	36269
Hose - Upper - Eng. To Rad.		22668	Idler Pulley - Grooved	1979642	36341
Hose - Lower - Rad. To Cooler		21891	Caterpillar C12 Diesel		
Hose - Lower - Pipe To Cooler		22951	Argosy		
Caterpillar C9 Diesel			Belt - Fan & Alt.	0128330003	♣K080855HD
Business Class M2			Belt - Fan To A.C.	0129729330	♣K060523HD
Belt - Fan, Alt. & A.C.	0123415069	♣K080785HD	Tensioner Assy. - Fan, Alt. & Hub	1600649	38506
Tensioner Assy. - Fan, Alt. & A.C.	2201209	38550	Tensioner Assy. - Fan To A.C.	DCO568	38524
Idler Pulley - Smooth	2078118	36269	Idler Pulley - Fan & Alt.; W/Flat Idler Pulley .	1337023	36091
Hose - Upper - Eng. To Rad.		23085	Idler Pulley - Fan & Alt.; W/Multi-Grooved		
Hose - Lower - Eng. To Rad.		23173	Idler Pulley	1731498	36231
Caterpillar C10 Diesel			Tensioner Pulley - Fan, Alt. & Hub	1600649	36091
Condor			Tensioner Pulley - Fan To A.C.	DCO568	36091
Belt - Fan & Alt.	0124587007	♣K080878HD	Century Class		
Belt - A.C.		♣K060495HD	Belt - Fan & Alt.; W/O Idler	0128330001	♣K080922HD
Tensioner Assy. - Fan, Alt. & Hub	1600649	38506	Belt - Fan To A.C.	0129729220	♣K060480HD
Tensioner Assy. - Fan To A.C.	DCO568	38524	Tensioner Assy. - Fan & Alt.	1900649	38506
Idler Pulley - Fan & Alt.; W/Flat Idler Pulley .	1337023	36091	Tensioner Assy. - Fan To A.C.	DCO568	38524
Idler Pulley - Fan & Alt.; W/Multi-Grooved			Idler Pulley - Fan & Alt.; W/Flat Idler Pulley .	1337023	36091
Idler Pulley	1731498	36231	Idler Pulley - Fan & Alt.; W/Multi-Grooved		
Tensioner Pulley - Fan, Alt. & Hub	1600649	36091	Idler Pulley	1731498	36231
Tensioner Pulley - Fan To A.C.	DCO568	36091	Tensioner Pulley - Fan To A.C.	DCO568	36091
FL112			Classic		
Belt - Fan, Alt. & Hub	0123415034	♣K080872HD	Idler Pulley - Fan & Alt.; W/Flat Idler Pulley .	1337023	36091
Belt - Fan To A.C.	0126709000	♣K060529HD	Idler Pulley - Fan & Alt.; W/Multi-Grooved		
Tensioner Assy. - Fan, Alt. & Hub	1600649	38506	Idler Pulley	1731498	36231
Tensioner Assy. - Fan To A.C.	DCO568	38524	Columbia		
Idler Pulley - Fan & Alt.; W/Flat Idler Pulley .	1337023	36091	Belt - Fan, Alt. & Hub	0123415056	K080850HD
Idler Pulley - Fan & Alt.; W/Multi-Grooved			Belt - Fan To A.C.		♣K060525HD
Idler Pulley	1731498	36231	Tensioner Assy. - Fan, Alt. & Hub	1600649	38506
Tensioner Pulley - Fan, Alt. & Hub	1600649	36091	Tensioner Assy. - Fan To A.C.	DCO568	38524
Tensioner Pulley - Fan To A.C.	DCO568	36091	Idler Pulley - Fan & Alt.; W/Flat Idler Pulley .	1337023	36091
Hose - Upper - Eng. To Pipe		21891	Idler Pulley - Fan & Alt.; W/Multi-Grooved		
Hose - Upper - Pipe To Rad.		24240	Idler Pulley	1731498	36231
Hose - Lower - Eng. To Pipe		21891	Tensioner Pulley - Fan, Alt. & Hub	1600649	36091
Hose - Lower - Pipe To Rad.		24240	Tensioner Pulley - Fan To A.C.	DCO568	36091
FLD			Condor		
Belt - Fan & Alt.	0128330002	K080850HD	Belt - Fan & Alt.	0124587007	♣K080878HD
Belt - Fan To A.C.	0129729330	♣K060523HD	Belt - A.C.		♣K060495HD
Tensioner Assy. - Fan & Alt.	1900649	38506	Tensioner Assy. - Fan, Alt. & Hub	1600649	38506
			Tensioner Assy. - Fan To A.C.	DCO568	38524

♣Standard Belt Available.

Belts and Coolant Hose for Medium/Heavy-Duty Trucks (2001 & Newer)

Medium & Heavy-Duty Trucks (2001 & Newer)

Application	Mfr. Part No.	Our No.
Freightliner - Continued		
2004 - Continued		
Caterpillar C12 Diesel - Continued		
Condor - Continued		
Idler Pulley - Fan & Alt.; W/Flat Idler Pulley .	1337023	36091
Idler Pulley - Fan & Alt.; W/Multi-Grooved		
Idler Pulley	1731498	36231
Tensioner Pulley - Fan, Alt. & Hub	1600649	36091
Tensioner Pulley - Fan To A.C.	DCO568	36091
FL112		
Belt - Fan & Alt.	0128330002	K080850HD
Belt - Fan To A.C.	0124196013	▲K060523HD
Tensioner Assy. - Fan, Alt. & Hub	1600649	38506
Tensioner Assy. - Fan To A.C.	DCO568	38524
Idler Pulley - Fan & Alt.; W/Flat Idler Pulley .	1337023	36091
Idler Pulley - Fan & Alt.; W/V-Groove Idler Pulley	1731498	36231
Tensioner Pulley - Fan, Alt. & Hub	1600649	36091
Tensioner Pulley - Fan To A.C.	DCO568	36091
FLD		
Belt - Fan & Alt.	0128330002	K080850HD
Belt - Fan To A.C.	0129729330	▲K060523HD
Tensioner Assy. - Fan & Alt.	1900649	38506
Tensioner Assy. - Fan To A.C.	DCO568	38524
Idler Pulley - Fan & Alt.; W/Flat Idler Pulley .	1337023	36091
Idler Pulley - Fan & Alt.; W/Multi-Grooved		
Idler Pulley	1731498	36231
Tensioner Pulley - Fan To A.C.	DCO568	36091
Hose - Upper - Eng. To Pipe		24240
Hose - Upper - Rad. To Pipe		21891
Hose - Lower - Eng. To Pipe		24240
Hose - Lower - Rad. To Pipe		21891
Caterpillar C13 Diesel		
Business Class M2		
Belt - Hub, Fan, Alt. & A.C.	0123415080	▲K081005HD
Tensioner Assy. - Hub, Fan, Alt. & A.C.	2117895	38590
Tensioner Pulley - Hub, Fan, Alt. & A.C.	2117895	36164
Idler Pulley - Smooth	2078118	36269
Idler Pulley - Grooved	1979642	36341
Hose - Upper - Eng. To Rad.		23086
Hose - Lower - Eng. To Rad.		22952
Century Class; Classic; Classic XL		
Idler Pulley - Smooth	2078118	36269
Idler Pulley - Grooved	1979642	36341
Columbia		
Belt - Fan, Alt. & A.C.	0123415055	▲K080952HD
Tensioner Assy. - Fan, Alt. & A.C.	2117895	38590
Tensioner Pulley - Fan, Alt. & A.C.	2117895	36164
Idler Pulley - Smooth	2078118	36269
Idler Pulley - Grooved	1979642	36341
Hose - Upper - Eng. To Pipe		22950
Hose - Lower - Eng. To Pipe		24240
Hose - Lower - Rad. To Pipe		24240
Condor; FLD		
Idler Pulley - Smooth	2078118	36269
Idler Pulley - Grooved	1979642	36341
Caterpillar C15 Diesel		
Argosy		
Belt - Fan & Alt.		▲K080952HD
Belt - Fan To A.C.		▲K060547HD
Tensioner Assy. - Fan & Alt.	1900649	38506
Tensioner Assy. - Fan To A.C.	1382514	38508
Tensioner Pulley - Fan & Alt.	1900649	36091
Tensioner Pulley - Fan To A.C.	1382514	36091
Hose - Upper - Eng. To Pipe		24240
Hose - Upper - Rad. To Pipe		24240
Hose - Lower - Eng. To Pipe		21400
Hose - Lower - Rad. To Pipe		≈21891

▲Standard Belt Available.

Application	Mfr. Part No.	Our No.
Freightliner - Continued		
2004 - Continued		
Caterpillar C15 Diesel - Continued		
Century Class		
Belt - Fan & Alt.	0123415029	▲K080952HD
Belt - Fan To A.C.	0126709006	▲K060598HD
Tensioner Assy. - Fan & Alt.	1352142	38506
Tensioner Assy. - Fan To A.C.	1382514	38508
Idler Pulley - Upper	1979641	36091
Idler Pulley - Grooved	1979642	36341
Tensioner Pulley - Fan & Alt.	1352142	36091
Tensioner Pulley - Fan To A.C.	1382514	36091
Hose - Upper - Eng. To Pipe		24240
Hose - Upper - Pipe To Rad.		24240
Hose - Lower - Eng. To Pipe		24248
Hose - Lower - Pipe To Rad.		24248
Classic		
Belt - Fan & Alt.	0123415079	▲K080991HD
Belt - Fan To A.C.	0127177010	▲K060586HD
Tensioner Assy. - Fan & Alt.	1900649	38506
Tensioner Assy. - Fan To A.C.	1382514	38508
Idler Pulley - Smooth	1979641	36091
Idler Pulley - Grooved	1979642	36341
Tensioner Pulley - Fan & Alt.	1900649	36091
Tensioner Pulley - Fan To A.C.	1382514	36091
Hose - Upper - Eng. To Pipe		21194
Hose - Upper - Pipe To Rad.		24240
Hose - Lower - Eng. To Rad.		23015
Classic XL		
Belt - Fan & Alt.	0123415050	▲K080944HD
Belt - Fan To A.C.	0126709007	▲K060547HD
Tensioner Assy. - Fan & Alt.	1900649	38506
Tensioner Assy. - Fan To A.C.	1382514	38508
Idler Pulley - Smooth	1979641	36091
Idler Pulley - Grooved	1979642	36341
Tensioner Pulley - Fan & Alt.	1900649	36091
Tensioner Pulley - Fan To A.C.	1382514	36091
Hose - Upper - Eng. To Pipe		24240
Hose - Upper - Pipe To Rad.		24240
Hose - Lower - Eng. To Pipe		24248
Hose - Lower - Pipe To Rad.		24240
Columbia		
Belt - Fan, Alt. & A.C.	0123415078	▲K080926HD
Tensioner Assy.	2002279	38569
Idler Pulley - Smooth	1979641	36091
Idler Pulley - Grooved	1979642	36341
Hose - Upper - Eng. To Pipe		≈24240
Hose - Upper - Rad. To Pipe		21891
Hose - Lower - Pipe To Rad.		≈24240
Coronado		
Belt - Fan & Alt.; W/130A. Alt.	0127110011	▲K080952HD
Belt - Fan & Alt.; W/135A. Alt.	0123415053	▲K080939HD
Belt - Fan To A.C.	0126709007	▲K060547HD
Tensioner Assy. - Fan & Alt.	1900649	38506
Tensioner Assy. - Fan To A.C.	1382514	38508
Idler Pulley - Smooth	1979641	36091
Idler Pulley - Grooved	1979642	36341
Tensioner Pulley - Fan & Alt.	1900649	36091
Tensioner Pulley - Fan To A.C.	1382514	36091
Hose - Upper - Eng. To Pipe		21891
Hose - Upper - Pipe To Rad.		24240
Hose - Lower - Eng. To Pipe		21891
Hose - Lower - Pipe To Rad.		24240
FLD		
Belt - Fan & Alt.	0123415050	▲K080944HD
Belt - Fan To A.C.	0126709007	▲K060547HD
Tensioner Assy. - Fan & Alt.	1900649	38506
Tensioner Assy. - Fan To A.C.	1382514	38508
Idler Pulley - Smooth	1979641	36091

≈Cut to Fit.

Belts and Coolant Hose for Medium/Heavy-Duty Trucks (2001 & Newer)

Medium & Heavy-Duty Trucks
(2001 & Newer)

Application	Mfr. Part No.	Our No.	Application	Mfr. Part No.	Our No.
Freightliner - Continued			Freightliner - Continued		
2004 - Continued			2004 - Continued		
Caterpillar C15 Diesel - Continued			Cummins ISC Diesel - Continued		
FLD - Continued			Business Class M2 - Continued		
Idler Pulley - Grooved	1979642	36341	Idler Pulley	3970945	36283
Tensioner Pulley - Fan & Alt.	1900649	36091	Tensioner Pulley - Fan & Alt.	3936213	36093
Tensioner Pulley - Fan To A.C.	1382514	36091	Hose - Upper - Eng. To Pipe		24236
Hose - Upper - Eng. To Pipe		24240	Hose - Upper - Rad. To Pipe		24232
Hose - Upper - Pipe To Rad.		24240	Hose - Lower - Rad. To Pipe		21891
Hose - Lower - Eng. To Pipe		24248	Condor		
Hose - Lower - Pipe To Rad.		24240	Belt - Alt.	3944838	♣K080755HD
Caterpillar C16 Diesel			Tensioner Assy. - Alt.	3936213	38516
Columbia			FL50; FL60; FL70; FL80		
Belt - Fan & Alt.; W/130A. Alt.	0123415050	♣K080944HD	Belt - Fan, Alt. & Hub	3289404	♣K080716HD
Belt - Fan & Alt.; W/135A. Alt.	0123415053	♣K080939HD	Belt - Fan To A.C.	2310001067	♣9480HD
Belt - Fan To A.C.	0126709007	♣K060547HD	Tensioner Assy. - Fan, Alt. & Hub	3936213	38516
Tensioner Assy. - Fan & Alt.	1352142	38506	Tensioner Pulley - Fan, Alt. & Hub	3936213	36093
Tensioner Assy. - Fan To A.C.	1382514	38508	Hose - Upper - Eng. To Pipe		24236
Tensioner Pulley - Fan & Alt.	1352142	36091	Hose - Upper - Pipe To Rad.		24232
Tensioner Pulley - Fan To A.C.	1382514	36091	Hose - Lower - Eng. To Pipe		20206
Hose - Upper - Eng. To Pipe		24240	Hose - Lower - Pipe To Cooler		21194
Hose - Upper - Pipe To Rad.		24240	Cummins ISL Diesel		
Hose - Lower - Eng. To Pipe		24052	Condor		
Hose - Lower - Pipe To Rad.		24240	Belt - Fan		♣K080765HD
FLD			Belt - A.C.		♣9412HD
Belt - Fan & Alt.	0123415050	♣K080944HD	Tensioner Assy.	3936213	38516
Belt - Fan To A.C.	0126709007	♣K060547HD	Hose - Upper - Rad. To Pipe		≈24232
Tensioner Assy. - Fan & Alt.	1900649	38506		or	≈24832
Tensioner Assy. - Fan To A.C.	1382514	38508	Hose - Upper - Pipe To Eng.		≈24236
Tensioner Pulley - Fan & Alt.	1900649	36091	Hose - Lower - Rad. To Cooler		24210
Tensioner Pulley - Fan To A.C.	1382514	36091	Hose - Lower - Cooler To Pipe		≈21891
Hose - Upper - Eng. To Pipe		24240	Hose - Lower - Pipe To Eng.		≈24236
Hose - Upper - Pipe To Rad.		24240	XC		
Hose - Lower - Eng. To Pipe		24248	Belt - Alt.	3911567	♣K080670HD
Hose - Lower - Pipe To Rad.		24240	Tensioner Assy. - Alt.	3936213	38516
Cummins 4-Cyl. 3.9 L Diesel			Detroit Diesel 6-Cyl. 12.7 L Diesel		
MT35			Argosy		
Belt - Fan & Alt.	3911587	♣K080537HD	Belt - Fan	0124894000	♣K100579HD
Tensioner Assy.	3970822	38504	Belt - Alt. & A.C.	0124587000	♣K080580HD
Hose - Upper - Eng. To Rad.		23951	Tensioner Assy. - Fan		38503
Cummins ISB Diesel			Tensioner Assy. - Alt. & A.C.	23520317	38501
FC70			Tensioner Pulley - Fan		38076
Belt - Alt. & A.C.	0127086001	♣K080594HD	Tensioner Pulley - Alt. & A.C.		38075
Tensioner Assy.	3936197	38517	Hose - Upper - Eng. To Pipe		24240
Tensioner Pulley	3936197	36095	Hose - Upper - Rad. To Pipe		24240
Hose - Upper - Eng. To Pipe		20206	Hose - Lower - Eng. To Cooler		24244
Hose - Upper - Pipe To Rad.		24232	Hose - Lower - Cooler To Pipe		24244
Hose - Lower - Eng. To Pipe		24232	Hose - Lower - Rad. To Pipe		≈21891
Hose - Lower - Cooler To Pipe		②21891	Century Class		
Hose - Lower - Pipe To Rad.		24232	Belt - Fan	0124894004	♣K100502HD
Cummins MT35; MT45			Belt - Hub To Alt. & A.C.	0124587004	♣K080565HD
Belt - Fan, Alt. & A.C.	3959840	♣K080825HD	Tensioner Assy. - Fan	0127846000	38503
Tensioner Assy. - Fan, Alt. & A.C.	3957433	38517	Tensioner Assy. - Hub, Alt. & A.C.	0127425000	38501
Hose - Upper - Eng. To Rad.		23114	Tensioner Pulley - Fan	0127846000	38076
Hose - Lower - Eng. To Pipe		24232	Tensioner Pulley - Hub, Alt. & A.C.	0127425000	38075
Hose - Lower - Rad. To Pipe		24232	Hose - Upper - Eng. To Pipe		24240
Cummins ISC Diesel			Hose - Upper - Rad. To Pipe		24240
Business Class M2			Hose - Lower - Eng. To Rad.		22877
Belt - Fan & Alt.	3289404	♣K080716HD	Hose - Oil Cooler To Heater; W/Beaded End		CT103
Tensioner Assy. - Fan & Alt.	3936213	38516	Hose - Oil Cooler To Heater; W/Threaded End		CT105
			Hose - Oil Cooler To Aux. Heater; W/Beaded End		CT104
			Hose - Oil Cooler To Aux. Heater; W/Threaded End		CT106
			Hose - W.P. Rear To Heater; W/Beaded End		CT102
			Hose - W.P. Rear To Heater; W/Threaded End		CT108
			Hose - W.P. Front To Aux. Heater; W/Beaded End		CT100
			Hose - W.P. Front To Aux. Heater; W/Threaded End		CT107
			Hose - W.P. To Reservoir		CT101

♣Standard Belt Available.
≈Cut to Fit.

②Two Required.

Belts and Coolant Hose for Medium/Heavy-Duty Trucks (2001 & Newer)

Medium & Heavy-Duty Trucks
(2001 & Newer)

Application	Mfr. Part No.	Our No.	Application	Mfr. Part No.	Our No.
Freightliner - Continued			Freightliner - Continued		
2004 - Continued			2004 - Continued		
Detroit Diesel 6-Cyl. 12.7 L Diesel - Continued			Detroit Diesel 6-Cyl. 12.7 L Diesel - Continued		
Classic			FLD - Continued		
Belt - Fan; V-Belt; Preferred Belt		3/9525PB	Tensioner Assy. - Hub, Alt. & A.C.	0127425000	38501
Belt - Fan; V-Belt; Optional Belt	2310001051	③▲9525HD	Tensioner Pulley - Hub, Alt. & A.C.	0127425000	38075
Belt - Fan; W/V-Ribbed Belt	0124894000	▲K100579HD	Hose - Upper - Eng. To Pipe		24240
Belt - Hub, Alt. & A.C.	0124587006	▲K080570HD	Hose - Upper - Pipe To Rad.		24240
Tensioner Assy. - Hub, Alt. & A.C.	0127425000	38501	Hose - Lower - Eng. To Pipe		24240
Tensioner Pulley - Hub, Alt. & A.C.	0127425000	38075	Hose - Lower - Pipe To Rad.		24240
Hose - Upper - Eng. To Pipe		24240			
Hose - Upper - Pipe To Rad.		24240	Detroit Diesel 6-Cyl. 14.0 L Diesel		
Hose - Lower - Eng. To Pipe		24240	Argosy		
Hose - Lower - Pipe To Rad.		24240	Belt - Fan	0124894000	▲K100579HD
			Belt - Alt. & A.C.	0124587000	▲K080580HD
Classic XL			Tensioner Assy. - Fan		38503
Belt - Fan; V-Belt; Preferred Belt		3/9525PB	Tensioner Assy. - Alt. & A.C.	23520317	38501
Belt - Fan; V-Belt; Optional Belt	2310001051	③▲9525HD	Tensioner Pulley - Fan		38076
Belt - Fan; W/V-Ribbed Belt	0124894000	▲K100579HD	Tensioner Pulley - Alt. & A.C.		38075
Belt - Hub, Alt. & A.C.	0124587006	▲K080570HD	Hose - Upper - Eng. To Pipe		24240
Tensioner Assy. - Hub, Alt. & A.C.	0127425000	38501	Hose - Upper - Rad. To Pipe		24240
Tensioner Pulley - Hub, Alt. & A.C.	0127425000	38075	Hose - Lower - Eng. To Cooler		24244
Hose - Upper - Eng. To Pipe		24240	Hose - Lower - Cooler To Pipe		24244
Hose - Upper - Pipe To Rad.		24240	Hose - Lower - Rad. To Pipe		≈<21891
Hose - Lower - Eng. To Pipe		24240	Century Class		
Hose - Lower - Pipe To Rad.		24240	Belt - Fan	0124894004	▲K100502HD
Hose - Oil Cooler To Heater; W/Beaded End		CT103	Belt - Hub To Alt. & A.C.	0124587004	▲K080565HD
Hose - Oil Cooler To Heater; W/Threaded End		CT105	Tensioner Assy. - Fan	0127846000	38503
Hose - Oil Cooler To Aux. Heater; W/Beaded End		CT104	Tensioner Assy. - Hub, Alt. & A.C.	0127425000	38501
Hose - Oil Cooler To Aux. Heater; W/Threaded End		CT106	Tensioner Pulley - Fan	0127846000	38076
Hose - W.P. Rear To Heater; W/Beaded End		CT102	Tensioner Pulley - Hub, Alt. & A.C.	0127425000	38075
Hose - W.P. Rear To Heater; W/Threaded End		CT108	Hose - Upper - Eng. To Pipe		24240
Hose - W.P. Front To Aux. Heater; W/Beaded End		CT100	Hose - Upper - Rad. To Pipe		24240
Hose - W.P. Front To Aux. Heater; W/Threaded End		CT107	Hose - Lower - Eng. To Rad.		22877
Hose - W.P. To Reservoir		CT101	Hose - Oil Cooler To Heater; W/Beaded End		CT103
Columbia			Hose - Oil Cooler To Heater; W/Threaded End		CT105
Belt - Fan	0124894004	▲K100502HD	Hose - Oil Cooler To Aux. Heater; W/Beaded End		CT104
Belt - Hub To Alt. & A.C.	0124587004	▲K080565HD	Hose - Oil Cooler To Aux. Heater; W/Threaded End		CT106
Tensioner Assy. - Fan	0127846000	38503	Hose - W.P. Rear To Heater; W/Beaded End		CT102
Tensioner Assy. - Hub, Alt. & A.C.	0127425000	38501	Hose - W.P. Rear To Heater; W/Threaded End		CT108
Tensioner Pulley - Fan	0127846000	38076	Hose - W.P. Front To Aux. Heater; W/Beaded End		CT100
Tensioner Pulley - Hub, Alt. & A.C.	0127425000	38075	Hose - W.P. Front To Aux. Heater; W/Threaded End		CT107
Hose - Upper - Eng. To Rad.		21135	Hose - W.P. To Reservoir		CT101
Hose - Upper - Rad. To Pipe		24240	Classic		
Hose - Lower - Eng. To Rad.		22877	Belt - Fan; V-Belt; Preferred Belt		3/9525PB
Hose - Oil Cooler To Heater; W/Beaded End		CT103	Belt - Fan; V-Belt; Optional Belt	2310001051	③▲9525HD
Hose - Oil Cooler To Heater; W/Threaded End		CT105	Belt - Fan; W/V-Ribbed Belt	0124894000	▲K100579HD
Hose - Oil Cooler To Aux. Heater; W/Beaded End		CT104	Belt - Hub, Alt. & A.C.	0124587006	▲K080570HD
Hose - Oil Cooler To Aux. Heater; W/Threaded End		CT106	Tensioner Assy. - Hub, Alt. & A.C.	0127425000	38501
Hose - W.P. Rear To Heater; W/Beaded End		CT102	Tensioner Pulley - Hub, Alt. & A.C.	0127425000	38075
Hose - W.P. Rear To Heater; W/Threaded End		CT108	Hose - Upper - Eng. To Pipe		24240
Hose - W.P. Front To Aux. Heater; W/Beaded End		CT100	Hose - Upper - Pipe To Rad.		24240
Hose - W.P. Front To Aux. Heater; W/Threaded End		CT107	Hose - Lower - Eng. To Pipe		24240
Hose - W.P. To Reservoir		CT101	Hose - Lower - Pipe To Rad.		24240
Coronado			Classic XL		
Belt - Fan	0124894004	▲K100502HD	Belt - Fan; V-Belt; Preferred Belt		3/9525PB
Belt - Hub, Alt. & A.C.	0124587004	▲K080565HD	Belt - Fan; V-Belt; Optional Belt	2310001051	③▲9525HD
Tensioner Assy. - Fan	0127846000	38503	Belt - Fan; W/V-Ribbed Belt	0124894000	▲K100579HD
Tensioner Assy. - Hub, Alt. & A.C.	0127425000	38501	Belt - Hub, Alt. & A.C.	0124587006	▲K080570HD
Tensioner Pulley - Fan	0127846000	38076	Tensioner Assy. - Hub, Alt. & A.C.	0127425000	38501
Tensioner Pulley - Hub, Alt. & A.C.	0127425000	38075	Tensioner Pulley - Hub, Alt. & A.C.	0127425000	38075
Hose - Upper - Eng. To Pipe		21135	Hose - Upper - Eng. To Pipe		24240
Hose - Upper - Pipe To Rad.		24240	Hose - Upper - Pipe To Rad.		24240
Hose - Lower - Eng. To Pipe		24240	Hose - Lower - Eng. To Pipe		24240
Hose - Lower - Pipe To Rad.		24240	Hose - Lower - Pipe To Rad.		24240
FLD			Hose - Oil Cooler To Heater; W/Beaded End		CT103
Belt - Fan; V-Belt; Preferred Belt		3/9525PB	Hose - Oil Cooler To Heater; W/Threaded End		CT105
Belt - Fan; V-Belt; Optional Belt	2310001051	③▲9525HD	Hose - Oil Cooler To Aux. Heater; W/Beaded End		CT104
Belt - Fan; W/V-Ribbed Belt	0124894000	▲K100579HD	Hose - Oil Cooler To Aux. Heater; W/Threaded End		CT106
Belt - Hub, Alt. & A.C.	0124587006	▲K080570HD			

▲Standard Belt Available.
≈<Cut to Fit.

③Three Required.

Belts and Coolant Hose for Medium/Heavy-Duty Trucks (2001 & Newer)

Medium & Heavy-Duty Trucks
(2001 & Newer)

Application	Mfr. Part No.	Our No.	Application	Mfr. Part No.	Our No.
Freightliner - Continued			Freightliner - Continued		
2004 - Continued			2004 - Continued		
Detroit Diesel 6-Cyl. 14.0 L Diesel - Continued			Mercedes-Benz MBE 900 Diesel - Continued		
Classic XL - Continued			MT45		
Hose - W.P. Rear To Heater; W/Beaded End		CT102	Belt - Fan, Alt. & A.C.	0127110045	▲K080830HD
Hose - W.P. Rear To Heater; W/Threaded End		CT108	Tensioner Assy.	A9062003170	38567
Hose - W.P. Front To Aux. Heater; W/Beaded End		CT100	Hose - Upper - Eng. To Rad.		20611
Hose - W.P. Front To Aux. Heater; W/Threaded End		CT107	Hose - Lower - Eng. To Pipe		21571
Hose - W.P. To Reservoir		CT101	Hose - Lower - Pipe To Rad.		20206
Columbia			Hose - Intercooler To Engine (Cold Side) ...	0129159000	29003
Belt - Fan	0124894004	▲K100502HD	Hose - Pipe To Intercooler (Hot Side)		26201
Belt - Hub To Alt. & A.C.	0124587004	▲K080565HD	MT55		
Tensioner Assy. - Fan	0127846000	38503	Belt - Fan, Alt. & A.C.; W/68" Belt O.C.	0127110051	▲K080675HD
Tensioner Assy. - Hub, Alt. & A.C.	0127425000	38501	Belt - Fan, Alt. & A.C.; W/83" Belt O.C.	0127110045	▲K080830HD
Tensioner Pulley - Fan	0127846000	38076	Hose - Upper - Eng. To Rad.		20611
Tensioner Pulley - Hub, Alt. & A.C.	0127425000	38075	Hose - Lower - Eng. To Pipe		21571
Hose - Upper - Eng. To Rad.		21135	Hose - Lower - Pipe To Rad.		20206
Hose - Upper - Rad. To Pipe		24240	Hose - Intercooler To Engine (Cold Side) ...	0129159000	29003
Hose - Lower - Eng. To Rad.		22877	Hose - Pipe To Intercooler (Hot Side)		26201
Hose - Oil Cooler To Heater; W/Beaded End		CT103	Mercedes-Benz MBE 4000 Diesel		
Hose - Oil Cooler To Heater; W/Threaded End		CT105	Business Class M2		
Hose - Oil Cooler To Aux. Heater; W/Beaded End		CT104	Belt - Fan	0127116007	▲K080575HD
Hose - Oil Cooler To Aux. Heater; W/Threaded End		CT106	Belt - Hub, Alt. & A.C.	0127116004	▲K080855HD
Hose - W.P. Rear To Heater; W/Beaded End		CT102	Tensioner Assy. - Fan	0127427001	38597
Hose - W.P. Rear To Heater; W/Threaded End		CT108	Tensioner Assy. - Hub, Alt. & A.C.	0127425000	38501
Hose - W.P. Front To Aux. Heater; W/Beaded End		CT100	Tensioner Pulley - Hub, Alt. & A.C.	0127425000	38075
Hose - W.P. Front To Aux. Heater; W/Threaded End		CT107	Hose - Upper - Eng. To Rad.		23013
Hose - W.P. To Reservoir		CT101	Hose - Lower - Eng. To Rad.		23014
Coronado			Century Class		
Belt - Fan	0124894004	▲K100502HD	Belt - Fan	0127086004	▲K080672HD
Belt - Hub, Alt. & A.C.	0124587004	▲K080565HD	Belt - Hub & Alt.	0127198001	▲K090609HD
Tensioner Assy. - Fan	0127846000	38503	Belt - A.C.	0127177001	▲K060439HD
Tensioner Assy. - Hub, Alt. & A.C.	0127425000	38501	Tensioner Assy. - Fan	A4572001970	38542
Tensioner Pulley - Fan	0127846000	38076	Tensioner Assy. - Hub & Alt.	A4602000770	38541
Tensioner Pulley - Hub, Alt. & A.C.	0127425000	38075	Tensioner Assy. - A.C.	A4602000870	38540
Hose - Upper - Eng. To Pipe		21135	Hose - Upper - Eng. To Rad.		24240
Hose - Upper - Pipe To Rad.		24240	Hose - Upper - Rad. To Pipe		24240
Hose - Lower - Eng. To Pipe		24240	Hose - Lower - Eng. To Rad.		21891
Hose - Lower - Pipe To Rad.		24240	Hose - Lower - Rad. To Pipe		24240
FLD			Classic; Columbia		
Belt - Fan; V-Belt; Preferred Belt		3/9525PB	Belt - Fan	0127086004	▲K080672HD
Belt - Fan; V-Belt; Optional Belt	2310001051	③▲9525HD	Belt - Hub & Alt.	0127198001	▲K090609HD
Belt - Fan; W/V-Ribbed Belt	0124894000	▲K100579HD	Belt - A.C.	0127177004	▲K060439HD
Belt - Hub, Alt. & A.C.	0124587006	▲K080570HD	Tensioner Assy. - Fan	A4602000970	38542
Tensioner Assy. - Hub, Alt. & A.C.	0127425000	38501	Tensioner Assy. - Hub & Alt.	A4602000770	38541
Tensioner Pulley - Hub, Alt. & A.C.	0127425000	38075	Tensioner Assy. - A.C.	A4602000870	38540
Hose - Upper - Eng. To Pipe		24240	Hose - Upper - Eng. To Pipe		24240
Hose - Upper - Pipe To Rad.		24240	Hose - Upper - Pipe To Rad.		24240
Hose - Lower - Eng. To Pipe		24240	Hose - Lower - Eng. To Pipe		21891
Hose - Lower - Pipe To Rad.		24240	Hose - Lower - Pipe To Rad.		24240
Mercedes-Benz MBE 900 Diesel			FL112		
Business Class M2			Belt - Fan		
Belt - Fan, Alt. & A.C.	0127110016	▲K080830HD	Belt - Hub & Alt.	0127198001	▲K090609HD
Belt - Fan & Alt.	0127110046	▲K080677HD	Belt - A.C.	0127117004	▲K060439HD
Tensioner Assy.	9062002470	38567	Tensioner Assy. - Fan	A4602000970	38542
Hose - Upper - Eng. To Rad.		⊃21378	Tensioner Assy. - Hub & Alt.	A4602000770	38541
Hose - Lower - Eng. To Pipe		20206	Tensioner Assy. - A.C.	A4602000870	38540
Hose - Lower - Rad. To Pipe		24232	Hose - Upper - Eng. To Pipe		24240
FL50; FL60; FL70; FL80			Hose - Upper - Pipe To Rad.		24240
Belt - Fan, Alt. & A.C.	0127110016	▲K080830HD	Hose - Lower - Eng. To Pipe		21891
Hose - Upper - Eng. To Rad.		22701	Hose - Lower - Pipe To Rad.		24240
Hose - Lower - Eng. To Pipe		20611	2003		
Hose - Lower - Pipe To Rad.		22702	Caterpillar 3126 Diesel		
MT35			Business Class M2		
Belt - Fan, Alt. & A.C.	0127110045	▲K080830HD	Belt - Fan, Alt. & A.C.; W/145A. Alt.	0123415040	▲K080774HD
Hose - Upper - Eng. To Rad.		20611	Belt - Fan, Alt. & A.C.; W/130A. Alt.	0123415058	▲K080780HD
Hose - Lower - Eng. To Rad.		21571	Tensioner Assy. - Fan, Alt. & A.C.	2201209	38550

▲Standard Belt Available.
⊃Cut to Fit.

③Three Required.

Belts and Coolant Hose for Medium/Heavy-Duty Trucks (2001 & Newer)

Medium & Heavy-Duty Trucks
(2001 & Newer)

Application	Mfr. Part No.	Our No.	Application	Mfr. Part No.	Our No.
Freightliner - Continued			Freightliner - Continued		
2003 - Continued			2003 - Continued		
Caterpillar 3126 Diesel - Continued			Caterpillar C10 Diesel - Continued		
Business Class M2 - Continued			FL112 - Continued		
Hose - Upper - Eng. To Rad.		22745	Tensioner Assy. - Fan, Alt. & Hub	1600649	38506
Hose - Lower - Eng. To Rad.		22744	Tensioner Assy. - Fan To A.C.	DC0568	38524
FL50; FL60; FL70; FL80			Idler Pulley - Fan & Alt.; W/Flat Idler Pulley .	1337023	36091
Belt - Fan, Alt. & A.C.; W/Delco Alt.	0123415000	♣K080702HD	Idler Pulley - Fan & Alt.; W/Multi-Grooved		
Belt - Fan, Alt. & A.C.; W/Leece Neville Alt. .	0127110003	♣K080708HD	Idler Pulley	1731498	36231
Belt - W.P.		♣9341HD	Tensioner Pulley - Fan, Alt. & Hub	1600649	36091
Tensioner Assy. - Fan, Alt. & A.C.	1352151	38511	Tensioner Pulley - Fan To A.C.	DC0568	36091
Idler Pulley - Alt. & A.C.	1445612	36096	Hose - Upper - Eng. To Pipe		21891
Tensioner Pulley - Fan, Alt. & A.C.	1352151	36091	Hose - Upper - Pipe To Rad.		24240
Hose - Upper - Eng. To Rad.		22668	Hose - Lower - Eng. To Pipe		21891
Hose - Lower - Eng. To Pipe; W/2 1/4" I.D. Hose		20748	Hose - Lower - Pipe To Rad.		24240
Hose - Lower - Eng. To Pipe; W/2" I.D. Hose		21571	FLD		
Hose - Lower - Rad. To Pipe; W/2 1/4" I.D. Hose		21194	Belt - Fan & Alt.; W/O Idler	0128330001	♣K080922HD
Hose - Lower - Rad. To Pipe; W/2" I.D. Hose		≈20611	Belt - Fan To A.C.	0129729220	♣K060480HD
Caterpillar C10 Diesel			Caterpillar C12 Diesel		
Argosy			Argosy		
Belt - Fan & Alt.	0128330003	♣K080855HD	Belt - Fan & Alt.	0128330003	♣K080855HD
Belt - Fan To A.C.	0129729330	♣K060523HD	Belt - Fan To A.C.	0129729330	♣K060523HD
Tensioner Assy. - Fan, Alt. & Hub	1600649	38506	Tensioner Assy. - Fan, Alt. & Hub	1600649	38506
Tensioner Assy. - Fan To A.C.	DC0568	38524	Tensioner Assy. - Fan To A.C.	DC0568	38524
Idler Pulley - Fan & Alt.; W/Flat Idler Pulley .	1337023	36091	Idler Pulley - Fan & Alt.; W/Flat Idler Pulley .	1337023	36091
Idler Pulley - Fan & Alt.; W/Multi-Grooved			Idler Pulley - Fan & Alt.; W/Multi-Grooved		
Idler Pulley	1731498	36231	Idler Pulley	1731498	36231
Tensioner Pulley - Fan, Alt. & Hub	1600649	36091	Tensioner Pulley - Fan, Alt. & Hub	1600649	36091
Tensioner Pulley - Fan To A.C.	DC0568	36091	Tensioner Pulley - Fan To A.C.	DC0568	36091
Century Class			Century Class		
Belt - Fan & Alt.; W/O Idler	0128330001	♣K080922HD	Belt - Fan & Alt.; W/O Idler	0128330001	♣K080922HD
Belt - Fan To A.C.	0129729220	♣K060480HD	Belt - Fan To A.C.	0129729220	♣K060480HD
Tensioner Assy. - Fan & Alt.	1900649	38506	Tensioner Assy. - Fan & Alt.	1900649	38506
Tensioner Assy. - Fan To A.C.	DC0568	38524	Tensioner Assy. - Fan To A.C.	DC0568	38524
Idler Pulley - Fan & Alt.; W/Flat Idler Pulley .	1337023	36091	Idler Pulley - Fan & Alt.; W/Flat Idler Pulley .	1337023	36091
Idler Pulley - Fan & Alt.; W/Multi-Grooved			Idler Pulley - Fan & Alt.; W/Multi-Grooved		
Idler Pulley	1731498	36231	Idler Pulley	1731498	36231
Tensioner Pulley - Fan To A.C.	DC0568	36091	Tensioner Pulley - Fan, Alt. & Hub	1600649	36091
Classic; Classic XL			Classic; Classic XL		
Idler Pulley - Fan & Alt.; W/Flat Idler Pulley .	1337023	36091	Idler Pulley - Fan & Alt.; W/Flat Idler Pulley .	1337023	36091
Idler Pulley - Fan & Alt.; W/Multi-Grooved			Idler Pulley - Fan & Alt.; W/Multi-Grooved		
Idler Pulley	1731498	36231	Idler Pulley	1731498	36231
Columbia			Columbia		
Belt - Fan, Alt. & Hub	0123415056	K080850HD	Belt - Fan, Alt. & Hub	0123415056	K080850HD
Belt - Fan To A.C.	0124196013	♣K060523HD	Belt - Fan To A.C.	0124196013	♣K060523HD
Tensioner Assy. - Fan, Alt. & Hub	1600649	38506	Tensioner Assy. - Fan, Alt. & Hub	1600649	38506
Tensioner Assy. - Fan To A.C.	DC0568	38524	Tensioner Assy. - Fan To A.C.	DC0568	38524
Idler Pulley - Fan & Alt.; W/Flat Idler Pulley .	1337023	36091	Idler Pulley - Fan & Alt.; W/Flat Idler Pulley .	1337023	36091
Idler Pulley - Fan & Alt.; W/Multi-Grooved			Idler Pulley - Fan & Alt.; W/Multi-Grooved		
Idler Pulley	1731498	36231	Idler Pulley	1731498	36231
Tensioner Pulley - Fan, Alt. & Hub	1600649	36091	Tensioner Pulley - Fan, Alt. & Hub	1600649	36091
Tensioner Pulley - Fan To A.C.	DC0568	36091	Tensioner Pulley - Fan To A.C.	DC0568	36091
Hose - Upper - Eng. To Pipe		21891	Hose - Upper - Eng. To Pipe		21891
Hose - Upper - Pipe To Rad.		21891	Hose - Upper - Pipe To Rad.		21891
Hose - Lower - Eng. To Pipe		21891	Hose - Lower - Eng. To Pipe		21891
Hose - Lower - Pipe To Rad.		24240	Hose - Lower - Pipe To Rad.		24240
Condor			Condor		
Belt - Fan & Alt.	0124587007	♣K080878HD	Belt - Fan & Alt.	0124587007	♣K080878HD
Belt - A.C.		♣K060495HD	Belt - A.C.		♣K060495HD
Tensioner Assy. - Fan, Alt. & Hub	1600649	38506	Tensioner Assy. - Fan, Alt. & Hub	1600649	38506
Tensioner Assy. - Fan To A.C.	DC0568	38524	Tensioner Assy. - Fan To A.C.	DC0568	38524
Idler Pulley - Fan & Alt.; W/Flat Idler Pulley .	1337023	36091	Idler Pulley - Fan & Alt.; W/Flat Idler Pulley .	1337023	36091
Idler Pulley - Fan & Alt.; W/Multi-Grooved			Idler Pulley - Fan & Alt.; W/Multi-Grooved		
Idler Pulley	1731498	36231	Idler Pulley	1731498	36231
Tensioner Pulley - Fan, Alt. & Hub	1600649	36091	Tensioner Pulley - Fan, Alt. & Hub	1600649	36091
Tensioner Pulley - Fan To A.C.	DC0568	36091	Tensioner Pulley - Fan To A.C.	DC0568	36091
FL112			FL112		
Belt - Fan, Alt. & Hub	0123415034	♣K080872HD	Belt - Fan, Alt. & Hub	0123415034	♣K080872HD
Belt - Fan To A.C.	0126709000	♣K060529HD	Belt - Fan To A.C.	0126709000	♣K060529HD

♣Standard Belt Available.

≈Cut to Fit.

Belts and Coolant Hose for Medium/Heavy-Duty Trucks (2001 & Newer)

Application	Mfr. Part No.	Our No.	Application	Mfr. Part No.	Our No.
Freightliner - Continued			Freightliner - Continued		
2003 - Continued			2003 - Continued		
Caterpillar C12 Diesel - Continued			Caterpillar C15 Diesel - Continued		
Condor			Classic - Continued		
Belt - Fan & Alt.	0124587007	♣K080878HD	Tensioner Pulley - Fan & Alt.	1900649	36091
Belt - A.C.		♣K060495HD	Tensioner Pulley - Fan To A.C.	1382514	36091
Tensioner Assy. - Fan, Alt. & Hub	1600649	38506	Hose - Upper - Eng. To Pipe		24240
Tensioner Assy. - Fan To A.C.	DC0568	38524	Hose - Upper - Pipe To Rad.		24240
Idler Pulley - Fan & Alt.; W/Flat Idler Pulley.	1337023	36091	Hose - Lower - Eng. To Pipe		24248
Idler Pulley - Fan & Alt.; W/Multi-Grooved Idler Pulley	1731498	36231	Hose - Lower - Pipe To Rad.		24240
Tensioner Pulley - Fan, Alt. & Hub	1600649	36091	Classic XL		
Tensioner Pulley - Fan To A.C.	DC0568	36091	Belt - Fan & Alt.	0123415050	♣K080944HD
FL112			Belt - Fan To A.C.	0126709007	♣K060547HD
Belt - Fan, Alt. & Hub	0123415034	♣K080872HD	Tensioner Assy. - Fan & Alt.	1900649	38506
Belt - Fan To A.C.	0126709000	♣K060529HD	Tensioner Assy. - Fan To A.C.	1900642	38508
Tensioner Assy. - Fan, Alt. & Hub	1600649	38506	Idler Pulley - Lower (Grooved)	1731498	36231
Tensioner Assy. - Fan To A.C.	DC0568	38524	Idler Pulley - Upper (Smooth)	1337023	36091
Idler Pulley - Fan & Alt.; W/Flat Idler Pulley.	1337023	36091	Hose - Upper - Eng. To Pipe		24240
Idler Pulley - Fan & Alt.; W/Multi-Grooved Idler Pulley	1731498	36231	Hose - Upper - Pipe To Rad.		24240
Tensioner Pulley - Fan, Alt. & Hub	1600649	36091	Hose - Lower - Eng. To Pipe		24248
Tensioner Pulley - Fan To A.C.	DC0568	36091	Hose - Lower - Pipe To Rad.		24240
Hose - Upper - Eng. To Pipe		21891	Columbia		
Hose - Upper - Pipe To Rad.		24240	Belt - Fan & Alt.; W/130A. Alt.	0123415050	♣K080944HD
Hose - Lower - Eng. To Pipe		21891	Belt - Fan & Alt.; W/135A. Alt.	0123415053	♣K080939HD
Hose - Lower - Pipe To Rad.		24240	Belt - Fan To A.C.	0126709007	♣K060547HD
FLD			Tensioner Assy. - Fan & Alt.	1352142	38506
Belt - Fan & Alt.; W/O Idler	0128330001	♣K080922HD	Tensioner Assy. - Fan To A.C.	1382514	38508
Belt - Fan To A.C.	0129729220	♣K060480HD	Tensioner Pulley - Fan & Alt.	1352142	36091
Tensioner Assy. - Fan & Alt.	1900649	38506	Tensioner Pulley - Fan To A.C.	1382514	36091
Tensioner Assy. - Fan To A.C.	DC0568	38524	Hose - Upper - Eng. To Pipe		24240
Idler Pulley - Fan & Alt.; W/Flat Idler Pulley.	1337023	36091	Hose - Upper - Pipe To Rad.		24240
Idler Pulley - Fan & Alt.; W/Multi-Grooved Idler Pulley	1731498	36231	Hose - Lower - Eng. To Pipe		24052
Tensioner Pulley - Fan To A.C.	DC0568	36091	Hose - Lower - Pipe To Rad.		24240
Hose - Upper - Eng. To Pipe		21891	Coronado		
Hose - Upper - Pipe To Rad.		24240	Belt - Fan & Alt.; W/130A. Alt.	0127110011	♣K080952HD
Hose - Lower - Eng. To Pipe		21891	Belt - Fan & Alt.; W/135A. Alt.	0123415053	♣K080939HD
Hose - Lower - Pipe To Cooler		24240	Belt - Fan To A.C.	0126709007	♣K060547HD
Hose - Lower - Pipe To Rad.		24240	Tensioner Assy. - Fan & Alt.	1900649	38506
Caterpillar C15 Diesel			Tensioner Assy. - Fan To A.C.	1382514	38508
Argosy			Tensioner Pulley - Fan & Alt.	1900649	36091
Belt - Fan & Alt.		♣K080952HD	Tensioner Pulley - Fan To A.C.	1382514	36091
Belt - Fan To A.C.		♣K060547HD	Hose - Upper - Eng. To Pipe		21891
Tensioner Assy. - Fan & Alt.	1900649	38506	Hose - Upper - Pipe To Rad.		24240
Tensioner Assy. - Fan To A.C.	1382514	38508	Hose - Lower - Eng. To Pipe		21891
Tensioner Pulley - Fan & Alt.	1900649	36091	Hose - Lower - Pipe To Rad.		24240
Tensioner Pulley - Fan To A.C.	1382514	36091	FLD		
Hose - Upper - Eng. To Pipe		24240	Belt - Fan & Alt.	0123415050	♣K080944HD
Hose - Upper - Rad. To Pipe		24240	Belt - Fan To A.C.	0126709007	♣K060547HD
Hose - Lower - Eng. To Pipe		21400	Tensioner Assy. - Fan & Alt.	1900649	38506
Hose - Lower - Rad. To Pipe		≧21891	Tensioner Assy. - Fan To A.C.	1382514	38508
Century Class			Tensioner Pulley - Fan & Alt.	1900649	36091
Belt - Fan & Alt.	0123415029	♣K080952HD	Tensioner Pulley - Fan To A.C.	1382514	36091
Belt - Fan To A.C.	0126709006	♣K060598HD	Hose - Upper - Eng. To Pipe		24240
Tensioner Assy. - Fan & Alt.	1352142	38506	Hose - Upper - Pipe To Rad.		24240
Tensioner Assy. - Fan To A.C.	1382514	38508	Hose - Lower - Eng. To Pipe		24248
Tensioner Pulley - Fan & Alt.	1352142	36091	Hose - Lower - Pipe To Rad.		24248
Tensioner Pulley - Fan To A.C.	1382514	36091	Classic		
Hose - Upper - Eng. To Pipe		24240	Belt - Fan & Alt.	0123415050	♣K080944HD
Hose - Upper - Pipe To Rad.		24240	Belt - Fan To A.C.	0126709007	♣K060547HD
Hose - Lower - Eng. To Pipe		24248	Tensioner Assy. - Fan & Alt.	1900649	38506
Hose - Lower - Pipe To Rad.		24248	Tensioner Assy. - Fan To A.C.	1382514	38508
Classic			Tensioner Pulley - Fan & Alt.	1900649	36091
Belt - Fan & Alt.	0123415050	♣K080944HD	Tensioner Pulley - Fan To A.C.	1382514	36091
Belt - Fan To A.C.	0126709007	♣K060547HD	Hose - Upper - Eng. To Pipe		24240
Tensioner Assy. - Fan & Alt.	1900649	38506	Hose - Upper - Pipe To Rad.		24240
Tensioner Assy. - Fan To A.C.	1382514	38508	Hose - Lower - Eng. To Pipe		24248
Caterpillar C16 Diesel			Hose - Lower - Pipe To Rad.		24240
Classic; Classic XL			Classic; Classic XL		
Belt - Fan & Alt.	0123415050	♣K080944HD	Belt - Fan & Alt.	0123415050	♣K080944HD
Belt - Fan To A.C.	0126709007	♣K060547HD	Belt - Fan To A.C.	0126709007	♣K060547HD
Tensioner Assy. - Fan & Alt.	1900649	38506	Tensioner Assy. - Fan & Alt.	1900649	38506
Tensioner Assy. - Fan To A.C.	1382514	38508	Tensioner Assy. - Fan To A.C.	1382514	38508
Tensioner Pulley - Fan & Alt.	1900649	36091	Tensioner Pulley - Fan & Alt.	1900649	36091
Tensioner Pulley - Fan To A.C.	1382514	36091	Tensioner Pulley - Fan To A.C.	1382514	36091
Hose - Upper - Eng. To Pipe		24240	Hose - Upper - Eng. To Pipe		24240
Hose - Upper - Pipe To Rad.		24240	Hose - Upper - Pipe To Rad.		24240
Hose - Lower - Eng. To Pipe		24248	Hose - Lower - Eng. To Pipe		24248
Hose - Lower - Pipe To Rad.		24240	Hose - Lower - Pipe To Rad.		24240

Medium & Heavy-Duty Trucks
(2001 & Newer)

♣Standard Belt Available.

≧Cut to Fit.

Belts and Coolant Hose for Medium/Heavy-Duty Trucks (2001 & Newer)

Medium & Heavy-Duty Trucks
(2001 & Newer)

Application	Mfr. Part No.	Our No.	Application	Mfr. Part No.	Our No.
Freightliner - Continued			Freightliner - Continued		
2003 - Continued			2003 - Continued		
Caterpillar C16 Diesel - Continued			Cummins ISB Diesel - Continued		
Columbia			MT45 - Continued		
Belt - Fan & Alt.: W/130A. Alt.	0123415050	♣K080944HD	Hose - Lower - Eng. To Pipe		24236
Belt - Fan & Alt.: W/135A. Alt.	0123415053	♣K080939HD	Hose - Lower - Pipe To Rad.		24232
Belt - Fan To A.C.	0126709007	♣K060547HD	MT55		
Tensioner Assy. - Fan & Alt.	1352142	38506	Belt - Fan To Alt.	3943214	♣K080726HD
Tensioner Assy. - Fan To A.C.	1382514	38508	Belt - Fan To A.C.	17430	♣9430HD
Tensioner Pulley - Fan & Alt.	1352142	36091	Tensioner Assy. - Fan, Alt. & Hub	3936213	38516
Tensioner Pulley - Fan To A.C.	1382514	36091	Tensioner Pulley - Fan, Alt. & Hub	3936213	36093
Hose - Upper - Eng. To Pipe		24240	Hose - Upper - Eng. To Rad.		22795
Hose - Upper - Pipe To Rad.		24240	Hose - Lower - Eng. To Pipe		24236
Hose - Lower - Eng. To Pipe		24052	Hose - Lower - Pipe To Rad.		24232
Hose - Lower - Pipe To Rad.		24240	Cummins ISC Diesel		
Coronado			Condor		
Belt - Fan & Alt.: W/130A. Alt.	0127110011	♣K080952HD	Belt - Alt.	3944838	♣K080755HD
Belt - Fan & Alt.: W/135A. Alt.	0123415053	♣K080939HD	Tensioner Assy. - Alt.	3936213	38516
Belt - Fan To A.C.	0126709007	♣K060547HD	FL50; FL60; FL70; FL80		
Tensioner Assy. - Fan & Alt.	1900649	38506	Belt - Fan, Alt. & Hub	3911583	♣K080708HD
Tensioner Assy. - Fan To A.C.	1382514	38508	Belt - Fan To A.C.	2310001067	♣9480HD
Tensioner Pulley - Fan & Alt.	1900649	36091	Tensioner Assy. - Fan, Alt. & Hub	3936213	38516
Tensioner Pulley - Fan To A.C.	1382514	36091	Tensioner Pulley - Fan, Alt. & Hub	3936213	36093
Hose - Upper - Eng. To Pipe		21891	Hose - Upper - Eng. To Pipe		24236
Hose - Upper - Pipe To Rad.		24240	Hose - Upper - Pipe To Rad.		21571
Hose - Lower - Eng. To Pipe		21891	Hose - Lower - Eng. To Pipe		20206
Hose - Lower - Pipe To Rad.		24240	Hose - Lower - Pipe To Rad.		20206
FLD			Cummins ISL Diesel		
Belt - Fan & Alt.	0123415050	♣K080944HD	Condor		
Belt - Fan To A.C.	0126709007	♣K060547HD	Tensioner Assy.	3936213	38516
Tensioner Assy. - Fan & Alt.	1900649	38506	Hose - Upper - Rad. To Pipe		≈24232
Tensioner Assy. - Fan To A.C.	1382514	38508		or	≈24832
Tensioner Pulley - Fan & Alt.	1900649	36091	Hose - Upper - Pipe To Eng.		≈24236
Tensioner Pulley - Fan To A.C.	1382514	36091	Hose - Lower - Rad. To Cooler		24210
Hose - Upper - Eng. To Pipe		24240	Hose - Lower - Cooler To Pipe		≈21891
Hose - Upper - Pipe To Rad.		24240	Hose - Lower - Pipe To Eng.		≈24236
Hose - Lower - Eng. To Pipe		24248	XC		
Hose - Lower - Pipe To Rad.		24240	Belt - Alt.	3911567	♣K080670HD
Cummins 4-Cyl. 3.9 L Diesel			Tensioner Assy. - Alt.	3936213	38516
MT35			Cummins ISM Diesel		
Belt - Fan & Alt.	3911587	♣K080537HD	Classic; Classic XL		
Tensioner Assy.	3970822	38504	Belt - Fan, Alt. & Hub	0127110014	♣K080817HD
Hose - Upper - Eng. To Rad.		22795	Belt - Hub & A.C.	0124196015	♣K060559HD
Hose - Lower - Eng. To Pipe		24236	Tensioner Assy. - Fan, Alt. & Hub	3400885	38521
Hose - Lower - Pipe To Rad.		24232	Tensioner Assy. - Hub & A.C.	4004933	38505
Cummins ISB Diesel			Idler Pulley - Fan & Alt.	3400884	36308
FC70; FC80			Tensioner Pulley - A.C.	4004933	36091
Belt - Alt. & A.C.	0127086001	♣K080594HD	Hose - Upper - Eng. To Pipe		24236
Tensioner Assy.	3936197	38517	Hose - Upper - Pipe To Rad.		24240
Tensioner Pulley	3936197	36095	Hose - Lower - Eng. To Cooler		24240
Hose - Upper - Eng. To Pipe		20206	Hose - Lower - Pipe To Cooler		21042
Hose - Upper - Pipe To Rad.		24232	Hose - Lower - Cooler To Pipe		24248
Hose - Lower - Eng. To Pipe		24232	Hose - Lower - Pipe To Rad.		24240
Hose - Lower - Cooler To Pipe		@21891	Columbia		
Hose - Lower - Pipe To Rad.		24232	Belt - Fan & Alt.	0127110006	♣K080730HD
FL50; FL60; FL70; FL80			Belt - Hub & A.C.	0126709009	♣K060575HD
Belt - Fan, Alt. & Hub	3926856	♣K080694HD	Tensioner Assy. - Fan & Alt.	3400885	38521
Belt - Fan & A.C.	2310001043	♣9447HD	Tensioner Assy. - Hub & A.C.	4004933	38505
Tensioner Assy. - Fan, Alt. & Hub	3936213	38516	Idler Pulley - Fan & Alt.	3400884	36308
Tensioner Pulley - Fan, Alt. & Hub	3936213	36093	Tensioner Pulley - A.C.	4004933	36091
Hose - Upper - Eng. To Rad.		22700	FL112		
Hose - Lower - Eng. To Rad.		22704	Belt - Fan & Alt.	0127110006	♣K080730HD
MT45			Belt - Hub & A.C.	0126709008	♣K060559HD
Belt - Fan, Alt. & Hub	3943214	♣K080726HD	Tensioner Assy. - Fan & Alt.	3400885	38521
Belt - Fan To A.C.	17430	♣9430HD	Tensioner Assy. - Hub & A.C.	4004933	38505
Tensioner Assy. - Fan, Alt. & Hub	3936213	38516	Idler Pulley - Fan & Alt.	3400884	36308
Tensioner Pulley - Fan, Alt. & Hub	3936213	36093	Tensioner Pulley - A.C.	4004933	36091
Hose - Upper - Eng. To Rad.		22795			

♣Standard Belt Available.
≈Cut to Fit.

@Two Required.

Belts and Coolant Hose for Medium/Heavy-Duty Trucks (2001 & Newer)

Application	Mfr. Part No.	Our No.	Application	Mfr. Part No.	Our No.
Freightliner - Continued			Freightliner - Continued		
2003 - Continued			2003 - Continued		
Cummins ISM Diesel - Continued			Detroit Diesel 6-Cyl. 11.1 L Diesel - Continued		
FL112 - Continued			Argosy - Continued		
Hose - Upper - Eng. To Pipe		24240	Hose - Upper - Rad. To Pipe		24240
Hose - Upper - Pipe To Rad.		24240	Hose - Lower - Eng. To Cooler		24244
Hose - Lower - Eng. To Pipe		24240	Hose - Lower - Cooler To Pipe		24244
Hose - Lower - Pipe To Rad.		24240	Hose - Lower - Rad. To Pipe		≠21891
FLD			Century Class		
Belt - Fan, Alt. & Hub	0127110014	♣K080817HD	Belt - Fan; Preferred Belt; W/50 3/8" Belt O.C.		3/9500PB
Belt - Hub & A.C.	0124196015	♣K060559HD	Belt - Fan; Optional Belt; W/50 3/8" Belt O.C.	2310001022	③♣9500HD
Tensioner Assy. - Fan, Alt. & Hub	3400885	38521	Belt - Fan; W/V-Ribbed Belt	0124894009	K100529HD
Tensioner Assy. - Hub & A.C.	4004933	38505	Belt - Hub, Alt. & A.C.	0124587006	♣K080570HD
Idler Pulley - Fan & Alt.	3400884	36308	Tensioner Assy. - Hub, Alt. & A.C.	23520317	38501
Tensioner Pulley - A.C.	4004933	36091	Tensioner Pulley - Hub, Alt. & A.C.	23520317	38075
Hose - Upper - Eng. To Pipe		24236	Hose - Upper - Eng. To Pipe		21891
Hose - Upper - Pipe To Rad.		24240	Hose - Upper - Pipe To Rad.		24240
Hose - Lower - Eng. To Cooler		24240	Hose - Lower - Eng. To Pipe		24240
Hose - Lower - Pipe To Cooler		21042	Hose - Lower - Pipe To Rad.		24240
Hose - Lower - Cooler To Pipe		24248			
Hose - Lower - Pipe To Rad.		24240			
Cummins ISX Diesel			Detroit Diesel 6-Cyl. 12.7 L Diesel		
Argosy; FLD			Argosy		
Belt - Fan & W.P.		♣K060685HD	Belt - Fan	0124894000	♣K100579HD
Belt - W.P., Alt. & A.C.		♣K100710HD	Belt - Alt. & A.C.	0124587000	♣K080580HD
Tensioner Assy. - Fan	3681240	38535	Tensioner Assy. - Fan	23520317	38503
Tensioner Assy. - Hub, Alt. & A.C.	3680194	38532	Tensioner Assy. - Alt. & A.C.	23520317	38501
Idler Pulley - Alt. & A.C.	4026886	36226	Tensioner Pulley - Fan		38076
Tensioner Pulley - Fan	3681240	36092	Tensioner Pulley - Alt. & A.C.		38075
Tensioner Pulley - Hub, Alt. & A.C.	3680194	36095	Hose - Upper - Eng. To Pipe		24240
			Hose - Upper - Rad. To Pipe		24240
			Hose - Lower - Eng. To Cooler		24244
			Hose - Lower - Cooler To Pipe		24244
			Hose - Lower - Rad. To Pipe		≠21891
Cummins N14 Diesel			Century Class		
Classic XL			Belt - Fan; Preferred Belt; W/50 3/8" Belt O.C.		
Belt - Fan	0127191000	2/TR28466PB	Belt - Fan; Optional Belt; W/50 3/8" Belt O.C.	2310001022	③♣9500HD
Belt - Hub & W.P.		♣K060425HD	Belt - Fan; W/V-Ribbed Belt	0124894009	K100529HD
Belt - Alt.	2310001028	♣9451HD	Belt - Hub, Alt. & A.C.	0124587006	♣K080570HD
Belt - Hub & A.C.	2310001087	♣9435HD	Tensioner Assy. - Hub, Alt. & A.C.	23520317	38501
Hose - Upper - Eng. To Pipe		24240	Tensioner Pulley - Hub, Alt. & A.C.	23520317	38075
Hose - Upper - Pipe To Rad.		24240	Hose - Upper - Eng. To Pipe		21891
Hose - Lower - Eng. To Pipe		24240	Hose - Upper - Pipe To Rad.		24240
Hose - Lower - Pipe To Rad.		24248	Hose - Lower - Eng. To Pipe		24240
Columbia			Hose - Lower - Pipe To Rad.		
Belt - Fan & Hub	0127191002	TR28445	Hose - Oil Cooler To Heater; W/Beaded End		CT103
Belt - Hub & W.P.		♣K060425HD	Hose - Oil Cooler To Heater; W/Threaded End		CT105
Belt - Alt.	2310001028	②♣9451HD	Hose - Oil Cooler To Aux. Heater; W/Beaded End		CT104
Belt - Hub & A.C.	GT17446	♣9447HD	Hose - Oil Cooler To Aux. Heater; W/Threaded End		CT106
Hose - Upper - Eng. To Rad.		24240	Hose - W.P. Rear To Heater; W/Beaded End		CT102
Hose - Upper - Pipe To Rad.		24240	Hose - W.P. Rear To Heater; W/Threaded End		CT108
Hose - Lower - Eng. To Rad.		24240	Hose - W.P. Front To Aux. Heater; W/Beaded End		CT100
Hose - Lower - Pipe To Rad.		24240	Hose - W.P. Front To Aux. Heater; W/Threaded End		CT107
FLD			Hose - W.P. To Reservoir		
Belt - Fan	0127191000	2/TR28466PB			CT101
Belt - Hub & W.P.		♣K060425HD	Classic		
Belt - Alt.	2310001028	♣9451HD	Belt - Fan; Preferred Belt		3/9525PB
Belt - Hub & A.C.	2310001087	♣9435HD	Belt - Fan; Optional Belt		③♣9525HD
Hose - Upper - Eng. To Pipe		24240	Belt - Hub, Alt. & A.C.; W/130A. Alt.	0124587000	♣K080580HD
Hose - Upper - Pipe To Rad.		24240	Belt - Hub, Alt. & A.C.; W/135A. Alt.	0124587006	♣K080570HD
Hose - Lower - Eng. To Pipe		24240	Tensioner Assy. - Hub, Alt. & A.C.	0127425000	38501
Hose - Lower - Pipe To Rad.		24248	Tensioner Pulley - Hub, Alt. & A.C.	0127425000	38075
Detroit Diesel 6-Cyl. 11.1 L Diesel			Hose - Upper - Eng. To Pipe		
Argosy			Hose - Upper - Pipe To Rad.		
Belt - Fan	0124894000	♣K100579HD	Hose - Lower - Eng. To Pipe		24240
Belt - Alt. & A.C.	0124587000	♣K080580HD	Hose - Lower - Pipe To Rad.		24240
Tensioner Assy. - Fan		38503			
Tensioner Assy. - Alt. & A.C.	23520317	38501	Classic XL		
Tensioner Pulley - Fan		38076	Belt - Fan; Preferred Belt		3/9525PB
Tensioner Pulley - Alt. & A.C.		38075	Belt - Fan; Optional Belt		③♣9525HD
Hose - Upper - Eng. To Pipe		24240	Belt - Hub, Alt. & A.C.; W/130A. Alt.	0124587000	♣K080580HD

**Medium & Heavy-Duty Trucks
(2001 & Newer)**

♣Standard Belt Available.
≠Cut to Fit.

②Two Required.
③Three Required.

Belts and Coolant Hose for Medium/Heavy-Duty Trucks (2001 & Newer)

Medium & Heavy-Duty Trucks
(2001 & Newer)

Application	Mfr. Part No.	Our No.	Application	Mfr. Part No.	Our No.
Freightliner - Continued			Freightliner - Continued		
2003 - Continued			2003 - Continued		
Detroit Diesel 6-Cyl. 12.7 L Diesel - Continued			Detroit Diesel 6-Cyl. 14.0 L Diesel - Continued		
Classic XL - Continued			Argosy - Continued		
Belt - Hub, Alt. & A.C.; W/135A. Alt.	0124587006	♣K080570HD	Tensioner Pulley - Alt. & A.C.		38075
Tensioner Assy. - Hub, Alt. & A.C.	0127425000	38501	Hose - Upper - Eng. To Pipe		24240
Tensioner Pulley - Hub, Alt. & A.C.	0127425000	38075	Hose - Upper - Rad. To Pipe		24240
Hose - Upper - Eng. To Pipe		24240	Hose - Lower - Eng. To Cooler		24244
Hose - Upper - Pipe To Rad.		24240	Hose - Lower - Cooler To Pipe		24244
Hose - Lower - Eng. To Pipe		24240	Hose - Lower - Rad. To Pipe		≈21891
Hose - Lower - Pipe To Rad.		24240	Century Class		
Hose - Oil Cooler To Heater; W/Beaded End		CT103	Belt - Fan; Preferred Belt; W/50 3/8" Belt O.C.		3/9500PB
Hose - Oil Cooler To Heater; W/Threaded End		CT105	Belt - Fan; Optional Belt; W/50 3/8" Belt		
Hose - Oil Cooler To Aux. Heater; W/Beaded End		CT104	O.C.	2310001022	③♣9500HD
Hose - Oil Cooler To Aux. Heater; W/Threaded End		CT106	Belt - Fan; W/V-Ribbed Belt	0124894009	K100529HD
Hose - W.P. Rear To Heater; W/Beaded End		CT102	Belt - Hub, Alt. & A.C.	0124587006	♣K080570HD
Hose - W.P. Rear To Heater; W/Threaded End		CT108	Tensioner Assy. - Hub, Alt. & A.C.	23520317	38501
Hose - W.P. Front To Aux. Heater; W/Beaded End		CT100	Tensioner Pulley - Hub, Alt. & A.C.	23520317	38075
Hose - W.P. Front To Aux. Heater; W/Threaded End		CT107	Hose - Upper - Eng. To Pipe		21891
Hose - W.P. To Reservoir		CT101	Hose - Upper - Pipe To Rad.		24240
Columbia			Hose - Lower - Eng. To Pipe		24240
Belt - Fan; Preferred Belt; W/50 3/8" Belt O.C.		3/9500PB	Hose - Lower - Pipe To Rad.		24240
Belt - Fan; Optional Belt; W/50 3/8" Belt			Hose - Oil Cooler To Heater; W/Beaded End		CT103
O.C.	2310001022	③♣9500HD	Hose - Oil Cooler To Heater; W/Threaded End		CT105
Belt - Hub, Alt. & A.C.; W/135A. Alt.	0124587006	♣K080570HD	Hose - Oil Cooler To Aux. Heater; W/Beaded End		CT104
Belt - Hub, Alt. & A.C.; W/130A. Alt.	0124587000	♣K080580HD	Hose - Oil Cooler To Aux. Heater; W/Threaded End		CT106
Tensioner Assy. - Hub, Alt. & A.C.	0127425000	38501	Hose - W.P. Rear To Heater; W/Beaded End		CT102
Tensioner Pulley - Hub, Alt. & A.C.	0127425000	38075	Hose - W.P. Rear To Heater; W/Threaded End		CT108
Hose - Upper - Eng. To Pipe		21891	Hose - W.P. Front To Aux. Heater; W/Beaded End		CT100
Hose - Upper - Pipe To Rad.		24240	Hose - W.P. Front To Aux. Heater; W/Threaded End		CT107
Hose - Lower - Eng. To Pipe		24240	Hose - W.P. To Reservoir		CT101
Hose - Lower - Pipe To Rad.		24240	Classic		
Hose - Oil Cooler To Heater; W/Beaded End		CT103	Belt - Fan; Preferred Belt		3/9525PB
Hose - Oil Cooler To Heater; W/Threaded End		CT105	Belt - Fan; Optional Belt		③♣9525HD
Hose - Oil Cooler To Aux. Heater; W/Beaded End		CT104	Belt - Hub, Alt. & A.C.; W/130A. Alt.	0124587000	♣K080580HD
Hose - Oil Cooler To Aux. Heater; W/Threaded End		CT106	Belt - Hub, Alt. & A.C.; W/135A. Alt.	0124587006	♣K080570HD
Hose - W.P. Rear To Heater; W/Beaded End		CT102	Tensioner Assy. - Hub, Alt. & A.C.	0127425000	38501
Hose - W.P. Rear To Heater; W/Threaded End		CT108	Tensioner Pulley - Hub, Alt. & A.C.	0127425000	38075
Hose - W.P. Front To Aux. Heater; W/Beaded End		CT100	Hose - Upper - Eng. To Pipe		24240
Hose - W.P. Front To Aux. Heater; W/Threaded End		CT107	Hose - Upper - Pipe To Rad.		24240
Hose - W.P. To Reservoir		CT101	Hose - Lower - Eng. To Pipe		24240
Coronado			Hose - Lower - Pipe To Rad.		24240
Belt - Fan	0124894000	♣K100579HD	Classic XL		
Belt - Hub, Alt. & A.C.	0124587004	♣K080565HD	Belt - Fan; Preferred Belt		3/9525PB
Tensioner Assy. - Fan	0517808000	38503	Belt - Fan; Optional Belt		③♣9525HD
Tensioner Assy. - Hub, Alt. & A.C.	23520317	38501	Belt - Hub, Alt. & A.C.; W/130A. Alt.	0124587000	♣K080580HD
Tensioner Pulley - Fan	0517808000	38076	Belt - Hub, Alt. & A.C.; W/135A. Alt.	0124587006	♣K080570HD
Tensioner Pulley - Hub, Alt. & A.C.	23520317	38075	Tensioner Assy. - Hub, Alt. & A.C.	0127425000	38501
Hose - Upper - Eng. To Pipe		24240	Tensioner Pulley - Hub, Alt. & A.C.	0127425000	38075
Hose - Upper - Pipe To Rad.		24240	Hose - Upper - Eng. To Pipe		24240
Hose - Lower - Pipe To Rad.		24240	Hose - Upper - Pipe To Rad.		24240
FLD			Hose - Lower - Eng. To Pipe		24240
Belt - Fan; Preferred Belt		3/9525PB	Hose - Lower - Pipe To Rad.		24240
Belt - Fan; Optional Belt		③♣9525HD	Hose - Oil Cooler To Heater; W/Beaded End		CT103
Belt - Hub, Alt. & A.C.; W/130A. Alt.	0124587000	♣K080580HD	Hose - Oil Cooler To Heater; W/Threaded End		CT105
Belt - Hub, Alt. & A.C.; W/135A. Alt.	0124587006	♣K080570HD	Hose - Oil Cooler To Aux. Heater; W/Beaded End		CT104
Tensioner Assy. - Hub, Alt. & A.C.	0127425000	38501	Hose - Oil Cooler To Aux. Heater; W/Threaded End		CT106
Tensioner Pulley - Hub, Alt. & A.C.	0127425000	38075	Hose - W.P. Rear To Heater; W/Beaded End		CT102
Hose - Upper - Eng. To Pipe		24240	Hose - W.P. Rear To Heater; W/Threaded End		CT108
Hose - Upper - Pipe To Rad.		24240	Hose - W.P. Front To Aux. Heater; W/Beaded End		CT100
Hose - Lower - Eng. To Pipe		24240	Hose - W.P. Front To Aux. Heater; W/Threaded End		CT107
Hose - Lower - Pipe To Rad.		24240	Hose - W.P. To Reservoir		CT101
Detroit Diesel 6-Cyl. 14.0 L Diesel			Columbia		
Argosy			Belt - Fan; Preferred Belt; W/50 3/8" Belt O.C.		3/9500PB
Belt - Fan	0124894000	♣K100579HD	Belt - Fan; Optional Belt; W/50 3/8" Belt		
Belt - Alt. & A.C.	0124587000	♣K080580HD	O.C.	2310001022	③♣9500HD
Tensioner Assy. - Fan		38503	Belt - Hub, Alt. & A.C.; W/135A. Alt.	0124587006	♣K080570HD
Tensioner Assy. - Alt. & A.C.	23520317	38501	Belt - Hub, Alt. & A.C.; W/130A. Alt.	0124587000	♣K080580HD
Tensioner Pulley - Fan		38076	Tensioner Assy. - Hub, Alt. & A.C.	0127425000	38501

♣Standard Belt Available.
≈Cut to Fit.

③Three Required.

Belts and Coolant Hose for Medium/Heavy-Duty Trucks (2001 & Newer)

Medium & Heavy-Duty Trucks
(2001 & Newer)

Application	Mfr. Part No.	Our No.	Application	Mfr. Part No.	Our No.
Freightliner - Continued			Freightliner - Continued		
2003 - Continued			2003 - Continued		
Detroit Diesel 6-Cyl. 14.0 L Diesel - Continued			Mercedes-Benz MBE 4000 Diesel - Continued		
Columbia - Continued			Columbia; FL112 - Continued		
Tensioner Pulley - Hub, Alt. & A.C.	0127425000	38075	Hose - Upper - Pipe To Rad.		24240
Hose - Upper - Eng. To Pipe		21891	Hose - Lower - Eng. To Pipe		21891
Hose - Upper - Pipe To Rad.		24240	Hose - Lower - Pipe To Rad.		24240
Hose - Lower - Eng. To Pipe		24240			
Hose - Lower - Pipe To Rad.		24240	2002		
Hose - Oil Cooler To Heater; W/Beaded End		CT103	Caterpillar 3126 Diesel		
Hose - Oil Cooler To Heater; W/Threaded End		CT105	Business Class M2		
Hose - Oil Cooler To Aux. Heater; W/Beaded End		CT104	Belt - Fan, Alt. & A.C.; W/145A. Alt.	0123415040	▲K080774HD
Hose - Oil Cooler To Aux. Heater; W/Threaded End		CT106	Belt - Fan, Alt. & A.C.; W/130A. Alt.	0123415058	▲K080780HD
Hose - W.P. Rear To Heater; W/Beaded End		CT102	Tensioner Assy. - Fan, Alt. & A.C.	2201209	38550
Hose - W.P. Rear To Heater; W/Threaded End		CT108	Hose - Upper - Eng. To Rad.		22745
Hose - W.P. Front To Aux. Heater; W/Beaded End		CT100	Hose - Lower - Eng. To Rad.		22744
Hose - W.P. Front To Aux. Heater; W/Threaded End		CT107			
Hose - W.P. To Reservoir		CT101	FL50; FL60; FL70; FL80		
Coronado			Belt - Fan, Alt. & A.C.; W/Delco Alt.	0123415000	▲K080702HD
Belt - Fan	0124894000	▲K100579HD	Belt - Fan, Alt. & A.C.; W/Leece Neville Alt.	0127110003	▲K080708HD
Belt - Hub, Alt. & A.C.	0124587004	▲K080565HD	Belt - W.P.		▲9341HD
Tensioner Assy. - Fan	0517808000	38503	Tensioner Assy. - Fan, Alt. & A.C.	1352151	38511
Tensioner Assy. - Hub, Alt. & A.C.	23520317	38501	Idler Pulley	1445612	36096
Tensioner Pulley - Fan	0517808000	38076	Tensioner Pulley - Fan, Alt. & A.C.	1352151	36091
Tensioner Pulley - Hub, Alt. & A.C.	23520317	38075	Hose - Upper - Eng. To Rad.		22668
Hose - Upper - Eng. To Pipe		24240	Hose - Lower - Eng. To Pipe; W/2 1/4" I.D. Hose		20748
Hose - Upper - Pipe To Rad.		24240	Hose - Lower - Eng. To Pipe; W/2" I.D. Hose		21571
Hose - Lower - Pipe To Rad.		24240	Hose - Lower - Rad. To Pipe; W/2 1/4" I.D. Hose		21194
FLD			Hose - Lower - Rad. To Pipe; W/2" I.D. Hose		≥20611
Belt - Fan; Preferred Belt		3/9525PB	Caterpillar C10 Diesel		
Belt - Fan; Optional Belt		③▲9525HD	Argosy		
Belt - Hub, Alt. & A.C.; W/130A. Alt.	0124587000	▲K080580HD	Belt - Fan & Alt.	0128330003	▲K080855HD
Belt - Hub, Alt. & A.C.; W/135A. Alt.	0124587006	▲K080570HD	Belt - Fan To A.C.	0129729330	▲K060523HD
Tensioner Assy. - Hub, Alt. & A.C.	0127425000	38501	Tensioner Assy. - Fan, Alt. & Hub	1600649	38506
Tensioner Pulley - Hub, Alt. & A.C.	0127425000	38075	Tensioner Assy. - Fan To A.C.	DC0568	38524
Hose - Upper - Eng. To Pipe		24240	Idler Pulley - Fan & Alt.; W/Flat Idler Pulley .	1337023	36091
Hose - Upper - Pipe To Rad.		24240	Idler Pulley - Fan & Alt.; W/Multi-Grooved		
Hose - Lower - Eng. To Pipe		24240	Idler Pulley	1731498	36231
Hose - Lower - Pipe To Rad.		24240	Tensioner Pulley - Fan, Alt. & Hub	1600649	36091
Mercedes-Benz MBE 900 Diesel			Tensioner Pulley - Fan To A.C.	DC0568	36091
Business Class M2			Century Class		
Belt - Fan, Alt. & A.C.	0127110016	▲K080830HD	Belt - Fan & Alt.	0127110018	▲K080780HD
Belt - Fan & Alt.	0127110046	▲K080677HD	Belt - Fan To A.C.		▲K060529HD
Hose - Upper - Eng. To Rad.		≥21378	Tensioner Assy. - Fan & Alt.	1333529	38506
Hose - Lower - Pipe To Rad.		24232	Tensioner Assy. - Fan To A.C.	DC0568	38524
FL50; FL60; FL70; FL80			Idler Pulley - Fan & Alt.; W/Flat Idler Pulley .	1337023	36091
Belt - Fan, Alt. & A.C.	0127110016	▲K080830HD	Idler Pulley - Fan & Alt.; W/Multi-Grooved		
Hose - Upper - Eng. To Rad.		22701	Idler Pulley	1731498	36231
Hose - Lower - Eng. To Pipe		20611	Tensioner Pulley - Fan & Alt.	1333529	36091
Hose - Lower - Pipe To Rad.		22702	Tensioner Pulley - Fan To A.C.	DC0568	36091
MT45			Classic; Classic XL		
Belt - Serpentine; W/82 1/2" Belt O.C.	0129866094	▲K080825HD	Idler Pulley - Fan & Alt.; W/Flat Idler Pulley .	1337023	36091
Belt - Serpentine; W/83" Belt O.C.	0127110045	▲K080830HD	Idler Pulley - Fan & Alt.; W/Multi-Grooved		
Tensioner Assy.	A9062003170	38567	Idler Pulley	1731498	36231
Hose - Upper - Eng. To Rad.		20611	Columbia		
Hose - Lower - Eng. To Pipe		21571	Belt - Fan, Alt. & Hub	0123415056	K080850HD
Hose - Lower - Pipe To Rad.		20206	Belt - Fan To A.C.	0124196013	▲K060523HD
Hose - Intercooler To Engine (Cold Side) ...	0129159000	29003	Tensioner Assy. - Fan, Alt. & Hub	1600649	38506
Hose - Pipe To Left Intercooler (Hot Side)		26201	Tensioner Assy. - Fan To A.C.	DC0568	38524
Mercedes-Benz MBE 4000 Diesel			Idler Pulley - Fan & Alt.; W/Flat Idler Pulley .	1337023	36091
Columbia; FL112			Idler Pulley - Fan & Alt.; W/Multi-Grooved		
Belt - Fan	A0149975992	▲K080672HD	Idler Pulley	1731498	36231
Belt - Hub & Alt.	0127198001	▲K090609HD	Idler Pulley	1731498	36231
Belt - A.C.	0127117004	▲K060439HD	Tensioner Pulley - Fan, Alt. & Hub	1600649	36091
Tensioner Assy. - Fan	A4602000970	38542	Tensioner Pulley - Fan To A.C.	DC0568	36091
Tensioner Assy. - Hub & Alt.	A4602000770	38541	Hose - Upper - Eng. To Pipe		21891
Tensioner Assy. - A.C.	A4602000870	38540	Hose - Upper - Pipe To Rad.		21891
Hose - Upper - Eng. To Pipe		24240	Hose - Lower - Eng. To Pipe		21891
			Hose - Lower - Pipe To Rad.		24240

▲Standard Belt Available.
≥Cut to Fit.

③Three Required.

Belts and Coolant Hose for Medium/Heavy-Duty Trucks (2001 & Newer)

Medium & Heavy-Duty Trucks
(2001 & Newer)

Application	Mfr. Part No.	Our No.	Application	Mfr. Part No.	Our No.
Freightliner - Continued			Freightliner - Continued		
2002 - Continued			2002 - Continued		
Caterpillar C10 Diesel - Continued			Caterpillar C12 Diesel - Continued		
Condor			Columbia		
Belt - Fan & Alt.	0124587007	♣K080878HD	Belt - Fan & A.C.		♣K060525HD
Belt - A.C.		♣K060495HD	Belt - Alt.; W/85 1/2" Belt O.C.		♣K080855HD
Tensioner Assy. - Fan, Alt. & Hub	1600649	38506	Belt - Alt.; W/87.5" Belt O.C.		♣K080876HD
Tensioner Assy. - Fan To A.C.	DCO568	38524	Tensioner Assy. - Alt.	1352142	38506
Idler Pulley - Fan & Alt.; W/Flat Idler Pulley .	1337023	36091	Tensioner Assy. - A.C.		38524
Idler Pulley - Fan & Alt.; W/Multi-Grooved			Idler Pulley - Fan & Alt.; W/Flat Idler Pulley .	1337023	36091
Idler Pulley	1731498	36231	Idler Pulley - Fan & Alt.; W/Multi-Grooved		
Tensioner Pulley - Fan, Alt. & Hub	1600649	36091	Idler Pulley	1731498	36231
Tensioner Pulley - Fan To A.C.	DCO568	36091	Condor		
FL112			Belt - Fan & Alt.	0124587007	♣K080878HD
Belt - Fan, Alt. & Hub	0127110008	♣K080855HD	Belt - A.C.		♣K060495HD
Belt - Fan To A.C.	0126709340	♣K060529HD	Tensioner Assy. - Fan, Alt. & Hub	1600649	38506
Tensioner Assy. - Fan, Alt. & Hub	1481974	38506	Tensioner Assy. - Fan To A.C.	DCO568	38524
Tensioner Assy. - Fan To A.C.	DCO568	38524	Idler Pulley - Fan & Alt.; W/Flat Idler Pulley .	1337023	36091
Idler Pulley - Fan & Alt.; W/Flat Idler Pulley .	1337023	36091	Idler Pulley - Fan & Alt.; W/Multi-Grooved		
Idler Pulley - Fan & Alt.; W/Multi-Grooved			Idler Pulley	1731498	36231
Idler Pulley	1731498	36231	Tensioner Pulley - Fan, Alt. & Hub	1600649	36091
Tensioner Pulley - Fan, Alt. & Hub	1481974	36091	Tensioner Pulley - Fan To A.C.	DCO568	36091
Tensioner Pulley - Fan To A.C.	DCO568	36091	FL112		
Hose - Upper - Eng. To Pipe		21891	Belt - Fan, Alt. & Hub	0127110008	♣K080855HD
Hose - Upper - Pipe To Rad.		24240	Belt - Fan To A.C.	0126709340	♣K060529HD
Hose - Lower - Eng. To Pipe		21891	Tensioner Assy. - Fan, Alt. & Hub	1481974	38506
Hose - Lower - Pipe To Rad.		21891	Tensioner Assy. - Fan To A.C.	DCO568	38524
Hose - Lower - Pipe To Cooler		21891	Idler Pulley - Fan & Alt.; W/Flat Idler Pulley .	1337023	36091
FLD			Idler Pulley - Fan & Alt.; W/Multi-Grooved		
Belt - Fan & Alt.	0127110018	♣K080780HD	Idler Pulley	1731498	36231
Belt - Fan To A.C.; W/V-Belt Drive	2310001022	♣9500HD	Tensioner Pulley - Fan, Alt. & Hub	1481974	36091
Belt - Fan To A.C.; W/V-Ribbed Belt		♣K060529HD	Tensioner Pulley - Fan To A.C.	DCO568	36091
Tensioner Assy. - Fan & Alt.	1333529	38506	Hose - Upper - Eng. To Pipe		21891
Tensioner Assy. - Fan To A.C.	DCO568	38524	Hose - Upper - Pipe To Rad.		24240
Idler Pulley - Fan & Alt.; W/Flat Idler Pulley .	1337023	36091	Hose - Lower - Eng. To Pipe		21891
Idler Pulley - Fan & Alt.; W/Multi-Grooved			Hose - Lower - Pipe To Rad.		21891
Idler Pulley	1731498	36231	FLD		
Tensioner Pulley - Fan & Alt.	1333529	36091	Belt - Fan & Alt.	0127110018	♣K080780HD
Tensioner Pulley - Fan To A.C.	DCO568	36091	Belt - Fan To A.C.; W/V-Belt Drive	2310001022	♣9500HD
Hose - Upper - Eng. To Pipe		21891	Belt - Fan To A.C.; W/V-Ribbed Belt		♣K060529HD
Hose - Upper - Pipe To Rad.		24240	Tensioner Assy. - Fan & Alt.	1333529	38506
Hose - Lower - Eng. To Pipe		21891	Tensioner Assy. - Fan To A.C.	DCO568	38524
Hose - Lower - Pipe To Cooler		24240	Idler Pulley - Fan & Alt.; W/Flat Idler Pulley .	1337023	36091
Hose - Lower - Pipe To Rad.		24240	Idler Pulley - Fan & Alt.; W/Multi-Grooved		
Caterpillar C12 Diesel			Idler Pulley	1731498	36231
Argosy			Tensioner Pulley - Fan & Alt.	1333529	36091
Belt - Fan & Alt.	0128330003	♣K080855HD	Tensioner Pulley - Fan To A.C.	DCO568	36091
Belt - Fan To A.C.	0129729330	♣K060523HD	Hose - Upper - Eng. To Pipe		21891
Tensioner Assy. - Fan, Alt. & Hub	1600649	38506	Hose - Upper - Pipe To Rad.		24240
Tensioner Assy. - Fan To A.C.	DCO568	38524	Hose - Lower - Eng. To Cooler		21891
Idler Pulley - Fan & Alt.; W/Flat Idler Pulley .	1337023	36091	Hose - Lower - Pipe To Cooler		24240
Idler Pulley - Fan & Alt.; W/Multi-Grooved			Hose - Lower - Pipe To Rad.		24240
Idler Pulley	1731498	36231	Caterpillar C15 Diesel		
Tensioner Pulley - Fan, Alt. & Hub	1600649	36091	Argosy		
Tensioner Pulley - Fan To A.C.	DCO568	36091	Belt - Fan & Alt.		♣K080952HD
Century Class			Belt - Fan To A.C.		♣K060547HD
Belt - Fan & Alt.	0127110018	♣K080780HD	Tensioner Assy. - Fan & Alt.	1900649	38506
Belt - Fan To A.C.		♣K060529HD	Tensioner Assy. - Fan To A.C.	1382514	38508
Tensioner Assy. - Fan & Alt.	1333529	38506	Tensioner Pulley - Fan & Alt.	1900649	36091
Tensioner Assy. - Fan To A.C.	DCO568	38524	Tensioner Pulley - Fan To A.C.	1382514	36091
Idler Pulley - Fan & Alt.; W/Flat Idler Pulley .	1337023	36091	Hose - Upper - Eng. To Pipe		24240
Idler Pulley - Fan & Alt.; W/Multi-Grooved			Hose - Upper - Rad. To Pipe		24240
Idler Pulley	1731498	36231	Hose - Lower - Eng. To Pipe		21400
Tensioner Pulley - Fan & Alt.	1333529	36091	Hose - Lower - Rad. To Pipe		≈21891
Tensioner Pulley - Fan To A.C.	DCO568	36091	Century Class		
Classic; Classic XL			Belt - Fan & Alt.	0123415029	♣K080952HD
Idler Pulley - Fan & Alt.; W/Flat Idler Pulley .	1337023	36091	Belt - Fan To A.C.	0126709006	♣K060598HD
Idler Pulley - Fan & Alt.; W/Multi-Grooved			Tensioner Assy. - Fan & Alt.	1352142	38506
Idler Pulley	1731498	36231	Tensioner Assy. - Fan To A.C.	1382514	38508

♣Standard Belt Available.

≈Cut to Fit.

Belts and Coolant Hose for Medium/Heavy-Duty Trucks (2001 & Newer)

Application	Mfr. Part No.	Our No.	Application	Mfr. Part No.	Our No.
Freightliner - Continued			Freightliner - Continued		
2002 - Continued			2002 - Continued		
Caterpillar C15 Diesel - Continued			Caterpillar C16 Diesel - Continued		
Century Class - Continued			Columbia		
Tensioner Pulley - Fan & Alt.	1352142	36091	Belt - Fan & Alt.; W/130A. Alt.	0127110011	▲K080952HD
Tensioner Pulley - Fan To A.C.	1382514	36091	Belt - Fan & Alt.; W/135A. Alt.	0123415053	▲K080939HD
Hose - Upper - Eng. To Pipe		24240	Belt - Fan To A.C.	0126709007	▲K060547HD
Hose - Upper - Pipe To Rad.		24240	Tensioner Assy. - Fan & Alt.	1352142	38506
Hose - Lower - Eng. To Pipe		24248	Tensioner Assy. - Fan To A.C.	1382514	38508
Hose - Lower - Pipe To Rad.		24248	Tensioner Pulley - Fan & Alt.	1352142	36091
Classic; Classic XL			Tensioner Pulley - Fan To A.C.	1382514	36091
Belt - Fan & Alt.	0127110011	▲K080952HD	Hose - Upper - Eng. To Pipe		24240
Belt - Fan To A.C.	0124196005	▲K060598HD	Hose - Upper - Pipe To Rad.		24240
Tensioner Assy. - Fan & Alt.	1352142	38506	Hose - Lower - Eng. To Pipe		24052
Tensioner Assy. - Fan To A.C.	1382514	38508	Hose - Lower - Pipe To Rad.		24240
Tensioner Pulley - Fan & Alt.	1352142	36091	Coronado		
Tensioner Pulley - Fan To A.C.	1382514	36091	Belt - Fan & Alt.; W/130A. Alt.	0127110011	▲K080952HD
Hose - Upper - Eng. To Pipe		24240	Belt - Fan & Alt.; W/135A. Alt.	0123415053	▲K080939HD
Hose - Upper - Pipe To Rad.		24240	Belt - Fan To A.C.	0126709007	▲K060547HD
Hose - Lower - Eng. To Pipe		24248	Tensioner Assy. - Fan & Alt.	1352142	38506
Hose - Lower - Pipe To Rad.		24248	Tensioner Assy. - Fan To A.C.	1382514	38508
Columbia			Tensioner Pulley - Fan & Alt.	1352142	36091
Belt - Fan & Alt.; W/130A. Alt.	0127110011	▲K080952HD	Tensioner Pulley - Fan To A.C.	1382514	36091
Belt - Fan & Alt.; W/135A. Alt.	0123415053	▲K080939HD	Hose - Upper - Eng. To Pipe		24240
Belt - Fan To A.C.	0126709007	▲K060547HD	Hose - Upper - Pipe To Rad.		24240
Tensioner Assy. - Fan & Alt.	1352142	38506	Hose - Lower - Eng. To Pipe		21891
Tensioner Assy. - Fan To A.C.	1382514	38508	Hose - Lower - Pipe To Rad.		24240
Tensioner Pulley - Fan & Alt.	1352142	36091	FLD		
Tensioner Pulley - Fan To A.C.	1382514	36091	Belt - Fan & Alt.	0127110011	▲K080952HD
Hose - Upper - Eng. To Pipe		24240	Belt - Fan To A.C.	0124196005	▲K060598HD
Hose - Upper - Pipe To Rad.		24240	Tensioner Assy. - Fan & Alt.	1352142	38506
Hose - Lower - Eng. To Pipe		24052	Tensioner Assy. - Fan To A.C.	1382514	38508
Hose - Lower - Pipe To Rad.		24240	Tensioner Pulley - Fan & Alt.	1352142	36091
Coronado			Tensioner Pulley - Fan To A.C.	1382514	36091
Belt - Fan & Alt.; W/130A. Alt.	0127110011	▲K080952HD	Hose - Upper - Eng. To Pipe		24240
Belt - Fan & Alt.; W/135A. Alt.	0123415053	▲K080939HD	Hose - Upper - Pipe To Rad.		24240
Belt - Fan To A.C.	0126709007	▲K060547HD	Hose - Lower - Eng. To Pipe		24248
Tensioner Assy. - Fan & Alt.	1352142	38506	Hose - Lower - Pipe To Rad.		24248
Tensioner Assy. - Fan To A.C.	1382514	38508	Cummins 4-Cyl. 3.9 L Diesel		
Tensioner Pulley - Fan & Alt.	1352142	36091	MT35		
Tensioner Pulley - Fan To A.C.	1382514	36091	Belt - Fan & Alt.	3911587	▲K080537HD
Hose - Upper - Eng. To Pipe		21891	Tensioner Assy.	3970822	38504
Hose - Upper - Pipe To Rad.		24240	Hose - Upper - Eng. To Rad.		22795
Hose - Lower - Eng. To Pipe		21891	Hose - Lower - Eng. To Pipe		24236
Hose - Lower - Pipe To Rad.		24240	Hose - Lower - Pipe To Rad.		24232
FLD			Cummins ISB Diesel		
Belt - Fan & Alt.	0127110011	▲K080952HD	FL50; FL60; FL70; FL80		
Belt - Fan To A.C.	0124196005	▲K060598HD	Belt - Fan, Alt. & Hub	3926856	▲K080694HD
Tensioner Assy. - Fan & Alt.	1352142	38506	Belt - Fan & A.C.	2310001081	▲9463HD
Tensioner Assy. - Fan To A.C.	1382514	38508	Tensioner Assy. - Fan, Alt. & Hub	3936213	38516
Tensioner Pulley - Fan & Alt.	1352142	36091	Tensioner Pulley - Fan, Alt. & Hub	3936213	36093
Tensioner Pulley - Fan To A.C.	1382514	36091	Hose - Upper - Eng. To Rad.		22700
Hose - Upper - Eng. To Pipe		24240	Hose - Lower - Eng. To Rad.		22704
Hose - Upper - Pipe To Rad.		24240	MT45; MT55		
Hose - Lower - Eng. To Pipe		24248	Belt - Fan, Alt. & Hub	3943214	▲K080726HD
Hose - Lower - Pipe To Rad.		24248	Belt - Fan To A.C.		▲9430HD
Caterpillar C16 Diesel			Tensioner Assy. - Fan, Alt. & Hub	3936213	38516
Classic; Classic XL			Tensioner Pulley - Fan, Alt. & Hub	3936213	36093
Belt - Fan & Alt.	0127110011	▲K080952HD	Hose - Upper - Eng. To Rad.		22795
Belt - Fan To A.C.	0124196005	▲K060598HD	Hose - Lower - Eng. To Pipe		24236
Tensioner Assy. - Fan & Alt.	1352142	38506	Hose - Lower - Pipe To Rad.		24232
Tensioner Assy. - Fan To A.C.	1382514	38508	Cummins ISC Diesel		
Tensioner Pulley - Fan & Alt.	1352142	36091	Condor		
Tensioner Pulley - Fan To A.C.	1382514	36091	Belt - Alt.	3944838	▲K080755HD
Hose - Upper - Eng. To Pipe		24240	Tensioner Assy. - Alt.	3936213	38516
Hose - Upper - Pipe To Rad.		24240	FL50; FL60; FL70; FL80		
Hose - Lower - Eng. To Pipe		24248	Belt - Fan, Alt. & Hub	3281981	▲K080680HD
Hose - Lower - Pipe To Rad.		24248			

▲Standard Belt Available.

Medium & Heavy-Duty Trucks
(2001 & Newer)

Belts and Coolant Hose for Medium/Heavy-Duty Trucks (2001 & Newer)

**Medium & Heavy-Duty Trucks
(2001 & Newer)**

Application	Mfr. Part No.	Our No.
Freightliner - Continued		
2002 - Continued		
Cummins ISC Diesel - Continued		
FL50; FL60; FL70; FL80 - Continued		
Belt - Fan & A.C.	2310001037	♠9510HD
Tensioner Assy. - Fan, Alt. & Hub	3936213	38516
Tensioner Pulley - Fan, Alt. & Hub	3936213	36093
Hose - Upper - Eng. To Pipe		24236
Hose - Upper - Pipe To Rad.		21571
Hose - Lower - Eng. To Pipe		21194
Hose - Lower - Pipe To Rad.		21194
Cummins ISL Diesel		
Condor		
Belt - Fan	3944839	♠K080765HD
Tensioner Assy.	3936213	38516
Hose - Upper - Rad. To Pipe		≈21299
Hose - Upper - Pipe To Eng.		≈24236
Hose - Lower - Rad. To Cooler		24210
Hose - Lower - Pipe To Eng.		≈24240
Hose - Lower - Cooler To Pipe		21891
XC		
Belt - Alt.	3911567	♠K080670HD
Tensioner Assy. - Alt.	3936213	38516
Cummins ISM Diesel		
Classic; Classic XL		
Belt - Fan, Alt. & Hub	0127110014	♠K080817HD
Belt - Hub & A.C.	0124196015	♠K060559HD
Tensioner Assy. - Fan, Alt. & Hub	3400885	38521
Tensioner Assy. - Hub & A.C.	4004933	38505
Idler Pulley - Fan & Alt.	3400884	36308
Tensioner Pulley - A.C.	4004933	36091
Hose - Upper - Eng. To Pipe		24240
Hose - Upper - Pipe To Rad.		24240
Hose - Lower - Eng. To Cooler		24240
Hose - Lower - Pipe To Cooler		21042
Hose - Lower - Cooler To Pipe		24248
Hose - Lower - Pipe To Rad.		24240
Columbia		
Belt - Fan & Alt.	0127110006	♠K080730HD
Belt - Hub & A.C.	0126709009	♠K060575HD
Tensioner Assy. - Fan & Alt.	3400885	38521
Tensioner Assy. - Hub & A.C.	4004933	38505
Idler Pulley - Fan & Alt.	3400884	36308
Tensioner Pulley - A.C.	4004933	36091
Condor		
Belt - Fan & Alt.		♠K080760HD
Belt - A.C.	0126709009	♠K060575HD
Tensioner Assy. - Fan & Alt.	3400885	38521
Tensioner Assy. - Hub & A.C.	4004933	38505
Tensioner Pulley - A.C.	4004933	36091
FL112		
Belt - Fan & Alt.	0127110006	♠K080730HD
Belt - Hub & A.C.	0126709008	♠K060559HD
Tensioner Assy. - Fan & Alt.	3400885	38521
Tensioner Assy. - Hub & A.C.	4004933	38505
Idler Pulley - Fan & Alt.	3400884	36308
Tensioner Pulley - A.C.	4004933	36091
Hose - Upper - Eng. To Pipe		24240
Hose - Upper - Pipe To Rad.		24240
Hose - Lower - Eng. To Pipe		24240
Hose - Lower - Pipe To Rad.		24240
FLD		
Belt - Fan, Alt. & Hub	0127110014	♠K080817HD
Belt - Hub & A.C.	0124196015	♠K060559HD
Tensioner Assy. - Fan, Alt. & Hub	3400885	38521
Tensioner Assy. - Hub & A.C.	4004933	38505
Idler Pulley - Fan & Alt.	3400884	36308

♠Standard Belt Available.
③Three Required.

Application	Mfr. Part No.	Our No.
Freightliner - Continued		
2002 - Continued		
Cummins ISM Diesel - Continued		
FLD - Continued		
Tensioner Pulley - A.C.	4004933	36091
Hose - Upper - Eng. To Pipe		24240
Hose - Upper - Pipe To Rad.		24240
Hose - Lower - Eng. To Cooler		24240
Hose - Lower - Pipe To Cooler		21042
Hose - Lower - Cooler To Pipe		24248
Hose - Lower - Pipe To Rad.		24240
Cummins ISX Diesel		
Argosy; FLD		
Belt - Fan & W.P.		♠K060685HD
Belt - W.P., Alt. & A.C.		♠K100710HD
Tensioner Assy. - Fan	3681240	38535
Tensioner Assy. - Hub, Alt. & A.C.	3680194	38532
Idler Pulley - Alt. & A.C.	4026886	36226
Tensioner Pulley - Fan	3681240	36092
Tensioner Pulley - Hub, Alt. & A.C.	3680194	36095
Cummins N14 Diesel		
Classic; Classic XL; FLD		
Belt - Hub & W.P.		♠K060425HD
Belt - Alt.	2310001028	♠9451HD
Belt - Hub & A.C.	2310001087	♠9435HD
Belt - Fan	0127191000	2/TR28466PB
Hose - Upper - Eng. To Pipe		24240
Hose - Upper - Pipe To Rad.		24240
Hose - Lower - Eng. To Pipe		24240
Hose - Lower - Pipe To Rad.		24248
Detroit Diesel 6-Cyl. 11.1 L Diesel		
Argosy		
Belt - Fan	0124894000	♠K100579HD
Belt - Alt. & A.C.	0124587000	♠K080580HD
Tensioner Assy. - Fan		38503
Tensioner Assy. - Alt. & A.C.	23520317	38501
Tensioner Pulley - Fan		38076
Tensioner Pulley - Alt. & A.C.		38075
Hose - Upper - Eng. To Pipe		24240
Hose - Upper - Rad. To Pipe		24240
Hose - Lower - Eng. To Cooler		24244
Hose - Lower - Cooler To Pipe		24244
Hose - Lower - Rad. To Pipe		≈21891
Century Class		
Belt - Fan; Preferred Belt; W/50 3/8" Belt O.C.		3/9500PB
Belt - Fan; Optional Belt; W/50 3/8" Belt O.C.	2310001022	③♠9500HD
Belt - Hub, Alt. & A.C.	0124587006	♠K080570HD
Tensioner Assy. - Hub, Alt. & A.C.	23520317	38501
Tensioner Pulley - Hub, Alt. & A.C.	23520317	38075
Hose - Upper - Eng. To Pipe		21891
Hose - Upper - Pipe To Rad.		24240
Hose - Lower - Eng. To Pipe		24240
Hose - Lower - Pipe To Rad.		24240
Classic; Classic XL; FLD		
Belt - Fan; Preferred Belt		3/9525PB
Belt - Fan; Optional Belt		③♠9525HD
Belt - Hub, Alt. & A.C.; W/130A. Alt.	0124587000	♠K080580HD
Belt - Hub, Alt. & A.C.; W/135A. Alt.	0124587005	♠K080575HD
Tensioner Assy. - Hub, Alt. & A.C.	23520317	38501
Tensioner Pulley - Hub, Alt. & A.C.	23520317	38075
Hose - Upper - Eng. To Pipe		24240
Hose - Upper - Pipe To Rad.		24240
Hose - Lower - Eng. To Pipe		24240
Hose - Lower - Pipe To Rad.		24240

≈Cut to Fit.

Belts and Coolant Hose for Medium/Heavy-Duty Trucks (2001 & Newer)

Application	Mfr. Part No.	Our No.
Freightliner - Continued		
2002 - Continued		
Detroit Diesel 6-Cyl. 12.7 L Diesel		
Argosy		
Belt - Fan	0124894000	♣K100579HD
Belt - Alt. & A.C.	0124587000	♣K080580HD
Tensioner Assy. - Fan		38503
Tensioner Assy. - Alt. & A.C.	23520317	38501
Tensioner Pulley - Fan		38076
Tensioner Pulley - Alt. & A.C.		38075
Hose - Upper - Eng. To Pipe		24240
Hose - Upper - Rad. To Pipe		24240
Hose - Lower - Eng. To Cooler		24244
Hose - Lower - Cooler To Pipe		24244
Hose - Lower - Rad. To Pipe		≠21891
Century Class		
Belt - Fan; Preferred Belt; W/50 3/8" Belt O.C.		3/9500PB
Belt - Fan; Optional Belt; W/50 3/8" Belt O.C.	2310001022	③♣9500HD
Belt - Hub, Alt. & A.C.	0124587006	♣K080570HD
Tensioner Assy. - Hub, Alt. & A.C.	23520317	38501
Tensioner Pulley - Hub, Alt. & A.C.	23520317	38075
Hose - Upper - Eng. To Pipe		21891
Hose - Upper - Pipe To Rad.		24240
Hose - Lower - Eng. To Pipe		24240
Hose - Lower - Pipe To Rad.		24240
Hose - Oil Cooler To Heater; W/Beaded End		CT103
Hose - Oil Cooler To Heater; W/Threaded End		CT105
Hose - Oil Cooler To Aux. Heater; W/Beaded End		CT104
Hose - Oil Cooler To Aux. Heater; W/Threaded End		CT106
Hose - W.P. Rear To Heater; W/Beaded End		CT102
Hose - W.P. Rear To Heater; W/Threaded End		CT108
Hose - W.P. Front To Aux. Heater; W/Beaded End		CT100
Hose - W.P. Front To Aux. Heater; W/Threaded End		CT107
Hose - W.P. To Reservoir		CT101
Classic		
Belt - Fan; Preferred Belt		3/9525PB
Belt - Fan; Optional Belt		③♣9525HD
Belt - Hub, Alt. & A.C.; W/130A. Alt.	0124587000	♣K080580HD
Belt - Hub, Alt. & A.C.; W/135A. Alt.	0124587005	♣K080575HD
Tensioner Assy. - Hub, Alt. & A.C.	23520317	38501
Tensioner Pulley - Hub, Alt. & A.C.	23520317	38075
Hose - Upper - Eng. To Pipe		24240
Hose - Upper - Pipe To Rad.		24240
Hose - Lower - Eng. To Pipe		24240
Hose - Lower - Pipe To Rad.		24240
Classic XL		
Belt - Fan; Preferred Belt		3/9525PB
Belt - Fan; Optional Belt		③♣9525HD
Belt - Hub, Alt. & A.C.; W/130A. Alt.	0124587000	♣K080580HD
Belt - Hub, Alt. & A.C.; W/135A. Alt.	0124587005	♣K080575HD
Tensioner Assy. - Hub, Alt. & A.C.	23520317	38501
Tensioner Pulley - Hub, Alt. & A.C.	23520317	38075
Hose - Upper - Eng. To Pipe		24240
Hose - Upper - Pipe To Rad.		24240
Hose - Lower - Eng. To Pipe		24240
Hose - Lower - Pipe To Rad.		24240
Hose - Oil Cooler To Heater; W/Beaded End		CT103
Hose - Oil Cooler To Heater; W/Threaded End		CT105
Hose - Oil Cooler To Aux. Heater; W/Beaded End		CT104
Hose - Oil Cooler To Aux. Heater; W/Threaded End		CT106
Hose - W.P. Rear To Heater; W/Beaded End		CT102
Hose - W.P. Rear To Heater; W/Threaded End		CT108
Hose - W.P. Front To Aux. Heater; W/Beaded End		CT100
Hose - W.P. Front To Aux. Heater; W/Threaded End		CT107
Hose - W.P. To Reservoir		CT101
Columbia		
Belt - Fan; Preferred Belt; W/50 3/8" Belt O.C.		3/9500PB

♣Standard Belt Available.
③Three Required.

Application	Mfr. Part No.	Our No.
Freightliner - Continued		
2002 - Continued		
Detroit Diesel 6-Cyl. 12.7 L Diesel - Continued		
Columbia - Continued		
Belt - Fan; Optional Belt; W/50 3/8" Belt O.C.	2310001022	③♣9500HD
Belt - Hub, Alt. & A.C.; W/135A. Alt.	0124587006	♣K080570HD
Belt - Hub, Alt. & A.C.; W/130A. Alt.	0124587000	♣K080580HD
Tensioner Assy. - Hub, Alt. & A.C.	23520317	38501
Tensioner Pulley - Hub, Alt. & A.C.	23520317	38075
Hose - Upper - Eng. To Pipe		21891
Hose - Upper - Pipe To Rad.		24240
Hose - Lower - Eng. To Pipe		24240
Hose - Lower - Pipe To Rad.		24240
Hose - Oil Cooler To Heater; W/Beaded End		CT103
Hose - Oil Cooler To Heater; W/Threaded End		CT105
Hose - Oil Cooler To Aux. Heater; W/Beaded End		CT104
Hose - Oil Cooler To Aux. Heater; W/Threaded End		CT106
Hose - W.P. Rear To Heater; W/Beaded End		CT102
Hose - W.P. Rear To Heater; W/Threaded End		CT108
Hose - W.P. Front To Aux. Heater; W/Beaded End		CT100
Hose - W.P. Front To Aux. Heater; W/Threaded End		CT107
Hose - W.P. To Reservoir		CT101
Coronado		
Belt - Fan	0124894000	♣K100579HD
Belt - Hub, Alt. & A.C.	0124587004	♣K080565HD
Tensioner Assy. - Fan	0517808000	38503
Tensioner Assy. - Hub, Alt. & A.C.	23520317	38501
Tensioner Pulley - Fan	0517808000	38076
Tensioner Pulley - Hub, Alt. & A.C.	23520317	38075
Hose - Upper - Eng. To Pipe		24240
Hose - Upper - Pipe To Rad.		24240
Hose - Lower - Pipe To Rad.		24240
FLD		
Belt - Fan; Preferred Belt		3/9525PB
Belt - Fan; Optional Belt		③♣9525HD
Belt - Hub, Alt. & A.C.; W/130A. Alt.	0124587000	♣K080580HD
Belt - Hub, Alt. & A.C.; W/135A. Alt.	0124587005	♣K080575HD
Tensioner Assy. - Hub, Alt. & A.C.	23520317	38501
Tensioner Pulley - Hub, Alt. & A.C.	23520317	38075
Hose - Upper - Eng. To Pipe		24240
Hose - Upper - Pipe To Rad.		24240
Hose - Lower - Eng. To Pipe		24240
Hose - Lower - Pipe To Rad.		24240
Detroit Diesel 6-Cyl. 14.0 L Diesel		
Classic XL		
Belt - Fan; Preferred Belt		3/9525PB
Belt - Fan; Optional Belt		③♣9525HD
Belt - Hub, Alt. & A.C.; W/130A. Alt.	0124587000	♣K080580HD
Belt - Hub, Alt. & A.C.; W/135A. Alt.	0124587006	♣K080570HD
Tensioner Assy. - Hub, Alt. & A.C.	0127425000	38501
Tensioner Pulley - Hub, Alt. & A.C.	0127425000	38075
Hose - Upper - Eng. To Pipe		24240
Hose - Upper - Pipe To Rad.		24240
Hose - Lower - Eng. To Pipe		24240
Hose - Lower - Pipe To Rad.		24240
Hose - Oil Cooler To Heater; W/Beaded End		CT103
Hose - Oil Cooler To Heater; W/Threaded End		CT105
Hose - Oil Cooler To Aux. Heater; W/Beaded End		CT104
Hose - Oil Cooler To Aux. Heater; W/Threaded End		CT106
Hose - W.P. Rear To Heater; W/Beaded End		CT102
Hose - W.P. Rear To Heater; W/Threaded End		CT108
Hose - W.P. Front To Aux. Heater; W/Beaded End		CT100
Hose - W.P. Front To Aux. Heater; W/Threaded End		CT107
Hose - W.P. To Reservoir		CT101
Columbia		
Belt - Fan; Preferred Belt; W/50 3/8" Belt O.C.		3/9500PB
Belt - Fan; Optional Belt; W/50 3/8" Belt O.C.	2310001022	③♣9500HD

≠Cut to Fit.

Medium & Heavy-Duty Trucks (2001 & Newer)

Belts and Coolant Hose for Medium/Heavy-Duty Trucks (2001 & Newer)

Medium & Heavy-Duty Trucks
(2001 & Newer)

Application	Mfr. Part No.	Our No.	Application	Mfr. Part No.	Our No.
Freightliner - Continued			Freightliner - Continued		
2002 - Continued			2001 - Continued		
Detroit Diesel 6-Cyl. 14.0 L Diesel - Continued			Caterpillar 3126 Diesel - Continued		
Columbia - Continued			FL50; FL60; FL70 - Continued		
Belt - Hub, Alt. & A.C.; W/135A. Alt.	0124587006	♣K080570HD	Belt - W.P.		♣9341HD
Belt - Hub, Alt. & A.C.; W/130A. Alt.	0124587000	♣K080580HD	Tensioner Assy. - Fan, Alt. & A.C.	1352151	38511
Tensioner Assy. - Hub, Alt. & A.C.	23520317	38501	Idler Pulley	1445612	36096
Tensioner Pulley - Hub, Alt. & A.C.	23520317	38075	Tensioner Pulley - Fan, Alt. & A.C.	1352151	36091
Hose - Upper - Eng. To Pipe		21891	Hose - Upper - Eng. To Rad.		22668
Hose - Upper - Pipe To Rad.		24240	Hose - Lower - Eng. To Pipe; W/2 1/4" I.D. Hose		20748
Hose - Lower - Eng. To Pipe		24240	Hose - Lower - Eng. To Pipe; W/2" I.D. Hose		21571
Hose - Lower - Pipe To Rad.		24240	Hose - Lower - Rad. To Pipe; W/2 1/4" I.D. Hose		21194
Hose - Oil Cooler To Heater; W/Beaded End		CT103	Hose - Lower - Rad. To Pipe; W/2" I.D. Hose		≡20611
Hose - Oil Cooler To Heater; W/Threaded End		CT105	FL80		
Hose - Oil Cooler To Aux. Heater; W/Beaded End		CT104	Belt - Fan, Alt. & A.C.; W/Delco Alt.	0123415000	♣K080702HD
Hose - Oil Cooler To Aux. Heater; W/Threaded End		CT106	Belt - Fan, Alt. & A.C.; W/Leece Neville Alt. .	0127110003	♣K080708HD
Hose - W.P. Rear To Heater; W/Beaded End		CT102	Belt - W.P.	0366775	♣9341HD
Hose - W.P. Rear To Heater; W/Threaded End		CT108	Tensioner Assy. - Fan, Alt. & A.C.	1352151	38511
Hose - W.P. Front To Aux. Heater; W/Beaded End		CT100	Idler Pulley	1445612	36096
Hose - W.P. Front To Aux. Heater; W/Threaded End		CT107	Tensioner Pulley - Fan, Alt. & A.C.	1352151	36091
Hose - W.P. To Reservoir		CT101	Hose - Upper - Eng. To Rad.		22668
FLD			Hose - Lower - Eng. To Pipe; W/2 1/4" I.D. Hose		20748
Belt - Fan; Preferred Belt		3/9525PB	Hose - Lower - Eng. To Pipe; W/2" I.D. Hose		21571
Belt - Fan; Optional Belt		♣9525HD	Hose - Lower - Rad. To Pipe; W/2 1/4" I.D. Hose		21194
Belt - Hub, Alt. & A.C.; W/130A. Alt.	0124587000	♣K080580HD	Hose - Lower - Rad. To Pipe; W/2" I.D. Hose		≡20611
Belt - Hub, Alt. & A.C.; W/135A. Alt.	0124587005	♣K080575HD	Caterpillar C10 Diesel		
Tensioner Assy. - Hub, Alt. & A.C.	23520317	38501	Argosy		
Tensioner Pulley - Hub, Alt. & A.C.	23520317	38075	Belt - Fan & Alt.	0128330003	♣K080855HD
Hose - Upper - Eng. To Pipe		24240	Belt - Fan To A.C.	0129729330	♣K060523HD
Hose - Upper - Pipe To Rad.		24240	Tensioner Assy. - Fan, Alt. & Hub	1600649	38506
Hose - Lower - Eng. To Pipe		24240	Tensioner Assy. - Fan To A.C.	DCO568	38524
Hose - Lower - Pipe To Rad.		24240	Idler Pulley - Fan & Alt.; W/Flat Idler Pulley .	1337023	36091
Mercedes-Benz MBE 900 Diesel			Idler Pulley - Fan & Alt.; W/Multi-Grooved		
Business Class M2			Idler Pulley	1731498	36231
Belt - Fan, Alt. & A.C.	0127110016	♣K080830HD	Tensioner Pulley - Fan, Alt. & Hub	1600649	36091
Belt - Fan & Alt.	0127110046	♣K080677HD	Tensioner Pulley - Fan To A.C.	DCO568	36091
Hose - Upper - Eng. To Rad.		≡21378	Century Class		
Hose - Lower - Pipe To Rad.		24232	Belt - Fan & Alt.	0123415014	♣K080855HD
FL50			Belt - Fan To A.C.		♣K060523HD
Belt - Fan, Alt. & A.C.	0127110016	♣K080830HD	Tensioner Assy. - Fan & Alt.	1333529	38506
Hose - Upper - Eng. To Rad.		22743	Tensioner Assy. - Fan To A.C.	DCO568	38524
Hose - Lower - Eng. To Pipe		20611	Idler Pulley - Fan & Alt.; W/Flat Idler Pulley .	1337023	36091
Hose - Lower - Pipe To Rad.		22702	Idler Pulley - Fan & Alt.; W/Multi-Grooved		
FL60; FL70; FL80			Idler Pulley	1731498	36231
Belt - Fan, Alt. & A.C.	0127110016	♣K080830HD	Tensioner Pulley - Fan & Alt.	1333529	36091
Hose - Upper - Eng. To Rad.		22743	Tensioner Pulley - Fan To A.C.	DCO568	36091
Hose - Lower - Eng. To Pipe		20611	Classic; Classic XL		
Hose - Lower - Pipe To Rad.		22702	Idler Pulley - Fan & Alt.; W/Flat Idler Pulley .	1337023	36091
MT45			Idler Pulley - Fan & Alt.; W/Multi-Grooved		
Belt - Serpentine; W/59 1/2" Belt O.C.	0127110015	♣K080594HD	Idler Pulley	1731498	36231
Belt - Serpentine; W/83" Belt O.C.	0127110045	♣K080830HD	Idler Pulley	1731498	36231
Hose - Upper - Eng. To Rad.		20611	Tensioner Pulley - Fan, Alt. & Hub	1600649	36091
Hose - Lower - Eng. To Rad.		21571	Tensioner Pulley - Fan To A.C.	DCO568	36091
Hose - Intercooler To Engine (Cold Side) ...	0129159000	29003	Hose - Upper - Eng. To Pipe		21891
Hose - Turbo To Pipe (Hot Side)		26201	Hose - Upper - Pipe To Rad.		21891
Hose - Pipe To Intercooler (Hot Side)		26201	Hose - Lower - Eng. To Pipe		21891
Mercedes-Benz MBE 4000 Diesel			Hose - Lower - Pipe To Rad.		24240
FL112			Condor		
Belt - Alt.	0127198001	♣K090609HD	Belt - Fan & Alt.	0124587007	♣K080878HD
Belt - A.C.	0127177004	♣K060439HD	Belt - A.C.		♣K060495HD
Belt - Fan		♣K080672HD	Tensioner Assy. - Fan, Alt. & Hub	1600649	38506
2001					
Caterpillar 3126 Diesel					
FL50; FL60; FL70					
Belt - Fan, Alt. & A.C.; W/Delco Alt.	0123415000	♣K080702HD			
Belt - Fan, Alt. & A.C.; W/Leece Neville Alt. .	0127110003	♣K080708HD			

♣Standard Belt Available.
≡Cut to Fit.

③Three Required.

Belts and Coolant Hose for Medium/Heavy-Duty Trucks (2001 & Newer)

Application	Mfr. Part No.	Our No.	Application	Mfr. Part No.	Our No.
Freightliner - Continued			Freightliner - Continued		
2001 - Continued			2001 - Continued		
Caterpillar C10 Diesel - Continued			Caterpillar C12 Diesel - Continued		
Condor - Continued			Condor - Continued		
Tensioner Assy. - Fan To A.C.	DC0568	38524	Tensioner Assy. - Fan, Alt. & Hub	1600649	38506
Idler Pulley - Fan & Alt.; W/Flat Idler Pulley	1337023	36091	Tensioner Assy. - Fan To A.C.	DCO568	38524
Idler Pulley - Fan & Alt.; W/Multi-Grooved			Idler Pulley - Fan & Alt.; W/Flat Idler Pulley	1337023	36091
Idler Pulley	1731498	36231	Idler Pulley - Fan & Alt.; W/Multi-Grooved		
Tensioner Pulley - Fan, Alt. & Hub	1600649	36091	Idler Pulley	1731498	36231
Tensioner Pulley - Fan To A.C.	DCO568	36091	Tensioner Pulley - Fan, Alt. & Hub	1600649	36091
FL112			Tensioner Pulley - Fan To A.C.	DCO568	36091
Belt - Fan, Alt. & Hub	0123415014	♣K080855HD	FL112		
Belt - Fan & A.C.	0126709000	♣K060529HD	Belt - Fan, Alt. & Hub	0123415014	♣K080855HD
Tensioner Assy. - Fan, Alt. & Hub	1481974	38506	Belt - Fan & A.C.	0126709000	♣K060529HD
Tensioner Assy. - Fan To A.C.	DC0568	38524	Tensioner Assy. - Fan, Alt. & Hub	1481974	38506
Idler Pulley - Fan & Alt.; W/Flat Idler Pulley	1337023	36091	Tensioner Assy. - Fan To A.C.	DCO568	38524
Idler Pulley - Fan & Alt.; W/Multi-Grooved			Idler Pulley - Fan & Alt.; W/Flat Idler Pulley	1337023	36091
Idler Pulley	1731498	36231	Idler Pulley - Fan & Alt.; W/Multi-Grooved		
Tensioner Pulley - Fan, Alt. & Hub	1481974	36091	Idler Pulley	1731498	36231
Tensioner Pulley - Fan To A.C.	DCO568	36091	Tensioner Pulley - Fan, Alt. & Hub	1481974	36091
Hose - Upper - Eng. To Pipe		≈21891	Tensioner Pulley - Fan To A.C.	DCO568	36091
Hose - Upper - Pipe To Rad.		24240	Hose - Upper - Eng. To Pipe		≈21891
Hose - Lower - Eng. To Pipe		≈21891	Hose - Upper - Pipe To Rad.		24240
Hose - Lower - Pipe To Rad.		≈21891	Hose - Lower - Eng. To Pipe		21891
FLD			Hose - Lower - Pipe To Rad.		21891
Belt - Fan & Alt.; W/78 1/2" Belt O.C.	0123415009	♣K080780HD	FLD		
Belt - Fan & Alt.; W/90" Belt O.C.	0123415014	♣K080855HD	Belt - Fan & Alt.; W/78 1/2" Belt O.C.	0123415009	♣K080780HD
Belt - Fan To A.C.; W/V-Belt Drive	2310001022	♣9500HD	Belt - Fan & Alt.; W/86" Belt O.C.	0123415014	♣K080855HD
Belt - Fan To A.C.; W/W-Ribbed Belt		♣K060523HD	Belt - Fan To A.C.; W/V-Belt Drive	2310001022	♣9500HD
Tensioner Assy. - Fan & Alt.	1333529	38506	Belt - Fan To A.C.; W/W-Ribbed Belt		♣K060523HD
Tensioner Assy. - Fan To A.C.	DCO568	38524	Tensioner Assy. - Fan & Alt.	1333529	38506
Idler Pulley - Fan & Alt.; W/Flat Idler Pulley	1337023	36091	Tensioner Assy. - Fan To A.C.	DCO568	38524
Idler Pulley - Fan & Alt.; W/Multi-Grooved			Idler Pulley - Fan & Alt.; W/Flat Idler Pulley	1337023	36091
Idler Pulley	1731498	36231	Idler Pulley - Fan & Alt.; W/Multi-Grooved		
Tensioner Pulley - Fan & Alt.	1333529	36091	Idler Pulley	1731498	36231
Tensioner Pulley - Fan To A.C.	DCO568	36091	Tensioner Pulley - Fan & Alt.	1333529	36091
Hose - Upper - Eng. To Pipe		21891	Tensioner Pulley - Fan To A.C.	DCO568	36091
Hose - Upper - Pipe To Rad.		24240	Hose - Upper - Eng. To Pipe		21891
Hose - Lower - Pipe To Rad.		24240	Hose - Upper - Pipe To Rad.		24240
Hose - Lower - Eng. To Cooler		21891	Hose - Lower - Pipe To Rad.		24240
Hose - Lower - Pipe To Cooler		24240	Hose - Lower - Eng. To Cooler		21891
			Hose - Lower - Pipe To Cooler		24240
Caterpillar C12 Diesel			Caterpillar C15 Diesel		
Argosy			Argosy		
Belt - Fan & Alt.	0128330003	♣K080855HD	Belt - Fan & Alt.		♣K080952HD
Belt - Fan To A.C.	0129729330	♣K060523HD	Belt - Fan To A.C.		♣K060547HD
Tensioner Assy. - Fan, Alt. & Hub	1600649	38506	Tensioner Assy. - Fan & Alt.	1900649	38506
Tensioner Assy. - Fan To A.C.	DC0568	38524	Tensioner Assy. - Fan To A.C.	1382514	38508
Idler Pulley - Fan & Alt.; W/Flat Idler Pulley	1337023	36091	Tensioner Pulley - Fan & Alt.	1900649	36091
Idler Pulley - Fan & Alt.; W/Multi-Grooved			Tensioner Pulley - Fan To A.C.	1382514	36091
Idler Pulley	1731498	36231	Hose - Upper - Eng. To Pipe		24240
Tensioner Pulley - Fan, Alt. & Hub	1600649	36091	Hose - Upper - Rad. To Pipe		24240
Tensioner Pulley - Fan To A.C.	DCO568	36091	Hose - Lower - Eng. To Pipe		21400
Century Class			Hose - Lower - Rad. To Pipe		≈21891
Belt - Fan & Alt.	0123415014	♣K080855HD	Century Class		
Belt - Fan To A.C.		♣K060523HD	Belt - Fan & Alt.	0123415029	♣K080952HD
Tensioner Assy. - Fan & Alt.	1333529	38506	Belt - Fan To A.C.	0126709006	♣K060598HD
Tensioner Assy. - Fan To A.C.	DCO568	38524	Tensioner Assy. - Fan & Alt.	1352142	38506
Idler Pulley - Fan & Alt.; W/Flat Idler Pulley	1337023	36091	Tensioner Assy. - Fan To A.C.	1382514	38508
Idler Pulley - Fan & Alt.; W/Multi-Grooved			Tensioner Pulley - Fan & Alt.	1352142	36091
Idler Pulley	1731498	36231	Tensioner Pulley - Fan To A.C.	1382514	36091
Tensioner Pulley - Fan & Alt.	1333529	36091	Hose - Upper - Eng. To Pipe		24240
Tensioner Pulley - Fan To A.C.	DCO568	36091	Hose - Upper - Pipe To Rad.		24240
Classic; Classic XL; Columbia			Hose - Lower - Eng. To Pipe		24248
Idler Pulley - Fan & Alt.; W/Flat Idler Pulley	1337023	36091	Hose - Lower - Pipe To Rad.		24248
Idler Pulley - Fan & Alt.; W/Multi-Grooved			Classic; Classic XL		
Idler Pulley	1731498	36231	Belt - Fan & Alt.	0123415029	♣K080952HD
Condor			Belt - Fan To A.C.	0124196005	♣K060598HD
Belt - Fan & Alt.	0124587007	♣K080878HD	Tensioner Assy. - Fan & Alt.	1352142	38506
Belt - A.C.		♣K060495HD			

♣Standard Belt Available.

≈Cut to Fit.

Medium & Heavy-Duty Trucks
(2001 & Newer)

Belts and Coolant Hose for Medium/Heavy-Duty Trucks (2001 & Newer)

Medium & Heavy-Duty Trucks
(2001 & Newer)

Application	Mfr. Part No.	Our No.	Application	Mfr. Part No.	Our No.
Freightliner - Continued			Freightliner - Continued		
2001 - Continued			2001 - Continued		
Caterpillar C15 Diesel - Continued			Cummins 4-Cyl. 3.9 L Diesel		
Classic; Classic XL - Continued			MT35		
Tensioner Assy. - Fan To A.C.	1382514	38508	Belt - Fan & Alt.	3911587	♣K080537HD
Tensioner Pulley - Fan & Alt.	1352142	36091	Tensioner Assy.	3970822	38504
Tensioner Pulley - Fan To A.C.	1382514	36091	Hose - Upper		22795
Hose - Upper - Eng. To Pipe		24240	Hose - Lower - Eng. To Pipe		24236
Hose - Upper - Pipe To Rad.		24240	Hose - Lower - Pipe To Rad.		24232
Hose - Lower - Eng. To Pipe		24248	Cummins ISB CNG		
Hose - Lower - Pipe To Rad.		24248	MT45; MT55		
Columbia			Belt - Fan, Alt. & Hub		
Belt - Fan & Alt.	0123415029	♣K080952HD	Tensioner Assy. - Fan, Alt. & Hub	3937553	♣K080575HD
Belt - Fan To A.C.	0124196014	♣K060547HD	Tensioner Pulley - Fan, Alt. & Hub	3937553	38504
Tensioner Assy. - Fan & Alt.	1352142	38506	Hose - Upper - Eng. To Pipe		24232
Tensioner Assy. - Fan To A.C.	1382514	38508	Hose - Upper - Pipe To Rad.		20206
Tensioner Pulley - Fan & Alt.	1352142	36091	Hose - Lower - Eng. To Pipe		24240
Tensioner Pulley - Fan To A.C.	1382514	36091	Hose - Lower - Pipe To Rad.		24240
Hose - Upper - Eng. To Pipe		24240	Cummins ISB Diesel		
Hose - Upper - Pipe To Rad.		24240	FL50; FL60; FL70; FL80		
Hose - Lower - Eng. To Pipe		24052	Belt - Fan & Alt.		
Hose - Lower - Pipe To Rad.		24240	Belt - Fan & A.C.		
FLD			Tensioner Assy. - Fan & Alt.		
Belt - Fan & Alt.	0123415029	♣K080952HD	Tensioner Pulley - Fan & Alt.	3936213	♣K080694HD
Belt - Fan To A.C.	0124196005	♣K060598HD	Hose - Upper - Eng. To Rad.		38516
Tensioner Assy. - Fan & Alt.	1352142	38506	Hose - Lower - Eng. To Rad.		36093
Tensioner Assy. - Fan To A.C.	1382514	38508			22669
Tensioner Pulley - Fan & Alt.	1352142	36091			22670
Tensioner Pulley - Fan To A.C.	1382514	36091	MT45; MT55		
Hose - Upper - Eng. To Pipe		24240	Belt - Fan & Alt.		
Hose - Upper - Pipe To Rad.		24240	Belt - Fan To A.C.		
Hose - Lower - Eng. To Pipe		24248	Tensioner Assy. - Fan & Alt.		
Hose - Lower - Pipe To Rad.		24248	Tensioner Pulley - Fan & Alt.		
Caterpillar C16 Diesel			Hose - Upper		
Classic; Classic XL			Hose - Lower - Eng. To Pipe		
Belt - Fan & Alt.	0123415029	♣K080952HD	Hose - Lower - Pipe To Rad.		
Belt - Fan To A.C.	0124196005	♣K060598HD	Cummins ISC Diesel		
Tensioner Assy. - Fan & Alt.	1352142	38506	Condor		
Tensioner Assy. - Fan To A.C.	1382514	38508	Belt - Alt.		
Tensioner Pulley - Fan & Alt.	1352142	36091	Tensioner Assy. - Alt.		
Tensioner Pulley - Fan To A.C.	1382514	36091	FL50; FL60; FL70; FL80		
Hose - Upper - Eng. To Pipe		24240	Belt - Fan, Alt. & Hub		
Hose - Upper - Pipe To Rad.		24240	Belt - Fan & A.C.		
Hose - Lower - Eng. To Pipe		24248	Tensioner Assy. - Fan, Alt. & Hub		
Hose - Lower - Pipe To Rad.		24248	Hose - Upper - Eng. To Pipe		
Columbia			Hose - Upper - Pipe To Rad.		
Belt - Fan & Alt.	0123415029	♣K080952HD	Hose - Lower - Eng. To Pipe		
Belt - Fan To A.C.	0124196014	♣K060547HD	Hose - Lower - Pipe To Rad.		
Tensioner Assy. - Fan & Alt.	1352142	38506	Cummins ISM Diesel		
Tensioner Assy. - Fan To A.C.	1382514	38508	Century Class		
Tensioner Pulley - Fan & Alt.	1352142	36091	Belt - Fan & Alt.		
Tensioner Pulley - Fan To A.C.	1382514	36091	Belt - Hub & A.C.		
Hose - Upper - Eng. To Pipe		24240	Tensioner Assy. - Fan & Alt.		
Hose - Upper - Pipe To Rad.		24240	Tensioner Assy. - Hub & A.C.		
Hose - Lower - Eng. To Pipe		24052	Idler Pulley - Fan & Alt.		
Hose - Lower - Pipe To Rad.		24240	Tensioner Pulley - A.C.		
FLD			Hose - Upper - Eng. To Pipe		
Belt - Fan & Alt.	0123415029	♣K080952HD	Hose - Upper - Pipe To Rad.		
Belt - Fan To A.C.	0124196005	♣K060598HD	Hose - Lower - Eng. To Pipe		
Tensioner Assy. - Fan & Alt.	1352142	38506	Hose - Lower - Pipe To Rad.		
Tensioner Assy. - Fan To A.C.	1382514	38508	Classic		
Tensioner Pulley - Fan & Alt.	1352142	36091	Belt - Fan, Alt. & Hub		
Tensioner Pulley - Fan To A.C.	1382514	36091	Belt - Fan & Alt.		
Hose - Upper - Eng. To Pipe		24240	Belt - Hub & A.C.		
Hose - Upper - Pipe To Rad.		24240	Tensioner Assy. - Fan, Alt. & Hub		
Hose - Lower - Eng. To Pipe		24248	Tensioner Assy. - Hub & A.C.		
Hose - Lower - Pipe To Rad.		24248	Idler Pulley - Fan & Alt.		
			Tensioner Pulley - A.C.		

♣Standard Belt Available.

ⓂTwo Required.

Belts and Coolant Hose for Medium/Heavy-Duty Trucks (2001 & Newer)

Application	Mfr. Part No.	Our No.	Application	Mfr. Part No.	Our No.
Freightliner - Continued			Freightliner - Continued		
2001 - Continued			2001 - Continued		
Cummins ISM Diesel - Continued			Cummins ISX Diesel - Continued		
Classic - Continued			Argosy - Continued		
Hose - Upper - Eng. To Pipe		24240	Tensioner Pulley - Hub, Alt. & A.C.	3680194	36095
Hose - Upper - Pipe To Rad.		24240	Century Class		
Hose - Lower - Pipe To Rad.		24240	Belt - Fan & Hub	3681811	♣K100710HD
Hose - Lower - Eng. To Cooler		24240	Belt - Hub, Alt. & A.C.	0124196010	♣K060685HD
Hose - Lower - Cooler To Pipe		24248	Tensioner Assy. - Fan & Hub	3681240	38535
Classic XL			Tensioner Assy. - Hub, Alt. & A.C.	3680194	38532
Belt - Fan & Alt.	0123415028	♣K080816HD	Idler Pulley - Alt. & A.C.	4026886	36226
Belt - Hub & A.C.	0124196015	♣K060559HD	Tensioner Pulley - Fan & Hub	3681240	36092
Tensioner Assy. - Fan & Alt.	3400885	38521	Tensioner Pulley - Hub, Alt. & A.C.	3680194	36095
Tensioner Assy. - Hub & A.C.	4004933	38505	Hose - Upper - Eng. To Pipe		24240
Idler Pulley - Fan & Alt.	3400884	36308	Hose - Upper - Pipe To Rad.		24240
Tensioner Pulley - A.C.	4004933	36091	Hose - Lower - Eng. To Pipe		24240
Hose - Upper - Eng. To Pipe		24240	Hose - Lower - Pipe To Rad.		21891
Hose - Upper - Pipe To Rad.		24240	Classic XL		
Hose - Lower - Pipe To Rad.		24240	Belt - Fan	3681811	♣K100710HD
Hose - Lower - Eng. To Cooler		24240	Belt - Hub, Alt. & A.C.	0124196010	♣K060685HD
Hose - Lower - Pipe To Cooler		24240	Tensioner Assy. - Fan	3681240	38532
Columbia			Tensioner Assy. - Hub, Alt. & A.C.	3680194	38535
Belt - Fan & Alt.	0123415045	♣K080740HD	Idler Pulley - Alt. & A.C.	4026886	36226
Belt - Hub & A.C.		♣K060559HD	Tensioner Pulley - A.C.	4004933	36091
Tensioner Assy. - Fan & Alt.	3400885	38521	Tensioner Pulley - Fan	3681240	36092
Tensioner Assy. - Hub & A.C.	4004933	38505	Tensioner Pulley - Hub, Alt. & A.C.	3680194	36095
Idler Pulley - Fan & Alt.	3400884	36308	Hose - Upper - Eng. To Pipe		24240
Tensioner Pulley - A.C.	4004933	36091	Hose - Upper - Pipe To Rad.		24240
Hose - Upper - Eng. To Pipe		24236	Hose - Lower - Eng. To Pipe		21891
Hose - Upper - Pipe To Rad.		24240	Hose - Lower - Pipe To Rad.		♣24240
Hose - Lower - Eng. To Pipe		24240	Columbia		
Hose - Lower - Pipe To Rad.		24240	Belt - Fan & Hub	3681811	♣K100710HD
Condor			Belt - Hub, Alt. & A.C.	0124196010	♣K060685HD
Belt - Fan & Alt.		♣K080760HD	Tensioner Assy. - Fan & Hub	3681240	38535
Belt - A.C.	0126709009	♣K060575HD	Tensioner Assy. - Hub, Alt. & A.C.	3680194	38532
Tensioner Assy. - Fan & Alt.	3400885	38521	Idler Pulley - Alt. & A.C.	4026886	36226
Tensioner Assy. - Hub & A.C.	4004933	38505	Tensioner Pulley - Fan & Hub	3681240	36092
Tensioner Pulley - A.C.	4004933	36091	Tensioner Pulley - Hub, Alt. & A.C.	3680194	36095
FL112			Hose - Upper - Eng. To Pipe		24240
Belt - Fan & Alt.	0123415026	♣K080730HD	Hose - Upper - Pipe To Rad.		24240
Belt - Hub & A.C.	0124196015	♣K060559HD	Hose - Lower - Eng. To Pipe		24240
Tensioner Assy. - Fan & Alt.	3400885	38521	Hose - Lower - Pipe To Rad.		21891
Tensioner Assy. - Hub & A.C.	4004933	38505	FLD		
Idler Pulley - Fan & Alt.	3400884	36308	Belt - Fan	3681811	♣K100710HD
Tensioner Pulley - A.C.	4004933	36091	Belt - Hub, Alt. & A.C.	0124196010	♣K060685HD
Hose - Upper - Eng. To Pipe		24236	Tensioner Assy. - Fan	3681240	38535
Hose - Upper - Pipe To Rad.		24240	Tensioner Assy. - Hub, Alt. & A.C.	3680194	38532
Hose - Lower - Eng. To Pipe		24240	Idler Pulley - Alt. & A.C.	4026886	36226
Hose - Lower - Pipe To Rad.		21891	Tensioner Pulley - A.C.	4004933	36091
FLD			Tensioner Pulley - Fan	3681240	36092
Belt - Fan & Alt.	0123415028	♣K080816HD	Tensioner Pulley - Hub, Alt. & A.C.	3680194	36095
Belt - Hub & A.C.	0124196015	♣K060559HD	Hose - Upper - Eng. To Pipe		24240
Tensioner Assy. - Fan & Alt.	3400885	38521	Hose - Upper - Pipe To Rad.		24240
Tensioner Assy. - Hub & A.C.	4004933	38505	Hose - Lower - Eng. To Pipe		21891
Idler Pulley - Fan & Alt.	3400884	36308	Hose - Lower - Pipe To Rad.		♣24240
Hose - Upper - Eng. To Pipe		24240	Cummins N14 Diesel		
Hose - Upper - Pipe To Rad.		24240	Century Class		
Hose - Lower - Pipe To Rad.		24240	Belt - Hub & Fan; Preferred Belt		2/TR28411PB
Hose - Lower - Eng. To Cooler		24240	Belt - Hub & Fan; Optional Belt		②TR28412
Hose - Lower - Pipe To Cooler		24240	Belt - Alt.		②♣9451HD
Cummins ISX Diesel			Belt - Hub & A.C.	2310001087	♣9435HD
Argosy			Belt - Hub & W.P.		♣K060425HD
Belt - Fan & W.P.		♣K060685HD	Hose - Upper - Eng. To Pipe		24240
Belt - W.P., Alt. & A.C.		♣K100710HD	Hose - Upper - Pipe To Rad.		24240
Tensioner Assy. - Fan	3681240	38535	Hose - Lower - Eng. To Pipe		24240
Tensioner Assy. - Hub, Alt. & A.C.	3680194	38532	Hose - Lower - Pipe To Rad.		24240
Idler Pulley - Alt. & A.C.	4026886	36226	Classic; Classic XL; FLD		
Tensioner Pulley - Fan	3681240	36092	Belt - Hub & Fan		②TR28429

 Medium & Heavy-Duty Trucks
(2001 & Newer)

 ♣Standard Belt Available.
 ②Two Required.

♣Cut to Fit.

Belts and Coolant Hose for Medium/Heavy-Duty Trucks (2001 & Newer)

Medium & Heavy-Duty Trucks
(2001 & Newer)

Application	Mfr. Part No.	Our No.
Freightliner - Continued		
2001 - Continued		
Cummins N14 Diesel - Continued		
Classic; Classic XL; FLD - Continued		
Belt - Alt.		②♠9451HD
Belt - Hub & A.C.	2310001087	♠9435HD
Belt - Hub & W.P.		♠K060425HD
Hose - Upper - Eng. To Pipe		24240
Hose - Upper - Pipe To Rad.		24240
Hose - Lower - Eng. To Pipe		24240
Hose - Lower - Pipe To Rad.		24248
Detroit Diesel 6-Cyl. 11.1 L Diesel		
Argosy		
Belt - Fan	0124894000	♠K100579HD
Belt - Alt. & A.C.	0124587000	♠K080580HD
Tensioner Assy. - Fan		38503
Tensioner Assy. - Alt. & A.C.	23520317	38501
Tensioner Pulley - Fan		38076
Tensioner Pulley - Alt. & A.C.		38075
Hose - Upper - Eng. To Pipe		24240
Hose - Upper - Rad. To Pipe		24240
Hose - Lower - Eng. To Cooler		24244
Hose - Lower - Cooler To Pipe		24244
Hose - Lower - Rad. To Pipe		≈21891
Century Class		
Belt - Fan; Preferred Belt; W/50 3/8" Belt O.C.		3/9500PB
Belt - Fan; Optional Belt; W/50 3/8" Belt O.C.	2310001022	③♠9500HD
Belt - Hub, Alt. & A.C.; W/130A. Alt.	0124587006	♠K080570HD
Belt - Hub, Alt. & A.C.; W/135A. Alt.	0124587004	♠K080565HD
Tensioner Assy. - Hub, Alt. & A.C.	23520317	38501
Tensioner Pulley - Hub, Alt. & A.C.	23520317	38075
Hose - Upper - Eng. To Pipe		21891
Hose - Upper - Pipe To Rad.		24240
Hose - Lower - Eng. To Pipe		24240
Hose - Lower - Pipe To Rad.		24240
Classic; Classic XL		
Belt - Fan; Preferred Belt		3/9525PB
Belt - Fan; Optional Belt		③♠9525HD
Belt - Hub, Alt. & A.C.; W/130A. Alt.	0124587000	♠K080580HD
Belt - Hub, Alt. & A.C.; W/135A. Alt.	0124587005	♠K080575HD
Tensioner Assy. - Hub, Alt. & A.C.	23520317	38501
Tensioner Pulley - Hub, Alt. & A.C.	23520317	38075
Hose - Upper - Eng. To Pipe		24240
Hose - Upper - Pipe To Rad.		24240
Hose - Lower - Eng. To Pipe		24248
Hose - Lower - Pipe To Rad.		24248
Columbia		
Belt - Fan; Preferred Belt; W/50 3/8" Belt O.C.		3/9500PB
Belt - Fan; Optional Belt; W/50 3/8" Belt O.C.	2310001022	③♠9500HD
Belt - Hub, Alt. & A.C.; W/135A. Alt.	0124587006	♠K080570HD
Belt - Hub, Alt. & A.C.; W/130A. Alt.	0124587000	♠K080580HD
Tensioner Assy. - Hub, Alt. & A.C.	23520317	38501
Tensioner Pulley - Hub, Alt. & A.C.	23520317	38075
Hose - Upper - Eng. To Pipe		21891
Hose - Upper - Pipe To Rad.		24240
Hose - Lower - Eng. To Pipe		24240
Hose - Lower - Pipe To Rad.		24240
FLD		
Belt - Fan; Preferred Belt		3/9525PB
Belt - Fan; Optional Belt		③♠9525HD
Belt - Hub, Alt. & A.C.; W/130A. Alt.	0124587000	♠K080580HD
Belt - Hub, Alt. & A.C.; W/135A. Alt.	0124587005	♠K080575HD
Tensioner Assy. - Hub, Alt. & A.C.	23520317	38501
Tensioner Pulley - Hub, Alt. & A.C.	23520317	38075
Hose - Upper - Eng. To Pipe		24240
Hose - Upper - Pipe To Rad.		24240
Hose - Lower - Eng. To Pipe		24248

Application	Mfr. Part No.	Our No.
Freightliner - Continued		
2001 - Continued		
Detroit Diesel 6-Cyl. 11.1 L Diesel - Continued		
FLD - Continued		
Hose - Lower - Pipe To Rad.		24248
Detroit Diesel 6-Cyl. 12.7 L Diesel		
Argosy		
Belt - Fan	0124894000	♠K100579HD
Belt - Alt. & A.C.	0124587000	♠K080580HD
Tensioner Assy. - Fan		38503
Tensioner Assy. - Alt. & A.C.	23520317	38501
Tensioner Pulley - Fan		38076
Tensioner Pulley - Alt. & A.C.		38075
Hose - Upper - Eng. To Pipe		24240
Hose - Upper - Rad. To Pipe		24240
Hose - Lower - Eng. To Cooler		24244
Hose - Lower - Cooler To Pipe		24244
Hose - Lower - Rad. To Pipe		≈21891
Century Class		
Belt - Fan; Preferred Belt; W/50 3/8" Belt O.C.		3/9500PB
Belt - Fan; Optional Belt; W/50 3/8" Belt O.C.	2310001022	③♠9500HD
Belt - Hub, Alt. & A.C.; W/130A. Alt.	0124587006	♠K080570HD
Belt - Hub, Alt. & A.C.; W/135A. Alt.	0124587004	♠K080565HD
Tensioner Assy. - Hub, Alt. & A.C.	23520317	38501
Tensioner Pulley - Hub, Alt. & A.C.	23520317	38075
Hose - Upper - Eng. To Pipe		21891
Hose - Upper - Pipe To Rad.		24240
Hose - Lower - Eng. To Pipe		24240
Hose - Lower - Pipe To Rad.		24240
Hose - Oil Cooler To Heater; W/Beaded End		CT103
Hose - Oil Cooler To Heater; W/Threaded End		CT105
Hose - Oil Cooler To Aux. Heater; W/Beaded End		CT104
Hose - Oil Cooler To Aux. Heater; W/Threaded End		CT106
Hose - W.P. Rear To Heater; W/Beaded End		CT102
Hose - W.P. Rear To Heater; W/Threaded End		CT108
Hose - W.P. Front To Aux. Heater; W/Beaded End		CT100
Hose - W.P. Front To Aux. Heater; W/Threaded End		CT107
Hose - W.P. To Reservoir		CT101
Classic		
Belt - Fan; Preferred Belt		3/9525PB
Belt - Fan; Optional Belt		③♠9525HD
Belt - Hub, Alt. & A.C.; W/130A. Alt.	0124587000	♠K080580HD
Belt - Hub, Alt. & A.C.; W/135A. Alt.	0124587005	♠K080575HD
Tensioner Assy. - Hub, Alt. & A.C.	23520317	38501
Tensioner Pulley - Hub, Alt. & A.C.	23520317	38075
Hose - Upper - Eng. To Pipe		24240
Hose - Upper - Pipe To Rad.		24240
Hose - Lower - Eng. To Pipe		24248
Hose - Lower - Pipe To Rad.		24248
Classic XL		
Belt - Fan; Preferred Belt		3/9525PB
Belt - Fan; Optional Belt		③♠9525HD
Belt - Hub, Alt. & A.C.; W/130A. Alt.	0124587000	♠K080580HD
Belt - Hub, Alt. & A.C.; W/135A. Alt.	0124587005	♠K080575HD
Tensioner Assy. - Hub, Alt. & A.C.	23520317	38501
Tensioner Pulley - Hub, Alt. & A.C.	23520317	38075
Hose - Upper - Eng. To Pipe		24240
Hose - Upper - Pipe To Rad.		24240
Hose - Lower - Eng. To Pipe		24248
Hose - Lower - Pipe To Rad.		24248
Hose - Oil Cooler To Heater; W/Beaded End		CT103
Hose - Oil Cooler To Heater; W/Threaded End		CT105
Hose - Oil Cooler To Aux. Heater; W/Beaded End		CT104
Hose - Oil Cooler To Aux. Heater; W/Threaded End		CT106
Hose - W.P. Rear To Heater; W/Beaded End		CT102
Hose - W.P. Rear To Heater; W/Threaded End		CT108
Hose - W.P. Front To Aux. Heater; W/Beaded End		CT100
Hose - W.P. Front To Aux. Heater; W/Threaded End		CT107

♠Standard Belt Available.
③Three Required.

≈Cut to Fit.

Belts and Coolant Hose for Medium/Heavy-Duty Trucks (2001 & Newer)

Application	Mfr. Part No.	Our No.	Application	Mfr. Part No.	Our No.
Freightliner - Continued			Freightliner - Continued		
2001 - Continued			2001 - Continued		
Detroit Diesel 6-Cyl. 12.7 L Diesel - Continued			Detroit Diesel Series 50 Diesel		
Classic XL - Continued			FL106		
Hose - W.P. To Reservoir		CT101	Belt - Fan		③▲9465HD
Columbia			Belt - Fan & Alt.	2310001039	▲9530HD
Belt - Fan; Preferred Belt; W/50 3/8" Belt O.C.		3/9500PB	Belt - Alt. & Hyd. Pump		▲9610HD
Belt - Fan; Optional Belt; W/50 3/8" Belt O.C.	2310001022	③▲9500HD	Belt - Hub & A.C.	0120984004	2/9435PB
Belt - Hub, Alt. & A.C.; W/135A. Alt.	0124587006	▲K080570HD	Hose - Upper - Eng. To Pipe		24240
Belt - Hub, Alt. & A.C.; W/130A. Alt.	0124587000	▲K080580HD	Hose - Upper - Pipe To Rad.		24240
Tensioner Assy. - Hub, Alt. & A.C.	23520317	38501	Hose - Lower - Pipe To Rad.		≡21194
Tensioner Pulley - Hub, Alt. & A.C.	23520317	38075	Mercedes-Benz MBE 900 Diesel		
Hose - Upper - Eng. To Pipe		21891	FL50; FL60; FL70; FL80		
Hose - Upper - Pipe To Rad.		24240	Belt - Fan, Alt. & A.C.	0126246000	▲K080830HD
Hose - Lower - Eng. To Pipe		24240	Hose - Upper - Eng. To Rad.		22743
Hose - Lower - Pipe To Rad.		24240	Hose - Lower - Eng. To Pipe		20206
Hose - Oil Cooler To Heater; W/Beaded End		CT103	Hose - Lower - Pipe To Rad.		20206
Hose - Oil Cooler To Heater; W/Threaded End		CT105	Mercedes-Benz MBE 4000 Diesel		
Hose - Oil Cooler To Aux. Heater; W/Beaded End		CT104	Century Class		
Hose - Oil Cooler To Aux. Heater; W/Threaded End		CT106	Belt - Fan	9355103	③▲9510HD
Hose - W.P. Rear To Heater; W/Beaded End		CT102	Belt - Hub & Alt.	0124587004	▲K080565HD
Hose - W.P. Rear To Heater; W/Threaded End		CT108	Belt - A.C.	9363156	▲K080560HD
Hose - W.P. Front To Aux. Heater; W/Beaded End		CT100	Tensioner Assy. - A.C.	23520317	38501
Hose - W.P. Front To Aux. Heater; W/Threaded End		CT107	Tensioner Pulley - A.C.		38075
Hose - W.P. To Reservoir		CT101	Hose - Upper - Eng. To Pipe		24240
FLD			Hose - Upper - Pipe To Rad.		24240
Belt - Fan; Preferred Belt		3/9525PB	Hose - Lower - Eng. To Pipe		24240
Belt - Fan; Optional Belt		③▲9525HD	Hose - Lower - Pipe To Rad.		24240
Belt - Hub, Alt. & A.C.; W/130A. Alt.	0124587000	▲K080580HD	GMC		
Belt - Hub, Alt. & A.C.; W/135A. Alt.	0124587005	▲K080575HD	2010		
Tensioner Assy. - Hub, Alt. & A.C.	23520317	38501	Isuzu 4HK1-TC Diesel		
Tensioner Pulley - Hub, Alt. & A.C.	23520317	38075	W3500; W5500; W5500HD		
Hose - Upper - Eng. To Pipe		24240	Belt - Fan & Alt.	8980031870	K070404HD
Hose - Upper - Pipe To Rad.		24240	Belt - A.C.	8980108410	▲9650HD
Hose - Lower - Eng. To Pipe		24248	2009		
Hose - Lower - Pipe To Rad.		24248	Caterpillar C7 Diesel		
Detroit Diesel 6-Cyl. 14.0 L Diesel			C6500; C7500; C8500		
Classic XL			Belt - Fan, A.C., Alt. & W.P.	12605194	▲K080810HD
Belt - Fan; Preferred Belt		3/9525PB	Tensioner Assy. - Fan, A.C., Alt. & W.P.	15170283	38586
Belt - Fan; Optional Belt		③▲9525HD	GM V-8 6.0 L		
Belt - Hub, Alt. & A.C.; W/130A. Alt.	0124587000	▲K080580HD	W3500; W4500		
Belt - Hub, Alt. & A.C.; W/135A. Alt.	0124587005	▲K080575HD	Belt - A.C.; Installation Tool Required	12603509	K040355SF
Tensioner Assy. - Hub, Alt. & A.C.	23520317	38501	Belt - Fan, Alt. & P.S.	8980361660	▲K061010HD
Tensioner Pulley - Hub, Alt. & A.C.	23520317	38075	Belt - Stretch Fit Belt Installation Tool		91030
Hose - Upper - Eng. To Pipe		24240	Tensioner Assy. - Fan, Alt. & P.S.	12609719	39083
Hose - Upper - Pipe To Rad.		24240	GM V-8 6.6 L Diesel		
Hose - Lower - Eng. To Pipe		24248	C4500; C5500		
Hose - Lower - Pipe To Rad.		24248	Belt - Fan, Alt., P.S. & A.C.	98035629	▲K061203HD
Hose - Oil Cooler To Heater; W/Beaded End		CT103	Tensioner Assy. - Fan, Alt., P.S. & A.C.	97329062	38172
Hose - Oil Cooler To Heater; W/Threaded End		CT105	Idler Pulley - Upper (Smooth)	98072072	36310
Hose - Oil Cooler To Aux. Heater; W/Beaded End		CT104	Idler Pulley - Lower (Smooth)	98072072	36310
Hose - Oil Cooler To Aux. Heater; W/Threaded End		CT106	GM V-8 8.1 L		
Hose - W.P. Rear To Heater; W/Beaded End		CT102	C4500; C5500		
Hose - W.P. Rear To Heater; W/Threaded End		CT108	Belt - Fan, Alt., P.S. & A.C.	12617797	▲K061000HD
Hose - W.P. Front To Aux. Heater; W/Beaded End		CT100	Tensioner Assy. - Fan, Alt., P.S. & A.C.	12581203	38258
Hose - W.P. Front To Aux. Heater; W/Threaded End		CT107	Idler Pulley - Fan, Alt. & A.C.	12580771	36299
Hose - W.P. To Reservoir		CT101	Hose - Upper - Eng. To Rad.		22769
FLD			C6500; C7500		
Belt - Fan; Preferred Belt		3/9525PB	Belt - Fan, Alt., P.S. & A.C.	12617797	▲K061000HD
Belt - Fan; Optional Belt		③▲9525HD	Tensioner Assy. - Fan, Alt., P.S. & A.C.	12581203	38258
Belt - Hub, Alt. & A.C.; W/130A. Alt.	0124587000	▲K080580HD	Idler Pulley - Fan, Alt. & A.C.	12580771	36299
Belt - Hub, Alt. & A.C.; W/135A. Alt.	0124587005	▲K080575HD	Hose - Upper - Eng. To Rad.		22769
Tensioner Assy. - Hub, Alt. & A.C.	23520317	38501	Caterpillar C7 Diesel		
Tensioner Pulley - Hub, Alt. & A.C.	23520317	38075	C6500; C7500		
Hose - Upper - Eng. To Pipe		24240	Belt - Fan, Alt., P.S. & A.C.	12617797	▲K061000HD
Hose - Upper - Pipe To Rad.		24240	Tensioner Assy. - Fan, Alt., P.S. & A.C.	12581203	38258
Hose - Lower - Eng. To Pipe		24248	Idler Pulley - Fan, Alt. & A.C.	12580771	36299
Hose - Lower - Pipe To Rad.		24248	Hose - Upper		22769

Medium & Heavy-Duty Trucks (2001 & Newer)

 ▲Standard Belt Available.
 ≡Cut to Fit.

③Three Required.

Belts and Coolant Hose for Medium/Heavy-Duty Trucks (2001 & Newer)

Medium & Heavy-Duty Trucks
(2001 & Newer)

Application	Mfr. Part No.	Our No.	Application	Mfr. Part No.	Our No.
GMC - Continued			GMC - Continued		
2009 - Continued			2008 - Continued		
GM V-8 8.1 L - Continued			Isuzu 6HK1-TC Diesel		
C6500; C7500 - Continued			C6500; C7500; C8500		
Hose - Upper - Eng. To Rad.		22769	Belt - Fan, Alt. & A.C.	15020893	♣K070786HD
C8500			Belt - W.P.	1136714641	TR22461
Belt - Fan, Alt., P.S. & A.C.	12617797	♣K061000HD	Tensioner Assy. - Fan, Alt. & A.C.	12597859	38548
Tensioner Assy. - Fan, Alt., P.S. & A.C.	12581203	38258	Idler Pulley - Fan, Alt. & A.C.	89022559	36096
Idler Pulley - Fan, Alt. & A.C.	12580771	36299	Hose - Upper - Eng. To Rad.		22767
Hose - Upper - Eng. To Rad.		22769	Hose - Lower - Eng. To Rad.		22768
Isuzu 4HK1-TC Diesel			T6500; T7500; T8500		
W3500; W5500; W5500HD			Belt - Fan, Alt. & A.C.		
Belt - Fan & Alt.	8980031870	K070404HD	Tensioner Assy. - Fan, Alt. & A.C.	15098394	♣K080726HD
Belt - A.C.	8980108410	♣9650HD	Hose - Upper - Eng. To Rad.		22855
Isuzu 6HK1-TC Diesel			2007		
C6500; C7500; C8500			Caterpillar C7 Diesel		
Belt - Fan, Alt. & A.C.	15020893	♣K070786HD	C6500; C7500; C8500		
Belt - W.P.: V-Belt	1136714641	TR22461	Belt - Fan, Alt. & A.C.		
Tensioner Assy. - Fan, Alt. & A.C.	12597859	38548	Belt - Fan, Alt. & A.C.		
Idler Pulley - Fan, Alt. & A.C.	89022559	36096	Tensioner Assy. - Fan, Alt. & A.C.		
Hose - Upper - Eng. To Rad.		22767	Idler Pulley		
Hose - Lower - Eng. To Rad.		22768	89022559		
2008			GM V-8 6.0 L		
Caterpillar C7 Diesel			W3500; W4500		
C6500; C7500; C8500			Belt - Fan, Alt. & P.S.		
Belt - Fan, A.C., Alt. & W.P.	12605194	♣K080810HD	Belt - A.C.	12576447	♣K040378HD
Tensioner Assy. - Fan, A.C., Alt. & W.P.	15170283	38586	Tensioner Assy. - Alt. & P.S.	12580162	38158
GM V-8 6.0 L			Tensioner Assy. - A.C.		
W3500; W4500			Tensioner Pulley - Alt. & P.S.		
Belt - A.C.; Installation Tool Required	12603509	K040355SF	Tensioner Pulley - A.C.		
Belt - Fan, Alt. & P.S.	8980361660	♣K061010HD	Hose - Upper - Eng. To Rad.		
Belt - Stretch Fit Belt Installation Tool		91030	Hose - Lower - Eng. To Rad.		
Tensioner Assy. - Fan, Alt. & P.S.	12609719	39083	23098		
Idler Pulley	97252188	38006	23097		
GM V-8 6.6 L Diesel			GM V-8 6.6 L Diesel		
C4500; C5500			C4500; C5500		
Belt - Fan, Alt., P.S. & A.C.	98035629	♣K061203HD	Belt - Fan, Alt., P.S. & A.C.; W/105A. Alt. ...		
Tensioner Assy. - Fan, Alt., P.S. & A.C.	97329062	38172	Belt - Fan, Alt., P.S. & A.C.; W/150A. Alt. ...		
Tensioner Assy.	8973290620	38172	Belt - Fan, Alt., P.S. & A.C.; W/Dual 105A.		
Idler Pulley; W/Flat Idler Pulley	97209546	36310	Alts.		
Idler Pulley; W/O A.C.	14102597	36177	Tensioner Assy.		
Tensioner Pulley	8973290620	36239	Idler Pulley; W/Flat Idler Pulley		
GM V-8 8.1 L			Idler Pulley; W/O A.C.		
C4500; C5500			Tensioner Pulley		
Belt - Fan, Alt., P.S. & A.C.	12576754	♣K060994HD	Hose - Upper - Eng. To Rad.		
Tensioner Assy. - Fan, Alt., P.S. & A.C.	12581203	38258	Hose - Lower - Eng. To Rad.		
Idler Pulley	12580771	36299	22769		
Tensioner Pulley	12581203	38006	22770		
Hose - Upper		22769	C6500; C7500; C8500		
Hose - Lower		22770	Belt - Fan, Alt., P.S. & A.C.		
C6500; C7500; C8500			Belt - Fan, Alt. & P.S.; W/O A.C.		
Belt - Fan, Alt., P.S. & A.C.	15768485	♣K071247HD	Belt - Air Compr.		
Belt - Fan, Alt. & P.S.; W/O A.C.	15021740	♣K071056HD	Tensioner Assy. - Fan, Alt., P.S. & A.C.		
Belt - Air Compr.	15074400	♣K040745HD	Tensioner Pulley - Fan, Alt., P.S. & A.C.		
Tensioner Assy. - Fan, Alt., P.S. & A.C.	15021742	38256	Hose - Upper		
Tensioner Pulley - Fan, Alt., P.S. & A.C.	15021742	38033	Hose - Lower		
Tensioner Pulley - Fan & Air Compr.	15001551	38006	22769		
Hose - Upper		22769	22770		
Isuzu 4HK1-TC Diesel			C6500; C7500; C8500		
W3500; W4500; W5500; W5500HD			Belt - Fan, Alt., P.S. & A.C.		
Belt - W.P., Fan & Alt.	8980031870	K070404HD	Belt - Fan, Alt. & P.S.; W/O A.C.		
Belt - A.C.	8980108410	♣9650HD	Belt - Air Compr.		
			Tensioner Assy. - Fan, Alt., P.S. & A.C.		
			Tensioner Pulley - Fan, Alt., P.S. & A.C.		
			Tensioner Pulley - Fan & Air Compr.		
			Hose - Upper - Eng. To Rad.		
			Hose - Lower - Eng. To Rad.		

♣Standard Belt Available.

ⓂTwo Required.

Belts and Coolant Hose for Medium/Heavy-Duty Trucks (2001 & Newer)

Application	Mfr. Part No.	Our No.	Application	Mfr. Part No.	Our No.
GMC - Continued			GMC - Continued		
2007 - Continued			2006 - Continued		
Isuzu 4HK1-TC Diesel			GM V-8 8.1 L - Continued		
W3500; W4500; W5500; W5500HD			C6500; C7500; C8500 - Continued		
Belt - Fan & Alt.	8971801811	②▲9420HD	Belt - Fan, Alt. & P.S.; W/O A.C.	15021740	▲K071056HD
Belt - Alt. & A.C.	8971801832	▲9620HD	Belt - Air Compr.	15074400	▲K040745HD
Hose - Upper - Eng. To Rad.		23096	Tensioner Assy. - Fan, Alt., P.S. & A.C.	15021742	38256
Hose - Lower - Eng. To Rad.		23095	Tensioner Pulley - Fan, Alt., P.S. & A.C.	15021742	38033
Isuzu 6HK1-TC Diesel			Tensioner Pulley - Fan & Air Compr.	15001551	38006
C6500; C7500; C8500			Hose - Upper - Eng. To Rad.		22854
Belt - Fan, Alt. & A.C.	15020893	▲K070786HD	Hose - Lower - Eng. To Rad.		22771
Belt - P.S. & W.P.	97730199	TR22461	Isuzu 4HK1-TC Diesel		
Hose - Upper - Eng. To Rad.		22767	W3500; W4500; W5500; W5500HD		
Hose - Lower - Eng. To Rad.		22768	Belt - Fan & Alt.	8971801811	②▲9420HD
T6500; T7500; T8500			Belt - Alt. & A.C.	8971801832	▲9620HD
Belt - Fan, Alt. & A.C.	15065874	▲K080726HD	Hose - Upper - Eng. To Rad.		23096
Belt - Fan & Alt.	15065875	▲K080550HD	Hose - Lower - Eng. To Rad.		23095
Tensioner Assy. - Fan, Alt. & A.C.	15098394	38579	Isuzu 6HK1-TC Diesel		
Hose - Upper - Eng. To Rad.		22855	C6500; C7500; C8500		
Hose - Lower - Eng. To Rad.		22856	Belt - Fan, Alt. & A.C.	15020893	▲K070786HD
2006			Belt - P.S. & W.P.	97730199	TR22461
Caterpillar C7 Diesel			Tensioner Assy.	15008841	38548
C6500; C7500; C8500			Hose - Upper - Eng. To Rad.		22767
Belt - Fan, Alt. & A.C.	15170173	▲K080806HD	Hose - Lower - Eng. To Rad.		22768
Tensioner Assy. - Fan, Alt. & A.C.	15170283	38586	T6500; T7500; T8500		
Idler Pulley	89022559	36096	Belt - Fan, Alt. & A.C.	15065874	▲K080726HD
Hose - Upper - Eng. To Rad.		23087	Belt - Fan & Alt.	15065875	▲K080550HD
Hose - Lower - Eng. To Rad.		23088	Tensioner Assy. - Fan, Alt. & A.C.	15098394	38579
GM V-8 6.0 L			Hose - Upper - Eng. To Rad.		22855
W3500; W4500			Hose - Lower - Eng. To Rad.		22856
Belt - Fan, Alt. & P.S.	12576754	▲K060994HD	2005		
Belt - A.C.	12576447	▲K040378HD	Caterpillar C7 Diesel		
Tensioner Assy. - Alt. & P.S.	12580162	38158	C6500; C7500; C8500		
Tensioner Assy. - A.C.	12580196	38159	Belt - Fan, Alt. & A.C.		
Tensioner Pulley - Alt. & P.S.	12580162	38009	Belt - Fan, Alt. & A.C.		
Tensioner Pulley - A.C.	12580196	36169	Idler Pulley		
Hose - Upper - Eng. To Rad.		23098	Hose - Upper - Eng. To Rad.; W/O H.D. Cool.		
Hose - Lower - Eng. To Rad.		23097	Hose - Upper - Eng. To Rad.; W/H.D. Cool.		
GM V-8 6.6 L Diesel			Hose - Lower - Eng. To Rad.		
C4500; C5500			23088		
Belt - Fan, Alt., P.S. & A.C.; W/105A. Alt. ...	97300654	▲K061187HD	GM V-8 6.0 L		
Belt - Fan, Alt., P.S. & A.C.; W/150A. Alt. ...	97300656	▲K061195HD	W3500; W4500		
Belt - Fan, Alt., P.S. & A.C.; W/Dual 105A. Alts.	97300655	▲K061360HD	Belt - Fan, Alt. & P.S.		
Tensioner Assy.	97288625	38172	Belt - A.C.		
Idler Pulley; W/Flat Idler Pulley	97209546	36310	Tensioner Assy. - Alt. & P.S.		
Idler Pulley; W/O A.C.	14102597	36177	Tensioner Assy. - A.C.		
Tensioner Pulley	97288625	36239	Tensioner Pulley		
Hose - Upper - Eng. To Rad.		22763	Tensioner Pulley - Alt. & P.S.		
Hose - Lower - Eng. To Rad.		22771	Tensioner Pulley - A.C.		
GM V-8 8.1 L			Hose - Upper - Eng. To Rad.		
C4500; C5500			Hose - Lower - Eng. To Rad.		
Belt - Fan, Alt. & P.S.; W/O A.C.; W/Dual 105A. Alts.	12563074	▲K061058HD	23097		
Belt - Fan, Alt., P.S. & A.C.; W/Single 150A. Alt.	12563076	▲K060994HD	GM V-8 6.6 L Diesel		
Tensioner Assy.	12581203	38258	C4500; C5500		
Idler Pulley; W/A.C.	12580771	36299	Belt - Fan, Alt., P.S. & A.C.; W/105A. Alt. ...		
Idler Pulley - Smooth; W/O A.C.	12580771	36299	Belt - Fan, Alt., P.S. & A.C.; W/150A. Alt. ...		
Idler Pulley - Grooved; W/O A.C.	12580774	38008	Belt - Fan, Alt., P.S. & A.C.; W/Dual 105A. Alts.		
Tensioner Pulley	12581203	38006	Tensioner Assy.		
Hose - Upper - Eng. To Rad.		22769	Idler Pulley; W/Flat Idler Pulley		
Hose - Lower - Eng. To Rad.		22770	Idler Pulley; W/O A.C.		
C6500; C7500; C8500			Idler Pulley - Smooth; W/O A.C.		
Belt - Fan, Alt., P.S. & A.C.	15768485	▲K071247HD	Tensioner Pulley		

Medium & Heavy-Duty Trucks (2001 & Newer)

▲Standard Belt Available.
≡Cut to Fit.

②Two Required.

Belts and Coolant Hose for Medium/Heavy-Duty Trucks (2001 & Newer)

**Medium & Heavy-Duty Trucks
(2001 & Newer)**

Application	Mfr. Part No.	Our No.	Application	Mfr. Part No.	Our No.
GMC - Continued			GMC - Continued		
2005 - Continued			2004 - Continued		
GM V-8 8.1 L			GM V-8 6.0 L - Continued		
C4500; C5500			W3500; W4500 - Continued		
Belt - Fan, Alt., P.S. & A.C.; W/Single			Belt - A.C.	12576447	♣K040378HD
105A. Alt.	12563075	♣K060988HD	Tensioner Assy. - Alt. & P.S.	12580162	38158
Belt - Fan, Alt. & P.S.; W/O A.C.; W/Single			Tensioner Assy. - A.C.	12580196	38159
105A. Alt.	12563072	♣K060905HD	Idler Pulley	12580771	36299
Belt - Fan, Alt., P.S. & A.C.; W/Dual 105A.			Tensioner Pulley - Alt. & P.S.	12580162	38009
Alts.	12563077	♣K061140HD	Tensioner Pulley - A.C.	12580196	36169
Belt - Fan, Alt. & P.S.; W/O A.C.; W/Dual			Hose - Upper - Eng. To Rad.		23098
105A. Alts.	12563074	♣K061058HD	Hose - Lower - Eng. To Rad.		23097
Belt - Fan, Alt., P.S. & A.C.; W/Single			GM V-8 6.6 L Diesel		
150A. Alt.	12563076	♣K060994HD	C4500; C5500		
Tensioner Assy.	12581203	38258	Belt - Fan, Alt., P.S. & A.C.; W/105A. Alt. ...	97300654	♣K061187HD
Idler Pulley; W/A.C.	12580771	36299	Belt - Fan, Alt., P.S. & A.C.; W/150A. Alt. ...	97300656	♣K061195HD
Idler Pulley - Smooth; W/O A.C.	12580771	36299	Belt - Fan, Alt., P.S. & A.C.; W/Dual 105A.		
Idler Pulley - Grooved; W/O A.C.	12580774	38008	Alts.	97300655	♣K061360HD
Tensioner Pulley	12581203	38006	Tensioner Assy.	97288625	38172
Hose - Upper - Eng. To Rad.		22769	Idler Pulley; W/Flat Idler Pulley	97209546	36310
Hose - Lower - Eng. To Rad.		22770	Idler Pulley; W/O A.C.	14102597	36177
C6500; C7500; C8500			Tensioner Pulley	97288625	36239
Belt - Fan, Alt., P.S. & A.C.	15768485	♣K071247HD	Hose - Upper - Eng. To Rad.		22763
Belt - Fan, Alt. & P.S.; W/O A.C.	15021740	♣K071056HD	Hose - Lower - Eng. To Rad.		22771
Belt - Air Compr.	15074400	♣K040745HD	GM V-8 8.1 L		
Tensioner Assy. - Fan, Alt., P.S. & A.C.	15021742	38256	C4500; C5500		
Tensioner Pulley - Fan, Alt., P.S. & A.C.	15021742	38033	Belt - Fan, Alt., P.S. & A.C.; W/Single		
Tensioner Pulley - Fan & Air Compr.	15001551	38006	105A. Alt.	12563075	♣K060988HD
Hose - Upper - Eng. To Rad.		22854	Belt - Fan, Alt. & P.S.; W/O A.C.; W/Single		
Hose - Lower - Eng. To Rad.		22771	105A. Alt.	12563072	♣K060905HD
Isuzu 4HK1-TC Diesel			Belt - Fan, Alt., P.S. & A.C.; W/Dual 105A.		
W3500; W4500			Alts.	12563077	♣K061140HD
Belt - Fan & Alt.	8971801811	②♣9420HD	Belt - Fan, Alt. & P.S.; W/O A.C.; W/Dual		
Belt - Alt. & A.C.	8971801832	♣9620HD	105A. Alts.	12563074	♣K061058HD
Hose - Upper - Eng. To Rad.		23096	Belt - Fan, Alt., P.S. & A.C.; W/Single		
Hose - Lower - Eng. To Rad.		23095	150A. Alt.	12563076	♣K060994HD
W5500; W5500HD			Tensioner Assy.	12581203	38258
Belt - Fan & Alt.	8971801811	♣9420HD	Idler Pulley; W/A.C.	12580771	36299
Belt - Alt. & A.C.	8971801832	♣9620HD	Idler Pulley - Smooth; W/O A.C.	12580771	36299
Hose - Upper - Eng. To Rad.		23096	Idler Pulley - Grooved; W/O A.C.	12580774	38008
Hose - Lower - Eng. To Rad.		23095	Tensioner Pulley	12581203	38006
Isuzu 6HK1-TC Diesel			Hose - Upper - Eng. To Rad.		22769
C6500; C7500; C8500			Hose - Lower - Eng. To Rad.		22770
Belt - Fan, Alt. & A.C.	15020893	♣K070786HD	C6500; C7500; C8500		
Belt - P.S. & W.P.	97730199	TR22461	Belt - Fan, Alt., P.S. & A.C.	15768485	♣K071247HD
Tensioner Assy. - Fan, Alt. & A.C.	15008841	38548	Belt - Fan, Alt. & P.S.; W/O A.C.	15021740	♣K071056HD
Hose - Upper - Eng. To Rad.		22767	Belt - Air Compr.	15074400	♣K040745HD
Hose - Lower - Eng. To Rad.		22768	Tensioner Assy. - Fan, Alt., P.S. & A.C.	15021742	38256
T6500; T7500; T8500			Tensioner Pulley - Fan, Alt., P.S. & A.C.	15021742	38033
Belt - Fan, Alt. & A.C.	15065874	♣K080726HD	Tensioner Pulley - Fan & Air Compr.	15001551	38006
Belt - Fan & Alt.	15065875	♣K080550HD	Hose - Upper - Eng. To Rad.		22854
Tensioner Assy. - Fan, Alt. & A.C.	15098394	38579	Hose - Lower - Eng. To Rad.		22771
Hose - Upper - Eng. To Rad.		22855	Isuzu 4HE1-TC Diesel		
Hose - Lower - Eng. To Rad.		22856	W3500; W4500; W5500		
2004			Belt - Fan & Alt.	8971801811	②♣9420HD
Caterpillar C7 Diesel			Belt - Alt. & A.C.	8971801832	♣9620HD
C6500; C7500; C8500			Hose - Upper - Eng. To Rad.		23096
Belt - Fan, Alt. & A.C.	15170173	♣K080806HD	Hose - Lower - Eng. To Rad.		23095
Tensioner Assy. - Fan, Alt. & A.C.	15170283	38586	Isuzu 6HK1-TC Diesel		
Idler Pulley	89022559	36096	C6500; C7500; C8500		
Hose - Upper - Eng. To Rad.; W/O H.D. Cool.		23087	Belt - Fan, Alt. & A.C.	15020893	♣K070786HD
Hose - Upper - Eng. To Rad.; W/H.D. Cool.		23099	Belt - P.S. & W.P.	97730199	TR22461
Hose - Lower - Eng. To Rad.		23088	Tensioner Assy. - Fan, Alt. & A.C.	15008841	38548
GM V-8 6.0 L			Hose - Upper - Eng. To Rad.		22767
W3500; W4500			Hose - Lower - Eng. To Rad.		22768
Belt - Fan, Alt. & P.S.		♣K060994HD	T6500; T7500; T8500		
			Belt - Fan, Alt. & A.C.	15065874	♣K080726HD

♣Standard Belt Available.

②Two Required.

Belts and Coolant Hose for Medium/Heavy-Duty Trucks (2001 & Newer)

 Medium & Heavy-Duty Trucks
(2001 & Newer)

Application	Mfr. Part No.	Our No.	Application	Mfr. Part No.	Our No.
GMC - Continued			GMC - Continued		
2004 - Continued			2003 - Continued		
Isuzu 6HK1-TC Diesel - Continued			GM V-8 8.1 L		
T6500; T7500; T8500 - Continued			C4500; C5500		
Belt - Fan & Alt.	15065875	♣K080550HD	Belt - Fan, Alt., P.S. & A.C.; W/Single 105A. Alt.	12563075	♣K060988HD
Tensioner Assy. - Fan, Alt. & A.C.	15098394	38579	Belt - Fan, Alt. & P.S.; W/O A.C.; W/Single 105A. Alt.	12563072	♣K060905HD
Hose - Upper - Eng. To Rad.		22855	Belt - Fan, Alt., P.S. & A.C.; W/Dual 105A. Alts.	12563077	♣K061140HD
Hose - Lower - Eng. To Rad.		22856	Belt - Fan, Alt. & P.S.; W/O A.C.; W/Dual 105A. Alts.	12563074	♣K061058HD
W4500; W5500; WT5500			Belt - Fan, Alt., P.S. & A.C.; W/Single 150A. Alt.	12563076	♣K060994HD
Belt - Fan & Alt.	1136714641	②TR22461	Belt - Fan, Alt. & P.S.; W/O A.C.; W/Single 150A. Alt.	12563073	♣K060910HD
Belt - A.C.	8943951720	TR22434	Tensioner Assy.	12581203	38258
Hose - Upper - Eng. To Rad.		22733	Idler Pulley; W/A.C.	12580771	36299
Hose - Lower - Eng. To Rad.		22734	Idler Pulley - Smooth; W/O A.C.	12580771	36299
2003			Idler Pulley - Grooved; W/O A.C.	12580774	38008
Caterpillar 3126 Diesel			Tensioner Pulley	12581203	38006
C6500; C7500; C8500			Hose - Upper - Eng. To Rad.		22769
Belt - Fan, Alt. & A.C.	15008836	♣K070835HD	Hose - Lower - Eng. To Rad.		22770
Belt - Fan & Alt.; W/O A.C.	15043146	♣K070709HD	C6500; C7500; C8500		
Belt - W.P.	0618384	♣9335HD	Belt - Fan, Alt., P.S. & A.C.	15768485	♣K071247HD
Tensioner Assy.	15083306	38557	Belt - Fan, Alt. & P.S.; W/O A.C.	15021740	♣K071056HD
Idler Pulley	89022559	36096	Belt - Air Compr.	15074400	♣K040745HD
Tensioner Pulley	15083306	36091	Tensioner Assy. - Fan, Alt., P.S. & A.C.	15021742	38256
Hose - Upper - Eng. To Rad.; W/H.D. Cool.		22764	Tensioner Pulley - Fan, Alt., P.S. & A.C.	15021742	38033
Hose - Upper - Eng. To Rad.; W/O H.D. Cool.		22765	Tensioner Pulley - Fan & Air Compr.	15001551	38006
Hose - Lower - Eng. To Rad.		22766	Hose - Upper - Eng. To Rad.		22854
T5500; T6500; T7500; T8500			Isuzu 4HE1-TC Diesel		
Belt - Fan & Alt.	15149560	♣K070553HD	W3500; W4500; W5500		
Belt - Fan, Alt. & A.C.	15985715	♣K070677HD	Belt - Fan & Alt.	8971801811	②♣9420HD
Belt - Hub & W.P.	0366775	♣9341HD	Belt - Alt. & A.C.	8971801832	♣9620HD
Tensioner Assy.	15999618	38578	Hose - Upper - Eng. To Rad.		23096
Tensioner Pulley	15999618	36091	Hose - Lower - Eng. To Rad.		23095
Hose - Upper - Eng. To Rad.		22706	Isuzu 6HK1-TC Diesel		
Hose - Lower - Eng. To Rad.		22705	C6500; C7500; C8500		
GM V-8 5.7 L			Belt - Fan, Alt. & A.C.		
W3500; W4500			Belt - P.S. & W.P.		
Belt - Fan, Alt., P.S. & A.C.	8971106400	♣K061010HD	Tensioner Assy. - Fan, Alt. & A.C.		
Tensioner Assy. - Fan, Alt., P.S. & A.C.	8971619590	38528	Hose - Upper - Eng. To Rad.		
Hose - Upper - Eng. To Rad.		22731	Hose - Lower - Eng. To Rad.		
Hose - Lower - Eng. To Rad.		22732	GM V-8 6.0 L		
GM V-8 6.0 L			W4500		
W4500			Belt - Fan, Alt. & P.S.		
Belt - Fan, Alt. & P.S.		♣K060994HD	Belt - A.C.		
Belt - A.C.	12576447	♣K040378HD	Tensioner Assy. - Alt. & P.S.		
Tensioner Assy. - Alt. & P.S.	12580162	38158	Tensioner Assy. - A.C.		
Tensioner Assy. - A.C.	12580196	38159	Idler Pulley		
Idler Pulley	12580771	36299	Tensioner Pulley - Alt. & P.S.		
Tensioner Pulley - Alt. & P.S.	12580162	38009	Tensioner Pulley - A.C.		
Tensioner Pulley - A.C.	12580196	36169	Hose - Upper - Eng. To Rad.		
Hose - Upper - Eng. To Rad.		23098	Hose - Lower - Eng. To Rad.		
Hose - Lower - Eng. To Rad.		23097	2002		
GM V-8 6.6 L Diesel			Caterpillar 3126 Diesel		
C4500; C5500			C5500; C6500; C7500; C8500		
Belt - Fan, Alt., P.S. & A.C.; W/105A. Alt. ...	97300654	♣K061187HD	Belt - Fan & Alt.; W/O A.C.	15670937	♣K070705HD
Belt - Fan, Alt., P.S. & A.C.; W/150A. Alt. ...	97300656	♣K061195HD	Belt - Fan, Alt. & A.C.	15690236	♣K070733HD
Belt - Fan, Alt., P.S. & A.C.; W/Dual 105A. Alts.	97300655	♣K061360HD	Belt - W.P.	0366775	♣9341HD
Tensioner Assy.	97288625	38172	Tensioner Assy.	7E3999	38509
Idler Pulley; W/Flat Idler Pulley	97209546	36310	Idler Pulley	89022559	36096
Idler Pulley; W/O A.C.	14102597	36177	Tensioner Pulley	7E3999	36091
Tensioner Pulley	97288625	36239	Hose - Upper - Eng. To Rad.; W/Conventional Hood		22032
Hose - Upper - Eng. To Rad.		22763	Hose - Upper - Eng. To Rad.; W/High Visibility Hood		22664
Hose - Lower - Eng. To Rad.		22771	Hose - Lower - Eng. To Rad.		21985
GM V-8 8.1 L			Hose - Heater Inlet		28442
C4500; C5500			Hose - Heater Outlet		28441
Belt - Fan & Alt.; W/O A.C.	15149560	♣K070553HD	T5500; T6500; T7500; T8500		
Belt - Fan, Alt. & A.C.	15985715	♣K070677HD	Belt - Fan & Alt.; W/O A.C.	15149560	♣K070553HD
Belt - Hub & W.P.	0366775	♣9341HD	Belt - Fan, Alt. & A.C.	15985715	♣K070677HD

②Two Required.

♣Standard Belt Available.

Belts and Coolant Hose for Medium/Heavy-Duty Trucks (2001 & Newer)

 Medium & Heavy-Duty Trucks
(2001 & Newer)

Application	Mfr. Part No.	Our No.	Application	Mfr. Part No.	Our No.
GMC - Continued			GMC - Continued		
2002 - Continued			2001 - Continued		
Caterpillar 3126 Diesel - Continued			GM V-8 5.7 L		
T5500; T6500; T7500; T8500 - Continued			W3500; W4500		
Tensioner Assy.	15999618	38578	Belt - Fan, Alt., P.S. & A.C.	8971106400	♣K061010HD
Tensioner Pulley	15999618	36091	Tensioner Assy. - Fan, Alt., P.S. & A.C.	8971619590	38528
Hose - Upper - Eng. To Rad.		22706	Hose - Upper - Eng. To Rad.		22731
Hose - Lower - Eng. To Rad.		22705	Hose - Lower - Eng. To Rad.		22732
GM V-8 5.7 L			GM V-8 8.1 L		
W3500; W4500			C5500; C6500; C7500; C8500		
Belt - Fan, Alt., P.S. & A.C.	8971106400	♣K061010HD	Belt - Fan, Alt., P.S. & A.C.	15768485	♣K071247HD
Tensioner Assy. - Fan, Alt., P.S. & A.C.	8971619590	38528	Belt - Fan, Alt. & P.S.; W/O A.C.	15021740	♣K071056HD
Hose - Upper - Eng. To Rad.		22731	Belt - Fan & Air Compr.	15060753	♣K040762HD
Hose - Lower - Eng. To Rad.		22732	Tensioner Assy. - Fan, Alt., P.S. & A.C.	15021742	38256
GM V-8 8.1 L			Tensioner Assy. - Fan & Air Compr.		
C5500; C6500; C7500; C8500			Tensioner Pulley - Fan, Alt., P.S. & A.C.		
Belt - Fan, Alt., P.S. & A.C.	15768485	♣K071247HD	Tensioner Pulley - Fan, Alt., P.S. & A.C.		
Belt - Fan, Alt. & P.S.; W/O A.C.	15021740	♣K071056HD	Tensioner Pulley - Fan & Air Compr.		
Belt - Fan & Air Compr.	15060753	♣K040762HD	Hose - Upper - Eng. To Rad.		
Tensioner Assy. - Fan, Alt., P.S. & A.C.	15021742	38256	Hose - Lower - Eng. To Rad.		
Tensioner Assy. - Fan & Air Compr.	15001551	38261			
Tensioner Pulley - Fan, Alt., P.S. & A.C.	15021742	38033			
Tensioner Pulley - Fan & Air Compr.	15001551	38006			
Hose - Upper - Eng. To Rad.		22678			
Hose - Lower - Eng. To Rad.		22679			
Isuzu 4HE1-TC Diesel			Isuzu 4HE1-TC Diesel		
W3500; W4500; W5500			W3500; W4500; W5500		
Belt - Fan & Alt.	8971801810	Ⓜ♣9415HD	Belt - Fan & Alt.	8971801810	Ⓜ♣9415HD
Belt - Alt. & A.C.	8971801830	♣9610HD	Belt - Alt. & A.C.	8971801830	♣9610HD
Hose - Upper - Eng. To Rad.		23096	Hose - Upper - Eng. To Rad.		23096
Hose - Lower - Eng. To Rad.		23095	Hose - Lower - Eng. To Rad.		23095
Isuzu 6HK1-TC Diesel			Isuzu 6HK1-TC Diesel		
T5500; T6500; T7500; T8500			T5500; T6500; T7500; T8500		
Belt - Fan & Alt.	94395171	ⓂTR22461	Belt - Fan & Alt.	94395171	ⓂTR22461
Belt - A.C.	94395172	TR22434	Belt - A.C.	94395172	TR22434
Hose - Upper - Eng. To Rad.		22733	Hose - Upper - Eng. To Rad.		22733
Hose - Lower - Eng. To Rad.		22734	Hose - Lower - Eng. To Rad.		22734
W5500; WT5500			W5500		
Belt - Fan & Alt.	94395171	TR22461	Belt - Fan & Alt.	94395171	TR22461
Belt - A.C.	94395172	TR22434	Belt - A.C.	94395172	TR22434
Hose - Upper - Eng. To Rad.		22733	Hose - Upper - Eng. To Rad.		22733
Hose - Lower - Eng. To Rad.		22734	Hose - Lower - Eng. To Rad.		22734
2001			2012		
Caterpillar 3126 Diesel			Hino J08E-VB Diesel (Canada)		
C5500; C6500; C7500; C8500			358		
Belt - Fan & Alt.; W/O A.C.	15670937	♣K070705HD	Belt - Fan & Alt.	SZ91045377	♣K100563HD
Belt - Fan, Alt. & A.C.	15690236	♣K070733HD	Belt - A.C.	SZ91045354	♣9395HD
Belt - W.P.	0366775	♣9341HD	Hino J08E-VB Diesel		
Tensioner Assy.	7E3999	38509	338		
Idler Pulley	89022559	36096	Belt - Fan & Alt.	SZ91045377	♣K100563HD
Tensioner Pulley	7E3999	36091	Belt - A.C.	SZ91045354	♣9395HD
Hose - Upper - Eng. To Rad.; W/Conventional Hood		22032	Hino J08E-VC Diesel (Canada)		
Hose - Upper - Eng. To Rad.; W/High Visibility Hood		22664	198		
Hose - Lower - Eng. To Rad.		21985	Belt - Fan & Alt.	SZ91045377	♣K100563HD
Hose - Heater Inlet		28442	Belt - A.C.	SZ91045354	♣9395HD
Hose - Heater Outlet		28441	Hino J08E-VC Diesel		
T5500; T6500; T7500; T8500			258LP; 268		
Belt - Fan & Alt.; W/O A.C.	15149560	♣K070553HD	Belt - Fan & Alt.	SZ91045377	♣K100563HD
Belt - Fan, Alt. & A.C.	15985715	♣K070677HD	Belt - A.C.	SZ91045354	♣9395HD
Belt - Hub & W.P.	0366775	♣9341HD			
Tensioner Assy.	15999618	38578			
Tensioner Pulley	15999618	36091			
Hose - Upper - Eng. To Rad.		22706			
Hose - Lower - Eng. To Rad.		22705			

♣Standard Belt Available.

ⓂTwo Required.

Belts and Coolant Hose for Medium/Heavy-Duty Trucks (2001 & Newer)

Application	Mfr. Part No.	Our No.	Application	Mfr. Part No.	Our No.
Hino - Continued			Hino - Continued		
2011			2010 - Continued		
Hino J08E-VB Diesel (Canada)			Hino J08E-TW Diesel (Canada)		
358			358		
Belt - Fan & Alt.	SZ91045377	♣K100563HD	Belt - Fan	SZ91045306	K080539HD
Belt - A.C.	SZ91045354	♣9395HD	Hose - Upper		23995
			Hose - Lower		23988
Hino J08E-VB Diesel			Hino J08E-TW Diesel		
338			338		
Belt - Fan & Alt.	SZ91045377	♣K100563HD	Belt - Fan	SZ91045306	K080539HD
Belt - A.C.	SZ91045354	♣9395HD	Hose - Upper		23995
			Hose - Lower		23988
Hino J08E-VC Diesel (Canada)			2009		
198			Hino J05D-TF Diesel (Canada)		
Belt - Fan & Alt.	SZ91045377	♣K100563HD	155		
Belt - A.C.	SZ91045354	♣9395HD	Belt - Fan & Alt.	SZ91045307	②♣9463HD
			Belt - A.C.	900145569A	A38
Hino J08E-VC Diesel			Hose - Upper		23996
238; 258ALP; 258LP; 268			Hose - Lower		23989
Belt - Fan & Alt.	SZ91045377	♣K100563HD			
Belt - A.C.	SZ91045354	♣9395HD	Hino J05D-TF Diesel		
			145; 165		
2010			Belt - Fan & Alt.	SZ91045307	②♣9463HD
Hino J05D-TF Diesel (Canada)			Belt - A.C.	900145569A	A38
155			Hose - Upper		23996
Belt - Fan & Alt.	SZ91045307	②♣9463HD	Hose - Lower		23989
Belt - A.C.	SZ91045266	A38			
Hose - Upper		23996	185		
Hose - Lower		23989	Belt - Fan & Alt.	SZ91049219	②♣9463HD
			Belt - A.C.	SZ91045266	A38
Hino J05D-TF Diesel			Hose - Upper		23996
145			Hose - Lower		23989
Belt - Fan & Alt.	SZ91045307	②♣9463HD	Hino J08E-TV Diesel (Canada)		
Belt - A.C.	SZ91045266	A38	338		
Hose - Upper		23996	Belt - Fan	SZ91045306	K080539HD
Hose - Lower		23989	Belt - A.C.	SZ91045354	♣9395HD
			Hose - Upper		23995
165; 185			Hose - Lower		23988
Belt - Fan & Alt.	SZ91049219	②♣9463HD	Hino J08E-TV Diesel		
Belt - A.C.	SZ91045266	A38	238		
Hose - Upper		23996	Belt - Fan & Alt.	SZ91045306	K080539HD
Hose - Lower		23989	Belt - A.C.	SZ91045354	♣9395HD
			Hose - Upper		23995
Hino J08E-TV Diesel (Canada)			Hose - Lower		23988
338			Hino J08E-TV Diesel		
Belt - Fan	SZ91045306	K080539HD	238		
Hose - Upper		23995	Belt - Fan & Alt.	SZ91045306	K080539HD
Hose - Lower		23988	Belt - A.C.	SZ91045354	♣9395HD
			Hose - Upper		23995
Hino J08E-TV Diesel			Hose - Lower		23988
238			258ALP		
Belt - Fan & Alt.	SZ91045306	K080539HD	Belt - Fan & Alt.	SZ91045306	K080539HD
Belt - A.C.	SZ91045354	♣9395HD	Hose - Upper		23995
Hose - Upper		23995	Hose - Lower		23988
Hose - Lower		23988	258LP		
			Belt - Fan & Alt.	SZ91045306	K080539HD
258ALP			Belt - A.C.	SZ91045354	♣9395HD
Belt - Fan & Alt.	SZ91045306	K080539HD	Hose - Upper		23995
Hose - Upper		23995	Hose - Lower		23988
Hose - Lower		23988	268		
			Belt - Fan & Alt.	SZ91045306	K080539HD
258LP			Hose - Upper		23995
Belt - Fan & Alt.	SZ91045306	K080539HD	Hose - Lower		23988
Belt - A.C.	SZ91045354	♣9395HD	Hino J08E-TW Diesel (Canada)		
Hose - Upper		23995	358		
Hose - Lower		23988	Belt - Fan	SZ91045306	K080539HD
			Hose - Upper		23995
268			Hose - Lower		23988
Belt - Fan & Alt.	SZ91045306	K080539HD	Hino J08E-TW Diesel		
Hose - Upper		23995	338		
Hose - Lower		23988	Belt - Fan	SZ91045306	K080539HD

Medium & Heavy-Duty Trucks
(2001 & Newer)

♣Standard Belt Available.

②Two Required.

Belts and Coolant Hose for Medium/Heavy-Duty Trucks (2001 & Newer)

Medium & Heavy-Duty Trucks
(2001 & Newer)

Application	Mfr. Part No.	Our No.	Application	Mfr. Part No.	Our No.
Hino - Continued			Hino - Continued		
2009 - Continued			2007 - Continued		
Hino J08E-TW Diesel - Continued			Hino J08E-TB Diesel		
338 - Continued			338		
Belt - A.C.	SZ91045354	♣9395HD	Belt - Fan & Alt.	900145548A	♣K080514HD
Hose - Upper		23995	Belt - A.C.	908611000	♣9400HD
Hose - Lower		23988	Tensioner Assy. - Fan & Alt.	16630E0250	38659
2008			Hose - Upper		23993
Hino J05D-TF Diesel			Hose - Lower		23987
145			2006		
Belt - Fan & Alt.	SZ91049219	②♣9463HD	Hino J05D-TA Diesel		
Belt - A.C.	900145569A	A38	145; 165; 185		
Hose - Upper		23996	Belt - Fan & Alt.	900145550A	②A43
Hose - Lower		23989	Belt - A.C.	900145569A	A38
165			Hose - Upper		23997
Belt - Fan & Alt.	SZ91045307	②♣9463HD	Hose - Lower		23991
Belt - A.C.	900145569A	♣9380HD	Hino J08E-TA Diesel (Canada)		
Hose - Upper		23996	308		
Hose - Lower		23989	Belt - Fan & Alt.	900145548A	♣K080514HD
185			Belt - A.C.	908611000	♣9400HD
Belt - Fan & Alt.	SZ91045307	♣9463HD	Tensioner Assy. - Fan & Alt.	16630E0250	38659
Belt - A.C.	900145569A	A38	Hose - Upper		23993
Hose - Upper		23996	Hose - Lower		23987
Hose - Lower		23989	Hino J08E-TA Diesel		
Hino J08E-TV Diesel (Canada)			238; 258LP; 268		
308			Belt - Fan & Alt.	900145548A	♣K080514HD
Hose - Upper		23995	Belt - A.C.	908611000	♣9400HD
Hose - Lower		23988	Tensioner Assy. - Fan & Alt.	16630E0250	38659
Hino J08E-TV Diesel			Hose - Upper		23993
238; 258LP			Hose - Lower		23987
Belt - Fan & Alt.	SZ91045306	K080539HD	Hino J08E-TB Diesel		
Belt - A.C.	SZ91045354	♣9395HD	338		
Hose - Upper		23995	Belt - Fan & Alt.	900145548A	♣K080514HD
Hose - Lower		23988	Belt - A.C.	908611000	♣9400HD
268			Tensioner Assy. - Fan & Alt.	16630E0250	38659
Belt - Fan & Alt.	SZ91045306	K080539HD	Hose - Upper		23993
Hose - Upper		23995	Hose - Lower		23987
Hose - Lower		23988	2005		
Hino J08E-TW Diesel (Canada)			Hino J05D-TA Diesel		
358			145; 165; 185		
Belt - Fan	SZ91045306	K080539HD	Belt - Fan & Alt.	900145550A	②A43
Hose - Upper		23995	Belt - A.C.	900145569A	A38
Hose - Lower		23988	Hose - Upper		23997
Hino J08E-TW Diesel			Hose - Lower		23991
338			Hino J08E-TA Diesel (Canada)		
Belt - Fan	SZ91045306	K080539HD	308		
Hose - Upper		23995	Belt - Fan & Alt.	900145548A	♣K080514HD
Hose - Lower		23988	Belt - A.C.	908611000	♣9400HD
2007			Tensioner Assy. - Fan & Alt.	16630E0250	38659
Hino J05D-TA Diesel			Hose - Upper		23993
145; 165; 185			Hose - Lower		23987
Belt - Fan & Alt.	900145550A	②A43	Hino J08E-TA Diesel		
Belt - A.C.	900145569A	A38	238; 268		
Hose - Upper		23997	Belt - Fan & Alt.	900145548A	♣K080514HD
Hose - Lower		23991	Belt - A.C.	908611000	♣9400HD
Hino J08E-TA Diesel			Tensioner Assy. - Fan & Alt.	16630E0250	38659
238; 258LP; 268; 308			Hose - Upper		23993
Belt - Fan & Alt.	900145548A	♣K080514HD	Hose - Lower		23987
Belt - A.C.	908611000	♣9400HD	Hino J08E-TB Diesel		
Tensioner Assy. - Fan & Alt.	16630E0250	38659	338		
Hose - Upper		23993	Belt - Fan & Alt.	900145548A	♣K080514HD
Hose - Lower		23987	Belt - A.C.	908611000	♣9400HD

♣Standard Belt Available.

②Two Required.

Belts and Coolant Hose for Medium/Heavy-Duty Trucks (2001 & Newer)

Application	Mfr. Part No.	Our No.	Application	Mfr. Part No.	Our No.
Hino - Continued			Hino - Continued		
2005 - Continued			2001 - Continued		
Hino J08E-TB Diesel - Continued			Hino J08C-TP Diesel		
338 - Continued			FD2220; FD2320; FE2620; FF3020; SG3320		
Tensioner Assy. - Fan & Alt.	16630E0250	38659	Belt - Fan & Alt.	900145421A	②TR20451
Hose - Upper		23993	Belt - A.C.	908611000	♣9400HD
Hose - Lower		23987	Hose - Upper		23994
2004			Hose - Lower; W/Auto. Trans.		
Hino J05C-TD Diesel			Hose - Lower; W/Man. Trans.		
FA1517; FB1817			Hino J08C-TR Diesel		
Belt - Fan & Alt.	900145286A	②TR22455	SG3325		
Belt - A.C.	908611000	♣9400HD	Belt - Fan & Alt.		
Hose - Upper - Eng. To Rad.		22727	Belt - A.C.		
Hose - Lower - Eng. To Rad.		22728	Hose - Upper		
Hino J08C-TP Diesel			Hose - Lower; W/Auto. Trans.		
FD2220; FD2320; FE2620			Hose - Lower; W/Man. Trans.		
Belt - Fan & Alt.	900145286A	②TR22474	International/Navistar		
Belt - A.C.	908611000	♣9400HD	2016		
Hose - Upper		23994	Cummins ISX15 Diesel		
Hose - Lower; W/Auto. Trans.		23990	ProStar Series		
Hose - Lower; W/Man. Trans.		23986	Belt - Serpentine - Fan		
FF3020; SG3320			Belt - Serpentine - A.C.		
Hose - Upper		23994	Tensioner Assy. - Fan		
Hose - Lower; W/Auto. Trans.		23990	Tensioner Assy. - A.C.		
Hose - Lower; W/Man. Trans.		23986	Idle Pulley - A.C.		
Hino J08C-TR Diesel			Hose - Lower - Pipe To Eng.; Cut at 7"		
SG3325			Hose - Lower - Pipe To Rad.; Cut at 8"		
Hose - Upper		23994	Hose - Turbo To Pipe (Hot Side)		
Hose - Lower; W/Auto. Trans.		23990	Hose - Pipe To Intercooler (Hot Side)		
Hose - Lower; W/Man. Trans.		23986	International/Navistar N9 Diesel		
2003 - 2002			WorkStar 7500		
Hino J05C-TD Diesel			Belt - Fan		
FA1517; FB1817			Hose - Upper - Eng. To Pipe; Cut at 7"		
Belt - Fan & Alt.	900145286A	②TR22455	Hose - Lower - Pipe To Cooler; Cut at 5"		
Belt - A.C.	908611000	♣9400HD	Hose - Lower - Oil Cooler To Pipe; Cut at 5"		
Hose - Upper - Eng. To Rad.		22727	Hose - Lower - Eng. To Rad.		
Hose - Lower - Eng. To Rad.		22728	International/Navistar N10 Diesel		
Hino J08C-TP Diesel			WorkStar 7500		
FD2220; FD2320; FE2620			Belt - Fan		
Belt - Fan & Alt.	900145286A	②TR22474	Hose - Upper - Eng. To Pipe; Cut at 7"		
Belt - A.C.	908611000	♣9400HD	Hose - Lower - Pipe To Cooler; Cut at 5"		
Hose - Upper		23994	Hose - Lower - Oil Cooler To Pipe; Cut at 5"		
Hose - Lower; W/Auto. Trans.		23990	Hose - Lower - Eng. To Rad.		
Hose - Lower; W/Man. Trans.		23986	International/Navistar N13 Diesel		
FF3020; SG3320			ProStar Series		
Belt - Fan & Alt.		②TR20451	Belt - Serpentine - Alt. & A.C.		
Belt - A.C.		♣9400HD	Hose - Lower - Pipe To Eng.; Cut at 6"		
Hose - Upper		23994	Hose - Pipe To Intercooler (Hot Side)		
Hose - Lower; W/Auto. Trans.		23990	Hose - Turbo To Pipe (Hot Side)		
Hose - Lower; W/Man. Trans.		23986	2015		
Hino J08C-TR Diesel			Cummins ISX15 Diesel		
SG3325			9900i; LoneStar; PayStar 5900i		
Hose - Upper		23994	Tensioner Assy. - Fan & W.P.		
Hose - Lower; W/Auto. Trans.		23990	Tensioner Assy. - A.C.		
Hose - Lower; W/Man. Trans.		23986	ProStar Series		
2001			Belt - Serpentine - Fan		
Hino J05C-TD Diesel			Belt - Serpentine - A.C.		
FA1517; FB1817			Tensioner Assy. - Fan		
Belt - Fan & Alt.	900145421A	②TR20451	Tensioner Assy. - A.C.		
Belt - A.C.	908611000	♣9400HD	Idle Pulley - A.C.		
Hose - Upper - Eng. To Rad.		22727			
Hose - Lower - Eng. To Rad.		22728			

Medium & Heavy-Duty Trucks
(2001 & Newer)

②Two Required.
♣Cut to Fit.

♣Standard Belt Available.

Belts and Coolant Hose for Medium/Heavy-Duty Trucks (2001 & Newer)

**Medium & Heavy-Duty Trucks
(2001 & Newer)**

Application	Mfr. Part No.	Our No.
International/Navistar - Continued		
2015 - Continued		
International/Navistar MaxxForce 7 Diesel		
TerraStar		
Belt - Serpentine	1889037C1	K081047HD
Tensioner Assy.	1833688C2	38556
International/Navistar MaxxForce DT Diesel		
DuraStar 4300; DuraStar 4400		
Belt - Serpentine	1879843C1	▲K100885HD
Tensioner Assy.	1873217C2	38634
2014		
Cummins ISX15 Diesel		
ProStar Series		
Belt - Serpentine - Fan	4019203C1	▲K120852HD
Belt - Serpentine - A.C.	3999452C1	▲K060631HD
Tensioner Assy. - Fan	4299052	38587
Tensioner Assy. - A.C.	2891940	38610
Idler Pulley - A.C.	3682229	36223
Hose - Lower - Rad. To Pipe		≈<24240
Hose - Lower - Pipe To Eng.		≈<24240
Hose - Return - Pump To Tank	3989653C1	DEF7023
Hose - Pressure - Pump To Injector	3990139C1	DEF7037
Hose - Turbo To Pipe (Hot Side)		26203
Hose - Pipe To Intercooler (Hot Side)		26203
International/Navistar MaxxForce 7 Diesel		
TerraStar		
Belt - Serpentine	1889037C1	K081047HD
Tensioner Assy.	1833688C2	38556
International/Navistar MaxxForce 9 Diesel		
WorkStar 7400		
Belt - A.C. & Alt.	1847710C1	K100814HD
Belt - Fan	1888570C1	▲K080855HD
Hose - Upper - Eng. To Pipe; Cut at 7"		≈<24236
Hose - Upper - Pipe To Rad.; Cut at 7"		≈<28200
Hose - Lower - Eng. To Pipe; Cut at 6"		≈<28207
Hose - Lower - Pipe To Cooler; Cut at 5"		≈<24836
Hose - Lower - Oil Cooler To Pipe; Cut at 5"		≈<24836
Hose - Lower - Pipe To Rad.; Cut at 6"		≈<28207
Hose - Pipe To Intercooler (Hot Side)		26200
WorkStar 7500		
Belt - Alt. & A.C.	1847710C1	K100814HD
Belt - Fan	1888570C1	▲K080855HD
Tensioner Assy. - Alt. & A.C.	1873217C1	38634
Idler Pulley - Fan	1841930C1	36164
Idler Pulley - Alt. & A.C.	1841930C1	36164
Hose - Upper - Eng. To Pipe; Cut at 7"		≈<24236
Hose - Upper - Pipe To Rad.; Cut at 7"		≈<28200
Hose - Lower - Eng. To Pipe; Cut at 6"		≈<28207
Hose - Lower - Pipe To Cooler; Cut at 5"		≈<24836
Hose - Lower - Oil Cooler To Pipe; Cut at 5"		≈<24836
Hose - Lower - Pipe To Rad.; Cut at 6"		≈<28207
Hose - Lower - Pipe To Intercooler (Hot Side)		26200
International/Navistar MaxxForce 10 Diesel		
WorkStar 7400		
Belt - Alt. & A.C.	1847710C1	K100814HD
Belt - Fan	1888570C1	▲K080855HD
Hose - Upper - Eng. To Pipe; Cut at 7"		≈<24236
Hose - Upper - Pipe To Rad.; Cut at 7"		≈<28200
Hose - Lower - Eng. To Pipe; Cut at 6"		≈<28207
Hose - Lower - Pipe To Cooler; Cut at 5"		≈<24836
Hose - Lower - Oil Cooler To Pipe; Cut at 5"		≈<24836
Hose - Lower - Pipe To Rad.; Cut at 6"		≈<28207
Hose - Lower - Pipe To Intercooler (Hot Side)		26200
WorkStar 7500		
Belt - Alt. & A.C.	1847710C1	K100814HD
Belt - Fan	1888570C1	▲K080855HD

Application	Mfr. Part No.	Our No.
International/Navistar - Continued		
2014 - Continued		
International/Navistar MaxxForce 10 Diesel - Continued		
WorkStar 7500 - Continued		
Tensioner Assy. - Alt. & A.C.	1873217C1	38634
Idler Pulley - Fan	1841930C1	36164
Idler Pulley - Alt. & A.C.	1841930C1	36164
Hose - Upper - Eng. To Pipe; Cut at 7"		≈<24236
Hose - Upper - Pipe To Rad.; Cut at 7"		≈<28200
Hose - Lower - Eng. To Pipe; Cut at 6"		≈<28207
Hose - Lower - Pipe To Cooler; Cut at 5"		≈<24836
Hose - Lower - Oil Cooler To Pipe; Cut at 5"		≈<24836
Hose - Lower - Pipe To Rad.; Cut at 6"		≈<28207
International/Navistar MaxxForce DT Diesel		
DuraStar 4300		
Belt - Fan, Alt. & A.C.	1879845C1	K100877HD
Tensioner Assy.	1873217C2	38634
Idler Pulley	1841930C1	36164
Hose - Upper		23794
Hose - Lower - Rad. To Pipe		24060
Hose - Lower - Pipe To Eng.		24075
Hose - Turbo To Pipe (Hot Side)		26200
Hose - Pipe To Intercooler (Hot Side)		26203
2013		
Cummins ISX15 Diesel		
9900i		
Belt - Fan	3998047C1	▲K120915HD
Belt - A.C.	3999453C1	▲K060628HD
Tensioner Assy. - Fan	2871293	38587
Tensioner Assy. - A.C.	2891940	38610
Idler Pulley - A.C.	3682229	36223
Hose - Lower		≈<20172
Hose - Turbo To Pipe (Hot Side)		26203
Hose - Pipe To Intercooler (Hot Side)		26203
ProStar Series		
Belt - Fan	3817452C1	K120870HD
Belt - A.C.	3565412C1	▲K060637HD
Tensioner Assy. - Fan	2871293	38587
Tensioner Assy. - A.C.	2891940	38610
Idler Pulley	3682229	36223
Hose - Lower - Rad. To Pipe		≈<24240
Hose - Lower - Pipe To Eng.		≈<24240
Hose - Pressure - Pump To Injector	3990139C1	DEF7037
Hose - Suction - Tank To Pump	3989653C1	DEF7023
Hose - Turbo To Pipe (Hot Side)		26203
Hose - Pipe To Intercooler (Hot Side)		26203
International/Navistar MaxxForce 7 Diesel		
TerraStar		
Belt - Serpentine	1889037C1	K081047HD
Tensioner Assy.	1833688C2	38556
International/Navistar MaxxForce 9 Diesel		
DuraStar 4300		
Hose - Upper		23794
WorkStar 7500		
Belt - Fan	1888570C1	▲K080855HD
Belt - Alt. & A.C.	1847710C1	K100814HD
Tensioner Assy. - Alt. & A.C.	1873217C1	38634
Idler Pulley - Fan	1841930C1	36164
Idler Pulley - Alt. & A.C.	1841930C1	36164
International/Navistar MaxxForce 10 Diesel		
WorkStar 7500		
Belt - Fan	1888570C1	▲K080855HD
Belt - Alt. & A.C.	1847710C1	K100814HD
Tensioner Assy. - Alt. & A.C.	1873217C1	38634
Idler Pulley - Fan	1841930C1	36164

▲Standard Belt Available.

≈<Cut to Fit.

Belts and Coolant Hose for Medium/Heavy-Duty Trucks (2001 & Newer)

Medium & Heavy-Duty Trucks
(2001 & Newer)

Application	Mfr. Part No.	Our No.	Application	Mfr. Part No.	Our No.
International/Navistar - Continued			International/Navistar - Continued		
2013 - Continued			2012 - Continued		
International/Navistar MaxxForce 10 Diesel - Continued			International/Navistar MaxxForce 9 Diesel - Continued		
WorkStar 7500 - Continued			WorkStar 7500 - Continued		
Idler Pulley - Alt. & A.C.	1841930C1	36164	Hose - Upper		≈21135
International/Navistar MaxxForce 11 Diesel			International/Navistar MaxxForce 11 Diesel		
PayStar 5900i			PayStar 5600i; PayStar 5900i		
Belt - Serpentine - Fan	3815648C1	♣K080776HD	Belt - Serpentine - Fan	3815648C1	♣K080776HD
Belt - Serpentine - A.C.	3664150C1	K080794HD	Belt - Serpentine - A.C.	3664150C1	K080794HD
International/Navistar MaxxForce 13 Diesel			International/Navistar MaxxForce 13 Diesel		
LoneStar			ProStar Series		
Belt - Fan	3861887C1	♣K080733HD	Belt - Alt. & A.C.	3664150C1	K080794HD
Belt - Alt.	3664150C1	K080794HD	Hose - Turbo To Pipe (Hot Side)		26200
Hose - Upper - Pipe To Eng.		≈21891	Hose - Pipe To Intercooler (Hot Side)		26200
Hose - Pipe To Pipe (Cold Side)	1140336	26203	TranStar 8600		
Hose - Pipe To Engine (Cold Side)	1140336	26203	Hose - Lower - Rad. To Pipe		21891
Hose - Intercooler To Pipe (Cold Side)	1140336	26203	Hose - Lower - Pipe To Eng.		21135
ProStar Series			WorkStar 7600		
Belt - Alt. & A.C.	3664150C1	K080794HD	Belt - Alt. & W.P.	3664150C1	K080794HD
WorkStar 7600			Belt - Fan	3815648C1	♣K080776HD
Belt - Fan	3815648C1	♣K080776HD	Hose - Upper - Rad. To Pipe		≈28200
Belt - Alt. & A.C.	3664150C1	K080794HD	Hose - Upper - Pipe To Eng.		≈28200
Hose - Lower - Rad. To Pipe		≈20987	Hose - Lower - Rad. To Pipe		≈28212
Hose - Lower - Pipe To Cooler		≈20987	Hose - Lower - Pipe To Eng.		≈24840
Hose - Lower - Cooler To Pipe		≈24440	International/Navistar MaxxForce 15 Diesel		
Hose - Lower - Pipe To Eng.		≈24440	9900i		
Hose - Intercooler To Pipe (Cold Side)		26203	Tensioner Assy. - A.C.	2891940	38610
Hose - Pipe To Engine (Cold Side)		26203	Idler Pulley - A.C.	3682229	36223
International/Navistar MaxxForce 15 Diesel			International/Navistar MaxxForce DT Diesel		
ProStar Series			DuraStar 4300		
Belt - Serpentine - Fan	7078754C1	♣K120919HD	Belt - Fan	1842455C1	K080723HD
Belt - Serpentine - A.C.	1894698C1	K060703	Tensioner Assy.	1841760C1	38620
International/Navistar MaxxForce DT Diesel			Hose - Upper		24074
DuraStar 4300			Hose - Lower		20731
Belt - Fan, Alt. & A.C.	1879845C1	K100877HD	DuraStar 4400		
Tensioner Assy.	1873217C2	38634	Belt - Fan	1879845C1	K100877HD
Idler Pulley	1841930C1	36164	Tensioner Assy. - Fan	1873217C2	38634
Hose - Upper		23794	Idler Pulley	1841930C1	36164
Hose - Lower - Rad. To Pipe		24060	Hose - Upper		23794
Hose - Lower - Pipe To Eng.		24075	Hose - Lower		24060
Hose - Turbo To Pipe (Hot Side)		26200	2011		
Hose - Pipe To Intercooler (Hot Side)		26203	Caterpillar C13 Diesel		
2012			9200i		
Cummins ISX15 Diesel			Belt - Alt.		
ProStar Series			Tensioner Assy. - Alt.		
Tensioner Assy. - A.C.	2891940	38610	Tensioner Assy. - Fan & A.C.		
Idler Pulley - A.C.	3682229	36223	Idler Pulley - Alt. (Upper)		
International/Navistar MaxxForce 7 Diesel			Idler Pulley - Alt. (Lower)		
TerraStar			Idler Pulley - Fan & A.C. (Grooved)		
Belt - Serpentine	1889037C1	K081047HD	Idler Pulley - Fan & A.C. (Smooth)		
Tensioner Assy.	1833688C2	38567	Hose - Upper - Rad. To Pipe		
Idler Pulley	1832710C1	36351	Hose - Upper - Pipe To Eng.		
Hose - Lower		24059	Hose - Lower - Rad. To Pipe		
International/Navistar MaxxForce 9 Diesel			Hose - Lower - Pipe To Eng.		
WorkStar 7400			≈24440		
Belt - Serpentine	1847715C1	♣K100976HD	Cummins ISM Diesel		
Tensioner Assy.	1873217C2	38634	PayStar 5600i		
WorkStar 7500			Belt - Serpentine - A.C.		
Belt - Fan	1888570C1	♣K080855HD	Belt - Serpentine - Alt.		
Belt - Alt. & A.C.	1847710C1	K100814HD	Tensioner Assy. - Alt.		
Tensioner Assy. - Alt. & A.C.	1873217C1	38634	Tensioner Assy. - A.C.		
Idler Pulley - Fan	1841930C1	36164	Idler Pulley - Alt.		
Idler Pulley - Alt. & A.C.	1841930C1	36164	Idler Pulley - A.C.		

♣Standard Belt Available.

≈Cut to Fit.

Belts and Coolant Hose for Medium/Heavy-Duty Trucks (2001 & Newer)

Medium & Heavy-Duty Trucks
(2001 & Newer)

Application	Mfr. Part No.	Our No.	Application	Mfr. Part No.	Our No.
International/Navistar - Continued			International/Navistar - Continued		
2011 - Continued			2011 - Continued		
Cummins ISX Diesel			International/Navistar MaxxForce 10 Diesel - Continued		
9200i			WorkStar 7400 - Continued		
Belt - A.C.	3565412C1	♣K060637HD	Idler Pulley - Fan	1841930C1	36164
Belt - Fan	3817452C1	K120870HD	Hose - Upper		≈<21135
Tensioner Assy. - A.C.	3104149	38610	Hose - Lower		≈<21135
Tensioner Assy. - Fan	2871293	38587	WorkStar 7500		
Idler Pulley - A.C.	3682229	36223	Tensioner Assy.	1873217C1	38634
Hose - Upper - Rad. To Pipe		≈<21135	Hose - Upper - Rad. To Pipe		21135
Hose - Upper - Pipe To Pipe		≈<24440	Hose - Lower		21135
Hose - Upper - Pipe To Eng.		≈<21891			
Hose - Lower - Rad. To Pipe		≈<24440	International/Navistar MaxxForce 11 Diesel		
LoneStar			TranStar 8600		
Belt - A.C.	3565412C1	♣K060637HD	Belt - Fan	3815648C1	♣K080776HD
Belt - Fan	3833748C1	K120895HD	Hose - Lower - Rad. To Pipe		≈<21891
Tensioner Assy. - A.C.	3104149	38610	Hose - Lower - Pipe To Eng.		≈<21135
Tensioner Assy. - Fan	2871293	38587			
Idler Pulley - A.C.	3682229	36223	International/Navistar MaxxForce 13 Diesel		
Hose - Upper - Rad. To Pipe		≈<21135	ProStar Series		
Hose - Upper - Pipe To Eng.		≈<21135	Belt - Alt. & A.C.	3664150C1	K080794HD
Hose - Lower - Rad. To Pipe		≈<21891	TranStar 8600		
Hose - Lower - Pipe To Eng.		≈<21891	Belt - Fan	3815648C1	♣K080776HD
ProStar Series			Hose - Lower - Rad. To Pipe		≈<21891
Belt - Fan, Alt. & W.P.	3817452C1	K120870HD	Hose - Lower - Pipe To Eng.		≈<21135
Belt - A.C. - From W.P.	3565412C1	♣K060637HD	WorkStar 7600		
Tensioner Assy. - A.C.	3104149	38610	Belt - Alt.	3815648C1	♣K080776HD
Idler Pulley - A.C.	3682229	36223	Belt - Fan	3625293C2	♣K080780HD
Hose - Upper - Rad. To Pipe		≈<24440			
Hose - Upper - Pipe To Pipe		≈<24440	International/Navistar MaxxForce 15 Diesel		
Hose - Upper - Pipe To Eng.		≈<21891	PayStar 5900i		
Hose - Lower - Rad. To Pipe		≈<24440	Belt - A.C.		K060703
Hose - Lower - Pipe To Eng.		≈<24440			
International/Navistar MaxxForce 7 Diesel			International/Navistar MaxxForce DT Diesel		
DuraStar 4300			DuraStar 4300		
Belt - Serpentine	1889037C1	K081047HD	Belt - Fan	1847708C1	K100870HD
Tensioner Assy. - Fan	1833688C2	38556	Tensioner Assy. - Fan	1873217C2	38634
Idler Pulley - Fan	1832710C1	36351	Idler Pulley - Fan	1841930C1	36164
Hose - Upper		23795	Hose - Upper		23794
Hose - Lower		23793	Hose - Lower		≈<21302
TerraStar			DuraStar 4400		
Belt - Serpentine	1889037C1	K081047HD	Belt - Fan	1879845C1	K100877HD
Tensioner Assy.	1833688C2	38556	Tensioner Assy.	1873217C1	38634
Idler Pulley - Fan	1832710C1	36351	Idler Pulley	1841930C1	36164
Hose - Upper		≈<21891	Hose - Upper		23794
Hose - Lower		24059	Hose - Lower - Rad. To Pipe		≈<21302
			Hose - Lower - Pipe To Eng.		24075
International/Navistar MaxxForce 9 Diesel			WorkStar 7500		
WorkStar 7400			Belt - Fan	1847748C1	K100983HD
Belt - Fan	1888570C1	♣K080855HD	Tensioner Assy.	1873217C1	38634
Belt - Alt. & W.P.; W/A.C.	1847716C1	K100822HD	Idler Pulley	1841930C1	36164
Belt - Alt. & W.P.; W/O A.C.	1888656C1	K100706HD	Hose - Upper		21135
Tensioner Assy. - Alt. & W.P.	1873217C2	38634	Hose - Lower		21135
Idler Pulley - Alt. & W.P. (Upper)	1841930C1	36164			
Idler Pulley - Fan	1841930C1	36164			
Hose - Upper		≈<21135	2010		
Hose - Lower		≈<21135	Cummins ISM Diesel		
WorkStar 7500			PayStar 5600i		
Tensioner Assy.	1873217C1	38634	Belt - Serpentine - A.C.		♣K060516HD
Hose - Upper - Rad. To Pipe		21135	Belt - Serpentine - Alt.		♣K080797HD
Hose - Lower		21135	Tensioner Assy. - Alt.	2871294	38622
			Tensioner Assy. - A.C.	3102888	38505
International/Navistar MaxxForce 10 Diesel			Idler Pulley - Alt.	3400883	36308
WorkStar 7400			Idler Pulley - A.C.	3104139	36225
Belt - Fan	1888570C1	♣K080855HD			
Belt - Alt. & W.P.; W/A.C.	1847716C1	K100822HD	Cummins ISX Diesel		
Belt - Alt. & W.P.; W/O A.C.	1888656C1	K100706HD	9200i; 9900i		
Tensioner Assy. - Alt. & W.P.	1873217C2	38634	Tensioner Assy. - A.C.	2891940	38610
Idler Pulley - Alt. & W.P. (Upper)	1841930C1	36164	Idler Pulley - A.C.	3682229	36223
			LoneStar		
			Belt - A.C. - From W.P.	3565412C1	♣K060637HD

≈<Cut to Fit.

♣Standard Belt Available.

Belts and Coolant Hose for Medium/Heavy-Duty Trucks (2001 & Newer)

Application	Mfr. Part No.	Our No.	Application	Mfr. Part No.	Our No.
International/Navistar - Continued			International/Navistar - Continued		
2010 - Continued			2010 - Continued		
Cummins ISX Diesel - Continued			International/Navistar MaxxForce 10 Diesel - Continued		
LoneStar - Continued			WorkStar 7500 - Continued		
Belt - Fan, Alt. & W.P.	3833748C1	K120895HD	Hose - Upper - Pipe To Rad.		≈21135
Tensioner Assy. - A.C.	3104149	38610	Hose - Lower - Eng. To Pipe		≈20987
Tensioner Assy. - Fan, W.P. & Alt.	3684428	38587	Hose - Lower - Pipe To Heat Exch.		≈24640
Idler Pulley - A.C.	3682229	36223	Hose - Lower - Heat Exch. To Pipe		≈21891
Hose - Upper - Eng. To Pipe		21135	Hose - Lower - Pipe To Rad.		≈21891
Hose - Upper - Pipe To Rad.		21135	International/Navistar MaxxForce 13 Diesel		
Hose - Lower - Eng. To Pipe		≈21891	ProStar Series		
Hose - Lower - Pipe To Rad.		≈21891	Belt - Alt. & A.C.	3664150C1	K080794HD
ProStar Series			WorkStar 7600		
Belt - Fan, Alt. & W.P.	3817452C1	K120870HD	Belt - Fan, A.C., Alt. & W.P.	1847748C1	K100983HD
Belt - A.C. - From W.P.	3565412C1	♣K060637HD	Tensioner Assy. - Fan, A.C., Alt. & W.P.	1873217C2	38634
Tensioner Assy. - A.C.	3104149	38610	Idler Pulley - Fan, A.C., Alt. & W.P.	1841930C1	36164
Idler Pulley - A.C.	3682229	36223	Hose - Upper - Eng. To Pipe		≈24636
Hose - Upper - Rad. To Pipe		≈24440	Hose - Upper - Pipe To Rad.		21135
Hose - Upper - Pipe To Pipe		≈24440	Hose - Lower - Eng. To Pipe		≈21891
Hose - Upper - Pipe To Eng.		≈21891	Hose - Lower - Pipe To Heat Exch.		≈24640
Hose - Lower - Rad. To Pipe		≈24440	Hose - Lower - Heat Exch. To Pipe		≈21891
Hose - Lower - Pipe To Eng.		≈24440	Hose - Lower - Pipe To Rad.		21891
International/Navistar MaxxForce 5 Diesel			International/Navistar MaxxForce DT Diesel		
CityStar CF500; CityStar CF600			DuraStar 4300		
Belt - Serpentine; W/O Prestolite Alt.	1846055C1	♣K081331HD	Belt - Serpentine	1889037C1	K081047HD
Tensioner Assy.	1844538C1	38257	Tensioner Assy. - Fan	1833688C2	38556
International/Navistar MaxxForce 7 Diesel			Idler Pulley - Fan	1841930C1	36164
DuraStar 4300			Hose - Upper		23794
Belt - Fan & Alt.	1832193C2	K081065HD	Hose - Lower		≈21302
Belt - Air Compr.	1847509C1	♣K060696HD	DuraStar 4400		
Tensioner Assy. - Fan & Alt.	1833688C2	38556	Belt - Fan & Alt.; W/90" Belt O.C.	1847727C1	K100894HD
Tensioner Assy. - Air Brake Compr.	1832711C2	38629	Belt - Fan & Alt.; W/75 1/2" Belt O.C.	1879842C1	♣K100749HD
Idler Pulley - Upper; W/Air Brake Compr.	1832712C1	38006	Tensioner Assy. - Fan & Alt.	1873217C2	38634
Idler Pulley - Lower; W/Air Brake Compr.	1832712C1	38006	Idler Pulley - Fan & Alt.	1841930C1	36164
Hose - Upper		23795	Hose - Upper		23794
Hose - Lower		23793	Hose - Lower - Rad. To Pipe		≈21302
TerraStar			Hose - Lower - Pipe To Eng.		24075
Belt - Serpentine	1889037C1	K081047HD	2009		
Tensioner Assy. - Fan	1833688C2	38556	Caterpillar C13 Diesel		
Idler Pulley - Fan	1832710C1	36351	PayStar 5900i		
Hose - Lower		24059	Belt - Serpentine - Fan	3670943C1	♣K101078HD
International/Navistar MaxxForce 9 Diesel			Belt - Serpentine - A.C.	3808254C1	♣K060860HD
WorkStar 7400			WorkStar 7600		
Belt - Fan	1888570C1	♣K080855HD	Belt - Fan & A.C.	3817958C1	K101115HD
Belt - Alt. & W.P.; W/A.C.	1847716C1	K100822HD	Belt - Alt.	3808254C1	♣K060860HD
Belt - Alt. & W.P.; W/O A.C.	1888656C1	K100706HD	Tensioner Assy. - Fan & A.C.	2873203	38646
Tensioner Assy. - Alt. & W.P.	1873217C2	38634	Tensioner Assy. - Alt.	2756558	38635
Idler Pulley - Alt. & W.P. (Upper)	1841930C1	36164	Idler Pulley - Alt. (Left)	2790251	36227
Idler Pulley - Fan	1841930C1	36164	Idler Pulley - Alt. (Right)	2790251	36227
Hose - Upper		≈21135	Idler Pulley - Accessory Drive (Grooved)	2850276	36164
Hose - Lower		≈21135	Idler Pulley - Accessory Drive (Smooth)	2850273	36164
International/Navistar MaxxForce 10 Diesel			Hose - Upper - Eng. To Pipe		≈24440
WorkStar 7400			Hose - Upper - Pipe To Rad.		21135
Belt - Fan	1888570C1	♣K080855HD	Caterpillar C15 Diesel		
Belt - Alt. & W.P.; W/A.C.	1847716C1	K100822HD	PayStar 5600i		
Belt - Alt. & W.P.; W/O A.C.	1888656C1	K100706HD	Belt - Fan & Alt.	3577919C1	♣K081088HD
Tensioner Assy. - Alt. & W.P.	1873217C2	38634	Belt - Fan To A.C.	3577620C1	♣K060555HD
Idler Pulley - Alt. & W.P. (Upper)	1841930C1	36164	Tensioner Assy. - Fan & Alt.	2002279	38569
Idler Pulley - Fan	1841930C1	36164	Tensioner Assy. - Fan To A.C.	2178938	38511
Hose - Upper		≈21135	Idler Pulley - Smooth	1979641	36091
Hose - Lower		≈21135	Idler Pulley - Grooved	1979642	36341
WorkStar 7500			Tensioner Pulley - Fan To A.C.	2178938	36091
Belt - Fan, A.C., Alt. & W.P.	1847748C1	K100983HD	Hose - Upper - Eng. To Pipe		21135
Tensioner Assy. - Fan, A.C., Alt. & W.P.	1873217C2	38634	Hose - Upper - Rad. To Pipe		21891
Idler Pulley - Fan, A.C., Alt. & W.P.	1841930C1	36164	Hose - Lower - Eng. To Pipe		24248
Hose - Upper - Eng. To Pipe		≈24636	Hose - Lower - Rad. To Pipe		21135

Medium & Heavy-Duty Trucks (2001 & Newer)

≈Cut to Fit.

♣Standard Belt Available.

Belts and Coolant Hose for Medium/Heavy-Duty Trucks (2001 & Newer)

**Medium & Heavy-Duty Trucks
(2001 & Newer)**

Application	Mfr. Part No.	Our No.	Application	Mfr. Part No.	Our No.
International/Navistar - Continued			International/Navistar - Continued		
2009 - Continued			2009 - Continued		
Caterpillar C15 Diesel - Continued			Cummins ISX Diesel - Continued		
PayStar 5900i			ProStar Series - Continued		
Belt - Alt.	3676724C1	♣K060716HD	Hose - Upper - Pipe To Pipe		≈<24440
Belt - Fan & A.C.	3676401C1	K120992HD	Hose - Upper - Pipe To Rad.		≈<24440
Tensioner Assy. - Alt.	2790253	38636	Hose - Lower - Eng. To Pipe		≈<24440
Tensioner Assy. - Fan & A.C.	2362301	38609	Hose - Lower - Pipe To Rad.		≈<24440
Idler Pulley - Alt. (Upper)	2790252	36230	International/Navistar MaxxForce 5 Diesel		
Idler Pulley - Alt. (Lower)	2790252	36230	CityStar CF500; CityStar CF600		
Idler Pulley - A.C. (Lower)	2850277	36282	Belt - Serpentine; W/O Prestolite Alt.	1846055C1	♣K081331HD
Hose - Upper - Eng. To Pipe		≈<21891	Tensioner Assy.	1844538C1	38257
Cummins ISM Diesel			International/Navistar MaxxForce 7 Diesel		
PayStar 5600i			DuraStar 4300		
Belt - Fan & Alt.	3664150C1	K080794HD	Belt - Serpentine	1832193C2	K081065HD
Belt - A.C.	3579001C1	♣K060516HD	International/Navistar MaxxForce 9 Diesel		
Tensioner Assy. - Fan & Alt.	4920105	38622	WorkStar 7400		
Tensioner Assy. - A.C.	3102888	38505	Belt - Fan & Alt.; W/A.C.	1847748C1	K100983HD
Idler Pulley - Fan & Alt.	3400884	36308	Belt - Fan & Alt.; W/O A.C.	1847751C1	K100818HD
Idler Pulley - A.C.	3104139	36225	Tensioner Assy. - Fan, Alt. & A.C.	1873217C2	38634
TranStar 8600			International/Navistar MaxxForce 10 Diesel		
Belt - Fan & Alt.	3578997C1	♣K080694HD	WorkStar 7500		
Belt - A.C.	3579001C1	♣K060516HD	Belt - W.P., Fan, Alt. & A.C.	1847748C1	K100983HD
Tensioner Assy. - Fan & Alt.	3102888	38505	International/Navistar MaxxForce DT Diesel		
Tensioner Assy. - A.C.	4920105	38622	DuraStar 4300		
Idler Pulley - Fan & Alt.	3400883	36308	Belt - Fan, W.P. & Alt.	1847707C1	K100860HD
Idler Pulley - A.C.	3104139	36225	Tensioner Assy.	1873217C1	38634
Hose - Upper - Rad. To Pipe		≈<21135	Hose - Upper		23794
Hose - Lower - Rad. To Pipe		≈<21135	Hose - Lower		≈<21302
WorkStar 7600			DuraStar 4400		
Belt - A.C.	3579001C1	♣K060516HD	Belt - Fan & Alt.; W/90" Belt O.C.	1847727C1	K100894HD
Belt - Alt.	3605646C1	♣K080816HD	Belt - Fan & Alt.; W/75 1/2" Belt O.C.	1879842C1	♣K100749HD
Tensioner Assy. - Alt.	2871294	38622	Tensioner Assy. - Fan & Alt.	1873217C2	38634
Tensioner Assy. - A.C.	3102888	38505	Idler Pulley - Fan & Alt.	1841930C1	36164
Idler Pulley - Alt.	3400884	36308	WorkStar 7300		
Idler Pulley - A.C.	3104139	36225	Belt - Accessory Drive	1847725C1	K101015HD
Cummins ISX Diesel			Tensioner Assy.		
9200i; 9900i			Idler Pulley		
Tensioner Assy. - A.C.	2891940	38610	WorkStar 7400		
Idler Pulley - A.C.	3682229	36223	Belt - Fan, Alt. & W.P.; W/A.C.	1847720C1	K100994HD
LoneStar			Belt - Fan, Alt. & W.P.; W/O A.C.	1847750C1	K100830HD
Belt - A.C. - From W.P.	3565412C1	♣K060637HD	Tensioner Assy.	1873217C2	38634
Belt - Fan, Alt. & W.P.	3833748C1	K120895HD	Idler Pulley	1841930C1	36164
Tensioner Assy. - A.C.	3104149	38610	Hose - Upper - Eng. To Pipe		
Tensioner Assy. - Fan, W.P. & Alt.	3684428	38587	Hose - Upper - Pipe To Rad.		
Idler Pulley - A.C.	3682229	36223	Hose - Lower - Eng. To Pipe		
Hose - Upper - Eng. To Pipe		21135	Hose - Lower - Pipe To Heat Exch.		
Hose - Upper - Pipe To Rad.		21135	Hose - Lower - Heat Exch. To Pipe		
Hose - Lower - Eng. To Pipe		≈<21891	Hose - Lower - Pipe To Rad.		
Hose - Lower - Pipe To Rad.		≈<21891			
PayStar 5900i					
Belt - Fan & Alt.	3574308C1	♣K120964HD			
Belt - Hub & A.C.	3565412C1	♣K060637HD			
Tensioner Assy. - Fan & Alt.	3682946	38587			
Tensioner Assy. - A.C.	3682683	38610			
Idler Pulley - A.C.	3682229	36223			
Tensioner Pulley - Fan & Alt.	3682946	36165			
Hose - Upper - Eng. To Pipe		21135			
Hose - Upper - Rad. To Pipe		21891			
Hose - Lower - Eng. To Pipe		24240			
Hose - Lower - Rad. To Pipe		21135			
ProStar Series					
Belt - W.P. To A.C.	3565412C1	♣K060637HD			
Belt - W.P., Fan & Alt.	3817452C1	K120870HD			
Tensioner Assy. - A.C.	3104149	38610			
Tensioner Assy. - Fan, W.P. & Alt.	3684428	38587			
Idler Pulley - A.C.	3682229	36223			
2008					
Caterpillar C13 Diesel			Caterpillar C13 Diesel		
7600			7600		
Belt - Fan, Alt. & A.C.	3565415C1	♣K081092HD	Belt - Fan, Alt. & A.C.	3565415C1	♣K081092HD
Tensioner Assy. - Fan, Alt. & A.C.	2117895	38590	Tensioner Assy. - Fan, Alt. & A.C.	2117895	38590
Tensioner Pulley - Fan, Alt. & A.C.	2117895	36164	Idler Pulley - Smooth	2078118	36269
Idler Pulley - Smooth	2078118	36269	Idler Pulley - Grooved	1979642	36341
Idler Pulley - Grooved	1979642	36341	Hose - Upper - Eng. To Pipe		24240
Hose - Upper - Eng. To Pipe		24240	Hose - Upper - Rad. To Pipe		≈<21115
Hose - Upper - Rad. To Pipe		≈<21115	Hose - Lower - Eng. To Pipe		24240
Hose - Lower - Eng. To Pipe		24240	Hose - Lower - Rad. To Pipe		21894
Hose - Lower - Rad. To Pipe		21894	TranStar 8500; TranStar 8600; WorkStar 7700		
TranStar 8500; TranStar 8600; WorkStar 7700			Idler Pulley - Smooth		
Idler Pulley - Smooth	2078118	36269	Idler Pulley - Grooved	1979642	36341
Idler Pulley - Grooved	1979642	36341			

≈<Cut to Fit.

♣Standard Belt Available.

Belts and Coolant Hose for Medium/Heavy-Duty Trucks (2001 & Newer)

Medium & Heavy-Duty Trucks
(2001 & Newer)

Application	Mfr. Part No.	Our No.	Application	Mfr. Part No.	Our No.
International/Navistar - Continued			International/Navistar - Continued		
2008 - Continued			2008 - Continued		
Caterpillar C15 Diesel			Cummins ISX Diesel - Continued		
PayStar 5600i			9200i - Continued		
Belt - Fan & Alt.	3577919C1	♣K081088HD	Hose - Lower - Pipe To Eng.		≋24440
Belt - Fan To A.C.	3577620C1	♣K060555HD	9900i		
Tensioner Assy. - Fan & Alt.	2002279	38569	Belt - Fan & Alt.	3565411C1	K120979
Tensioner Assy. - Fan To A.C.	2178938	38511	Belt - A.C.	3565412C1	♣K060637HD
Idler Pulley - Smooth	1979641	36091	PayStar 5500i		
Idler Pulley - Grooved	1979642	36341	Belt - Fan & Alt.	3574308C1	♣K120964HD
Tensioner Pulley - Fan To A.C.	2178938	36091	Belt - Hub & A.C.	3565412C1	♣K060637HD
Hose - Upper - Eng. To Pipe		21135	Tensioner Assy. - Fan & Alt.	3682946	38587
Hose - Upper - Rad. To Pipe		21891	Tensioner Assy. - A.C.	3682683	38610
Hose - Lower - Eng. To Pipe		24248	Idler Pulley - A.C.	3682229	36223
Hose - Lower - Rad. To Pipe		21135	Tensioner Pulley - Fan & Alt.	3682946	36165
Cummins ISL Diesel			Hose - Upper - Eng. To Pipe		21135
PayStar 5600i			Hose - Upper - Rad. To Pipe		≋21115
Belt - Serpentine	3289875	♣K080830HD	Hose - Lower - Eng. To Pipe		24240
Tensioner Assy.	3976831	38516	Hose - Lower - Rad. To Pipe		21135
Idler Pulley	3970945	36283	PayStar 5900i		
Cummins ISM Diesel			Belt - Fan & Alt.	3574308C1	♣K120964HD
PayStar 5500i			Belt - Hub & A.C.	3565412C1	♣K060637HD
Belt - Fan & Alt.	3579000C1	♣K080806HD	Tensioner Assy. - Fan & Alt.	3682946	38587
Belt - Hub & A.C.	3579001C1	♣K060516HD	Tensioner Assy. - A.C.	3682683	38610
Tensioner Assy. - Fan & Alt.	4920105	38622	Idler Pulley - A.C.	3682229	36223
Tensioner Assy. - Hub & A.C.	3102888	38505	Tensioner Pulley - Fan & Alt.	3682946	36165
Idler Pulley - Fan & Alt.	3400884	36308	Hose - Upper - Eng. To Pipe		21135
Idler Pulley - A.C.	3104139	36225	Hose - Upper - Rad. To Pipe		21891
Tensioner Pulley - A.C.	3102888	36091	Hose - Lower - Eng. To Pipe		24240
PayStar 5600i			Hose - Lower - Rad. To Pipe		21135
Belt - Fan	3579000C1	♣K080806HD	ProStar Series		
Belt - A.C.	3579001C1	♣K060516HD	Belt - Fan & Alt.	3289314	♣K080708HD
Tensioner Assy. - Fan	3976831	38516	Belt - Hub & A.C.	3565412C1	♣K060637HD
TranStar 8500			Tensioner Assy. - A.C.	3682683	38610
Idler Pulley - Fan & Alt.	3400884	36308	Tensioner Assy. - Fan & Alt.	3400885	38521
Idler Pulley - A.C.	3104139	36225	Idler Pulley - A.C.	3682229	36223
TranStar 8600			Idler Pulley - Fan & Alt.	3400883	36308
Belt - Fan & Alt.	3578997C1	♣K080694HD	Hose - Upper - Eng. To Pipe		24240
Belt - Hub & A.C.	3579001C1	♣K060516HD	Hose - Upper - Rad. To Pipe		24240
Tensioner Assy. - Fan & Alt.	4920105	38622	Hose - Lower - Eng. To Pipe		24240
Tensioner Assy. - Hub & A.C.	3102888	38505	Hose - Lower - Rad. To Pipe		24240
Idler Pulley - Fan & Alt.	3400884	36308	International/Navistar DT570 Diesel		
Idler Pulley - A.C.	3104139	36225	4400		
Tensioner Pulley - A.C.	3102888	36091	Belt - Hub, Fan, Alt. & A.C.	1842466C1	K080845HD
Hose - Upper - Eng. To Pipe		21135	Tensioner Assy. - Hub, Fan, Alt. & A.C.	1841760C1	38620
Hose - Upper - Rad. To Pipe		≋21135	Hose - Upper - Eng. To Rad.		20731
Hose - Lower - Eng. To Pipe		21891	International/Navistar MaxxForce 5 Diesel		
Hose - Lower - Rad. To Pipe		21135	CityStar CF500; CityStar CF600		
WorkStar 7600			Belt - Serpentine; W/O Prestolite Alt.	1846055C1	♣K081331HD
Belt - Fan & Alt.	3579000C1	♣K080806HD	Tensioner Assy.	1844538C1	38257
Belt - Hub & A.C.	3579001C1	♣K060516HD	International/Navistar MaxxForce 7 Diesel		
Tensioner Assy. - Fan & Alt.	4920105	38622	DuraStar 4300		
Tensioner Assy. - Hub & A.C.	3102888	38505	Belt - Fan, Alt. & A.C.	1832193C2	K081065HD
Idler Pulley - Fan & Alt.	3400884	36308	Belt - Air Compr.	1847509C1	♣K060696HD
Idler Pulley - A.C.	3104139	36225	Tensioner Assy. - Fan, Alt. & A.C.	1833688C2	38556
Tensioner Pulley - A.C.	3102888	36091	Tensioner Assy. - Air Brake Compr.	1832711C2	38629
Hose - Upper - Eng. To Pipe		24240	Hose - Upper - Eng. To Pipe		21135
Hose - Upper - Rad. To Pipe		21135	Hose - Upper - Rad. To Pipe		21042
Hose - Lower - Cooler To Pipe		24240	International/Navistar MaxxForce 9 Diesel		
Hose - Lower - Rad. To Pipe		21891	WorkStar 7400		
Cummins ISX Diesel			Belt - Fan, Alt. & A.C.	1847748C1	K100983HD
9200i			Tensioner Assy. - Fan, Alt. & A.C.	1873217C1	38634
Belt - Fan & Alt.	3565410C3	♣K120911HD	Hose - Upper - Eng. To Pipe		24240
Belt - A.C.	3565412C1	♣K060637HD	Hose - Upper - Rad. To Pipe		21135
Idler Pulley - A.C.	3682229	36223	Hose - Lower - Eng. To Cooler		24240
Hose - Upper		≋24440	Hose - Lower - Rad. To Pipe		21891
Hose - Lower - Rad. To Pipe		≋21135			

♣Standard Belt Available.

≋Cut to Fit.

Belts and Coolant Hose for Medium/Heavy-Duty Trucks (2001 & Newer)

Medium & Heavy-Duty Trucks (2001 & Newer)

Application	Mfr. Part No.	Our No.	Application	Mfr. Part No.	Our No.
International/Navistar - Continued			International/Navistar - Continued		
2008 - Continued			2008 - Continued		
International/Navistar MaxxForce 9 Diesel - Continued			International/Navistar MaxxForce DT Diesel - Continued		
WorkStar 7400 - Continued			WorkStar 7400 - Continued		
Hose - Lower - Cooler To Pipe		24240	Hose - Upper - Eng. To Pipe		≈<24636
International/Navistar MaxxForce 10 Diesel			Hose - Upper - Pipe To Rad.		≈<21135
TranStar 8500			Hose - Lower - Eng. To Pipe		≈<20987
Belt - Accessory Drive	1879845C1	K100877HD	Hose - Lower - Pipe To Heat Exch.		≈<24640
Tensioner Assy.	1873217C1	38634	Hose - Lower - Heat Exch. To Pipe		≈<21891
WorkStar 7400			Hose - Lower - Pipe To Rad.		≈<21891
Belt - Fan, Alt. & A.C.	1847748C1	K100983HD	International/Navistar MaxxForce DT Diesel Electric Assist		
Tensioner Assy. - Fan, Alt. & A.C.	1873217C1	38634	DuraStar Hybrid		
Hose - Upper		21135	Belt - Fan	1847708C1	K100870HD
Hose - Lower - Eng. To Cooler		21891	Tensioner Assy.	1873217C2	38634
Hose - Lower - Rad. To Pipe		21891	Hose - Upper		23794
Hose - Lower - Cooler To Pipe		21891	International/Navistar VT365 Diesel		
WorkStar 7500			4200		
Tensioner Assy. - Fan, Alt. & A.C.	1873217C1	38634	Belt - A.C.	1843218C1	♣K060509HD
Hose - Upper - Eng. To Pipe		24236	Belt - Fan	1839963C1	♣K080830HD
Hose - Upper - Rad. To Pipe		21135	Tensioner Assy. - A.C.	1833688C2	38556
Hose - Lower - Eng. To Pipe		21891	Hose - Upper - Rad. To Eng.		22774
Hose - Lower - Rad. To Pipe		21135	Hose - Lower		22775
International/Navistar MaxxForce 13 Diesel			MXT		
ProStar Series			Belt - Fan, Alt. & A.C.	1842458C1	♣K080816HD
Hose - Upper - Eng. To Pipe		21891	Hose - Lower - Rad. To Pipe		21891
Hose - Upper - Rad. To Pipe		21135	2007		
Hose - Lower - Eng. To Pipe		24240	Caterpillar C11 Diesel		
Hose - Lower - Rad. To Pipe		21891	7600		
International/Navistar MaxxForce DT Diesel			Belt - Fan, Alt. & A.C.	3565415C1	♣K081092HD
4300			Tensioner Assy. - Fan, Alt. & A.C.	2117895	38590
Belt - Fan, Alt. & A.C.	1842457C1	♣K080825HD	Tensioner Pulley - Fan, Alt. & A.C.	2117895	36164
Tensioner Assy. - Fan, Alt. & A.C.	1841760C1	38620	Hose - Upper - Eng. To Pipe		24240
Hose - Upper - Eng. To Rad.		20731	Hose - Lower - Eng. To Pipe		24240
Hose - Lower - Eng. To Rad.		22742	Hose - Lower - Rad. To Pipe		21894
4400			8600		
Belt - Fan & Alt.	1847727C1	K100894HD	Belt - Fan, Alt. & A.C.	3578774C1	♣K080944HD
Tensioner Assy. - Fan & Alt.	1873217C2	38634	Tensioner Assy. - Fan, Alt. & A.C.	2117895	38590
Idler Pulley - Fan & Alt.	1841930C1	36164	Tensioner Pulley - Fan, Alt. & A.C.	2117895	36164
DuraStar 4300			Hose - Upper - Eng. To Pipe		24240
Belt - Fan, Alt. & A.C.; W/Air Brake Compr. .	1832193C2	K081065HD	Hose - Upper - Rad. To Pipe		21135
Belt - Fan, Alt. & A.C.; W/O Air Brake			Hose - Lower - Eng. To Pipe		21135
Compr.	1847707C1	K100860HD	Hose - Lower - Rad. To Pipe		21135
Belt - Air Brake Compr.	1847509C1	♣K060696HD	Caterpillar C13 Diesel		
Tensioner Assy. - Fan, Alt. & A.C.; W/Air			5500i		
Brake Compr.	1833688C2	38556	Belt - Fan, Alt. & A.C.	3565415C1	♣K081092HD
Tensioner Assy. - Fan, Alt. & A.C.; W/O Air			Tensioner Assy. - Fan, Alt. & A.C.	2117895	38590
Brake Compr.	1873217C1	38634	Tensioner Pulley - Fan, Alt. & A.C.	2117895	36164
Tensioner Assy. - Air Brake Compr.	1832711C2	38629	Idler Pulley - Smooth	2078118	36269
Hose - Upper - Eng. To Rad.		20731	Idler Pulley - Grooved	1979642	36341
Hose - Lower - Eng. To Rad.		22742	Hose - Upper - Eng. To Rad.		21135
DuraStar 4400			Hose - Upper - Rad. To Pipe		≈<21115
Belt - Fan & Alt.; W/90" Belt O.C.	1847727C1	K100894HD	Hose - Lower - Eng. To Pipe		24240
Belt - Fan & Alt.; W/75 1/2" Belt O.C.	1879842C1	♣K100749HD	Hose - Lower - Rad. To Cooler		21135
Tensioner Assy. - Fan & Alt.	1873217C2	38634	Hose - Lower - Cooler To Pipe		24240
Hose - Upper		23794	5600i; 5900i		
Hose - Lower		≈<21302	Idler Pulley - Smooth	2078118	36269
WorkStar 7300			Idler Pulley - Grooved	1979642	36341
Belt - Fan, Alt. & A.C.	1847725C1	K101015HD	7600		
Tensioner Assy. - Fan, Alt. & A.C.	1873217C2	38634	Belt - Fan, Alt. & A.C.	3565415C1	♣K081092HD
Hose - Upper - Eng. To Pipe		21135	Tensioner Assy. - Fan, Alt. & A.C.	2117895	38590
Hose - Lower - Pipe To Rad.		21135	Tensioner Pulley - Fan, Alt. & A.C.	2117895	36164
Hose - Lower - Eng. To Pipe		≈<21891	Idler Pulley - Smooth	2078118	36269
WorkStar 7400			Idler Pulley - Grooved	1979642	36341
Belt - Fan, Alt. & W.P.; W/A.C.	1847720C1	K100994HD	7600		
Belt - Fan, Alt. & W.P.; W/O A.C.	1847750C1	K100830HD	Belt - Fan, Alt. & A.C.	3565415C1	♣K081092HD
Tensioner Assy. - Fan & Alt.	1873217C2	38634	Tensioner Assy. - Fan, Alt. & A.C.	2117895	38590
Idler Pulley - Fan & Alt.	1841930C1	36164	Tensioner Pulley - Fan, Alt. & A.C.	2117895	36164

♣Standard Belt Available.

≈<Cut to Fit.

Belts and Coolant Hose for Medium/Heavy-Duty Trucks (2001 & Newer)

Medium & Heavy-Duty Trucks
(2001 & Newer)

Application	Mfr. Part No.	Our No.	Application	Mfr. Part No.	Our No.
International/Navistar - Continued			International/Navistar - Continued		
2007 - Continued			2007 - Continued		
Caterpillar C13 Diesel - Continued			Cummins ISM Diesel		
7600 - Continued			5500i		
Hose - Lower - Eng. To Pipe		24240	Belt - Fan & Alt.	3579000C1	♣K080806HD
Hose - Lower - Rad. To Pipe		21894	Belt - Hub & A.C.	3579001C1	♣K060516HD
7700			Tensioner Assy. - Fan & Alt.	4920105	38622
Idler Pulley - Smooth	2078118	36269	Tensioner Assy. - Hub & A.C.	3102888	38505
Idler Pulley - Grooved	1979642	36341	Idler Pulley - Fan & Alt.	3400884	36308
8600			Idler Pulley - A.C.	3104139	36225
Belt - Fan, Alt. & A.C.	3578774C1	♣K080944HD	Tensioner Pulley - A.C.	3102888	36091
Tensioner Assy. - Fan, Alt. & A.C.	2117895	38590	Hose - Upper - Eng. To Pipe		24240
Tensioner Pulley - Fan, Alt. & A.C.	2117895	36164	Hose - Upper - Rad. To Pipe		21135
Idler Pulley - Smooth	2078118	36269	Hose - Lower - Eng. To Pipe		21135
Idler Pulley - Grooved	1979642	36341	Hose - Lower - Rad. To Pipe		21891
Hose - Upper - Eng. To Pipe		24240	Hose - Lower - Pipe To Cooler		21135
Hose - Upper - Rad. To Pipe		21135	Hose - Lower - Cooler To Pipe		24240
Hose - Lower - Eng. To Pipe		21135	5600i		
Hose - Lower - Rad. To Pipe		21135	Belt - Fan & Alt.	3579000C1	♣K080806HD
9200i			Belt - Hub & A.C.	3579001C1	♣K060516HD
Belt - Fan, Alt. & A.C.	3578775C2	♣K081000HD	Tensioner Assy. - Fan & Alt.	4920105	38622
Tensioner Assy. - Fan, Alt. & A.C.	2117895	38590	Tensioner Assy. - Hub & A.C.	3102888	38505
Tensioner Pulley - Fan, Alt. & A.C.	2117895	36164	Idler Pulley - Fan & Alt.	3400884	36308
Idler Pulley - Smooth	2078118	36269	Idler Pulley - A.C.	3104139	36225
Idler Pulley - Grooved	1979642	36341	Tensioner Pulley - A.C.	3102888	36091
Hose - Upper - Eng. To Pipe		24240	Hose - Upper - Eng. To Pipe		≈21115
Hose - Upper - Rad. To Pipe		21135	Hose - Upper - Rad. To Pipe		24240
Hose - Lower - Eng. To Pipe		24240	Hose - Lower - Eng. To Pipe		24240
Hose - Lower - Rad. To Pipe		21891	Hose - Lower - Rad. To Pipe		21135
9400i			5900i		
Belt - Fan, Alt. & A.C.	3578775C2	♣K081000HD	Idler Pulley - Fan & Alt.	3400884	36308
Tensioner Assy. - Fan, Alt. & A.C.	2117895	38590	7600		
Tensioner Pulley - Fan, Alt. & A.C.	2117895	36164	Belt - Fan & Alt.	3579000C1	♣K080806HD
Idler Pulley - Smooth	2078118	36269	Belt - Hub & A.C.	3579001C1	♣K060516HD
Idler Pulley - Grooved	1979642	36341	Tensioner Assy. - Fan & Alt.	4920105	38622
9900i			Tensioner Assy. - Hub & A.C.	3102888	38505
Belt - Fan, Alt. & A.C.	3578777C2	K081099HD	Idler Pulley - Fan & Alt.	3400884	36308
Tensioner Assy. - Fan, Alt. & A.C.	2117895	38590	Idler Pulley - A.C.	3104139	36225
Idler Pulley - Smooth	2078118	36269	Tensioner Pulley - A.C.	3102888	36091
Idler Pulley - Grooved	1979642	36341	Hose - Upper - Eng. To Pipe		21891
Caterpillar C15 Diesel			Hose - Upper - Rad. To Pipe		24240
5500i			Hose - Lower - Eng. To Pipe		21135
Belt - Serpentine - Fan	3577919C1	♣K081088HD	Hose - Lower - Rad. To Pipe		21891
Belt - Serpentine - A.C.	3577920C1	♣K060555HD	7700		
9400i			Idler Pulley - Fan & Alt.	3400884	36308
Belt - Fan & Alt.	35664736C2	♣K080991HD	8600		
Belt - Fan To A.C.	3565414C1	♣K060605HD	Belt - Fan & Alt.	3578997C1	♣K080694HD
Tensioner Assy. - Fan & Alt.	2002279	38569	Belt - Hub & A.C.	3579001C1	♣K060516HD
Tensioner Assy. - Fan To A.C.	2178938	38511	Tensioner Assy. - Fan & Alt.	4920105	38622
Idler Pulley - Smooth	1979641	36091	Tensioner Assy. - Hub & A.C.	3102888	38505
Idler Pulley - Grooved	1979642	36341	Idler Pulley - Fan & Alt.	3400884	36308
Tensioner Pulley - Fan To A.C.	2178938	36091	Idler Pulley - A.C.	3104139	36225
Hose - Upper - Eng. To Pipe		21891	Tensioner Pulley - A.C.	3102888	36091
Hose - Upper - Rad. To Pipe		21135	Hose - Upper - Eng. To Pipe		24240
Hose - Lower - Eng. To Pipe		24248	Hose - Upper - Pipe To Rad.		24240
Hose - Lower - Rad. To Pipe		24240	Hose - Lower - Eng. To Pipe		24240
9900i; 9900ix			Hose - Lower - Pipe To Rad.		21891
Belt - Fan & Alt.	3565415C1	♣K081092HD	9200i; 9400i		
Belt - Fan To A.C.	3565416C1	♣K060557HD	Belt - Fan & Alt.	3578998C1	♣K080740HD
Tensioner Assy. - Fan & Alt.	2002279	38569	Belt - Hub & A.C.	3579001C1	♣K060516HD
Tensioner Assy. - Fan To A.C.	2178938	38511	Tensioner Assy. - Fan & Alt.	4920105	38622
Idler Pulley - Smooth	1979641	36091	Tensioner Assy. - Hub & A.C.	3102888	38505
Idler Pulley - Grooved	1979642	36341	Idler Pulley - Fan & Alt.	3400884	36308
Tensioner Pulley - Fan To A.C.	2178938	36091	Idler Pulley - A.C.	3104139	36225
Hose - Upper - Eng. To Rad.		21891	Tensioner Pulley - A.C.	3102888	36091
Hose - Upper - Rad. To Pipe		21135	Hose - Upper - Eng. To Pipe		24240
Hose - Lower - Eng. To Rad.		24248	Hose - Upper - Rad. To Pipe		21135
Hose - Lower - Rad. To Pipe		24240	Hose - Lower - Eng. To Pipe		24240
			Hose - Lower - Rad. To Pipe		21891

♣Standard Belt Available.

≈Cut to Fit.

Belts and Coolant Hose for Medium/Heavy-Duty Trucks (2001 & Newer)

Medium & Heavy-Duty Trucks
(2001 & Newer)

Application	Mfr. Part No.	Our No.	Application	Mfr. Part No.	Our No.
International/Navistar - Continued			International/Navistar - Continued		
2007 - Continued			2007 - Continued		
Cummins ISX Diesel			International/Navistar DT466 Diesel - Continued		
5500i			4400		
Belt - Fan & Alt.	3574308C1	♣K120964HD	Belt - Fan, Alt. & A.C.	1842457C1	♣K080825HD
Belt - Hub & A.C.	3565412C1	♣K060637HD	Tensioner Assy. - Fan, Alt. & A.C.	1841760C1	38620
Tensioner Assy. - Fan & Alt.	3682946	38587	Hose - Upper - Eng. To Rad.		20731
Tensioner Assy. - A.C.	3682683	38610	Hose - Lower - Cooler To Rad.		21891
Idler Pulley - A.C.	3682229	36223	7400		
Tensioner Pulley - Fan & Alt.	3682946	36165	Belt - Hub, Fan, Alt. & A.C.	1842461C1	♣K080926HD
Hose - Upper - Eng. To Pipe		21135	Belt - Fan, Alt. & Hub	1842459C1	K080801HD
Hose - Upper - Rad. To Pipe		♣21115	Tensioner Assy. - Hub, Fan, Alt. & A.C.	1841760C1	38620
Hose - Lower - Eng. To Pipe		24240	Hose - Upper - Eng. To Rad.		21194
Hose - Lower - Rad. To Pipe		21135	Hose - Upper - Rad. To Pipe		24240
5600i			Hose - Lower - Eng. To Pipe		21135
Belt - Fan & Alt.	3574308C1	♣K120964HD	Hose - Lower - Rad. To Pipe		21135
Belt - Hub & A.C.	3565412C1	♣K060637HD	Hose - Lower - Pipe To Cooler		24240
Tensioner Assy. - Fan & Alt.	3682946	38587	International/Navistar DT570 Diesel		
Tensioner Assy. - A.C.	3682683	38610	4400		
Idler Pulley - A.C.	3682229	36223	Belt - Hub, Fan, Alt. & A.C.	1842466C1	K080845HD
Tensioner Pulley - Fan & Alt.	3682946	36165	Tensioner Assy. - Hub, Fan, Alt. & A.C.	1841760C1	38620
Hose - Upper - Eng. To Pipe		23084	Hose - Upper - Eng. To Rad.		20731
Hose - Upper - Rad. To Pipe		21891	7400		
Hose - Lower - Eng. To Pipe		24240	Belt - Hub, Fan, Alt. & A.C.	1842468C1	♣K080952HD
Hose - Lower - Rad. To Pipe		21135	Tensioner Assy. - Hub, Fan, Alt. & A.C.	1841760C1	38620
Hose - Lower - Pipe To Cooler		24240	Hose - Upper - Eng. To Pipe		21891
Hose - Lower - Cooler To Pipe		②24240	Hose - Upper - Rad. To Pipe		24240
5900i			Hose - Lower - Eng. To Pipe		21135
Belt - Fan & Alt.	3574308C1	♣K120964HD	Hose - Lower - Pipe To Cooler		21891
Belt - Hub & A.C.	3565412C1	♣K060637HD	Hose - Lower - Cooler To Rad.		21891
Tensioner Assy. - Fan & Alt.	3682946	38587	Hose - Lower - Cooler To Pipe		21891
Tensioner Assy. - A.C.	3682683	38610	International/Navistar HT570 Diesel		
Idler Pulley - A.C.	3682229	36223	7500		
Tensioner Pulley - Fan & Alt.	3682946	36165	Belt - Fan, Alt. & A.C.	1842600C1	♣K080944HD
Hose - Upper - Eng. To Pipe		21135	Tensioner Assy. - Fan, Alt. & A.C.	1841760C1	38620
Hose - Upper - Rad. To Pipe		21891	Hose - Upper - Eng. To Pipe		21891
Hose - Lower - Eng. To Pipe		24240	Hose - Upper - Rad. To Pipe		24240
Hose - Lower - Rad. To Pipe		21135	Hose - Lower - Eng. To Rad.		24077
9200i; 9400i			8500		
Belt - Fan & Alt.	3565410C3	♣K120911HD	Belt - Fan, Alt. & A.C.	1842466C1	K080845HD
Belt - Hub & A.C.	3565412C1	♣K060637HD	Tensioner Assy. - Fan, Alt. & A.C.	1841760C1	38620
Tensioner Assy. - Fan & Alt.	3682946	38587	Hose - Upper - Eng. To Rad.		21115
Tensioner Assy. - A.C.	3682683	38610	International/Navistar VT275 Diesel		
Idler Pulley - A.C.	3682229	36223	CF500; CF600		
Tensioner Pulley - Fan & Alt.	3682946	36165	Belt - Fan, Alt. & P.S.	1848715C1	♣K081331HD
Hose - Upper - Eng. To Pipe		♣21135	Tensioner Assy.	1844538C1	38257
Hose - Upper - Rad. To Pipe		♣21135	International/Navistar VT365 Diesel		
Hose - Lower - Eng. To Pipe		♣21891	4100		
Hose - Lower - Rad. To Pipe		♣21891	Belt - Fan, Alt. & A.C.	1839963C1	♣K080830HD
9900i; 9900ix			Tensioner Assy. - Fan, Alt. & A.C.	1833688C2	38556
Belt - A.C.	3565412C1	♣K060637HD	Hose - Upper - Eng. To Rad.		22774
Belt - Fan & Alt.	3565411C3	♣K120975HD	Hose - Lower - Eng. To Rad.		22775
Tensioner Assy. - Fan & Alt.	3682946	38587	4200		
Tensioner Assy. - A.C.	3682683	38610	Belt - Fan, Alt. & A.C.	1839963C1	♣K080830HD
Idler Pulley - A.C.	3682229	36223	Belt - Fan & Air Compr.	1843218C1	♣K060509HD
Tensioner Pulley - Fan & Alt.	3682946	36165	Tensioner Assy. - Fan, Alt. & A.C.	1833688C2	38556
Hose - Upper - Eng. To Pipe		21135	Tensioner Assy. - Air Brake Compr.	1832711C2	38629
Hose - Upper - Rad. To Pipe		21135	Hose - Upper - Eng. To Rad.		22774
Hose - Lower - Eng. To Pipe		24240	Hose - Lower - Eng. To Rad.		22775
Hose - Lower - Pipe To Rad.		24240	MXT		
International/Navistar DT466 Diesel			Belt - Fan, Alt. & A.C.	1842458C1	♣K080816HD
4300			Hose - Lower - Rad. To Pipe		21891
Belt - Fan, Alt. & A.C.	1842457C1	♣K080825HD			
Tensioner Assy. - Fan, Alt. & A.C.	1841760C1	38620			
Idler Pulley - Fan, Alt. & A.C.	1841930C1	36164			
Hose - Upper - Eng. To Rad.		20731			
Hose - Lower - Eng. To Rad.		22742			

♣Standard Belt Available.
②Two Required.

♣Cut to Fit.

Belts and Coolant Hose for Medium/Heavy-Duty Trucks (2001 & Newer)

Application	Mfr. Part No.	Our No.	Application	Mfr. Part No.	Our No.
International/Navistar - Continued			International/Navistar - Continued		
2006			2006 - Continued		
Caterpillar C11 Diesel			Caterpillar C15 Diesel		
7600; 7700			5900i		
Belt - Fan, Alt. & A.C.	3565415C1	♣K081092HD	Belt - Fan & Alt.	2577919C1	♣K081088HD
Tensioner Assy. - Fan, Alt. & A.C.	2117895	38590	Belt - Fan To A.C.	3577920C1	♣K060555HD
Tensioner Pulley - Fan, Alt. & A.C.	2117895	36164	Tensioner Assy. - Fan & Alt.	2002279	38569
Hose - Upper - Eng. To Pipe		24240	Tensioner Assy. - Fan To A.C.	2178938	38511
Hose - Upper - Rad. To Pipe		24240	Tensioner Pulley - Fan To A.C.	2178938	36091
Hose - Lower - Eng. To Pipe		24240	Hose - Upper - Eng. To Pipe		21891
Hose - Lower - Rad. To Pipe		21894	Hose - Upper - Rad. To Pipe		21135
8600			Hose - Lower - Eng. To Pipe		24248
Belt - Fan, Alt. & A.C.	3578774C1	♣K080944HD	Hose - Lower - Rad. To Pipe		21135
Tensioner Assy. - Fan, Alt. & A.C.	2117895	38590	9400i		
Tensioner Pulley - Fan, Alt. & A.C.	2117895	36164	Belt - Fan & Alt.	35664736C2	♣K080991HD
Hose - Upper - Eng. To Pipe		21135	Belt - Fan To A.C.	3565414C1	♣K060605HD
Hose - Upper - Rad. To Pipe		24240	Tensioner Assy. - Fan & Alt.	2002279	38569
Hose - Lower - Eng. To Pipe		24240	Tensioner Assy. - Fan To A.C.	2178938	38511
Hose - Lower - Rad. To Pipe		21891	Idler Pulley - Smooth	1979641	36091
Caterpillar C13 Diesel			Idler Pulley - Grooved	1979642	36341
5500i			Tensioner Pulley - Fan To A.C.	2178938	36091
Belt - Fan, Alt. & A.C.	3565415C1	♣K081092HD	Hose - Upper - Eng. To Pipe		21891
Tensioner Assy. - Fan, Alt. & A.C.	2117895	38590	Hose - Upper - Rad. To Pipe		21135
Tensioner Pulley - Fan, Alt. & A.C.	2117895	36164	Hose - Lower - Eng. To Pipe		24248
Idler Pulley - Smooth	2078118	36269	Hose - Lower - Rad. To Pipe		24240
Idler Pulley - Grooved	1979642	36341	9900i; 9900ix		
Hose - Upper - Eng. To Rad.		21135	Belt - Fan & Alt.	3565415C1	♣K081092HD
Hose - Upper - Rad. To Pipe		♣K21115	Belt - Fan To A.C.	3565416C1	♣K060557HD
Hose - Lower - Eng. To Pipe		24240	Tensioner Assy. - Fan & Alt.	2002279	38569
Hose - Lower - Rad. To Cooler		21135	Tensioner Assy. - Fan To A.C.	2178938	38511
Hose - Lower - Cooler To Pipe		24240	Idler Pulley - Smooth	1979641	36091
5600i; 5900i			Idler Pulley - Grooved	1979642	36341
Idler Pulley - Smooth	2078118	36269	Tensioner Pulley - Fan To A.C.	2178938	36091
Idler Pulley - Grooved	1979642	36341	Hose - Upper - Eng. To Rad.		21891
7600; 7700			Hose - Upper - Rad. To Pipe		21135
Belt - Fan, Alt. & A.C.	3565415C1	♣K081092HD	Hose - Lower - Eng. To Rad.		24248
Tensioner Assy. - Fan, Alt. & A.C.	2117895	38590	Hose - Lower - Rad. To Pipe		24240
Tensioner Pulley - Fan, Alt. & A.C.	2117895	36164	Cummins ISM Diesel		
Idler Pulley - Smooth	2078118	36269	5500i		
Idler Pulley - Grooved	1979642	36341	Belt - Fan & Alt.	3579000C1	♣K080806HD
Hose - Upper - Eng. To Pipe		24240	Belt - Hub & A.C.	3579001C1	♣K060516HD
Hose - Upper - Rad. To Pipe		24240	Tensioner Assy. - Fan & Alt.	4920105	38622
Hose - Lower - Eng. To Pipe		24240	Tensioner Assy. - Hub & A.C.	3102888	38505
Hose - Lower - Rad. To Pipe		21894	Idler Pulley - Fan & Alt.	3400884	36308
8600			Idler Pulley - A.C.	3104139	36225
Belt - Fan, Alt. & A.C.	3578774C1	♣K080944HD	Tensioner Pulley - A.C.	3102888	36091
Tensioner Assy. - Fan, Alt. & A.C.	2117895	38590	Hose - Upper - Eng. To Pipe		24240
Tensioner Pulley - Fan, Alt. & A.C.	2117895	36164	Hose - Upper - Rad. To Pipe		21135
Idler Pulley - Smooth	2078118	36269	Hose - Lower - Eng. To Pipe		21135
Idler Pulley - Grooved	1979642	36341	Hose - Lower - Rad. To Pipe		21891
Hose - Upper - Eng. To Pipe		21135	Hose - Lower - Pipe To Cooler		21135
Hose - Upper - Rad. To Pipe		24240	Hose - Lower - Cooler To Pipe		24240
Hose - Lower - Eng. To Pipe		24240	5600i; 5900i		
Hose - Lower - Rad. To Pipe		21891	Belt - Fan & Alt.	3579000C1	♣K080806HD
9200i; 9400i			Belt - Hub & A.C.	3579001C1	♣K060516HD
Belt - Fan, Alt. & A.C.	3578775C2	♣K081000HD	Tensioner Assy. - Fan & Alt.	4920105	38622
Tensioner Assy. - Fan, Alt. & A.C.	2117895	38590	Tensioner Assy. - Hub & A.C.	3102888	38505
Tensioner Pulley - Fan, Alt. & A.C.	2117895	36164	Idler Pulley - Fan & Alt.	3400884	36308
Idler Pulley - Smooth	2078118	36269	Idler Pulley - A.C.	3104139	36225
Idler Pulley - Grooved	1979642	36341	Tensioner Pulley - A.C.	3102888	36091
Hose - Upper - Eng. To Pipe		24240	Hose - Upper - Eng. To Pipe		24240
Hose - Upper - Rad. To Pipe		21135	Hose - Upper - Rad. To Pipe		21135
Hose - Lower - Eng. To Pipe		24240	Hose - Lower - Eng. To Pipe		24240
Hose - Lower - Rad. To Pipe		21891	Hose - Lower - Rad. To Pipe		21891
9900i			7600; 7700		
Idler Pulley - Smooth	2078118	36269	Belt - Fan & Alt.	3579000C1	♣K080806HD
Idler Pulley - Grooved	1979642	36341	Belt - Hub & A.C.	3579001C1	♣K060516HD
			Tensioner Assy. - Fan & Alt.	4920105	38622

♣Standard Belt Available.

♣Cut to Fit.

Medium & Heavy-Duty Trucks
(2001 & Newer)

Belts and Coolant Hose for Medium/Heavy-Duty Trucks (2001 & Newer)

Medium & Heavy-Duty Trucks
(2001 & Newer)

Application	Mfr. Part No.	Our No.	Application	Mfr. Part No.	Our No.
International/Navistar - Continued			International/Navistar - Continued		
2006 - Continued			2006 - Continued		
Cummins ISM Diesel - Continued			Cummins ISX Diesel - Continued		
7600; 7700 - Continued			5900i - Continued		
Tensioner Assy. - Hub & A.C.	3102888	38505	Idler Pulley - A.C.	3682229	36223
Idler Pulley - Fan & Alt.	3400884	36308	Tensioner Pulley - Fan & Alt.	3682946	36165
Idler Pulley - A.C.	3104139	36225	Hose - Upper - Eng. To Pipe		21135
Tensioner Pulley - A.C.	3102888	36091	Hose - Upper - Rad. To Pipe		21135
Hose - Upper - Eng. To Pipe		24240	Hose - Lower - Eng. To Pipe		24240
Hose - Upper - Rad. To Pipe		24240	Hose - Lower - Rad. To Pipe		21135
Hose - Lower - Eng. To Pipe		21135			
Hose - Lower - Rad. To Pipe		21891	9200i; 9400i		
8600			Belt - Fan & Alt.	3565410C3	♣K120911HD
Belt - Fan & Alt.	3578997C1	♣K080694HD	Belt - Hub & A.C.	3565412C1	♣K060637HD
Belt - Hub & A.C.	3579001C1	♣K060516HD	Tensioner Assy. - A.C.	3682683	38610
Tensioner Assy. - Fan & Alt.	4920105	38622	Tensioner Assy. - Fan & Alt.	3682946	38587
Tensioner Assy. - Hub & A.C.	3102888	38505	Idler Pulley - A.C.	3682229	36223
Idler Pulley - Fan & Alt.	3400884	36308	Tensioner Pulley - Fan & Alt.	3682946	36165
Idler Pulley - A.C.	3104139	36225	Hose - Upper - Eng. To Pipe		21135
Tensioner Pulley - A.C.	3102888	36091	Hose - Upper - Rad. To Pipe		21135
Hose - Upper - Eng. To Pipe		24240	Hose - Lower - Eng. To Pipe		24240
Hose - Upper - Pipe To Rad.		24240	Hose - Lower - Rad. To Pipe		21891
Hose - Lower - Eng. To Pipe		24240			
Hose - Lower - Pipe To Rad.		21891	9900i; 9900ix		
9200i; 9400i			Belt - A.C.	3565412C1	♣K060637HD
Belt - Fan & Alt.	3578998C1	♣K080740HD	Belt - Fan & Alt.	3565411C3	♣K120975HD
Belt - Hub & A.C.	3579001C1	♣K060516HD	Tensioner Assy. - A.C.	3682683	38610
Tensioner Assy. - Fan & Alt.	4920105	38622	Tensioner Assy. - Fan & Alt.	3682946	38587
Tensioner Assy. - Hub & A.C.	3102888	38505	Idler Pulley - A.C.	3682229	36223
Idler Pulley - Fan & Alt.	3400884	36308	Tensioner Pulley - Fan & Alt.	3682946	36165
Idler Pulley - A.C.	3104139	36225	Hose - Upper - Eng. To Pipe		21135
Tensioner Pulley - A.C.	3102888	36091	Hose - Upper - Rad. To Pipe		21135
Hose - Upper - Eng. To Pipe		24240	Hose - Lower - Eng. To Pipe		♣21115
Hose - Upper - Rad. To Pipe		21135	Hose - Lower - Pipe To Rad.		21891
Hose - Lower - Eng. To Pipe		24240			
Hose - Lower - Rad. To Pipe		21891	International/Navistar 570 Diesel		
Cummins ISX Diesel			7400		
5500i			Belt - Hub, Fan, Alt. & A.C.	1842468C1	♣K080952HD
Belt - Fan & Alt.	3574308C1	♣K120964HD	Tensioner Assy. - Hub, Fan, Alt. & A.C.	1841760C1	38620
Belt - Hub & A.C.	3565412C1	♣K060637HD	Hose - Upper - Eng. To Pipe		21891
Tensioner Assy. - Fan & Alt.	3682946	38587	Hose - Upper - Rad. To Pipe		24240
Tensioner Assy. - A.C.	3682683	38610	Hose - Lower - Eng. To Pipe		21135
Idler Pulley - A.C.	3682229	36223	Hose - Lower - Pipe To Cooler		21891
Tensioner Pulley - Fan & Alt.	3682946	36165	Hose - Lower - Cooler To Rad.		21891
Hose - Upper - Eng. To Pipe		21135	Hose - Lower - Cooler To Pipe		21891
Hose - Upper - Rad. To Pipe		21135			
Hose - Lower - Eng. To Pipe		24240	International/Navistar DT466 Diesel		
Hose - Lower - Rad. To Pipe		24240	4300		
Hose - Lower - Pipe To Cooler		24240	Belt - Fan, Alt. & A.C.	1842457C1	♣K080825HD
Hose - Lower - Cooler To Pipe		21135	Tensioner Assy. - Fan, Alt. & A.C.	1841760C1	38620
5600i			Hose - Upper - Eng. To Rad.		20731
Belt - Fan & Alt.	3574308C1	♣K120964HD	Hose - Lower - Eng. To Rad.		22742
Belt - Hub & A.C.	3565412C1	♣K060637HD			
Tensioner Assy. - Fan & Alt.	3682946	38587	4400		
Tensioner Assy. - A.C.	3682683	38610	Belt - Fan, Alt. & A.C.	1842457C1	♣K080825HD
Idler Pulley - A.C.	3682229	36223	Tensioner Assy. - Fan, Alt. & A.C.	1841760C1	38620
Tensioner Pulley - Fan & Alt.	3682946	36165	Hose - Upper - Eng. To Rad.		20731
Hose - Upper - Eng. To Pipe		21135	Hose - Lower - Cooler To Rad.		21891
Hose - Upper - Rad. To Pipe		21135			
Hose - Lower - Eng. To Pipe		24240	7300		
Hose - Lower - Rad. To Pipe		24240	Belt - Hub, Fan, Alt. & A.C.	1842461C1	♣K080926HD
Hose - Lower - Pipe To Cooler		24240	Tensioner Assy. - Hub, Fan, Alt. & A.C.	1841760C1	38620
Hose - Lower - Cooler To Pipe		21135	Hose - Upper - Eng. To Rad.		21194
5900i			Hose - Upper - Rad. To Pipe		24240
Belt - Fan & Alt.	3574308C1	♣K120964HD	7400		
Belt - Hub & A.C.	3565412C1	♣K060637HD	Belt - Hub, Fan, Alt. & A.C.	1842461C1	♣K080926HD
Tensioner Assy. - A.C.	3682683	38610	Tensioner Assy. - Hub, Fan, Alt. & A.C.	1841760C1	38620
Tensioner Assy. - Fan & Alt.	3682946	38587	Hose - Upper - Eng. To Rad.		21194
			Hose - Upper - Rad. To Pipe		24240
			Hose - Lower - Eng. To Pipe		21135
			Hose - Lower - Rad. To Pipe		21135
			Hose - Lower - Pipe To Cooler		24240

♣Standard Belt Available.
⊗Cut to Fit.

⊗Two Required.

Belts and Coolant Hose for Medium/Heavy-Duty Trucks (2001 & Newer)

 Medium & Heavy-Duty Trucks
(2001 & Newer)

Application	Mfr. Part No.	Our No.	Application	Mfr. Part No.	Our No.
International/Navistar - Continued			International/Navistar - Continued		
2006 - Continued			2005 - Continued		
International/Navistar DT466 Diesel - Continued			Caterpillar C11 Diesel - Continued		
CXT			8600 - Continued		
Belt - W.P., Fan, Alt. & A.C.	1842461C1	♣K080926HD	Hose - Upper - Eng. To Pipe		21135
Tensioner Assy. - Hub, Fan, Alt. & A.C.	1841760C1	38620	Hose - Upper - Rad. To Pipe		21135
Hose - Upper - Eng. To Pipe		21891	Hose - Lower - Eng. To Pipe		24240
Hose - Upper - Rad. To Pipe		24240	Hose - Lower - Rad. To Pipe		21891
Hose - Lower - Eng. To Pipe		21135	Caterpillar C13 Diesel		
Hose - Lower - Rad. To Pipe		21135	5500i		
Hose - Lower - Pipe To Cooler		21891	Belt - Fan, Alt. & A.C.	3565415C1	♣K081092HD
Hose - Lower - Cooler To Pipe		21891	Tensioner Assy. - Fan, Alt. & A.C.	2117895	38590
International/Navistar DT570 Diesel			Tensioner Pulley - Fan, Alt. & A.C.	2117895	36164
4400			Idler Pulley - Smooth	2078118	36269
Belt - Hub, Fan, Alt. & A.C.	1842466C1	K080845HD	Idler Pulley - Grooved	1979642	36341
Tensioner Assy. - Hub, Fan, Alt. & A.C.	1841760C1	38620	Hose - Upper - Eng. To Rad.		21135
Hose - Upper - Eng. To Rad.		20731	Hose - Upper - Rad. To Pipe	♣21115	
8500			Hose - Lower - Eng. To Pipe		24240
Belt - Fan, Alt. & A.C.	1842466C1	K080845HD	Hose - Lower - Rad. To Cooler		21135
Tensioner Assy. - Fan, Alt. & A.C.	1841760C1	38620	Hose - Lower - Cooler To Pipe		24240
Hose - Upper - Eng. To Rad.		21115	5600i		
RXT			Belt - Fan, Alt. & A.C.	3595415C1	♣K081092HD
Belt - Hub, Fan, Alt. & A.C.	1842466C1	K080845HD	Tensioner Assy. - Fan, Alt. & A.C.	2117895	38590
Tensioner Assy. - Hub, Fan, Alt. & A.C.	1841760C1	38620	Tensioner Pulley - Fan, Alt. & A.C.	2117895	36164
Hose - Upper - Eng. To Rad.		20731	Idler Pulley - Smooth	2078118	36269
International/Navistar HT570 Diesel			Idler Pulley - Grooved	1979642	36341
7500			Hose - Upper - Eng. To Pipe		21135
Belt - Fan, Alt. & A.C.	1842599C1	♣K080820HD	Hose - Upper - Rad. To Pipe		21135
Tensioner Assy. - Fan, Alt. & A.C.	1841760C1	38620	Hose - Lower - Eng. To Pipe		24240
Hose - Upper - Eng. To Pipe		21891	Hose - Lower - Rad. To Pipe		21135
Hose - Upper - Rad. To Pipe		24240	5900i		
Hose - Lower - Eng. To Pipe		24240	Idler Pulley - Smooth	2078118	36269
Hose - Lower - Rad. To Pipe		24244	Idler Pulley - Grooved	1979642	36341
Hose - Lower - Pipe To Cooler		24240	7600		
Hose - Lower - Cooler To Pipe		24244	Belt - Fan, Alt. & A.C.	3565415C1	♣K081092HD
International/Navistar VT275 Diesel			Tensioner Assy. - Fan, Alt. & A.C.	2117895	38590
CF500; CF600			Tensioner Pulley - Fan, Alt. & A.C.	2117895	36164
Belt - W.P., Fan, Alt. & A.C.	1846055C1	♣K081331HD	Idler Pulley - Smooth	2078118	36269
Tensioner Assy.	1844538C1	38257	Idler Pulley - Grooved	1979642	36341
International/Navistar VT365 Diesel			Hose - Upper - Eng. To Pipe		24240
4100			Hose - Upper - Rad. To Pipe		24240
Belt - Fan, Alt. & A.C.	1839963C1	♣K080830HD	Hose - Lower - Eng. To Pipe		24240
Tensioner Assy. - Fan, Alt. & A.C.	1833688C2	38556	Hose - Lower - Rad. To Pipe		20206
Hose - Upper - Eng. To Rad.		22774	7700		
Hose - Lower - Eng. To Rad.		22775	Belt - Fan, Alt. & A.C.		♣K081092HD
4200			Tensioner Assy. - Fan, Alt. & A.C.	2117895	38590
Belt - Fan, Alt. & A.C.	1839963C1	♣K080830HD	Tensioner Pulley - Fan, Alt. & A.C.	2117895	36164
Belt - Fan & Air Compr.	1843218C1	♣K060509HD	Idler Pulley - Smooth	2078118	36269
Tensioner Assy. - Fan, Alt. & A.C.	1833688C2	38556	Idler Pulley - Grooved	1979642	36341
Hose - Upper - Eng. To Rad.		22774	Hose - Upper - Eng. To Pipe		24240
Hose - Lower - Eng. To Rad.		22775	Hose - Upper - Rad. To Pipe		24240
2005			Hose - Lower - Eng. To Pipe		21891
Caterpillar C11 Diesel			Hose - Lower - Rad. To Pipe		24240
7600; 7700			Hose - Lower - Pipe To Cooler		24240
Belt - Fan, Alt. & A.C.	3565415C1	♣K081092HD	Hose - Lower - Cooler To Pipe		21891
Tensioner Assy. - Fan, Alt. & A.C.	2117895	38590	8600		
Tensioner Pulley - Fan, Alt. & A.C.	2117895	36164	Belt - Fan, Alt. & A.C.	3578774C1	♣K080944HD
Hose - Upper - Eng. To Pipe		24240	Tensioner Assy. - Fan, Alt. & A.C.	2117895	38590
Hose - Upper - Rad. To Pipe		24240	Tensioner Pulley - Fan, Alt. & A.C.	2117895	36164
Hose - Lower - Eng. To Pipe		24240	Idler Pulley - Smooth	2078118	36269
Hose - Lower - Rad. To Pipe		21891	Idler Pulley - Grooved	1979642	36341
8600			Hose - Upper - Eng. To Pipe		21135
Belt - Fan, Alt. & A.C.	3578774C1	♣K080944HD	Hose - Upper - Rad. To Pipe		21135
Tensioner Assy. - Fan, Alt. & A.C.	2117895	38590	Hose - Lower - Eng. To Pipe		24240
Tensioner Pulley - Fan, Alt. & A.C.	2117895	36164	Hose - Lower - Rad. To Pipe		21891
			Hose - Lower - Pipe To Cooler		24240
			Hose - Lower - Cooler To Pipe		21891
			8600		
			Belt - Fan, Alt. & A.C.	3578774C1	♣K080944HD
			Tensioner Assy. - Fan, Alt. & A.C.	2117895	38590
			Tensioner Pulley - Fan, Alt. & A.C.	2117895	36164
			Idler Pulley - Smooth	2078118	36269
			Idler Pulley - Grooved	1979642	36341
			Hose - Upper - Eng. To Pipe		21135
			Hose - Upper - Rad. To Pipe		21135
			Hose - Lower - Eng. To Pipe		24240
			Hose - Lower - Rad. To Pipe		21891
			9200i		
			Belt - Fan, Alt. & A.C.	3578775C2	♣K081000HD
			Tensioner Assy. - Fan, Alt. & A.C.	2117895	38590

♣Standard Belt Available.

♣Cut to Fit.

Belts and Coolant Hose for Medium/Heavy-Duty Trucks (2001 & Newer)

Medium & Heavy-Duty Trucks
(2001 & Newer)

Application	Mfr. Part No.	Our No.	Application	Mfr. Part No.	Our No.
International/Navistar - Continued			International/Navistar - Continued		
2005 - Continued			2005 - Continued		
Caterpillar C13 Diesel - Continued			Cummins ISM Diesel - Continued		
9200i - Continued			5500i; 5600i - Continued		
Tensioner Pulley - Fan, Alt. & A.C.	2117895	36164	Hose - Upper - Eng. To Pipe		24240
Idler Pulley - Smooth	2078118	36269	Hose - Upper - Rad. To Pipe		21135
Idler Pulley - Grooved	1979642	36341	Hose - Lower - Eng. To Pipe		24240
Hose - Upper - Eng. To Pipe		21135	Hose - Lower - Rad. To Pipe		21891
Hose - Upper - Rad. To Pipe		24240	5900i		
Hose - Lower - Eng. To Pipe		24240	Belt - Fan & Alt.	3579000C1	♣K080806HD
Hose - Lower - Rad. To Pipe		21891	Belt - Hub & A.C.	3579001C1	♣K060516HD
9400i			Tensioner Assy. - Fan & Alt.	4920105	38622
Belt - Fan, Alt. & A.C.	3578775C2	♣K081000HD	Tensioner Assy. - Hub & A.C.	3102888	38505
Tensioner Assy. - Fan, Alt. & A.C.	2117895	38590	Idler Pulley - Fan & Alt.	3400884	36308
Tensioner Pulley - Fan, Alt. & A.C.	2117895	36164	Idler Pulley - A.C.	3104139	36225
Idler Pulley - Smooth	2078118	36269	Tensioner Pulley - A.C.	3102888	36091
Idler Pulley - Grooved	1979642	36341	7400; 7600; 7700		
Hose - Upper - Eng. To Pipe		24240	Belt - Fan & Alt.	3579000C1	♣K080806HD
Hose - Upper - Rad. To Pipe		21135	Belt - Hub & A.C.	3579001C1	♣K060516HD
Hose - Lower - Eng. To Pipe		24240	Tensioner Assy. - Fan & Alt.	4920105	38622
Hose - Lower - Rad. To Pipe		21891	Tensioner Assy. - Hub & A.C.	3102888	38505
9900i			Idler Pulley - Fan & Alt.	3400884	36308
Idler Pulley - Smooth	2078118	36269	Idler Pulley - A.C.	3104139	36225
Idler Pulley - Grooved	1979642	36341	Tensioner Pulley - A.C.	3102888	36091
Caterpillar C15 Diesel			Hose - Upper - Eng. To Pipe		24240
5900i			Hose - Upper - Rad. To Pipe		24240
Belt - Fan & Alt.	2577919C1	♣K081088HD	Hose - Lower - Eng. To Pipe		21135
Belt - Fan To A.C.	3577920C1	♣K060555HD	Hose - Lower - Rad. To Pipe		21891
Tensioner Assy. - Fan & Alt.	2002279	38569	8600		
Tensioner Assy. - Fan To A.C.	2178938	38511	Belt - Fan & Alt.	3578997C1	♣K080694HD
Tensioner Pulley - Fan To A.C.	2178938	36091	Belt - Hub & A.C.	3579001C1	♣K060516HD
Hose - Upper - Eng. To Pipe		21891	Tensioner Assy. - Fan & Alt.	4920105	38622
Hose - Upper - Rad. To Pipe		21135	Tensioner Assy. - Hub & A.C.	3102888	38505
Hose - Lower - Eng. To Pipe		24248	Idler Pulley - Fan & Alt.	3400884	36308
Hose - Lower - Rad. To Pipe		21135	Tensioner Pulley - A.C.	3102888	36091
9400i			Hose - Upper - Eng. To Pipe		24240
Belt - Fan & Alt.	35664736C2	♣K080991HD	Hose - Upper - Pipe To Rad.		24240
Belt - Fan To A.C.	3565414C1	♣K060605HD	Hose - Lower - Eng. To Pipe		24240
Tensioner Assy. - Fan & Alt.	2002279	38569	Hose - Lower - Pipe To Rad.		21891
Tensioner Assy. - Fan To A.C.	2178938	38511	9200i		
Idler Pulley - Smooth	1979641	36091	Belt - Fan & Alt.	3578998C1	♣K080740HD
Idler Pulley - Grooved	1979642	36341	Belt - Hub & A.C.	3579001C1	♣K060516HD
Tensioner Pulley - Fan To A.C.	2178938	36091	Tensioner Assy. - Fan & Alt.	4920105	38622
Hose - Upper - Eng. To Pipe		21891	Tensioner Assy. - Hub & A.C.	3102888	38505
Hose - Upper - Rad. To Pipe		21135	Idler Pulley - Fan & Alt.	3400884	36308
Hose - Lower - Eng. To Pipe		24248	Idler Pulley - A.C.	3104139	36225
Hose - Lower - Rad. To Pipe		24240	Tensioner Pulley - A.C.	3102888	36091
9900i; 9900ix			Hose - Upper - Eng. To Pipe		24240
Belt - Fan & Alt.	3565415C1	♣K081092HD	Hose - Upper - Rad. To Pipe		21135
Belt - Fan To A.C.	3565416C1	♣K060557HD	Hose - Lower - Eng. To Pipe		24240
Tensioner Assy. - Fan & Alt.	2002279	38569	Hose - Lower - Rad. To Pipe		21891
Tensioner Assy. - Fan To A.C.	2178938	38511	9400i		
Idler Pulley - Smooth	1979641	36091	Belt - Fan & Alt.	3578998C1	♣K080740HD
Idler Pulley - Grooved	1979642	36341	Belt - Hub & A.C.	3579001C1	♣K060516HD
Tensioner Pulley - Fan To A.C.	2178938	36091	Tensioner Assy. - Fan & Alt.	3400885	38521
Hose - Upper - Eng. To Rad.		21891	Tensioner Assy. - Hub & A.C.	4004933	38505
Hose - Upper - Rad. To Pipe		21135	Idler Pulley - A.C.	3104139	36225
Hose - Lower - Eng. To Rad.		24248	Tensioner Pulley - A.C.	4004933	36091
Hose - Lower - Rad. To Pipe		24240	Idler Pulley - Fan & Alt.	3400884	36308
Cummins ISM Diesel			Hose - Upper - Eng. To Pipe		24240
5500i; 5600i			Hose - Upper - Rad. To Pipe		21135
Belt - Fan & Alt.	3579000C1	♣K080806HD	Hose - Lower - Eng. To Pipe		24240
Belt - Hub & A.C.	3579001C1	♣K060516HD	Hose - Lower - Rad. To Pipe		21891
Tensioner Assy. - Fan & Alt.	4920105	38622	Cummins ISX Diesel		
Tensioner Assy. - Hub & A.C.	3102888	38505	5500i; 5600i; 5900i		
Idler Pulley - Fan & Alt.	3400884	36308	Belt - Fan & Alt.	3574308C1	♣K120964HD
Idler Pulley - A.C.	3104139	36225	Belt - Hub & A.C.	3565412C1	♣K060637HD
Tensioner Pulley - A.C.	3102888	36091	Tensioner Assy. - A.C.	3682683	38610

♣Standard Belt Available.

Belts and Coolant Hose for Medium/Heavy-Duty Trucks (2001 & Newer)

Application	Mfr. Part No.	Our No.	Application	Mfr. Part No.	Our No.
International/Navistar - Continued			International/Navistar - Continued		
2005 - Continued			2005 - Continued		
Cummins ISX Diesel - Continued			International/Navistar DT466 Diesel - Continued		
5500i; 5600i; 5900i - Continued			7400 - Continued		
Tensioner Assy. - Fan & Alt.	3682946	38587	Hose - Lower - Rad. To Pipe		21135
Idler Pulley - A.C.	3682229	36223	Hose - Lower - Pipe To Cooler		24240
Tensioner Pulley - Fan & Alt.	3682946	36165	CXT		
Hose - Upper - Eng. To Pipe		21135	Belt - W.P., Fan, Alt. & A.C.	1842461C1	▲K080926HD
Hose - Upper - Rad. To Pipe		21135	Tensioner Assy. - Hub, Fan, Alt. & A.C.	1841760C1	38620
Hose - Lower - Eng. To Pipe		24240	Hose - Upper - Eng. To Pipe		21891
Hose - Lower - Rad. To Pipe		24240	Hose - Upper - Rad. To Pipe		24240
9200i; 9400i			Hose - Lower - Eng. To Pipe		21135
Belt - Fan & Alt.	3565410C3	▲K120911HD	Hose - Lower - Rad. To Pipe		21135
Belt - Hub & A.C.	3565412C1	▲K060637HD	Hose - Lower - Pipe To Cooler		21891
Tensioner Assy. - A.C.	3682683	38610	Hose - Lower - Cooler To Pipe		21891
Tensioner Assy. - Fan & Alt.	3682946	38587			
Idler Pulley - A.C.	3682229	36223	International/Navistar DT530 Diesel		
Tensioner Pulley - Fan & Alt.	3682946	36165	7400		
Hose - Upper - Eng. To Pipe		21135	Belt - Fan, Alt. & Hub	3543930C1	▲K080760HD
Hose - Upper - Rad. To Pipe		21135	Belt - Fan To A.C.	1841563C1	▲K060458HD
Hose - Lower - Eng. To Pipe		24240	Tensioner Assy. - Fan, Alt. & Hub	1830033C1	38514
Hose - Lower - Rad. To Pipe		21891	Tensioner Assy. - A.C.	3543883C1	38511
9900i; 9900ix			Tensioner Pulley - Fan, Alt. & Hub	1830033C1	36091
Belt - A.C.	3565412C1	▲K060637HD	Tensioner Pulley - A.C.	3543883C1	36091
Belt - Fan & Alt.	3565411C3	▲K120975HD	Hose - Upper - Eng. To Pipe		24236
Tensioner Assy. - A.C.	3682683	38610	Hose - Upper - Pipe To Rad.		24240
Tensioner Assy. - Fan & Alt.	3682946	38587	Hose - Lower - Eng. To Rad.		22762
Idler Pulley - A.C.	3682229	36223	7500		
Tensioner Pulley - Fan & Alt.	3682946	36165	Belt - Fan & Alt.	1820547C3	▲K080774HD
Hose - Upper - Eng. To Pipe		21135	Belt - Fan To A.C.	1841563C1	▲K060458HD
Hose - Upper - Rad. To Pipe		21135	Tensioner Assy. - Fan & Alt.	1830033C1	38514
Hose - Lower - Eng. To Pipe		24240	Tensioner Assy. - Fan To A.C.	3543883C1	38511
Hose - Lower - Pipe To Rad.		24240	Tensioner Pulley - Fan To A.C.	3543883C1	36091
			Tensioner Pulley - Fan & Alt.	1830033C1	36091
International/Navistar 530 Diesel			Hose - Upper - Eng. To Pipe		24236
4400			Hose - Upper - Pipe To Rad.		24240
Belt - Fan, Alt. & Hub		▲K080685HD	Hose - Lower - Eng. To Rad.		22762
Belt - Fan To A.C.	2017725C1	▲K060490HD			
Tensioner Assy. - Fan, Alt. & Hub	1830033C1	38514	International/Navistar DT570 Diesel		
Tensioner Assy. - Fan To A.C.	3543883C1	38511	4400		
Tensioner Pulley - Fan, Alt. & Hub	1830033C1	36091	Belt - Hub, Fan, Alt. & A.C.	1842466C1	K080845HD
Tensioner Pulley - Fan To A.C.	3543883C1	36091	Tensioner Assy. - Hub, Fan, Alt. & A.C.	1841760C1	38620
Hose - Upper - Eng. To Rad.		20731	Hose - Upper - Eng. To Rad.		20731
Hose - Lower - Eng. To Rad.		22742	7400		
8500			Belt - Hub, Fan, Alt. & A.C.	1842468C1	▲K080952HD
Belt - Fan & Alt.		▲K080685HD	Tensioner Assy. - Hub, Fan, Alt. & A.C.	1841760C1	38620
Belt - Fan To A.C.	2017725C1	▲K060490HD	Hose - Upper - Eng. To Pipe		21891
Tensioner Assy. - Fan & Alt.	1830033C1	38514	Hose - Upper - Rad. To Pipe		24240
Tensioner Assy. - Fan To A.C.	3543883C1	38511	Hose - Lower - Eng. To Pipe		21135
Tensioner Pulley - Fan & Alt.	1830033C1	36091	Hose - Lower - Pipe To Cooler		21891
Tensioner Pulley - Fan To A.C.	3543883C1	36091	Hose - Lower - Cooler To Rad.		21891
			Hose - Lower - Cooler To Pipe		21891
International/Navistar DT466 Diesel			International/Navistar HT570 Diesel		
4300; 4400			7500		
Belt - Fan, Alt. & A.C.	1842457C1	▲K080825HD	Belt - Fan, Alt. & A.C.	1842600C1	▲K080944HD
Tensioner Assy. - Fan, Alt. & A.C.	1841760C1	38620	Tensioner Assy. - Fan, Alt. & A.C.	1841760C1	38620
Hose - Upper - Eng. To Rad.		20731	Hose - Upper - Eng. To Pipe		21891
Hose - Lower - Eng. To Rad.		22742	Hose - Upper - Rad. To Pipe		24240
7300			Hose - Lower - Eng. To Pipe		24240
Belt - Hub, Fan, Alt. & A.C.	1842597C1	▲K080934HD	Hose - Lower - Rad. To Pipe		24244
Tensioner Assy. - Hub, Fan, Alt. & A.C.	1841760C1	38620	Hose - Lower - Pipe To Cooler		24240
7400			Hose - Lower - Cooler To Pipe		24244
Belt - Hub, Fan, Alt. & A.C.; W/93" Belt			8500; 8600		
O.C.	1842461C1	▲K080926HD	Belt - Fan, Alt. & A.C.	1842466C1	K080845HD
Belt - Hub, Fan, Alt. & A.C.; W/94" Belt			Tensioner Assy. - Fan, Alt. & A.C.	1841760C1	38620
O.C.	1842597C1	▲K080934HD			
Tensioner Assy. - Hub, Fan, Alt. & A.C.	1841760C1	38620	International/Navistar VT275 Diesel		
Hose - Upper - Eng. To Rad.		21194	CF500; CF600		
Hose - Upper - Rad. To Pipe		24240	Belt - W.P., Fan, Alt. & A.C.		
Hose - Lower - Eng. To Pipe		21135		1846055C1	▲K081331HD

▲Standard Belt Available.

Medium & Heavy-Duty Trucks
(2001 & Newer)

Belts and Coolant Hose for Medium/Heavy-Duty Trucks (2001 & Newer)

Medium & Heavy-Duty Trucks
(2001 & Newer)

Application	Mfr. Part No.	Our No.	Application	Mfr. Part No.	Our No.
International/Navistar - Continued			International/Navistar - Continued		
2005 - Continued			2004 - Continued		
International/Navistar VT275 Diesel - Continued			Caterpillar C10 Diesel - Continued		
CF500; CF600 - Continued			9200i - Continued		
Tensioner Assy.	1844538C1	38257	Hose - Lower - Rad. To Pipe		21891
International/Navistar VT365 Diesel			Caterpillar C11 Diesel		
4200			7600		
Belt - Fan, Alt. & A.C.	1839963C1	♣K080830HD	Belt - Fan, Alt. & A.C.	3565415C1	♣K081092HD
Belt - Fan & Air Compr.	1843218C1	♣K060509HD	Tensioner Assy. - Fan, Alt. & A.C.	2117895	38590
Tensioner Assy. - Fan, Alt. & A.C.	1833688C2	38556	Tensioner Pulley - Fan, Alt. & A.C.	2117895	36164
Tensioner Assy. - Fan & Air Compr.	1832711C2	38629	Hose - Upper - Eng. To Pipe		24240
Hose - Upper - Eng. To Rad.		22774	Hose - Upper - Rad. To Pipe		24240
Hose - Lower - Eng. To Rad.		22775	Hose - Lower - Eng. To Pipe		24240
2004			Hose - Lower - Rad. To Pipe		
Caterpillar C10 Diesel			21891		
5500i; 5600i			8600		
Belt - Fan & Alt.	3565420C1	♣K081005HD	Belt - Fan, Alt. & A.C.	3578774C1	♣K080944HD
Belt - Fan To A.C.	3565421C1	♣K060478HD	Tensioner Assy. - Fan, Alt. & A.C.	2117895	38590
Tensioner Assy. - Fan & Alt.	1900649	38506	Tensioner Pulley - Fan, Alt. & A.C.	2117895	36164
Tensioner Assy. - Fan To A.C.	1421987	38534	Hose - Upper - Eng. To Pipe		21135
Idler Pulley - Fan & Alt.; W/Flat Idler Pulley .	1337023	36091	Hose - Upper - Rad. To Pipe		21135
Idler Pulley - Fan & Alt.; W/Multi-Grooved			Hose - Lower		24240
Idler Pulley	1731498	36231	Caterpillar C12 Diesel		
Tensioner Pulley - Fan & Alt.	1900649	36091	5500i; 5600i		
Hose - Upper - Eng. To Pipe		21891	Belt - Fan & Alt.	3565420C1	♣K081005HD
Hose - Upper - Rad. To Pipe		21891	Belt - Fan To A.C.	3565421C1	♣K060478HD
Hose - Lower - Eng. To Pipe		24240	Tensioner Assy. - Fan & Alt.	1900649	38506
Hose - Lower - Rad. To Pipe		21891	Tensioner Assy. - Fan To A.C.	1421987	38534
7600			Idler Pulley - Fan & Alt.; W/Flat Idler Pulley .	1337023	36091
Belt - Fan & Alt.	3565420C2	♣K081005HD	Idler Pulley - Fan & Alt.; W/Multi-Grooved		
Belt - Fan To A.C.	3565421C1	♣K060478HD	Idler Pulley	1731498	36231
Tensioner Assy. - Fan & Alt.	1900649	38506	Tensioner Pulley - Fan & Alt.	1900649	36091
Tensioner Assy. - Fan To A.C.	1421987	38534	Hose - Upper - Eng. To Pipe		21891
Idler Pulley - Fan & Alt.; W/Flat Idler Pulley .	1337023	36091	Hose - Upper - Rad. To Pipe		21891
Idler Pulley - Fan & Alt.; W/Multi-Grooved			Hose - Lower - Eng. To Pipe		24240
Idler Pulley	1731498	36231	Hose - Lower - Rad. To Pipe		21891
Tensioner Pulley - Fan & Alt.	1900649	36091	5900i		
Hose - Upper - Eng. To Pipe		21135	Belt - Fan & Alt.	3565420C1	♣K081005HD
Hose - Upper - Rad. To Pipe		24240	Belt - Fan To A.C.	3565421C1	♣K060478HD
Hose - Lower - Eng. To Pipe		24240	Tensioner Assy. - Fan & Alt.	1900649	38506
Hose - Lower - Rad. To Pipe		21891	Tensioner Assy. - Fan To A.C.	1421987	38534
8600			Idler Pulley - Fan & Alt.; W/Flat Idler Pulley .	1337023	36091
Belt - Fan & Alt.	3559834C1	♣K080859HD	Idler Pulley - Fan & Alt.; W/Multi-Grooved		
Belt - Fan To A.C.	3559835C1	♣K060586HD	Idler Pulley	1731498	36231
Tensioner Assy. - Fan & Alt.	1900649	38506	Tensioner Pulley - Fan & Alt.	1900649	36091
Tensioner Assy. - Fan To A.C.	1900634	38507	Hose - Upper - Eng. To Pipe		21135
Idler Pulley - Fan & Alt.; W/Flat Idler Pulley .	1337023	36091	Hose - Upper - Rad. To Pipe		21135
Idler Pulley - Fan & Alt.; W/Multi-Grooved			Hose - Lower - Eng. To Pipe		24240
Idler Pulley	1731498	36231	Hose - Lower - Rad. To Pipe		21135
Tensioner Pulley - Fan & Alt.	1900649	36091	7600		
Tensioner Pulley - Fan To A.C.	1900634	36091	Belt - Fan & Alt.	3565420C2	♣K081005HD
Hose - Upper - Eng. To Pipe		24240	Belt - Fan To A.C.	3565421C1	♣K060478HD
Hose - Upper - Pipe To Rad.		21135	Tensioner Assy. - Fan & Alt.	1900649	38506
Hose - Lower - Eng. To Pipe		24240	Tensioner Assy. - Fan To A.C.	1421987	38534
Hose - Lower - Pipe To Rad.		21891	Idler Pulley - Fan & Alt.; W/Flat Idler Pulley .	1337023	36091
9200i			Idler Pulley - Fan & Alt.; W/Multi-Grooved		
Belt - Fan & Alt.	3571272C2	♣K080915HD	Idler Pulley	1731498	36231
Belt - Fan To A.C.	3571274C1	♣K060523HD	Tensioner Pulley - Fan & Alt.	1900649	36091
Tensioner Assy. - Fan & Alt.	1900649	38506	Hose - Upper - Eng. To Pipe		21135
Tensioner Assy. - Fan To A.C.	1900634	38507	Hose - Upper - Rad. To Pipe		24240
Idler Pulley - Fan & Alt.; W/Flat Idler Pulley .	1337023	36091	Hose - Lower - Eng. To Pipe		24240
Idler Pulley - Fan & Alt.; W/Multi-Grooved			Hose - Lower - Rad. To Pipe		21891
Idler Pulley	1731498	36231	8600		
Tensioner Pulley - Fan & Alt.	1900649	36091	Belt - Fan & Alt.	3559834C1	♣K080859HD
Tensioner Pulley - Fan To A.C.	1900634	36091	Belt - Fan To A.C.	3559835C1	♣K060586HD
Hose - Upper - Eng. To Rad.		21135	Tensioner Assy. - Fan & Alt.	1900649	38506
Hose - Upper - Rad. To Pipe		21135	Tensioner Assy. - Fan To A.C.	1900634	38507
Hose - Lower - Eng. To Rad.		24240	Idler Pulley - Fan & Alt.; W/Flat Idler Pulley .	1337023	36091

♣Standard Belt Available.

Belts and Coolant Hose for Medium/Heavy-Duty Trucks (2001 & Newer)

Application	Mfr. Part No.	Our No.	Application	Mfr. Part No.	Our No.
International/Navistar - Continued			International/Navistar - Continued		
2004 - Continued			2004 - Continued		
Caterpillar C12 Diesel - Continued			Caterpillar C13 Diesel - Continued		
8600 - Continued			9400i - Continued		
Idler Pulley - Fan & Alt.; W/Multi-Grooved			Hose - Lower - Eng. To Pipe		24240
Idler Pulley	1731498	36231	Hose - Lower - Rad. To Pipe		21891
Tensioner Pulley - Fan & Alt.	1900649	36091	9900i		
Tensioner Pulley - Fan To A.C.	1900634	36091	Idler Pulley - Smooth	2078118	36269
Hose - Upper - Eng. To Pipe		24240	Idler Pulley - Grooved	1979642	36341
Hose - Upper - Pipe To Rad.		21135	Caterpillar C15 Diesel		
Hose - Lower - Eng. To Pipe		24240	5600i		
Hose - Lower - Pipe To Rad.		21891	Belt - A.C.	3577920C1	♣K060555HD
9200i			Tensioner Assy. - Fan & Alt.	2002279	38569
Belt - Fan & Alt.	3571272C2	♣K080915HD	Tensioner Assy. - Fan To A.C.	2178938	38511
Belt - Fan To A.C.	3571274C1	♣K060523HD	Tensioner Pulley - Fan To A.C.	2178938	36091
Tensioner Assy. - Fan & Alt.	1900649	38506	5900i		
Tensioner Assy. - Fan To A.C.	1900634	38507	Belt - Fan & Alt.	2577919C1	♣K081088HD
Idler Pulley - Fan & Alt.; W/Flat Idler Pulley	1337023	36091	Belt - Fan To A.C.	3577920C1	♣K060555HD
Idler Pulley - Fan & Alt.; W/Multi-Grooved			Tensioner Assy. - Fan & Alt.	2002279	38569
Idler Pulley	1731498	36231	Tensioner Assy. - Fan To A.C.	2178938	38511
Tensioner Pulley - Fan & Alt.	1900649	36091	Tensioner Pulley - Fan To A.C.	2178938	36091
Tensioner Pulley - Fan To A.C.	1900634	36091	Hose - Upper - Eng. To Pipe		21891
Hose - Upper - Eng. To Rad.		21135	Hose - Upper - Rad. To Pipe		21135
Hose - Upper - Rad. To Pipe		21135	Hose - Lower - Eng. To Pipe		24248
Hose - Lower - Eng. To Rad.		24240	Hose - Lower - Rad. To Pipe		21135
Hose - Lower - Rad. To Pipe		21891	9200i		
9900i			Belt - Fan & Alt.	2018284C1	♣K100771HD
Belt - A.C.		♣K060470HD	Belt - Fan & A.C.	2005148C1	♣K060500HD
Idler Pulley - Fan & Alt.; W/Flat Idler Pulley	1337023	36091	Hose - Upper - Eng. To Pipe		24240
Idler Pulley - Fan & Alt.; W/Multi-Grooved			Hose - Upper - Pipe To Rad.		21135
Idler Pulley	1731498	36231	Hose - Lower - Eng. To Pipe		24240
Caterpillar C13 Diesel			Hose - Lower - Pipe To Rad.		21135
7600			9400i		
Belt - Fan, Alt. & A.C.	3565415C1	♣K081092HD	Belt - Fan & Alt.	3565413C2	♣K080991HD
Tensioner Assy. - Fan, Alt. & A.C.	2117895	38590	Belt - Fan To A.C.	3565414C1	♣K060605HD
Tensioner Pulley - Fan, Alt. & A.C.	2117895	36164	Tensioner Assy. - Fan & Alt.	2002279	38569
Idler Pulley - Smooth	2078118	36269	Tensioner Assy. - Fan To A.C.	2178938	38511
Idler Pulley - Grooved	1979642	36341	Idler Pulley - Smooth	1979641	36091
Hose - Upper - Eng. To Pipe		24240	Idler Pulley - Grooved	1979642	36341
Hose - Upper - Rad. To Pipe		24240	Tensioner Pulley - Fan To A.C.	2178938	36091
Hose - Lower - Eng. To Pipe		24240	9900i; 9900ix		
Hose - Lower - Rad. To Pipe		20206	Belt - Fan & Alt.	3565415C1	♣K081092HD
8600			Belt - Fan To A.C.	3565416C1	♣K060557HD
Belt - Fan, Alt. & A.C.	3578774C1	♣K080944HD	Tensioner Assy. - Fan & Alt.	2002279	38569
Tensioner Assy. - Fan, Alt. & A.C.	2117895	38590	Tensioner Assy. - Fan To A.C.	2178938	38511
Tensioner Pulley - Fan, Alt. & A.C.	2117895	36164	Idler Pulley - Smooth	1979641	36091
Idler Pulley - Smooth	2078118	36269	Idler Pulley - Grooved	1979642	36341
Idler Pulley - Grooved	1979642	36341	Tensioner Pulley - Fan To A.C.	2178938	36091
Hose - Upper - Eng. To Pipe		21135	Hose - Upper - Eng. To Rad.		21891
Hose - Upper - Rad. To Pipe		21135	Hose - Upper - Rad. To Pipe		21135
Hose - Lower		24240	Hose - Lower - Eng. To Rad.		24248
9200i			Hose - Lower - Rad. To Pipe		24240
Belt - Fan, Alt. & A.C.	3578775C2	♣K081000HD	Cummins ISM Diesel		
Tensioner Assy. - Fan, Alt. & A.C.	2117895	38590	5500i; 5600i; 5900i		
Tensioner Pulley - Fan, Alt. & A.C.	2117895	36164	Belt - Fan & Alt.	3579000C1	♣K080806HD
Idler Pulley - Smooth	2078118	36269	Belt - Hub & A.C.	3579001C1	♣K060516HD
Idler Pulley - Grooved	1979642	36341	Tensioner Assy. - Fan & Alt.	3400885	38521
Hose - Upper - Eng. To Pipe		21135	Tensioner Assy. - Hub & A.C.	3102888	38505
Hose - Upper - Rad. To Pipe		24240	Idler Pulley - A.C.	3104139	36225
Hose - Lower - Eng. To Pipe		24240	Idler Pulley - Fan & Alt.	3400884	36308
Hose - Lower - Rad. To Pipe		21891	Tensioner Pulley - A.C.	3102888	36091
9400i			Hose - Upper - Eng. To Pipe		24240
Belt - Fan, Alt. & A.C.	3578775C2	♣K081000HD	Hose - Upper - Rad. To Pipe		21135
Tensioner Assy. - Fan, Alt. & A.C.	2117895	38590	Hose - Lower - Eng. To Pipe		24240
Tensioner Pulley - Fan, Alt. & A.C.	2117895	36164	Hose - Lower - Rad. To Pipe		24240
Idler Pulley - Smooth	2078118	36269	7600		
Idler Pulley - Grooved	1979642	36341	Belt - Fan & Alt.	3579000C1	♣K080806HD
Hose - Upper - Eng. To Pipe		24240			
Hose - Upper - Rad. To Pipe		24240			
Hose - Lower - Rad. To Pipe		21135			

♣Standard Belt Available.

Medium & Heavy-Duty Trucks
(2001 & Newer)

Belts and Coolant Hose for Medium/Heavy-Duty Trucks (2001 & Newer)

Medium & Heavy-Duty Trucks
(2001 & Newer)

Application	Mfr. Part No.	Our No.	Application	Mfr. Part No.	Our No.
International/Navistar - Continued			International/Navistar - Continued		
2004 - Continued			2004 - Continued		
Cummins ISM Diesel - Continued			Cummins ISX Diesel - Continued		
7600 - Continued			9200i - Continued		
Belt - Hub & A.C.	3579001C1	♣K060516HD	Hose - Upper - Eng. To Pipe		21135
Tensioner Assy. - Fan & Alt.	3400885	38521	Hose - Upper - Rad. To Pipe		21135
Tensioner Assy. - Hub & A.C.	3102888	38505	Hose - Lower - Eng. To Pipe		24240
Idler Pulley - A.C.	3104139	36225	Hose - Lower - Pipe To Rad.		21891
Idler Pulley - Fan & Alt.	3400884	36308	9400i		
Tensioner Pulley - A.C.	3102888	36091	Belt - Fan & Alt.	3565410C3	♣K120911HD
Hose - Upper - Eng. To Pipe		24240	Belt - A.C.	3565412C1	♣K060637HD
Hose - Upper - Rad. To Pipe		24240	Tensioner Assy. - A.C.	3682683	38610
Hose - Lower - Eng. To Cooler		21135	Tensioner Assy. - Fan & Alt.	3682946	38587
Hose - Lower - Rad. To Cooler		21891	Idler Pulley - A.C.	3682229	36223
8600			Tensioner Pulley - Fan & Alt.	3682946	36165
Belt - Fan & Alt.	3578997C1	♣K080694HD	Hose - Upper - Eng. To Pipe		21135
Belt - Hub & A.C.	3579001C1	♣K060516HD	Hose - Upper - Rad. To Pipe		21135
Tensioner Assy. - Fan & Alt.	3400885	38521	Hose - Lower - Eng. To Pipe		24240
Tensioner Assy. - Hub & A.C.	3102888	38505	Hose - Lower - Pipe To Rad.		21891
Idler Pulley - A.C.	3104139	36225	9900i; 9900ix		
Tensioner Pulley - A.C.	4004933	36091	Belt - Fan & Alt.	3565411C3	♣K120975HD
Idler Pulley - Fan & Alt.	3400884	36308	Belt - A.C.	3565412C1	♣K060637HD
Hose - Upper - Eng. To Pipe		24240	Tensioner Assy. - A.C.	3682683	38610
Hose - Upper - Pipe To Rad.		24240	Tensioner Assy. - Fan & Alt.	3682946	38587
Hose - Lower - Eng. To Pipe		24240	Idler Pulley - A.C.	3682229	36223
Hose - Lower - Pipe To Rad.		21891	Tensioner Pulley - Fan & Alt.	3682946	36165
9200i; 9400i			Hose - Upper - Eng. To Pipe		21135
Belt - Fan & Alt.	3578998C1	♣K080740HD	Hose - Upper - Rad. To Pipe		21135
Belt - Hub & A.C.	3579001C1	♣K060516HD	Hose - Lower - Eng. To Pipe		24240
Tensioner Assy. - Fan & Alt.	3400885	38521	Hose - Lower - Pipe To Rad.		24240
Tensioner Assy. - Hub & A.C.	4004933	38505	International/Navistar 530 Diesel		
Idler Pulley - A.C.	3104139	36225	4400		
Tensioner Pulley - A.C.	4004933	36091	Belt - Fan, Alt. & Hub		♣K080685HD
Idler Pulley - Fan & Alt.	3400884	36308	Belt - Fan To A.C.	2017725C1	♣K060490HD
Hose - Upper - Eng. To Pipe		24240	Tensioner Assy. - Fan, Alt. & Hub	1830033C1	38514
Hose - Upper - Rad. To Pipe		21135	Tensioner Assy. - Fan To A.C.	3543883C1	38511
Hose - Lower - Eng. To Pipe		24240	Tensioner Pulley - Fan, Alt. & Hub	1830033C1	36091
Hose - Lower - Rad. To Pipe		21891	Tensioner Pulley - Fan To A.C.	3543883C1	36091
Cummins ISX Diesel			Hose - Upper - Eng. To Rad.		20731
5500i			Hose - Lower - Eng. To Rad.		22742
Belt - Fan & Alt.	3574308C1	♣K120964HD	8500		
Belt - Hub & A.C.	3565412C1	♣K060637HD	Belt - Fan & Alt.		♣K080685HD
Tensioner Assy. - A.C.	3682683	38610	Belt - Fan To A.C.	2017725C1	♣K060490HD
Tensioner Assy. - Fan & Alt.	3682946	38587	Tensioner Assy. - Fan & Alt.	1830033C1	38514
Idler Pulley - A.C.	3682229	36223	Tensioner Assy. - Fan To A.C.	3543883C1	38511
Tensioner Pulley - Fan & Alt.	3682946	36165	Tensioner Pulley - Fan & Alt.	1830033C1	36091
Hose - Upper - Eng. To Pipe		21135	Tensioner Pulley - Fan To A.C.	3543883C1	36091
Hose - Upper - Rad. To Pipe		21135	International/Navistar DT466 Diesel		
Hose - Lower - Eng. To Pipe		24240	4300; 4400		
Hose - Lower - Rad. To Pipe		24240	Belt - Fan, Alt. & Hub	1833009C1	♣K080702HD
5900i			Belt - Fan To A.C.	1830641C2	♣K060490HD
Belt - Fan & Alt.	3574308C1	♣K120964HD	Tensioner Assy. - Fan, Alt. & Hub	1830033C1	38514
Belt - Hub & A.C.	3565412C1	♣K060637HD	Tensioner Assy. - Fan To A.C.	3543883C1	38511
Tensioner Assy. - A.C.	3682683	38610	Tensioner Pulley - Fan, Alt. & Hub	1830033C1	36091
Tensioner Assy. - Fan & Alt.	3682946	38587	Tensioner Pulley - Fan To A.C.	3543883C1	36091
Idler Pulley - A.C.	3682229	36223	Hose - Upper - Eng. To Rad.		20731
Tensioner Pulley - Fan & Alt.	3682946	36165	Hose - Lower - Eng. To Rad.		22742
Hose - Upper - Eng. To Pipe		21135	International/Navistar DT530 Diesel		
Hose - Upper - Rad. To Pipe		21135	7400		
Hose - Lower - Eng. To Pipe		24240	Belt - Fan, Alt. & Hub	3543930C1	♣K080760HD
Hose - Lower - Rad. To Pipe		21135	Belt - Fan To A.C.	1841563C1	♣K060458HD
9200j			Tensioner Assy. - Fan, Alt. & Hub	1830033C1	38514
Belt - Fan & Alt.		♣K120901HD	Tensioner Assy. - A.C.	3543883C1	38511
Belt - A.C.	3565412C1	♣K060637HD	Tensioner Pulley - Fan, Alt. & Hub	1830033C1	36091
Tensioner Assy. - A.C.	3682683	38610	Tensioner Pulley - A.C.	3543883C1	36091
Tensioner Assy. - Fan & Alt.	3682946	38587	Hose - Upper - Eng. To Pipe		24236
Idler Pulley - A.C.	3682229	36223	Hose - Upper - Pipe To Rad.		24240
Tensioner Pulley - Fan & Alt.	3682946	36165			

♣Standard Belt Available.

Belts and Coolant Hose for Medium/Heavy-Duty Trucks (2001 & Newer)

Application	Mfr. Part No.	Our No.	Application	Mfr. Part No.	Our No.
International/Navistar - Continued			International/Navistar - Continued		
2004 - Continued			2003 - Continued		
International/Navistar DT530 Diesel - Continued			Caterpillar C10 Diesel - Continued		
7400 - Continued			5500i; 5600i - Continued		
Hose - Lower - Eng. To Rad.		22762	Belt - Fan To A.C.	3565421C1	♣K060478HD
7500			Tensioner Assy. - Fan & Alt.	1900649	38506
Belt - Fan & Alt.	1820547C3	♣K080774HD	Tensioner Assy. - Fan To A.C.	1421987	38534
Belt - Fan To A.C.	1841563C1	♣K060458HD	Idler Pulley - Fan & Alt.; W/Flat Idler Pulley .	1337023	36091
Tensioner Assy. - Fan & Alt.	1830033C1	38514	Idler Pulley - Fan & Alt.; W/Multi-Grooved		
Tensioner Assy. - Fan To A.C.	3543883C1	38511	Idler Pulley	1731498	36231
Tensioner Pulley - Fan To A.C.	3543883C1	36091	Tensioner Pulley - Fan & Alt.	1900649	36091
Tensioner Pulley - Fan & Alt.	1830033C1	36091	Hose - Upper - Eng. To Pipe		21891
Hose - Upper - Eng. To Pipe		24236	Hose - Upper - Rad. To Pipe		21891
Hose - Upper - Pipe To Rad.		24240	Hose - Lower - Eng. To Pipe		24240
Hose - Lower - Eng. To Rad.		22762	Hose - Lower - Rad. To Pipe		21891
International/Navistar DT570 Diesel			5900i		
4400			Belt - Fan & Alt.	3565420C1	♣K081005HD
Belt - Hub, Fan, Alt. & A.C.	1842466C1	K080845HD	Belt - Fan To A.C.	3565421C1	♣K060478HD
Tensioner Assy. - Hub, Fan, Alt. & A.C.	1841760C1	38620	Tensioner Assy. - Fan & Alt.	1900649	38506
Hose - Upper - Eng. To Rad.		20731	Tensioner Assy. - Fan To A.C.	1421987	38534
International/Navistar HT570 Diesel			Idler Pulley - Fan & Alt.; W/Flat Idler Pulley .		
7500			Idler Pulley - Fan & Alt.; W/Multi-Grooved		
Belt - Fan, Alt. & A.C.	1842600C1	♣K080944HD	Idler Pulley	1731498	36231
Tensioner Assy. - Fan, Alt. & A.C.	1841760C1		Tensioner Pulley - Fan & Alt.	1900649	36091
Hose - Upper - Eng. To Pipe		21891	Hose - Upper - Eng. To Pipe		21135
Hose - Upper - Rad. To Pipe		24240	Hose - Upper - Rad. To Pipe		21135
Hose - Lower - Eng. To Pipe		24240	Hose - Lower - Eng. To Pipe		24240
Hose - Lower - Rad. To Pipe		24244	Hose - Lower - Rad. To Pipe		21135
Hose - Lower - Pipe To Cooler		24240			
Hose - Lower - Cooler To Pipe		24244	7600		
International/Navistar VT365 Diesel			Belt - Fan & Alt.		
4200			Belt - Fan To A.C.	3561002C1	♣K080986HD
Belt - Fan, Alt. & A.C.	1839963C1	♣K080830HD	Belt - Fan To A.C.	3561003C1	♣K060483HD
Belt - Fan To Compr.	1843218C1	♣K060509HD	Tensioner Assy. - Fan & Alt.	1900649	38506
Tensioner Assy. - Fan, Alt. & A.C.	1833688C1	38556	Tensioner Assy. - Fan To A.C.	1900634	38507
Tensioner Assy. - Air Brake Compr.	1832711C2	38629	Idler Pulley - Fan & Alt.; W/Flat Idler Pulley .	1337023	36091
Hose - Upper - Eng. To Rad.		22774	Idler Pulley - Fan & Alt.; W/Multi-Grooved		
Hose - Lower - Eng. To Rad.		22775	Idler Pulley	1731498	36231
2003			Tensioner Pulley - Fan & Alt.		
Caterpillar 3406 Diesel			Tensioner Pulley - Fan To A.C.		
5900i			Hose - Upper - Eng. To Pipe		
Belt - A.C.	3577920C1	♣K060555HD	Hose - Upper - Pipe To Rad.		
Belt - Fan & Alt.	3577919C1	♣K081088HD	Hose - Lower - Eng. To Pipe		
Tensioner Assy. - A.C.	1900642	38508	Hose - Lower - Rad. To Pipe		
Tensioner Assy. - Fan & Alt.	1900649	38506			
Hose - Upper - Rad. To Pipe		21135	8100; 8600		
Hose - Upper - Eng. To Pipe		≠21891	Belt - Fan & Alt.		
Hose - Lower - Eng. To Pipe		≠24248	Belt - Fan To A.C.		
Hose - Lower - Rad. To Pipe		21135	Tensioner Assy. - Fan & Alt.		
7600			Tensioner Assy. - Fan To A.C.		
Belt - Fan & Alt.	3561002C1	♣K080986HD	Idler Pulley - Fan & Alt.; W/Flat Idler Pulley .		
Belt - Fan & A.C.	3561003C1	♣K060483HD	Idler Pulley - Fan & Alt.; W/Multi-Grooved		
Caterpillar C10 Diesel			Idler Pulley		
2554; 2574; 2654; 2674			Tensioner Pulley - Fan & Alt.		
Belt - Fan	3561002C1	♣K080986HD	Tensioner Pulley - Fan To A.C.		
Belt - Fan To Alt. & A.C.	3561003C1	♣K060483HD	Hose - Upper - Eng. To Pipe		
Idler Pulley - Fan & Alt.; W/Flat Idler Pulley .	1337023	36091	Hose - Upper - Pipe To Rad.		
Idler Pulley - Fan & Alt.; W/Multi-Grooved			Hose - Lower - Eng. To Pipe		
Idler Pulley	1731498	36231	Hose - Lower - Rad. To Pipe		
Hose - Upper - Eng. To Pipe		21891			
Hose - Upper - Pipe To Rad.		24240	9100i; 9200i		
Hose - Lower - Eng. To Rad.		24240	Belt - Fan & Alt.		
Hose - Lower - Pipe To Rad.		21891	Belt - Fan & A.C.; Preferred Belt		
5500i; 5600i			Belt - Fan & A.C.; Optional Belt		
Belt - Fan & Alt.	3565420C1	♣K081005HD	Hose - Upper - Eng. To Pipe		
			Hose - Upper - Pipe To Rad.		
			Hose - Lower - Eng. To Pipe		
			Hose - Lower - Rad. To Pipe		
			Caterpillar C12 Diesel		
			2554; 2574; 2654; 2674		
			Belt - Fan		
			Belt - Fan To Alt. & A.C.		
			Idler Pulley - Fan & Alt.; W/Flat Idler Pulley .		

♣Standard Belt Available.
 ⊗Two Required.

≠Cut to Fit.

Belts and Coolant Hose for Medium/Heavy-Duty Trucks (2001 & Newer)

Medium & Heavy-Duty Trucks
(2001 & Newer)

Application	Mfr. Part No.	Our No.	Application	Mfr. Part No.	Our No.
International/Navistar - Continued			International/Navistar - Continued		
2003 - Continued			2003 - Continued		
Caterpillar C12 Diesel - Continued			Caterpillar C12 Diesel - Continued		
2554; 2574; 2654; 2674 - Continued			9100i - Continued		
Idler Pulley - Fan & Alt.; W/Multi-Grooved			Hose - Lower - Eng. To Pipe		
Idler Pulley	1731498	36231	Hose - Lower - Rad. To Pipe		21891
Hose - Upper - Eng. To Pipe		21891			21135
Hose - Upper - Pipe To Rad.		24240	9200i		
Hose - Lower - Eng. To Rad.		24240	Belt - Fan & Alt.	1618533C1	▲K080733HD
Hose - Lower - Pipe To Rad.		21891	Belt - Fan & A.C.; Preferred Belt	149635R2	2/9463PB
5500i; 5600i			Belt - Fan & A.C.; Optional Belt		②▲9463HD
Belt - Fan & Alt.	3565420C1	▲K081005HD	Idler Pulley - Fan & Alt.; W/Flat Idler Pulley .	1337023	36091
Belt - Fan To A.C.	3565421C1	▲K060478HD	Idler Pulley - Fan & Alt.; W/Multi-Grooved		
Tensioner Assy. - Fan & Alt.	1900649	38506	Idler Pulley	1731498	36231
Tensioner Assy. - Fan To A.C.	1421987	38534	Hose - Upper - Eng. To Pipe		21135
Idler Pulley - Fan & Alt.; W/Flat Idler Pulley .	1337023	36091	Hose - Upper - Pipe To Rad.		24240
Idler Pulley - Fan & Alt.; W/Multi-Grooved			Hose - Lower - Eng. To Pipe		21891
Idler Pulley	1731498	36231	Hose - Lower - Rad. To Pipe		21135
Tensioner Pulley - Fan & Alt.	1900649	36091	9400i		
Hose - Upper - Eng. To Pipe		21891	Belt - Fan & Alt.	1618533C1	▲K080733HD
Hose - Upper - Rad. To Pipe		21891	Belt - Fan & A.C.; Preferred Belt	149635R2	2/9463PB
Hose - Lower - Eng. To Pipe		24240	Belt - Fan & A.C.; Optional Belt		②▲9463HD
Hose - Lower - Rad. To Pipe		21891	Hose - Upper - Eng. To Pipe		21135
5900i			Hose - Upper - Pipe To Rad.		24240
Belt - Fan & Alt.	3565420C1	▲K081005HD	Hose - Lower - Eng. To Pipe		21891
Belt - Fan To A.C.	3565421C1	▲K060478HD	Hose - Lower - Rad. To Pipe		21135
Tensioner Assy. - Fan & Alt.	1900649	38506	9900i; 9900ix		
Tensioner Assy. - Fan To A.C.	1421987	38534	Belt - Fan & Alt.	1618533C1	▲K080733HD
Idler Pulley - Fan & Alt.; W/Flat Idler Pulley .	1337023	36091	Belt - Fan & A.C.; Preferred Belt	149635R2	2/9463PB
Idler Pulley - Fan & Alt.; W/Multi-Grooved			Belt - Fan & A.C.; Optional Belt		②▲9463HD
Idler Pulley	1731498	36231	Idler Pulley - Fan & Alt.; W/Flat Idler Pulley .	1337023	36091
Tensioner Pulley - Fan & Alt.	1900649	36091	Idler Pulley - Fan & Alt.; W/Multi-Grooved		
Hose - Upper - Eng. To Pipe		21135	Idler Pulley	1731498	36231
Hose - Upper - Rad. To Pipe		21135	Hose - Upper - Eng. To Pipe		21135
Hose - Lower - Eng. To Pipe		24240	Hose - Upper - Pipe To Rad.		24240
Hose - Lower - Rad. To Pipe		21135	Hose - Lower - Eng. To Pipe		21891
7600			Hose - Lower - Rad. To Pipe		21135
Belt - Fan & Alt.	3561002C1	▲K080986HD	Caterpillar C15 Diesel		
Belt - Fan To A.C.	3561003C1	▲K060483HD	5900i		
Tensioner Assy. - Fan & Alt.	1900649	38506	Belt - Alt.	3577919C1	▲K081088HD
Tensioner Assy. - Fan To A.C.	1900634	38507	Belt - A.C.	3577920C1	▲K060555HD
Idler Pulley - Fan & Alt.; W/Flat Idler Pulley .	1337023	36091	9200i; 9400i; 9900i; 9900ix		
Idler Pulley - Fan & Alt.; W/Multi-Grooved			Belt - Fan & Alt.	2018284C1	▲K100771HD
Idler Pulley	1731498	36231	Belt - Fan & A.C.	2005148C1	▲K060500HD
Tensioner Pulley - Fan & Alt.	1900649	36091	Hose - Upper - Eng. To Pipe		24240
Tensioner Pulley - Fan To A.C.	1900634	36091	Hose - Upper - Pipe To Rad.		21135
Hose - Upper - Eng. To Pipe		21135	Hose - Lower - Eng. To Pipe		24240
Hose - Upper - Pipe To Rad.		24240	Hose - Lower - Pipe To Rad.		21135
Hose - Lower - Eng. To Pipe		24240	Caterpillar C16 Diesel		
Hose - Lower - Pipe To Rad.		21891	9200i; 9400i; 9900i		
8600			Belt - Fan & Alt.	2018284C1	▲K100771HD
Belt - Fan & Alt.	3559834C1	▲K080859HD	Belt - Fan & A.C.	2005148C1	▲K060500HD
Belt - Fan To A.C.	3559835C1	▲K060586HD	Hose - Upper - Eng. To Pipe		24240
Tensioner Assy. - Fan & Alt.	1900649	38506	Hose - Upper - Pipe To Rad.		21135
Tensioner Assy. - Fan To A.C.	1900634	38507	Hose - Lower - Eng. To Pipe		24240
Idler Pulley - Fan & Alt.; W/Flat Idler Pulley .	1337023	36091	Hose - Lower - Pipe To Rad.		21135
Idler Pulley - Fan & Alt.; W/Multi-Grooved			Cummins ISM Diesel		
Idler Pulley	1731498	36231	2674		
Tensioner Pulley - Fan & Alt.	1900649	36091	Belt - Fan	1648750C1	▲K080605HD
Tensioner Pulley - Fan To A.C.	1900634	36091	Belt - Hub & Alt.	586452C1	▲K050336HD
Hose - Upper - Eng. To Pipe		21135	Belt - Hub & A.C.	2016338C1	TR22485
Hose - Upper - Pipe To Rad.		21135	5500i; 5600i; 5900i		
Hose - Lower - Eng. To Pipe		24240	Belt - Fan & Alt.	3579000C1	▲K080806HD
Hose - Lower - Pipe To Rad.		21891	Belt - Hub & A.C.	3579001C1	▲K060516HD
9100i			Tensioner Assy. - Fan & Alt.	3400885	38521
Belt - Fan & Alt.	1618533C1	▲K080733HD	Tensioner Assy. - Hub & A.C.	3102888	38505
Belt - Fan & A.C.; Preferred Belt	149635R2	2/9463PB	Idler Pulley - A.C.	3104139	36225
Belt - Fan & A.C.; Optional Belt		②▲9463HD	Idler Pulley - Fan & Alt.	3400884	36308
Hose - Upper - Eng. To Pipe		21135			
Hose - Upper - Pipe To Rad.		24240			

▲Standard Belt Available.

②Two Required.

Belts and Coolant Hose for Medium/Heavy-Duty Trucks (2001 & Newer)

Application	Mfr. Part No.	Our No.	Application	Mfr. Part No.	Our No.
International/Navistar - Continued			International/Navistar - Continued		
2003 - Continued			2003 - Continued		
Cummins ISM Diesel - Continued			Cummins ISX Diesel		
5500i; 5600i; 5900i - Continued			5500i		
Tensioner Pulley - A.C.	3102888	36091	Belt - Fan & Alt.	3574308C1	♣K120964HD
Hose - Upper - Eng. To Pipe		24240	Belt - Hub & A.C.	3565412C1	♣K060637HD
Hose - Upper - Rad. To Pipe		21135	Tensioner Assy. - A.C.	3682683	38610
Hose - Lower - Eng. To Pipe		24240	Tensioner Assy. - Fan & Alt.	3682946	38587
Hose - Lower - Rad. To Pipe		24240	Idler Pulley - A.C.	3682229	36223
7600			Tensioner Pulley - Fan & Alt.	3682946	36165
Belt - Fan & Alt.	3579000C1	♣K080806HD	Hose - Upper - Eng. To Pipe		21135
Belt - Hub & A.C.	3579001C1	♣K060516HD	Hose - Upper - Rad. To Pipe		21135
Tensioner Assy. - Fan & Alt.	3400885	38521	Hose - Lower - Eng. To Pipe		24240
Tensioner Assy. - Hub & A.C.	3102888	38505	Hose - Lower - Rad. To Pipe		24240
Idler Pulley - A.C.	3104139	36225	5900i		
Idler Pulley - Fan & Alt.	3400884	36308	Belt - Fan & Alt.	3574308C1	♣K120964HD
Tensioner Pulley - A.C.	3102888	36091	Belt - Hub & A.C.	3565412C1	♣K060637HD
Hose - Upper - Eng. To Pipe		24240	Tensioner Assy. - A.C.	3682683	38610
Hose - Upper - Rad. To Pipe		24240	Tensioner Assy. - Fan & Alt.	3682946	38587
Hose - Lower - Eng. To Cooler		21135	Idler Pulley - A.C.	3682229	36223
Hose - Lower - Rad. To Cooler		21891	Tensioner Pulley - Fan & Alt.	3682946	36165
8100			Hose - Upper - Eng. To Pipe		21135
Belt - Fan 1648750C1		♣K080605HD	Hose - Upper - Rad. To Pipe		21135
Belt - Hub & Alt. 586452C1		♣K050336HD	Hose - Lower - Eng. To Pipe		24240
Belt - Hub & A.C. 2016338C1		TR22485	Hose - Lower - Rad. To Pipe		21135
Hose - Upper - Eng. To Pipe		24240	9100i		
Hose - Upper - Pipe To Rad.		21135	Belt - Fan 3681819		♣K100719HD
Hose - Lower - Eng. To Pipe		24240	Belt - W.P. & A.C. 3681812		♣K060685HD
Hose - Lower - Pipe To Rad.		21194	Tensioner Assy. - Fan 3681240		38535
8600			Tensioner Assy. - W.P. & A.C. 3680194		38532
Belt - Fan & Alt. 3578097C1		♣K080694HD	Idler Pulley - Alt. & A.C. 4026886		36226
Belt - Hub & A.C. 3579001C1		♣K060516HD	Tensioner Pulley - Fan 3681240		36092
Tensioner Assy. - Fan & Alt. 3400885		38521	Tensioner Pulley - W.P. & A.C. 3680194		36095
Tensioner Assy. - Hub & A.C. 4004933		38505	Hose - Upper - Eng. To Pipe		24240
Idler Pulley - Fan & Alt. 3400884		36308	Hose - Upper - Pipe To Rad.		21135
Tensioner Pulley - A.C. 4004933		36091	Hose - Lower - Eng. To Pipe		21891
Hose - Upper - Eng. To Pipe		24236	Hose - Lower - Pipe To Rad.		21135
Hose - Upper - Pipe To Rad.		24240	9200i		
Hose - Lower - Eng. To Pipe		24240	Belt - Fan & Alt.		♣K120901HD
Hose - Lower - Pipe To Rad.		21891	Belt - A.C. 3565412C1		♣K060637HD
9100i			Tensioner Assy. - A.C. 3682683		38610
Belt - Fan 1651399C1		♣K080565HD	Tensioner Assy. - Fan & Alt. 3682946		38587
Belt - Hub & Alt. 586452C1		♣K050336HD	Idler Pulley - A.C. 3682229		36223
Belt - Hub & A.C. 2016338C1		TR22485	Tensioner Pulley - Fan & Alt. 3682946		36165
Hose - Upper - Eng. To Pipe		24240	Hose - Upper - Eng. To Pipe		21135
Hose - Upper - Pipe To Rad.		21135	Hose - Upper - Rad. To Pipe		21135
Hose - Lower - Eng. To Pipe		21135	Hose - Lower - Eng. To Pipe		24240
Hose - Lower - Pipe To Rad.		24240	Hose - Lower - Pipe To Rad.		21891
9200i			9400i		
Belt - Fan & Alt. 3578998C1		♣K080740HD	Belt - Fan & Alt. 3565411C3		♣K120975HD
Belt - Hub & A.C. 3579001C1		♣K060516HD	Belt - A.C. 3565412C1		♣K060637HD
Tensioner Assy. - Fan & Alt. 3400885		38521	Tensioner Assy. - A.C. 3682683		38610
Tensioner Assy. - Hub & A.C. 4004933		38505	Tensioner Assy. - Fan & Alt. 3682946		38587
Idler Pulley - Fan & Alt. 3400884		36308	Idler Pulley - A.C. 3682229		36223
Tensioner Pulley - A.C. 4004933		36091	Tensioner Pulley - Fan & Alt. 3682946		36165
Hose - Upper - Eng. To Pipe		24240	Hose - Upper - Eng. To Pipe		21135
Hose - Upper - Rad. To Pipe		21135	Hose - Upper - Rad. To Pipe		21135
Hose - Lower - Eng. To Pipe		24240	Hose - Lower - Eng. To Pipe		24240
Hose - Lower - Rad. To Pipe		21891	Hose - Lower - Pipe To Rad.		21891
9400i; 9900i			9900i		
Belt - Fan 1651399C1		♣K080565HD	Belt - Fan; W/O Clean Air Pkg. 3681819		♣K100719HD
Belt - Hub & Alt. 586452C1		♣K050336HD	Belt - Fan & Alt.; W/Clean Air Pkg. 3565411C3		♣K120975HD
Belt - Hub & A.C. 2016338C1		TR22485	Belt - W.P. & A.C.; W/O Clean Air Pkg. 3681812		♣K060685HD
Hose - Upper - Eng. To Pipe		24240	Belt - W.P. & A.C.; W/Clean Air Pkg. 3565412C1		♣K060637HD
Hose - Upper - Pipe To Rad.		21135	Tensioner Assy. - Fan; W/O Clean Air Pkg. 3681240		38535
Hose - Lower - Eng. To Pipe		21135	Tensioner Assy. - Fan & Alt.; W/Clean Air Pkg. 3682946		38587
Hose - Lower - Pipe To Rad.		24240	Tensioner Assy. - W.P. & A.C.; W/O Clean Air Pkg. 3680194		38532

♣Standard Belt Available.

Medium & Heavy-Duty Trucks
(2001 & Newer)

Belts and Coolant Hose for Medium/Heavy-Duty Trucks (2001 & Newer)

Medium & Heavy-Duty Trucks
(2001 & Newer)

Application	Mfr. Part No.	Our No.	Application	Mfr. Part No.	Our No.
International/Navistar - Continued			International/Navistar - Continued		
2003 - Continued			2003 - Continued		
Cummins ISX Diesel - Continued			Cummins N14 Diesel - Continued		
9900i - Continued			9100i - Continued		
Tensioner Assy. - W.P. & A.C.; W/Clean Air Pkg.	3682683	38610	Hose - Lower - Eng. To Pipe		24240
Idler Pulley - Alt. & A.C.; W/O Clean Air Pkg.	4026886	36226	Hose - Lower - Pipe To Rad.		21135
Idler Pulley - A.C.; W/Clean Air Pkg.	3682229	36223	9200i; 9400i; 9900i; 9900ix		
Tensioner Pulley - Fan & Alt.; W/Clean Air Pkg.	3682946	36165	Belt - Hub & W.P.	3076492	♣K060425HD
Tensioner Pulley - Fan; W/O Clean Air Pkg.	3681240	36092	Belt - Hub & Fan	3501266C1	♣K100465HD
Tensioner Pulley - W.P. & A.C.; W/O Clean Air Pkg.	3680194	36095	Belt - Alt.	598183C1	♣9447HD
Hose - Upper - Eng. To Pipe		21135	Belt - Hub & A.C.		♣9405HD
Hose - Upper - Pipe To Rad.		21891	Hose - Upper - Eng. To Pipe		24240
Hose - Upper - Rad. To Pipe		21135	Hose - Upper - Pipe To Rad.		21135
Hose - Lower - Eng. To Pipe		24240	Hose - Lower - Eng. To Pipe		24240
Hose - Lower - Pipe To Rad.		24240	Hose - Lower - Pipe To Rad.		21135
9900ix			Detroit Diesel 6-Cyl. 12.7 L Diesel		
Belt - Fan; W/O Clean Air Pkg.	3681819	♣K100719HD	9100i		
Belt - Fan & Alt.; W/Clean Air Pkg.	3565411C3	♣K120975HD	Belt - Fan	3503813C1	♣K100570HD
Belt - W.P. & A.C.; W/O Clean Air Pkg.	3681812	♣K060685HD	Belt - Alt.	3560719C1	♣K080605HD
Belt - W.P. & A.C.; W/Clean Air Pkg.	3565412C1	♣K060637HD	Belt - A.C.	3514954C1	♣K060340HD
Tensioner Assy. - Fan; W/O Clean Air Pkg.	3681240	38535	Tensioner Assy. - Fan	3508604C91	38529
Tensioner Assy. - Fan & Alt.; W/Clean Air Pkg.	3682946	38587	Tensioner Pulley - Fan	3508604C91	36092
Tensioner Assy. - W.P. & A.C.; W/O Clean Air Pkg.	3680194	38532	9200i; 9400i; 9900i		
Tensioner Assy. - W.P. & A.C.; W/Clean Air Pkg.	3682683	38610	Belt - Fan	1687800C1	♣K100540HD
Idler Pulley - Alt. & A.C.; W/O Clean Air Pkg.	4026886	36226	Hose - Upper - Eng. To Pipe		24240
Idler Pulley - W.P. & A.C.; W/Clean Air Pkg.	3682229	36223	Hose - Upper - Rad. To Pipe		21135
Tensioner Pulley - Fan & Alt.; W/Clean Air Pkg.	3682946	36165	Hose - Lower - Eng. To Pipe		24240
Tensioner Pulley - Fan; W/O Clean Air Pkg.	3681240	36092	Hose - Lower - Rad. To Pipe		21135
Tensioner Pulley - W.P. & A.C.; W/O Clean Air Pkg.	3680194	36095	International/Navistar 530 Diesel		
Hose - Upper - Eng. To Pipe		21135	4400		
Hose - Upper - Pipe To Rad.		21891	Belt - Fan, Alt. & Hub		♣K080685HD
Hose - Upper - Rad. To Pipe		21135	Belt - Fan To A.C.	2017725C1	♣K060490HD
Hose - Lower - Eng. To Pipe		24240	Tensioner Assy. - Fan, Alt. & Hub	1830033C1	38514
Hose - Lower - Pipe To Rad.		24240	Tensioner Assy. - Fan To A.C.	3543883C1	38511
Cummins N14 Diesel			Tensioner Pulley - Fan, Alt. & Hub	1830033C1	36091
2574			Tensioner Pulley - Fan To A.C.	3543883C1	36091
Belt - Fan		②TR28522	Hose - Upper - Eng. To Pipe		20731
Belt - Alt.		♣9447HD	Hose - Lower - Eng. To Rad.		22742
Belt - W.P.	3076492	♣K060425HD	7400; 7500		
Belt - A.C.		♣9405HD	Belt - Fan, Alt. & Hub	3543930C1	♣K080760HD
5500i; 5600i; 5900i			Belt - Fan To A.C.		♣K060458HD
Belt - Hub & W.P.	3865157	♣K060408HD	Tensioner Assy. - Fan, Alt. & Hub	1830033C1	38514
Belt - Hub & Fan	479577C1	②TR28522	Tensioner Assy. - Fan To A.C.	3543883C1	38511
Belt - Alt.	598183C1	②♣9447HD	Tensioner Pulley - Fan, Alt. & Hub	1830033C1	36091
Belt - Hub & A.C.	196666R1	♣9405HD	Tensioner Pulley - Fan To A.C.	3543883C1	36091
Hose - Upper - Eng. To Pipe		24240	Hose - Upper - Eng. To Pipe		24236
Hose - Upper - Pipe To Rad.		21891	Hose - Upper - Pipe To Rad.		24244
Hose - Lower - Eng. To Pipe		24240	Hose - Lower - Eng. To Rad.		22762
Hose - Lower - Pipe To Rad.		21891	8100		
9100i			Belt - Fan, Alt. & Hub	168297C1	♣K080760HD
Belt - W.P.	3095880	♣K060415HD	Belt - Fan & A.C.	3517822C1	♣K060478HD
Belt - Fan	3501266C1	♣K100465HD	Tensioner Assy. - Fan, Alt. & Hub	1830033C1	38514
Belt - Alt.; Preferred Belt	598183C1	2/9447PB	Tensioner Assy. - Fan & A.C.	1687819C92	38512
Belt - Alt.; Optional Belt		②♣9447HD	Tensioner Pulley - Fan, Alt. & Hub	1830033C1	36091
Belt - Hub & A.C.	196666R1	♣9405HD	Tensioner Pulley - Fan & A.C.	1687819C92	36091
Hose - Upper - Eng. To Pipe		24240	Hose - Upper - Eng. To Pipe		24240
Hose - Upper - Pipe To Rad.		21135	Hose - Upper - Pipe To Rad.		21135
			Hose - Lower - Eng. To Pipe		♣21891
			Hose - Lower - Pipe To Rad.		♣21891
			8500		
			Belt - Fan & Alt.		♣K080685HD
			Belt - Fan To A.C.	2017725C1	♣K060490HD
			Tensioner Assy. - Fan & Alt.	1830033C1	38514
			Tensioner Assy. - Fan To A.C.	3543883C1	38511
			Tensioner Pulley - Fan & Alt.	1830033C1	36091
			Tensioner Pulley - Fan To A.C.	3543883C1	36091

♣Standard Belt Available.
∞Cut to Fit.

②Two Required.

Belts and Coolant Hose for Medium/Heavy-Duty Trucks (2001 & Newer)

Application	Mfr. Part No.	Our No.	Application	Mfr. Part No.	Our No.
International/Navistar - Continued			International/Navistar - Continued		
2003 - Continued			2002 - Continued		
International/Navistar DT466 Diesel			Caterpillar C10 Diesel - Continued		
2574			2574; 2674 - Continued		
Belt - Fan, Alt. & Hub	1820547C2	♣K080774HD	Belt - A.C.	L17446	♣9447HD
4300; 4400			5500i		
Belt - Fan, Alt. & Hub	1833009C1	♣K080702HD	Belt - Fan & Alt.	3507969C1	♣K080780HD
Belt - Fan To A.C.	1830641C2	♣K060490HD	Belt - Fan & A.C.	311175C2	♣9447HD
Tensioner Assy. - Fan, Alt. & Hub	1830033C1	38514	Hose - Upper - Eng. To Pipe		21335
Tensioner Assy. - Fan To A.C.	3543883C1	38511	Hose - Upper - Pipe To Rad.		24240
Tensioner Pulley - Fan, Alt. & Hub	1830033C1	36091	Hose - Lower - Eng. To Pipe		24240
Tensioner Pulley - Fan To A.C.	3543883C1	36091	Hose - Lower - Pipe To Rad.		24240
Hose - Upper - Eng. To Rad.		20731	5600i; 5900i		
Hose - Lower - Eng. To Rad.		22742	Belt - Fan & Alt.	3507969C1	♣K080780HD
4800			Belt - Fan & A.C.	311175C2	♣9447HD
Belt - Fan & Alt.; W/P.T.O.; W/1.2 To 1 Fan			Tensioner Assy. - Fan & Alt.	1333529	38506
Ratio	1819391C1	♣K080730HD	Idler Pulley - Fan & Alt.; W/Flat Idler Pulley .	1337023	36091
Belt - Fan & Alt.; W/P.T.O.; W/Mechanical			Idler Pulley - Fan & Alt.; W/Multi-Grooved		
Eng.; W/1.08 To 1 Fan Ratio	1682696C1	♣K080738HD	Idler Pulley	1731498	36231
Belt - Fan & Alt.; W/P.T.O.; W/Electronic			Tensioner Pulley - Fan & Alt.	1333529	36091
Eng.; W/1.08 To 1 Fan Ratio	1820547C2	♣K080774HD	Hose - Upper - Eng. To Pipe		21335
Belt - Fan & Alt.; W/O P.T.O.	1822503C1	♣K080726HD	Hose - Upper - Pipe To Rad.		24240
Belt - A.C.	1687797C1	♣K060470HD	Hose - Lower - Eng. To Pipe		24240
Tensioner Assy. - Fan & Alt.	1814719C1	38514	Hose - Lower - Pipe To Rad.		24240
Tensioner Assy. - Fan To A.C.	1687819C91	38511	7600		
Tensioner Pulley - Fan & Alt.	1814719C1	36091	Belt - Fan & Alt.	3561002C1	♣K080986HD
Tensioner Pulley - Fan To A.C.	1687819C91	36091	Belt - Fan To A.C.	3561003C1	♣K060483HD
Hose - Upper - Eng. To Rad.		21765	Tensioner Assy. - Fan & Alt.	1900649	38506
Hose - Lower - Eng. To Pipe		21842	Tensioner Assy. - Fan To A.C.	1900634	38507
Hose - Lower - Pipe To Rad.		21115	Idler Pulley - Fan & Alt.; W/Flat Idler Pulley .	1337023	36091
Hose - Lower - Eng. To Rad.		21842	Idler Pulley - Fan & Alt.; W/Multi-Grooved		
7300			Idler Pulley	1731498	36231
Belt - Fan & Alt.	1820547C3	♣K080774HD	Tensioner Pulley - Fan & Alt.	1900649	36091
Belt - Fan To A.C.	1841563C1	♣K060458HD	Tensioner Pulley - Fan To A.C.	1900634	36091
Tensioner Assy. - Fan & Alt.	1830033C1	38514	Hose - Upper - Eng. To Pipe		21135
Tensioner Assy. - Fan To A.C.	3543883C1	38511	Hose - Upper - Pipe To Rad.		24240
Tensioner Pulley - Fan To A.C.	3543883C1	36091	Hose - Lower - Eng. To Pipe		24240
Tensioner Pulley - Fan & Alt.	1830033C1	36091	Hose - Lower - Pipe To Rad.		21891
7400			8100		
Belt - Fan & Alt.; W/A.C.	1820547C3	♣K080774HD	Belt - Fan & Alt.	3559834C1	♣K080859HD
Belt - Fan To A.C.	1841563C1	♣K060458HD	Belt - Fan To A.C.	3559835C1	♣K060586HD
Belt - Fan & Alt.; W/O A.C.	1842459C1	K080801HD	Tensioner Assy. - Fan & Alt.	1900649	38506
Tensioner Assy. - Fan & Alt.	1830033C1	38514	Tensioner Assy. - Fan To A.C.	1900634	38507
Tensioner Assy. - Fan To A.C.	3543883C1	38511	Idler Pulley - Fan & Alt.; W/Flat Idler Pulley .	1337023	36091
Tensioner Pulley - Fan To A.C.	3543883C1	36091	Idler Pulley - Fan & Alt.; W/Multi-Grooved		
Tensioner Pulley - Fan & Alt.	1830033C1	36091	Idler Pulley	1731498	36231
Hose - Upper - Eng. To Pipe		24236	Tensioner Pulley - Fan & Alt.	1900649	36091
Hose - Upper - Pipe To Rad.		24240	Tensioner Pulley - Fan To A.C.	1900634	36091
Hose - Lower - Eng. To Rad.		22762	Hose - Upper - Eng. To Pipe		21135
International/Navistar T444 Diesel			Hose - Upper - Pipe To Rad.		21135
1652 SC			Hose - Lower - Eng. To Pipe		24240
Belt - W.P., Fan & Alt.; W/O Air Brake			Hose - Lower - Pipe To Rad.		21891
Compr.; W/O Schwitzer Fan Clutch	1822830C1	♣K080893HD	9100i; 9200i; 9400i; 9900i; 9900ix		
Idler Pulley; W/Flat Idler Pulley	1822652C91	36287	Belt - Fan & Alt.	1618533C1	♣K080733HD
Idler Pulley; W/V-Groove Idler Pulley	1822653C91	36288	Belt - Fan & A.C.; Preferred Belt	149635R2	2/9463PB
International/Navistar VT365 Diesel			Belt - Fan & A.C.; Optional Belt		♣9463HD
4200; 4300; 4400			Hose - Upper - Eng. To Pipe		21135
Belt - Fan, Alt. & A.C.	1839963C1	♣K080830HD	Hose - Upper - Pipe To Rad.		24240
Belt - Fan & Air Compr.	1833620C1	♣K060525HD	Hose - Lower - Eng. To Pipe		21891
Tensioner Assy. - Fan, Alt. & A.C.	1833688C1	38556	Hose - Lower - Rad. To Pipe		21135
Tensioner Assy. - Fan & Air Compr.	1832711C2	38629	Caterpillar C12 Diesel		
Hose - Upper - Eng. To Rad.		22774	2574; 2674		
Hose - Lower - Eng. To Rad.		22775	Belt - Fan & Alt.	1841558C1	♣K080755HD
2002			Belt - A.C.	L17446	♣9447HD
Caterpillar C10 Diesel			5500i; 5600i; 5900i		
2574; 2674			Belt - Fan & Alt.	3507969C1	♣K080780HD
Belt - Fan & Alt.	1841558C1	♣K080755HD	Belt - Fan & A.C.	311175C2	♣9447HD
			Tensioner Assy. - Fan & Alt.	1333529	38506

♣Standard Belt Available.

②Two Required.

Medium & Heavy-Duty Trucks
(2001 & Newer)

Belts and Coolant Hose for Medium/Heavy-Duty Trucks (2001 & Newer)

Medium & Heavy-Duty Trucks
(2001 & Newer)

Application	Mfr. Part No.	Our No.	Application	Mfr. Part No.	Our No.
International/Navistar - Continued			International/Navistar - Continued		
2002 - Continued			2002 - Continued		
Caterpillar C12 Diesel - Continued			Cummins ISM Diesel - Continued		
5500i; 5600i; 5900i - Continued			8100 - Continued		
Idler Pulley - Fan & Alt.; W/Flat Idler Pulley .	1337023	36091	Hose - Upper - Eng. To Pipe		24240
Idler Pulley - Fan & Alt.; W/Multi-Grooved			Hose - Upper - Pipe To Rad.		21135
Idler Pulley	1731498	36231	Hose - Lower - Eng. To Pipe		24240
Tensioner Pulley - Fan & Alt.	1333529	36091	Hose - Lower - Pipe To Rad.		21194
Hose - Upper - Eng. To Pipe		21335	9100i; 9200i; 9400i; 9900i; 9900ix		
Hose - Upper - Pipe To Rad.		24240	Belt - Fan	1651399C1	▲K080565HD
Hose - Lower - Eng. To Pipe		24240	Belt - Hub & Alt.	586452C1	▲K050336HD
Hose - Lower - Pipe To Rad.		24240	Belt - Hub & A.C.	2016338C1	TR22485
7600			Hose - Upper - Eng. To Pipe		24240
Belt - Fan & Alt.	3561002C1	▲K080986HD	Hose - Upper - Pipe To Rad.		21135
Belt - Fan To A.C.	3561003C1	▲K060483HD	Hose - Lower - Eng. To Pipe		21135
Tensioner Assy. - Fan & Alt.	1900649	38506	Hose - Lower - Pipe To Rad.		24240
Tensioner Assy. - Fan To A.C.	1900634	38507	Cummins ISX Diesel		
Idler Pulley - Fan & Alt.; W/Flat Idler Pulley .	1337023	36091	9100i		
Idler Pulley - Fan & Alt.; W/Multi-Grooved			Belt - Fan	3681819	▲K100719HD
Idler Pulley	1731498	36231	Belt - W.P., Alt. & A.C.	3681812	▲K060685HD
Tensioner Pulley - Fan & Alt.	1900649	36091	Tensioner Assy. - Fan	3681240	38535
Tensioner Pulley - Fan To A.C.	1900634	36091	Tensioner Assy. - Hub, Alt. & A.C.	3680194	38532
Hose - Upper - Eng. To Pipe		21135	Idler Pulley - Alt. & A.C.	4026886	36226
Hose - Upper - Pipe To Rad.		24240	Tensioner Pulley - Fan	3681240	36092
Hose - Lower - Eng. To Pipe		24240	Tensioner Pulley - Hub, Alt. & A.C.	3680194	36095
Hose - Lower - Pipe To Rad.		21891	Hose - Upper - Eng. To Pipe		24240
9100i; 9200i; 9400i; 9900i; 9900ix			Hose - Upper - Pipe To Rad.		21135
Belt - Fan & Alt.	1618533C1	▲K080733HD	Hose - Lower - Eng. To Pipe		21891
Belt - Fan & A.C.; Preferred Belt	149635R2	2/9463PB	Hose - Lower - Pipe To Rad.		21135
Belt - Fan & A.C.; Optional Belt		②▲9463HD	9400i; 9900i; 9900ix		
Hose - Upper - Eng. To Pipe		21135	Belt - Fan	3681819	▲K100719HD
Hose - Upper - Pipe To Rad.		24240	Belt - W.P., Alt. & A.C.	3681812	▲K060685HD
Hose - Lower - Eng. To Pipe		21891	Tensioner Assy. - Fan	3681240	38535
Hose - Lower - Rad. To Pipe		21135	Tensioner Assy. - W.P., Alt. & A.C.	3680194	38532
Caterpillar C15 Diesel			Idler Pulley - Alt. & A.C.	4026886	36226
9400i; 9900i; 9900ix			Tensioner Pulley - Fan	3681240	36092
Belt - Fan & Alt.	2018284C1	▲K100771HD	Tensioner Pulley - W.P., Alt. & A.C.	3680194	36095
Belt - Fan & A.C.	2005148C1	▲K060500HD	Hose - Upper - Eng. To Pipe		21135
Hose - Upper - Eng. To Pipe		24240	Hose - Upper - Pipe To Rad.		21891
Hose - Upper - Pipe To Rad.		21135	Hose - Lower - Eng. To Pipe		21891
Hose - Lower - Eng. To Pipe		24240	Hose - Lower - Pipe To Rad.		21135
Hose - Lower - Pipe To Rad.		21135	Cummins N14 Diesel		
Caterpillar C16 Diesel			2674		
9400i; 9900i; 9900ix			Belt - Fan	28523	TR28522
Belt - Fan & Alt.	2018284C1	▲K100771HD	Belt - Alt.	17445	▲9447HD
Belt - Fan & A.C.	2005148C1	▲K060500HD	Belt - A.C.	17405	▲9405HD
Hose - Upper - Eng. To Pipe		24240	Belt - W.P.	3076492	▲K060425HD
Hose - Upper - Pipe To Rad.		21135	5500i; 5600i; 5900i		
Hose - Lower - Eng. To Pipe		24240	Belt - Hub & W.P.	3865157	▲K060408HD
Hose - Lower - Pipe To Rad.		21135	Belt - Hub & Fan	479577C1	②TR28522
Cummins ISM Diesel			Belt - Alt.	598183C1	②▲9447HD
5500i; 5600i; 5900i			Belt - Hub & A.C.	196666R1	▲9405HD
Belt - Fan & Alt.	3579000C1	▲K080806HD	Hose - Upper - Eng. To Pipe		24240
Belt - Hub & A.C.	3579001C1	▲K060516HD	Hose - Upper - Pipe To Rad.		21891
Tensioner Assy. - Fan & Alt.	3400885	38521	Hose - Lower - Eng. To Pipe		24240
Tensioner Assy. - Hub & A.C.	3102888	38505	Hose - Lower - Pipe To Rad.		21891
Idler Pulley - A.C.	3104139	36225	9100i; 9200i; 9400i; 9900i; 9900ix		
Idler Pulley - Fan & Alt.	3400884	36308	Belt - W.P.	3095880	▲K060415HD
Tensioner Pulley - A.C.	3102888	36091	Belt - Fan	3501266C1	▲K100465HD
Hose - Upper - Eng. To Pipe		24240	Belt - Alt.; Preferred Belt	598183C1	2/9447PB
Hose - Upper - Rad. To Pipe		21135	Belt - Alt.; Optional Belt		②▲9447HD
Hose - Lower - Eng. To Pipe		24240	Belt - Hub & A.C.	196666R1	▲9405HD
Hose - Lower - Rad. To Pipe		24240	Hose - Upper - Eng. To Pipe		24240
8100			Hose - Upper - Pipe To Rad.		21135
Belt - Fan	1648750C1	▲K080605HD	Hose - Lower - Eng. To Pipe		24240
Belt - Hub & Alt.	586452C1	▲K050336HD	Hose - Lower - Pipe To Rad.		21135
Belt - Hub & A.C.	2016338C1	TR22485			

▲Standard Belt Available.

②Two Required.

Belts and Coolant Hose for Medium/Heavy-Duty Trucks (2001 & Newer)

Application	Mfr. Part No.	Our No.	Application	Mfr. Part No.	Our No.
International/Navistar - Continued			International/Navistar - Continued		
2002 - Continued			2002 - Continued		
Cummins Signature 600 Diesel			International/Navistar 530 Diesel - Continued		
9200i			8500		
Belt - Fan	3529218C1	♣K100719HD	Belt - Fan & Alt.	3541491C1	♣K080685HD
Belt - Hub, Alt. & A.C.	3527406C2	♣K060680HD	Belt - Fan To A.C.	2017725C1	♣K060490HD
Tensioner Assy. - Fan	3681240	38535	Tensioner Assy. - Fan & Alt.	1830033C1	38514
Tensioner Assy. - Hub, Alt. & A.C.	3680194	38532	Tensioner Assy. - Fan To A.C.	3543883C1	38511
Idler Pulley - Alt. & A.C.	4026886	36226	Tensioner Pulley - Fan & Alt.	1830033C1	36091
Tensioner Pulley - Fan	3681240	36092	Tensioner Pulley - Fan To A.C.	3543883C1	36091
Tensioner Pulley - Hub, Alt. & A.C.	3680194	36095			
Detroit Diesel 6-Cyl. 12.7 L Diesel			International/Navistar DT466 Diesel		
9100i; 9200i; 9400i; 9900i; 9900ix			2554; 2574; 2654		
Belt - Fan	1687800C1	♣K100540HD	Belt - Fan, Alt. & Hub	1820547C2	♣K080774HD
Hose - Upper - Eng. To Pipe		24240	Tensioner Assy. - Fan, Alt. & Hub	1830033C1	38514
Hose - Upper - Rad. To Pipe		21135	Tensioner Pulley - Fan, Alt. & Hub	1830033C1	36091
Hose - Lower - Eng. To Pipe		24240	Hose - Upper - Eng. To Pipe		24240
Hose - Lower - Rad. To Pipe		21135	Hose - Upper - Pipe To Rad.		24240
			Hose - Lower - Eng. To Pipe		24240
			Hose - Lower - Pipe To Rad.		24240
International/Navistar 530 Diesel			4300; 4400		
2554; 2654			Belt - Fan, Alt. & Hub		
Belt - Fan, Alt. & Hub	168297C1	♣K080760HD	Belt - Fan To A.C.	2017725C1	♣K060490HD
Belt - Fan & A.C.	3515596C1	♣K060470HD	Tensioner Assy. - Fan, Alt. & Hub	1830033C1	38514
Tensioner Assy. - Fan, Alt. & Hub	1830033C1	38514	Tensioner Assy. - Fan To A.C.	3543883C1	38511
Tensioner Assy. - Fan & A.C.	1687819C92	38512	Tensioner Pulley - Fan, Alt. & Hub	1830033C1	36091
Tensioner Pulley - Fan, Alt. & Hub	1830033C1	36091	Tensioner Pulley - Fan To A.C.	3543883C1	36091
Tensioner Pulley - Fan & A.C.	1687819C92	36091	Hose - Upper - Eng. To Rad.		20731
Hose - Upper - Eng. To Rad.		22140	Hose - Lower - Eng. To Rad.		22742
Hose - Lower - Eng. To Rad.		♣<21115			
4400			4700		
Belt - Fan, Alt. & Hub		♣K080685HD	Belt - Fan & Alt.; W/P.T.O.; W/1.2 To 1 Fan Ratio	1819391C1	♣K080730HD
Belt - Fan To A.C.	2017725C1	♣K060490HD	Belt - Fan & Alt.; W/P.T.O.; W/Mechanical Eng.; W/1.08 To 1 Fan Ratio	1682696C1	♣K080738HD
Tensioner Assy. - Fan, Alt. & Hub	1830033C1	38514	Belt - Fan & Alt.; W/P.T.O.; W/Electronic Eng.; W/1.08 To 1 Fan Ratio	1820547C2	♣K080774HD
Tensioner Assy. - Fan To A.C.	3543883C1	38511	Belt - Fan & Alt.; W/O P.T.O.	1822503C1	♣K080726HD
Tensioner Pulley - Fan, Alt. & Hub	1830033C1	36091	Belt - Fan & A.C.	3516596C1	♣K060470HD
Tensioner Pulley - Fan To A.C.	3543883C1	36091	Tensioner Assy. - Fan & Alt.	1830033C1	38514
Hose - Upper - Eng. To Rad.		20731	Tensioner Assy. - Fan & A.C.	1687819C92	38512
Hose - Lower - Eng. To Rad.		22742	Tensioner Pulley - Fan & Alt.	1830033C1	36091
			Tensioner Pulley - Fan & A.C.	1687819C92	36091
4700; 4800; 4900			Hose - Upper - Eng. To Rad.		
Belt - Fan, Alt. & Hub	1819392C1	♣K080716HD	Hose - Lower - Eng. To Rad.		♣<21115
Belt - Fan & A.C.	3515596C1	♣K060470HD			
Tensioner Assy. - Fan, Alt. & Hub	1830033C1	38514	4800		
Tensioner Assy. - Fan & A.C.	1687819C92	38512	Belt - Fan & Alt.; W/P.T.O.; W/1.2 To 1 Fan Ratio		
Tensioner Pulley - Fan, Alt. & Hub	1830033C1	36091	Belt - Fan & Alt.; W/P.T.O.; W/Mechanical Eng.; W/1.08 To 1 Fan Ratio		
Tensioner Pulley - Fan & A.C.	1687819C92	36091	Belt - Fan & Alt.; W/P.T.O.; W/Electronic Eng.; W/1.08 To 1 Fan Ratio		
Hose - Upper - Eng. To Rad.		22140	Belt - Fan & Alt.; W/O P.T.O.		
Hose - Lower - Eng. To Rad.		♣<21115	Belt - Fan To A.C.		
7400; 7500			Tensioner Assy. - Fan & Alt.		
Belt - Fan, Alt. & Hub	3543930C1	♣K080760HD	Tensioner Assy. - Fan To A.C.		
Belt - Fan To A.C.	3503871C1	♣K060458HD	Tensioner Pulley - Fan, Alt. & Hub		
Tensioner Assy. - Fan, Alt. & Hub	1830033C1	38514	Tensioner Pulley - Fan To A.C.		
Tensioner Assy. - Fan To A.C.	3543883C1	38511	Hose - Upper - Eng. To Pipe		
Tensioner Pulley - Fan, Alt. & Hub	1830033C1	36091	Hose - Upper - Pipe To Rad.		
Tensioner Pulley - Fan To A.C.	3543883C1	36091	Hose - Lower - Eng. To Rad.		
Hose - Upper - Eng. To Pipe		24236			
Hose - Upper - Pipe To Rad.		24244			
Hose - Lower - Eng. To Rad.		22762			
8100					
Belt - Fan, Alt. & Hub	168297C1	♣K080760HD			
Belt - Fan & A.C.	3517822C1	♣K060478HD			
Tensioner Assy. - Fan, Alt. & Hub	1830033C1	38514			
Tensioner Assy. - Fan & A.C.	1687819C92	38512			
Tensioner Pulley - Fan, Alt. & Hub	1830033C1	36091			
Tensioner Pulley - Fan & A.C.	1687819C92	36091			
Hose - Upper - Eng. To Pipe		24240			
Hose - Upper - Pipe To Rad.		21135			
Hose - Lower - Eng. To Pipe		♣<21891			
Hose - Lower - Pipe To Rad.		♣<21891			

♣Standard Belt Available.

♣<Cut to Fit.

Medium & Heavy-Duty Trucks (2001 & Newer)

Belts and Coolant Hose for Medium/Heavy-Duty Trucks (2001 & Newer)

Medium & Heavy-Duty Trucks
(2001 & Newer)

Application	Mfr. Part No.	Our No.	Application	Mfr. Part No.	Our No.
International/Navistar - Continued			International/Navistar - Continued		
2002 - Continued			2001		
International/Navistar DT466 Diesel - Continued			Caterpillar C10 Diesel		
4900 - Continued			2574		
Tensioner Assy. - Fan & Alt.	1830033C1	38514	Belt - Fan & Alt.	1841558C1	♣K080755HD
Tensioner Assy. - Fan To A.C.	1687819C92	38512	Belt - A.C.	L17446	♣9447HD
Tensioner Pulley - Fan & Alt.	1830033C1	36091	2674		
Tensioner Pulley - Fan To A.C.	1687819C92	36091	Belt - Fan & Alt.	1682697C1	♣K080760HD
Hose - Lower - Eng. To Rad.		21891	Belt - Fan To A.C.		♣9447HD
5500i; 5600i			Hose - Upper - Eng. To Pipe		
Belt - Fan & Alt.	1841558C1	♣K080755HD	Hose - Upper - Pipe To Rad.		21135
Belt - A.C.	3515596C1	♣K060470HD	Hose - Lower - Eng. To Pipe		24240
Tensioner Assy. - Fan & Alt.	1830033C1	38514	Hose - Lower - Pipe To Rad.		21891
Tensioner Assy. - Fan & A.C.	1687819C92	38512	5500i; 5600i; 5900i		
Tensioner Pulley - Fan & Alt.	1830033C1	36091	Belt - Fan & Alt.	3507969C1	♣K080780HD
Tensioner Pulley - Fan & A.C.	1687819C92	36091	Belt - Fan & A.C.	311175C2	♣9447HD
7300			Hose - Upper - Eng. To Pipe		
Belt - Fan & Alt.	1820547C3	♣K080774HD	Hose - Upper - Pipe To Rad.		21335
Belt - Fan To A.C.	1841563C1	♣K060458HD	Hose - Lower - Eng. To Pipe		24240
Tensioner Assy. - Fan & Alt.	1830033C1	38514	Hose - Lower - Pipe To Rad.		24240
Tensioner Assy. - Fan To A.C.	3543883C1	38511	8100		
Tensioner Pulley - Fan & Alt.	1830033C1	36091	Belt - Fan & Alt.	1682697C1	♣K080760HD
Tensioner Pulley - Fan To A.C.	3543883C1	36091	Belt - A.C.	311175C2	♣9447HD
7400; 7500			Hose - Upper - Eng. To Pipe		
Belt - Fan & Alt.	1820547C3	♣K080774HD	Hose - Upper - Pipe To Rad.		21335
Belt - Fan To A.C.	1841563C1	♣K060458HD	Hose - Lower - Eng. To Pipe		24240
Tensioner Assy. - Fan & Alt.	1830033C1	38514	Hose - Lower - Pipe To Rad.		21891
Tensioner Assy. - Fan To A.C.	3543883C1	38511	Hose - Lower - Eng. To Pipe		24240
Tensioner Pulley - Fan & Alt.	1830033C1	36091	9100i; 9200i; 9400i; 9900i; 9900ix		
Tensioner Pulley - Fan To A.C.	3543883C1	36091	Belt - Fan & Alt.	1618533C1	♣K080733HD
Hose - Upper - Eng. To Pipe		24236	Belt - Fan & A.C.; Preferred Belt	149635R2	2/9463PB
Hose - Upper - Pipe To Rad.		24240	Belt - Fan & A.C.; Optional Belt		②9463HD
Hose - Lower - Eng. To Rad.		22762	Hose - Upper - Eng. To Pipe		21135
International/Navistar T444 Diesel			Hose - Upper - Pipe To Rad.		
1652 SC			Hose - Lower - Eng. To Pipe		
Belt - W.P., Fan & Alt.; W/O Air Brake			Hose - Lower - Rad. To Pipe		21135
Compr.; W/O Schwitzer Fan Clutch	1822830C1	♣K080893HD	Caterpillar C12 Diesel		
Idler Pulley; W/Flat Idler Pulley	1822652C91	36287	2574; 2674		
Idler Pulley; W/V-Groove Idler Pulley	1822653C91	36288	Belt - Fan & Alt.	1841558C1	♣K080755HD
4700			Belt - A.C.	L17446	♣9447HD
Belt - W.P., Fan & Alt.; W/O Air Brake			5500i; 5600i; 5900i		
Compr.; W/Schwitzer Fan Clutch	1821840C1	♣K080922HD	Belt - Fan & Alt.	3507969C1	♣K080780HD
Belt - W.P., Fan & Alt.; W/Air Brake			Belt - Fan & A.C.	311175C2	♣9447HD
Compr.; W/Schwitzer Fan Clutch	1821850C1	♣K081102HD	Hose - Upper - Eng. To Pipe		21335
Belt - W.P., Fan, Alt. & A.C.; W/O Air Brake			Hose - Upper - Pipe To Rad.		24240
Compr.; W/Schwitzer Fan Clutch	1821839C1	♣K081035HD	Hose - Lower - Eng. To Pipe		24240
Belt - W.P., Fan, Alt. & A.C.; W/Air Brake			Hose - Lower - Pipe To Rad.		24240
Compr.; W/Schwitzer Fan Clutch	1821843C1	♣K081223HD	9100i; 9200i; 9400i; 9900i; 9900ix		
Belt - W.P., Fan & Alt.; W/O Air Brake			Belt - Fan & Alt.	1618533C1	♣K080733HD
Compr.; W/O Schwitzer Fan Clutch	1822830C1	♣K080893HD	Belt - Fan & A.C.; Preferred Belt	149635R2	2/9463PB
Belt - W.P., Fan & Alt.; W/Air Brake			Belt - Fan & A.C.; Optional Belt		②9463HD
Compr.; W/O Schwitzer Fan Clutch	1822832C1	♣K081124HD	Hose - Upper - Eng. To Pipe		21135
Belt - W.P., Fan, Alt. & A.C.; W/O Air Brake			Hose - Upper - Pipe To Rad.		24240
Compr.; W/O Schwitzer Fan Clutch	1822831C2	♣K081000HD	Hose - Lower - Eng. To Pipe		21891
Belt - W.P., Fan, Alt. & A.C.; W/Air Brake			Hose - Lower - Rad. To Pipe		21135
Compr.; W/O Schwitzer Fan Clutch	1822833C1	♣K081265HD	Caterpillar C15 Diesel		
Tensioner Assy.	1822679C3	38510	9400i; 9900i; 9900ix		
Idler Pulley; W/Flat Idler Pulley	1822652C91	36287	Belt - Fan & Alt.	2018284C1	♣K100771HD
Idler Pulley; W/V-Groove Idler Pulley	1822653C91	36288	Belt - Fan & A.C.	2005148C1	♣K060500HD
Hose - Upper - Eng. To Rad.		22159	Hose - Upper - Eng. To Pipe		21135
Hose - Lower - Eng. To Rad.		22671	Hose - Upper - Pipe To Rad.		24240
International/Navistar VT365 Diesel			Hose - Lower - Eng. To Pipe		21135
4200			Hose - Lower - Pipe To Rad.		24240
Belt - Fan, Alt. & A.C.	1839963C1	♣K080830HD	Caterpillar C16 Diesel		
Belt - Fan & Air Compr.	1833620C1	♣K060525HD	9400i; 9900i; 9900ix		
Tensioner Assy. - Fan, Alt. & A.C.	1833688C1	38556	Belt - Fan & Alt.	2018284C1	♣K100771HD
Tensioner Assy. - Fan & Air Compr.	1832711C2	38629	Belt - Fan & A.C.	2005148C1	♣K060500HD
Hose - Upper - Eng. To Rad.		22774	Hose - Upper - Eng. To Pipe		21135
Hose - Lower - Eng. To Rad.		22775	Hose - Upper - Pipe To Rad.		24240

♣Standard Belt Available.

②Two Required.

Belts and Coolant Hose for Medium/Heavy-Duty Trucks (2001 & Newer)

Application	Mfr. Part No.	Our No.	Application	Mfr. Part No.	Our No.
International/Navistar - Continued			International/Navistar - Continued		
2001 - Continued			2001 - Continued		
Caterpillar C16 Diesel - Continued			Cummins N14 Diesel		
9400i; 9900i; 9900ix - Continued			5500i; 5600i; 5900i		
Hose - Upper - Pipe To Rad.		24240	Belt - Hub & W.P.	3865157	♣K060408HD
Hose - Lower - Eng. To Pipe		21135	Belt - Hub & Fan	479577C1	②TR28522
Hose - Lower - Pipe To Rad.		24240	Belt - Alt.	598183C1	②♣9447HD
Cummins ISM Diesel			Belt - Hub & A.C.	196666R1	♣9405HD
5500i			9100i; 9200i; 9400i; 9900i; 9900ix		
Belt - Alt.	L4050335	♣K050336HD	Belt - W.P.	3095880	♣K060415HD
Belt - Fan	1675429C1	K080655	Belt - Fan	3501266C1	♣K100465HD
Belt - A.C.	2016339C1	TR22525	Belt - Alt.; Preferred Belt	598183C1	2/9447PB
5900i			Belt - Alt.; Optional Belt		②♣9447HD
Belt - Fan & Alt.	3579000C1	♣K080806HD	Belt - Hub & A.C.	196666R1	♣9405HD
Belt - Hub & A.C.	3579001C1	♣K060516HD	Hose - Upper - Eng. To Pipe		24240
Tensioner Assy. - Fan & Alt.	3400885	38521	Hose - Upper - Pipe To Rad.		21135
Tensioner Assy. - Hub & A.C.	3102888	38505	Hose - Lower - Eng. To Pipe		24240
Idler Pulley - A.C.	3104139	36225	Hose - Lower - Pipe To Rad.		21135
Idler Pulley - Fan & Alt.	3400884	36308	Cummins Signature 600 Diesel		
Tensioner Pulley - A.C.	3102888	36091	9200i		
Hose - Upper - Eng. To Pipe		24240	Belt - Fan	3529218C1	♣K100719HD
Hose - Upper - Rad. To Pipe		21135	Belt - Hub, Alt. & A.C.	3527406C2	♣K060680HD
Hose - Lower - Eng. To Pipe		24240	Tensioner Assy. - Fan	3681240	38535
Hose - Lower - Rad. To Pipe		24240	Tensioner Assy. - Hub, Alt. & A.C.	3680194	38532
8100			Idler Pulley - Alt. & A.C.	4026886	36226
Belt - Fan	1648750C1	♣K080605HD	Tensioner Pulley - Fan	3681240	36092
Belt - Hub & Alt.	586452C1	♣K050336HD	Tensioner Pulley - Hub, Alt. & A.C.	3680194	36095
Belt - Hub & A.C.	2016338C1	TR22485	Detroit Diesel 6-Cyl. 12.7 L Diesel		
Hose - Upper - Eng. To Pipe		24240	9100i; 9200i		
Hose - Upper - Pipe To Rad.		21135	Belt - Fan	3503813C1	♣K100570HD
Hose - Lower - Eng. To Pipe		24240	Belt - Fan To Alt.	3505387C1	♣K060455HD
Hose - Lower - Pipe To Rad.		21135	Belt - Hub & A.C.	3514954C1	♣K060340HD
9100i; 9200i; 9400i; 9900i; 9900ix			Tensioner Assy. - Fan	3508604C91	38529
Belt - Fan	1651399C1	♣K080565HD	Tensioner Pulley - Fan	3508604C91	36092
Belt - Hub & Alt.	586452C1	♣K050336HD	Hose - Upper - Eng. To Pipe		≈21891
Belt - Hub & A.C.	2016338C1	TR22485	Hose - Upper - Pipe To Rad.		≈21135
Hose - Upper - Eng. To Pipe		24240	Hose - Lower - Eng. To Pipe		24240
Hose - Upper - Pipe To Rad.		21135	Hose - Lower - Pipe To Rad.		≈21135
Hose - Lower - Eng. To Pipe		21135	9400i; 9900i; 9900ix		
Hose - Lower - Pipe To Rad.		24240	Belt - Fan	1687800C1	♣K100540HD
Cummins ISX Diesel			Belt - Alt.	3505387C1	♣K060455HD
9100i			Belt - A.C.	3514954C1	♣K060340HD
Belt - Fan	3681819	♣K100719HD	Tensioner Assy. - Fan	1687801C91	38519
Belt - Hub, Alt. & A.C.	3681812	♣K060685HD	Tensioner Pulley - Fan	1687801C91	36092
Tensioner Assy. - Fan	3681240	38535	Hose - Upper - Eng. To Pipe		≈21891
Tensioner Assy. - Hub, Alt. & A.C.	3680194	38532	Hose - Upper - Pipe To Rad.		≈21135
Idler Pulley - Alt. & A.C.	4026886	36226	Hose - Lower - Eng. To Pipe		24240
Tensioner Pulley - Fan	3681240	36092	Hose - Lower - Pipe To Rad.		21135
Tensioner Pulley - Hub, Alt. & A.C.	3680194	36095	International/Navistar 530 Diesel		
Hose - Upper - Eng. To Pipe		24240	2554; 2654		
Hose - Upper - Pipe To Rad.		21135	Belt - Fan, Alt. & Hub	168297C1	♣K080760HD
Hose - Lower - Eng. To Pipe		21891	Belt - Fan & A.C.	3515596C1	♣K060470HD
Hose - Lower - Pipe To Rad.		21135	Tensioner Assy. - Fan, Alt. & Hub	1830033C1	38514
9400i; 9900i; 9900ix			Tensioner Assy. - Fan & A.C.	1687819C92	38512
Belt - Fan	3681819	♣K100719HD	Tensioner Pulley - Fan, Alt. & Hub	1830033C1	36091
Belt - Hub, Alt. & A.C.	3681812	♣K060685HD	Tensioner Pulley - Fan & A.C.	1687819C92	36091
Tensioner Assy. - Fan	3681240	38535	Hose - Upper - Eng. To Rad.		22140
Tensioner Assy. - Hub, Alt. & A.C.	3680194	38532	Hose - Lower - Eng. To Rad.		≈21115
Idler Pulley - Alt. & A.C.	4026886	36226	4900		
Tensioner Pulley - Fan	3681240	36092	Belt - Fan, Alt. & Hub	1819392C1	♣K080716HD
Tensioner Pulley - Hub, Alt. & A.C.	3680194	36095	Belt - Fan & A.C.	3515596C1	♣K060470HD
Hose - Upper - Eng. To Pipe		21135	Tensioner Assy. - Fan, Alt. & Hub	1830033C1	38514
Hose - Upper - Pipe To Rad.		21891	Tensioner Assy. - Fan & A.C.	1687819C92	38512
Hose - Lower - Eng. To Pipe		21891	Tensioner Pulley - Fan, Alt. & Hub	1830033C1	36091
Hose - Lower - Pipe To Rad.		21135	Tensioner Pulley - Fan & A.C.	1687819C92	36091
			Hose - Upper - Eng. To Rad.		22140
			Hose - Lower - Eng. To Rad.		≈21115

♣Standard Belt Available.
≈Cut to Fit.

②Two Required.

Medium & Heavy-Duty Trucks
(2001 & Newer)

Belts and Coolant Hose for Medium/Heavy-Duty Trucks (2001 & Newer)

Medium & Heavy-Duty Trucks
(2001 & Newer)

Application	Mfr. Part No.	Our No.	Application	Mfr. Part No.	Our No.
International/Navistar - Continued			International/Navistar - Continued		
2001 - Continued			2001 - Continued		
International/Navistar 530 Diesel - Continued			International/Navistar DT466 Diesel - Continued		
8100			4800 - Continued		
Belt - Fan, Alt. & Hub	168297C1	♣K080760HD	Belt - Fan & Alt.; W/P.T.O.; W/Electronic Eng.; W/1.08 To 1 Fan Ratio	1820547C2	♣K080774HD
Belt - Fan & A.C.	3517822C1	♣K060478HD	Belt - Fan & Alt.; W/O P.T.O.	1822503C1	♣K080726HD
Tensioner Assy. - Fan, Alt. & Hub	1830033C1	38514	Belt - Fan To A.C.	1687797C1	♣K060470HD
Tensioner Assy. - Fan & A.C.	1687819C92	38512	Tensioner Assy. - Fan & Alt.	1814719C1	38514
Tensioner Pulley - Fan, Alt. & Hub	1830033C1	36091	Tensioner Assy. - Fan To A.C.	1687819C91	38511
Tensioner Pulley - Fan & A.C.	1687819C92	36091	Tensioner Pulley - Fan & Alt.	1814719C1	36091
Hose - Upper - Eng. To Pipe	24240	24240	Tensioner Pulley - Fan To A.C.	1687819C91	36091
Hose - Upper - Pipe To Rad.	21135	21135	Hose - Upper - Eng. To Rad.	21765	21842
Hose - Lower - Eng. To Pipe	♣21891	♣21891	Hose - Lower - Eng. To Pipe	21842	21115
Hose - Lower - Pipe To Rad.	♣21891	♣21891	Hose - Lower - Pipe To Rad.	21115	21842
International/Navistar DT466 Diesel			4900		
2554			Belt - Fan & Alt.; W/P.T.O.; W/1.2 To 1 Fan Ratio		
Belt - Fan, Alt. & Hub; W/Delco Alt.	1682697C1	♣K080760HD	Ratio	1819391C1	♣K080730HD
Belt - Fan & A.C.	3517822C1	♣K060478HD	Belt - Fan & Alt.; W/P.T.O.; W/Mechanical Eng.; W/1.08 To 1 Fan Ratio	1682696C1	♣K080738HD
Tensioner Assy. - Fan, Alt. & Hub	1830033C1	38514	Belt - Fan & Alt.; W/P.T.O.; W/Electronic Eng.; W/1.08 To 1 Fan Ratio	1820547C2	♣K080774HD
Tensioner Assy. - Fan & A.C.	1687819C92	38512	Belt - Fan & Alt.; W/O P.T.O.	1822503C1	♣K080726HD
Tensioner Pulley - Fan, Alt. & Hub	1830033C1	36091	Belt - Fan & A.C.	3516596C1	♣K060470HD
Tensioner Pulley - Fan & A.C.	1687819C92	36091	Tensioner Assy. - Fan & Alt.	1830033C1	38514
Hose - Upper - Eng. To Pipe	24240	24240	Tensioner Assy. - Fan & A.C.	1687819C92	38512
Hose - Upper - Pipe To Rad.	24240	24240	Tensioner Pulley - Fan & Alt.	1830033C1	36091
Hose - Lower - Eng. To Pipe	24240	24240	Tensioner Pulley - Fan & A.C.	1687819C92	36091
Hose - Lower - Pipe To Rad.	24240	24240	Hose - Upper - Eng. To Rad.	22140	22140
Hose - Lower - Cooler To Rad.	21571	21571	Hose - Lower - Eng. To Rad.	♣21115	♣21115
2574			5500i; 5600i		
Belt - Fan, Alt. & Hub	1820547C2	♣K080774HD	Belt - Fan & Alt.	1841558C1	♣K080755HD
Tensioner Assy. - Fan, Alt. & Hub	1830033C1	38514	Belt - A.C.	3515596C1	♣K060470HD
Tensioner Pulley - Fan, Alt. & Hub	1830033C1	36091	Tensioner Assy. - Fan & Alt.	1830033C1	38514
Hose - Upper - Eng. To Pipe	24240	24240	Tensioner Assy. - Fan & A.C.	1687819C92	38512
Hose - Upper - Pipe To Rad.	24240	24240	Tensioner Pulley - Fan & Alt.	1830033C1	36091
Hose - Lower - Eng. To Pipe	24240	24240	Tensioner Pulley - Fan & A.C.	1687819C92	36091
Hose - Lower - Pipe To Rad.	24240	24240	International/Navistar T444 Diesel		
2654			1652 SC		
Belt - Fan, Alt. & Hub; W/O Delco Alt.	1820547C2	♣K080774HD	Belt - W.P., Fan & Alt.; W/O Air Brake Compr.; W/O Schwitzer Fan Clutch	1822830C1	♣K080893HD
Belt - Fan, Alt. & Hub; W/Delco Alt.	1682697C1	♣K080760HD	Idler Pulley; W/Flat Idler Pulley	1822652C91	36287
Belt - Fan & A.C.	3517822C1	♣K060478HD	Idler Pulley; W/V-Groove Idler Pulley	1822653C91	36288
Tensioner Assy. - Fan, Alt. & Hub	1830033C1	38514	4700		
Tensioner Assy. - Fan & A.C.	1687819C92	38512	Belt - W.P., Fan & Alt.; W/O Air Brake Compr.; W/Schwitzer Fan Clutch	1821840C1	♣K080922HD
Tensioner Pulley - Fan, Alt. & Hub	1830033C1	36091	Belt - W.P., Fan & Alt.; W/Air Brake Compr.; W/Schwitzer Fan Clutch	1821850C1	♣K081102HD
Tensioner Pulley - Fan & A.C.	1687819C92	36091	Belt - W.P., Fan, Alt. & A.C.; W/O Air Brake Compr.; W/Schwitzer Fan Clutch	1821839C1	♣K081035HD
Hose - Upper - Eng. To Pipe	24240	24240	Belt - W.P., Fan, Alt. & A.C.; W/Air Brake Compr.; W/Schwitzer Fan Clutch	1821843C1	♣K081223HD
Hose - Upper - Pipe To Rad.	24240	24240	Belt - W.P., Fan & Alt.; W/O Air Brake Compr.; W/O Schwitzer Fan Clutch	1822830C1	♣K080893HD
Hose - Lower - Eng. To Pipe	24240	24240	Belt - W.P., Fan & Alt.; W/Air Brake Compr.; W/O Schwitzer Fan Clutch	1822832C1	♣K081124HD
Hose - Lower - Pipe To Rad.	24240	24240	Belt - W.P., Fan, Alt. & A.C.; W/O Air Brake Compr.; W/O Schwitzer Fan Clutch	1822831C2	♣K081000HD
Hose - Lower - Cooler To Rad.	21571	21571	Belt - W.P., Fan, Alt. & A.C.; W/Air Brake Compr.; W/O Schwitzer Fan Clutch	1822833C1	♣K081265HD
4700			Tensioner Assy.	1822679C3	38510
Belt - Fan & Alt.; W/P.T.O.; W/1.2 To 1 Fan Ratio	1819391C1	♣K080730HD	Idler Pulley; W/Flat Idler Pulley	1822652C91	36287
Belt - Fan & Alt.; W/P.T.O.; W/Mechanical Eng.; W/1.08 To 1 Fan Ratio	1682696C1	♣K080738HD	Idler Pulley; W/V-Groove Idler Pulley	1822653C91	36288
Belt - Fan & Alt.; W/P.T.O.; W/Electronic Eng.; W/1.08 To 1 Fan Ratio	1820547C2	♣K080774HD	Hose - Upper - Eng. To Rad.	22159	22159
Belt - Fan & Alt.; W/O P.T.O.	1822503C1	♣K080726HD	Hose - Lower - Eng. To Rad.; W/14" Hose	22671	22671
Belt - Fan & A.C.	3516596C1	♣K060470HD	Hose - Lower - Eng. To Rad.; W/27" Hose	22782	22782
Tensioner Assy. - Fan & Alt.	1830033C1	38514			
Tensioner Assy. - Fan & A.C.	1687819C92	38512			
Tensioner Pulley - Fan & Alt.	1830033C1	36091			
Tensioner Pulley - Fan & A.C.	1687819C92	36091			
Hose - Upper - Eng. To Rad.	22140	22140			
Hose - Lower - Eng. To Rad.	♣21115	♣21115			
4800					
Belt - Fan & Alt.; W/P.T.O.; W/1.2 To 1 Fan Ratio	1819391C1	♣K080730HD			
Belt - Fan & Alt.; W/P.T.O.; W/Mechanical Eng.; W/1.08 To 1 Fan Ratio	1682696C1	♣K080738HD			

♣Standard Belt Available.

♣Cut to Fit.

Belts and Coolant Hose for Medium/Heavy-Duty Trucks (2001 & Newer)

Medium & Heavy-Duty Trucks
(2001 & Newer)

Application	Mfr. Part No.	Our No.	Application	Mfr. Part No.	Our No.
Isuzu			Isuzu - Continued		
2011			2007 - Continued		
Isuzu 4HK1-TC Diesel			Isuzu 4HK1-TC Diesel		
NRR			NPR		
Belt - Fan & Alt.	8973629260	K070390	Belt - Fan & Alt.	8980031870	K070404HD
Belt - A.C.	8980883850	♣9530HD	Belt - A.C.	8980108410	♣9650HD
2010			NQR		
Isuzu 4HK1-TC Diesel			Belt - Fan & Alt.		
NPR				8971801811	②♣9420HD
Belt - Fan & Alt.	8980031870	K070404HD	Belt - A.C.	8971801832	♣9620HD
Belt - A.C.	8980108410	♣9650HD	Isuzu 6HK1-TC Diesel		
NQR			FTR; FVR; FXR		
Belt - Fan & Alt.	8980031870	K070404HD	Belt - Fan, Alt. & A.C.	15065874	♣K080726HD
Belt - A.C.	8980108410	②♣9650HD	Tensioner Assy. - Fan, Alt. & A.C.	15098394	38579
NRR			Hose - Upper - Eng. To Rad.		22855
Belt - Fan & Alt.	8980031870	K070404HD	Hose - Lower - Eng. To Rad.		22856
Belt - A.C.	8980108410	♣9650HD	HTR; HVR; HXR		
2009			Belt - Fan, Alt. & A.C.		
GM V-8 6.0 L				15020893	♣K070786HD
NPR			Belt - P.S. & W.P.	97730199	TR22461
Belt - A.C.: Installation Tool Required	12603509	K040355SF	Hose - Upper - Eng. To Rad.		22767
Belt - Fan, Alt. & P.S.	8980361660	♣K061010HD	Hose - Lower - Eng. To Rad.		22768
Belt - Stretch Fit Belt Installation Tool		91030	2006		
Tensioner Assy. - Fan, Alt. & P.S.	12609719	39083	GM V-8 6.0 L		
Isuzu 4HK1-TC Diesel			NPR		
NPR			Belt - Fan, Alt. & P.S.	12576754	♣K060994HD
Belt - Fan & Alt.	8980031870	K070404HD	Belt - A.C.	12576447	♣K040378HD
Belt - A.C.	8980108410	♣9650HD	Tensioner Assy. - Alt. & P.S.	12580162	38158
NQR			Tensioner Assy. - A.C.	12580196	38159
Belt - Fan & Alt.	98003187	K070404HD	Tensioner Pulley - Alt. & P.S.	12580162	38009
Belt - A.C.	8980108410	②♣9650HD	Hose - Upper - Eng. To Rad.		23098
NRR			Hose - Lower - Eng. To Rad.		23097
Belt - Fan & Alt.	8980031870	K070404HD	Isuzu 4HK1-TC Diesel		
Belt - A.C.	8980108410	♣9650HD	NPR; NQR; NRR		
2008			Belt - Fan & Alt.		
Isuzu 4HK1-TC Diesel				8971801811	②♣9420HD
NPR			Belt - Alt. & A.C.	8971801832	♣9620HD
Belt - Fan & Alt.	8980031870	K070404HD	Hose - Upper - Eng. To Rad.		23096
Belt - A.C.	8980108410	♣9650HD	Hose - Lower - Eng. To Rad.		23095
NQR			Isuzu 6HK1-TC Diesel		
Belt - Fan & Alt.	98003187	K070404HD	FTR; FVR; FXR		
Belt - A.C.	8980108410	②♣9650HD	Belt - Fan, Alt. & A.C.	15065874	♣K080726HD
NRR			Tensioner Assy. - Fan, Alt. & A.C.	15098394	38579
Belt - Fan & Alt.	8980031870	K070404HD	Hose - Upper - Eng. To Rad.		22855
Belt - A.C.	8980108410	♣9650HD	Hose - Lower - Eng. To Rad.		22856
Isuzu 6HK1-TC Diesel			HTR; HVR; HXR		
FTR; FVR			Belt - Fan, Alt. & A.C.	15020893	♣K070786HD
Belt - Fan, Alt. & A.C.	15065874	♣K080726HD	Belt - P.S. & W.P.	97730199	TR22461
Tensioner Assy. - Fan, Alt. & A.C.	15098394	38579	Hose - Upper - Eng. To Rad.		22767
Hose - Upper - Eng. To Rad.		22855	Hose - Lower - Eng. To Rad.		22768
2007			2005		
GM V-8 6.0 L			GM V-8 6.0 L		
NPR			NPR		
Belt - Fan, Alt. & P.S.	12576754	♣K060994HD	Belt - Fan, Alt. & P.S.		♣K060994HD
Belt - A.C.	12576447	♣K040378HD	Belt - A.C.	12576447	♣K040378HD
Tensioner Assy. - Alt. & P.S.	12580162	38158	Tensioner Assy. - Alt. & P.S.	12580162	38158
Tensioner Assy. - A.C.	12580196	38159	Tensioner Assy. - A.C.	12580196	38159
Tensioner Pulley - Alt. & P.S.	12580162	38009	Idle Pulley	12580771	36299
Hose - Upper - Eng. To Rad.		23098	Tensioner Pulley - Alt. & P.S.	12580162	38009
Hose - Lower - Eng. To Rad.		23097	Tensioner Pulley - A.C.	12580196	36169
Isuzu 4HK1-TC Diesel			Isuzu 4HK1-TC Diesel		
NPR; NQR; NRR			NPR; NQR; NRR		
Belt - Fan & Alt.	8971801811	②♣9420HD	Belt - Fan & Alt.	8971801811	②♣9420HD
Belt - Alt. & A.C.	8971801832	♣9620HD	Belt - Alt. & A.C.	8971801832	♣9620HD

♣Standard Belt Available.

②Two Required.

Belts and Coolant Hose for Medium/Heavy-Duty Trucks (2001 & Newer)

Medium & Heavy-Duty Trucks
(2001 & Newer)

Application	Mfr. Part No.	Our No.	Application	Mfr. Part No.	Our No.
Isuzu - Continued			Isuzu - Continued		
2005 - Continued			2003 - Continued		
Isuzu 4HK1-TC Diesel - Continued			GM V-8 5.7 L - Continued		
NPR; NQR; NRR - Continued			NPR - Continued		
Hose - Upper - Eng. To Rad.		23096	Tensioner Assy.	8971619590	38528
Hose - Lower - Eng. To Rad.		23095	Hose - Upper - Eng. To Rad.		22731
Isuzu 6HK1-TC Diesel			Hose - Lower - Eng. To Rad.		
FTR; FVR; FXR			22732		
Belt - Fan, Alt. & A.C.	15065874	♣K080726HD	GM V-8 6.0 L		
Tensioner Assy. - Fan, Alt. & A.C.	15098394	38579	NPR		
Hose - Upper - Eng. To Rad.		22855	Belt - Fan, Alt. & P.S.		
Hose - Lower - Eng. To Rad.		22856	Tensioner Assy. - Alt. & P.S.		
HTR; HVR; HXR			Tensioner Assy. - A.C.		
Belt - Fan, Alt. & A.C.	15020893	♣K070786HD	Idler Pulley		
Belt - P.S. & W.P.	97730199	TR22461	Tensioner Pulley - Alt. & P.S.		
Hose - Upper - Eng. To Rad.		22767	Tensioner Pulley - A.C.		
Hose - Lower - Eng. To Rad.		22768	Hose - Upper - Eng. To Rad.		
2004			Hose - Lower - Eng. To Rad.		
GM V-8 5.7 L			23097		
NPR			Isuzu 4HE1-TC Diesel		
Belt - Fan, Alt., P.S. & A.C.	8971106400	♣K061010HD	NPR		
Belt - Fan, Alt. & P.S.	8970427480	♣K061000HD	Belt - Fan & Alt.		
Tensioner Assy.	8971619590	38528	Belt - Alt. & A.C.		
Hose - Upper - Eng. To Rad.		22731	Hose - Upper - Eng. To Rad.		
Hose - Lower - Eng. To Rad.		22732	Hose - Lower - Eng. To Rad.		
GM V-8 6.0 L			23095		
NPR			NQR		
Belt - Fan, Alt. & P.S.		♣K060994HD	Belt - Fan & Alt.		
Belt - A.C.	12576447	♣K040378HD	Belt - Alt. & A.C.		
Tensioner Assy. - Alt. & P.S.	12580162	38158	Hose - Upper - Eng. To Rad.		
Tensioner Assy. - A.C.	12580196	38159	Hose - Lower - Eng. To Rad.		
Idler Pulley	12580771	36299	23095		
Tensioner Pulley - Alt. & P.S.	12580162	38009	Isuzu 6HK1-TC Diesel		
Tensioner Pulley - A.C.	12580196	36169	FRR		
Hose - Upper - Eng. To Rad.		23098	Belt - Fan & Alt.		
Hose - Lower - Eng. To Rad.		23097	Belt - A.C.		
Isuzu 4HE1-TC Diesel			Hose - Upper - Eng. To Rad.		
NPR			Hose - Lower - Eng. To Rad.		
Belt - Fan & Alt.	8971801811	②♣9420HD	22734		
Belt - Alt. & A.C.	8971801832	♣9620HD	FTR; FVR		
Hose - Upper - Eng. To Rad.		23096	Belt - Fan & Alt.		
Hose - Lower - Eng. To Rad.		23095	Belt - A.C.		
NQR			Hose - Upper - Eng. To Rad.		
Belt - Fan & Alt.	8971801810	②♣9415HD	Hose - Lower - Eng. To Rad.		
Belt - Alt. & A.C.	8971801830	♣9610HD	22733		
Hose - Upper - Eng. To Rad.		23096	22734		
Hose - Lower - Eng. To Rad.		23095	2002		
Isuzu 6HK1-TC Diesel			GM V-8 5.7 L		
FRR			NPR		
Belt - Fan & Alt.	1136714641	TR22461	Belt - Fan, Alt., P.S. & A.C.		
Belt - A.C.	8943951720	TR22434	Belt - Fan, Alt. & P.S.		
Hose - Upper - Eng. To Rad.		22733	Tensioner Assy.		
Hose - Lower - Eng. To Rad.		22734	Hose - Upper - Eng. To Rad.		
FTR; FVR			Hose - Lower - Eng. To Rad.		
Belt - Fan, Alt. & A.C.	15065874	♣K080726HD	22732		
Tensioner Assy. - Fan, Alt. & A.C.	15098394	38579	Isuzu 4HE1-TC Diesel		
Hose - Upper - Eng. To Rad.		22855	NPR; NQR		
Hose - Lower - Eng. To Rad.		22856	Belt - Fan & Alt.		
2003			Belt - Alt. & A.C.		
GM V-8 5.7 L			Hose - Upper - Eng. To Rad.		
NPR			Hose - Lower - Eng. To Rad.		
Belt - Fan, Alt., P.S. & A.C.	8971106400	♣K061010HD	23096		
Belt - Fan, Alt. & P.S.	8970427480	♣K061000HD	23095		
Isuzu 6HK1-TC Diesel			Isuzu 6HK1-TC Diesel		
FRR; FSR			FRR; FSR		
Belt - Fan & Alt.	1136714050	②TR22474	Belt - Fan & Alt.		
Belt - A.C.	8943951720	TR22434	Belt - A.C.		
Hose - Upper - Eng. To Rad.		22733	Hose - Upper - Eng. To Rad.		
Hose - Lower - Eng. To Rad.		22734	Hose - Lower - Eng. To Rad.		
FTR			FTR		
Belt - Fan & Alt.	8943951710	TR22461	Belt - Fan & Alt.		
Belt - A.C.	8943951720	TR22434	Belt - A.C.		
Hose - Upper - Eng. To Rad.		22733	Hose - Upper - Eng. To Rad.		
Hose - Lower - Eng. To Rad.		22734	Hose - Lower - Eng. To Rad.		

♣Standard Belt Available.

②Two Required.

Belts and Coolant Hose for Medium/Heavy-Duty Trucks (2001 & Newer)

Application	Mfr. Part No.	Our No.	Application	Mfr. Part No.	Our No.
Isuzu - Continued			Kenworth - Continued		
2002 - Continued			2015 - Continued		
Isuzu 6HK1-TC Diesel - Continued			Paccar PX-9 Diesel		
FVR			T370		
Belt - Fan & Alt.	1136714050	②TR22474	Belt - Serpentine	3974249	▲K080842HD
Belt - A.C.	8943951720	TR22434	Tensioner Assy.	3973819	38627
Hose - Upper - Eng. To Rad.		22733	2014		
Hose - Lower - Eng. To Rad.		22734	Cummins ISX12 Diesel		
2001			T660; T680; T800; W900		
GM V-8 5.7 L			Tensioner Assy. - Fan		
NPR			4299053		
Belt - Fan, Alt., P.S. & A.C.	8971106400	▲K061010HD	Cummins ISX12-G		
Belt - Fan, Alt. & P.S.	8970427480	▲K061000HD	T660; T800		
Tensioner Assy.	8971619590	38528	Tensioner Assy. - Fan		
Hose - Upper - Eng. To Rad.		22731	4299053		
Hose - Lower - Eng. To Rad.		22732	Cummins ISX15 Diesel		
Isuzu 4HE1-TC Diesel			C500; C550; T660		
NPR; NQR			Tensioner Assy. - Fan		
Belt - Fan & Alt.	8971801810	②▲9415HD	4299051		
Belt - Alt. & A.C.	8971801830	▲9610HD	T680		
Hose - Upper - Eng. To Rad.		23096	Belt - Serpentine - Fan, W.P. & Alt.		
Hose - Lower - Eng. To Rad.		23095	D8410006122180		
Isuzu 6HK1-TC Diesel			▲K120858HD		
FRR			Belt - Serpentine - A.C.		
Belt - Fan & Alt.	1136714050	②TR22474	D8410006061620		
Belt - A.C.	8943951720	TR22434	Tensioner Assy. - Fan		
Hose - Upper - Eng. To Rad.		22733	4299051		
Hose - Lower - Eng. To Rad.		22734	Tensioner Assy. - A.C.		
FSR; FTR; FVR			2891940		
Belt - Fan	8943951710	TR22461	38610		
Belt - A.C.	8943951720	TR22434	Idler Pulley - A.C.		
Hose - Upper - Eng. To Rad.		22733	3689465		
Hose - Lower - Eng. To Rad.		22734	Hose - Upper - Eng. To Pipe		
Kenworth			28212		
2015			Hose - Upper - Pipe To Rad.		
Cummins ISX15 Diesel			28359		
T880			Hose - Lower - Eng. To Pipe		
Belt - Serpentine - Fan, W.P. & Alt.	D8410006122180	▲K120858HD	≈<24840		
Belt - Serpentine - A.C.	D8410006061620	▲K060637HD	Hose - Lower - Pipe To Rad.		
Tensioner Assy. - Fan, W.P. & Alt.	4299051	38587	≈<24840		
Tensioner Assy. - A.C.	2891940	38610	Hose - Suction - Tank To Pump		
Idler Pulley - A.C.	3689465	36223	M50603274320450		
Hose - Upper - Eng. To Pipe		28212	DEF7056		
Hose - Upper - Pipe To Rad.		28359	Hose - Return - Pump To Tank		
Hose - Lower - Eng. To Pipe		≈<24840	M50603274110450		
Hose - Lower - Pipe To Rad.		≈<24840	DEF7057		
Hose - Suction - Tank To Pump	M50603274320450	DEF7056	Hose - Turbo To Pipe (Hot Side)		
Hose - Return - Pump To Tank	M50603274110450	DEF7057	26203		
Hose - Turbo To Pipe (Hot Side)		26203	Hose - Pipe To Intercooler (Hot Side)		
Hose - Pipe To Intercooler (Hot Side)		26203	26203		
Hose - Intercooler To Pipe (Cold Side)		26203	Hose - Intercooler To Pipe (Cold Side)		
Hose - Pipe To Engine (Cold Side)		26203	26203		
Paccar MX-13 Diesel			T880; W900		
T660; T680; T800; T880			Tensioner Assy. - Fan		
Belt - Serpentine - Fan	D841003121161	▲K120457HD	4299051		
Belt - Serpentine - Alt., W.P. & A.C.	1898312	▲K080913HD	38587		
Hose - Upper - Pipe To Rad.		28359	Paccar MX-13 Diesel		
Hose - Upper - Eng. To Pipe		≈<24840	T680		
Hose - Lower		≈<24840	Belt - Serpentine - Alt., W.P. & A.C.		
Hose - Lower		≈<24840	D841003121212		
Hose - Turbo To Pipe (Hot Side)		26203	Belt - Serpentine - Fan		
Hose - Pipe To Intercooler (Hot Side)		26203	D841003121212		
Hose - Intercooler To Manifold (Cold Side)		26203	Hose - Upper - Eng. To Pipe		
Hose - Pipe To Engine (Cold Side)		26203	≈<24840		
			Hose - Upper - Pipe To Rad.		
			28359		
			Hose - Lower - Eng. To Pipe		
			≈<24840		
			Hose - Lower - Pipe To Rad.		
			≈<24840		
			Hose - Suction - Tank To Pump; W/450mm		
			Line		
			M50603274320450		
			DEF7056		
			Hose - Return - Pump To Tank; W/450mm		
			Line		
			M50603274110450		
			DEF7057		
			Hose - Pressure - Pump To Injector;		
			W/2400mm Line		
			M50603172132400		
			DEF7042		

▲Standard Belt Available.
≈<Cut to Fit.

②Two Required.

Medium & Heavy-Duty Trucks
(2001 & Newer)

Belts and Coolant Hose for Medium/Heavy-Duty Trucks (2001 & Newer)

Medium & Heavy-Duty Trucks
(2001 & Newer)

Application	Mfr. Part No.	Our No.	Application	Mfr. Part No.	Our No.
Kenworth - Continued			Kenworth - Continued		
2014 - Continued			2013 - Continued		
Paccar MX-13 Diesel - Continued			Cummins ISX15 Diesel - Continued		
T680 - Continued			T680 - Continued		
Hose - Intercooler To Pipe (Cold Side)		26203	Tensioner Assy. - Fan	3682946	38587
Hose - Pipe To Engine (Cold Side)		26203	Tensioner Assy. - A.C.	2891940	38610
Hose - Turbo To Pipe (Hot Side)		26203	Idler Pulley	3682229	36223
Hose - Pipe To Intercooler (Hot Side)		26203	Hose - Upper - Rad. To Pipe		28359
T800			Hose - Upper - Pipe To Eng.		28212
Belt - Serpentine - Alt., W.P. & A.C.	D841003082322	♣K080915HD	Hose - Suction - Tank To Pump	M50603474320500	DEF7002
Belt - Serpentine - Fan	D841003121212	♣K120477HD	Hose - Return - Pump To Tank	M50603474110500	DEF7001
Hose - Upper - Eng. To Pipe		≈24840	Hose - Pressure - Pump To Injector; W/2400mm Line	M50603372132400	DEF7042
Hose - Upper - Pipe To Rad.		28359	Hose - Turbo To Pipe (Hot Side)	D506039	26203
Hose - Lower - Eng. To Pipe		≈24840	Hose - Pipe To Intercooler (Hot Side)	D506039	26203
Hose - Lower - Pipe To Rad.		≈24840	Hose - Intercooler To Pipe (Cold Side)	D506039	26203
Hose - Intercooler To Pipe (Cold Side)		26203	Hose - Pipe To Engine (Cold Side)	D506039	26203
Hose - Pipe To Engine (Cold Side)		26203	T800		
Hose - Turbo To Pipe (Hot Side)		26203	Belt - Serpentine - Fan	D8410006122180	♣K120858HD
Hose - Pipe To Intercooler (Hot Side)		26203	Belt - Serpentine - A.C.	D8410006061620	♣K060637HD
T880			Tensioner Assy. - Fan	3682946	38587
Belt - Serpentine - Alt., W.P. & A.C.	D841003082322	♣K080915HD	Tensioner Assy. - A.C.	2891940	38610
Belt - Serpentine - Fan	D841003121212	♣K120477HD	Idler Pulley - A.C.	3682229	36223
Hose - Upper - Eng. To Pipe		≈24840	W900		
Hose - Upper - Pipe To Rad.		28359	Belt - Fan & W.P.		K120910HD
Hose - Lower - Eng. To Pipe		≈24840	Belt - A.C. & Alt.		♣K060716HD
Hose - Lower - Pipe To Rad.		≈24840	Tensioner Assy. - Fan	3682946	38587
Hose - Suction - Tank To Pump; W/450mm Line	M50603274320450	DEF7056	Tensioner Assy. - A.C.	2891940	38610
Hose - Return - Pump To Tank; W/450mm Line	M50603274110450	DEF7057	Hose - Upper - Pipe To Eng.		28212
Hose - Intercooler To Pipe (Cold Side)		26203	Hose - Upper - Rad. To Pipe		28359
Hose - Pipe To Engine (Cold Side)		26203	Hose - Lower		≈24840
Hose - Turbo To Pipe (Hot Side)		26203	Paccar MX Diesel		
Hose - Pipe To Intercooler (Hot Side)		26203	T680		
Paccar PX-7 Diesel			Belt - Fan	D841002121640	K120645HD
K270; K370			Belt - A.C.	D841002071939	K070762HD
Belt - Serpentine	3289831	K080806HD	Tensioner Assy. - Fan	1853658	38670
Tensioner Assy.	3976834	38516	Idler Pulley	1855571	36359
Idler Pulley - Grooved	4991240	36093	Hose - Upper - Rad. To Pipe		28359
2013			Hose - Upper - Pipe To Eng.		≈24840
Cummins ISL9 Diesel			Hose - Suction - Tank To Pump; W/450mm Line	M50603274320450	DEF7056
T440			Hose - Return - Pump To Tank; W/450mm Line	M50603274110450	DEF7057
Belt - Fan	3972376	K080852HD	Hose - Pressure - Pump To Injector; W/2400mm Line	M50603172132400	DEF7042
Idler Pulley	3970945	36283	T800		
Cummins ISX12 Diesel			Belt - W.P., Alt. & A.C.	1898312	♣K080913HD
T800			Hose - Upper - Rad. To Pipe		28359
Belt - Fan		♣K080876HD	Hose - Upper - Pipe To Eng.		≈24840
Belt - A.C.		K060604	Hose - Lower - Rad. To Pipe		28212
Tensioner Assy. - Fan	2871294	38622	Hose - Lower - Pipe To Eng.		≈24840
Tensioner Assy. - A.C.	2891940	38610	Hose - Return - Pump To Tank	M50603474110500	DEF7001
Idler Pulley	3682229	36223	Hose - Suction - Tank To Pump	M50603474320500	DEF7002
Cummins ISX15 Diesel			Hose - Pressure - Pump To Injector; W/2700mm Line	M50603372132700	DEF7053
T660			Hose - Turbo To Pipe (Hot Side)		26203
Hose - Return - Pump To Tank	M50602274110500	DEF7001	Hose - Pipe To Intercooler (Hot Side)		26203
Hose - Suction - Tank To Pump	M50602274320500	DEF7002	Hose - Intercooler To Pipe (Cold Side)		26203
Hose - Pressure - Pump To Injector; W/2500mm Line	M50602072232500	DEF7038	Hose - Pipe To Engine (Cold Side)		26203
Hose - Pressure - Pump To Injector; W/2400mm Line	M50603372132400	DEF7042	2012		
Hose - Turbo To Pipe (Hot Side)	D506039	26203	Cummins ISL Diesel		
Hose - Pipe To Intercooler (Hot Side)	D506039	26203	T470		
Hose - Intercooler To Pipe (Cold Side)	D506039	26203	Tensioner Assy.	3973819	38627
Hose - Pipe To Engine (Cold Side)	D506039	26203	Cummins ISL9 Diesel		
T680			T440		
Belt - Fan	D8410006122180	♣K120858HD	Belt - Fan	3972376	K080852HD
Belt - A.C.	D8410006061620	♣K060637HD	Idler Pulley	3970945	36283

♣Standard Belt Available.

≈Cut to Fit.

Belts and Coolant Hose for Medium/Heavy-Duty Trucks (2001 & Newer)

Application	Mfr. Part No.	Our No.	Application	Mfr. Part No.	Our No.
Kenworth - Continued			Kenworth - Continued		
2012 - Continued			2012 - Continued		
Cummins ISX15 Diesel			Paccar PX-6 Diesel - Continued		
T660			T270 - Continued		
Belt - Fan	D8410006122180	♣K120858HD	Hose - Suction - Tank To Pump; W/600mm Line	M50602274320600	DEF7014
Belt - A.C.	D8410006061620	♣K060637HD	Hose - Suction - Tank To Pump; W/650mm Line	M50603474320650	DEF7055
Tensioner Assy. - Fan	3682946	38587	Hose - Pressure - Pump To Injector; W/1300mm Line	M50602072131300	DEF7050
Tensioner Assy. - A.C.	2891940	38610	Hose - Pressure - Pump To Injector; W/2600mm Line	M50603372132600	DEF7054
Idler Pulley	3682229	36223	Hose - Pressure - Pump To Injector; W/800mm Line	M50602072130800	DEF7049
Hose - Return - Pump To Tank	M50602274110500	DEF7001	Hose - Turbo To Pipe (Hot Side)		26203
Hose - Suction - Tank To Pump	M50602274320500	DEF7002	Hose - Pipe To Intercooler (Hot Side)		26203
Hose - Pressure - Pump To Injector; W/2500mm Line	M50602072232500	DEF7038	Hose - Intercooler To Pipe (Cold Side)		26203
Hose - Pressure - Pump To Injector; W/2400mm Line	M50603372132400	DEF7042	Hose - Pipe To Engine (Cold Side)		26203
Hose - Pressure - Pump To Injector; W/1100mm Line	M50602072131100	DEF7051			
Hose - Pressure - Pump To Injector; W/1200mm Line	M50603372131200	DEF7046	Paccar PX-8 Diesel		
Hose - Turbo To Pipe (Hot Side)	D506039	26203	T370		
Hose - Pipe To Intercooler (Hot Side)	D506039	26203	Belt - Serpentine	4933083	♣K080842HD
Hose - Intercooler To Pipe (Cold Side)	D506039	26203	Tensioner Assy.	3973819	38627
Hose - Pipe To Engine (Cold Side)	D506039	26203	Idler Pulley	3970945	36283
			Hose - Suction - Tank To Pump	M50602274320600	DEF7014
T700			2011		
Belt - Fan	D8410006122180	♣K120858HD	Caterpillar C15 Diesel		
Belt - Alt. & A.C.	D8410006061620	♣K060637HD	T660		
Tensioner Assy. - Fan	2871292	38587	Belt - Fan & A.C.	D8410006122490	K120980HD
Tensioner Assy. - Alt. & A.C.	3104149	38610	Belt - Alt.	D8410006061878	♣K060739HD
Tensioner Pulley - Fan	2871292	36165	Tensioner Assy.	2790253	38636
			Idler Pulley	2790252	36230
T800			Cummins ISL Diesel		
Belt - Fan	D8410006122180	♣K120858HD	T470		
Belt - A.C.	D8410006061620	♣K060637HD	Belt - Fan & Alt.	3289930	♣K080690HD
Tensioner Assy. - Fan	3682946	38587	Belt - A.C.	D8410006061290	♣K060509HD
Tensioner Assy. - A.C.	3104149	38610	Tensioner Assy. - Fan & Alt.	3973819	38627
Tensioner Pulley - Fan	3682946	36165	Cummins ISM Diesel		
Idler Pulley - A.C.	3682229	36223	T800		
Hose - Upper - Rad. To Pipe		28359	Belt - Fan & Alt.	D8410006081735	K080683HD
Hose - Upper - Pipe To Eng.		≧28212	Belt - A.C.	4004824	♣K060539HD
Hose - Lower - Pipe To Eng.		≧28212	Tensioner Assy. - Fan & Alt.	4920105	38622
Hose - Lower - Rad. To Pipe		≧28200	Tensioner Assy. - A.C.	3102888	38505
Hose - Return - Pump To Tank	M50602274110500	DEF7001	Cummins ISX15 Diesel		
Hose - Suction - Tank To Pump	M50602274320500	DEF7002	T660		
Hose - Pressure - Pump To Injector; W/1700mm Line	M50603372131700	DEF7044	Belt - Fan & Alt.	D8410006122180	♣K120858HD
Hose - Pressure - Pump To Injector; W/2100mm Line	M50602072132100	DEF7047	Belt - A.C.	D8410006061620	♣K060637HD
Paccar MX Diesel			Tensioner Assy. - Fan & Alt.	2871292	38587
T660			Tensioner Assy. - A.C.	3104149	38610
Belt - Fan	D841002121640	K120645HD	Tensioner Pulley - Fan & Alt.	2871292	36165
Belt - A.C.	D841002071939	K070762HD	Idler Pulley - A.C.	3682229	36223
Tensioner Assy. - Fan	1853658	38670	Hose - Upper - Eng. To Pipe		≧28212
Idler Pulley	1855571	36359	Hose - Upper - Pipe To Rad.		28359
Hose - Upper		28359	Hose - Lower - Eng. To Pipe		≧24440
T800			Hose - Lower - Pipe To Rad.		≧24440
Belt - Alt. & A.C.	D841000071939	K070762HD	Hose - Return - Pump To Tank	M50602274110500	DEF7001
Tensioner Assy. - Alt. & A.C.	1853658PE	38670	Hose - Suction - Tank To Pump	M50602274320500	DEF7002
Idler Pulley	1855571PE	36359	Hose - Pressure - Pump To Injector; W/2500mm Line	M50602072232500	DEF7038
Paccar PX-6 Diesel			Hose - Pressure - Pump To Injector; W/2400mm Line	M50603372132400	DEF7042
T270			Hose - Pressure - Pump To Injector; W/1100mm Line	M50602072131100	DEF7051
Belt - Fan	3289864	♣K080825HD	Hose - Pressure - Pump To Injector; W/1200mm Line	M50603372131200	DEF7046
Hose - Upper - Rad. To Pipe		≧24840	Hose - Turbo To Pipe (Hot Side)	D506039	26203
Hose - Upper - Pipe To Eng.		≧24828	Hose - Pipe To Intercooler (Hot Side)	D506039	26203
Hose - Lower - Rad. To Oil Cooler		≧24840			
Hose - Lower - Oil Cooler To Pipe		≧24836			
Hose - Lower - Pipe To Eng.		≧24832			
Hose - Return - Pump To Tank; W/550mm Line	M50602274110550	DEF7020			
Hose - Return - Pump To Tank; W/500mm Line	M50603474110500	DEF7001			

♣Standard Belt Available.

≧Cut to Fit.

Medium & Heavy-Duty Trucks (2001 & Newer)

Belts and Coolant Hose for Medium/Heavy-Duty Trucks (2001 & Newer)

Medium & Heavy-Duty Trucks
(2001 & Newer)

Application	Mfr. Part No.	Our No.	Application	Mfr. Part No.	Our No.
Kenworth - Continued			Kenworth - Continued		
2011 - Continued			2011 - Continued		
Cummins ISX15 Diesel - Continued			Paccar PX-6 Diesel - Continued		
T660 - Continued			T270 - Continued		
Hose - Intercooler To Pipe (Cold Side)	D506039	26203	Hose - Pressure - Pump To Injector; W/2600mm Line	M50603372132600	DEF7054
Hose - Pipe To Engine (Cold Side)	D506039	26203	Hose - Pressure - Pump To Injector; W/800mm Line	M50602072130800	DEF7049
T700			Hose - Turbo To Pipe (Hot Side)		26203
Belt - Fan	D8410006122180	♣K120858HD	Hose - Pipe To Intercooler (Hot Side)		26203
Belt - Alt. & A.C.	D8410006061620	♣K060637HD	Hose - Intercooler To Pipe (Cold Side)		26203
Tensioner Assy. - Fan	2871292	38587	Hose - Pipe To Engine (Cold Side)		26203
Tensioner Assy. - Alt. & A.C.	3104149	38610	T370		
Tensioner Pulley - Fan	2871292	36165	Belt - Fan	4080825	♣K080825HD
Hose - Suction - Tank To Pump	M50603474320500	DEF7002	Hose - Upper - Rad. To Pipe		≈<24840
Hose - Return - Pump To Tank	M50602274110500	DEF7001	Hose - Upper - Pipe To Eng.		≈<24828
Hose - Pressure - Pump To Injector; W/2500mm Line	M50603372232500	DEF7038	Hose - Lower - Rad. To Pipe		≈<24836
T800			Hose - Lower - Pipe To Eng.		≈<24832
Belt - Fan	D8410006122180	♣K120858HD	Hose - Return - Tank To Pump	M50602274320600	DEF7014
Belt - Alt. & A.C.	D8410006061620	♣K060637HD	Hose - Pressure - Pump To Injector	M50602274110550	DEF7020
Tensioner Assy. - Fan	2871292	38587	Paccar PX-8 Diesel		
Tensioner Assy. - Alt. & A.C.	3104149	38610	T370		
Tensioner Pulley - Fan	2871292	36165	Belt - Serpentine	4933083	♣K080842HD
Hose - Upper - Eng. To Pipe		≈<28212	Tensioner Assy.	3973819	38627
Hose - Upper - Pipe To Rad.		28359	Idler Pulley	3970945	36283
Hose - Lower - Eng. To Pipe		≈<24440	2010		
Hose - Lower - Pipe To Rad.		≈<28212	Caterpillar C15 Diesel		
Hose - Return - Pump To Tank	M50602274110500	DEF7001	W900		
Hose - Suction - Tank To Pump	M50602274320500	DEF7002	Belt - Fan & W.P.		K121049HD
Hose - Pressure - Pump To Injector; W/1700mm Line	M50603372131700	DEF7044	Belt - A.C. & Alt.		♣K060690HD
Hose - Pressure - Pump To Injector; W/2100mm Line	M50602072132100	DEF7047	Tensioner Assy. - A.C.	2790253	38636
W900			Tensioner Assy. - Fan	3368955	38609
Belt - Fan & Alt.	D8410006102220	K100874HD	Hose - Upper - Pipe To Eng.		28359
Belt - A.C.	D8410006061535	♣K060605HD	Cummins ISL9 Diesel		
Tensioner Assy. - Fan & Alt.	2871292	38587	T440; T450; T470H		
Tensioner Assy. - A.C.	3104149	38610	Belt - Fan & Alt.	3974246	K080860HD
Tensioner Pulley - Fan & Alt.	2871292	36165	Belt - A.C.	D8410006060856	K060337HD
Idler Pulley - A.C.	3682229	36223	Tensioner Assy. - Fan, W.P. & Alt.	3973819	38627
Paccar MX Diesel			Cummins ISM Diesel		
T700			T800		
Belt - Fan	D841002121640	K120645HD	Belt - Fan & Alt.	D8410006081735	K080683HD
Belt - Alt. & A.C.	D841002071939	K070762HD	Belt - A.C.	4004824	♣K060539HD
Tensioner Assy. - Alt. & A.C.	1787113PE	38670	Tensioner Assy. - Fan & Alt.	4920105	38622
Idler Pulley - Alt. & A.C.	1787114PE	36359	Tensioner Assy. - A.C.	3102888	38505
T800			Cummins ISX15 Diesel		
Belt - Fan	D841002121640	K120645HD	T660		
Belt - Alt. & A.C.	D841002071939	K070762HD	Belt - A.C. - From W.P.	D8410006061620	♣K060637HD
Tensioner Assy. - Alt. & A.C.	1853658PE	38670	Belt - Fan, W.P. & Alt.	D8410006122215	♣K120872HD
Idler Pulley	1855571PE	36359	Tensioner Assy. - A.C.	3104149	38610
Paccar PX-6 Diesel			Tensioner Assy. - Fan, W.P. & Alt.	3682946	38587
T270			Idler Pulley - A.C.	3682229	36223
Belt - Fan	3289864	♣K080825HD	Tensioner Pulley - Fan, W.P. & Alt.	3682946	36165
Hose - Upper - Rad. To Pipe		≈<24840	Hose - Upper - Eng. To Pipe		≈<28212
Hose - Upper - Pipe To Eng.		≈<24828	Hose - Upper - Pipe To Rad.		28359
Hose - Lower - Rad. To Oil Cooler		≈<24840	Hose - Lower - Eng. To Pipe		≈<24440
Hose - Lower - Oil Cooler To Pipe		≈<24836	Hose - Lower - Pipe To Rad.		≈<24440
Hose - Lower - Pipe To Eng.		≈<24832	Hose - Return - Pump To Tank	M50602274110500	DEF7001
Hose - Return - Pump To Tank; W/550mm Line	M50602274110550	DEF7020	Hose - Suction - Tank To Pump	M50602274320500	DEF7002
Hose - Return - Pump To Tank; W/500mm Line	M50603474110500	DEF7001	Hose - Pressure - Pump To Injector; W/2500mm Line	M50602072232500	DEF7038
Hose - Suction - Tank To Pump; W/600mm Line	M50602274320600	DEF7014	Hose - Pressure - Pump To Injector; W/2400mm Line	M50603372132400	DEF7042
Hose - Suction - Tank To Pump; W/650mm Line	M50603474320650	DEF7055	Hose - Turbo To Pipe (Hot Side)	D506039	26203
Hose - Pressure - Pump To Injector; W/1300mm Line	M50602072131300	DEF7050	Hose - Pipe To Intercooler (Hot Side)	D506039	26203
			Hose - Intercooler To Pipe (Cold Side)	D506039	26203

♣Standard Belt Available.

≈<Cut to Fit.

Belts and Coolant Hose for Medium/Heavy-Duty Trucks (2001 & Newer)

Application	Mfr. Part No.	Our No.	Application	Mfr. Part No.	Our No.
Kenworth - Continued			Kenworth - Continued		
2010 - Continued			2010 - Continued		
Cummins ISX15 Diesel - Continued			Paccar PX-6 Diesel - Continued		
T660 - Continued			K260 - Continued		
Hose - Pipe To Engine (Cold Side)	D506039	26203	Hose - Pressure - Pump To Injector; W/1400mm Line	M50603371231400	DEF7026
T700			Hose - Pressure - Pump To Injector; W/900mm Line	M50603371230900	DEF7025
Belt - Fan	D8410006122180	▲K120858HD	Hose - Pressure - Pump To Injector; W/600mm Line	M50602274110600	DEF7021
Belt - Alt. & A.C.	D8410006061620	▲K060637HD	T270		
Tensioner Assy. - Fan	2871292	38587	Belt - Fan	3289864	▲K080825HD
Tensioner Assy. - Alt. & A.C.	3104149	38610	Hose - Upper - Rad. To Pipe	≈<24840	
Tensioner Pulley - Fan	2871292	36165	Hose - Upper - Pipe To Eng.	≈<24828	
T800			Hose - Lower - Rad. To Oil Cooler	≈<24840	
Belt - A.C. - From W.P.	D8410006061620	▲K060637HD	Hose - Lower - Oil Cooler To Pipe	≈<24836	
Belt - Fan, W.P. & Alt.	D8410006122215	▲K120872HD	Hose - Lower - Pipe To Eng.	≈<24832	
Tensioner Assy. - A.C.	3104149	38610	Hose - Return - Pump To Tank; W/550mm Line	M50602274110550	DEF7020
Tensioner Assy. - Fan, W.P. & Alt.	2871292	38587	Hose - Return - Pump To Tank; W/500mm Line	M50603474110500	DEF7001
Idler Pulley - A.C.	3682229	36223	Hose - Suction - Tank To Pump; W/600mm Line	M50602274320600	DEF7014
Hose - Upper - Eng. To Pipe	≈<28212		Hose - Suction - Tank To Pump; W/650mm Line	M50603474320650	DEF7055
Hose - Upper - Pipe To Rad.	28359		Hose - Pressure - Pump To Injector; W/1300mm Line	M50602072131300	DEF7050
Hose - Lower - Eng. To Pipe	≈<24440		Hose - Pressure - Pump To Injector; W/2600mm Line	M50603372132600	DEF7054
Hose - Lower - Pipe To Rad.	≈<28212		Hose - Pressure - Pump To Injector; W/800mm Line	M50602072130800	DEF7049
Hose - Return - Pump To Tank	M50602274110500	DEF7001	Hose - Turbo To Pipe (Hot Side)		26203
Hose - Suction - Tank To Pump	M50602274320500	DEF7002	Hose - Pipe To Intercooler (Hot Side)		26203
Hose - Pressure - Pump To Injector; W/1700mm Line	M50603372131700	DEF7044	Hose - Intercooler To Pipe (Cold Side)		26203
Hose - Pressure - Pump To Injector; W/2100mm Line	M50602072132100	DEF7047	Hose - Pipe To Engine (Cold Side)		26203
T2000			Paccar PX-8 Diesel		
Belt - Fan	D8410006122180	▲K120858HD	T370		
Belt - Alt. & A.C.	D8410006061620	▲K060637HD	Belt - Fan, A.C., Alt. & W.P.	3289974	▲K080855HD
Tensioner Assy. - Fan	2871292	38587	Tensioner Assy.	3973819	38627
Tensioner Assy. - Alt. & A.C.	3104149	38610	Idler Pulley	3970945	36283
Tensioner Pulley - Fan	2871292	36165	2009		
W900			Caterpillar C13 Diesel		
Belt - Fan, W.P. & Alt.	D8410006122310	▲K120911HD	T660		
Belt - A.C. - From W.P.	D8410006061620	▲K060637HD	Belt - Fan & A.C.	D8410006102405	K100946HD
Tensioner Assy. - A.C.	3104149	38610	Belt - Alt.	D8410006062175	▲K060858HD
Tensioner Assy. - Fan, W.P. & Alt.	2871292	38587	Tensioner Assy. - Fan & A.C.	2873203	38646
Idler Pulley - A.C.	3682229	36223	Tensioner Assy. - Alt.	2756558	38635
Hose - Upper - Eng. To Pipe	≈<28212		Idler Pulley - Fan & A.C. (Smooth)	2850273	36164
Hose - Upper - Pipe To Rad.	28359		Idler Pulley - Fan & A.C. (Grooved)	2850276	36164
Hose - Lower - Eng. To Pipe	24840		Idler Pulley - Alt.	2790251	36227
Hose - Lower - Pipe To Rad.	28200		Hose - Upper	≈<28212	
Paccar MX Diesel			Hose - Lower	28359	
T700			T800		
Belt - Fan	D841002121640	K120645HD	Belt - Fan & Alt.	D8410006102405	K100946HD
Belt - Alt. & A.C.	D841002071939	K070762HD	Belt - A.C.	D8410006062175	▲K060858HD
Tensioner Assy. - Alt. & A.C.	1787113PE	38670	Tensioner Assy. - Fan & Alt.	2756558	38635
Idler Pulley - Alt. & A.C.	1787114PE	36359	Tensioner Assy. - A.C.	2873203	38646
Paccar PX-6 Diesel			Hose - Upper - Eng. To Pipe	≈<24240	
K260			Hose - Upper - Pipe To Rad.	24240	
Hose - Pressure - Pump To Injector; W/2700mm Line	M50602072232700	DEF7041	Hose - Lower - Eng. To Pipe	21891	
Hose - Pressure - Pump To Injector; W/2600mm Line	M50603371232600	DEF7035	Hose - Lower - Pipe To Rad.	21891	
Hose - Pressure - Pump To Injector; W/2500mm Line	M50603371232500	DEF7034	Caterpillar C15 Diesel		
Hose - Pressure - Pump To Injector; W/2100mm Line	M50603371232100	DEF7032	C500		
Hose - Pressure - Pump To Injector; W/2400mm Line	M50603371232400	DEF7033	Belt - Fan & A.C.	D8410006061695	K060667
Hose - Pressure - Pump To Injector; W/1900mm Line	M50603371231900	DEF7031	Tensioner Assy. - Fan & A.C.	3368955	38609
Hose - Pressure - Pump To Injector; W/1800mm Line	M50603371231800	DEF7030	Tensioner Assy. - Alt.	2790253	38636
Hose - Pressure - Pump To Injector; W/1700mm Line	M50603371231700	DEF7029			
Hose - Pressure - Pump To Injector; W/1500mm Line	M50603371231500	DEF7028			

▲Standard Belt Available.

≈<Cut to Fit.

Medium & Heavy-Duty Trucks
(2001 & Newer)

Belts and Coolant Hose for Medium/Heavy-Duty Trucks (2001 & Newer)

Medium & Heavy-Duty Trucks
(2001 & Newer)

Application	Mfr. Part No.	Our No.
Kenworth - Continued		
2009 - Continued		
Caterpillar C15 Diesel - Continued		
T660		
Belt - Fan & A.C.		K120980HD
Belt - Alt.		▲K060739HD
Tensioner Assy. - Alt.		38609
Tensioner Assy. - Fan & A.C.		38587
Tensioner Pulley - Fan & A.C.		36165
Hose - Upper - Eng. To Pipe		≈<21891
Hose - Upper - Pipe To Rad.		≈<24240
Hose - Lower - Eng. To Pipe		≈<24240
Hose - Lower - Pipe To Rad.		≈<21135
T800		
Belt - Fan & A.C.	D8410006122490	K120980HD
Belt - Fan To Alt.	D8410006061870	K060736HD
Tensioner Assy. - Fan & A.C.	2362301	38609
Tensioner Assy. - Alt.	2790253	38636
Idler Pulley - A.C. (Lower)	2850277	36282
Idler Pulley - Alt. (Upper)	2790252	36230
Idler Pulley - Alt. (Lower)	2790252	36230
Hose - Upper - Eng. To Pipe		≈<28212
Hose - Upper - Pipe To Rad.		28359
Hose - Lower - Eng. To Pipe		≈<24240
Hose - Lower - Pipe To Rad.		≈<28212
W900		
Belt - Alt. - From Fan	D8410006061750	▲K060690HD
Belt - Fan & A.C.	D8410006122665	K121049HD
Tensioner Assy. - Fan & Alt.	2790253	38636
Tensioner Assy. - Fan & A.C.	2362301	38609
Idler Pulley - Fan & Alt. (Upper)	2790252	36230
Idler Pulley - Fan & Alt. (Lower)	2790252	36230
Idler Pulley - A.C. (Lower)	2850277	36282
Hose - Upper - Eng. To Pipe		24440
Hose - Upper - Pipe To Rad.		24840
Hose - Lower - Eng. To Pipe		24440
Hose - Lower - Pipe To Rad.		24440
Cummins ISC Diesel		
T370		
Belt - Fan, A.C., Alt. & W.P.	3289974	▲K080855HD
Tensioner Assy. - Fan, A.C., Alt. & W.P.	3973819	38627
Idler Pulley	3970945	36283
Cummins ISL Diesel		
W900		
Belt - Fan & Alt.	3289930	▲K080690HD
Belt - A.C.	D8410006061290	▲K060509HD
Tensioner Assy. - A.C.	3973819	38627
Cummins ISM Diesel		
T800		
Belt - Fan & Alt.	D8410006081735	K080683HD
Belt - A.C.	4004824	▲K060539HD
Tensioner Assy. - Fan & Alt.	4920105	38622
Tensioner Assy. - A.C.	3102888	38505
W900		
Belt - Fan & Alt.	D8410006081735	K080683HD
Belt - A.C.	D8410003061370	▲K060539HD
Tensioner Assy. - Fan & Alt.	2871294	38622
Cummins ISX Diesel		
T660		
Belt - Fan, Alt. & W.P.	D8410006122215	▲K120872HD
Belt - A.C. - From W.P.	D8410006061620	▲K060637HD
Tensioner Assy. - Fan, W.P. & Alt.	3682946	38587
Tensioner Assy. - A.C.	3104149	38610
Idler Pulley - A.C.	3682229	36223
Hose - Upper - Eng. To Pipe		≈<28212
Hose - Upper - Pipe To Rad.		28359

▲Standard Belt Available.

Application	Mfr. Part No.	Our No.
Kenworth - Continued		
2009 - Continued		
Cummins ISX Diesel - Continued		
T660 - Continued		
Hose - Lower - Eng. To Pipe		24440
Hose - Lower - Pipe To Rad.		24440
T800		
Belt - A.C. - From W.P.	D8410006061620	▲K060637HD
Belt - Fan, Alt. & W.P.; W/88" Belt O.C.	D8410006122215	▲K120872HD
Belt - Fan, Alt. & W.P.; W/91 5/8" Belt O.C.	D8410006122310	▲K120911HD
Tensioner Assy. - A.C.	3104149	38610
Tensioner Assy. - Fan, W.P. & Alt.	2871292	38587
Idler Pulley - A.C.	3682229	36223
Hose - Upper - Eng. To Pipe; W/Conventional Hood		≈<28212
Hose - Upper - Pipe To Rad.; W/Conventional Hood		28359
Hose - Upper - Eng. To Pipe; W/Wide Hood		≈<24448
Hose - Lower - Eng. To Pipe; W/Conventional Hood		24440
Hose - Lower - Pipe To Rad.; W/Conventional Hood		≈<28212
Hose - Lower - Eng. To Pipe; W/Wide Hood		≈<24448
Hose - Lower - Pipe To Pipe; W/Wide Hood		≈<24448
Hose - Lower - Pipe To Rad.; W/Wide Hood		28359
W900		
Belt - Fan, Alt. & W.P.	D8410006122310	▲K120911HD
Belt - A.C. - From W.P.	D8410006061620	▲K060637HD
Tensioner Assy. - A.C.	3104149	38610
Tensioner Assy. - Fan, W.P. & Alt.	2871292	38587
Idler Pulley - A.C.	3682229	36223
Hose - Upper - Eng. To Pipe		≈<28212
Hose - Upper - Pipe To Rad.		28359
Hose - Lower - Eng. To Pipe		≈<24440
Hose - Lower - Pipe To Rad.		28200
Paccar PX-6 Diesel		
T170		
Belt - Fan, A.C., Alt. & W.P.	3972377	K080868HD
Tensioner Assy. - Fan, A.C., Alt. & W.P.	4937433	38631
Hose - Upper - Pipe To Rad.		28359
T270		
Belt - Fan, A.C., Alt. & W.P.	3972377	K080868HD
Tensioner Assy. - Fan, A.C., Alt. & W.P.	4937433	38631
Hose - Upper - Eng. To Pipe		≈<24428
Hose - Lower - Eng. To Pipe		≈<24428
T300; T370		
Belt - Fan, Alt. & A.C.; W/86" Belt O.C.	3289974	▲K080855HD
Belt - Fan, Alt. & A.C.; W/87 1/4" Belt O.C.	3972377	K080868HD
Tensioner Assy. - Fan, Alt. & A.C.	4937433	38631
Hose - Upper - Eng. To Pipe		24228
Hose - Upper - Pipe To Rad.		24240
Hose - Lower - Eng. To Pipe		24228
Hose - Lower - Pipe To Rad.		24240
Paccar PX-8 Diesel		
T270		
Belt - Fan, A.C., Alt. & W.P.	3289974	▲K080855HD
Tensioner Assy. - Fan, A.C., Alt. & W.P.	3973819	38627
T370		
Belt - Fan, A.C., Alt. & W.P.	3289974	▲K080855HD
Tensioner Assy. - Fan, A.C., Alt. & W.P.	3973819	38627
Idler Pulley	3970945	36283
2008		
Caterpillar C11 Diesel		
T800		
Belt - Fan, Alt. & A.C.	D11084930	▲K080952HD
Tensioner Assy. - Fan, Alt. & A.C.	2117895	38590
Tensioner Pulley - Fan, Alt. & A.C.	2117895	36164
Idler Pulley - Smooth	2078118	36269
Idler Pulley - Grooved	1979642	36341
Hose - Upper - Eng. To Pipe		24240

≈<Cut to Fit.

Belts and Coolant Hose for Medium/Heavy-Duty Trucks (2001 & Newer)

Application	Mfr. Part No.	Our No.	Application	Mfr. Part No.	Our No.
Kenworth - Continued			Kenworth - Continued		
2008 - Continued			2008 - Continued		
Caterpillar C11 Diesel - Continued			Cummins ISC Diesel - Continued		
T800 - Continued			T300 - Continued		
Hose - Upper - Pipe To Rad.		24240	Hose - Upper - Pipe To Rad.		24240
Hose - Lower - Eng. To Rad.		24240	Hose - Lower - Eng. To Rad.		24236
Hose - Lower - Rad. To Pipe		24248	Hose - Lower - Rad. To Pipe		24240
Caterpillar C13 Diesel			Cummins ISL Diesel		
T800			T800		
Belt - Fan & A.C.	D8410006102405	K100946HD	Belt - Fan, W.P. & Alt.	3972383	♣K080806HD
Belt - Alt.	D8410006062175	♣K060858HD	Belt - Fan To A.C.		♣9380HD
Tensioner Assy. - Alt.	2756558	38635	Tensioner Assy. - Fan, W.P. & Alt.	3936213	38516
Tensioner Assy. - Fan & A.C.	2873203	38646	Tensioner Pulley - Fan, W.P. & Alt.	3936213	36093
Hose - Upper - Eng. To Pipe		21891	Hose - Upper - Eng. To Pipe		24236
Hose - Upper - Pipe To Rad.		24240	Hose - Upper - Pipe To Rad.		24236
Hose - Lower - Eng. To Pipe		21891	Hose - Lower - Eng. To Pipe		24232
Hose - Lower - Pipe To Rad.		21891	Hose - Lower - Pipe To Cooler		24236
W900			W900		
Belt - Fan & A.C.	D8410006102405	K100946HD	Hose - Lower - Cooler To Pipe		24240
Belt - Alt.	D8410006062175	♣K060858HD	Hose - Lower - Pipe To Rad.		24052
Tensioner Assy. - Alt.	2756558	38635	W900		
Caterpillar C15 Diesel			Belt - Fan & Alt.		
T600			Belt - A.C.		
Tensioner Assy. - Fan & A.C.	2362301	38609	Tensioner Assy. - A.C.	3973819	38627
T660			Cummins ISM Diesel		
Belt - Fan & A.C.	D8410006122490	K120980HD	T600		
Belt - Fan To Alt.	D8410006061870	K060736HD	Belt - Alt.	D8410006081735	K080683HD
Hose - Upper - Eng. To Pipe		21891	Belt - A.C.	4004824	♣K060539HD
Hose - Upper - Pipe To Rad.		♣24240	Tensioner Assy. - Alt.	2871294	38622
Hose - Lower - Eng. To Pipe		♣24240	Idler Pulley - Fan & Alt.	3400884	36308
Hose - Lower - Pipe To Rad.		21135	Tensioner Pulley - A.C.	4004933	36091
T800			T800		
Belt - Fan & Alt.; W/Conventional Hood:			Belt - Fan & Alt.	D8410006081735	K080683HD
W/94" Belt O.C.	D8410001082370	♣K080934HD	Belt - A.C.	4004824	♣K060539HD
Belt - Fan & Alt.; W/Conventional Hood:			Tensioner Assy. - Fan & Alt.	4920105	38622
W/103" Belt O.C.	D11089803	♣K081023HD	Tensioner Assy. - A.C.	3102888	38505
Belt - Fan To A.C.; W/Conventional Hood:			W900		
W/50 1/2" Belt O.C.	D8410003061280	♣K060505HD	Belt - Fan & Alt.	D8410006081735	K080683HD
Belt - Fan To A.C.; W/Conventional Hood:			Belt - A.C.	D8410003061370	♣K060539HD
W/58" Belt O.C.	D11085689	♣K060575HD	Tensioner Assy. - Fan & Alt.	2871294	38622
Belt - Fan & Alt.; W/Short Hood	D8410006061870	K060736HD	Cummins ISX Diesel		
Belt - Fan & A.C.; W/Short Hood	D8410006122490	K120980HD	T600		
Tensioner Assy. - Fan & A.C.	2362301	38609	Idler Pulley - A.C. 3682229 36223		
Tensioner Assy. - Fan & Alt.	2790253	38636	T660		
Idler Pulley - Fan & Alt.; W/V-Groove Idler			Belt - Fan & Alt. D8410006122215 ♣K120872HD		
Pulley	2790252	36230	Belt - Hub & A.C. D8410006061620 ♣K060637HD		
Idler Pulley - A.C.; W/V-Groove Idler Pulley	2850277	36282	Tensioner Assy. - Hub & A.C. 3682683 38610		
Hose - Upper - Eng. To Pipe		24240	Tensioner Assy. - Fan & Alt. 3682946 38587		
Hose - Upper - Pipe To Rad.		24240	Idler Pulley - A.C. 3682229 36223		
Hose - Lower - Eng. To Pipe		24248	Tensioner Pulley - Fan & Alt. 3682946 36165		
Hose - Lower - Pipe To Rad.		24248	Hose - Upper - Eng. To Pipe 21891		
W900			Hose - Upper - Rad. To Pipe 24240		
Belt - Fan & A.C.	D8410006122665	K121049HD	Hose - Lower - Eng. To Pipe 24240		
Belt - Fan To Alt.	D8410006061750	♣K060690HD	Hose - Lower - Rad. To Pipe 24240		
Tensioner Assy. - Fan & Alt.	2362301	38609	T800		
Tensioner Assy. - Fan To A.C.	2790253	38636	Belt - Fan & Alt. D8410006122215 ♣K120872HD		
Idler Pulley - Smooth	1979641	36091	Belt - Hub & A.C. D11085527 ♣K060637HD		
Idler Pulley - Grooved	1979642	36341	Tensioner Assy. - Hub & A.C. 3682683 38610		
Hose - Upper - Eng. To Pipe		24240	Tensioner Assy. - Fan & Alt. 3682946 38587		
Hose - Upper - Pipe To Rad.		24240	Idler Pulley - A.C. 3682229 36223		
Hose - Lower - Eng. To Pipe		24240	Tensioner Pulley - Fan & Alt. 3682946 36165		
Hose - Lower - Pipe To Rad.		21135	Hose - Upper - Eng. To Pipe 21891		
Cummins ISC Diesel			Hose - Upper - Pipe To Rad. 24240		
T300			Hose - Lower - Eng. To Pipe 24240		
Belt - Fan, Alt. & A.C.	D8410001082430	♣K080956HD	Hose - Lower - Pipe To Rad. 21891		
Idler Pulley	3970945	36283	T2000		
Hose - Upper - Eng. To Pipe		24240	Idler Pulley - A.C. 3682229 36223		

♣Standard Belt Available.

♣Cut to Fit.

Medium & Heavy-Duty Trucks
(2001 & Newer)

Belts and Coolant Hose for Medium/Heavy-Duty Trucks (2001 & Newer)

Medium & Heavy-Duty Trucks
(2001 & Newer)

Application	Mfr. Part No.	Our No.	Application	Mfr. Part No.	Our No.
Kenworth - Continued			Kenworth - Continued		
2008 - Continued			2007 - Continued		
Cummins ISX Diesel - Continued			Caterpillar C13 Diesel - Continued		
W900			T800 - Continued		
Belt - Fan & Alt.	D8410006122310	♣K120911HD	Tensioner Pulley - Fan, Alt. & A.C.	2117895	36164
Belt - A.C.	D8410006061620	♣K060637HD	Idler Pulley - Smooth	2078118	36269
Tensioner Assy. - Fan & Alt.	3682946	38587	Idler Pulley - Grooved	1979642	36341
Tensioner Assy. - A.C.	3682683	38610	Hose - Upper - Eng. To Pipe		24240
Paccar 6-Cyl. 5.9 L Diesel			Hose - Upper - Pipe To Rad.		24240
K360			Hose - Lower - Eng. To Rad.		24248
Tensioner Assy.	4891116	38584	Hose - Lower - Rad. To Pipe		24248
Paccar PX-6 Diesel			W900		
T170			Belt - Fan, Alt. & A.C.		♣K080968HD
Belt - W.P., Fan, Alt. & A.C.	3972377	K080868HD	Tensioner Assy. - Fan, Alt. & A.C.	2117895	38590
Tensioner Assy. - W.P., Alt. & A.C.	4937433	38631	Tensioner Pulley - Fan, Alt. & A.C.	2117895	36164
Hose - Upper - Pipe To Rad.		28359	Idler Pulley - Smooth	2078118	36269
T300			Idler Pulley - Grooved	1979642	36341
Belt - Fan, Alt. & A.C.; W/86" Belt O.C.	3289974	♣K080855HD	Hose - Upper - Eng. To Pipe		24240
Belt - Fan, Alt. & A.C.; W/87 1/4" Belt O.C. .	3972377	K080868HD	Hose - Upper - Pipe To Rad.		24240
Tensioner Assy. - Fan, Alt. & A.C.	4937433	38631	Hose - Lower - Eng. To Rad.		24240
Hose - Upper - Eng. To Pipe		24228	Hose - Lower - Rad. To Pipe		24248
Hose - Upper - Pipe To Rad.		24240	Caterpillar C15 Diesel		
Hose - Lower - Eng. To Pipe		24228	C500		
Hose - Lower - Pipe To Rad.		24240	Belt - Fan To A.C.	D840003061315	♣K060516HD
Paccar PX-8 Diesel			Tensioner Assy. - Fan & Alt.	2002279	38569
T300			Tensioner Assy. - Fan To A.C.	2178938	38511
Idler Pulley	3970945	36283	Idler Pulley - Smooth	1979641	36091
T370			Idler Pulley - Grooved	1979642	36341
Belt - Serpentine	3289974	♣K080855HD	Tensioner Pulley - Fan To A.C.	2178938	36091
Tensioner Assy.	3973819	38627	T600		
Idler Pulley	3970945	36283	Belt - Fan & Alt.	D8410001082370	♣K080934HD
2007			Belt - Fan To A.C.	D8410003061460	♣K060575HD
Caterpillar C7 Diesel			Tensioner Assy. - Fan & Alt.	2002279	38569
T300			Tensioner Assy. - Fan To A.C.	2178938	38511
Belt - Fan, Alt. & A.C.	D11084843	♣K080810HD	Idler Pulley - Smooth	1979641	36091
Tensioner Assy. - Fan, Alt. & A.C.	2222880	38586	Idler Pulley - Grooved	1979642	36341
Idler Pulley - Lower	2534525	36096	Hose - Upper - Eng. To Pipe		24240
Hose - Upper - Eng. To Pipe		20206	Hose - Upper - Pipe To Rad.		24240
Hose - Upper - Pipe To Rad.		21194	Hose - Lower - Eng. To Pipe		24248
Caterpillar C11 Diesel			Hose - Lower - Pipe To Rad.		24248
T800			T660		
Belt - Fan, Alt. & A.C.	D11084930	♣K080952HD	Idler Pulley - Smooth	1979641	36091
Tensioner Assy. - Fan, Alt. & A.C.	2117895	38590	Idler Pulley - Grooved	1979642	36341
Tensioner Pulley - Fan, Alt. & A.C.	2117895	36164	T800		
Idler Pulley - Smooth	2078118	36269	Belt - Fan & Alt.; W/Conventional Hood;		
Idler Pulley - Grooved	1979642	36341	W/94" Belt O.C.	D8410001082370	♣K080934HD
Hose - Upper - Eng. To Pipe		24240	Belt - Fan & Alt.; W/Conventional Hood;		
Hose - Upper - Pipe To Rad.		24240	W/103" Belt O.C.	D11089803	♣K081023HD
Hose - Lower - Eng. To Rad.		24240	Belt - Fan To A.C.; W/Conventional Hood;		
Hose - Lower - Rad. To Pipe		24248	W/50 1/2" Belt O.C.	D8410003061280	♣K060505HD
W900			Belt - Fan & Alt.; W/Short Hood	D8410003122480	♣K120975HD
Belt - Fan, Alt. & A.C.	D8410003082450	K080964HD	Belt - Fan To A.C.; W/Conventional Hood;		
Tensioner Assy. - Fan, Alt. & A.C.	2117895	38590	W/58" Belt O.C.	D11085689	♣K060575HD
Tensioner Pulley - Fan, Alt. & A.C.	2117895	36164	Belt - Fan To A.C.; W/Short Hood	D8410003061470	♣K060578HD
Idler Pulley - Smooth	2078118	36269	Tensioner Assy. - Fan & Alt.;		
Idler Pulley - Grooved	1979642	36341	W/Conventional Hood	2002279	38569
Hose - Upper - Eng. To Pipe		24240	Tensioner Assy. - Fan To A.C.	2178938	38511
Hose - Upper - Pipe To Rad.		24240	Idler Pulley - Smooth	1979641	36091
Hose - Lower - Eng. To Rad.		24240	Idler Pulley - Grooved	1979642	36341
Hose - Lower - Rad. To Pipe		24248	Hose - Upper - Eng. To Pipe		24240
Caterpillar C13 Diesel			Hose - Upper - Pipe To Rad.		24240
T800			Hose - Lower - Eng. To Pipe		24248
Belt - Fan, Alt. & A.C.	D11084930	♣K080952HD	Hose - Lower - Pipe To Rad.		24248
Tensioner Assy. - Fan, Alt. & A.C.	2117895	38590	T2000		
2007			Belt - Fan & Alt.	D11084936	♣K080939HD
Caterpillar C13 Diesel			Belt - Fan To A.C.	D11085527	♣K060637HD
T800			Tensioner Assy. - Fan & Alt.	2002279	38569
Belt - Fan, Alt. & A.C.	D11084930	♣K080952HD	Tensioner Assy. - Fan To A.C.	2178938	38511
Tensioner Assy. - Fan, Alt. & A.C.	2117895	38590	Idler Pulley - Smooth	1979641	36091

♣Standard Belt Available.

Belts and Coolant Hose for Medium/Heavy-Duty Trucks (2001 & Newer)

Application	Mfr. Part No.	Our No.	Application	Mfr. Part No.	Our No.
Kenworth - Continued			Kenworth - Continued		
2007 - Continued			2007 - Continued		
Caterpillar C15 Diesel - Continued			Cummins ISM Diesel - Continued		
T2000 - Continued			T800 - Continued		
Idler Pulley - Grooved	1979642	36341	Idler Pulley - Fan & Alt.	3400884	36308
Tensioner Pulley - Fan To A.C.	2178938	36091	Tensioner Pulley - A.C.		36091
Hose - Upper - Eng. To Pipe		24240			
Hose - Lower - Eng. To Pipe		24248			
Hose - Lower - Pipe To Rad.		24240			
W900			W900		
Belt - Fan & Alt.; W/8-Ribbed Belt	D11084884	♣K080952HD	Belt - Fan & Alt.; W/Short Hood	D8410001081780	♣K080702HD
Belt - Fan & Alt.; W/12-Ribbed Belt	D8410001122540	K121000HD	Belt - Hub & A.C.; W/Short Hood	4004824	♣K060539HD
Belt - Fan & A.C.; W/55 7/8" Belt O.C.	D11085700	♣K060555HD	Tensioner Assy. - Fan & Alt.	4920105	38622
Belt - Fan To A.C.; W/62" Belt O.C.	D11085352	♣K060615HD	Tensioner Assy. - Hub & A.C.	4004933	38505
Tensioner Assy. - Fan & Alt.; W/8-Ribbed Belt	2002279	38569	Idler Pulley - Fan & Alt.	3400884	36308
Tensioner Assy. - Fan & Alt.; W/12-Ribbed Belt	2362301	38609	Tensioner Pulley - A.C.	4004933	36091
Tensioner Assy. - Fan To A.C.	2178938	38511	Hose - Upper - Eng. To Pipe		24240
Idler Pulley - Smooth	1979641	36091	Hose - Upper - Pipe To Rad.		24240
Idler Pulley - Grooved	1979642	36341	Hose - Lower - Eng. To Pipe		24240
Tensioner Pulley - Fan To A.C.	2178938	36091	Hose - Lower - Pipe To Rad.		24248
Hose - Upper - Eng. To Pipe		24240			
Hose - Upper - Pipe To Rad.		24240			
Hose - Lower - Eng. To Pipe		24248			
Hose - Lower - Pipe To Rad.		24248			
Cummins ISB Diesel			Cummins ISX Diesel		
T300			T600		
Belt - Fan, Alt. & A.C.	3289974	♣K080855HD	Belt - Fan & Alt.	D8410001122195	♣K120864HD
Tensioner Assy. - Fan, Alt. & A.C.	3976833	38517	Belt - Hub, Alt. & A.C.	D8410003061620	♣K060637HD
Hose - Upper - Eng. To Pipe		24228	Tensioner Assy. - Hub & A.C.	3682683	38610
Hose - Upper - Pipe To Rad.		≧21115	Tensioner Assy. - Fan & Alt.	3682946	38587
Hose - Lower - Eng. To Cooler		24240	Idler Pulley - A.C.	3682229	36223
			Tensioner Pulley - Fan & Alt.	3682946	36165
			Hose - Upper - Eng. To Pipe		24240
			Hose - Upper - Pipe To Rad.		24240
			Hose - Lower - Eng. To Pipe		24240
			Hose - Lower - Pipe To Rad.		24248
Cummins ISC Diesel			T660		
T300			Tensioner Assy. - Hub & A.C.		
Belt - Fan, Alt. & A.C.	D8410001082430	♣K080956HD	Tensioner Assy. - Fan & Alt.	3682946	38587
Belt - Fan & Alt.; W/O A.C.	3972265	♣K080878HD	Idler Pulley - A.C.	3682229	36223
Tensioner Assy. - Fan, Alt. & A.C.	3976831	38516	Tensioner Pulley - Fan & Alt.	3682946	36165
Idler Pulley	3970945	36283			
Hose - Upper - Eng. To Pipe		24240			
Hose - Upper - Pipe To Rad.		24240			
Hose - Lower - Eng. To Rad.		24236			
Hose - Lower - Rad. To Pipe		24240			
Cummins ISL Diesel			T800		
T800			Belt - Fan, Alt. & W.P.; W/Conventional Hood		
Belt - Fan, W.P. & Alt.	3972383	♣K080806HD	Belt - Fan, Alt. & W.P.; W/Wide Hood	D8410001122195	♣K120864HD
Belt - Fan To A.C.		♣9380HD	Belt - Fan, Alt. & W.P.; W/Wide Hood	D8410003122400	K120945HD
Tensioner Assy. - Fan, W.P. & Alt.	3936213	38516	Belt - A.C. - From W.P.	D8410003061620	♣K060637HD
Tensioner Pulley - Fan, W.P. & Alt.	3936213	36093	Tensioner Assy. - Hub & A.C.	3682683	38610
Hose - Upper - Eng. To Pipe		24236	Tensioner Assy. - Fan & Alt.	3682946	38587
Hose - Upper - Pipe To Rad.		24236	Idler Pulley - A.C.	3682229	36223
Hose - Lower - Eng. To Pipe		24232	Tensioner Pulley - Fan & Alt.	3682946	36165
Hose - Lower - Pipe To Cooler		24236	Hose - Upper - Eng. To Pipe		24240
Hose - Lower - Cooler To Pipe		24240	Hose - Upper - Pipe To Rad.		24240
Hose - Lower - Pipe To Rad.		24052	Hose - Lower - Eng. To Pipe		24240
			Hose - Lower - Pipe To Rad.		24248
Cummins ISM Diesel			T2000		
T600			Belt - Fan, Alt. & Hub		
Idler Pulley - Fan & Alt.	3400884	36308	Belt - Hub & A.C.	D8410001122195	♣K120864HD
Tensioner Pulley - A.C.	4004933	36091	Tensioner Assy. - Hub & A.C.	D8410003061620	♣K060637HD
			Tensioner Assy. - Fan & Alt.	3682683	38610
			Tensioner Assy. - Fan & Alt.	3682946	38587
			Idler Pulley - A.C.	3682229	36223
			Tensioner Pulley - Fan & Alt.	3682946	36165
			Hose - Upper - Eng. To Pipe		24240
			Hose - Upper - Pipe To Rad.		26531
			Hose - Lower - Eng. To Pipe		21591
			Hose - Lower - Pipe To Rad.		24240
T660			W900		
Idler Pulley - Fan & Alt.	3400884	36308	Belt - Fan & Alt.	D11084210	♣K120878HD
			Belt - Hub, Alt. & A.C.	D11085527	♣K060637HD
			Tensioner Assy. - Hub & A.C.	3682683	38610
			Tensioner Assy. - Fan & Alt.	3682946	38587
			Idler Pulley - A.C.	3682229	36223
			Tensioner Pulley - Fan & Alt.	3682946	36165
			Hose - Upper - Eng. To Pipe		24240
			Hose - Upper - Pipe To Rad.		24240
			Hose - Lower - Eng. To Pipe		21591
			Hose - Lower - Pipe To Rad.		24240
T800			W900		
Belt - Fan & Alt.	D11084891	♣K080702HD	Belt - Fan & Alt.	D11084210	♣K120878HD
Belt - A.C.	4004824	♣K060539HD	Belt - Hub, Alt. & A.C.	D11085527	♣K060637HD
Tensioner Assy. - Fan & Alt.	4920105	38622	Tensioner Assy. - Hub & A.C.	3682683	38610
Tensioner Assy. - A.C.	3102888	38505	Tensioner Assy. - Fan & Alt.	3682946	38587
			Idler Pulley - A.C.	3682229	36223
			Tensioner Pulley - Fan & Alt.	3682946	36165
			Hose - Upper - Eng. To Pipe		24240

Medium & Heavy-Duty Trucks (2001 & Newer)

♣Standard Belt Available.

≧Cut to Fit.

Belts and Coolant Hose for Medium/Heavy-Duty Trucks (2001 & Newer)

Medium & Heavy-Duty Trucks
(2001 & Newer)

Application	Mfr. Part No.	Our No.	Application	Mfr. Part No.	Our No.
Kenworth - Continued			Kenworth - Continued		
2007 - Continued			2006 - Continued		
Cummins ISX Diesel - Continued			Caterpillar C13 Diesel - Continued		
W900 - Continued			W900		
Hose - Upper - Pipe To Rad.; W/O E.G.R.		24240	Belt - Fan, Alt. & A.C.		♣K080968HD
Hose - Lower - Eng. To Pipe		24240	Tensioner Assy. - Fan, Alt. & A.C.	2117895	38590
Hose - Lower - Pipe To Rad.		24240	Tensioner Pulley - Fan, Alt. & A.C.	2117895	36164
Paccar 6-Cyl. 5.9 L Diesel			Idler Pulley - Smooth	2078118	36269
K360			Idler Pulley - Grooved	1979642	36341
Tensioner Assy. - Fan & Alt.	4891116	38584	Hose - Upper - Eng. To Pipe		24240
Paccar PX-6 Diesel			Hose - Upper - Pipe To Rad.		24240
T300			Hose - Lower - Eng. To Rad.		24240
Belt - Fan, Alt. & A.C.	3972377	K080868HD	Hose - Lower - Rad. To Pipe		24248
Tensioner Assy. - Fan, Alt. & A.C.	4937433	38631	Caterpillar C15 Diesel		
Hose - Upper - Eng. To Pipe		24228	C500		
Hose - Upper - Pipe To Rad.		24240	Belt - Fan To A.C.	D840003061315	♣K060516HD
Hose - Lower - Eng. To Pipe		24228	Tensioner Assy. - Fan & Alt.	2002279	38569
Hose - Lower - Pipe To Rad.		24240	Tensioner Assy. - Fan To A.C.	2178938	38511
2006			Idler Pulley - Smooth	1979641	36091
Caterpillar C7 Diesel			Idler Pulley - Grooved	1979642	36341
T300			Tensioner Pulley - Fan To A.C.	2178938	36091
Belt - Fan, Alt. & A.C.	D11084843	♣K080810HD	T600		
Tensioner Assy. - Fan, Alt. & A.C.	2222880	38586	Belt - Fan & Alt.	D8410001082370	♣K080934HD
Idler Pulley - Upper	1979641	36091	Belt - Fan To A.C.	D8410003061460	♣K060575HD
Idler Pulley - Lower	2534525	36096	Tensioner Assy. - Fan & Alt.	1900649	38506
Hose - Upper - Eng. To Pipe		20206	Tensioner Assy. - Fan To A.C.	1900642	38508
Hose - Upper - Pipe To Rad.		21194	Idler Pulley - Smooth	1979641	36091
Caterpillar C11 Diesel			Idler Pulley - Grooved	1979642	36341
T800			Tensioner Pulley - Fan & Alt.	1900649	36091
Belt - Fan, Alt. & A.C.	D11084930	♣K080952HD	Tensioner Pulley - Fan To A.C.	1900642	36091
Tensioner Assy. - Fan, Alt. & A.C.	2117895	38590	Hose - Upper - Eng. To Pipe		24240
Tensioner Pulley - Fan, Alt. & A.C.	2117895	36164	Hose - Upper - Pipe To Rad.		24240
Idler Pulley - Smooth	2078118	36269	Hose - Lower - Eng. To Pipe		24248
Idler Pulley - Grooved	1979642	36341	Hose - Lower - Pipe To Rad.		24248
Hose - Upper - Eng. To Pipe		24240	T800		
Hose - Upper - Pipe To Rad.		24240	Belt - Fan & Alt.; W/Conventional Hood	D8410001082370	♣K080934HD
Hose - Lower - Eng. To Rad.		24240	Belt - Fan & Alt.; W/Short Hood	D8410003122480	♣K120975HD
Hose - Lower - Rad. To Pipe		24248	Belt - Fan To A.C.; W/Conventional Hood;		
W900			W/51" Belt O.C.	D8410003061280	♣K060505HD
Belt - Fan, Alt. & A.C.	D8410003082450	K080964HD	Belt - Fan & Alt.; W/Wide Hood	D8410003082600	♣K081023HD
Tensioner Assy. - Fan, Alt. & A.C.	2117895	38590	Belt - Fan To A.C.; W/Conventional Hood;		
Tensioner Pulley - Fan, Alt. & A.C.	2117895	36164	W/58" Belt O.C.	D11085689	♣K060575HD
Idler Pulley - Smooth	2078118	36269	Belt - Fan To A.C.; W/Short Hood	D8410003061470	♣K060578HD
Idler Pulley - Grooved	1979642	36341	Belt - Fan & A.C.; W/Wide Hood	D8410003061280	♣K060505HD
Hose - Upper - Eng. To Pipe		24240	Tensioner Assy. - Fan & Alt.		
Hose - Upper - Pipe To Rad.		24240	W/Conventional Hood	2002279	38569
Hose - Lower - Eng. To Rad.		24240	Tensioner Assy. - Fan & A.C.	2178938	38511
Hose - Lower - Rad. To Pipe		24248	Idler Pulley - Smooth	1979641	36091
Caterpillar C13 Diesel			Idler Pulley - Grooved	1979642	36341
T800			Hose - Upper - Eng. To Pipe		24240
Belt - Fan, Alt. & A.C.; W/Short Hood		♣K080952HD	Hose - Upper - Pipe To Rad.; W/Conventional Hood		24240
Tensioner Assy. - Fan, Alt. & A.C.	2117895	38590	Hose - Lower - Eng. To Pipe		24248
Tensioner Pulley - Fan, Alt. & A.C.	2117895	36164	Hose - Lower - Pipe To Rad.		24248
Idler Pulley - Smooth	2078118	36269	T2000		
Idler Pulley - Grooved	1979642	36341	Belt - Fan & Alt.	D11084936	♣K080939HD
Hose - Upper - Eng. To Pipe		24240	Belt - Fan To A.C.	D11085527	♣K060637HD
Hose - Upper - Pipe To Rad.		24240	Tensioner Assy. - Fan & Alt.	2002279	38569
Hose - Lower - Eng. To Rad.		24240	Tensioner Assy. - Fan To A.C.	2178938	38511
Hose - Lower - Rad. To Pipe		24248	Idler Pulley - Smooth	1979641	36091
T2000			Idler Pulley - Grooved	1979642	36341
Belt - Accessory Drive		♣K080956HD	Tensioner Pulley - Fan To A.C.	2178938	36091
Tensioner Assy.	2117895	38590	Hose - Upper - Eng. To Pipe		24240
Hose - Upper - Eng. To Pipe		♣21891	Hose - Upper - Pipe To Rad.; W/O Clean Air Pkg.		24240
Hose - Upper - Pipe To Rad.		♣20996	Hose - Lower - Eng. To Pipe		24248
Hose - Lower - Eng. To Pipe		♣24240	Hose - Lower - Pipe To Rad.; W/Clean Air Pkg.		24240
			Hose - Lower - Pipe To Rad.; W/O Clean Air Pkg.		24248
			W900		
			Belt - Fan & Alt.; W/8-Ribbed Belt; W/96"		
			Belt O.C.	D11084884	♣K080952HD

♣Standard Belt Available.

♣Cut to Fit.

Belts and Coolant Hose for Medium/Heavy-Duty Trucks (2001 & Newer)

Application	Mfr. Part No.	Our No.	Application	Mfr. Part No.	Our No.
Kenworth - Continued			Kenworth - Continued		
2006 - Continued			2006 - Continued		
Caterpillar C15 Diesel - Continued			Cummins ISM Diesel - Continued		
W900 - Continued			W900 - Continued		
Belt - Fan & Alt.; W/8-Ribbed Belt; W/106" Belt O.C.	D11085882	K081055HD	Belt - Hub & A.C.; W/Short Hood	4004824	▲K060539HD
Belt - Fan & Alt.; W/12-Ribbed Belt	D8410001122540	K121000HD	Tensioner Assy. - Fan & Alt.	4920105	38622
Belt - Fan To A.C.; W/62" Belt O.C.	D11085352	▲K060615HD	Tensioner Assy. - Hub & A.C.	4004933	38505
Belt - Fan & A.C.; W/55 7/8" Belt O.C.	D11085700	▲K060555HD	Idler Pulley - Fan & Alt.	3400884	36308
Tensioner Assy. - Fan & Alt.; W/8-Ribbed Belt	2002279	38569	Tensioner Pulley - A.C.	4004933	36091
Tensioner Assy. - Fan & Alt.; W/12-Ribbed Belt	2362301	38609	Hose - Upper - Eng. To Pipe		24240
Tensioner Assy. - Fan To A.C.	2178938	38511	Hose - Upper - Pipe To Rad.		24240
Idler Pulley - Smooth	1979641	36091	Hose - Lower - Eng. To Pipe		24240
Idler Pulley - Grooved	1979642	36341	Hose - Lower - Pipe To Rad.		24248
Tensioner Pulley - Fan To A.C.	2178938	36091	Cummins ISX Diesel		
Hose - Upper - Eng. To Pipe		24240	T600		
Hose - Upper - Pipe To Rad.		24240	Belt - Fan, Alt. & W.P.	D11084213	▲K120864HD
Hose - Lower - Eng. To Pipe		24248	Belt - W.P. To A.C.	D8410003061620	▲K060637HD
Hose - Lower - Pipe To Rad.		24248	Tensioner Assy. - Hub & A.C.	3682683	38610
Cummins ISB Diesel			Tensioner Assy. - Fan & Alt.	3682946	38587
T300			Idler Pulley - A.C.	3682229	36223
Belt - Fan, Alt. & A.C.	3289974	▲K080855HD	Tensioner Pulley - Fan & Alt.	3682946	36165
Tensioner Assy. - Fan, Alt. & A.C.	3976833	38517	Hose - Upper - Eng. To Pipe		24240
Hose - Upper - Eng. To Pipe		24228	Hose - Upper - Pipe To Rad.		24240
Hose - Upper - Pipe To Rad.		≅21115	Hose - Lower - Eng. To Pipe		24240
Hose - Lower - Eng. To Cooler		24240	Hose - Lower - Pipe To Rad.		24248
Cummins ISC Diesel			T800		
T300			Belt - Fan, Alt. & W.P.; W/Conventional Hood	D8410001122195	▲K120864HD
Belt - Fan, Alt. & A.C.	3972265	▲K080878HD	Belt - Fan, Alt. & W.P.; W/Wide Hood	D8410003122400	K120945HD
Tensioner Assy. - Fan, Alt. & A.C.	3976831	38516	Belt - A.C. - From W.P.	D8410003061620	▲K060637HD
Idler Pulley	3970945	36283	Tensioner Assy. - Hub & A.C.	3682683	38610
Hose - Upper - Eng. To Pipe		24236	Tensioner Assy. - Fan & Alt.	3682946	38587
Hose - Upper - Pipe To Rad.		24236	Idler Pulley - A.C.	3682229	36223
Cummins ISL Diesel			Tensioner Pulley - Fan & Alt.	3682946	36165
T800			Hose - Upper - Eng. To Pipe		24240
Belt - Fan, W.P. & Alt.	3972383	▲K080806HD	Hose - Upper - Pipe To Rad.		24240
Belt - Fan To A.C.		▲9380HD	Hose - Lower - Eng. To Pipe		24240
Tensioner Assy. - Fan, W.P. & Alt.	3936213	38516	Hose - Lower - Pipe To Rad.		24240
Tensioner Pulley - Fan, W.P. & Alt.	3936213	36093	Hose - Lower - Cooler To Pipe		24240
Hose - Upper - Eng. To Pipe		24236	Hose - Lower - Rad. To Pipe		24052
Hose - Upper - Rad. To Pipe		24236	Cummins ISM Diesel		
Hose - Lower - Eng. To Pipe		24232	T600		
Hose - Lower - Pipe To Cooler		24236	Idler Pulley - Fan & Alt.	3400884	36308
Hose - Lower - Cooler To Pipe		24240	Tensioner Pulley - A.C.	4004933	36091
Hose - Lower - Rad. To Pipe		24052	T800		
Cummins ISM Diesel			Belt - Fan & Alt.	D8410001081780	▲K080702HD
T600			Belt - Hub & A.C.	4004824	▲K060539HD
Idler Pulley - Fan & Alt.	3400884	36308	Tensioner Assy. - Fan & Alt.	4920105	38622
Tensioner Pulley - A.C.	4004933	36091	Tensioner Assy. - Hub & A.C.	4004933	38505
T800			Idler Pulley - Fan & Alt.	3400884	36308
Belt - Fan & Alt.	D8410001081780	▲K080702HD	Tensioner Pulley - A.C.	4004933	36091
Belt - Hub & A.C.	4004824	▲K060539HD	Hose - Upper - Eng. To Pipe		24240
Tensioner Assy. - Fan & Alt.	4920105	38622	Hose - Upper - Pipe To Rad.		24240
Tensioner Assy. - Hub & A.C.	4004933	38505	Hose - Lower - Eng. To Pipe		24240
Idler Pulley - Fan & Alt.	3400884	36308	Hose - Lower - Pipe To Rad.		24248
Tensioner Pulley - A.C.	4004933	36091	T2000		
Hose - Upper - Eng. To Pipe		24240	Idler Pulley - Fan & Alt.	3400884	36308
Hose - Upper - Pipe To Rad.		24240	W900		
Hose - Lower - Eng. To Pipe		24240	Belt - Fan & Alt.	D8410001122230	▲K120878HD
Hose - Lower - Pipe To Rad.		24248	Belt - Hub, Alt. & A.C.	D8410003061620	▲K060637HD
T2000			Tensioner Assy. - Hub & A.C.	3682683	38610
Idler Pulley - Fan & Alt.	3400884	36308	Tensioner Assy. - Fan & Alt.	3682946	38587
W900			Idler Pulley - A.C.	3682229	36223
Belt - Fan & Alt.; W/Short Hood	D8410001081780	▲K080702HD	Tensioner Pulley - Fan & Alt.	3682946	36165
▲Standard Belt Available.			Hose - Upper - Eng. To Pipe		24240
			Hose - Upper - Pipe To Rad.; W/O E.G.R.		24240
			Hose - Lower - Eng. To Pipe		24240
			Hose - Lower - Pipe To Rad.		24240
			2005		
			Caterpillar C7 Diesel		
			T300		
			Belt - Fan, Alt. & A.C.	D8410001082175	▲K080859HD
			Tensioner Assy. - Fan, Alt. & A.C.	2222880	38586
			Idler Pulley - Upper	1979641	36091
			Idler Pulley - Lower	2534525	36096
			≅Cut to Fit.		

Medium & Heavy-Duty Trucks (2001 & Newer)

Belts and Coolant Hose for Medium/Heavy-Duty Trucks (2001 & Newer)

Medium & Heavy-Duty Trucks
(2001 & Newer)

Application	Mfr. Part No.	Our No.	Application	Mfr. Part No.	Our No.
Kenworth - Continued			Kenworth - Continued		
2005 - Continued			2005 - Continued		
Caterpillar C7 Diesel - Continued			Caterpillar C15 Diesel - Continued		
T300 - Continued			T600 - Continued		
Hose - Upper - Eng. To Pipe		20206	Idler Pulley - Smooth	1979641	36091
Hose - Upper - Pipe To Rad.		21194	Idler Pulley - Grooved	1979642	36341
Caterpillar C11 Diesel			Tensioner Pulley - Fan To A.C.	1900642	36091
T800			Hose - Upper - Eng. To Pipe		24240
Belt - Fan, Alt. & A.C.; W/Conventional Hood	D8410001082420	♣K080952HD	Hose - Upper - Pipe To Rad.		24240
Belt - Fan, Alt. & A.C.; W/Short Hood	D8410003082730	♣K081074HD	Hose - Lower - Eng. To Pipe		24248
Tensioner Assy. - Fan, Alt. & A.C.	2117895	38590	Hose - Lower - Pipe To Rad.		24248
Tensioner Pulley - Fan, Alt. & A.C.	2117895	36164	T800		
Idler Pulley - Smooth	2078118	36269	Belt - Fan & Alt.	D11084948	♣K080934HD
Idler Pulley - Grooved	1979642	36341	Belt - Fan To A.C.	D11085688	♣K060575HD
Hose - Upper - Eng. To Pipe		24240	Tensioner Assy. - Fan & Alt.	2002279	38569
Hose - Upper - Pipe To Rad.; W/Conventional Hood		24240	Tensioner Assy. - Fan To A.C.	2178938	38511
Hose - Lower - Eng. To Pipe; W/Conventional Hood		24240	Idler Pulley - Smooth	1979641	36091
Hose - Lower - Eng. To Pipe; W/Short Hood		21891	Idler Pulley - Grooved	1979642	36341
Hose - Lower - Pipe To Pipe; W/Short Hood		24240	Hose - Upper - Eng. To Pipe		24240
Hose - Lower - Pipe To Rad.		24248	Hose - Upper - Pipe To Rad.		24240
W900			Hose - Lower - Eng. To Pipe		24248
Belt - Fan, Alt. & A.C.	D8410003082450	K080964HD	Hose - Lower - Pipe To Rad.		24248
Tensioner Assy. - Fan, Alt. & A.C.	2117895	38590	T2000		
Tensioner Pulley - Fan, Alt. & A.C.	2117895	36164	Belt - Fan & Alt.	D11084936	♣K080939HD
Idler Pulley - Smooth	2078118	36269	Belt - Fan To A.C.	D11085527	♣K060637HD
Idler Pulley - Grooved	1979642	36341	Tensioner Assy. - Fan & Alt.	2002279	38569
Hose - Upper - Eng. To Pipe		24240	Tensioner Assy. - Fan To A.C.	2178938	38511
Hose - Upper - Pipe To Rad.		24240	Idler Pulley - Smooth	1979641	36091
Hose - Lower - Eng. To Rad.		24240	Idler Pulley - Grooved	1979642	36341
Hose - Lower - Rad. To Pipe		24248	Tensioner Pulley - Fan To A.C.	2178938	36091
Caterpillar C13 Diesel			Hose - Upper - Eng. To Pipe		24240
T800			Hose - Upper - Pipe To Rad.; W/O Clean Air Pkg.		24240
Belt - Fan, Alt. & A.C.; W/Conventional Hood	D8410001082420	♣K080952HD	Hose - Lower - Eng. To Pipe		24248
Belt - Fan, Alt. & A.C.; W/Short Hood	D8410003082730	♣K081074HD	Hose - Lower - Pipe To Rad.; W/Clean Air Pkg.		24240
Tensioner Assy. - Fan, Alt. & A.C.	2117895	38590	Hose - Lower - Pipe To Rad.; W/O Clean Air Pkg.		24248
Tensioner Pulley - Fan, Alt. & A.C.	2117895	36164	W900		
Idler Pulley - Smooth	2078118	36269	Belt - Fan & Alt.; W/8-Ribbed Belt; W/96" Belt O.C.	D11084884	♣K080952HD
Idler Pulley - Grooved	1979642	36341	Belt - Fan & Alt.; W/8-Ribbed Belt; W/106" Belt O.C.	D11085882	K081055HD
Hose - Upper - Eng. To Pipe		24240	Belt - Fan To A.C.	D11085352	♣K060615HD
Hose - Upper - Pipe To Rad.; W/Conventional Hood		24240	Tensioner Assy. - Fan & Alt.	2002279	38569
Hose - Lower - Eng. To Pipe; W/Conventional Hood		24240	Tensioner Assy. - Fan To A.C.	2178938	38511
Hose - Lower - Eng. To Pipe; W/Short Hood		21891	Idler Pulley - Smooth	1979641	36091
Hose - Lower - Pipe To Pipe; W/Short Hood		24240	Idler Pulley - Grooved	1979642	36341
Hose - Lower - Pipe To Rad.		24248	Tensioner Pulley - Fan To A.C.	2178938	36091
W900			Hose - Upper - Eng. To Pipe		24240
Belt - Fan, Alt. & A.C.		♣K080968HD	Hose - Upper - Pipe To Rad.		24240
Tensioner Assy. - Fan, Alt. & A.C.	2117895	38590	Hose - Lower - Eng. To Pipe		24248
Tensioner Pulley - Fan, Alt. & A.C.	2117895	36164	Hose - Lower - Pipe To Rad.		24248
Idler Pulley - Smooth	2078118	36269	Cummins ISB Diesel		
Idler Pulley - Grooved	1979642	36341	T300		
Hose - Upper - Eng. To Pipe		24240	Belt - Fan, Alt. & A.C.	3289974	♣K080855HD
Hose - Upper - Pipe To Rad.		24240	Tensioner Assy. - Fan, Alt. & A.C.	3957433	38517
Hose - Lower - Eng. To Rad.		24240	Hose - Upper - Eng. To Pipe		24228
Hose - Lower - Rad. To Pipe		24248	Hose - Upper - Pipe To Rad.		♣21115
Caterpillar C15 Diesel			Hose - Lower - Eng. To Cooler		24240
T600			Cummins ISC Diesel		
Belt - Fan & Alt.; W/Clean Air Pkg.; W/84 7/8" Belt O.C.	D8410001082135	♣K080842HD	T300		
Belt - Fan & Alt.; W/Clean Air Pkg.; W/89 7/8" Belt O.C.	D11084906	♣K080893HD	Belt - Fan & Alt.	3959841	♣K080720HD
Belt - Fan To A.C.	D8410003061450	♣K060569HD	Belt - Fan To A.C.	D11022461	7417
Tensioner Assy. - Fan & Alt.; W/Clean Air Pkg.; W/84" Belt O.C.	1900643	38620	Tensioner Assy. - Fan & Alt.	3976831	38516
Tensioner Assy. - Fan & Alt.; W/Clean Air Pkg.; W/89" Belt O.C.	1900649	38506	Hose - Upper - Eng. To Pipe		24236
Tensioner Assy. - Fan To A.C.	1900642	38508	Hose - Lower - Eng. To Pipe		24236
			Hose - Lower - Pipe To Cooler		24240

♣Standard Belt Available.

♣Cut to Fit.

Belts and Coolant Hose for Medium/Heavy-Duty Trucks (2001 & Newer)

Application	Mfr. Part No.	Our No.	Application	Mfr. Part No.	Our No.
Kenworth - Continued			Kenworth - Continued		
2005 - Continued			2005 - Continued		
Cummins ISL Diesel			Cummins ISX Diesel - Continued		
T800			T2000		
Belt - Fan, W.P. & Alt.	3289369	♣K080716HD	Belt - Fan, Alt. & Hub	D8410001122195	♣K120864HD
Belt - Fan To A.C.	D11023525	♣9463HD	Belt - Hub & A.C.	D8410003061620	♣K060637HD
Tensioner Assy. - Fan, W.P. & Alt.	3936213	38516	Tensioner Assy. - Hub & A.C.	3682683	38610
Tensioner Pulley - Fan, W.P. & Alt.	3936213	36093	Tensioner Assy. - Fan & Alt.	3682946	38587
Hose - Upper - Eng. To Pipe		24236	Idler Pulley - A.C.	3682229	36223
Hose - Upper - Pipe To Rad.		24236	Tensioner Pulley - Fan & Alt.	3682946	36165
Hose - Lower - Eng. To Pipe		24232	Hose - Upper - Eng. To Pipe		24240
Hose - Lower - Pipe To Cooler		24236	Hose - Upper - Pipe To Rad.		26531
Hose - Lower - Cooler To Pipe		24240	Hose - Lower - Eng. To Pipe		21591
Hose - Lower - Pipe To Rad.		24052	Hose - Lower - Pipe To Rad.		24240
Cummins ISM Diesel			W900		
T600			Belt - Hub, Alt. & A.C.		
Idler Pulley - Fan & Alt.	3400884	36308	Tensioner Assy. - Fan & Alt.	3682946	38587
T800			Tensioner Assy. - Hub & A.C.	3682683	38610
Belt - Fan & Alt.	D8410001081780	♣K080702HD	Idler Pulley - A.C.	3682229	36223
Belt - Hub & A.C.	4004824	♣K060539HD	Tensioner Pulley - Fan & Alt.	3682946	36165
Tensioner Assy. - Fan & Alt.	4920105	38622	Hose - Upper - Eng. To Pipe		24240
Tensioner Assy. - Hub & A.C.	4004933	38505	Hose - Upper - Pipe To Rad.; W/O E.G.R.		24240
Idler Pulley - Fan & Alt.	3400884	36308	Hose - Lower - Eng. To Pipe		24240
Tensioner Pulley - A.C.	4004933	36091	Hose - Lower - Pipe To Rad.		24240
Hose - Upper - Eng. To Pipe		24240	2004		
Hose - Upper - Pipe To Rad.		24240	Caterpillar C7 Diesel		
Hose - Lower - Eng. To Pipe		24240	T300		
Hose - Lower - Pipe To Rad.		24248	Belt - Fan, Alt. & A.C.		
T2000			Tensioner Assy. - Fan, Alt. & A.C.		
Idler Pulley - Fan & Alt.	3400884	36308	Idler Pulley - Upper	1979641	36091
W900			Idler Pulley - Lower	2534525	36096
Belt - Fan & Alt.	D11084891	♣K080702HD	Hose - Upper - Eng. To Rad.		20206
Belt - Hub & A.C.	4004824	♣K060539HD	Hose - Upper - Rad. To Rad.		♣<20611
Tensioner Assy. - Fan & Alt.	4920105	38622	Caterpillar C10 Diesel		
Tensioner Assy. - Hub & A.C.	3102888	38505	T600		
Idler Pulley - Fan & Alt.	3400884	36308	Belt - Fan, Alt. & Hub		
Idler Pulley - A.C.	3104139	36225	Belt - Fan To A.C.		
Tensioner Pulley - A.C.	3102888	36091	Tensioner Assy. - Fan, Alt. & Hub		
Hose - Upper - Eng. To Pipe		24240	Idler Pulley - Fan & Alt.; W/Flat Idler Pulley .		
Hose - Upper - Pipe To Rad.		24240	Idler Pulley - Fan & Alt.; W/Multi-Grooved		
Hose - Lower - Eng. To Pipe		24240	Idler Pulley		
Hose - Lower - Pipe To Rad.		24248	Tensioner Pulley - Fan, Alt. & Hub		
Cummins ISX Diesel			Hose - Upper - Eng. To Pipe		
T600			Hose - Upper - Pipe To Rad.		
Belt - Fan & Alt.	D8410001122195	♣K120864HD	Hose - Lower - Eng. To Pipe		
Belt - Hub, Alt. & A.C.	D8410003061620	♣K060637HD	Hose - Lower - Pipe To Rad.		
Tensioner Assy. - Hub & A.C.	3682683	38610	T800		
Tensioner Assy. - Fan & Alt.	3682946	38587	Belt - Fan, Alt. & Hub		
Idler Pulley - A.C.	3682229	36223	Belt - Fan & A.C.		
Tensioner Pulley - Fan & Alt.	3682946	36165	Tensioner Assy. - Fan, Alt. & Hub		
Hose - Upper - Eng. To Pipe		24240	Idler Pulley - Fan & Alt.; W/Flat Idler Pulley .		
Hose - Upper - Pipe To Rad.		24240	Idler Pulley - Fan & Alt.; W/Multi-Grooved		
Hose - Lower - Eng. To Pipe		24240	Idler Pulley		
Hose - Lower - Pipe To Rad.		24248	Tensioner Pulley - Fan, Alt. & Hub		
T800			Hose - Upper - Eng. To Pipe		
Belt - Fan, Alt. & W.P.; W/Conventional Hood	D8410001122195	♣K120864HD	Hose - Upper - Pipe To Rad.		
Belt - Fan, Alt. & W.P.; W/Wide Hood	D8410003122400	K120945HD	Hose - Lower - Eng. To Pipe		
Belt - A.C. - From W.P.	D8410003061620	♣K060637HD	Hose - Lower - Pipe To Rad.		
Tensioner Assy. - Hub & A.C.	3682683	38610	W900		
Tensioner Assy. - Fan & Alt.	3682946	38587	Belt - Fan & Alt.		
Idler Pulley - A.C.	3682229	36223	Belt - Fan To A.C.		
Tensioner Pulley - Fan & Alt.	3682946	36165	Idler Pulley - Fan & Alt.; W/Flat Idler Pulley .		
Hose - Upper - Eng. To Pipe		24240	Idler Pulley - Fan & Alt.; W/Multi-Grooved		
Hose - Upper - Pipe To Rad.		24240	Idler Pulley		
Hose - Lower - Eng. To Pipe		24240	Hose - Upper - Eng. To Pipe		
Hose - Lower - Pipe To Rad.		24248	Hose - Upper - Pipe To Rad.		
			Hose - Lower - Eng. To Pipe		
			Hose - Lower - Pipe To Rad.		

Medium & Heavy-Duty Trucks (2001 & Newer)

♣Standard Belt Available.

♣<Cut to Fit.

Belts and Coolant Hose for Medium/Heavy-Duty Trucks (2001 & Newer)

Medium & Heavy-Duty Trucks
(2001 & Newer)

Application	Mfr. Part No.	Our No.	Application	Mfr. Part No.	Our No.
Kenworth - Continued			Kenworth - Continued		
2004 - Continued			2004 - Continued		
Caterpillar C10 Diesel - Continued			Caterpillar C13 Diesel - Continued		
W900 - Continued			W900 - Continued		
Hose - Lower - Pipe To Rad.		24240	Tensioner Pulley - Fan, Alt. & A.C.	2117895	36164
Caterpillar C11 Diesel			Idler Pulley - Smooth	2078118	36269
T800			Idler Pulley - Grooved	1979642	36341
Belt - Fan, Alt. & A.C.; W/Conventional			Hose - Upper - Eng. To Pipe		24240
Hood	D8410001082420	♣K080952HD	Hose - Upper - Pipe To Rad.		24240
Belt - Fan, Alt. & A.C.; W/Short Hood	D8410003082730	♣K081074HD	Hose - Lower - Eng. To Rad.		24240
Tensioner Assy. - Fan, Alt. & A.C.	2117895	38590	Hose - Lower - Rad. To Pipe		24248
Tensioner Pulley - Fan, Alt. & A.C.	2117895	36164	Caterpillar C15 Diesel		
Idler Pulley - Smooth	2078118	36269	T600		
Idler Pulley - Grooved	1979642	36341	Belt - Fan & Alt.; W/Clean Air Pkg.; W/84		
Hose - Upper - Eng. To Pipe		24240	7/8" Belt O.C.	D8410001082135	♣K080842HD
Hose - Upper - Pipe To Rad.; W/Conventional Hood		24240	Belt - Fan & Alt.; W/Clean Air Pkg.; W/89		
Hose - Lower - Eng. To Pipe; W/Conventional Hood		24240	7/8" Belt O.C.	D11084906	♣K080893HD
Hose - Lower - Eng. To Pipe; W/Short Hood		21891	Belt - Fan To A.C.; W/Clean Air Pkg.	D8410003061450	♣K060569HD
Hose - Lower - Pipe To Pipe; W/Short Hood		24240	Belt - Fan & W.P.; W/O Clean Air Pkg.; Preferred Belt		2/TR22553PB
Hose - Lower - Pipe To Rad.		24248	Belt - Fan & W.P.; W/O Clean Air Pkg.; Optional Belt		②TR22553
Caterpillar C12 Diesel			Belt - Fan, Alt. & A.C.; W/O Clean Air Pkg.		②♣9620HD
T600			Tensioner Assy. - Fan & Alt.; W/Clean Air		
Belt - Fan, Alt. & Hub	D11080001	♣K080825HD	Pkg.; W/84" Belt O.C.	1900643	38620
Belt - Fan To A.C.		♣9510HD	Tensioner Assy. - Fan & Alt.; W/Clean Air		
Tensioner Assy. - Fan, Alt. & Hub	1481974	38506	Pkg.; W/89" Belt O.C.	1900649	38506
Idler Pulley - Fan & Alt.; W/Flat Idler Pulley .	1337023	36091	Tensioner Assy. - Fan To A.C.; W/Clean		
Idler Pulley - Fan & Alt.; W/Multi-Grooved			Air Pkg.	1900642	38508
Idler Pulley	1731498	36231	Idler Pulley - Smooth	1979641	36091
Tensioner Pulley - Fan, Alt. & Hub	1481974	36091	Idler Pulley - Grooved	1979642	36341
Hose - Upper - Eng. To Pipe		24240	Tensioner Pulley - Fan To A.C.; W/Clean		
Hose - Upper - Pipe To Rad.		24240	Air Pkg.	1900642	36091
Hose - Lower - Eng. To Pipe		24240	Hose - Upper - Eng. To Pipe		24240
Hose - Lower - Pipe To Rad.		24248	Hose - Upper - Pipe To Rad.		24240
T800			Hose - Lower - Eng. To Pipe		24248
Belt - Fan, Alt. & Hub	D8410001082060	♣K080810HD	Hose - Lower - Pipe To Rad.		24248
Belt - Fan & A.C.	D11023637	♣9500HD	T800		
Tensioner Assy. - Fan, Alt. & Hub	1900649	38506	Belt - Fan & Alt.; W/Clean Air Pkg.; W/84		
Idler Pulley - Fan & Alt.; W/Flat Idler Pulley .	1337023	36091	7/8" Belt O.C.	D8410001082135	♣K080842HD
Idler Pulley - Fan & Alt.; W/Multi-Grooved			Belt - Fan & Alt.; W/Clean Air Pkg.; W/89		
Idler Pulley	1731498	36231	7/8" Belt O.C.	D11084906	♣K080893HD
Tensioner Pulley - Fan, Alt. & Hub	1900649	36091	Belt - Fan & W.P.; W/O Clean Air Pkg.		②TR22545
Hose - Upper - Eng. To Pipe		24240	Belt - Fan To A.C.; W/Clean Air Pkg.	D11085634	♣K060569HD
Hose - Upper - Pipe To Rad.		24240	Belt - Fan, Alt. & A.C.; W/O Clean Air Pkg.		②♣9620HD
Hose - Lower - Eng. To Pipe		24240	Tensioner Assy. - Fan & Alt.; W/Clean Air		
Hose - Lower - Pipe To Rad.		24248	Pkg.; W/84" Belt O.C.	1900643	38620
W900			Tensioner Assy. - Fan & Alt.; W/Clean Air		
Idler Pulley - Fan & Alt.; W/Flat Idler Pulley .	1337023	36091	Pkg.; W/89" Belt O.C.	1900649	38506
Idler Pulley - Fan & Alt.; W/Multi-Grooved			Tensioner Assy. - Fan To A.C.; W/Clean		
Idler Pulley	1731498	36231	Air Pkg.	1900642	38508
Caterpillar C13 Diesel			Idler Pulley - Smooth	1979641	36091
T800			Idler Pulley - Grooved	1979642	36341
Belt - Fan, Alt. & A.C.; W/Conventional			Tensioner Pulley - Fan & Alt.; W/Clean Air		
Hood	D8410001082420	♣K080952HD	Pkg.	1900649	36091
Belt - Fan, Alt. & A.C.; W/Short Hood	D8410003082730	♣K081074HD	Tensioner Pulley - Fan To A.C.; W/Clean		
Tensioner Assy. - Fan, Alt. & A.C.	2117895	38590	Air Pkg.	1900642	36091
Tensioner Pulley - Fan, Alt. & A.C.	2117895	36164	Hose - Upper - Eng. To Pipe		24240
Idler Pulley - Smooth	2078118	36269	Hose - Upper - Pipe To Rad.		24240
Idler Pulley - Grooved	1979642	36341	Hose - Lower - Eng. To Pipe		24248
Hose - Upper - Eng. To Pipe		24240	Hose - Lower - Pipe To Rad.; W/Clean Air Pkg.		24240
Hose - Upper - Pipe To Rad.; W/Conventional Hood		24240	Hose - Lower - Pipe To Rad.; W/O Clean Air Pkg.		24248
Hose - Lower - Eng. To Pipe; W/Conventional Hood		24240	T2000		
Hose - Lower - Eng. To Pipe; W/Short Hood		21891	Belt - Fan & Alt.; W/Clean Air Pkg.	D11084936	♣K080939HD
Hose - Lower - Pipe To Pipe; W/Short Hood		24240	Belt - Fan; W/O Clean Air Pkg.; Preferred Belt		2/TR22570PB
Hose - Lower - Pipe To Rad.		24248	Belt - Fan; W/O Clean Air Pkg.; Optional Belt		②TR22570
W900			Belt - Fan To A.C.; W/Clean Air Pkg.	D11085527	♣K060637HD
Belt - Fan, Alt. & A.C.		♣K080968HD	Belt - Fan To Alt. & A.C.; W/O Clean Air Pkg.		②♣9650HD
Tensioner Assy. - Fan, Alt. & A.C.	2117895	38590	Tensioner Assy. - Fan & Alt.	2002279	38569
			Tensioner Assy. - Fan To A.C.	2178938	38511
			Idler Pulley - Smooth	1979641	36091
			Idler Pulley - Grooved	1979642	36341

♣Standard Belt Available.

②Two Required.

Belts and Coolant Hose for Medium/Heavy-Duty Trucks (2001 & Newer)

Application	Mfr. Part No.	Our No.	Application	Mfr. Part No.	Our No.
Kenworth - Continued			Kenworth - Continued		
2004 - Continued			2004 - Continued		
Caterpillar C15 Diesel - Continued			Cummins ISM Diesel - Continued		
T2000 - Continued			W900		
Tensioner Pulley - Fan To A.C.	2178938	36091	Belt - Fan & Alt.	D11084891	▲K080702HD
Hose - Upper - Eng. To Pipe		24240	Belt - Hub & A.C.	4004824	▲K060539HD
Hose - Upper - Pipe To Rad.; W/O Clean Air Pkg.		24240	Tensioner Assy. - Fan & Alt.	3400885	38521
Hose - Lower - Eng. To Pipe		24248	Tensioner Assy. - Hub & A.C.	3102888	38505
Hose - Lower - Pipe To Rad.; W/Clean Air Pkg.		24240	Idler Pulley - A.C.	3104139	36225
Hose - Lower - Pipe To Rad.; W/O Clean Air Pkg.		24248	Idler Pulley - Fan & Alt.	3400884	36308
W900			Tensioner Pulley - A.C.	3102888	36091
Belt - Fan & Alt.; W/Clean Air Pkg.	D11084884	▲K080952HD	Hose - Upper - Eng. To Pipe		24240
Belt - Fan & Alt.; W/O Clean Air Pkg.		②TR22648	Hose - Upper - Rad. To Pipe		24240
Belt - Fan To A.C.; W/Clean Air Pkg.	D11085352	▲K060615HD	Hose - Lower - Eng. To Pipe		24240
Belt - Fan To A.C.; W/O Clean Air Pkg.		②▲9520HD	Hose - Lower - Rad. To Pipe		24248
Tensioner Assy. - Fan & Alt.	2002279	38569	Cummins ISX Diesel		
Tensioner Assy. - Fan To A.C.	2178938	38511	T600		
Idler Pulley - Smooth	1979641	36091	Belt - Fan & Alt.	D8410001122195	▲K120864HD
Idler Pulley - Grooved	1979642	36341	Belt - Hub, Alt. & A.C.	D8410003061620	▲K060637HD
Tensioner Pulley - Fan To A.C.	2178938	36091	Tensioner Assy. - Hub & A.C.	3682683	38610
Hose - Upper - Eng. To Pipe		24240	Tensioner Assy. - Fan & Alt.	3682946	38587
Hose - Upper - Pipe To Rad.		24240	Idler Pulley - A.C.	3682229	36223
Hose - Lower - Eng. To Pipe		24248	Tensioner Pulley - Fan & Alt.	3682946	36165
Hose - Lower - Pipe To Rad.		24248	Hose - Upper - Eng. To Pipe		24240
Cummins ISC Diesel			Hose - Upper - Pipe To Rad.		24240
T300			Hose - Lower - Eng. To Pipe		24240
Belt - Fan, Alt. & Hub	3944837	▲K080745HD	Hose - Lower - Pipe To Rad.		24248
Belt - Fan To A.C.		7420	T800		
Tensioner Assy. - Fan, Alt. & Hub	3936213	38516	Belt - Fan, Alt. & W.P.; W/Conventional		
Tensioner Pulley - Fan, Alt. & Hub	3936213	36093	Hood	D8410001122195	▲K120864HD
Hose - Upper - Eng. To Pipe		24236	Belt - Fan, Alt. & W.P.; W/Wide Hood	D8410003122400	K120945HD
Hose - Upper - Pipe To Rad.		≠21115	Belt - A.C. - From W.P.	D8410003061620	▲K060637HD
W900			Tensioner Assy. - Hub & A.C.	3682683	38610
Belt - Fan & Alt.	3289404	▲K080716HD	Tensioner Assy. - Fan & Alt.	3682946	38587
Belt - A.C.		▲9463HD	Idler Pulley - A.C.	3682229	36223
Tensioner Assy. - Fan & Alt.	3936213	38516	Tensioner Pulley - Fan & Alt.	3682946	36165
Tensioner Pulley - Fan & Alt.	3936213	36093	Hose - Upper - Eng. To Pipe		24240
Cummins ISL Diesel			Hose - Upper - Pipe To Rad.		24240
T800			Hose - Lower - Eng. To Pipe		24240
Belt - Fan, W.P. & Alt.	3289369	▲K080716HD	Hose - Lower - Pipe To Rad.		24248
Belt - Fan To A.C.	D11023525	▲9463HD	T2000		
Tensioner Assy. - Fan, W.P. & Alt.	3936213	38516	Belt - Fan, Alt. & Hub	D8410001122195	▲K120864HD
Tensioner Pulley - Fan, W.P. & Alt.	3936213	36093	Belt - Hub & A.C.	D8410003061620	▲K060637HD
Hose - Upper - Eng. To Pipe		24236	Tensioner Assy. - Hub & A.C.	3682683	38610
Hose - Upper - Pipe To Rad.		24236	Tensioner Assy. - Fan & Alt.	3682946	38587
Hose - Lower - Eng. To Pipe		24232	Idler Pulley - A.C.	3682229	36223
Hose - Lower - Pipe To Cooler		24236	Tensioner Pulley - Fan & Alt.	3682946	36165
Hose - Lower - Cooler To Pipe		24240	Hose - Upper - Eng. To Pipe		24240
Hose - Lower - Pipe To Rad.		24052	Hose - Upper - Pipe To Rad.		26531
Cummins ISM Diesel			Hose - Lower - Eng. To Pipe		21591
T600			Hose - Lower - Pipe To Rad.		24240
Belt - Alt.	D8410001081780	▲K080702HD	W900		
Belt - A.C.	4004824	▲K060539HD	Belt - Fan & Alt.	D8410001122230	▲K120878HD
Tensioner Assy. - Alt.	3400885	38521	Belt - Hub, Alt. & A.C.	D8410003061620	▲K060637HD
Tensioner Assy. - A.C.	3102888	38505	Tensioner Assy. - Hub & A.C.	3682683	38610
Idler Pulley - Alt.	3400883	36308	Tensioner Assy. - Fan & Alt.	3682946	38587
T800			Idler Pulley - A.C.	3682229	36223
Belt - Fan & Alt.	D8410001081780	▲K080702HD	Tensioner Pulley - Fan & Alt.	3682946	36165
Belt - Hub & A.C.	4004824	▲K060539HD	Hose - Upper - Eng. To Pipe		24240
Tensioner Assy. - Fan & Alt.	3400885	38521	Hose - Upper - Pipe To Rad.; W/O E.G.R.		24240
Tensioner Assy. - Hub & A.C.	4004933	38505	Hose - Lower - Eng. To Pipe		24240
Idler Pulley - Fan & Alt.	3400884	36308	Hose - Lower - Pipe To Rad.		24240
Tensioner Pulley - A.C.	4004933	36091	2003		
Hose - Upper - Eng. To Pipe		24240	Caterpillar 3126 Diesel		
Hose - Upper - Pipe To Rad.		24240	T300		
Hose - Lower - Eng. To Pipe		24240	Belt - Fan, Alt. & A.C.	4080767	▲K080774HD
Hose - Lower - Pipe To Rad.		24248	Belt - W.P.	0366775	▲9341HD

▲Standard Belt Available.
≠Cut to Fit.

②Two Required.

Medium & Heavy-Duty Trucks
(2001 & Newer)

Belts and Coolant Hose for Medium/Heavy-Duty Trucks (2001 & Newer)

Medium & Heavy-Duty Trucks
(2001 & Newer)

Application	Mfr. Part No.	Our No.	Application	Mfr. Part No.	Our No.
Kenworth - Continued			Kenworth - Continued		
2003 - Continued			2003 - Continued		
Caterpillar 3126 Diesel - Continued			Caterpillar C12 Diesel - Continued		
T300 - Continued			T600 - Continued		
Tensioner Assy. - Fan, Alt. & A.C.	1352151	38511	Tensioner Assy. - Fan, Alt. & Hub	1481974	38506
Tensioner Pulley - Fan, Alt. & A.C.	1352151	36091	Idler Pulley - Fan & Alt.; W/Flat Idler Pulley .	1337023	36091
Hose - Upper - Eng. To Pipe		21891	Idler Pulley - Fan & Alt.; W/Multi-Grooved		
Hose - Upper - Pipe To Rad.		21115	Idler Pulley	1731498	36231
Hose - Lower - Eng. To Pipe		24232	Tensioner Pulley - Fan, Alt. & Hub	1481974	36091
Hose - Lower - Pipe To Pipe		24240	Hose - Upper - Eng. To Pipe		24240
Hose - Lower - Pipe To Rad.		22707	Hose - Upper - Pipe To Rad.		24240
Caterpillar C10 Diesel			Hose - Lower - Eng. To Pipe		
T600			Hose - Lower - Pipe To Rad.		
Belt - Fan, Alt. & Hub	D11080001	♣K080825HD	T800		
Belt - Fan To A.C.		♣9510HD	Belt - Fan, Alt. & Hub; W/Clean Air Pkg.	D8410001082060	♣K080810HD
Tensioner Assy. - Fan, Alt. & Hub	1481974	38506	Belt - Fan, Alt. & Hub; W/O Clean Air Pkg. .	D11080005	♣K080797HD
Idler Pulley - Fan & Alt.; W/Flat Idler Pulley .	1337023	36091	Belt - Fan & A.C.; W/Clean Air Pkg.	D11023637	♣9500HD
Idler Pulley - Fan & Alt.; W/Multi-Grooved			Belt - Fan & A.C.; W/O Clean Air Pkg.		♣9555HD
Idler Pulley	1731498	36231	Tensioner Assy. - Fan, Alt. & Hub	1900649	38506
Tensioner Pulley - Fan, Alt. & Hub	1481974	36091	Idler Pulley - Fan & Alt.; W/Flat Idler Pulley .	1337023	36091
Hose - Upper - Eng. To Pipe		24240	Idler Pulley - Fan & Alt.; W/Multi-Grooved		
Hose - Upper - Pipe To Rad.		24240	Idler Pulley	1731498	36231
Hose - Lower - Eng. To Pipe		24240	Tensioner Pulley - Fan & Alt.	1900649	36091
Hose - Lower - Pipe To Rad.		24248	Hose - Upper - Eng. To Pipe		24240
T800			Hose - Upper - Pipe To Rad.		
Belt - Fan, Alt. & Hub; W/Clean Air Pkg.	D8410001082060	♣K080810HD	Hose - Lower - Eng. To Pipe		
Belt - Fan, Alt. & Hub; W/O Clean Air Pkg. .	D11080005	♣K080797HD	Hose - Lower - Pipe To Rad.		
Belt - Fan & A.C.; W/Clean Air Pkg.	D11023637	♣9500HD	W900		
Belt - Fan & A.C.; W/O Clean Air Pkg.		♣9555HD	Belt - Fan & Alt.		♣K080810HD
Tensioner Assy. - Fan, Alt. & Hub	1900649	38506	Belt - Fan To A.C.		♣9540HD
Idler Pulley - Fan & Alt.; W/Flat Idler Pulley .	1337023	36091	Idler Pulley - Fan & Alt.; W/Flat Idler Pulley .	1337023	36091
Idler Pulley - Fan & Alt.; W/Multi-Grooved			Idler Pulley - Fan & Alt.; W/Multi-Grooved		
Idler Pulley	1731498	36231	Idler Pulley	1731498	36231
Tensioner Pulley - Fan & Alt.	1900649	36091	Hose - Upper - Eng. To Pipe		24240
Hose - Upper - Eng. To Pipe		24240	Hose - Upper - Pipe To Rad.		24240
Hose - Upper - Pipe To Rad.		24240	Hose - Lower - Eng. To Pipe		24240
Hose - Lower - Eng. To Pipe		24240	Hose - Lower - Pipe To Rad.		24248
W900			Caterpillar C15 Diesel		
Belt - Fan & Alt.		♣K080810HD	C500		
Belt - Fan To A.C.		♣9540HD	Belt - Fan		②TR22635
Idler Pulley - Fan & Alt.; W/Flat Idler Pulley .	1337023	36091	Belt - Fan, Alt. & A.C.		②♣9520HD
Idler Pulley - Fan & Alt.; W/Multi-Grooved			Hose - Upper - Eng. To Pipe		24232
Idler Pulley	1731498	36231	Hose - Upper - Pipe To Rad.		24240
Hose - Upper - Eng. To Pipe		24240	Hose - Lower - Eng. To Pipe		24248
Hose - Upper - Pipe To Rad.		24240	Hose - Lower - Pipe To Rad.		24240
Hose - Lower - Eng. To Pipe		24240	T600		
Hose - Lower - Pipe To Rad.		24248	Belt - Fan & Alt.; W/Clean Air Pkg.; W/84		
W900			7/8" Belt O.C.	D8410001082135	♣K080842HD
Belt - Fan & Alt.		♣K080810HD	Belt - Fan & Alt.; W/Clean Air Pkg.; W/89		
Belt - Fan To A.C.		♣9540HD	7/8" Belt O.C.	D11084906	♣K080893HD
Idler Pulley - Fan & Alt.; W/Flat Idler Pulley .	1337023	36091	Belt - Fan To A.C.; W/Clean Air Pkg.	D8410003061450	♣K060569HD
Idler Pulley - Fan & Alt.; W/Multi-Grooved			Belt - Fan & W.P.; W/O Clean Air Pkg.; Preferred Belt		2/TR22553PB
Idler Pulley	1731498	36231	Belt - Fan & W.P.; W/O Clean Air Pkg.; Optional Belt		②TR22553
Hose - Upper - Eng. To Pipe		24240	Belt - Fan, Alt. & A.C.; W/O Clean Air Pkg. .	17621	②♣9620HD
Hose - Upper - Pipe To Rad.		24240	Tensioner Assy. - Fan & Alt.; W/Clean Air		
Hose - Lower - Eng. To Pipe		24240	Pkg.; W/84" Belt O.C.	1900643	38620
Hose - Lower - Pipe To Rad.		24240	Tensioner Assy. - Fan & Alt.; W/Clean Air		
Caterpillar C11 Diesel			Pkg.; W/89" Belt O.C.	1900649	38506
T800			Tensioner Assy. - Fan To A.C.; W/Clean		
Belt - Fan, Alt. & A.C.; W/Conventional			Air Pkg.	1900642	38508
Hood	D8410001082420	♣K080952HD	Idler Pulley - Smooth	1979641	36091
Belt - Fan, Alt. & A.C.; W/Short Hood	D8410003082730	♣K081074HD	Idler Pulley - Grooved	1979642	36341
Tensioner Assy. - Fan, Alt. & A.C.	2117895	38590	Tensioner Pulley - Fan To A.C.; W/Clean		
Tensioner Pulley - Fan, Alt. & A.C.	2117895	36164	Air Pkg.	1900642	36091
Idler Pulley - Smooth	2078118	36269	Hose - Upper - Eng. To Pipe		24240
Idler Pulley - Grooved	1979642	36341	Hose - Upper - Pipe To Rad.		24240
Hose - Upper - Eng. To Pipe		24240	Hose - Lower - Eng. To Pipe		24248
Hose - Upper - Pipe To Rad.		24240	Hose - Lower - Pipe To Rad.		24248
Hose - Lower - Eng. To Pipe; W/Conventional Hood		24240	T800		
Hose - Lower - Eng. To Pipe; W/Short Hood		21891	Belt - Fan & W.P.		②TR22545
Hose - Lower - Pipe To Pipe; W/Short Hood		24240	Belt - Fan, Alt. & A.C.		②♣9620HD
Hose - Lower - Pipe To Rad.		24248	Hose - Upper - Eng. To Pipe		24240
Caterpillar C12 Diesel			Hose - Upper - Pipe To Rad.		24240
T600			Hose - Lower - Eng. To Pipe		24248
Belt - Fan, Alt. & Hub	D11080001	♣K080825HD	Hose - Lower - Pipe To Rad.		24248
Belt - Fan To A.C.		♣9510HD	Caterpillar C15 Diesel		

♣Standard Belt Available.

②Two Required.

Belts and Coolant Hose for Medium/Heavy-Duty Trucks (2001 & Newer)

Application	Mfr. Part No.	Our No.	Application	Mfr. Part No.	Our No.
Kenworth - Continued			Kenworth - Continued		
2003 - Continued			2003 - Continued		
Caterpillar C15 Diesel - Continued			Cummins ISL Diesel - Continued		
T2000			T800 - Continued		
Belt - Fan; Preferred Belt		2/TR22570PB	Hose - Lower - Pipe To Rad.		24052
Belt - Fan; Optional Belt		②TR22570	Cummins ISM Diesel		
Belt - Fan To Alt. & A.C.		②♣9650HD	T800		
Hose - Upper - Eng. To Pipe		24240	Belt - Fan & Alt.	D8410001081810	♣K080716HD
Hose - Upper - Pipe To Rad.		24240	Belt - Hub & A.C.	4004824	♣K060539HD
Hose - Lower - Eng. To Pipe		24248	Tensioner Assy. - Fan & Alt.	3400885	38521
Hose - Lower - Pipe To Rad.		24248	Tensioner Assy. - Hub & A.C.	4004933	38505
W900			Idler Pulley - Fan & Alt.	3400884	36308
Belt - Fan; Preferred Belt		2/TR22570PB	Tensioner Pulley - A.C.	4004933	36091
Belt - Fan; Optional Belt		②TR22570	Hose - Upper - Eng. To Pipe		24236
Belt - Fan, Alt. & A.C.	17611	②♣9610HD	Hose - Lower - Eng. To Pipe		24240
Hose - Upper - Eng. To Pipe		24240	Hose - Lower - Pipe To Pipe		24240
Hose - Upper - Pipe To Rad.		24240	Hose - Lower - Pipe To Rad.		24240
Hose - Lower - Eng. To Pipe		24248	W900		
Hose - Lower - Pipe To Rad.		24248	Belt - Fan & Alt.	D11084891	♣K080702HD
Caterpillar C16 Diesel			Belt - Hub & A.C.	4004824	♣K060539HD
T800			Tensioner Assy. - Fan & Alt.	3400885	38521
Belt - Fan & W.P.		②TR22545	Tensioner Assy. - Hub & A.C.	3102888	38505
Belt - Fan, Alt. & A.C.		②♣9620HD	Idler Pulley - A.C.	3104139	36225
Hose - Upper - Eng. To Pipe		24240	Idler Pulley - Fan & Alt.	3400884	36308
Hose - Upper - Pipe To Rad.		24240	Tensioner Pulley - A.C.	3102888	36091
Hose - Lower - Eng. To Pipe		24248	Hose - Upper - Eng. To Pipe		24240
Hose - Lower - Pipe To Rad.		24248	Hose - Upper - Rad. To Pipe		24240
T2000			Hose - Lower - Eng. To Pipe		24240
Belt - Fan; Preferred Belt		2/TR22570PB	Hose - Lower - Rad. To Pipe		24248
Belt - Fan; Optional Belt		②TR22570	Cummins ISX Diesel		
Belt - Fan To Alt. & A.C.		②♣9650HD	T600		
Hose - Upper - Eng. To Pipe		24240	Belt - Fan	3681817	♣K100658HD
Hose - Upper - Pipe To Rad.		24240	Belt - Hub, Alt. & A.C.	3681812	♣K060685HD
Hose - Lower - Eng. To Pipe		24248	Tensioner Assy. - Fan	3681240	38535
Hose - Lower - Pipe To Rad.		24248	Tensioner Assy. - Hub, Alt. & A.C.	3680194	38532
W900			Idler Pulley - Alt. & A.C.	4026886	36226
Belt - Fan; Preferred Belt		2/TR22570PB	Tensioner Pulley - Fan	3681240	36092
Belt - Fan; Optional Belt		②TR22570	Tensioner Pulley - Hub, Alt. & A.C.	3680194	36095
Belt - Fan, Alt. & A.C.	17611	②♣9610HD	Hose - Upper - Eng. To Pipe		24240
Hose - Upper - Eng. To Pipe		24240	Hose - Upper - Pipe To Rad.		24240
Hose - Upper - Pipe To Rad.		24240	Hose - Lower - Eng. To Pipe		24240
Hose - Lower - Eng. To Pipe		24248	Hose - Lower - Pipe To Rad.		24248
Hose - Lower - Pipe To Rad.		24248	T800		
Cummins ISC Diesel			Belt - Fan	3681816	♣K100739HD
T300			Belt - Hub, Alt. & A.C.	3681812	♣K060685HD
Belt - Fan, Alt. & Hub	3944837	♣K080745HD	Tensioner Assy. - Fan	3681240	38535
Belt - Fan To A.C.		7420	Tensioner Assy. - Hub, Alt. & A.C.	3680194	38532
Tensioner Assy. - Fan, Alt. & Hub	3936213	38516	Idler Pulley - Alt. & A.C.	4026886	36226
Tensioner Pulley - Fan, Alt. & Hub	3936213	36093	Tensioner Pulley - Fan	3681240	36092
Hose - Upper - Eng. To Pipe		24236	Tensioner Pulley - Hub, Alt. & A.C.	3680194	36095
Hose - Upper - Pipe To Rad.		♣<21115	Hose - Upper - Eng. To Rad.		24240
W900			Hose - Upper - Rad. To Pipe		26531
Belt - Fan & Alt.	3289404	♣K080716HD	Hose - Lower - Eng. To Pipe		24240
Belt - A.C.		♣9463HD	Hose - Lower - Pipe To Rad.		24240
Tensioner Assy. - Fan & Alt.	3936213	38516	T2000		
Tensioner Pulley - Fan & Alt.	3936213	36093	Belt - Fan	3681821	♣K100675HD
Cummins ISL Diesel			Belt - W.P., Alt. & A.C.	3681812	♣K060685HD
T800			Tensioner Assy. - Fan	3681240	38535
Belt - Fan, W.P. & Alt.	3289369	♣K080716HD	Tensioner Assy. - Hub, Alt. & A.C.	3680194	38532
Belt - Fan To A.C.	D11023525	♣9463HD	Idler Pulley - Alt. & A.C.	4026886	36226
Tensioner Assy. - Fan, W.P. & Alt.	3936213	38516	Tensioner Pulley - Fan	3681240	36092
Tensioner Pulley - Fan, W.P. & Alt.	3936213	36093	Tensioner Pulley - Hub, Alt. & A.C.	3680194	36095
Hose - Upper - Eng. To Pipe		24236	Hose - Upper - Eng. To Pipe		24240
Hose - Upper - Pipe To Rad.		24236	Hose - Upper - Pipe To Rad.		26532
Hose - Lower - Eng. To Pipe		24232	Hose - Lower - Eng. To Pipe		24240
Hose - Lower - Pipe To Cooler		24236	Hose - Lower - Pipe To Rad.		24240
Hose - Lower - Cooler To Pipe		24240	W900		
			Belt - Fan; W/O Clean Air Pkg.	3681823	♣K100670HD

②Two Required.
♣Cut to Fit.

♣Standard Belt Available.

Medium & Heavy-Duty Trucks
(2001 & Newer)

Belts and Coolant Hose for Medium/Heavy-Duty Trucks (2001 & Newer)

Medium & Heavy-Duty Trucks
(2001 & Newer)

Application	Mfr. Part No.	Our No.	Application	Mfr. Part No.	Our No.
Kenworth - Continued			Kenworth - Continued		
2003 - Continued			2002		
Cummins ISX Diesel - Continued			Caterpillar 3126 Diesel		
W900 - Continued			T300		
Belt - Fan & Alt.; W/81 1/4" Belt O.C.	3681822	♣K100810HD	Belt - Fan, Alt. & A.C.	4080767	♣K080774HD
Belt - Fan & Alt.; W/Clean Air Pkg.	D8410001122365	♣K120931HD	Belt - W.P.	0366775	♣9341HD
Belt - Hub, Alt. & A.C.; W/Clean Air Pkg.		♣K060637HD	Tensioner Assy. - Fan, Alt. & A.C.	1352151	38511
Belt - Hub, Alt. & A.C.; W/O Clean Air Pkg. .	3681812	♣K060685HD	Tensioner Pulley - Fan, Alt. & A.C.	1352151	36091
Tensioner Assy. - Fan; W/O Clean Air Pkg. .	3681240	38535	Hose - Upper - Eng. To Pipe; W/2 1/2" I.D. Hose		21891
Tensioner Assy. - Fan & Alt.; W/Clean Air Pkg.	3682946	38587	Hose - Upper - Pipe To Rad.		21115
Tensioner Assy. - Hub, Alt. & A.C.; W/Clean Air Pkg.	3682683	38610	Hose - Lower - Eng. To Pipe		24232
Tensioner Assy. - Hub, Alt. & A.C.; W/O Clean Air Pkg.	3680194	38532	Hose - Lower - Pipe To Pipe		24240
Idler Pulley - Alt. & A.C.	4026886	36226	Hose - Lower - Pipe To Rad.		22707
Idler Pulley - A.C.; W/Clean Air Pkg.	3682229	36223	Caterpillar C10 Diesel		
Tensioner Pulley - Fan; W/O Clean Air Pkg.	3681240	36092	T600		
Tensioner Pulley - Fan & Alt.; W/Clean Air Pkg.	3682946	36165	Belt - Fan, Alt. & Hub	D11080001	♣K080825HD
Tensioner Pulley - Hub, Alt. & A.C.; W/O Clean Air Pkg.	3680194	36095	Belt - Fan To A.C.		♣9510HD
Hose - Upper - Eng. To Pipe	24240	24240	Tensioner Assy. - Fan, Alt. & Hub	1481974	38506
Hose - Upper - Pipe To Rad.; W/O E.G.R.	24240	24240	Idler Pulley - Fan & Alt.; W/Flat Idler Pulley .	1337023	36091
Hose - Lower - Eng. To Pipe	24240	24240	Idler Pulley - Fan & Alt.; W/Multi-Grooved Idler Pulley	1731498	36231
Hose - Lower - Pipe To Rad.	24240	24240	Tensioner Pulley - Fan, Alt. & Hub	1481974	36091
Cummins N14 Diesel			T800		
K100			Belt - Fan, Alt. & Hub; W/Conventional Hood	D11080033	♣K080825HD
Belt - W.P.; W/6-Ribbed Belt	217638	♣K060435HD	Belt - Fan, Alt. & Hub; W/Short Hood		♣K080806HD
T800			Belt - Fan & A.C.		♣9555HD
Belt - Hub & W.P.		♣K060425HD	Tensioner Assy. - Fan, Alt. & Hub	1481974	38506
Belt - Hub To Fan	D11025738	TR28463	Idler Pulley - Fan & Alt.; W/Flat Idler Pulley .	1337023	36091
Belt - Alt.	D11023497	♣9451HD	Idler Pulley - Fan & Alt.; W/Multi-Grooved Idler Pulley	1731498	36231
Belt - Hub & A.C.	17425	♣9425HD	Tensioner Pulley - Fan, Alt. & Hub	1481974	36091
Hose - Upper - Eng. To Pipe		24240	Hose - Upper - Eng. To Pipe		24248
Hose - Upper - Pipe To Rad.		24240	Hose - Upper - Pipe To Rad.		24240
Hose - Lower - Eng. To Pipe		24240	Hose - Lower - Eng. To Pipe		24240
Hose - Lower - Pipe To Rad.		24240	Hose - Lower - Pipe To Rad.		24240
Hose - Lower - Pipe To Pipe		24240	W900		
W900			Belt - Fan & Alt.		♣K080810HD
Belt - Hub & W.P.	3076492	♣K060425HD	Belt - Fan To A.C.		♣9540HD
Belt - Hub & Fan	D11025780	TR28473	Idler Pulley - Fan & Alt.; W/Flat Idler Pulley .	1337023	36091
Belt - Alt.		♣9451HD	Idler Pulley - Fan & Alt.; W/Multi-Grooved Idler Pulley	1731498	36231
Belt - Hub & A.C.	17425	♣9425HD	Hose - Upper - Eng. To Pipe		24240
Hose - Upper - Eng. To Pipe		24240	Hose - Upper - Pipe To Rad.		24240
Hose - Upper - Pipe To Rad.		24240	Hose - Lower - Eng. To Pipe		24240
Hose - Lower - Eng. To Pipe		24240	Hose - Lower - Pipe To Rad.		24240
Hose - Lower - Pipe To Rad.		24240	Caterpillar C12 Diesel		
Cummins Signature 600 Diesel			T600		
T600			Belt - Fan, Alt. & Hub	D11080001	♣K080825HD
Belt - Fan	3681817	♣K100658HD	Belt - Fan To A.C.		♣9510HD
Belt - Hub, Alt. & A.C.	3681812	♣K060685HD	Tensioner Assy. - Fan, Alt. & Hub	1481974	38506
Tensioner Assy. - Fan	3681240	38535	Idler Pulley - Fan & Alt.; W/Flat Idler Pulley .	1337023	36091
Tensioner Assy. - Hub, Alt. & A.C.	3680194	38532	Idler Pulley - Fan & Alt.; W/Multi-Grooved Idler Pulley	1731498	36231
Idler Pulley - Alt. & A.C.	4026886	36226	Tensioner Pulley - Fan, Alt. & Hub	1481974	36091
Tensioner Pulley - Fan	3681240	36092	Hose - Upper - Eng. To Pipe		24240
Tensioner Pulley - Hub, Alt. & A.C.	3680194	36095	Hose - Upper - Pipe To Rad.		24240
Hose - Upper - Eng. To Pipe		24240	Hose - Lower - Eng. To Pipe		24240
Hose - Upper - Pipe To Rad.		24240	Hose - Lower - Pipe To Rad.		24240
Hose - Lower - Eng. To Pipe		24240	T800		
Hose - Lower - Pipe To Rad.		24248	Belt - Fan, Alt. & Hub; W/Conventional Hood	D11080033	♣K080825HD
W900			Belt - Fan, Alt. & Hub; W/Short Hood		♣K080806HD
Idler Pulley - Alt. & A.C.	4026886	36226	Belt - Fan & A.C.		♣9555HD

♣Standard Belt Available.

ⓂTwo Required.

Belts and Coolant Hose for Medium/Heavy-Duty Trucks (2001 & Newer)

Application	Mfr. Part No.	Our No.	Application	Mfr. Part No.	Our No.
Kenworth - Continued			Kenworth - Continued		
2002 - Continued			2002 - Continued		
Caterpillar C12 Diesel - Continued			Caterpillar C15 Diesel - Continued		
T800 - Continued			W900 - Continued		
Tensioner Assy. - Fan, Alt. & Hub	1481974	38506	Hose - Lower - Eng. To Pipe		24248
Idler Pulley - Fan & Alt.; W/Flat Idler Pulley .	1337023	36091	Hose - Lower - Pipe To Rad.		24248
Idler Pulley - Fan & Alt.; W/V-Groove Idler Pulley	1731498	36231	Caterpillar C16 Diesel		
Tensioner Pulley - Fan, Alt. & Hub	1481974	36091	T800		
Hose - Upper - Eng. To Pipe		24248	Belt - Fan & W.P.	2TR22545	
Hose - Upper - Pipe To Rad.		24240	Belt - Fan, Alt. & A.C.	2♣9620HD	
Hose - Lower - Eng. To Pipe		24240	Hose - Upper - Eng. To Pipe		24240
Hose - Lower - Pipe To Rad.		24240	Hose - Upper - Pipe To Rad.		24240
W900			Hose - Lower - Eng. To Pipe		24248
Idler Pulley - Fan & Alt.; W/Flat Idler Pulley .	1337023	36091	Hose - Lower - Pipe To Rad.		24248
Idler Pulley - Fan & Alt.; W/Multi-Grooved Idler Pulley	1731498	36231	T2000		
Caterpillar C15 Diesel			Belt - Fan; Preferred Belt		2/TR22570PB
C500			Belt - Fan; Optional Belt		2TR22570
Belt - Fan		2TR22635	Belt - Fan To Alt. & A.C.	2♣9650HD	
Belt - Fan, Alt. & A.C.		2♣9520HD	Hose - Upper - Eng. To Pipe		24240
Hose - Upper - Eng. To Pipe		24232	Hose - Upper - Pipe To Rad.	≧21115	
Hose - Upper - Pipe To Rad.		24240	Hose - Lower - Eng. To Pipe		24248
Hose - Lower - Eng. To Pipe		24248	Hose - Lower - Pipe To Rad.		24240
Hose - Lower - Pipe To Rad.		24240	W900		
T600			Belt - Fan; Preferred Belt		2/TR22570PB
Belt - Fan & Alt.; W/Clean Air Pkg.; W/84 7/8" Belt O.C.	D8410001082135	♣K080842HD	Belt - Fan; Optional Belt		2TR22570
Belt - Fan & Alt.; W/Clean Air Pkg.; W/89 7/8" Belt O.C.	D11084906	♣K080893HD	Belt - Fan, Alt. & A.C.	17611	2♣9610HD
Belt - Fan To A.C.; W/Clean Air Pkg.	D8410003061450	♣K060569HD	Hose - Upper - Eng. To Pipe		24240
Belt - Fan & W.P.; W/O Clean Air Pkg.; Preferred Belt		2/TR22553PB	Hose - Upper - Pipe To Rad.		24240
Belt - Fan & W.P.; W/O Clean Air Pkg.; Optional Belt		2TR22553	Hose - Lower - Eng. To Pipe		24248
Belt - Fan, Alt. & A.C.; W/O Clean Air Pkg.		2♣9620HD	Hose - Lower - Pipe To Rad.		24248
Tensioner Assy. - Fan & Alt.; W/Clean Air Pkg.; W/84" Belt O.C.	1900643	38620	Cummins ISC Diesel		
Tensioner Assy. - Fan & Alt.; W/Clean Air Pkg.; W/89" Belt O.C.	1900649	38506	T300		
Tensioner Assy. - Fan To A.C.; W/Clean Air Pkg.	1900642	38508	Belt - Fan, Alt. & Hub	3944837	♣K080745HD
Idler Pulley - Smooth	1979641	36091	Belt - Fan To A.C.		7420
Idler Pulley - Grooved	1979642	36093	Tensioner Assy. - Fan, Alt. & Hub	3936213	38516
Tensioner Pulley - Fan To A.C.; W/Clean Air Pkg.	1900642	36091	Tensioner Pulley - Fan, Alt. & Hub	3936213	36093
Hose - Upper - Eng. To Pipe		24240	Hose - Upper - Eng. To Pipe		24236
Hose - Upper - Pipe To Rad.		24240	Hose - Upper - Pipe To Rad.		≧21115
Hose - Lower - Eng. To Pipe		24248	Cummins ISL Diesel		
Hose - Lower - Pipe To Rad.		24248	T800		
T800			Belt - Fan, W.P. & Alt.	3289369	♣K080716HD
Belt - Fan & W.P.		2TR22545	Belt - Fan To A.C.	D11023525	♣9463HD
Belt - Fan, Alt. & A.C.		2♣9620HD	Tensioner Assy. - Fan, W.P. & Alt.	3936213	38516
Hose - Upper - Eng. To Pipe		24240	Tensioner Pulley - Fan, W.P. & Alt.	3936213	36093
Hose - Upper - Pipe To Rad.		24240	Hose - Upper - Eng. To Pipe		24236
Hose - Lower - Eng. To Pipe		24248	Hose - Upper - Pipe To Rad.		24236
Hose - Lower - Pipe To Rad.		24248	Hose - Lower - Eng. To Pipe		24232
T2000			Hose - Lower - Pipe To Cooler		24236
Belt - Fan; Preferred Belt		2/TR22570PB	Hose - Lower - Cooler To Pipe		24240
Belt - Fan; Optional Belt		2TR22570	Hose - Lower - Pipe To Rad.		24052
Belt - Fan To Alt. & A.C.		2♣9650HD	Cummins ISM Diesel		
Hose - Upper - Eng. To Pipe		24240	T600; T800		
Hose - Upper - Pipe To Rad.		≧21115	Belt - Fan & Alt.	3099256	♣K080708HD
Hose - Lower - Eng. To Pipe		24248	Belt - Hub & A.C.		♣9530HD
Hose - Lower - Pipe To Rad.		24240	Tensioner Assy. - Fan & Alt.	3400885	38521
W900			Idler Pulley - Fan & Alt.	3400884	36308
Belt - Fan; Preferred Belt		2/TR22570PB	Hose - Upper - Eng. To Pipe		24240
Belt - Fan; Optional Belt		2TR22570	Hose - Upper - Pipe To Rad.		24240
Belt - Fan, Alt. & A.C.	17611	2♣9610HD	Hose - Lower - Eng. To Pipe		24240
Hose - Upper - Eng. To Pipe		24240	Hose - Lower - Pipe To Rad.		24240
Hose - Upper - Pipe To Rad.		24240	W900		
W900			Belt - Fan & Alt.	3099256	♣K080708HD
Belt - Fan; Preferred Belt		2/TR22570PB	Belt - Hub & A.C.		♣9530HD
Belt - Fan; Optional Belt		2TR22570	Tensioner Assy. - Fan & Alt.	3400885	38521
Belt - Fan, Alt. & A.C.	17611	2♣9610HD	Idler Pulley - Fan & Alt.	3400884	36308
Hose - Upper - Eng. To Pipe		24240	Kenworth - Continued		
Hose - Upper - Pipe To Rad.		24240	2002 - Continued		

②Two Required.
≧Cut to Fit.

♣Standard Belt Available.

Medium & Heavy-Duty Trucks
(2001 & Newer)

Belts and Coolant Hose for Medium/Heavy-Duty Trucks (2001 & Newer)

Medium & Heavy-Duty Trucks
(2001 & Newer)

Application	Mfr. Part No.	Our No.
Kenworth - Continued		
2002 - Continued		
Cummins ISX Diesel		
T600		
Belt - Fan	3681817	♣K100658HD
Belt - W.P. & A.C.	3681812	♣K060685HD
Tensioner Assy. - Fan	3681240	38535
Tensioner Assy. - W.P. & A.C.	3680194	38532
Idler Pulley - Alt. & A.C.	4026886	36226
Tensioner Pulley - Fan	3681240	36092
Tensioner Pulley - W.P. & A.C.	3680194	36095
Hose - Upper - Eng. To Pipe		24240
Hose - Upper - Pipe To Rad.		24240
Hose - Lower - Eng. To Pipe		24240
Hose - Lower - Pipe To Rad.		24248
T800		
Belt - Fan	3681817	♣K100658HD
Belt - W.P., Alt. & A.C.	3681812	♣K060685HD
Tensioner Assy. - Fan	3681240	38535
Tensioner Assy. - W.P., Alt. & A.C.	3680194	38532
Idler Pulley - Alt. & A.C.	4026886	36226
Tensioner Pulley - Fan	3681240	36092
Tensioner Pulley - W.P., Alt. & A.C.	3680194	36095
Hose - Upper - Eng. To Pipe		24240
Hose - Upper - Pipe To Rad.		24240
Hose - Lower - Eng. To Pipe		24240
Hose - Lower - Pipe To Rad.		24248
T2000		
Belt - Fan	3681821	♣K100675HD
Belt - W.P., Alt. & A.C.	3681812	♣K060685HD
Tensioner Assy. - Fan	3681240	38535
Tensioner Assy. - W.P., Alt. & A.C.	3680194	38532
Idler Pulley - Alt. & A.C.	4026886	36226
Tensioner Pulley - Fan	3681240	36092
Tensioner Pulley - W.P., Alt. & A.C.	3680194	36095
Hose - Upper - Eng. To Pipe		24240
Hose - Upper - Pipe To Rad.		26532
Hose - Lower - Eng. To Pipe		24240
Hose - Lower - Pipe To Rad.		24240
W900		
Belt - Fan	3681823	♣K100670HD
Belt - W.P., Alt. & A.C.	3681812	♣K060685HD
Tensioner Assy. - Fan	3681240	38535
Tensioner Assy. - W.P., Alt. & A.C.	3680194	38532
Idler Pulley - Alt. & A.C.	4026886	36226
Tensioner Pulley - Fan	3681240	36092
Tensioner Pulley - W.P., Alt. & A.C.	3680194	36095
Hose - Upper - Eng. To Pipe		24240
Hose - Upper - Pipe To Rad.		24240
Hose - Lower - Eng. To Pipe		24240
Hose - Lower - Pipe To Rad.		24240
Cummins N14 Diesel		
K100		
Belt - W.P.; W/6-Ribbed Belt	217638	♣K060435HD
T800		
Belt - Hub & W.P.		♣K060425HD
Belt - Hub To Fan; W/44" Belt O.C.		TR28437
Belt - Hub To Fan; W/46 1/2" Belt O.C.	D11025738	TR28463
Belt - Alt.	D11023497	♣9451HD
Belt - Hub & A.C.	17425	♣9425HD
Hose - Upper - Eng. To Pipe		24240
Hose - Upper - Pipe To Rad.		24240
Hose - Lower - Eng. To Pipe		24240
Hose - Lower - Pipe To Rad.		24240
Hose - Lower - Pipe To Pipe		24240
W900		
Belt - Hub & W.P.	3076492	♣K060425HD
Belt - Hub & Fan		②TR28483

♣Standard Belt Available.

Application	Mfr. Part No.	Our No.
Kenworth - Continued		
2002 - Continued		
Cummins N14 Diesel - Continued		
W900 - Continued		
Belt - Alt.		②♣9451HD
Belt - Hub & A.C.	17425	♣9425HD
Hose - Upper - Eng. To Pipe		24240
Hose - Upper - Pipe To Rad.		24240
Hose - Lower - Eng. To Pipe		24240
Hose - Lower - Pipe To Rad.		24240
Cummins Signature 600 Diesel		
W900		
Belt - Fan	3681823	♣K100670HD
Belt - W.P., Alt. & A.C.	3681812	♣K060685HD
Tensioner Assy. - Fan	3681240	38535
Tensioner Assy. - W.P., Alt. & A.C.	3680194	38532
Idler Pulley - Alt. & A.C.	4026886	36226
Tensioner Pulley - Fan	3681240	36092
Tensioner Pulley - W.P., Alt. & A.C.	3680194	36095
Hose - Upper - Eng. To Pipe		24240
Hose - Upper - Pipe To Rad.		24240
Hose - Lower - Eng. To Pipe		24240
Hose - Lower - Pipe To Rad.		24240
2001		
Caterpillar 3126 Diesel		
T300		
Belt - Fan, Alt. & A.C.	4080767	♣K080774HD
Belt - W.P.	0366775	♣9341HD
Tensioner Assy. - Fan, Alt. & A.C.	1352151	38511
Tensioner Pulley - Fan, Alt. & A.C.	1352151	36091
Hose - Upper - Eng. To Pipe		21891
Hose - Upper - Pipe To Rad.		21115
Hose - Lower - Eng. To Pipe		24232
Hose - Lower - Pipe To Pipe		24240
Hose - Lower - Pipe To Rad.		22707
Caterpillar C10 Diesel		
T600		
Belt - Fan, Alt. & Hub	D11080001	♣K080825HD
Belt - Fan & A.C.		♣9555HD
Tensioner Assy. - Fan, Alt. & Hub	1481974	38506
Idler Pulley - Fan & Alt.; W/Flat Idler Pulley .	1337023	36091
Idler Pulley - Fan & Alt.; W/Multi-Grooved Idler Pulley	1731498	36231
Tensioner Pulley - Fan, Alt. & Hub	1481974	36091
Hose - Upper - Eng. To Pipe		24240
Hose - Upper - Pipe To Rad.		24240
Hose - Lower - Eng. To Pipe		24248
Hose - Lower - Pipe To Rad.		24248
T800		
Belt - Fan, Alt. & Hub; W/Conventional Hood	D11080033	♣K080825HD
Belt - Fan, Alt. & Hub; W/Short Hood		♣K080806HD
Belt - Fan & A.C.		♣9555HD
Tensioner Assy. - Fan, Alt. & Hub	1481974	38506
Idler Pulley - Fan & Alt.; W/Flat Idler Pulley .	1337023	36091
Idler Pulley - Fan & Alt.; W/Multi-Grooved Idler Pulley	1731498	36231
Tensioner Pulley - Fan, Alt. & Hub	1481974	36091
Hose - Upper - Eng. To Pipe		24248
Hose - Upper - Pipe To Rad.		24240
Hose - Lower - Eng. To Pipe		24240
Hose - Lower - Pipe To Rad.		24240
W900		
Belt - Fan & Alt.		♣K080810HD
Belt - Fan To A.C.		♣9540HD
Idler Pulley - Fan & Alt.; W/Flat Idler Pulley .	1337023	36091

②Two Required.

Belts and Coolant Hose for Medium/Heavy-Duty Trucks (2001 & Newer)

Application	Mfr. Part No.	Our No.	Application	Mfr. Part No.	Our No.
Kenworth - Continued			Kenworth - Continued		
2001 - Continued			2001 - Continued		
Caterpillar C10 Diesel - Continued			Caterpillar C15 Diesel - Continued		
W900 - Continued			T600 - Continued		
Idler Pulley - Fan & Alt.; W/Multi-Grooved			Tensioner Pulley - Fan To A.C.; W/Clean Air Pkg. 1900642		
Idler Pulley	1731498	36231	Hose - Upper - Eng. To Pipe		36091
Hose - Upper - Eng. To Pipe		24240	Hose - Upper - Pipe To Rad.		24240
Hose - Upper - Pipe To Rad.		24240	Hose - Lower - Eng. To Pipe		24248
Hose - Lower - Eng. To Pipe		24240	Hose - Lower - Pipe To Rad.		24248
Hose - Lower - Pipe To Rad.		24240	T800		
Caterpillar C12 Diesel			Belt - Fan & W.P.		
T600			Belt - Fan, Alt. & A.C.		
Belt - Fan, Alt. & Hub	D11080001	♣K080825HD	Hose - Upper - Eng. To Pipe		24240
Belt - Fan & A.C.		♣9555HD	Hose - Upper - Pipe To Rad.		24240
Tensioner Assy. - Fan, Alt. & Hub	1481974	38506	Hose - Lower - Eng. To Pipe		24248
Idler Pulley - Fan & Alt.; W/Flat Idler Pulley . 1337023		36091	Hose - Lower - Pipe To Rad.		24248
Idler Pulley - Fan & Alt.; W/Multi-Grooved			T2000		
Idler Pulley	1731498	36231	Belt - Fan; Preferred Belt		2/TR22570PB
Tensioner Pulley - Fan, Alt. & Hub	1481974	36091	Belt - Fan; Optional Belt		2/TR22570
Hose - Upper - Eng. To Rad.		24240	Belt - Fan, Alt. & A.C.		2/♣9560HD
Hose - Upper - Pipe To Rad.		24240	Hose - Upper - Eng. To Rad.		24240
Hose - Lower - Eng. To Pipe		24248	Hose - Upper - Pipe To Rad.		24240
Hose - Lower - Pipe To Rad.		24248	Hose - Lower - Eng. To Pipe		24240
T800			Hose - Lower - Pipe To Rad.		24240
Belt - Fan, Alt. & Hub; W/Conventional			W900		
Hood	D11080033	♣K080825HD	Belt - Fan; Preferred Belt		2/TR22570PB
Belt - Fan, Alt. & Hub; W/Short Hood		♣K080806HD	Belt - Fan; Optional Belt		2/TR22570
Belt - Fan & A.C.		♣9555HD	Belt - Fan, Alt. & A.C.		2/♣9610HD
Tensioner Assy. - Fan, Alt. & Hub	1481974	38506	Hose - Upper - Eng. To Pipe		24240
Tensioner Pulley - Fan, Alt. & Hub	1481974	36091	Hose - Upper - Pipe To Rad.		24240
Hose - Upper - Eng. To Pipe		24248	Hose - Lower - Eng. To Pipe		24248
Hose - Upper - Pipe To Rad.		24240	Hose - Lower - Pipe To Rad.		24248
Hose - Lower - Eng. To Pipe		24240	Caterpillar C16 Diesel		
Hose - Lower - Pipe To Rad.		24240	T800		
W900			Belt - Fan & W.P.		2/TR22545
Belt - Fan & Alt.		♣K080810HD	Belt - Fan, Alt. & A.C.		2/♣9620HD
Belt - Fan To A.C.		♣9540HD	Hose - Upper - Eng. To Pipe		24240
Idler Pulley - Fan & Alt.; W/Flat Idler Pulley . 1337023		36091	Hose - Upper - Pipe To Rad.		24240
Idler Pulley - Fan & Alt.; W/Multi-Grooved			Hose - Lower - Eng. To Pipe		24248
Idler Pulley	1731498	36231	Hose - Lower - Pipe To Rad.		24248
Hose - Upper - Eng. To Pipe		24240	T2000		
Hose - Upper - Pipe To Rad.		24240	Belt - Fan; Preferred Belt		2/TR22570PB
Hose - Lower - Eng. To Pipe		24240	Belt - Fan; Optional Belt		2/TR22570
Hose - Lower - Pipe To Rad.		24240	Belt - Fan, Alt. & A.C.		2/♣9560HD
Caterpillar C15 Diesel			Hose - Upper - Eng. To Rad.		24240
C500			Hose - Upper - Pipe To Rad.		24240
Belt - Fan		2/TR22635	Hose - Lower - Eng. To Pipe		24240
Belt - Fan, Alt. & A.C.		2/♣9520HD	Hose - Lower - Pipe To Rad.		24240
Hose - Upper - Eng. To Pipe		24232	W900		
Hose - Upper - Pipe To Rad.		24240	Belt - Fan; Preferred Belt		2/TR22570PB
Hose - Lower - Eng. To Pipe		24248	Belt - Fan; Optional Belt		2/TR22570
Hose - Lower - Pipe To Rad.		24240	Belt - Fan, Alt. & A.C.		2/♣9610HD
T600			Hose - Upper - Eng. To Pipe		24240
Belt - Fan & Alt.; W/Clean Air Pkg.; W/84			Hose - Upper - Pipe To Rad.		24240
7/8" Belt O.C.	D8410001082135	♣K080842HD	Hose - Lower - Eng. To Pipe		24240
Belt - Fan & Alt.; W/Clean Air Pkg.; W/89			Hose - Lower - Pipe To Rad.		24248
7/8" Belt O.C.	D11084906	♣K080893HD	Cummins ISB Diesel		
Belt - Fan To A.C.; W/Clean Air Pkg.	D8410003061450	♣K060569HD	K300		
Belt - Fan & W.P.; W/O Clean Air Pkg.; Preferred Belt		2/TR22553PB	Belt - Fan, W.P. & Alt.		3911579
Belt - Fan & W.P.; W/O Clean Air Pkg.; Optional Belt		2/TR22553	Belt - Fan & A.C.		17481
Belt - Fan, Alt. & A.C.; W/O Clean Air Pkg.		2/♣9620HD	Cummins ISC Diesel		
Tensioner Assy. - Fan & Alt.; W/Clean Air			T300		
Pkg.; W/84" Belt O.C.	1900643	38620	Belt - Fan, Alt. & Hub		3944837
Tensioner Assy. - Fan & Alt.; W/Clean Air			Belt - Fan & A.C.		7420
Pkg.; W/89" Belt O.C.	1900649	38506	Tensioner Assy. - Fan, Alt. & Hub		3936213
Tensioner Assy. - Fan To A.C.; W/Clean			Tensioner Pulley - Fan, Alt. & Hub		3936213
Air Pkg.	1900642	38508			36093
Idler Pulley - Smooth	1979641	36091			
Idler Pulley - Grooved	1979642	36341			

♣Standard Belt Available.

2/Two Required.

Medium & Heavy-Duty Trucks
(2001 & Newer)

Belts and Coolant Hose for Medium/Heavy-Duty Trucks (2001 & Newer)

Medium & Heavy-Duty Trucks
(2001 & Newer)

Application	Mfr. Part No.	Our No.	Application	Mfr. Part No.	Our No.
Kenworth - Continued			Kenworth - Continued		
2001 - Continued			2001 - Continued		
Cummins ISC Diesel - Continued			Cummins ISX Diesel - Continued		
T300 - Continued			W900 - Continued		
Hose - Upper - Eng. To Pipe		24236	Tensioner Pulley - Hub, Alt. & A.C.	3680194	36095
Hose - Upper - Pipe To Rad.		≧21115	Hose - Upper - Eng. To Pipe		24240
Hose - Lower - Eng. To Pipe		20206	Hose - Upper - Pipe To Rad.		24240
Cummins ISL Diesel			Hose - Lower - Eng. To Pipe		24240
T800			Hose - Lower - Pipe To Rad.		24240
Belt - Fan, W.P. & Alt.	3289369	♣K080716HD	Cummins N14 Diesel		
Belt - Fan To A.C.	D11023525	♣9463HD	K100		
Tensioner Assy. - Fan, W.P. & Alt.	3936213	38516	Belt - W.P.; W/6-Ribbed Belt	217638	♣K060435HD
Tensioner Pulley - Fan, W.P. & Alt.	3936213	36093	T600; T800		
Hose - Upper - Eng. To Pipe		24236	Belt - Hub & W.P.		♣K060425HD
Hose - Upper - Rad. To Pipe		24236	Belt - Hub & Fan		②TR28437
Hose - Lower - Eng. To Pipe		24232	Belt - Alt.		②♣9451HD
Hose - Lower - Pipe To Cooler		24236	Belt - Hub & A.C.	17425	♣9425HD
Hose - Lower - Cooler To Pipe		24240	Hose - Upper - Eng. To Pipe		24240
Hose - Lower - Rad. To Pipe		24052	Hose - Upper - Pipe To Rad.		24240
Cummins ISM Diesel			Hose - Lower - Eng. To Pipe		24240
T600; T800			Hose - Lower - Pipe To Rad.		24248
Belt - Fan & Alt.	3099256	♣K080708HD	T2000		
Belt - Hub & A.C.		♣9530HD	Belt - W.P.	3076492	♣K060425HD
Tensioner Assy. - Fan & Alt.	3400885	38521	Belt - A.C.	17421	♣9420HD
Idler Pulley - Fan & Alt.	3400884	36308	Belt - Fan	28413	TR28412
Hose - Upper - Eng. To Pipe		24240	Belt - Alt.	17451	♣9451HD
Hose - Upper - Pipe To Rad.		24240	W900		
Hose - Lower - Eng. To Pipe		24240	Belt - Hub & W.P.	3076492	♣K060425HD
Hose - Lower - Pipe To Rad.		24240	Belt - Hub & Fan		②TR28483
W900			Belt - Alt.		②♣9451HD
Belt - Fan & Alt.	3099256	♣K080708HD	Belt - Hub & A.C.	17425	♣9425HD
Belt - Hub & A.C.		♣9530HD	Hose - Upper - Eng. To Pipe		24240
Tensioner Assy. - Fan & Alt.	3400885	38521	Hose - Upper - Pipe To Rad.		24240
Idler Pulley - Fan & Alt.	3400884	36308	Hose - Lower - Eng. To Pipe		24240
Cummins ISX Diesel			Hose - Lower - Pipe To Rad.		24240
T800			Cummins Signature 600 Diesel		
Belt - Fan	3681817	♣K100658HD	W900		
Belt - Hub, Alt. & A.C.	3681812	♣K060685HD	Belt - Fan	3681823	♣K100670HD
Tensioner Assy. - Fan	3681240	38535	Belt - W.P., Alt. & A.C.	3681812	♣K060685HD
Tensioner Assy. - Hub, Alt. & A.C.	3680194	38532	Tensioner Assy. - Fan	3681240	38535
Idler Pulley - Alt. & A.C.	4026886	36226	Tensioner Assy. - Hub, Alt. & A.C.	3680194	38532
Tensioner Pulley - Fan	3681240	36092	Idler Pulley - Alt. & A.C.	4026886	36226
Tensioner Pulley - Hub, Alt. & A.C.	3680194	36095	Tensioner Pulley - Fan	3681240	36092
Hose - Upper - Eng. To Pipe		24240	Tensioner Pulley - Hub, Alt. & A.C.	3680194	36095
Hose - Upper - Pipe To Rad.		24240	Hose - Upper - Eng. To Pipe		24240
Hose - Lower - Eng. To Pipe		24240	Hose - Upper - Pipe To Rad.		24240
Hose - Lower - Pipe To Rad.		24248	Hose - Lower - Eng. To Pipe		24240
T2000			Hose - Lower - Pipe To Rad.		24240
Belt - Fan	3681821	♣K100675HD	Detroit Diesel 6-Cyl. 11.1 L Diesel		
Belt - Hub, Alt. & A.C.	3681812	♣K060685HD	T800		
Belt - W.P., Alt. & A.C.	3681812	♣K060685HD	Belt - Fan		③♣9447HD
Tensioner Assy. - Fan	3681240	38535	Belt - Hub, Alt. & A.C.		♣K080580HD
Tensioner Assy. - Hub, Alt. & A.C.	3680194	38532	Tensioner Assy. - Hub, Alt. & A.C.	23520317	38501
Idler Pulley - Alt. & A.C.	4026886	36226	Tensioner Pulley - Hub, Alt. & A.C.		38075
Tensioner Pulley - Fan	3681240	36092	Hose - Upper - Eng. To Pipe		24240
Tensioner Pulley - Hub, Alt. & A.C.	3680194	36095	Hose - Upper - Pipe To Rad.		24240
Hose - Upper - Eng. To Pipe		24240	Hose - Lower - Eng. To Pipe		24240
Hose - Upper - Pipe To Rad.		26532	Hose - Lower - Pipe To Rad.		24248
Hose - Lower - Eng. To Pipe		24240	W900		
Hose - Lower - Pipe To Rad.		24240	Belt - Fan; W/47 3/4" Belt O.C.; Preferred Belt		3/9470PB
W900			Belt - Fan; W/47 3/4" Belt O.C.; Optional Belt		③♣9470HD
Belt - Fan	3681823	♣K100670HD	Belt - Hub, Alt. & A.C.	23520613	♣K080580HD
Belt - Hub, Alt. & A.C.	3681812	♣K060685HD	Tensioner Assy. - Hub, Alt. & A.C.	23520317	38501
Tensioner Assy. - Fan	3681240	38535	Tensioner Pulley - Hub, Alt. & A.C.		38075
Tensioner Assy. - Hub, Alt. & A.C.	3680194	38532	Hose - Upper - Eng. To Pipe		24240
Idler Pulley - Alt. & A.C.	4026886	36226	Hose - Upper - Pipe To Rad.		24240
Tensioner Pulley - Fan	3681240	36092	Hose - Lower - Eng. To Pipe		24240
Tensioner Pulley - Hub, Alt. & A.C.	3680194	36095	Hose - Lower - Pipe To Rad.		24248

≧Cut to Fit.
②Two Required.

♣Standard Belt Available.
③Three Required.

Belts and Coolant Hose for Medium/Heavy-Duty Trucks (2001 & Newer)

Application	Mfr. Part No.	Our No.	Application	Mfr. Part No.	Our No.
Kenworth - Continued			Mack - Continued		
2001 - Continued			2015 - Continued		
Detroit Diesel 6-Cyl. 11.1 L Diesel - Continued			Mack MP8 Diesel - Continued		
W900 - Continued			GU Series		
Hose - Lower - Pipe To Rad.		24240	Belt - Serpentine Enhancement Kit - Alt. & A.C.; For Improved Belt Drive Design ...	21568414	ACK080630HD
Detroit Diesel 6-Cyl. 12.7 L Diesel			Belt - Serpentine - Fan	21372811	▲K120784HD
T800			Belt - Serpentine - Alt. & A.C.	21556637	▲K080630HD
Belt - Fan		③▲9447HD	Tensioner Assy. - Fan	21714847	38633
Belt - Hub, Alt. & A.C.		▲K080580HD	Tensioner Assy. - Alt. & A.C.	21454379	38671
Tensioner Assy. - Hub, Alt. & A.C.	23520317	38501	Hose - Turbo To Pipe (Hot Side)	20550690	26201
Tensioner Pulley - Hub, Alt. & A.C.		38075	Hose - Pipe To Intercooler (Hot Side)	20550690	26201
Hose - Upper - Eng. To Pipe		24240	MRU Series		
Hose - Upper - Pipe To Rad.		24240	Belt - Serpentine Enhancement Kit - Alt. & A.C.; For Improved Belt Drive Design ...	21568414	ACK080630HD
Hose - Lower - Eng. To Pipe		24240	Belt - Serpentine - Fan	21372811	▲K120784HD
Hose - Lower - Pipe To Rad.		24248	Belt - Serpentine - Alt. & A.C.	21556637	▲K080630HD
T2000			Tensioner Assy. - Fan	21714847	38633
Belt - A.C.	23520613	▲K080580HD	Tensioner Assy. - Alt. & A.C.	21454379	38671
W900			Mack MP10 Diesel		
Belt - Fan; W/47 3/4" Belt O.C.; Preferred Belt		3/9470PB	TD Series		
Belt - Fan; W/47 3/4" Belt O.C.; Optional Belt		③▲9470HD	Belt - Serpentine Enhancement Kit - Alt. & A.C.; For Improved Belt Drive Design		ACK080550HD
Belt - Hub, Alt. & A.C.	23520613	▲K080580HD	Belt - Serpentine - Fan	21064733	K100578HD
Tensioner Assy. - Hub, Alt. & A.C.	23520317	38501	Belt - Serpentine - Alt. & A.C.	21064734	▲K080550HD
Tensioner Pulley - Hub, Alt. & A.C.		38075	Tensioner Assy. - Fan	21631484	38581
Hose - Upper - Eng. To Pipe		24240	Tensioner Assy. - Alt. & A.C.	21422767	38585
Hose - Upper - Pipe To Rad.		24240	2014		
Hose - Lower - Eng. To Pipe		24240	Mack MP7 Diesel		
Hose - Lower - Pipe To Rad.		24240	GU Series		
Mack			Belt - Serpentine Enhancement Kit - Alt. & A.C.; For Improved Belt Drive Design ...	21568410	ACK080623HD
2015			Belt - Serpentine - Fan	21372809	▲K100739HD
Mack MP7 Diesel			Belt - Serpentine - Alt. & A.C.	21460409	▲K080623HD
CXU Series			Tensioner Assy. - Alt. & A.C.	21454379	38671
Belt - Serpentine Enhancement Kit - Alt. & A.C.; For Improved Belt Drive Design ...	21568410	ACK080623HD	Tensioner Assy. - Fan	21819687	38607
Belt - Serpentine - Fan	21372809	▲K100739HD	GU Series		
Belt - Serpentine - Alt. & A.C.	21460409	▲K080623HD	Belt - Serpentine Enhancement Kit - Alt. & A.C.; For Improved Belt Drive Design ...	21568410	ACK080623HD
Tensioner Assy. - Alt. & A.C.	21454379	38671	Belt - Serpentine - Fan	21372809	▲K100739HD
Tensioner Assy. - Fan	21819687	38607	Belt - Serpentine - Alt. & A.C.	21460409	▲K080623HD
LEU Series			Tensioner Assy. - Fan	21819687	38607
Belt - Serpentine Enhancement Kit - Alt. & A.C.; For Improved Belt Drive Design ...	21568410	ACK080623HD	Tensioner Assy. - Alt. & A.C.	21454379	38671
Belt - Serpentine - Fan	21372809	▲K100739HD	Hose - Upper - Pipe To Eng.		≧24840
Belt - Serpentine - Alt. & A.C.	21460409	▲K080623HD	MRU Series		
Tensioner Assy. - Fan	21819687	38607	Belt - Serpentine Enhancement Kit - Alt. & A.C.; For Improved Belt Drive Design ...	21568411	ACK080623HD
Tensioner Assy. - Alt. & A.C.	21454379	38671	Belt - Serpentine Enhancement Kit - Alt.; W/O A.C.; For Improved Belt Drive Design	21568412	ACK080585HD
MRU Series			Belt - Fan	21056225	DK100672
Belt - Serpentine Enhancement Kit - Alt. & A.C.; For Improved Belt Drive Design ...	21568410	ACK080623HD	Belt - Alt.	21460409	▲K080623HD
Belt - Serpentine - Fan	21372809	▲K100739HD	Tensioner Assy. - Fan	20935521	38607
Belt - Serpentine - Alt. & A.C.	21460409	▲K080623HD	Tensioner Assy. - Alt.	21454379	38671
Tensioner Assy. - Fan	21819687	38607	Hose - Pipe To Intercooler (Hot Side)	20550690	26201
Tensioner Assy. - Alt. & A.C.	21454379	38671	Mack MP8 Diesel		
Mack MP8 Diesel			CHU Series		
CHU Series; CXU Series			Belt - Serpentine Enhancement Kit - Alt. & A.C.; For Improved Belt Drive Design ...	21568414	ACK080630HD
Belt - Serpentine Enhancement Kit - Alt. & A.C.; For Improved Belt Drive Design ...	21568414	ACK080630HD	Belt - Serpentine - Fan	21372815	K120786HD
Belt - Serpentine - Fan	21372811	▲K120784HD	Belt - Serpentine - Alt. & A.C.	21556637	▲K080630HD
Belt - Serpentine - Alt. & A.C.	21556637	▲K080630HD	Tensioner Assy. - Fan	21714847	38633
Tensioner Assy. - Fan	21714847	38633	Tensioner Assy. - Alt. & A.C.	21454379	38671
Tensioner Assy. - Alt. & A.C.	21454379	38671	Hose - Upper - Pipe To Eng.		22714
Standard Belt Available.			GU Series		
≧Cut to Fit.			Belt - Serpentine Enhancement Kit - Alt. & A.C.; For Improved Belt Drive Design ...	21568414	ACK080630HD
			Belt - Serpentine - Alt. & A.C.	21556637	▲K080630HD
			Belt - Serpentine - Fan	20582565	K120640HD
			Tensioner Assy. - Alt. & A.C.	21454379	38671
			Tensioner Assy. - Fan	21714847	38633
			Hose - Upper - Pipe To Eng.		22714
			Three Required.		

 Medium & Heavy-Duty Trucks
(2001 & Newer)

Belts and Coolant Hose for Medium/Heavy-Duty Trucks (2001 & Newer)

Medium & Heavy-Duty Trucks
(2001 & Newer)

Application	Mfr. Part No.	Our No.	Application	Mfr. Part No.	Our No.
Mack - Continued			Mack - Continued		
2014 - Continued			2013 - Continued		
Mack MP8 Diesel - Continued			Mack MP7 Diesel - Continued		
GU Series - Continued			LEU Series - Continued		
Belt - Serpentine - Fan	21372811	♣K120784HD	Hose - Pipe To Engine (Cold Side)	20550690	26201
Belt - Serpentine - Alt. & A.C.	21556637	♣K080630HD	MRU Series		
Tensioner Assy. - Fan	21714847	38633	Belt - Serpentine Enhancement Kit - Alt. & A.C.; For Improved Belt Drive Design ...	21568411	ACK080623HD
Tensioner Assy. - Alt. & A.C.	21454379	38671	Belt - Serpentine Enhancement Kit - Alt.; W/O A.C.; For Improved Belt Drive Design	21568412	ACK080585HD
Hose - Turbo To Pipe (Hot Side)	20550690	26201	Belt - Fan	21056225	DK100672
Hose - Pipe To Intercooler (Hot Side)	20550690	26201	Belt - Alt.	21460409	♣K080623HD
MRU Series			Tensioner Assy. - Fan	20935521	38607
Belt - Serpentine Enhancement Kit - Alt. & A.C.; For Improved Belt Drive Design ...	21568414	ACK080630HD	Tensioner Assy. - Alt.	21454379	38671
Belt - Alt. & A.C.	21556637	♣K080630HD	Hose - Pipe To Intercooler (Hot Side)	20550690	26201
Mack MP10 Diesel			Mack MP8 Diesel		
TD Series			CHU Series		
Belt - Serpentine Enhancement Kit - Alt. & A.C.; For Improved Belt Drive Design		ACK080550HD	Belt - Serpentine Enhancement Kit - Alt. & A.C.; For Improved Belt Drive Design ...	21568414	ACK080630HD
Belt - Fan	21064733	K100578HD	Belt - Fan	21372815	K120786HD
Belt - Alt. & A.C.	21064734	♣K080550HD	Belt - Alt. & A.C.	21556637	♣K080630HD
Tensioner Assy. - Fan	21631484	38581	Tensioner Assy. - Fan	21714847	38633
Tensioner Assy. - Alt. & A.C.	21422767	38585	Tensioner Assy. - Alt. & A.C.	21454379	38671
Hose - Supply & Return Assy.	21483642	DEF7015	Hose - Upper - Pipe To Eng.		24202
Hose - Turbo To Pipe (Hot Side)	20550690	26201	Hose - Supply & Return Assy.	21483642	DEF7015
Hose - Pipe To Intercooler (Hot Side)	20550690	26201	CXU Series		
2013			Belt - Serpentine Enhancement Kit - Alt. & A.C.; For Improved Belt Drive Design ...	21568414	ACK080630HD
Cummins ISL Diesel			Belt - Fan	20582565	K120640HD
GU Series			Belt - Alt. & A.C.	21556637	♣K080630HD
Belt - A.C. & Alt.	21591998	♣K080944HD	Tensioner Assy. - Fan	21714847	38633
Tensioner Assy.	3973819	38627	Tensioner Assy. - Alt. & A.C.	21454379	38671
Idle Pulley	3970945	36283	Hose - Upper - Pipe To Eng.		22714
Mack MP7 Diesel			Hose - Supply & Return Assy.	21483642	DEF7015
CXU Series			Hose - Pressure - Pump To Injector	21483633	DEF7016
Belt - Serpentine Enhancement Kit - Alt. & A.C.; For Improved Belt Drive Design ...	21568411	ACK080623HD	GU Series		
Belt - Fan & W.P.	20883502	K100604HD	Belt - Serpentine Enhancement Kit - Alt. & A.C.; For Improved Belt Drive Design ...	21568414	ACK080630HD
Belt - Alt. & A.C.	21460409	♣K080623HD	Belt - Fan; W/700 Series	21372816	K100761HD
Tensioner Assy. - Fan	20935521	38607	Belt - Alt. & A.C.	21556637	♣K080630HD
Tensioner Assy. - Alt. & A.C.	21454379	38671	Tensioner Assy. - Fan; W/700 Series	21479276	38632
Hose - Supply & Return Assy.	21483642	DEF7015	Tensioner Assy. - Fan; W/800 Series	21714847	38633
Hose - Pressure - Pump To Injector	21483633	DEF7016	Tensioner Assy. - Alt. & A.C.	21454379	38671
Hose - Turbo To Pipe (Hot Side)	20550690	26201	Hose - Trans. Oil Cooler Outlet; W/Allison Trans.		28357
Hose - Pipe To Intercooler (Hot Side)	20550690	26201	Hose - Supply & Return Assy.; W/800 Series	21483642	DEF7015
GU Series			MRU Series		
Belt - Serpentine Enhancement Kit - Alt. & A.C.; For Improved Belt Drive Design ...	21568411	ACK080623HD	Belt - Serpentine Enhancement Kit - Alt. & A.C.; For Improved Belt Drive Design ...	21568414	ACK080630HD
Belt - Alt. & A.C.	21460409	♣K080623HD	Belt - Alt. & A.C.	21556637	♣K080630HD
Tensioner Assy. - Alt. & A.C.	21454379	38671	Tensioner Assy. - Fan	21454379	38671
Tensioner Assy. - Fan	21422765	38607	Hose - Upper - Rad. To Pipe; W/800 Series	≈24840	
Idle Pulley - Smooth	20933521	36286	Hose - Trans. Oil Cooler Outlet; W/Allison Trans.		28357
Hose - Upper - Rad. To Pipe; W/800 Series		≈24840	LEU Series		
Hose - Trans. Oil Cooler Outlet; W/Allison Trans.		28357	Belt - Serpentine Enhancement Kit - Alt. & A.C.; For Improved Belt Drive Design ...	21568411	ACK080623HD
LEU Series			Belt - Serpentine Enhancement Kit - Alt.; W/O A.C.; For Improved Belt Drive Design	21568412	ACK080585HD
Belt - Serpentine Enhancement Kit - Alt. & A.C.; For Improved Belt Drive Design ...	21568411	ACK080623HD	Belt - Fan & W.P.	21056225	DK100672
Belt - Alt. & A.C.	21460409	♣K080623HD	Belt - Alt.; W/A.C.	21460409	♣K080623HD
Tensioner Assy. - Alt. & A.C.	21454379	38671	Belt - Alt.; W/O A.C.	88GB457P588	♣K080590HD
Tensioner Assy. - Fan	21422765	38607	Tensioner Assy. - Fan	20935521	38607
Idle Pulley - Smooth	20933521	36286	Tensioner Assy. - Alt.	21454379	38671
Hose - Upper - Rad. To Pipe; W/800 Series		≈24840	Idle Pulley - Alt.; W/O A.C.	20747516	36285
Hose - Trans. Oil Cooler Outlet; W/Allison Trans.		28357	Hose - Turbo To Pipe (Hot Side)	20550690	26201
GU Series			Hose - Pipe To Intercooler (Hot Side)	20550690	26201
Belt - Serpentine Enhancement Kit - Alt. & A.C.; For Improved Belt Drive Design ...	21568411	ACK080623HD	Hose - Intercooler To Pipe (Cold Side)	20550690	26201
Belt - Alt. & A.C.	21460409	♣K080623HD	Mack MP10 Diesel		
Belt - Alt.; W/O A.C.	88GB457P588	♣K080590HD	TD Series		
Tensioner Assy. - Fan	20935521	38607	Belt - Serpentine Enhancement Kit - Alt. & A.C.; For Improved Belt Drive Design		ACK080550HD
Tensioner Assy. - Alt.	21454379	38671	Belt - Fan	21064733	K100578HD
Idle Pulley - Alt.; W/O A.C.	20747516	36285	Belt - Alt. & A.C.	21064734	♣K080550HD
Hose - Turbo To Pipe (Hot Side)	20550690	26201	Tensioner Assy. - Fan	21631484	38581
Hose - Pipe To Intercooler (Hot Side)	20550690	26201	Tensioner Assy. - Alt. & A.C.	21422767	38585
Hose - Intercooler To Pipe (Cold Side)	20550690	26201	Hose - Supply & Return Assy.	21483642	DEF7015
♣Standard Belt Available.			Hose - Turbo To Pipe (Hot Side)	20550690	26201
			Hose - Pipe To Intercooler (Hot Side)	20550690	26201
			♣Cut to Fit.		

Belts and Coolant Hose for Medium/Heavy-Duty Trucks (2001 & Newer)

Application	Mfr. Part No.	Our No.	Application	Mfr. Part No.	Our No.
Mack - Continued			Mack - Continued		
2012			2012 - Continued		
Cummins ISL Diesel			Mack MP8 Diesel - Continued		
GU Series			CHU Series - Continued		
Belt - Fan	21591999	K080794HD	Belt - Alt. & A.C.	21556637	▲K080630HD
Tensioner Assy.	3973819	38627	Tensioner Assy. - Alt. & A.C.	21454379	38671
Idler Pulley	3970945	36283	Tensioner Assy. - Fan & W.P.	21461221	38633
Hose - Turbo To Pipe (Hot Side)	20550690	26201	Hose - Upper - Pipe To Eng.		22714
Hose - Pipe To Intercooler (Hot Side)	20550690	26201	Hose - Supply & Return Assy.	21483642	DEF7015
Mack MP7 Diesel			CXU Series		
CXU Series			Belt - Serpentine Enhancement Kit - Alt. & A.C.; For Improved Belt Drive Design ...		
Belt - Serpentine Enhancement Kit - Alt. & A.C.; For Improved Belt Drive Design ...	21568411	ACK080623HD	Belt - Fan	20582565	K120640HD
Belt - Fan & W.P.	20883502	K100604HD	Belt - Alt. & A.C.	21556637	▲K080630HD
Belt - Alt. & A.C.	21460409	▲K080623HD	Tensioner Assy. - Fan	21461221	38633
Tensioner Assy. - Fan	20935521	38607	Tensioner Assy. - Alt. & A.C.	21454379	38671
Tensioner Assy. - Alt. & A.C.	21454379	38671	Hose - Upper - Pipe To Eng.		22714
Hose - Supply & Return Assy.	21483642	DEF7015	Hose - Supply & Return Assy.	21483642	DEF7015
Hose - Pressure - Pump To Injector	21483633	DEF7016	Hose - Pressure - Pump To Injector	21483633	DEF7016
GU Series			GU Series		
Belt - Serpentine Enhancement Kit - Alt. & A.C.; For Improved Belt Drive Design ...	21568411	ACK080623HD	Belt - Serpentine Enhancement Kit - Alt. & A.C.; For Improved Belt Drive Design ...	21568411	ACK080630HD
Belt - Fan; W/700 Series	21372816	K100761HD	Belt - Fan; W/700 Series	21372816	K100761HD
Belt - Alt. & A.C.	21460409	▲K080623HD	Belt - Alt. & A.C.	21556637	▲K080630HD
Tensioner Assy. - Alt	21454379	38671	Tensioner Assy. - Fan; W/700 Series	21479276	38632
Tensioner Assy. - Fan; W/700 Series	21479276	38632	Tensioner Assy. - Alt. & A.C.	21454379	38671
Tensioner Assy. - Fan; W/800 Series	21422765	38607	Hose - Trans. Oil Cooler Outlet; W/Allison Trans.		28357
Idler Pulley - Upper; W/800 Series	20953521	36286	MRU Series		
Hose - Upper - Rad. To Pipe; W/800 Series		≧24840	Belt - Serpentine Enhancement Kit - Alt. & A.C.; For Improved Belt Drive Design ...		
Hose - Trans. Oil Cooler Inlet; W/Allison Trans.; W/700 Series		28358	Belt - Alt. & A.C.	21556637	▲K080630HD
Hose - Trans. Oil Cooler Outlet; W/Allison Trans.; W/700 Series		28357	Tensioner Assy. - Alt. & A.C.	21454379	38671
Hose - Trans. Oil Cooler Outlet; W/Allison Trans.; W/800 Series		28357	Tensioner Assy. - Fan	21714847	38633
LEU Series			Mack MP10 Diesel		
Belt - Serpentine Enhancement Kit - Alt. & A.C.; For Improved Belt Drive Design ...			TD Series		
Belt - Serpentine Enhancement Kit - Alt.; W/O A.C.; For Improved Belt Drive Design	21568412	ACK080585HD	Belt - Serpentine Enhancement Kit - Alt. & A.C.; For Improved Belt Drive Design		
Belt - Fan & W.P.	21056225	DK100672	Belt - Fan	21064733	ACK080550HD
Belt - Alt.; W/A.C.	21460409	▲K080623HD	Belt - Alt. & A.C.	21064734	▲K080550HD
Belt - Alt.; W/O A.C.	88GB457P588	▲K080590HD	Tensioner Assy. - Fan	21631484	38581
Tensioner Assy. - Fan	20935521	38607	Tensioner Assy. - Alt. & A.C.	21422767	38585
Tensioner Assy. - Alt	21454379	38671	Hose - Supply & Return Assy.	21483642	DEF7015
Idler Pulley - Alt.; W/O A.C.	20747516	36285	Hose - Turbo To Pipe (Hot Side)	20550690	26201
Hose - Turbo To Pipe (Hot Side)	20550690	26201	Hose - Pipe To Intercooler (Hot Side)	20550690	26201
Hose - Pipe To Intercooler (Hot Side)	20550690	26201	2011		
Hose - Intercooler To Pipe (Cold Side)	20550690	26201	Cummins ISM Diesel		
Hose - Pipe To Engine (Cold Side)	20550690	26201	CXU Series		
MRU Series			Belt - Fan & W.P.		
Belt - Serpentine Enhancement Kit - Alt. & A.C.; For Improved Belt Drive Design ...			20883502		
Belt - Serpentine Enhancement Kit - Alt.; W/O A.C.; For Improved Belt Drive Design	21568412	ACK080623HD	Belt - A.C. & Alt.	20545619	▲K080630HD
Belt - Fan & W.P.	21056225	ACK080585HD	Tensioner Assy. - Fan	21422765	38607
Belt - Alt.; W/A.C.	21460409	DK100672	Tensioner Assy. - A.C.	21454379	38671
Belt - Alt.; W/O A.C.	21556636	▲K080585HD	Mack MP7 Diesel		
Tensioner Assy. - Fan & W.P.	20935521	38607	CXU Series		
Tensioner Assy. - Alt	21454379	38671	Belt - Serpentine Enhancement Kit - Alt. & A.C.; For Improved Belt Drive Design ...		
Idler Pulley - Alt.; W/O A.C.	20747516	36285	Belt - Fan & W.P.	20883502	ACK080623HD
Hose - Pipe To Intercooler (Hot Side)	20550690	26201	Belt - Alt. & A.C.	21460409	▲K080623HD
Mack MP8 Diesel			Tensioner Assy. - Fan		
CHU Series			20935521		
Belt - Serpentine Enhancement Kit - Alt. & A.C.; For Improved Belt Drive Design ...			21454379		
Belt - Fan & W.P.	21372815	K120786HD	Hose - Supply & Return Assy.	21483642	DEF7015
			Hose - Pressure - Pump To Injector	21483633	DEF7016
			GU Series		
			Belt - Serpentine Enhancement Kit - Alt. & A.C.; For Improved Belt Drive Design ...		
			21568411		
			ACK080623HD		
			Belt - Alt. & A.C.		
			21460409		
			▲K080623HD		
			Tensioner Assy. - Fan		
			20935521		
			38607		
			Tensioner Assy. - Alt. & A.C.		
			21454379		
			38671		

Medium & Heavy-Duty Trucks (2001 & Newer)

▲Standard Belt Available.

≧Cut to Fit.

Belts and Coolant Hose for Medium/Heavy-Duty Trucks (2001 & Newer)

Medium & Heavy-Duty Trucks
(2001 & Newer)

Application	Mfr. Part No.	Our No.	Application	Mfr. Part No.	Our No.
Mack - Continued			Mack - Continued		
2011 - Continued			2011 - Continued		
Mack MP7 Diesel - Continued			Mack MP8 Diesel - Continued		
GU Series - Continued			CXU Series - Continued		
Idler Pulley - Upper: W/800 Series	20953521	36286	Hose - Lower		24200
Hose - Upper - Rad. To Pipe; W/700 Series		≈24840	Hose - Supply & Return Assy.	21483642	DEF7015
Hose - Trans. Oil Cooler Inlet; W/Allison Trans.; W/800 Series		28358	Hose - Pressure - Pump To Injector	21483633	DEF7016
Hose - Trans. Oil Cooler Outlet; W/Allison Trans.; W/700 Series		28357	GU Series		
Hose - Supply & Return Assy.; W/800 Series	21483642	DEF7015	Belt - Serpentine Enhancement Kit - Alt. & A.C.; For Improved Belt Drive Design ...	21568414	ACK080630HD
LEU Series			Belt - Fan; W/700 Series	21372850	K100764HD
Belt - Serpentine Enhancement Kit - Alt. & A.C.; For Improved Belt Drive Design ...	21568411	ACK080623HD	Belt - Fan; W/800 Series	21372815	K120786HD
Belt - Serpentine Enhancement Kit - Alt.; W/O A.C.; For Improved Belt Drive Design	21568412	ACK080585HD	Belt - Alt. & A.C.	21556637	▲K080630HD
Belt - Fan & W.P.	21056225	DK100672	Tensioner Assy. - Fan; W/800 Series	21461221	38633
Belt - Alt.; W/A.C.	21460409	▲K080623HD	Tensioner Assy. - Fan; W/700 Series	20487079	38632
Belt - Alt.; W/O A.C.	88GB457P588	▲K080590HD	Tensioner Assy. - Alt. & A.C.	21454379	38671
Tensioner Assy. - Fan	20935521	38607	Idler Pulley - Upper: W/700 Series	20747516	36285
Tensioner Assy. - Alt.	21454379	38671	Hose - Upper - Rad. To Pipe		23563
Idler Pulley - Alt.; W/O A.C.	20747516	36285	Hose - Upper - Pipe To Eng.		24202
Hose - Upper - Rad. To Pipe		≈24840	Hose - Supply & Return Assy.; W/700 Series	21483642	DEF7015
Hose - Upper - Pipe To Eng.		≈24838	MRU Series		
Hose - Lower - Rad. To Pipe		≈24840	Belt - Serpentine Enhancement Kit - Alt. & A.C.; For Improved Belt Drive Design ...	21568414	ACK080630HD
Hose - Trans. Oil Cooler Outlet; W/Allison Trans.		28357	Belt - Fan	21372815	K120786HD
Hose - Trans. Oil Cooler Inlet; W/Allison Trans.		28358	Belt - Alt. & A.C.	21556637	▲K080630HD
Hose - Turbo To Pipe (Hot Side)	20550690	26201	Tensioner Assy. - Fan & W.P.	21461221	38633
Hose - Pipe To Intercooler (Hot Side)	20550690	26201	Tensioner Assy. - Alt. & A.C.	21454379	38671
Hose - Intercooler To Pipe (Cold Side)	20550690	26201	Mack MP10 Diesel		
Hose - Pipe To Engine (Cold Side)	20550690	26201	TD Series		
MRU Series			Belt - Serpentine Enhancement Kit - Alt. & A.C.; For Improved Belt Drive Design		ACK080550HD
Belt - Serpentine Enhancement Kit - Alt. & A.C.; For Improved Belt Drive Design ...	21568411	ACK080623HD	Belt - Fan	21064733	K100578HD
Belt - Serpentine Enhancement Kit - Alt.; W/O A.C.; For Improved Belt Drive Design	21568412	ACK080585HD	Belt - Alt. & A.C.	21064734	▲K080550HD
Belt - Fan & W.P.	21056225	DK100672	Tensioner Assy. - Fan	21155561	38581
Belt - Alt.; W/A.C.; W/62 7/8" Belt O.C.	21460409	▲K080623HD	Tensioner Assy. - Alt. & A.C.	20966526	38585
Belt - Alt.; W/A.C.; W/63 5/8" Belt O.C.	20545619	▲K080630HD	Idler Pulley - Lower	20747516	36285
Belt - Alt.; W/O A.C.; W/59" Belt O.C.	21556636	▲K080585HD	Hose - Supply & Return Assy.	21483642	DEF7015
Belt - Alt.; W/O A.C.; W/59 1/2" Belt O.C.	20545620	▲K080590HD	Hose - Turbo To Pipe (Hot Side)	20550690	26201
Tensioner Assy. - Fan & W.P.	20935521	38607	Hose - Pipe To Intercooler (Hot Side)	20550690	26201
Tensioner Assy. - Alt.; W/A.C.; W/62 7/8" Belt O.C.	21454379	38671	2010		
Tensioner Assy. - Alt.; W/A.C.; W/63 5/8" Belt O.C.	20762060	38671	Cummins ISL G CNG		
Tensioner Assy. - Alt.; W/O A.C.; W/59" Belt O.C.	21454379	38671	LEU Series		
Tensioner Assy. - Alt.; W/O A.C.; W/59 1/2" Belt O.C.	20762060	38671	Hose - Upper - Pipe To Eng.		
Idler Pulley - Alt.; W/O A.C.	20747516	36285	≈24838		
Hose - Pipe To Intercooler (Hot Side)	20550690	26201	Cummins ISM Diesel		
Mack MP8 Diesel			CXU Series		
CHU Series			Belt - Fan & W.P.	20883502	K100604HD
Belt - Serpentine Enhancement Kit - Alt. & A.C.; For Improved Belt Drive Design ...	21568414	ACK080630HD	Belt - Alt. & A.C.	88GB457P630	▲K080630HD
Belt - Fan	21372815	K120786HD	Tensioner Assy. - Fan	20935521	38607
Belt - Alt. & A.C.	21556637	▲K080630HD	Tensioner Assy. - Alt. & A.C.	21404578	38671
Tensioner Assy. - Fan & W.P.	21461221	38633	Mack MP7 Diesel		
Tensioner Assy. - Alt. & A.C.	21454379	38671	CXU Series		
CXU Series			Belt - Serpentine Enhancement Kit - Alt. & A.C.; For Improved Belt Drive Design ...	21568411	ACK080623HD
Belt - Serpentine Enhancement Kit - Alt. & A.C.; For Improved Belt Drive Design ...	21568414	ACK080630HD	Belt - Fan & W.P.	20883502	K100604HD
Belt - Alt. & A.C.	21556637	▲K080630HD	Belt - Alt. & A.C.; W/62 7/8" Belt O.C.	21460409	▲K080623HD
Tensioner Assy. - Fan & W.P.	21461221	38633	Belt - Alt. & A.C.; W/63 5/8" Belt O.C.	20545619	▲K080630HD
Tensioner Assy. - Alt. & A.C.	21454379	38671	Tensioner Assy. - Fan	20935521	38607
GU Series			Tensioner Assy. - Alt. & A.C.; W/62 7/8" Belt O.C.	21454379	38671
Belt - Serpentine Enhancement Kit - Alt. & A.C.; For Improved Belt Drive Design ...	21568414	ACK080630HD	Tensioner Assy. - Alt. & A.C.; W/63 5/8" Belt O.C.	20762060	38671
Belt - Alt. & A.C.	21556637	▲K080630HD	GU Series		
Tensioner Assy. - Fan & W.P.	21461221	38633	Belt - Serpentine Enhancement Kit - Alt. & A.C.; For Improved Belt Drive Design ...	21568411	ACK080623HD
Tensioner Assy. - Alt. & A.C.	21454379	38671	Belt - Fan; W/700 Series	88GB470P741	▲K100739HD
Hose - Upper - Rad. To Pipe		23564			

≈Cut to Fit.

▲Standard Belt Available.

Belts and Coolant Hose for Medium/Heavy-Duty Trucks (2001 & Newer)

Application	Mfr. Part No.	Our No.	Application	Mfr. Part No.	Our No.
Mack - Continued			Mack - Continued		
2010 - Continued			2010 - Continued		
Mack MP7 Diesel - Continued			Mack MP8 Diesel		
GU Series - Continued			CHU Series		
Belt - Alt. & A.C.	21460409	♣K080623HD	Belt - Serpentine Enhancement Kit - Alt. & A.C.; For Improved Belt Drive Design ...	21568414	ACK080630HD
Tensioner Assy. - Fan	20935521	38607	Belt - Fan & W.P.	20886339	K120786HD
Tensioner Assy. - Alt. & A.C.	21454379	38671	Belt - A.C. & Alt.	20582552	♣K080630HD
Idler Pulley - Fan (Upper)	20953521	36286	Tensioner Assy. - Alt. & A.C.	21454379	38671
Hose - Upper - Rad. To Pipe; W/800 Series	24840	24840	Tensioner Assy. - Fan	20860873	38633
Hose - Upper - Pipe To Eng.	24840	≠22714	Hose - Upper - Pipe To Rad.	20860873	22714
Hose - Trans. Oil Cooler Inlet; W/Allison Trans.; W/700 Series	24840	28358	CXU Series		
Hose - Trans. Oil Cooler Outlet; W/Allison Trans.; W/700 Series	24840	28357	Belt - Serpentine Enhancement Kit - Alt. & A.C.; For Improved Belt Drive Design ...	21568414	ACK080630HD
LEU Series			Belt - Fan	20582565	K120640HD
Belt - Serpentine Enhancement Kit - Alt. & A.C.; For Improved Belt Drive Design ...	21568411	ACK080623HD	Belt - A.C. & Alt.	20545619	♣K080630HD
Belt - Serpentine Enhancement Kit - Alt.; W/O A.C.; For Improved Belt Drive Design	21568412	ACK080585HD	Tensioner Assy. - Fan	21417563	38633
Belt - Fan & W.P.	88GB456P671	♣K100670HD	Tensioner Assy. - Alt. & A.C.	21454379	38671
Belt - Alt.; W/A.C.; W/62 7/8" Belt O.C.	21460409	♣K080623HD	Hose - Upper - Rad. To Pipe	21454379	23564
Belt - Alt.; W/A.C.; W/63 5/8" Belt O.C.	20545619	♣K080630HD	Hose - Upper - Pipe To Eng.	21454379	24202
Belt - Alt.; W/O A.C.; W/59" Belt O.C.	21556636	♣K080585HD	Hose - Lower	21454379	23563
Belt - Alt.; W/O A.C.; W/59 1/2" Belt O.C.	20545620	♣K080590HD	Hose - Turbo To Pipe (Hot Side)	20550690	26201
Tensioner Assy. - Fan & W.P.	20935521	38607	Hose - Pipe To Intercooler (Hot Side)	20550690	26201
Tensioner Assy. - Alt.; W/A.C.; W/62 7/8" Belt O.C.	21454379	38671	GU Series; MRU Series		
Tensioner Assy. - Alt.; W/A.C.; W/63 5/8" Belt O.C.	20762060	38671	Belt - Serpentine Enhancement Kit - Alt. & A.C.; For Improved Belt Drive Design ...	21568414	ACK080630HD
Tensioner Assy. - Alt.; W/O A.C.; W/59" Belt O.C.	21454379	38671	Belt - Alt. & A.C.	20545619	♣K080630HD
Tensioner Assy. - Alt.; W/O A.C.; W/59 1/2" Belt O.C.	20762060	38671	Belt - Fan & W.P.; W/10-Ribbed Belt	20582563	K100764HD
Idler Pulley - Alt.; W/O A.C.	20747516	36285	Belt - Fan & W.P.; W/12-Ribbed Belt	20886339	K120786HD
Hose - Upper - Rad. To Pipe	24840	≠24840	Tensioner Assy. - Fan	20487079	38632
Hose - Upper - Pipe To Eng.	24838	≠24838	Tensioner Assy. - Alt. & A.C.	21454379	38671
Hose - Lower - Rad. To Pipe	24840	≠24840	Idler Pulley - Fan; W/Flat Idler Pulley	20747516	36285
Hose - Lower - Pipe To Eng.	24840	≠24840	Hose - Upper - Eng. To Pipe	20747516	22714
Hose - Turbo To Pipe (Hot Side)	20550690	26201	Mack MP10 Diesel		
Hose - Pipe To Intercooler (Hot Side)	20550690	26201	TD Series		
Hose - Intercooler To Pipe (Cold Side)	20550690	26201	Belt - Serpentine Enhancement Kit - Alt. & A.C.; For Improved Belt Drive Design	21483642	ACK080550HD
Hose - Pipe To Engine (Cold Side)	20550690	26201	Belt - Fan & W.P.	21064733	K100578HD
MRU Series			Belt - Alt. & A.C.	21064734	♣K080550HD
Belt - Serpentine Enhancement Kit - Alt. & A.C.; For Improved Belt Drive Design ...	21568411	ACK080623HD	Tensioner Assy. - Fan	21145261	38581
Belt - Serpentine Enhancement Kit - Alt.; W/O A.C.; For Improved Belt Drive Design	21568412	ACK080585HD	Tensioner Assy. - Alt. & A.C.	21422767	38585
Belt - Fan & W.P.	21056225	DK100672	Idler Pulley - Fan	20747516	36285
Belt - Alt.; W/A.C.; W/62 7/8" Belt O.C.	21460409	♣K080623HD	Hose - Supply & Return Assy.	21483642	DEF7015
Belt - Alt.; W/A.C.; W/63 5/8" Belt O.C.	20545619	♣K080630HD	2009		
Belt - Alt.; W/O A.C.; W/59" Belt O.C.	21556636	♣K080585HD	Cummins ISM Diesel		
Belt - Alt.; W/O A.C.; W/59 1/2" Belt O.C.	20545620	♣K080590HD	CXU Series		
Tensioner Assy. - Fan & W.P.	20739751	38607	Belt - Fan & W.P.	20883502	K100604HD
Tensioner Assy. - Alt.; W/A.C.; W/62 7/8" Belt O.C.	21454379	38671	Belt - Alt. & A.C.	88GB457P630	♣K080630HD
Tensioner Assy. - Alt.; W/A.C.; W/63 5/8" Belt O.C.	20762060	38671	Tensioner Assy. - Fan	20935521	38607
Tensioner Assy. - Alt.; W/O A.C.; W/59" Belt O.C.	21454379	38671	Tensioner Assy. - Alt. & A.C.	21404578	38671
Tensioner Assy. - Alt.; W/O A.C.; W/59 1/2" Belt O.C.	20762060	38671	Mack MP7 Diesel		
Idler Pulley - Alt.; W/O A.C.	20747516	36285	CXU Series		
Hose - Upper - Rad. To Pipe	24840	≠24840	Belt - Serpentine Enhancement Kit - Alt. & A.C.; For Improved Belt Drive Design ...	21568411	ACK080623HD
Hose - Upper - Pipe To Eng.	24838	≠24838	Belt - Fan & W.P.	20883502	K100604HD
Hose - Lower - Rad. To Pipe	24840	≠24840	Belt - Alt. & A.C.; W/62 7/8" Belt O.C.	21460409	♣K080623HD
Hose - Lower - Pipe To Eng.	24840	≠24840	Belt - Alt. & A.C.; W/63 5/8" Belt O.C.	20545619	♣K080630HD
Hose - Pipe To Intercooler (Hot Side)	20550690	26201	Tensioner Assy. - Fan	20935521	38607
			Tensioner Assy. - Alt. & A.C.; W/62 7/8" Belt O.C.	21454379	38671
			Tensioner Assy. - Alt. & A.C.; W/63 5/8" Belt O.C.	20762060	38671
			Hose - Upper - Pipe To Eng.	20762060	38671
			Hose - Lower	20762060	22714
			Hose - Lower	20762060	23563
			GU Series		
			Belt - Serpentine Enhancement Kit - Alt. & A.C.; For Improved Belt Drive Design ...	21568411	ACK080623HD

 Medium & Heavy-Duty Trucks
(2001 & Newer)

≠Cut to Fit.

♣Standard Belt Available.

Belts and Coolant Hose for Medium/Heavy-Duty Trucks (2001 & Newer)

Medium & Heavy-Duty Trucks
(2001 & Newer)

Application	Mfr. Part No.	Our No.	Application	Mfr. Part No.	Our No.
Mack - Continued			Mack - Continued		
2009 - Continued			2009 - Continued		
Mack MP7 Diesel - Continued			Mack MP8 Diesel - Continued		
GU Series - Continued			CHU Series - Continued		
Belt - Serpentine Enhancement Kit - Alt.; W/O A.C.; For Improved Belt Drive Design	21568412	ACK080585HD	Belt - Fan & W.P.	20886339	K120786HD
Belt - Fan; W/74 1/2" Belt O.C.	20887407	▲K100739HD	Belt - A.C. & Alt.	20582552	▲K080630HD
Belt - Fan; W/75" Belt O.C.	20885394	K100745HD	Tensioner Assy. - Alt. & A.C.	21454379	38671
Belt - Alt.; W/A.C.	88GB457P630	▲K080630HD	Tensioner Assy. - Fan	20860873	38633
Belt - Alt.; W/O A.C.	21556636	▲K080585HD	CXU Series		
Tensioner Assy. - Alt. & A.C.	21454379	38671	Belt - Serpentine Enhancement Kit - Alt. & A.C.; For Improved Belt Drive Design ...	21568414	ACK080630HD
Tensioner Assy. - Fan	20935521	38607	Belt - A.C. & Alt.	20582552	▲K080630HD
Idler Pulley - Smooth	20953521	36286	Tensioner Assy. - Alt. & A.C.	21454379	38671
Idler Pulley - Alt.; W/O A.C.	20747516	36285	Tensioner Assy. - Fan	20860873	38633
Hose - Upper - Eng. To Pipe		22714	Hose - Upper - Rad. To Pipe		23564
LEU Series			Hose - Upper - Pipe To Eng.		≈22714
Belt - Serpentine Enhancement Kit - Alt. & A.C.; For Improved Belt Drive Design ...	21568411	ACK080623HD	Hose - Lower		≈23563
Belt - Serpentine Enhancement Kit - Alt.; W/O A.C.; For Improved Belt Drive Design	21568412	ACK080585HD	Hose - Turbo To Pipe (Hot Side)	20550690	26201
Belt - Fan & W.P.	88GB456P671	▲K100670HD	Hose - Pipe To Intercooler (Hot Side)	20550690	26201
Belt - Alt.; W/A.C.; W/62 7/8" Belt O.C.	21460409	▲K080623HD	GU Series		
Belt - Alt.; W/A.C.; W/63 5/8" Belt O.C.	20545619	▲K080630HD	Belt - Serpentine Enhancement Kit - Alt. & A.C.; For Improved Belt Drive Design ...	21568414	ACK080630HD
Belt - Alt.; W/O A.C.; W/59" Belt O.C.	21556636	▲K080585HD	Belt - Alt. & A.C.	20545619	▲K080630HD
Belt - Alt.; W/O A.C.; W/59 1/2" Belt O.C.	20545620	▲K080590HD	Belt - Fan & W.P.; W/10-Ribbed Belt	20582563	K100764HD
Tensioner Assy. - Fan & W.P.	20935521	38607	Belt - Fan & W.P.; W/12-Ribbed Belt	20886339	K120786HD
Tensioner Assy. - Alt.; W/A.C.; W/62 7/8" Belt O.C.	21454379	38671	Tensioner Assy. - Alt. & A.C.	21454379	38671
Tensioner Assy. - Alt.; W/A.C.; W/63 5/8" Belt O.C.	20762060	38671	Tensioner Assy. - Fan; W/10-Ribbed Belt ...	20487079	38632
Tensioner Assy. - Alt.; W/O A.C.; W/59" Belt O.C.	21454379	38671	Tensioner Assy. - Fan; W/12-Ribbed Belt ...	20860873	38633
Tensioner Assy. - Alt.; W/O A.C.; W/59 1/2" Belt O.C.	20762060	38671	Idler Pulley - Fan; W/Flat Idler Pulley; W/10-Ribbed Belt	20747516	36285
Idler Pulley - Alt.; W/O A.C.	20747516	36285	Hose - Upper - Eng. To Pipe		22714
Hose - Upper - Rad. To Pipe		≈24840	MRU Series		
Hose - Upper - Pipe To Eng.		≈24838	Belt - Serpentine Enhancement Kit - Alt. & A.C.; For Improved Belt Drive Design ...	21568414	ACK080630HD
Hose - Lower - Rad. To Pipe		≈24840	Hose - Turbo To Pipe (Hot Side)	20550690	26201
Hose - Lower - Pipe To Eng.		≈24840	Hose - Pipe To Intercooler (Hot Side)	20550690	26201
MRU Series			2008		
Belt - Serpentine Enhancement Kit - Alt. & A.C.; For Improved Belt Drive Design ...	21568411	ACK080623HD	Mack AMI Diesel		
Belt - Serpentine Enhancement Kit - Alt.; W/O A.C.; For Improved Belt Drive Design	21568412	ACK080585HD	CV Series		
Belt - Fan & W.P.	20927805	▲K100670HD	Belt - Fan	20870671	▲K100607HD
Belt - Alt.; W/A.C.; W/62 7/8" Belt O.C.	21460409	▲K080623HD	Tensioner Assy.	20851217	38523
Belt - Alt.; W/A.C.; W/63 5/8" Belt O.C.	20545619	▲K080630HD	Mack MP7 Diesel		
Belt - Alt.; W/O A.C.; W/59" Belt O.C.	21556636	▲K080585HD	CXU Series		
Belt - Alt.; W/O A.C.; W/59 1/2" Belt O.C. ...	20545620	▲K080590HD	Belt - Serpentine Enhancement Kit - Alt. & A.C.; For Improved Belt Drive Design ...	21568411	ACK080623HD
Tensioner Assy. - Fan & W.P.	20935521	38607	Belt - Fan & W.P.	20883502	K100604HD
Tensioner Assy. - Alt.; W/A.C.; W/62 7/8" Belt O.C.	21454379	38671	Belt - Alt. & A.C.; W/62 7/8" Belt O.C.	21460409	▲K080623HD
Tensioner Assy. - Alt.; W/A.C.; W/63 5/8" Belt O.C.	20762060	38671	Belt - Alt. & A.C.; W/63 5/8" Belt O.C.	20545619	▲K080630HD
Tensioner Assy. - Alt.; W/O A.C.; W/59" Belt O.C.	21454379	38671	Tensioner Assy. - Fan	20935521	38607
Tensioner Assy. - Alt.; W/O A.C.; W/59 1/2" Belt O.C.	20762060	38671	Tensioner Assy. - Alt. & A.C.; W/62 7/8" Belt O.C.	21454379	38671
Idler Pulley - Alt.; W/O A.C.	20747516	36285	Tensioner Assy. - Alt. & A.C.; W/63 5/8" Belt O.C.	20762060	38671
Hose - Upper - Rad. To Pipe		≈24840	Hose - Upper - Pipe To Eng.		22714
Hose - Upper - Pipe To Eng.		≈24838	Hose - Lower		23563
Hose - Lower - Rad. To Pipe		≈24840	Hose - Turbo To Pipe (Hot Side)	20550690	26201
Hose - Lower - Pipe To Eng.		≈24840	Hose - Pipe To Intercooler (Hot Side)	20550690	26201
Mack MP8 Diesel			GU Series		
CHU Series			Belt - Serpentine Enhancement Kit - Alt. & A.C.; For Improved Belt Drive Design ...	21568411	ACK080623HD
Belt - Serpentine Enhancement Kit - Alt. & A.C.; For Improved Belt Drive Design ...	21568414	ACK080630HD	Belt - Serpentine Enhancement Kit - Alt.; W/O A.C.; For Improved Belt Drive Design	21568412	ACK080585HD
			Belt - Fan	20887407	▲K100739HD
			Belt - Alt.; W/A.C.; W/62 7/8" Belt O.C.	21460409	▲K080623HD
			Belt - Alt.; W/A.C.; W/63 5/8" Belt O.C.	20545619	▲K080630HD
			Belt - Alt.; W/O A.C.; W/59" Belt O.C.	21556636	▲K080585HD
			Belt - Alt.; W/O A.C.; W/59 1/2" Belt O.C. ...	20545620	▲K080590HD

▲Standard Belt Available.

≈Cut to Fit.

Belts and Coolant Hose for Medium/Heavy-Duty Trucks (2001 & Newer)

Application	Mfr. Part No.	Our No.	Application	Mfr. Part No.	Our No.
Mack - Continued			Mack - Continued		
2008 - Continued			2008 - Continued		
Mack MP7 Diesel - Continued			Mack MP8 Diesel - Continued		
GU Series - Continued			CHU Series - Continued		
Tensioner Assy. - Fan	20935521	38607	Tensioner Assy. - Fan	20487079	38632
Tensioner Assy. - Alt.; W/A.C.; W/62 7/8" Belt O.C.	21454379	38671	Tensioner Assy. - Alt. & A.C.	20762060	38671
Tensioner Assy. - Alt.; W/A.C.; W/63 5/8" Belt O.C.	20762060	38671	Hose - Upper - Eng. To Rad.		≈21115
Tensioner Assy. - Alt.; W/O A.C.; W/59" Belt O.C.	21454379	38671	Hose - Upper - Rad. To Pipe		21891
Tensioner Assy. - Alt.; W/O A.C.; W/59 1/2" Belt O.C.	20762060	38671	CXU Series		
Idler Pulley - Smooth	20953521	36286	Belt - Serpentine Enhancement Kit - Alt. & A.C.; For Improved Belt Drive Design ...	21568414	ACK080630HD
Idler Pulley - Alt.; W/O A.C.	20747516	36285	Belt - Fan & W.P.	88GB460P640	K120640HD
Hose - Upper - Rad. To Pipe		≈24840	Belt - Alt. & A.C.	88GB457P630	▲K080630HD
LEU Series			Tensioner Assy. - Fan	20860873	38633
Belt - Serpentine Enhancement Kit - Alt. & A.C.; For Improved Belt Drive Design ...	21568411	ACK080623HD	Tensioner Assy. - Alt. & A.C.	20762060	38671
Belt - Serpentine Enhancement Kit - Alt.; W/O A.C.; For Improved Belt Drive Design	21568412	ACK080585HD	Hose - Upper - Rad. To Pipe		24076
Belt - Fan & W.P.	88GB456P671	▲K100670HD	Hose - Upper - Pipe To Eng.		24202
Belt - Alt.; W/A.C.; W/62 7/8" Belt O.C.	21460409	▲K080623HD	Hose - Lower		≈23563
Belt - Alt.; W/A.C.; W/63 5/8" Belt O.C.	20545619	▲K080630HD	Hose - Turbo To Pipe (Hot Side)	20550690	26201
Belt - Alt.; W/O A.C.; W/59" Belt O.C.	21556636	▲K080585HD	Hose - Pipe To Intercooler (Hot Side)	20550690	26201
Belt - Alt.; W/O A.C.; W/59 1/2" Belt O.C.	20545620	▲K080590HD	GU Series		
Tensioner Assy. - Fan & W.P.	20935521	38607	Belt - Serpentine Enhancement Kit - Alt. & A.C.; For Improved Belt Drive Design ...	21568414	ACK080630HD
Tensioner Assy. - Alt.; W/A.C.; W/62 7/8" Belt O.C.	21454379	38671	Belt - Fan & W.P.; W/12-Ribbed Belt	20886339	K120786HD
Tensioner Assy. - Alt.; W/A.C.; W/63 5/8" Belt O.C.	20762060	38671	Belt - Fan & W.P.; W/10-Ribbed Belt	20582563	K100764HD
Tensioner Assy. - Alt.; W/O A.C.; W/59" Belt O.C.	21454379	38671	Belt - Alt. & A.C.	88GB457P630	▲K080630HD
Tensioner Assy. - Alt.; W/O A.C.; W/59 1/2" Belt O.C.	20762060	38671	Tensioner Assy. - Fan	20487079	38632
Idler Pulley - Alt.; W/O A.C.	20747516	36285	Tensioner Assy. - Alt. & A.C.	21454379	38671
Hose - Upper - Rad. To Pipe		≈24840	Idler Pulley - Fan; W/Flat Idler Pulley	20747516	36285
Hose - Upper - Pipe To Eng.		≈24838	Hose - Upper - Eng. To Pipe		22714
Hose - Lower - Rad. To Pipe		≈24840	MRU Series		
Hose - Lower - Pipe To Eng.		≈24840	Belt - Serpentine Enhancement Kit - Alt. & A.C.; For Improved Belt Drive Design ...	21568414	ACK080630HD
MRU Series			Hose - Turbo To Pipe (Hot Side)	20550690	26201
Belt - Serpentine Enhancement Kit - Alt. & A.C.; For Improved Belt Drive Design ...	21568411	ACK080623HD	Hose - Pipe To Intercooler (Hot Side)	20550690	26201
Belt - Serpentine Enhancement Kit - Alt.; W/O A.C.; For Improved Belt Drive Design	21568412	ACK080585HD	2007		
Belt - Fan & W.P.	20927804	▲K100675HD	Cummins ISX Diesel		
Belt - Alt.; W/A.C.; W/62 7/8" Belt O.C.	21460409	▲K080623HD	CL Series		
Belt - Alt.; W/A.C.; W/63 5/8" Belt O.C.	20545619	▲K080630HD	Belt - Fan & Alt.	3100189	▲K120911HD
Belt - Alt.; W/O A.C.; W/59" Belt O.C.	21556636	▲K080585HD	Belt - Hub & A.C.	3682261	▲K060660HD
Belt - Alt.; W/O A.C.; W/59 1/2" Belt O.C.	20545620	▲K080590HD	Tensioner Assy. - Hub & A.C.	3682683	38610
Tensioner Assy. - Fan & W.P.	20739751	38607	Tensioner Assy. - Fan & Alt.	3682946	38587
Tensioner Assy. - Alt.; W/A.C.; W/62 7/8" Belt O.C.	21454379	38671	Idler Pulley - A.C.	3682229	36223
Tensioner Assy. - Alt.; W/A.C.; W/63 5/8" Belt O.C.	20762060	38671	Tensioner Pulley - Fan & Alt.	3682946	36165
Tensioner Assy. - Alt.; W/O A.C.; W/59" Belt O.C.	21454379	38671	Hose - Upper - Eng. To Pipe		24240
Tensioner Assy. - Alt.; W/O A.C.; W/59 1/2" Belt O.C.	20762060	38671	Hose - Upper - Rad. To Pipe		24240
Idler Pulley - Alt.; W/O A.C.	20747516	36285	Hose - Lower - Eng. To Pipe		24240
Hose - Lower - Rad. To Pipe		≈24840	Hose - Lower - Rad. To Pipe		24248
Hose - Lower - Pipe To Eng.		≈24840	Mack AC Diesel		
Hose - Pipe To Intercooler (Hot Side)	20550690	26201	CH Series		
Mack MP8 Diesel			Belt - Alt. & A.C.	88GB450P847	▲K060849HD
CHU Series			Tensioner Assy. - Alt. & A.C.	87GB46	38589
Belt - Serpentine Enhancement Kit - Alt. & A.C.; For Improved Belt Drive Design ...	21568414	ACK080630HD	CHN Series		
Belt - Fan & W.P.	88GB460P787	K120786HD	Belt - Fan	88GB449P687	K100686HD
Belt - Alt. & A.C.	88GB457P630	▲K080630HD	Belt - Hub, Fan, Alt. & A.C.	88GB450P847	▲K060849HD
			Tensioner Assy. - Fan	87GB41	38523
			Tensioner Assy. - Hub, Fan, Alt. & A.C.	87GB46	38589
			Idler Pulley - Fan, Alt. & A.C.	786GB41BM	36167
			Tensioner Pulley - Fan	87GB41	36092
			Hose - Upper - Eng. To Pipe		24240
			Hose - Upper - Rad. To Pipe		≈21115
			Hose - Lower - Rad. To Pipe		21891
			CXN Series		
			Belt - Fan; W/Borg Warner, Horton Fan Clutch; W/1.39 To 1 Fan Ratio	88GB449P579	▲K100579HD
			Belt - Fan; W/Behr Fan Clutch; W/1.51 To 1 Fan Ratio	88GB458P565	K100564HD

Medium & Heavy-Duty Trucks (2001 & Newer)

≈Cut to Fit.

▲Standard Belt Available.

Belts and Coolant Hose for Medium/Heavy-Duty Trucks (2001 & Newer)

Medium & Heavy-Duty Trucks
(2001 & Newer)

Application	Mfr. Part No.	Our No.	Application	Mfr. Part No.	Our No.
Mack - Continued			Mack - Continued		
2007 - Continued			2007 - Continued		
Mack AC Diesel - Continued			Mack MP7 Diesel - Continued		
CXN Series - Continued			CTP Series - Continued		
Belt - Fan, Alt. & A.C.; W/Borg Warner, Horton Fan Clutch	88GB453P746	♣K060747HD	Tensioner Assy. - Alt. & A.C.; W/63 5/8" Belt O.C.	20762060	38671
Belt - Fan, Alt. & A.C.; W/Behr Fan Clutch ..	88GB459P738	♣K060739HD	Tensioner Assy. - Alt. & A.C.; W/62 7/8" Belt O.C.	21454379	38671
Tensioner Assy. - Fan	87GB41A	38523	Hose - Upper - Eng. To Pipe		≈<24238
Tensioner Assy. - Fan, Alt. & A.C.	87GB46A	38589	Hose - Upper - Rad. To Pipe		≈<21891
Idler Pulley - Fan, Alt. & A.C.	786GB41BM	36167	Hose - Lower - Eng. To Pipe		≈<21891
Tensioner Pulley - Fan	87GB41A	36092	Hose - Intercooler To Pipe (Cold Side)	45MD443M	26201
Hose - Upper - Eng. To Pipe		24236	Hose - Pipe To Engine (Cold Side)	5MD4456M	26201
Hose - Upper - Rad. To Pipe		≈<21115	Hose - Turbo To Pipe (Hot Side)	45MD442M	26201
Hose - Lower - Rad. To Pipe		≈<21115	Hose - Pipe To Intercooler (Hot Side)	45MD442M	26201
Mack AI Diesel			CXP Series		
CT Series			Belt - Fan		
Belt - Fan; W/Horton Fan Clutch; W/1.56 To 1 Fan Ratio	88GB449P657	♣K100658HD	Belt - Alt. & A.C.	88GB457P630	♣K080630HD
Belt - Fan; W/Behr Fan Clutch; W/1.68 To 1 Fan Ratio	87GB458P650	K100649HD	Tensioner Assy. - Fan	20739751	38607
Belt - Fan, Alt. & A.C.; W/Behr Fan Clutch; W/1.56 To 1 Fan Ratio	88GB450P831	♣K060832HD	Tensioner Assy. - Alt. & A.C.	20762060	38671
Belt - Fan, Alt. & A.C.; W/Behr Fan Clutch; W/1.68 To 1 Fan Ratio	88GB459P825	♣K060828HD	Hose - Upper - Eng. To Pipe		24240
Tensioner Assy. - Fan	87GB45A	38611	Hose - Upper - Rad. To Pipe		≈<21115
Tensioner Assy. - Hub, Fan, Alt. & A.C.	87GB46A	38589	Hose - Lower - Rad. To Pipe		≈<21115
Idler Pulley - Fan, Alt. & A.C.	786GB41BM	36167	GU Series		
Tensioner Pulley	87GB45A	36092	Belt - Fan	88GB458P605	♣K100607HD
Hose - Upper - Eng. To Pipe		24240	Belt - Alt. & A.C.	88GB450P831	♣K060832HD
Hose - Upper - Rad. To Pipe		≈<21115	Tensioner Assy. - Fan	87GB41C	38523
Hose - Lower - Rad. To Pipe		≈<21115	Tensioner Assy. - Alt. & A.C.	87GB46A	38589
CV Series			LEU Series		
Belt - Fan; W/1.77 To 1 Fan Ratio	88GB449P605	♣K100607HD	Belt - Serpentine Enhancement Kit - Alt. & A.C.; For Improved Belt Drive Design ...	21568411	ACK080623HD
Belt - Fan; W/1.68 To 1 Fan Ratio	88GB458P661	K100661HD	Belt - Serpentine Enhancement Kit - Alt.; W/O A.C.; For Improved Belt Drive Design	21568412	ACK080585HD
Belt - Fan, Alt. & A.C.	88GB450P795	♣K060795HD	Belt - Fan & W.P.	88GB456P671	♣K100670HD
Belt - Fan & Alt.	88GB459P625	♣K060625HD	Belt - Alt.; W/A.C.; W/62 7/8" Belt O.C.	21460409	♣K080623HD
Tensioner Assy. - Fan	87GB41A	38523	Belt - Alt.; W/A.C.; W/63 5/8" Belt O.C.	20545619	♣K080630HD
Tensioner Assy. - Fan, Alt. & A.C.	87GB46A	38589	Belt - Alt.; W/O A.C.; W/59" Belt O.C.	21556636	♣K080585HD
Idler Pulley - Fan, Alt. & A.C.	786GB41BM	36167	Belt - Alt.; W/O A.C.; W/59 1/2" Belt O.C.	20545620	♣K080590HD
Tensioner Pulley - Fan	87GB41A	36092	Tensioner Assy. - Fan & W.P.	20935521	38607
Hose - Upper - Eng. To Pipe		24236	Tensioner Assy. - Alt.; W/A.C.; W/62 7/8" Belt O.C.	21454379	38671
Hose - Upper - Rad. To Pipe		24232	Tensioner Assy. - Alt.; W/A.C.; W/63 5/8" Belt O.C.	20762060	38671
Hose - Lower - Rad. To Pipe		21891	Tensioner Assy. - Alt.; W/O A.C.; W/59" Belt O.C.	21454379	38671
Hose - Lower - Pipe To Cooler		24232	Tensioner Assy. - Alt.; W/O A.C.; W/59 1/2" Belt O.C.	20762060	38671
Hose - Lower - Cooler To Pipe		24240	Idler Pulley - Alt.; W/O A.C.	20747516	36285
Mack AMI Diesel			MRU Series		
LE Series			Belt - Serpentine Enhancement Kit - Alt. & A.C.; For Improved Belt Drive Design ...		
Belt - Alt. & W.P.	88GB459P712	♣K060716HD	Belt - Serpentine Enhancement Kit - Alt.; W/O A.C.; For Improved Belt Drive Design	21568412	ACK080585HD
Belt - Fan & A.C.	88GB458P555	♣K100554HD	Belt - Fan & W.P.	20927804	♣K100675HD
Tensioner Assy. - Alt. & W.P.	87GB414AM	38668	Belt - Alt.; W/A.C.; W/62 7/8" Belt O.C.	21460409	♣K080623HD
Idler Pulley - Alt.	786GB43M	36230	Belt - Alt.; W/A.C.; W/63 5/8" Belt O.C.	20545619	♣K080630HD
Idler Pulley - A.C.	786GB41BM	36167	Belt - Alt.; W/O A.C.; W/59" Belt O.C.	21556636	♣K080585HD
MR Series			Belt - Alt.; W/O A.C.; W/59 1/2" Belt O.C.	20545620	♣K080590HD
Belt - Fan & A.C.	88GB458P555	♣K100554HD	Tensioner Assy. - Fan & W.P.	20739751	38607
Belt - Alt. & W.P.	88GB459P712	♣K060716HD	Tensioner Assy. - Alt.; W/A.C.; W/62 7/8" Belt O.C.	21454379	38671
Tensioner Assy. - Fan & A.C.	87GB47A	38599	Tensioner Assy. - Alt.; W/A.C.; W/63 5/8" Belt O.C.	20762060	38671
Tensioner Assy. - Alt. & W.P.	87GB414AM	38668	Tensioner Assy. - Alt.; W/O A.C.; W/59" Belt O.C.	21454379	38671
Idler Pulley - Fan, Alt. & A.C.	786GB41BM	36167	Mack MP7 Diesel		
Idler Pulley - A.C.	786GB41BM	36167	CTP Series		
Mack MP7 Diesel			Belt - Serpentine Enhancement Kit - Alt. & A.C.; For Improved Belt Drive Design ...		
CTP Series			Belt - Fan; W/73 5/8" Belt O.C.		
Belt - Serpentine Enhancement Kit - Alt. & A.C.; For Improved Belt Drive Design ...	21568411	ACK080623HD	Belt - Fan; W/72 3/8" Belt O.C.	88GB456P719	♣K100731HD
Belt - Fan; W/73 5/8" Belt O.C.	88GB456P730	♣K100731HD	Belt - Alt. & A.C.; W/63 5/8" Belt O.C.	88GB457P630	♣K080630HD
Belt - Fan; W/72 3/8" Belt O.C.	88GB456P719	♣K100719HD	Belt - Alt. & A.C.; W/62 7/8" Belt O.C.	21460409	♣K080623HD
Belt - Alt. & A.C.; W/63 5/8" Belt O.C.	88GB457P630	♣K080630HD	Tensioner Assy. - Fan	20739751	38607
Belt - Alt. & A.C.; W/62 7/8" Belt O.C.	21460409	♣K080623HD			
Tensioner Assy. - Fan	20739751	38607			

♣Standard Belt Available.

≈<Cut to Fit.

Belts and Coolant Hose for Medium/Heavy-Duty Trucks (2001 & Newer)

Application	Mfr. Part No.	Our No.	Application	Mfr. Part No.	Our No.
Mack - Continued			Mack - Continued		
2007 - Continued			2006 - Continued		
Mack MP7 Diesel - Continued			Mack AC Diesel - Continued		
MRU Series - Continued			CX Series - Continued		
Tensioner Assy. - Alt.; W/O A.C.; W/59 1/2" Belt O.C.	20762060	38671	Hose - Upper - Pipe To Rad.		24232
Idler Pulley - Alt.; W/O A.C.	20747516	36285	Hose - Lower - Pipe To Rad.		24232
Hose - Lower - Rad. To Pipe		≧24840	CXN Series		
Hose - Lower - Pipe To Eng.		≧24840	Belt - Fan; W/Borg Warner, Horton Fan Clutch; W/1.39 To 1 Fan Ratio	88GB449P579	♣K100579HD
Hose - Pipe To Intercooler (Hot Side)	20550690	26201	Belt - Fan; W/Behr Fan Clutch; W/1.51 To 1 Fan Ratio	88GB458P565	K100564HD
Mack MP8 Diesel			Belt - Fan, Alt. & A.C.; W/Borg Warner, Horton Fan Clutch	88GB453P746	♣K060747HD
CHU Series; CTP Series; CXP Series; CXU Series			Belt - Fan, Alt. & A.C.; W/Behr Fan Clutch ..	88GB459P738	♣K060739HD
Belt - Serpentine Enhancement Kit - Alt. & A.C.; For Improved Belt Drive Design ...	21568414	ACK080630HD	Tensioner Assy. - Fan	87GB41A	38523
Belt - Alt. & A.C.	21556637	♣K080630HD	Tensioner Assy. - Fan, Alt. & A.C.	87GB46A	38589
Tensioner Assy. - Alt. & A.C.	21454379	38671	Idler Pulley - Fan, Alt. & A.C.	786GB41BM	36167
MRU Series			Tensioner Pulley - Fan	87GB41A	36092
Belt - Serpentine Enhancement Kit - Alt. & A.C.; For Improved Belt Drive Design ...	21568414	ACK080630HD	Hose - Upper - Eng. To Pipe		24236
Belt - Alt. & A.C.	21556637	♣K080630HD	Hose - Upper - Rad. To Pipe		≧21115
Tensioner Assy. - Alt. & A.C.	21454379	38671	Hose - Lower - Rad. To Pipe		≧21115
Hose - Turbo To Pipe (Hot Side)	20550690	26201	Mack AI Diesel		
Hose - Pipe To Intercooler (Hot Side)	20550690	26201	CT Series		
2006			Belt - Fan; W/Horton Fan Clutch; W/1.56 To 1 Fan Ratio	88GB449P657	♣K100658HD
Cummins ISX Diesel			Belt - Fan; W/Behr Fan Clutch; W/1.68 To 1 Fan Ratio	87GB458P650	K100649HD
CL Series			Belt - Fan, Alt. & A.C.; W/Behr Fan Clutch; W/1.56 To 1 Fan Ratio	88GB450P831	♣K060832HD
Belt - Fan & Alt.	3100189	♣K120911HD	Belt - Fan, Alt. & A.C.; W/Behr Fan Clutch; W/1.68 To 1 Fan Ratio	88GB459P825	♣K060828HD
Belt - Hub & A.C.	3682261	♣K060660HD	Tensioner Assy. - Fan	87GB45A	38611
Tensioner Assy. - Hub & A.C.	3682683	38610	Tensioner Assy. - Fan, Alt. & A.C.	87GB46A	38589
Tensioner Assy. - Fan & Alt.	3682946	38587	Idler Pulley - Fan, Alt. & A.C.	786GB41BM	36167
Idler Pulley - A.C.	3682229	36223	Tensioner Pulley	87GB45A	36092
Tensioner Pulley - Fan & Alt.	3682946	36165	Hose - Upper - Eng. To Pipe		24240
Hose - Upper - Eng. To Pipe		24240	Hose - Upper - Rad. To Pipe		24240
Hose - Upper - Rad. To Pipe		24240	Hose - Lower - Rad. To Pipe		24248
Hose - Lower - Eng. To Pipe		24240	Mack AC Diesel		
Hose - Lower - Rad. To Pipe		24248	CH Series		
Mack AC Diesel			Belt - Fan	88GB458P678	♣K100677HD
CH Series			Belt - Fan To Alt. & A.C.	88GB459P847	K060846HD
Belt - Fan			Belt - Fan & Alt.	88GB459P670	♣K060670HD
Belt - Hub & A.C.			Tensioner Assy. - Fan	87GB41	38523
Tensioner Assy. - Hub & A.C.			Tensioner Assy. - Hub, Fan, Alt. & A.C.	87GB46	38589
Tensioner Assy. - Fan & Alt.			Idler Pulley - Fan, Alt. & A.C.	786GB41BM	36167
Idler Pulley - A.C.			Tensioner Pulley - Fan	87GB41	36092
Tensioner Pulley - Fan & Alt.			Hose - Upper - Eng. To Pipe		24232
Hose - Upper - Eng. To Pipe			Hose - Upper - Rad. To Pipe		24236
Hose - Upper - Rad. To Pipe			Hose - Lower - Rad. To Pipe		21891
Hose - Lower - Eng. To Pipe			CHN Series		
Hose - Lower - Rad. To Pipe			Belt - Fan	88GB449P687	K100686HD
Mack AC Diesel			Belt - Hub, Fan, Alt. & A.C.	88GB450P847	♣K060849HD
CH Series			Tensioner Assy. - Fan	87GB41	38523
Belt - Fan			Tensioner Assy. - Hub, Fan, Alt. & A.C.	87GB46	38589
Belt - Hub & A.C.			Idler Pulley - Fan, Alt. & A.C.	786GB41BM	36167
Tensioner Assy. - Fan			Tensioner Pulley - Fan	87GB41	36092
Tensioner Assy. - Hub, Fan, Alt. & A.C.			Hose - Upper - Eng. To Pipe		24240
Idler Pulley - Fan, Alt. & A.C.			Hose - Upper - Rad. To Pipe		≧21115
Tensioner Pulley - Fan			Hose - Lower - Rad. To Pipe		21891
Hose - Upper - Eng. To Pipe			CX Series		
Hose - Upper - Rad. To Pipe			Belt - Fan	88GB458P555	♣K100554HD
Hose - Lower - Rad. To Pipe			Belt - Fan To Alt. & A.C.	88GB459P735	♣K060735HD
CHN Series			Belt - Fan & Alt.	88GB459P585	♣K060586HD
Belt - Fan			Tensioner Assy. - Fan, Alt. & A.C.	87GB46A	38589
Belt - Hub & A.C.			Tensioner Assy. - Fan & Alt.	87GB44A	38617
Tensioner Assy. - Fan			Idler Pulley - Fan, Alt. & A.C.	786GB41BM	36167
Tensioner Assy. - Hub, Fan, Alt. & A.C.			Tensioner Pulley - Fan	87GB45A	36092
Idler Pulley - Fan, Alt. & A.C.			Hose - Upper - Eng. To Pipe		24236
Tensioner Pulley - Fan			Mack AMI Diesel		
Hose - Upper - Eng. To Pipe			CT Series		
CX Series			Belt - Fan; W/Horton Fan Clutch; W/1.44 To 1 Fan Ratio	88GB458P666	♣K100665HD
Belt - Fan			Belt - Fan; W/Behr Fan Clutch; W/1.56 To 1 Fan Ratio	88GB458P657	♣K100658HD
Belt - Fan To Alt. & A.C.			Belt - Fan, Alt. & A.C.; W/Behr Fan Clutch ..	88GB459P831	♣K060832HD
Belt - Fan & Alt.			Belt - Fan, Alt. & A.C.; W/Borg Warner, Horton Fan Clutch	88GB459P839	K060840
Tensioner Assy. - Fan, Alt. & A.C.			Belt - Fan & Alt.; W/Behr Fan Clutch	88GB459P654	♣K060653HD
Tensioner Assy. - Fan & Alt.			Belt - Fan & Alt.; W/Borg Warner, Horton Fan Clutch	88GB459P659	♣K060660HD
Idler Pulley - Fan, Alt. & A.C.					
Tensioner Pulley - Fan					
Hose - Upper - Eng. To Pipe					

Medium & Heavy-Duty Trucks
(2001 & Newer)

≧Cut to Fit.

♣Standard Belt Available.

Belts and Coolant Hose for Medium/Heavy-Duty Trucks (2001 & Newer)

Medium & Heavy-Duty Trucks
(2001 & Newer)

Application	Mfr. Part No.	Our No.	Application	Mfr. Part No.	Our No.
Mack - Continued			Mack - Continued		
2006 - Continued			2005 - Continued		
Mack AMI Diesel - Continued			Mack AC Diesel - Continued		
CT Series - Continued			CX Series - Continued		
Tensioner Assy. - Fan	87GB45A	38611	Belt - Fan To Alt. & A.C.	88GB450P735	♣K060735HD
Tensioner Assy. - Fan, Alt. & A.C.	87GB46A	38589	Belt - Fan & Alt.	88GB459P585	♣K060586HD
Idler Pulley - Fan, Alt. & A.C.	786GB41BM	36167	Tensioner Assy. - Fan	87GB45	38611
Tensioner Pulley	87GB45A	36092	Tensioner Assy. - Fan, Alt. & A.C.	87GB46	38589
CV Series			Idler Pulley - Fan, Alt. & A.C.		
Belt - Fan; W/Horton Fan Clutch	88GB458P615	K100615HD	Tensioner Pulley - Fan	87GB45	36092
Belt - Fan, Alt. & A.C.	88GB459P795	♣K060795HD	Hose - Upper - Eng. To Pipe		24236
Belt - Fan & Alt.	88GB459P625	♣K060625HD	Hose - Upper - Pipe To Rad.		24232
Tensioner Assy. - Fan	87GB41C	38523	Hose - Lower - Pipe To Rad.		24232
Tensioner Assy. - Fan, Alt. & A.C.	87GB414M	38668	CXN Series		
Idler Pulley - Fan, Alt. & A.C.	786GB41BM	36167	Belt - Fan, A.C., Alt. & W.P.	88GB453P746	♣K060747HD
Tensioner Pulley - Fan	87GB41C	36092	Belt - Fan	88GB449P579	♣K100579HD
MR Series			Tensioner Assy. - Fan, A.C., Alt. & W.P.		
Belt - Fan	88GB458P555	♣K100554HD	Tensioner Assy. - Fan	87GB46A	38589
Belt - Fan, Alt. & A.C.	88GB459P716	♣K060716HD	Tensioner Assy. - Fan	87GB45A	38611
Tensioner Assy. - Fan, Alt. & A.C.	87GB47A	38599	Idler Pulley - Fan, A.C., Alt. & W.P.	786GB41BM	36167
Idler Pulley - Fan, Alt. & A.C.	786GB41BM	36167	Hose - Upper - Rad. To Pipe		≈<21115
Mack MP7 Diesel			Hose - Upper - Pipe To Eng.		
CXP Series			Hose - Lower - Rad. To Pipe		
Belt - Fan & Hub	88GB456P660	K100661HD	Mack AI Diesel		
Belt - Alt. & A.C.	88GB457P630	♣K080630HD	CV Series		
Tensioner Assy. - Fan & Hub	87GB46A	38589	Belt - Fan	20870671	♣K100607HD
Tensioner Assy. - Alt. & A.C.	87GB41A	38523	Tensioner Assy. - Fan	87GB41	38523
Hose - Upper - Eng. To Pipe		24240	Tensioner Pulley - Fan	87GB41	36092
Hose - Upper - Rad. To Pipe		24240	LE Series		
Hose - Lower - Eng. To Pipe		21891	Belt - Fan	88GB447P610	♣K100610HD
Hose - Lower - Rad. To Pipe		21891	Belt - Fan, Alt. & A.C.	88GB459P712	♣K060716HD
2005			Belt - A.C.	88GB439P396	♣9395HD
Cummins ISX Diesel			Tensioner Assy. - Fan, Alt. & A.C.	87GB47A	38599
CL Series			Tensioner Assy. - Fan & Alt.	87GB41	38523
Belt - Fan & Alt.	3100189	♣K120911HD	Idler Pulley - Fan, Alt. & A.C.	786GB41BM	36167
Belt - Hub & A.C.	3682261	♣K060660HD	Tensioner Pulley - Fan & Alt.	87GB41	36092
Tensioner Assy. - Hub & A.C.	3682683	38610	MR Series		
Tensioner Assy. - Fan & Alt.	3682946	38587	Belt - Fan	88GB458P555	♣K100554HD
Idler Pulley - A.C.	3682229	36223	Belt - W.P., Alt. & A.C.	88GB459P712	♣K060716HD
Tensioner Pulley - Fan & Alt.	3682946	36165	Tensioner Assy. - Fan	21291243	38668
Hose - Upper - Eng. To Pipe		24240	Tensioner Assy. - W.P., Alt. & A.C.	87GB47A	38599
Hose - Upper - Rad. To Pipe		24240	Mack AMI Diesel		
Hose - Lower - Eng. To Pipe		24240	CT Series		
Hose - Lower - Rad. To Pipe		24248	Belt - Fan	88GB449P657	♣K100658HD
Mack AC Diesel			Belt - Alt. & A.C.	88GB450P831	♣K060832HD
CH Series			Tensioner Assy. - Fan	87GB41	38523
Belt - Fan	88GB449P678	♣K100677HD	Tensioner Assy. - Alt. & A.C.	87GB46	38589
Belt - Hub, Fan, Alt. & A.C.	88GB459P847	K060846HD	Tensioner Pulley - Fan		38076
Belt - Fan, Alt. & Hub	88GB459P670	♣K060672HD	Hose - Upper - Rad. To Pipe		≈<21891
Tensioner Assy. - Fan	87GB41	38523	Hose - Upper - Pipe To Eng.		≈<24236
Tensioner Assy. - Hub, Fan, Alt. & A.C.	87GB46	38589	CV Series		
Idler Pulley - Fan, Alt. & A.C.	786GB41BM	36167	Belt - Fan	88GB449P605	♣K100607HD
Tensioner Pulley - Fan	87GB41	36092	Belt - Fan, Alt. & A.C.	88GB450P795	♣K060795HD
Hose - Upper - Eng. To Pipe		24232	Tensioner Assy. - Fan	87GB41	38523
Hose - Upper - Rad. To Pipe		24236	Tensioner Assy. - Fan, Alt. & A.C.	87GB46	38589
Hose - Lower - Rad. To Pipe		21891	Idler Pulley - Fan, Alt. & A.C.	786GB41BM	36167
CHN Series			Tensioner Pulley - Fan	87GB41	36092
Belt - Fan	88GB449P687	K100686HD	Hose - Upper - Eng. To Pipe		24236
Belt - Alt. & A.C.	88GB453P847	♣K060849HD	Hose - Upper - Rad. To Pipe		24232
Tensioner Assy. - Fan	87GB41C	38523	Hose - Lower - Rad. To Pipe		21891
Tensioner Assy. - Alt. & A.C.	87GB46	38589	Hose - Lower - Pipe To Cooler		24232
Hose - Upper - Rad. To Pipe		28212	Hose - Lower - Cooler To Pipe		24240
Hose - Upper - Pipe To Eng.		≈<24836	MR Series		
Hose - Lower		24840	Belt - Fan	88GB458P555	♣K100554HD
CX Series			Belt - W.P., Alt. & A.C.	88GB450P716	♣K060716HD
Belt - Fan	88GB449P555	♣K100554HD	Tensioner Assy. - Fan	87GB47A	38599
			Tensioner Assy. - W.P., Alt. & A.C.	87GB46	38589

♣Standard Belt Available.

≈<Cut to Fit.

Belts and Coolant Hose for Medium/Heavy-Duty Trucks (2001 & Newer)

Application	Mfr. Part No.	Our No.	Application	Mfr. Part No.	Our No.
Mack - Continued			Mack - Continued		
2004			2003 - Continued		
Cummins ISX Diesel			Cummins Signature 600 Diesel - Continued		
CL Series			CH Series; CL Series - Continued		
Belt - Fan & Alt.	3100189	▲K120911HD	Tensioner Assy. - Fan	3681240	38535
Belt - Hub & A.C.	3682261	▲K060660HD	Tensioner Assy. - Hub, Alt. & A.C.	3680194	38532
Tensioner Assy. - Hub & A.C.	3682683	38610	Idler Pulley - Alt. & A.C.	4026886	36226
Tensioner Assy. - Fan & Alt.	3682946	38587	Tensioner Pulley - Fan	3681240	36092
Idler Pulley - A.C.	3682229	36223	Tensioner Pulley - Hub, Alt. & A.C.	3680194	36095
Tensioner Pulley - Fan & Alt.	3682946	36165	Hose - Upper - Eng. To Pipe		24240
Hose - Upper - Eng. To Pipe		24240	Hose - Upper - Pipe To Rad.		24240
Hose - Upper - Rad. To Pipe		24240	Hose - Lower - Eng. To Pipe		24240
Hose - Lower - Eng. To Pipe		24240	Hose - Lower - Pipe To Rad.		24248
Hose - Lower - Rad. To Pipe		24248			
Mack AC Diesel			Mack AC Diesel		
CH Series			CH Series		
Belt - Fan	88GB449P678	▲K100677HD	Belt - Fan	88GB449P678	▲K100677HD
Belt - Hub, Fan, Alt. & A.C.	88GB450P847	▲K060849HD	Belt - Hub, Fan, Alt. & A.C.	88GB450P847	▲K060849HD
Belt - Fan, Alt. & W.P.	88GB459P670	▲K060670HD	Belt - Fan, Alt. & W.P.	88GB459P670	▲K060670HD
Tensioner Assy. - Fan	87GB41	38523	Tensioner Assy. - Fan	87GB41	38523
Tensioner Assy. - Hub, Fan, Alt. & A.C.	87GB46	38589	Tensioner Assy. - Hub, Fan, Alt. & A.C.	87GB46	38589
Idler Pulley - Fan, Alt. & A.C.	786GB41BM	36167	Idler Pulley - Fan, Alt. & A.C.	786GB41BM	36167
Tensioner Pulley - Fan	87GB41	36092	Tensioner Pulley - Fan	87GB41	36092
Hose - Upper - Eng. To Pipe		24232	Hose - Upper - Eng. To Pipe		24232
Hose - Upper - Rad. To Pipe		24236	Hose - Upper - Rad. To Pipe		24236
Hose - Lower - Rad. To Pipe		21891	Hose - Lower - Rad. To Pipe		21891
CX Series			CS Series		
Belt - Fan	88GB449P555	▲K100554HD	Belt - Fan & Alt.	88GB447P660	▲K100658HD
Belt - Fan, Alt. & A.C.	88GB450P735	▲K060735HD	Belt - Fan To A.C.	88GB439P502	▲9500HD
Tensioner Assy. - Fan	87GB45	38611	Tensioner Assy. - Fan & Alt.	87GB41	38523
Tensioner Assy. - Fan, Alt. & A.C.	87GB46	38589	Tensioner Pulley - Fan & Alt.	87GB41	36092
Idler Pulley - Fan, Alt. & A.C.	786GB41BM	36167	Hose - Upper - Eng. To Pipe		22322
Tensioner Pulley - Fan	87GB45	36092	Hose - Upper - Pipe To Rad.		24232
Hose - Upper - Eng. To Pipe		≧24236	Hose - Lower - Pipe To Rad.		24240
Hose - Upper - Pipe To Rad.		≧24232			
Hose - Lower - Pipe To Rad.		≧24232	CX Series		
			Belt - Fan	88GB449P555	▲K100554HD
Mack AI Diesel			Belt - Fan, Alt. & A.C.	88GB450P735	▲K060735HD
LE Series			Tensioner Assy. - Fan	87GB45	38611
Belt - Fan	88GB447P610	▲K100610HD	Tensioner Assy. - Fan, Alt. & A.C.	87GB46	38589
Tensioner Assy. - Fan & Alt.	87GB41	38523	Idler Pulley - Fan, Alt. & A.C.	786GB41BM	36167
Tensioner Assy.	87GB47A	38599	Tensioner Pulley - Fan	87GB45	36092
Tensioner Pulley - Fan & Alt.	87GB41	36092	Hose - Upper - Eng. To Pipe		24236
Mack AMI Diesel			Hose - Upper - Pipe To Rad.		24232
CV Series			Hose - Lower - Pipe To Rad.		24232
Belt - Fan	88GB449P605	▲K100607HD	Mack AI Diesel		
Belt - Fan, Alt. & A.C.	88GB450P795	▲K060795HD	CV Series		
Tensioner Assy. - Fan	87GB41	38523	Belt - Fan & Alt.	88GB447P660	▲K100658HD
Tensioner Assy. - Fan, Alt. & A.C.	87GB46	38589	Belt - Fan To A.C.	88GB439P502	▲9500HD
Idler Pulley - Fan, Alt. & A.C.	786GB41BM	36167	Tensioner Assy. - Fan & Alt.	87GB41	38523
Tensioner Pulley - Fan	87GB41	36092	Tensioner Pulley - Fan & Alt.	87GB41	36092
Hose - Upper - Eng. To Pipe		24236	Hose - Upper - Eng. To Pipe		24232
Hose - Upper - Rad. To Pipe		24232	Hose - Upper - Rad. To Pipe		24232
Hose - Lower - Rad. To Pipe		21891	Hose - Lower - Rad. To Pipe		24240
Hose - Lower - Pipe To Cooler		24232	LE Series		
Hose - Lower - Cooler To Pipe		24240	Belt - Fan	88GB447P610	▲K100610HD
MR Series			Tensioner Assy. - Fan & Alt.	87GB41	38523
Belt - Fan	88GB458P555	▲K100554HD	Tensioner Pulley - Fan & Alt.	87GB41	36092
Belt - W.P., Alt. & A.C.	88GB450P716	▲K060716HD	Mack AMI Diesel		
Tensioner Assy. - Fan	21291243	38668	CV Series		
Tensioner Assy. - W.P., Alt. & A.C.	87GB46	38589	Belt - Fan & Alt.	88GB447P666	▲K100665HD
Idler Pulley - Fan, Alt. & A.C.	786GB41BM	36167	Belt - Fan To A.C.	88GB439P502	▲9500HD
			Tensioner Assy. - Fan & Alt.	87GB41	38523
2003			Tensioner Pulley - Fan & Alt.	87GB41	36092
Cummins Signature 600 Diesel			Hose - Upper - Eng. To Pipe		24232
CH Series; CL Series			Hose - Upper - Pipe To Rad.		24232
Belt - Fan	3681811	▲K100710HD	Hose - Lower - Pipe To Rad.		21194
Belt - Hub, Alt. & A.C.	3681812	▲K060685HD	MR Series		
			Belt - Fan	88GB458P555	▲K100554HD

▲Standard Belt Available.

≧Cut to Fit.

Medium & Heavy-Duty Trucks (2001 & Newer)

Belts and Coolant Hose for Medium/Heavy-Duty Trucks (2001 & Newer)

 Medium & Heavy-Duty Trucks
(2001 & Newer)

Application	Mfr. Part No.	Our No.	Application	Mfr. Part No.	Our No.
Mack - Continued			Mack - Continued		
2003 - Continued			2002 - Continued		
Mack AMI Diesel - Continued			Mack 6-Cyl. 12.0 L Diesel - Continued		
MR Series - Continued			LE Series - Continued		
Belt - W.P., Alt. & A.C.	88GB450P716	♣K060716HD	Belt - A.C.	88GB439P386	♣9390HD
Tensioner Assy. - Fan	87GB47A	38599	MR Series		
Tensioner Assy. - W.P., Alt. & A.C.	87GB46	38589	Belt - Fan & Alt.	88GB449P605	♣K100607HD
Idler Pulley - Fan, Alt. & A.C.	786GB41BM	36167	Belt - Fan To A.C.	88GB439P386	♣9390HD
Mack E7 Diesel			Tensioner Assy. - Fan & Alt.	87GB41	38523
MR Series			Tensioner Pulley - Fan & Alt.	87GB41	36092
Belt - Fan	88GB449P555	♣K100554HD	Hose - Upper - Eng. To Pipe		24232
Belt - Alt.	88GB450P712	♣K060716HD	Hose - Upper - Pipe To Rad.		24232
Belt - A.C.	88GB439P396	♣9395HD	Hose - Lower - Eng. To Pipe		24240
Tensioner Assy. - Fan	87GB45A	38611	Hose - Lower - Pipe To Rad.		24240
RD Series			RD Series		
Belt - Fan	88GB449P655	♣K100655HD	Belt - Fan & Alt.	88GB449P655	♣K100655HD
Belt - A.C.	88GB439P431	♣9430HD	Belt - Fan To A.C.	88GB439P431	♣9430HD
Tensioner Assy. - Fan	87GB41	38523	Tensioner Assy. - Fan & Alt.	87GB41	38523
Tensioner Pulley - Fan	87GB41	36092	Tensioner Pulley - Fan & Alt.	87GB41	36092
2002			2001		
Cummins Signature 600 Diesel			Cummins Signature 600 Diesel		
CH Series; CL Series			CH Series; CL Series		
Belt - Fan	3681811	♣K100710HD	Belt - Fan	3681811	♣K100710HD
Belt - Hub, Alt. & A.C.	3681812	♣K060685HD	Belt - Hub, Alt. & A.C.	3681812	♣K060685HD
Tensioner Assy. - Fan	3681240	38535	Tensioner Assy. - Fan	3681240	38535
Tensioner Assy. - Hub, Alt. & A.C.	3680194	38532	Tensioner Assy. - Hub, Alt. & A.C.	3680194	38532
Idler Pulley - Alt. & A.C.	4026886	36226	Idler Pulley - Alt. & A.C.	4026886	36226
Tensioner Pulley - Fan	3681240	36092	Tensioner Pulley - Fan	3681240	36092
Tensioner Pulley - Hub, Alt. & A.C.	3680194	36095	Tensioner Pulley - Hub, Alt. & A.C.	3680194	36095
Hose - Upper - Eng. To Pipe		24240	Hose - Upper - Eng. To Pipe		24240
Hose - Upper - Pipe To Rad.		24240	Hose - Upper - Pipe To Rad.		24240
Hose - Lower - Eng. To Pipe		24240	Hose - Lower - Eng. To Pipe		24240
Hose - Lower - Pipe To Rad.		24248	Hose - Lower - Pipe To Rad.		24248
Mack 6-Cyl. 12.0 L Diesel			Mack 6-Cyl. 12.0 L Diesel		
CH Series			CH Series		
Belt - Fan & Alt.	88GB447P732	♣K100731HD	Belt - Fan & Alt.	88GB447P732	♣K100731HD
Belt - Fan & A.C.	88GB439P506	♣9505HD	Belt - Fan & A.C.	88GB439P506	♣9505HD
Tensioner Assy. - Fan & Alt.	87GB41	38523	Tensioner Assy. - Fan & Alt.	87GB41	38523
Tensioner Pulley - Fan & Alt.	87GB41	36092	Tensioner Pulley - Fan & Alt.	87GB41	36092
Hose - Upper - Pipe To Rad.		24232	Hose - Upper - Pipe To Rad.		24232
Hose - Upper - Eng. To Pipe		24232	Hose - Upper - Eng. To Pipe		24232
Hose - Lower - Eng. To Pipe		24240	Hose - Lower - Eng. To Pipe		24240
Hose - Lower - Pipe To Rad.		≈21891	Hose - Lower - Pipe To Rad.		≈21891
CV Series			CL Series		
Belt - Fan & Alt.	88GB447P655	♣K100655HD	Belt - Fan & Alt.	88GB447P655	♣K100655HD
Belt - Fan To A.C.	88GB439P502	♣9500HD	Belt - Fan & A.C.	88GB439P431	♣9430HD
Tensioner Assy. - Fan & Alt.	87GB41	38523	Tensioner Assy. - Fan & Alt.	87GB41	38523
Tensioner Pulley - Fan & Alt.	87GB41	36092	Tensioner Pulley - Fan & Alt.	87GB41	36092
Hose - Upper - Eng. To Pipe		24232	Hose - Lower - Eng. To Pipe		24240
Hose - Upper - Pipe To Rad.		24232	Hose - Lower - Pipe To Eng.		24240
Hose - Lower - Eng. To Pipe		21194	CV Series		
Hose - Lower - Pipe To Rad.		24240	Belt - Fan & Alt.	88GB447P655	♣K100655HD
CX Series			Belt - Fan To A.C.	88GB439P502	♣9500HD
Belt - Fan & Alt.	88GB449P605	♣K100607HD	Tensioner Assy. - Fan & Alt.	87GB41	38523
Belt - Fan To Compr.	88GB439P491	♣9490HD	Tensioner Pulley - Fan & Alt.	87GB41	36092
Tensioner Assy. - Fan & Alt.	87GB41	38523	Hose - Upper - Eng. To Pipe		24232
Tensioner Pulley - Fan & Alt.	87GB41	36092	Hose - Upper - Pipe To Rad.		24232
Hose - Upper - Eng. To Pipe		24232	Hose - Lower - Eng. To Pipe		21194
Hose - Upper - Pipe To Rad.		24232	Hose - Lower - Pipe To Rad.		24240
Hose - Lower - Pipe To Rad.		24232	CX Series		
DM Series			Belt - Fan & Alt.	88GB447P666	♣K100665HD
Belt - Fan & Alt.	88GB447P655	♣K100655HD	Belt - Fan To Compr.	88GB439P491	♣9490HD
Belt - A.C.	88GB439P502	♣9500HD	Tensioner Assy. - Fan & Alt.	87GB41	38523
Tensioner Assy. - Fan & Alt.	87GB41	38523	Tensioner Pulley - Fan & Alt.	87GB41	36092
LE Series			Hose - Upper - Eng. To Pipe		24232
Belt - Fan & Alt.	88GB447P610	♣K100610HD	Hose - Upper - Pipe To Rad.		24232
			Hose - Lower - Eng. To Pipe		24240

♣Standard Belt Available.

≈Cut to Fit.

Belts and Coolant Hose for Medium/Heavy-Duty Trucks (2001 & Newer)

Application	Mfr. Part No.	Our No.	Application	Mfr. Part No.	Our No.
Mack - Continued			Mitsubishi Fuso - Continued		
2001 - Continued			2006 - Continued		
Mack 6-Cyl. 12.0 L Diesel - Continued			Mitsubishi Fuso 6M60 Diesel		
CX Series - Continued			FK; FM		
Hose - Lower - Pipe To Rad.		24232	Belt - Fan & Alt.	ME300899	TR22455
DM Series			Belt - A.C.	MPMF6395	▲9405HD
Belt - Fan & Alt.	88GB447P655	▲K100655HD	2005		
Belt - Fan & A.C.	88GB439P431	▲9430HD	Mitsubishi Fuso 4M50 Diesel		
Tensioner Assy. - Fan & Alt.	87GB41	38523	FE; FG		
Tensioner Pulley - Fan & Alt.	87GB41	36092	Belt - Fan, Alt. & A.C.	ME241670	▲K060480HD
Hose - Upper - Eng. To Pipe		24240	Hose - Upper - Eng. To Rad.		≡<20957
Hose - Upper - Pipe To Rad.		24240	FH		
Hose - Lower - Eng. To Pipe		24240	Belt - Fan, Alt. & A.C.	ME241666	▲K060495HD
Hose - Lower - Pipe To Eng.		21891	Hose - Upper - Eng. To Rad.		≡<20957
LE Series			Mitsubishi Fuso 6M60 Diesel		
Belt - A.C.	88GB439P386	▲9390HD	FK; FM		
Belt - Fan & Alt.	88GB447P610	▲K100610HD	Belt - Fan & Alt.	ME300899	TR22455
MR Series			Belt - A.C.	MPMF6395	▲9405HD
Belt - Fan & Alt.	88GB447P605	▲K100607HD	2004 - 2003		
Belt - Fan To A.C.	88GB439P386	▲9390HD	Mitsubishi Fuso 4D34 Diesel		
Tensioner Assy. - Fan & Alt.	87GB41	38523	FE; FG		
Tensioner Pulley - Fan & Alt.	87GB41	36092	Belt - Fan & Alt.	MH014094	▲9465HD
Hose - Upper - Eng. To Pipe		24232	Belt - A.C.	MPMF6560	▲9570HD
Hose - Upper - Pipe To Rad.		24232	Mitsubishi Fuso 4M50 Diesel		
Hose - Lower - Eng. To Pipe		24240	FE		
Hose - Lower - Pipe To Rad.		24240	Belt - Fan, Alt. & A.C.	ME241670	▲K060480HD
RD Series			Hose - Upper - Eng. To Rad.		≡<20957
Belt - Fan & Alt.	88GB447P655	▲K100655HD	FH		
Belt - Fan & A.C.	88GB439P431	▲9430HD	Belt - Fan, Alt. & A.C.	ME241666	▲K060495HD
Tensioner Assy. - Fan & Alt.	87GB41	38523	Hose - Upper - Eng. To Rad.		≡<20611
Tensioner Pulley - Fan & Alt.	87GB41	36092	Mitsubishi Fuso 6D16 Diesel		
Hose - Upper - Eng. To Pipe		24232	FK; FM		
Hose - Upper - Pipe To Rad.		24232	Belt - Fan & Alt.		②TR22416
Hose - Lower - Eng. To Pipe		24240	Belt - A.C.	MPMF6390	▲9400HD
Hose - Lower - Pipe To Rad.		24240	Hose - Upper - Eng. To Rad.		≡<21379
Renault 6-Cyl. 6.2 L Diesel			2002 - 2001		
CS Series			Mitsubishi Fuso 4D34 Diesel		
Belt - W.P. & Alt.; W/49 1/2" Belt O.C.	10X1250	7490	FE; FG		
Belt - W.P. & Alt.; W/51 1/2" Belt O.C.	5000686853	7512	Belt - Fan & Alt.	MH014094	▲9465HD
Belt - Air Compr.; W/48" Belt O.C.	AV131205	▲9476HD	Belt - A.C.	MPMF6560	▲9570HD
Belt - Air Compr.; W/49 1/2" Belt O.C.		▲9490HD	Mitsubishi Fuso 4M50 Diesel		
Mitsubishi Fuso			FE		
2008			Belt - W.P., Alt. & A.C.		
Mitsubishi Fuso 4M50 Diesel			ME241666		
FE			▲K060495HD		
Belt - Fan, Alt. & A.C.	ME241670	▲K060480HD	Hose - Upper - Eng. To Rad.		
2007			≡<20611		
Mitsubishi Fuso 4M50 Diesel			Mitsubishi Fuso 6D16 Diesel		
FE; FG			FK; FM		
Belt - Fan, Alt. & A.C.	ME241670	▲K060480HD	Belt - Fan & Alt.		②TR22416
Hose - Upper - Eng. To Rad.		≡<20957	Belt - A.C.	MPMF6390	▲9400HD
Mitsubishi Fuso 6M60 Diesel			Hose - Upper - Eng. To Rad.		≡<21379
FM			Mitsubishi Fuso 6D34 Diesel		
Belt - A.C.	MH014448	▲9395HD	FH		
Belt - Fan, Alt. & W.P.	ME300899	TR22455	Belt - Fan & Alt.	MH014379	▲9476HD
2006			Belt - A.C.	MPMF6580	7590
Mitsubishi Fuso 4M50 Diesel			Oshkosh		
FE; FG			2007 - 2006		
Belt - Fan, Alt. & A.C.	ME241670	▲K060480HD	Cummins ISM Diesel		
Hose - Upper - Eng. To Rad.		≡<20957	S Series Mixers		
			Belt - Serpentine		
			3102942		
			▲K080872HD		
			Tensioner Assy.		
			3400885		
			38521		

▲Standard Belt Available.
②Two Required.

≡<Cut to Fit.

Medium & Heavy-Duty Trucks
(2001 & Newer)

Belts and Coolant Hose for Medium/Heavy-Duty Trucks (2001 & Newer)

Medium & Heavy-Duty Trucks
(2001 & Newer)

Application	Mfr. Part No.	Our No.	Application	Mfr. Part No.	Our No.
Oshkosh - Continued			Peterbilt - Continued		
2007 - 2006 - Continued			2014		
Cummins ISM Diesel - Continued			Cummins ISL9 Diesel		
S Series Mixers - Continued			365		
Idler Pulley	3400883	36308	Belt - Fan	3972376	K080852HD
Peterbilt			Tensioner Assy.	3973819	38627
2015			Idler Pulley	3970945	36283
Cummins ISX12 Diesel			Hose - Upper - Rad. To Pipe		28359
320			Hose - Upper - Pipe To Eng.		≈<24836
Tensioner Assy.	4299053	38569	Hose - Lower - Rad. To Pipe		28212
Cummins ISX15 Diesel			Hose - Lower - Pipe To Eng.		≈<24836
367			Hose - Suction - Tank To Pump	M50603474320550	DEF7022
Belt - Serpentine - Fan	6122180	♣K120858HD	Hose - Return - Pump To Tank	M50603474110550	DEF7020
Belt - Serpentine - A.C.	6061620	♣K060637HD	Hose - Pressure - Pump To Injector; W/800mm Line	M50603371230800	DEF7000
Tensioner Assy. - Fan	4299051	38587	Hose - Turbo To Pipe (Hot Side)	D506039	26203
Tensioner Assy. - A.C.	3690067	38610	Hose - Pipe To Intercooler (Hot Side)	D506039	26203
Idler Pulley	3689465	36223	Hose - Intercooler To Pipe (Cold Side)	D506039	26203
Hose - Suction - Tank To Pump	M50603274320450	DEF7056	Hose - Pipe To Engine (Cold Side)	D506039	26203
Hose - Return - Pump To Tank	M50603274110450	DEF7057	Cummins ISX12 Diesel		
Hose - Turbo To Pipe (Hot Side)		26203	320		
Hose - Pipe To Intercooler (Hot Side)		26203	Tensioner Assy.	4299053	38569
Hose - Intercooler To Pipe (Cold Side)		26203	367		
Hose - Pipe To Engine (Cold Side)		26203	Belt - Fan	D8410006102220	K100874HD
386			Belt - Alt. & A.C.	D8410006061535	♣K060605HD
Tensioner Assy. - Fan	4299051	38587	Tensioner Assy. - Fan	2871294	38622
Tensioner Assy. - A.C.	3690067	38610	Tensioner Assy. - Alt. & A.C.	2891940	38610
Idler Pulley - A.C.	3689465	36223	Idler Pulley - Alt. & A.C.	3682229	36223
389			Hose - Upper - Rad. To Pipe		28359
Belt - Serpentine - Fan	D8410006122310	♣K120911HD	Hose - Upper - Pipe To Eng.		28212
Belt - Serpentine - A.C.	6061620	♣K060637HD	Hose - Lower - Rad. To Pipe		24840
Tensioner Assy. - Fan	4299051	38587	Hose - Lower - Pipe To Eng.		24840
Tensioner Assy. - A.C.	3690067	38610	Hose - Suction - Tank To Pump	M50602274320600	DEF7014
Idler Pulley - A.C.	3689465	36223	Hose - Return - Pump To Tank	M50602274110550	DEF7020
Hose - Upper - Rad. To Pipe		28359	Hose - Pressure - Pump To Injector; W/800mm Line	M50602071230800	DEF7000
Hose - Upper - Pipe To Eng.		≈<28212	Hose - Turbo To Pipe (Hot Side)	D506039	26203
Hose - Lower - Pipe To Rad.		≈<28200	Hose - Pipe To Intercooler (Hot Side)	D506039	26203
Hose - Lower - Pipe To Eng.		≈<28231	Hose - Intercooler To Pipe (Cold Side)	D506039	26203
Hose - Suction - Tank To Pump	M50603274320450	DEF7056	Hose - Pipe To Engine (Cold Side)	D506039	26203
Hose - Return - Pump To Tank	M50603274110450	DEF7057	Cummins ISX12-G		
Hose - Turbo To Pipe (Hot Side)		26203	320		
Hose - Pipe To Intercooler (Hot Side)		26203	Tensioner Assy.	4299053	38569
Hose - Intercooler To Pipe (Cold Side)		26203	Cummins ISX15 Diesel		
Hose - Pipe To Engine (Cold Side)		26203	367		
567			Belt - Fan & Alt.	D8410006122180	♣K120858HD
Belt - Serpentine - Fan	D8410006122310	♣K120911HD	Belt - A.C.	D8410006061620	♣K060637HD
Belt - Serpentine - A.C.	6061620	♣K060637HD	Tensioner Assy. - Fan & Alt.	2871292	38587
Tensioner Assy. - A.C.	3690067	38610	Tensioner Assy. - A.C.	2891940	38610
Tensioner Assy. - Fan	4299051	38587	Idler Pulley - A.C.	3682229	36223
Idler Pulley - A.C.	3689465	36223	386		
Hose - Upper - Rad. To Pipe		28359	Tensioner Assy. - Fan	4299051	38587
Hose - Upper - Pipe To Eng.		≈<28212	Tensioner Assy. - A.C.	3690067	38610
Hose - Lower - Rad. To Pipe		≈<28200	Idler Pulley - A.C.	3689465	36223
Hose - Lower - Pipe To Eng.		≈<28231	388		
Hose - Return - Pump To Tank	M50603274110450	DEF7057	Belt - Serpentine - Fan	6122180	♣K120858HD
Hose - Suction - Tank To Pump	M50603274320450	DEF7056	Belt - Serpentine - A.C.	6061620	♣K060637HD
Hose - Turbo To Pipe (Hot Side)		26203	Tensioner Assy. - Fan	4299051	38587
Hose - Pipe To Intercooler (Hot Side)		26203	Tensioner Assy. - A.C.	3690067	38610
Hose - Intercooler To Pipe (Cold Side)		26203	Idler Pulley	3689465	36223
Hose - Pipe To Engine (Cold Side)		26203	Hose - Upper - Pipe To Rad.		28359
579; 587			Hose - Upper - Pipe To Eng.		≈<28212
Tensioner Assy. - Fan	4299051	38587	Hose - Lower - Pipe To Rad.		≈<28200
Tensioner Assy. - A.C.	3690067	38610	Hose - Lower - Pipe To Eng.		≈<28231
Idler Pulley - A.C.	3689465	36223	Hose - Suction - Tank To Pump	M50603274320450	DEF7056
			Hose - Return - Pump To Tank	M50603274110450	DEF7057
			Hose - Turbo To Pipe (Hot Side)		26203

♣Standard Belt Available.

≈<Cut to Fit.

Belts and Coolant Hose for Medium/Heavy-Duty Trucks (2001 & Newer)

Medium & Heavy-Duty Trucks
(2001 & Newer)

Application	Mfr. Part No.	Our No.	Application	Mfr. Part No.	Our No.
Peterbilt - Continued			Peterbilt - Continued		
2014 - Continued			2014 - Continued		
Cummins ISX15 Diesel - Continued			Paccar MX-13 Diesel - Continued		
388 - Continued			367 - Continued		
Hose - Pipe To Intercooler (Hot Side)		26203	Hose - Suction - Tank To Pump	M50603474320600	DEF7014
Hose - Intercooler To Pipe (Cold Side)		26203	Hose - Return - Pump To Tank	M50603474110550	DEF7020
Hose - Pipe To Engine (Cold Side)		26203	Hose - Pressure - Pump To Injector; W/2200mm Line	M50603372232200	DEF7043
389			Hose - Turbo To Pipe (Hot Side)	D506039	26203
Belt - Fan	D8410006122310	♣K120911HD	Hose - Pipe To Intercooler (Hot Side)	D506039	26203
Belt - Alt. & A.C.	D8410006061620	♣K060637HD	Hose - Intercooler To Pipe (Cold Side)	D506039	26203
Tensioner Assy. - Fan	4299051	38587	Hose - Pipe To Engine (Cold Side)	D506039	26203
Tensioner Assy. - Alt. & A.C.	2891940	38610	384		
Idler Pulley - Alt. & A.C.	3682229	36223	Belt - Fan	D841002121640	K120645HD
Hose - Upper - Rad. To Pipe		28359	Belt - A.C.	D841002071939	K070762HD
Hose - Upper - Pipe To Eng.		28212	Tensioner Assy. - Fan	1853658	38670
Hose - Lower - Rad. To Pipe		28212	Idler Pulley	1855571	36359
Hose - Lower - Pipe To Eng.		≈24840	Hose - Upper		28359
Hose - Suction - Tank To Pump	M50603474320500	DEF7002	Hose - Upper - Pipe To Eng.		≈28200
Hose - Return - Pump To Tank	M50603474110500	DEF7001	Hose - Lower - Rad. To Pipe		28212
Hose - Pressure - Pump To Injector; W/3000mm Line	M50603372133000	DEF7048	Hose - Lower - Pipe To Eng.		≈24848
Hose - Turbo To Pipe (Hot Side)	D506039	26203	Hose - Suction - Tank To Pump	M50603474320600	DEF7014
Hose - Pipe To Intercooler (Hot Side)	D506039	26203	Hose - Return - Pump To Tank	M50603474110550	DEF7020
Hose - Intercooler To Pipe (Cold Side)	D506039	26203	Hose - Pressure - Pump To Injector; W/800mm Line	M50603371230800	DEF7000
Hose - Pipe To Engine (Cold Side)	D506039	26203	Hose - Turbo To Pipe (Hot Side)	D506039	26203
567			Hose - Pipe To Intercooler (Hot Side)	D506039	26203
Tensioner Assy. - Fan	4299051	38587	Hose - Intercooler To Pipe (Cold Side)	D506039	26203
Tensioner Assy. - A.C.	3690067	38610	Hose - Pipe To Engine (Cold Side)	D506039	26203
Idler Pulley - A.C.	3689465	36223	579		
579			Belt - Alt. & A.C.	1898312	♣K080913HD
Belt - Fan	D8410006122180	♣K120858HD	Hose - Upper - Rad. To Pipe		28359
Belt - A.C.	D8410006061620	♣K060637HD	Hose - Upper - Pipe To Eng.		≈24840
Tensioner Assy. - Fan	4299051	38587	Hose - Lower - Rad. To Pipe		≈24840
Tensioner Assy. - A.C.	2891940	38610	Hose - Lower - Pipe To Eng.		≈28212
Idler Pulley - A.C.	3682229	36223	Hose - Suction - Tank To Pump; W/450mm Line	M50603274320450	DEF7056
Hose - Upper - Rad. To Pipe		28359	Hose - Suction - Tank To Pump; W/550mm Line	M50603474320550	DEF7022
Hose - Upper - Pipe To Eng.		≈28212	Hose - Return - Pump To Tank; W/450mm Line	M50603274110450	DEF7057
Hose - Lower - Rad. To Pipe		≈24840	Hose - Return - Pump To Tank; W/550mm Line	M50603474110550	DEF7020
Hose - Lower - Pipe To Eng.		≈24840	Hose - Turbo To Pipe (Hot Side)	D506039	26203
Hose - Return - Pump To Tank; W/450mm Line	M50603274110450	DEF7057	Hose - Pipe To Intercooler (Hot Side)	D506039	26203
Hose - Return - Pump To Tank; W/500mm Line	M50603474110500	DEF7001	Hose - Intercooler To Pipe (Cold Side)	D506039	26203
Hose - Return - Pump To Tank; W/550mm Line	M50603074110550	DEF7020	Hose - Pipe To Engine (Cold Side)	D506039	26203
Hose - Suction - Tank To Pump; W/450mm Line	M50603274320450	DEF7056	Paccar PX-9 Diesel		
Hose - Suction - Tank To Pump; W/500mm Line	M50603474320500	DEF7002	337		
Hose - Suction - Tank To Pump; W/600mm Line	M50603074320600	DEF7014	Belt - Fan	4933083	♣K080842HD
Hose - Turbo To Pipe (Hot Side)	D506039	26203	Tensioner Assy.	3973819	38627
Hose - Pipe To Intercooler (Hot Side)	D506039	26203	Idler Pulley	3970945	36283
Hose - Intercooler To Pipe (Cold Side)	D506039	26203	Hose - Upper		≈24840
Hose - Pipe To Engine (Cold Side)	D506039	26203	Hose - Lower - Rad. To Oil Cooler		≈24836
587			Hose - Lower - Oil Cooler To Pipe		≈24836
Tensioner Assy. - Fan	4299051	38587	Hose - Lower - Pipe To Eng.		≈24836
Tensioner Assy. - A.C.	3690067	38610	Hose - Turbo To Pipe (Hot Side)		26203
Idler Pulley - A.C.	3689465	36223	Hose - Intercooler To Pipe (Cold Side)		26203
Paccar MX-13 Diesel			Hose - Pipe To Engine (Cold Side)		26203
367			2013		
Belt - Fan	D841002121640	K120645HD	Cummins ISL9 Diesel		
Belt - A.C.	D841002071939	K070762HD	365		
Tensioner Assy. - A.C.	1853658	38670	Belt - Fan	3972376	K080852HD
Idler Pulley - A.C.	1855571	36359	Tensioner Assy.	3973819	38627
Hose - Upper - Rad. To Pipe		28359	Idler Pulley	3970945	36283
Hose - Upper - Pipe To Eng.		28212	Hose - Upper - Rad. To Pipe		28359
Hose - Lower - Rad. To Pipe		28212	Hose - Upper - Pipe To Eng.		≈24836
Hose - Lower - Pipe To Eng.		≈24848	Hose - Lower - Rad. To Pipe		≈24836

♣Standard Belt Available.

≈Cut to Fit.

Belts and Coolant Hose for Medium/Heavy-Duty Trucks (2001 & Newer)

Medium & Heavy-Duty Trucks
(2001 & Newer)

Application	Mfr. Part No.	Our No.	Application	Mfr. Part No.	Our No.
Peterbilt - Continued			Peterbilt - Continued		
2013 - Continued			2013 - Continued		
Cummins ISL9 Diesel - Continued			Cummins ISX15 Diesel - Continued		
365 - Continued			386 - Continued		
Hose - Lower - Pipe To Eng.		≈<24840	Hose - Pressure - Pump To Injector; W/800mm Line	M50602071230800	DEF7000
Hose - Suction - Tank To Pump	M50602274320600	DEF7014	Hose - Pressure - Pump To Injector; W/900mm Line	M50602271230900	DEF7025
Hose - Return - Pump To Tank	M50602274110500	DEF7001	Hose - Pressure - Pump To Injector; W/2600mm Line	M50602072132600	DEF7054
Hose - Turbo To Pipe (Hot Side)	D506039	26203	388		
Hose - Pipe To Intercooler (Hot Side)	D506039	26203	Belt - Fan	D8410006122310	♣K120911HD
Hose - Intercooler To Pipe (Cold Side)	D506039	26203	Belt - A.C.	D8410006061620	♣K060637HD
Hose - Pipe To Engine (Cold Side)	D506039	26203	Tensioner Assy. - Fan	2871292	38587
			Tensioner Assy. - A.C.	2891940	38610
			Idle Pulley - A.C.	3682229	36223
			Hose - Upper - Rad. To Pipe		28359
Cummins ISL-G CNG			Hose - Upper - Pipe To Eng.		≈<28212
320			Hose - Lower - Rad. To Pipe		≈<28200
Belt - Fan	D8410006081940	♣K080765HD	Hose - Lower - Pipe To Eng.		≈<24840
Belt - Alt.	D8410006060950	♣K060374HD	Hose - Pressure - Pump To Injector; W/2200mm Line	M50602072232200	DEF7043
Tensioner Assy. - Fan	3973819	38627	Hose - Pressure - Pump To Injector; W/2300mm Line	M50602072232300	DEF7062
Hose - Upper - Pipe To Eng.		≈<24836	Hose - Pressure - Pump To Injector; W/800mm Line	M50602071230800	DEF7000
Hose - Pipe To Intercooler (Hot Side)	D506043	26201	Hose - Return - Pump To Tank	M50602274110500	DEF7001
Hose - Intercooler To Pipe (Cold Side)	D506039	26203	Hose - Suction - Tank To Pump	M50602274320500	DEF7002
Hose - Pipe To Engine (Cold Side)	D506039	26203	389		
			Belt - Fan	D8410006122310	♣K120911HD
Cummins ISX12 Diesel			Belt - A.C.	D8410006061620	♣K060637HD
365			Tensioner Assy. - Fan	2871292	38587
Belt - Fan	D8410006122310	♣K120911HD	Tensioner Assy. - A.C.	2891940	38610
Belt - A.C.	D8410006061620	♣K060637HD	Idle Pulley - A.C.	3682229	36223
Tensioner Assy. - Fan	2871292	38587	Hose - Pressure - Pump To Injector; W/3000mm Line	M50602072133000	DEF7048
Tensioner Assy. - A.C.	2891940	38610	Hose - Return - Pump To Tank	M50602274110500	DEF7001
Idle Pulley - A.C.	3682229	36223	Hose - Suction - Tank To Pump	M50602274320500	DEF7002
Hose - Pressure - Pump To Injector; W/3000mm Line	M50602072133000	DEF7048	384		
Hose - Return - Pump To Tank	M50602274110500	DEF7001	Belt - Fan	D8410006102220	K100874HD
Hose - Suction - Tank To Pump	M50602274320500	DEF7002	Belt - Alt. & A.C.	D8410006061535	♣K060605HD
			Tensioner Assy. - Fan	4920105	38622
			Tensioner Assy. - Alt. & A.C.	2891940	38610
			Idle Pulley - Alt. & A.C.	3682229	36223
			Hose - Upper - Rad. To Pipe		28359
			Hose - Upper - Pipe To Eng.		28212
			Hose - Lower - Pipe To Eng.		≈<24840
			Hose - Lower - Rad. To Pipe		≈<24840
			Hose - Pressure - Pump To Injector; W/800mm Line	M50602071230800	DEF7000
			Hose - Suction - Tank To Pump	M50602274320550	DEF7022
			Hose - Return - Pump To Tank	M50602274110550	DEF7020
			Hose - Turbo To Pipe (Hot Side)	D506039	26203
			Hose - Pipe To Intercooler (Hot Side)	D506039	26203
			Hose - Intercooler To Pipe (Cold Side)	D506039	26203
			Hose - Pipe To Engine (Cold Side)	D506039	26203
			Cummins ISX15 Diesel		
			367		
			Belt - Fan & Alt.	D8410006122180	♣K120858HD
			Belt - A.C.	D8410006061620	♣K060637HD
			Tensioner Assy. - Fan & Alt.	2871292	38587
			Tensioner Assy. - A.C.	2891940	38610
			Idle Pulley - A.C.	3682229	36223
			386		
			Belt - Fan & Alt.	D8410006122180	♣K120858HD
			Belt - A.C.	D8410006061620	♣K060637HD
			Tensioner Assy. - Fan & Alt.	2871292	38587
			Tensioner Assy. - A.C.	2891940	38610
			Idle Pulley - A.C.	3682229	36223
			Hose - Upper - Pipe To Rad.		28359
			Hose - Upper - Eng. To Pipe		≈<28212
			Hose - Lower		≈<24840
			Hose - Suction - Tank To Pump	M50602274320500	DEF7002
			Hose - Return - Pump To Tank	M50602274110500	DEF7001
			Cummins ISX15 Diesel		
			386		
			Belt - Fan	D8410006122180	♣K120858HD
			Belt - A.C.	D8410006061620	♣K060637HD
			Tensioner Assy. - Fan	4299051	38587
			Tensioner Assy. - A.C.	2891940	38610
			Idle Pulley - A.C.	3682229	36223
			Hose - Upper - Rad. To Pipe		28359
			Hose - Upper - Pipe To Eng.		≈<28212
			Hose - Lower - Rad. To Pipe		≈<28200
			Hose - Lower - Pipe To Eng.		≈<24840
			Hose - Return - Pump To Tank; W/450mm Line	M50603274110450	DEF7057
			Hose - Return - Pump To Tank; W/500mm Line	M50603474110500	DEF7001
			Hose - Return - Pump To Tank; W/550mm Line	M50603074110550	DEF7020
			Hose - Suction - Tank To Pump; W/450mm Line	M50603274320450	DEF7056
			Hose - Suction - Tank To Pump; W/500mm Line	M50603474320500	DEF7002
			Hose - Suction - Tank To Pump; W/600mm Line	M50603074320600	DEF7014
			Hose - Turbo To Pipe (Hot Side)	D506039	26203

♣Standard Belt Available.

≈<Cut to Fit.

Belts and Coolant Hose for Medium/Heavy-Duty Trucks (2001 & Newer)

Application	Mfr. Part No.	Our No.	Application	Mfr. Part No.	Our No.
Peterbilt - Continued			Peterbilt - Continued		
2013 - Continued			2013 - Continued		
Cummins ISX15 Diesel - Continued			Paccar MX Diesel - Continued		
579 - Continued			579 - Continued		
Hose - Pipe To Intercooler (Hot Side)	D506039	26203	Idler Pulley - Fan	1787114	36359
Hose - Intercooler To Pipe (Cold Side)	D506039	26203	Idler Pulley - Alt. & A.C.	1787114	36359
Hose - Pipe To Engine (Cold Side)	D506039	26203	Hose - Upper - Rad. To Pipe		28359
Paccar MX Diesel			Hose - Upper - Pipe To Eng.		≈28212
365			587		
Belt - Alt. & A.C.	1818253	K070762HD	Belt - Fan	D841002121640	K120645HD
Tensioner Assy. - Alt. & A.C.	1853658	38670	Belt - Alt. & A.C.	D841002071939	K070762HD
Idler Pulley - Alt. & A.C.	1855571	36359	Tensioner Assy. - Alt. & A.C.	1787113	38670
Hose - Upper - Rad. To Pipe		28359	Idler Pulley - Fan	1787114	36359
Hose - Upper - Pipe To Eng.		≈24840	Idler Pulley - Alt. & A.C.	1787114	36359
Hose - Lower - Pipe To Eng.		≈24848	Hose - Upper - Rad. To Pipe		28359
Hose - Return - Pump To Tank	M50602274110550	DEF7020	Hose - Upper - Pipe To Eng.		≈28212
Hose - Suction - Tank To Pump	M50602274320600	DEF7014	Hose - Lower - Rad. To Pipe		28212
Hose - Pressure - Pump To Injector; W/800mm Line	M50602071230800	DEF7000	Hose - Lower - Pipe To Eng.		≈24848
Hose - Turbo To Pipe (Hot Side)	D506039	26203	Hose - Suction - Tank To Pump	M50602274320550	DEF7022
Hose - Pipe To Intercooler (Hot Side)	D506039	26203	Hose - Return - Pump To Tank	M50602274110550	DEF7020
Hose - Intercooler To Pipe (Cold Side)	D506039	26203	Hose - Pressure - Pump To Injector; W/2400mm Line	M50602072132400	DEF7042
Hose - Pipe To Engine (Cold Side)	D506039	26203	Hose - Turbo To Pipe (Hot Side)	D506039	26203
367			Hose - Pipe To Intercooler (Hot Side)	D506039	26203
Belt - Fan	D841002121640	K120645HD	Hose - Intercooler To Pipe (Cold Side)	D506039	26203
Belt - A.C.	D841002011939	K070762HD	Hose - Pipe To Engine (Cold Side)	D506039	26203
Tensioner Assy. - A.C.	1787113	38670	Paccar PX-6 Diesel		
Idler Pulley - Fan	1787114	36359	210		
Idler Pulley - A.C.	1787114	36359	Belt - Fan	D841001081956	K080770HD
Hose - Upper - Rad. To Pipe		28359	Tensioner Assy.	3976834	38516
Hose - Upper - Pipe To Eng.		≈24840	Idler Pulley - Grooved	4991240	36093
Hose - Lower - Rad. To Pipe		28212	Hose - Suction - Tank To Pump	M50602274420400	DEF7058
Hose - Lower - Pipe To Eng.		≈24840	Hose - Return - Pump To Tank	M50603474210400	DEF7059
Hose - Suction - Tank To Pump	M50603474320600	DEF7014	337		
Hose - Return - Pump To Tank	M50603474110550	DEF7020	Belt - Fan	3289864	♣K080825HD
Hose - Pressure - Pump To Injector; W/2200mm Line	M50603372232200	DEF7043	Hose - Upper - Rad. To Pipe		≈24828
Hose - Turbo To Pipe (Hot Side)	D506039	26203	Hose - Upper - Pipe To Eng.		≈24840
Hose - Pipe To Intercooler (Hot Side)	D506039	26203	Hose - Lower - Rad. To Pipe		≈24840
Hose - Intercooler To Pipe (Cold Side)	D506039	26203	Hose - Lower - Pipe To Pipe		≈24832
Hose - Pipe To Engine (Cold Side)	D506039	26203	Hose - Lower - Pipe To Eng.		≈24836
384			Hose - Suction - Tank To Pump	M50603474320600	DEF7014
Belt - Fan	D841002121640	K120645HD	Hose - Return - Pump To Tank	M50602274110550	DEF7020
Belt - Alt. & A.C.	D841002071939	K070762HD	Hose - Pressure - Pump To Injector; W/800mm Line	M50603371230800	DEF7000
Tensioner Assy. - Alt. & A.C.	1787113	38670	Hose - Turbo To Pipe (Hot Side)	D506039	26203
Idler Pulley - Fan	1787114	36359	Hose - Pipe To Intercooler (Hot Side)	D506039	26203
Idler Pulley - Alt. & A.C.	1787114	36359	Hose - Intercooler To Pipe (Cold Side)	D506039	26203
386			Hose - Pipe To Engine (Cold Side)	D506039	26203
Belt - Fan	D841002121640	K120645HD	Paccar PX-8 Diesel		
Belt - A.C.	D841002071939	K070762HD	337		
Tensioner Assy. - A.C.	1787113	38670	Belt - Fan	4933083	♣K080842HD
Idler Pulley - Fan	1787114	36359	Tensioner Assy.	3973819	38627
Idler Pulley - A.C.	1787114	36359	Idler Pulley	3970945	36283
Hose - Upper - Rad. To Pipe		28359	Hose - Upper - Pipe To Eng.		≈24840
Hose - Upper - Pipe To Eng.		≈24840	Hose - Upper - Rad. To Pipe		≈24836
Hose - Lower - Rad. To Pipe		28212	Hose - Lower - Pipe To Pipe		≈24836
Hose - Lower - Pipe To Eng.		≈24848	Hose - Lower - Rad. To Pipe		≈24836
Hose - Return - Pump To Tank	M50603074110550	DEF7020	Hose - Lower - Pipe To Eng.		≈24840
Hose - Suction - Tank To Pump	M50602774320550	DEF7022	Hose - Suction - Tank To Pump	M50602274110550	DEF7020
Hose - Pressure - Pump To Injector; W/2700mm Line	M50602072132700	DEF7053	Hose - Return - Pump To Tank; W/600mm Line	M50602274320600	DEF7014
Hose - Turbo To Pipe (Hot Side)	D506039	26203	Hose - Return - Pump To Tank; W/500mm Line	M50602274320500	DEF7002
Hose - Pipe To Intercooler (Hot Side)	D506039	26203	Hose - Pressure - Pump To Injector; W/600mm Line	M50602071230600	DEF7024
Hose - Intercooler To Pipe (Cold Side)	D506039	26203	Hose - Pipe To Intercooler (Hot Side)	D506039	26203
Hose - Pipe To Engine (Cold Side)	D506039	26203	Hose - Intercooler To Pipe (Cold Side)	D506039	26203
579			Hose - Pipe To Engine (Cold Side)	D506039	26203
Belt - Fan	D841002121640	K120645HD			
Belt - Alt. & A.C.	D841002071939	K070762HD			
Tensioner Assy. - Alt. & A.C.	1787113	38670			

Medium & Heavy-Duty Trucks (2001 & Newer)

≈Cut to Fit.

♣Standard Belt Available.

Belts and Coolant Hose for Medium/Heavy-Duty Trucks (2001 & Newer)

Medium & Heavy-Duty Trucks
(2001 & Newer)

Application	Mfr. Part No.	Our No.	Application	Mfr. Part No.	Our No.
Peterbilt - Continued			Peterbilt - Continued		
2012			2012 - Continued		
Cummins ISL Diesel			Cummins ISX15 Diesel - Continued		
320			386 - Continued		
Tensioner Assy.	3973819	38627	Hose - Pressure - Pump To Injector; W/800mm Line	M50602071230800	DEF7000
Idler Pulley	3970945	36283	Hose - Pressure - Pump To Injector; W/900mm Line	M50602271230900	DEF7025
Cummins ISL9 Diesel			Hose - Pressure - Pump To Injector; W/2600mm Line	M50602072132600	DEF7054
365			Hose - Pressure - Pump To Injector; W/2300mm Line	M50602072232300	DEF7062
Belt - Fan	D8410006102220	K100874HD	388		
Belt - A.C.	D8410006061535	▲K060605HD	Belt - Fan	D8410006122310	▲K120911HD
Tensioner Assy. - Fan	4299053	38569	Belt - A.C.	D8410006061620	▲K060637HD
Tensioner Assy. - A.C.	2891940	38610	Tensioner Assy. - Fan	2871292	38587
Idler Pulley - A.C.	3682229	36223	Tensioner Assy. - A.C.	3104149	38610
Hose - Upper - Rad. To Pipe		28359	Idler Pulley - A.C.	3682229	36223
Hose - Upper - Pipe To Eng.		28212	Hose - Upper - Pipe To Rad.		28359
Hose - Lower - Rad. To Pipe	≈<24840		Hose - Upper - Eng. To Pipe	≈<28212	
Hose - Lower - Pipe To Eng.	≈<24840		Hose - Lower - Eng. To Pipe	≈<28200	
Hose - Turbo To Pipe (Hot Side)	D506039	26203	Hose - Lower - Pipe To Rad.	≈<24840	
Hose - Pipe To Intercooler (Hot Side)	D506039	26203	389		
Hose - Intercooler To Pipe (Cold Side)	D506039	26203	Belt - Fan & Alt.	D8410006122180	▲K120858HD
Hose - Pipe To Engine (Cold Side)	D506039	26203	Belt - A.C.	D8410006061620	▲K060637HD
Cummins ISX11.9 Diesel			Tensioner Assy. - Fan & Alt.	3682946	38587
320			Tensioner Assy. - A.C.	3104149	38610
Belt - Fan	D8410006102375	K100935HD	Tensioner Pulley - Fan & Alt.	3682946	36165
Belt - A.C.	D8410006061535	▲K060605HD	Idler Pulley - A.C.	3682229	36223
Tensioner Assy. - Fan	2871294	38622	Hose - Upper - Pipe To Rad.		28359
Tensioner Assy. - A.C.	3104149	38610	Hose - Upper - Pipe To Eng.		28212
Idler Pulley - A.C.	3682229	36223	Hose - Lower - Rad. To Pipe		28212
365			Hose - Lower - Pipe To Eng.	≈<24840	
Belt - Fan & A.C.	D8410006102220	K100874HD	Hose - Suction - Tank To Pump	M50602274320500	DEF7002
Belt - Alt.	D8410006061535	▲K060605HD	Hose - Return - Pump To Tank	M50602274110500	DEF7001
Tensioner Assy. - Alt.	3104149	38610	Hose - Pressure - Pump To Injector; W/3000mm Line	M50602072133000	DEF7048
Tensioner Assy. - Fan & A.C.	2871294	38622	Hose - Pressure - Pump To Injector; W/2500mm Line	M50602672132500	DEF7052
Idler Pulley - Alt.	3682229	36223	Hose - Turbo To Pipe (Hot Side)	D506039	26203
Hose - Upper - Rad. To Pipe		28359	Hose - Pipe To Intercooler (Hot Side)	D506039	26203
Hose - Upper - Pipe To Eng.	≈<28212		Hose - Intercooler To Pipe (Cold Side)		26203
Hose - Lower	≈<24840		Hose - Pipe To Engine (Cold Side)		26203
Cummins ISX15 Diesel			587		
367			Belt - Fan & Alt.	D8410006122180	▲K120858HD
Belt - Fan & Alt.	D8410006122180	▲K120858HD	Belt - A.C.	D8410006061620	▲K060637HD
Belt - A.C.	D8410006061620	▲K060637HD	Tensioner Assy. - Fan & Alt.	3682946	38587
Tensioner Assy. - Fan & Alt.	2871292	38587	Tensioner Assy. - A.C.	3104149	38610
Tensioner Assy. - A.C.	2891940	38610	Tensioner Pulley - Fan & Alt.	3682946	36165
Idler Pulley - A.C.	3682229	36223	Idler Pulley - A.C.	3682229	36223
Hose - Upper - Rad. To Pipe		28359	Hose - Upper - Rad. To Pipe		28359
Hose - Upper - Pipe To Eng.	≈<28212		Hose - Upper - Pipe To Eng.		28212
Hose - Lower - Rad. To Pipe	≈<28200		Hose - Lower - Rad. To Pipe	≈<24840	
Hose - Lower - Pipe To Eng.	≈<24840		Hose - Lower - Pipe To Eng.	≈<24840	
Hose - Return - Pump To Tank	M50602274110550	DEF7020	Hose - Suction - Tank To Pump	M50602274320550	DEF7022
Hose - Suction - Tank To Pump	M50602274320500	DEF7002	Hose - Return - Pump To Tank	M50602274110550	DEF7020
386			Hose - Pressure - Pump To Injector; W/1500mm Line	M50602072131500	DEF7045
Belt - Fan & Alt.	D8410006122180	▲K120858HD	Hose - Turbo To Pipe (Hot Side)	D506039	26203
Belt - A.C.	D8410006061620	▲K060637HD	Hose - Pipe To Intercooler (Hot Side)	D506039	26203
Tensioner Assy. - Fan & Alt.	2871292	38587	Hose - Intercooler To Pipe (Cold Side)	D506039	26203
Tensioner Assy. - A.C.	2891940	38610	Hose - Pipe To Engine (Cold Side)	D506039	26203
Idler Pulley - A.C.	3682229	36223	Cummins ISX-G LNG		
Hose - Upper - Pipe To Rad.		28359	388		
Hose - Upper - Eng. To Pipe	≈<28212		Belt - Fan	D8410006122310	▲K120911HD
Hose - Lower	≈<24840		Belt - A.C.	D8410006061620	▲K060637HD
Hose - Suction - Tank To Pump; W/500mm Line	M50602274320500	DEF7002	Tensioner Assy. - Fan	2871292	38587
Hose - Suction - Tank To Pump; W/550mm Line	M50602274320550	DEF7022	Tensioner Assy. - A.C.	3104149	38610
Hose - Return - Pump To Tank; W/500mm Line	M50602274110500	DEF7001	Idler Pulley - A.C.	3682229	36223
Hose - Return - Pump To Tank; W/550mm Line	M50602274110550	DEF7020			

▲Standard Belt Available.

≈<Cut to Fit.

Belts and Coolant Hose for Medium/Heavy-Duty Trucks (2001 & Newer)

Application	Mfr. Part No.	Our No.	Application	Mfr. Part No.	Our No.
Peterbilt - Continued			Peterbilt - Continued		
2012 - Continued			2012 - Continued		
Cummins ISX-G LNG - Continued			Paccar PX-8 Diesel - Continued		
388 - Continued			348 - Continued		
Hose - Upper - Pipe To Rad.		28359	Hose - Suction - Tank To Pump	M50602274110550	DEF7020
Hose - Upper - Eng. To Pipe		≅28212	Hose - Return - Pump To Tank	M50602274320600	DEF7014
Hose - Lower - Eng. To Pipe		≅28200	Hose - Pipe To Intercooler (Hot Side)	D506039	26203
Hose - Lower - Pipe To Rad.		≅24840	Hose - Intercooler To Pipe (Cold Side)	D506039	26203
Paccar MX Diesel			Hose - Pipe To Engine (Cold Side)		
365; 367			D506039		
Belt - Fan	D841002121640	K120645HD	2011		
Belt - A.C.	D841002071939	K070762HD	Caterpillar C13 Diesel		
Tensioner Assy. - A.C.	1787113	38670	365		
Idler Pulley - Fan	1787114	36359	Belt - Alt.		
Idler Pulley - A.C.	1787114	36359	Belt - Fan & A.C.		
384; 386			Idler Pulley - Alt.		
Belt - Fan	D841002121640	K120645HD	Idler Pulley - Fan & A.C. (Grooved)		
Belt - Alt. & A.C.	D841002071939	K070762HD	Idler Pulley - Fan & A.C. (Smooth)		
Tensioner Assy. - Alt. & A.C.	1787113	38670	Hose - Lower - Eng. To Pipe		
Idler Pulley - Fan	1787114	36359	384		
Idler Pulley - Alt. & A.C.	1787114	36359	Belt - Fan		
587			Belt - Alt.		
Belt - Fan	D841002121640	K120645HD	Tensioner Assy.		
Belt - Alt. & A.C.	D841002071939	K070762HD	Idler Pulley		
Tensioner Assy. - Alt. & A.C.	1787113	38670	Caterpillar C15 Diesel		
Idler Pulley - Fan	1787114	36359	388		
Idler Pulley - Alt. & A.C.	1787114	36359	Belt - Fan & A.C.		
Hose - Upper - Rad. To Pipe		28359	Belt - Alt.		
Hose - Upper - Pipe To Eng.		28212	Tensioner Assy. - Fan & A.C.		
Hose - Lower - Rad. To Pipe		28212	Tensioner Assy. - Alt.		
Hose - Lower - Pipe To Eng.		≅24848	Idler Pulley - Fan & A.C. (Grooved)		
Hose - Suction - Tank To Pump	M50602274320550	DEF7022	Idler Pulley - Alt.		
Hose - Return - Pump To Tank	M50602274110550	DEF7020	Hose - Upper - Rad. To Pipe		
Hose - Pressure - Pump To Injector; W/1500mm Line	M50602072131500	DEF7045	Hose - Upper - Pipe To Eng.		
Hose - Turbo To Pipe (Hot Side)	D506039	26203	Hose - Lower - Rad. To Pipe		
Hose - Pipe To Intercooler (Hot Side)	D506039	26203	Hose - Lower - Pipe To Eng.		
Hose - Intercooler To Pipe (Cold Side)	D506039	26203	Hose - Turbo To Pipe (Hot Side)		
Hose - Pipe To Engine (Cold Side)	D506039	26203	Hose - Pipe To Intercooler (Hot Side)		
Paccar PX-6 Diesel			Hose - Intercooler To Pipe (Cold Side)		
325			Hose - Pipe To Engine (Cold Side)		
Belt - Fan	3289864	♣K080825HD	389		
Hose - Upper		24840	Belt - Fan & A.C.		
Hose - Lower		24832	Belt - Alt.		
337			Tensioner Assy. - Fan & A.C.		
Belt - Fan	3289864	♣K080825HD	Tensioner Assy. - Alt.		
Hose - Upper - Eng. To Pipe		≅24828	Idler Pulley - Fan & A.C. (Grooved)		
Hose - Upper - Pipe To Rad.		≅24840	Idler Pulley - Alt. (Upper)		
Paccar PX-8 Diesel			Idler Pulley - Alt. (Lower)		
337			Hose - Upper - Rad. To Pipe		
Belt - Fan	4933083	♣K080842HD	Hose - Upper - Pipe To Eng.		
Tensioner Assy.	3973819	38627	Hose - Lower - Rad. To Pipe		
Idler Pulley	3970945	36283	Hose - Lower - Pipe To Eng.		
Hose - Upper - Pipe To Rad.		28359	Hose - Intercooler To Pipe (Cold Side)		
Hose - Upper - Eng. To Pipe; Cut at 6"		24840	Hose - Pipe To Engine (Cold Side)		
Hose - Lower - Eng. To Pipe; Cut at 6"		24836	Hose - Turbo To Pipe (Hot Side)		
Hose - Lower - Pipe To Rad.; Cut at 6"		24836	Hose - Pipe To Intercooler (Hot Side)		
Hose - Pressure - Tank To Pump	M50602274110550	DEF7020	Cummins ISM Diesel		
Hose - Return - Tank To Pump	M50602274320600	DEF7014	384		
348			Belt - Fan		
Belt - Fan	4933083	♣K080842HD	Belt - A.C.		
Tensioner Assy.	3973819	38627	Cummins ISX15 Diesel		
Idler Pulley	3970945	36283	367		
Hose - Upper - Pipe To Rad.		28359	Belt - Fan, W.P. & Alt.		
Hose - Upper - Eng. To Pipe; Cut at 6"		24840	Belt - A.C. - From W.P.		
Hose - Lower - Eng. To Pipe; Cut at 6"		24836	Tensioner Assy. - Fan, W.P. & Alt.		
Hose - Lower - Pipe To Rad.; Cut at 6"		24836	Tensioner Assy. - A.C.		

≅Cut to Fit.
ⓂTwo Required.

♣Standard Belt Available.

Medium & Heavy-Duty Trucks
(2001 & Newer)

Belts and Coolant Hose for Medium/Heavy-Duty Trucks (2001 & Newer)

Medium & Heavy-Duty Trucks
(2001 & Newer)

Application	Mfr. Part No.	Our No.	Application	Mfr. Part No.	Our No.
Peterbilt - Continued			Peterbilt - Continued		
2011 - Continued			2011 - Continued		
Cummins ISX15 Diesel - Continued			Cummins ISX15 Diesel - Continued		
367 - Continued			389 - Continued		
Idler Pulley - A.C.	3682229	36223	Hose - Pipe To Intercooler (Hot Side)	D506039	26203
386			Hose - Intercooler To Pipe (Cold Side)	D506039	26203
Belt - Fan & Alt.	D8410006122180	♣K120858HD	Hose - Pipe To Engine (Cold Side)	D506039	26203
Belt - A.C.	D8410006061620	♣K060637HD	587		
Tensioner Assy. - Fan & Alt.	3682946	38587	Belt - Fan & Alt.	D8410006122180	♣K120858HD
Tensioner Assy. - A.C.	3104149	38610	Belt - A.C.	D8410006061620	♣K060637HD
Idler Pulley - A.C.	3682229	36223	Tensioner Assy. - Fan & Alt.	3682946	38587
Hose - Upper - Pipe To Rad.		28359	Tensioner Assy. - A.C.	3104149	38610
Hose - Upper - Eng. To Pipe		≈<28212	Tensioner Pulley - Fan & Alt.	3682946	36165
Hose - Lower - Eng. To Pipe		≈<28200	Idler Pulley - A.C.	3682229	36223
Hose - Lower - Pipe To Rad.		≈<24840	Hose - Upper - Eng. To Pipe		21891
Hose - Suction - Tank To Pump	M50602274320500	DEF7002	Hose - Upper - Pipe To Rad.		28359
Hose - Return - Pump To Tank	M50602274110500	DEF7001	Hose - Lower - Eng. To Pipe		≈<24240
Hose - Pressure - Pump To Injector; W/800mm Line	M50602071230800	DEF7000	Hose - Lower - Pipe To Rad.		≈<24240
Hose - Pressure - Pump To Injector; W/900mm Line	M50602271230900	DEF7025	Hose - Intercooler To Pipe (Cold Side)	D506039	26203
Hose - Pressure - Pump To Injector; W/2600mm Line	M50602072132600	DEF7054	Hose - Pipe To Engine (Cold Side)	D506039	26203
Hose - Turbo To Pipe (Hot Side)	D506039	26203	Hose - Turbo To Pipe (Hot Side)	D506039	26203
Hose - Pipe To Intercooler (Hot Side)	D506039	26203	Hose - Pipe To Intercooler (Hot Side)	D506039	26203
Hose - Intercooler To Pipe (Cold Side)	D506039	26203			
Hose - Intercooler To Engine (Cold Side) ...	D506039	26203	Cummins ISX-G LNG		
387			388		
Belt - Fan	D8410006122180	♣K120858HD	Belt - Fan & Alt.	D8410006122180	♣K120858HD
Belt - A.C.	D8410006061620	♣K060637HD	Belt - A.C.	D8410006061620	♣K060637HD
Tensioner Assy. - Fan	3682946	38587	Tensioner Assy. - Fan & Alt.	3682946	38587
Tensioner Assy. - A.C.	3104149	38610	Tensioner Assy. - A.C.	3104149	38610
Idler Pulley - A.C.	3682229	36223	Idler Pulley - A.C.	3682229	36223
Hose - Upper - Rad. To Pipe		28359	Hose - Upper - Pipe To Rad.		28359
Hose - Upper - Pipe To Eng.		28212	Hose - Upper - Eng. To Pipe		≈<28212
Hose - Lower - Rad. To Pipe		24840	Hose - Lower - Eng. To Pipe		≈<28200
Hose - Lower - Pipe To Eng.		24840	Hose - Lower - Pipe To Rad.		≈<24840
Hose - Suction - Tank To Pump	M50602274320550	DEF7022			
Hose - Return - Pump To Tank	M50602274110550	DEF7020	Paccar MX Diesel		
Hose - Pressure - Pump To Injector; W/1500mm Line	M50602072131500	DEF7045	365; 367		
Hose - Turbo To Pipe (Hot Side)	D506039	26203	Belt - Fan	D841002121640	K120645HD
Hose - Pipe To Intercooler (Hot Side)	D506039	26203	Belt - A.C.	D841002011939	K070762HD
Hose - Intercooler To Pipe (Cold Side)	D506039	26203	Tensioner Assy. - A.C.	1787113	38670
Hose - Intercooler To Engine (Cold Side) ...	D506039	26203	Idler Pulley - Fan	1787114	36359
388			Idler Pulley - A.C.	1787114	36359
Belt - Fan & Alt.	D8410006122180	♣K120858HD	384		
Belt - A.C.	D8410006061620	♣K060637HD	Belt - Fan	D841002121640	K120645HD
Tensioner Assy. - Fan & Alt.	3682946	38587	Belt - A.C.	D841002071939	K070762HD
Tensioner Assy. - A.C.	3104149	38610	Tensioner Assy. - A.C.	1787113	38670
Idler Pulley - A.C.	3682229	36223	Idler Pulley - Fan	1787114	36359
Hose - Upper - Pipe To Rad.		28359	Idler Pulley - A.C.	1787114	36359
Hose - Upper - Eng. To Pipe		≈<28212	386		
Hose - Lower - Eng. To Pipe		≈<28200	Belt - Fan	D841002121640	K120645HD
Hose - Lower - Pipe To Rad.		≈<24840	Belt - A.C.	D841002071939	K070762HD
389			Tensioner Assy. - A.C.	1787113	38670
Belt - Fan & Alt.	D8410006122310	♣K120911HD	Idler Pulley - Fan	1787114	36359
Belt - A.C.	D8410006061620	♣K060637HD	Idler Pulley - A.C.	1787114	36359
Tensioner Assy. - Fan & Alt.	2871292	38587	386		
Tensioner Assy. - A.C.	3104149	38610	Belt - Fan	D841002121640	K120645HD
Tensioner Pulley - Fan & Alt.	2871292	36165	Belt - A.C.	D841002071939	K070762HD
Idler Pulley - A.C.	3682229	36223	Tensioner Assy. - A.C.	1787113	38670
Hose - Upper - Pipe To Rad.		28359	Idler Pulley - Fan	1787114	36359
Hose - Upper - Eng. To Pipe		≈<28212	Idler Pulley - A.C.	1787114	36359
Hose - Lower - Eng. To Pipe		≈<24840	Hose - Upper - Rad. To Pipe		28359
Hose - Lower - Pipe To Rad.		≈<28212	Hose - Upper - Pipe To Rad.		≈<24840
Hose - Suction - Tank To Pump	M50602274320500	DEF7002	Hose - Lower - Rad. To Pipe		≈<28212
Hose - Return - Pump To Tank	M50602274110500	DEF7001	Hose - Lower - Pipe To Eng.		≈<24848
Hose - Pressure - Pump To Injector	M50602071233000	DEF7036	Hose - Suction - Tank To Pump	M50603074320550	DEF7022
Hose - Turbo To Pipe (Hot Side)	D506039	26203	Hose - Return - Pump To Tank	M50602274110550	DEF7020
			Hose - Pressure - Pump To Injector	M50602072131300	DEF7050
			Hose - Turbo To Pipe (Hot Side)	D506039	26203
			Hose - Pipe To Intercooler (Hot Side)	D506039	26203
			Hose - Intercooler To Pipe (Cold Side)	D506039	26203
			Hose - Intercooler To Engine (Cold Side) ...	D506039	26203
			388		
			Belt - Serpentine - Fan; W/64 1/2" Belt O.C.	D841002121640	K120645HD
			Belt - Serpentine - A.C.	D841002071939	K070762HD

♣Standard Belt Available.

≈<Cut to Fit.

Belts and Coolant Hose for Medium/Heavy-Duty Trucks (2001 & Newer)

Application	Mfr. Part No.	Our No.	Application	Mfr. Part No.	Our No.
Peterbilt - Continued			Peterbilt - Continued		
2011 - Continued			2010		
Paccar MX Diesel - Continued			Caterpillar C13 Diesel		
388 - Continued			387		
Belt - Serpentine - Fan; W/73 1/2" Belt			Belt - Alt.	D8410006062175	▲K060858HD
O.C.	D841002121866	▲K120734HD	Belt - Fan & A.C.	D8410006102405	K100946HD
Tensioner Assy. - A.C.	1787113	38670	Tensioner Assy. - Alt.	2756558	38635
Idler Pulley - Fan	1787114	36359	Tensioner Assy. - Fan & A.C.	2873203	38646
Idler Pulley - A.C.	1787114	36359	Idler Pulley - Alt. (Upper)	2790251	36227
Hose - Upper - Rad. To Pipe		28359	Idler Pulley - Alt. (Lower)	2790251	36227
Hose - Suction - Tank To Pump	M50603274320450	DEF7056	Idler Pulley - Fan & A.C. (Grooved)	2850276	36164
Hose - Return - Pump To Tank	M50603474110500	DEF7001	Idler Pulley - Fan & A.C. (Smooth)	2850273	36164
Hose - Pressure - Pump To Injector	M50603371230800	DEF7000	Hose - Upper - Eng. To Pipe		24240
Hose - Turbo To Pipe (Hot Side)		26203	Hose - Upper - Pipe To Rad.		24240
Hose - Pipe To Intercooler (Hot Side)		26203	Hose - Lower - Eng. To Pipe		21891
Hose - Intercooler To Pipe (Cold Side)		26203	Hose - Lower - Pipe To Rad.		21891
Hose - Pipe To Engine (Cold Side)		26203			
587			Caterpillar C15 Diesel		
Belt - Fan	D841002121640	K120645HD	386		
Belt - A.C.	D841002011939	K070762HD	Belt - Fan	D8410006122490	K120980HD
Tensioner Assy. - A.C.	1787113	38670	Belt - A.C.	D8410006061870	K060736HD
Idler Pulley - Fan	1787114	36359	Tensioner Assy. - Fan	2362301	38609
Idler Pulley - A.C.	1787114	36359	Tensioner Assy. - A.C.	2790253	38636
Hose - Upper - Rad. To Pipe		28359	Idler Pulley - Fan (Lower)	2850277	36282
Hose - Upper - Pipe To Eng.		28212	Idler Pulley - A.C. (Upper)	2790252	36230
Hose - Lower - Rad. To Pipe		28212	Idler Pulley - A.C. (Lower)	2790252	36230
Hose - Lower - Pipe To Eng.		≧24848	Hose - Upper - Rad. To Pipe		28359
Hose - Suction - Tank To Pump	M50602274320500	DEF7002	Hose - Upper - Pipe To Eng.		≧28212
Hose - Return - Pump To Tank	M50602274110500	DEF7001	Hose - Lower - Rad. To Pipe		≧28212
Hose - Pressure - Pump To Injector	M50602072132500	DEF7052	Hose - Lower - Pipe To Eng.		≧24840
Hose - Turbo To Pipe (Hot Side)	D506039	26203			
Hose - Pipe To Intercooler (Hot Side)	D506039	26203	389		
Hose - Intercooler To Pipe (Cold Side)	D506039	26203	Belt - Fan & A.C.	D8410006122665	K121049HD
Hose - Pipe To Engine (Cold Side)	D506039	26203	Belt - Alt.	D8410006061750	▲K060690HD
			Tensioner Assy. - Fan & A.C.	3368955	38609
			Tensioner Assy. - Alt.	2790253	38636
			Idler Pulley - Fan & A.C. (Grooved)	2850277	36282
			Idler Pulley - Alt.	2790252	36230
			Hose - Upper - Rad. To Pipe		28359
			Hose - Upper - Pipe To Eng.		≧24840
			Hose - Lower - Rad. To Pipe		28212
			Hose - Lower - Pipe To Eng.		≧24840
			Hose - Turbo To Pipe (Hot Side)	D506040	26203
			Hose - Pipe To Intercooler (Hot Side)	D506040	26203
			Hose - Intercooler To Pipe (Cold Side)	D506040	26203
			Hose - Pipe To Engine (Cold Side)	D506040	26203
Paccar PX-6 Diesel			Cummins ISL Diesel		
325			320		
Belt - Fan	3289864	▲K080825HD	Belt - Fan	3972337	▲K080765HD
Hose - Upper		24840	Tensioner Assy.	3973819	38627
Hose - Lower		24832			
330			Cummins ISL9 Diesel		
Belt - Fan	3289864	▲K080825HD	365		
Hose - Upper - Rad. To Pipe		≧24840	Belt - Fan	D8410006060970	▲K060970HD
Hose - Upper - Pipe To Eng.		≧24828	Tensioner Assy. - Fan	3973819	38627
Hose - Lower		≧24832			
337			Cummins ISM Diesel		
Belt - Fan	3289864	▲K080825HD	320		
Hose - Upper - Eng. To Pipe		≧24828	Belt - Fan	D8410006081930	▲K080760HD
Hose - Upper - Pipe To Rad.		≧24840	Belt - A.C.	4004824	▲K060539HD
			Tensioner Assy. - Fan	2871294	38622
Paccar PX-8 Diesel					
337			384		
Belt - Fan	4933083	▲K080842HD	Belt - Fan & Alt.	D8410006081735	K080683HD
Tensioner Assy.	3973819	38627	Belt - A.C.	4004824	▲K060539HD
Idler Pulley	3970945	36283	Tensioner Assy. - Fan & Alt.	4920105	38622
Hose - Upper - Eng. To Pipe		≧24840	Tensioner Assy. - A.C.	3102888	38505
Hose - Upper - Pipe To Rad.		28359	Idler Pulley - Fan & Alt.	3400884	36308
Hose - Lower - Eng. To Pipe		≧24836			
Hose - Lower - Pipe To Rad.		≧24836			
348					
Belt - Fan	4933083	▲K080842HD			
Tensioner Assy.	3973819	38627			
Idler Pulley	3970945	36283			
Hose - Upper - Eng. To Pipe; Cut at 6"		24840			
Hose - Upper - Pipe To Rad.		28359			
Hose - Lower - Eng. To Pipe; Cut at 6"		24836			
Hose - Lower - Pipe To Rad.; Cut at 6"		24836			
Hose - Pressure - Tank To Pump	M50602274110550	DEF7020			
Hose - Return - Tank To Pump	M50602274320600	DEF7014			

Medium & Heavy-Duty Trucks
(2001 & Newer)

≧Cut to Fit.

▲Standard Belt Available.

Belts and Coolant Hose for Medium/Heavy-Duty Trucks (2001 & Newer)

 Medium & Heavy-Duty Trucks
(2001 & Newer)

Application	Mfr. Part No.	Our No.	Application	Mfr. Part No.	Our No.
Peterbilt - Continued			Peterbilt - Continued		
2010 - Continued			2010 - Continued		
Cummins ISX11.9 Diesel			Cummins ISX15 Diesel - Continued		
386			389 - Continued		
Belt - Alt. & A.C.	D8410006061535	♣K060605HD	Tensioner Assy. - A.C.	3104149	38610
Tensioner Assy. - Fan	4920105	38622	Tensioner Pulley - Fan & Alt.	2871292	36165
Tensioner Assy. - Alt. & A.C.	3104149	38610	Idler Pulley - A.C.	3682229	36223
Idler Pulley - Alt. & A.C.	3682229	36223	Hose - Upper - Eng. To Pipe		21891
Hose - Upper - Rad. To Pipe		28359	Hose - Upper - Pipe To Rad.		28359
Hose - Upper - Pipe To Eng.		28212	Hose - Lower - Eng. To Pipe		≈<24240
Hose - Lower - Rad. To Pipe		≈<24840	Hose - Lower - Pipe To Rad.		≈<24240
Hose - Lower - Pipe To Eng.		≈<24840			
Hose - Suction - Tank To Pump	M50602274320600	DEF7014	Paccar MX Diesel		
Hose - Return - Pump To Tank	M50603474110550	DEF7020	367		
Hose - Pressure - Pump To Injector; W/800mm Line	M50603371230800	DEF7000	Belt - Fan	D841002121640	K120645HD
Hose - Turbo To Pipe (Hot Side)	D506039	26203	Belt - A.C.	D841002011939	K070762HD
Hose - Pipe To Intercooler (Hot Side)	D506039	26203	Tensioner Assy. - A.C.	1787113	38670
Hose - Intercooler To Pipe (Cold Side)	D506039	26203	Idler Pulley - Fan	1787114	36359
Hose - Pipe To Engine (Cold Side)	D506039	26203	Idler Pulley - A.C.	1787114	36359
			Paccar PX-6 Diesel		
Cummins ISX15 Diesel			325		
367			Belt - Fan	4945003	♣K080926HD
Belt - Fan, W.P. & Alt.	D8410006122215	♣K120872HD	Tensioner Assy.	5264111	38631
Belt - A.C.	D8410006061620	♣K060637HD	Hose - Upper		24840
Tensioner Assy. - Fan, W.P. & Alt.	3682946	38587	Hose - Lower		24832
Tensioner Assy. - A.C.	3104149	38610			
Tensioner Pulley - Fan, W.P. & Alt.	3682946	36165	330; 335		
Idler Pulley - A.C.	3682229	36223	Belt - Fan	4945003	♣K080926HD
Hose - Upper - Pipe To Rad.		28359	Tensioner Assy.	5264111	38631
Hose - Upper - Eng. To Pipe		21891	Hose - Upper - Eng. To Pipe		≈<24840
Hose - Lower - Eng. To Pipe		≈<24240	Hose - Upper - Pipe To Rad.		≈<24832
Hose - Lower - Pipe To Rad.		≈<24240	Hose - Lower - Eng. To Pipe		≈<24840
			Hose - Lower - Pipe To Rad.		≈<24828
386			Paccar PX-8 Diesel		
Belt - Fan & Alt.	D8410006122215	♣K120872HD	335; 337; 340; 348		
Belt - A.C.	D8410006061620	♣K060637HD	Belt - Fan	4933083	♣K080842HD
Tensioner Assy. - Fan & Alt.	2871292	38587	Tensioner Assy.	3973819	38627
Tensioner Assy. - A.C.	3104149	38610	Idler Pulley	3970945	36283
Tensioner Pulley - Fan & Alt.	3682946	36165	Hose - Upper - Pipe To Rad.		28359
Idler Pulley - A.C.	3682229	36223	Hose - Upper - Eng. To Pipe		≈<24840
Hose - Upper - Eng. To Pipe		21891	Hose - Lower - Eng. To Pipe		≈<24836
Hose - Upper - Pipe To Rad.		28359	Hose - Lower - Pipe To Rad.		≈<24836
Hose - Lower - Eng. To Pipe		≈<24240			
Hose - Lower - Pipe To Rad.		≈<24240	2009		
			Caterpillar C13 Diesel		
387			384		
Belt - Fan & Alt.	D8410006122215	♣K120872HD	Belt - Alt.	D8410006062175	♣K060858HD
Belt - A.C.	D8410006061620	♣K060637HD	Belt - Fan & A.C.	D8410006102405	K100946HD
Tensioner Assy. - Fan & Alt.	3682946	38587	Tensioner Assy. - Alt.	2756558	38635
Tensioner Assy. - A.C.	3104149	38610	Tensioner Assy. - Fan & A.C.	2873203	38646
Tensioner Pulley - Fan & Alt.	3682946	36165			
Idler Pulley - A.C.	3682229	36223	386; 387		
Hose - Upper - Eng. To Pipe		21891	Belt - Alt.	D8410006062175	♣K060858HD
Hose - Upper - Pipe To Rad.		28359	Belt - Fan & A.C.	D8410006102405	K100946HD
Hose - Lower - Eng. To Pipe		≈<24240	Tensioner Assy. - Alt.	2756558	38635
Hose - Lower - Pipe To Rad.		≈<24240	Tensioner Assy. - Fan & A.C.	2873203	38646
			Idler Pulley - Alt. (Upper)	2790251	36227
388			Idler Pulley - Alt. (Lower)	2790251	36227
Belt - A.C.	D8410003061620	♣K060637HD	Idler Pulley - Fan & A.C. (Grooved)	2850276	36164
Tensioner Assy. - Fan & Alt.	3682946	38587	Idler Pulley - Fan & A.C. (Smooth)	2850273	36164
Tensioner Assy. - A.C.	3104149	38610	Hose - Upper - Eng. To Pipe		24240
Tensioner Pulley - Fan & Alt.	2871292	36165	Hose - Upper - Pipe To Rad.		24240
Idler Pulley - A.C.	3682229	36223	Hose - Lower - Eng. To Pipe		21891
Hose - Upper - Eng. To Pipe		21891	Hose - Lower - Pipe To Rad.		21891
Hose - Upper - Pipe To Rad.		28359			
Hose - Lower - Eng. To Pipe		≈<24240	Caterpillar C15 Diesel		
Hose - Lower - Pipe To Rad.		≈<24240	388; 389		
			Belt - Fan To Alt.	D8410006061750	♣K060690HD
389			Belt - Fan & A.C.	D8410006122665	K121049HD
Belt - Fan & Alt.	D8410006122310	♣K120911HD	Tensioner Assy. - Alt.	2790253	38636
Belt - A.C.	D8410003061620	♣K060637HD			
Tensioner Assy. - Fan & Alt.	3682946	38587			

≈<Cut to Fit.

♣Standard Belt Available.

Belts and Coolant Hose for Medium/Heavy-Duty Trucks (2001 & Newer)

Application	Mfr. Part No.	Our No.	Application	Mfr. Part No.	Our No.
Peterbilt - Continued			Peterbilt - Continued		
2009 - Continued			2009 - Continued		
Caterpillar C15 Diesel - Continued			Cummins ISX Diesel - Continued		
388; 389 - Continued			388		
Tensioner Assy. - Fan & A.C.	2362301	38609	Belt - Fan & Alt.	D841000612310	K120910HD
Idler Pulley - Alt. (Upper)	2790252	36230	Belt - Hub & A.C.	D8410003061620	▲K060637HD
Idler Pulley - Alt. (Lower)	2790252	36230	Tensioner Assy. - Fan & Alt.	3682946	38587
Idler Pulley - Fan (Lower)	2850277	36282	Tensioner Assy. - Hub & A.C.	3104149	38610
Cummins ISC Diesel			Hose - Upper - Eng. To Pipe		
340			Hose - Upper - Pipe To Rad.		
Belt - Fan & W.P.	3972261	▲K080760HD	Hose - Lower - Eng. To Pipe		
Tensioner Assy. - Fan & A.C.	3973819	38627	Hose - Lower - Pipe To Rad.		
Idler Pulley	3970945	36283	389		
Cummins ISL Diesel			Belt - Fan & Alt.		
320			Belt - A.C.		
Belt - Fan	3972337	▲K080765HD	Tensioner Assy. - Fan & Alt.		
Tensioner Assy.	3973819	38627	Tensioner Assy. - A.C.		
Cummins ISM Diesel			Tensioner Pulley - Fan & Alt.		
320			Idler Pulley - A.C.		
Belt - Fan & Alt.		▲K080740HD	Hose - Upper - Eng. To Pipe		
Belt - A.C.	4004824	▲K060539HD	Hose - Upper - Pipe To Rad.		
Tensioner Assy. - Fan & Alt.	3400885	38521	Hose - Lower - Eng. To Pipe		
Tensioner Assy. - A.C.	3102888	38505	Hose - Lower - Pipe To Rad.		
Idler Pulley - Fan & Alt.	3400884	36308	Paccar PX-6 Diesel		
Idler Pulley - A.C.	3104139	36225	325		
Tensioner Pulley - A.C.	3102888	36091	Belt - Fan		
Cummins ISX Diesel			Tensioner Assy.		
367			Hose - Upper		
Belt - Fan, W.P. & Alt.	D8410006122215	▲K120872HD	Hose - Lower		
Belt - A.C. - From W.P.	D8410006061620	▲K060637HD	330; 335		
Tensioner Assy. - Fan, W.P. & Alt.	3682946	38587	Belt - Fan		
Tensioner Assy. - A.C.	3104149	38610	Tensioner Assy.		
Tensioner Pulley - Fan, W.P. & Alt.	3682946	36165	Hose - Upper - Eng. To Pipe		
Idler Pulley - A.C.	3682229	36223	Hose - Upper - Pipe To Rad.		
Hose - Upper - Eng. To Pipe		≅28212	Hose - Lower - Eng. To Pipe		
Hose - Upper - Pipe To Rad.		28359	Hose - Lower - Pipe To Rad.		
Hose - Lower - Eng. To Pipe		≅24440	Paccar PX-8 Diesel		
Hose - Lower - Pipe To Rad.		≅28212	335		
Cummins ISX Diesel			Belt - Fan		
386			Tensioner Assy.		
Belt - Fan, W.P. & Alt.	D8410006122215	▲K120872HD	Idler Pulley		
Belt - A.C. - From W.P.	D8410006061620	▲K060637HD	Hose - Upper - Eng. To Pipe		
Tensioner Assy. - Fan, W.P. & Alt.	3682946	38587	Hose - Upper - Pipe To Rad.		
Tensioner Assy. - A.C.	3104149	38610	Hose - Lower - Eng. To Pipe		
Tensioner Pulley - Fan, W.P. & Alt.	3682946	36165	Hose - Lower - Pipe To Rad.		
Idler Pulley - A.C.	3682229	36223	340		
Hose - Upper - Eng. To Pipe		≅28212	Belt - Fan, Alt. & A.C.		
Hose - Upper - Pipe To Rad.		28359	Tensioner Assy. - Fan, Alt. & A.C.		
Hose - Lower - Eng. To Pipe		24240	Idler Pulley		
Hose - Lower - Pipe To Rad.		≅28212	Hose - Upper - Eng. To Pipe		
Cummins ISX Diesel			Hose - Upper - Pipe To Rad.		
387			Hose - Lower - Eng. To Pipe		
Belt - Fan, W.P. & Alt.	D8410006122215	▲K120872HD	Hose - Lower - Pipe To Rad.		
Belt - A.C. - From W.P.	D8410006061620	▲K060637HD	2008		
Tensioner Assy. - Fan, W.P. & Alt.	3682946	38587	Caterpillar C9 Diesel		
Tensioner Assy. - A.C.	3104149	38610	365		
Tensioner Pulley - Fan, W.P. & Alt.	3682946	36165	Belt - Fan, A.C., Alt. & W.P.; W/95 1/8" Belt		
Idler Pulley - A.C.	3682229	36223	O.C.		
Hose - Upper - Eng. To Pipe		21891	D8410006102415		
Hose - Upper - Pipe To Rad.		28359	D8410006102565		
Hose - Lower - Eng. To Pipe		≅24240	Belt - Fan, A.C., Alt. & W.P.; W/130A. Alt. ...		
Hose - Lower - Pipe To Rad.		≅24240	Idler Pulley - Upper (Smooth)		
Cummins ISX Diesel			Idler Pulley - Lower (Smooth)		
367			384		
Belt - Fan, W.P. & Alt.	D8410006122215	▲K120872HD	Idler Pulley - Smooth		
Belt - A.C. - From W.P.	D8410006061620	▲K060637HD			
Tensioner Assy. - Fan, W.P. & Alt.	3682946	38587			
Tensioner Assy. - A.C.	3104149	38610			
Tensioner Pulley - Fan, W.P. & Alt.	3682946	36165			
Idler Pulley - A.C.	3682229	36223			
Hose - Upper - Eng. To Pipe		21891			
Hose - Upper - Pipe To Rad.		28359			
Hose - Lower - Eng. To Pipe		≅24240			
Hose - Lower - Pipe To Rad.		≅24240			

▲Standard Belt Available.

≅Cut to Fit.

Medium & Heavy-Duty Trucks
(2001 & Newer)

Belts and Coolant Hose for Medium/Heavy-Duty Trucks (2001 & Newer)

Medium & Heavy-Duty Trucks
(2001 & Newer)

Application	Mfr. Part No.	Our No.
Peterbilt - Continued		
2008 - Continued		
Caterpillar C13 Diesel		
365		
Belt - Alt.	D8410006062175	♣K060858HD
Belt - Fan & A.C.	D8410006102405	K100946HD
Tensioner Assy. - Alt.	2756558	38635
Tensioner Assy. - Fan & A.C.	2873203	38646
Hose - Upper - Eng. To Pipe		24240
Hose - Upper - Pipe To Rad.		24240
Hose - Lower - Eng. To Pipe		21891
Hose - Lower - Pipe To Rad.		21891
384		
Belt - Alt.	D8410006062175	♣K060858HD
Belt - Fan & A.C.	D8410006102405	K100946HD
Tensioner Assy. - Alt.	2756558	38635
Tensioner Assy. - Fan & A.C.	2873203	38646
386		
Belt - Alt.	D8410003062175	♣K060858HD
Belt - Fan & A.C.	D8410006102405	K100946HD
Tensioner Assy. - Alt.	2756558	38635
Tensioner Assy. - Fan & A.C.	2873203	38646
Idler Pulley - Alt. (Upper)	2790251	36227
Idler Pulley - Alt. (Lower)	2790251	36227
Idler Pulley - Fan & A.C. (Grooved)	2850276	36164
Idler Pulley - Fan & A.C. (Smooth)	2850273	36164
Hose - Upper - Eng. To Pipe		21891
Hose - Upper - Pipe To Rad.		24240
Hose - Lower - Eng. To Pipe		21891
Hose - Lower - Pipe To Rad.		21891
388		
Belt - Alt.	D8410006062175	♣K060858HD
Belt - Fan & A.C.	D8410006102565	K101010HD
Caterpillar C15 Diesel		
367; 386		
Belt - Fan & Alt.	D8410006061870	K060736HD
Belt - Fan & A.C.	D8410006122490	K120980HD
Tensioner Assy. - Fan & Alt.	2790253	38636
Tensioner Assy. - Fan & A.C.	2362301	38609
Idler Pulley - Alt.	2790252	36230
Idler Pulley - A.C.; W/V-Groove Idler Pulley .	2850277	36282
Hose - Upper - Eng. To Pipe		21891
Hose - Upper - Pipe To Rad.		24240
Hose - Lower - Eng. To Pipe		24240
Hose - Lower - Pipe To Rad.		21891
387		
Belt - Fan & Alt.	D8410006061870	K060736HD
Belt - Fan & A.C.	D8410006122490	K120980HD
Tensioner Assy. - Fan & Alt.	2790253	38636
Tensioner Assy. - Fan & A.C.	2362301	38609
Idler Pulley - Alt.	2790252	36230
Idler Pulley - Fan & A.C. (Grooved)	2850277	36282
Hose - Upper - Eng. To Pipe		21891
Hose - Upper - Rad. To Pipe		24240
Hose - Lower - Eng. To Pipe		24240
Hose - Lower - Rad. To Pipe		21891
388		
Belt - Fan & Alt.	D8410001082420	♣K080952HD
Belt - Fan To A.C.	D8410006061750	K060568HD
Tensioner Assy. - Fan & Alt.	2002279	38569
Tensioner Assy. - Fan To A.C.	2178938	38511
Tensioner Pulley - Fan To A.C.	2178938	36091
Idler Pulley - Grooved	1979642	36341
Idler Pulley - Smooth	1979641	36091
Hose - Upper - Eng. To Pipe		24240
Hose - Upper - Pipe To Rad.		24240
Hose - Lower - Eng. To Pipe		24248
Hose - Lower - Pipe To Pipe		24240

♣Standard Belt Available.

Application	Mfr. Part No.	Our No.
Peterbilt - Continued		
2008 - Continued		
Caterpillar C15 Diesel - Continued		
388 - Continued		
Hose - Lower - Pipe To Rad.		21891
389		
Belt - Fan & Alt.	D8410006061750	♣K060690HD
Belt - Fan & A.C.	D8410006122665	K121049HD
Tensioner Assy. - Fan & Alt.	2790253	38636
Tensioner Assy. - Fan & A.C.	2362301	38609
Idler Pulley - Alt.	2790252	36230
Idler Pulley - A.C.; W/V-Groove Idler Pulley .	2850277	36282
Hose - Upper - Eng. To Pipe		24240
Hose - Upper - Pipe To Rad.		24240
Hose - Lower - Eng. To Pipe		24240
Hose - Lower - Pipe To Rad.		21891
Cummins ISC Diesel		
340		
Belt - Fan & W.P.	3972261	♣K080760HD
Tensioner Assy. - Fan & A.C.	3973819	38627
Idler Pulley	3970945	36283
Cummins ISM Diesel		
320		
Belt - Fan & Alt.		♣K080740HD
Belt - A.C.	4004824	♣K060539HD
Tensioner Assy. - Fan & Alt.	3400885	38521
Tensioner Assy. - A.C.	3102888	38505
Tensioner Pulley - A.C.	3102888	36091
Idler Pulley - Fan & Alt.	3400884	36308
Idler Pulley - A.C.	3104139	36225
365		
Belt - Fan & Alt.	D8410006081735	K080683HD
Belt - A.C.	4004824	♣K060539HD
Tensioner Assy. - Fan & Alt.	4920105	38622
Tensioner Assy. - A.C.	3102888	38505
Idler Pulley - Fan & Alt.	3400884	36308
Idler Pulley - A.C.	3104139	36225
384		
Belt - Fan	D8410006081735	K080683HD
Belt - A.C.	4004824	♣K060539HD
Tensioner Assy. - Fan	2871294	38622
Tensioner Assy. - A.C.	3102888	38505
Idler Pulley - Fan & Alt.	3400884	36308
Idler Pulley - A.C.	3104139	36225
386; 388		
Idler Pulley - Fan & Alt.	3400884	36308
Cummins ISX Diesel		
367		
Belt - Fan & Alt.		♣K120872HD
Belt - Hub & A.C.	D11085527	♣K060637HD
Tensioner Assy. - Fan & Alt.	3682946	38587
Tensioner Assy. - Hub & A.C.	3682683	38610
Tensioner Pulley - Fan & Alt.	3682946	36165
Idler Pulley - A.C.	3682229	36223
Hose - Upper - Eng. To Pipe		≈21891
Hose - Upper - Pipe To Rad.		28359
Hose - Lower - Eng. To Pipe		≈24240
Hose - Lower - Pipe To Rad.		≈24240
386		
Belt - Fan & Alt.	D8410006122215	♣K120872HD
Belt - A.C.	D8410006061620	♣K060637HD
Tensioner Assy. - Fan & Alt.	3682946	38587
Tensioner Assy. - A.C.	3682683	38610
Tensioner Pulley - Fan & Alt.	3682946	36165
Idler Pulley - A.C.	3682229	36223
Hose - Upper - Eng. To Pipe		21891
Hose - Upper - Pipe To Rad.		24240
Hose - Lower - Eng. To Pipe		24240

≈Cut to Fit.

Belts and Coolant Hose for Medium/Heavy-Duty Trucks (2001 & Newer)

Application	Mfr. Part No.	Our No.	Application	Mfr. Part No.	Our No.
Peterbilt - Continued			Peterbilt - Continued		
2008 - Continued			2007 - Continued		
Cummins ISX Diesel - Continued			Caterpillar C7 Diesel - Continued		
386 - Continued			330 - Continued		
Hose - Lower - Pipe To Rad.		24240	Hose - Upper - Eng. To Pipe		24232
387			Hose - Upper - Pipe To Rad.		24236
Belt - Fan & Alt.	D8410006122215	♣K120872HD	Hose - Lower - Pipe To Rad.		24236
Belt - A.C.	D8410006061620	♣K060637HD	335		
Tensioner Assy. - Fan & Alt.	3682946	38587	Belt - Fan, A.C., Alt. & W.P.	D8410001082175	♣K080859HD
Tensioner Assy. - A.C.	3104149	38610	Tensioner Assy. - Fan, A.C., Alt. & W.P.	2222880	38586
Tensioner Pulley - Fan & Alt.	3682946	36165	Idler Pulley - Upper	1979641	36091
Idler Pulley - A.C.	3682229	36223	Idler Pulley - Lower	2534525	36096
Hose - Upper - Eng. To Pipe		21891	340		
Hose - Upper - Pipe To Rad.		≧24240	Belt - Fan, A.C., Alt. & W.P.	D8410001082175	♣K080859HD
Hose - Lower - Eng. To Pipe		≧24240	Tensioner Assy. - Fan, A.C., Alt. & W.P.	2222880	38586
Hose - Lower - Pipe To Rad.		≧24240	Idler Pulley - Upper	1979641	36091
388			Idler Pulley - Lower	2534525	36096
Belt - Fan & Alt.	D8410006122310	♣K120911HD	Hose - Upper - Eng. To Pipe		24232
Belt - A.C.	D8410006061620	♣K060637HD	Hose - Upper - Pipe To Rad.		20397
Tensioner Assy. - Fan & Alt.	3682946	38587	Hose - Lower - Pipe To Rad.		24236
Tensioner Assy. - A.C.	3104149	38610	Caterpillar C9 Diesel		
Idler Pulley - A.C.	3682229	36223	357		
389			Belt - Serpentine	D8410005082385	♣K080939HD
Belt - Fan & Alt.	D8410006122310	♣K120911HD	Tensioner Assy.	2222880	38586
Belt - A.C.	D8410006061620	♣K060637HD	Idler Pulley	1979641	36091
Tensioner Assy. - Fan & Alt.	3682946	38587	Caterpillar C11 Diesel		
Tensioner Assy. - A.C.	3682683	38610	357		
Tensioner Pulley - Fan & Alt.	3682946	36165	Belt - Fan, Alt. & A.C.	D11085891	♣K081020HD
Idler Pulley - A.C.	3682229	36223	Tensioner Assy. - Fan, Alt. & A.C.	2117895	38590
Hose - Upper - Eng. To Pipe		21891	Tensioner Pulley - Fan, Alt. & A.C.	2117895	36164
Hose - Upper - Pipe To Rad.		24240	Idler Pulley - Grooved	1979642	36341
Hose - Lower - Eng. To Pipe		24240	Idler Pulley - Smooth	2078118	36269
Hose - Lower - Pipe To Rad.		21891	Hose - Upper - Eng. To Pipe		24240
Paccar PX-6 Diesel			Hose - Upper - Pipe To Rad.		24240
325			Hose - Lower - Eng. To Pipe		24240
Belt - Fan	4945003	♣K080926HD	Hose - Lower - Pipe To Rad.		24244
Tensioner Assy.	5264111	38631	378		
Hose - Upper		24840	Belt - Fan, Alt. & A.C.	D11085891	♣K081020HD
Hose - Lower		24832	Tensioner Assy. - Fan, Alt. & A.C.	2117895	38590
330; 335			Tensioner Pulley - Fan, Alt. & A.C.	2117895	36164
Belt - Fan	4945003	♣K080926HD	Idler Pulley - Grooved	1979642	36341
Tensioner Assy.	5264111	38631	Idler Pulley - Smooth	2078118	36269
Hose - Upper - Eng. To Pipe		≧24840	385		
Hose - Upper - Pipe To Rad.		≧24832	Idler Pulley - Grooved	1979642	36341
Hose - Lower - Eng. To Pipe		≧24840	Idler Pulley - Smooth	2078118	36269
Hose - Lower - Pipe To Rad.		≧24828	Caterpillar C13 Diesel		
Paccar PX-8 Diesel			357		
335; 340			Belt - Fan, Alt. & A.C.	D11085891	♣K081020HD
Belt - Fan, Alt. & A.C.	3972381	K080931HD	Tensioner Assy. - Fan, Alt. & A.C.	2117895	38590
Tensioner Assy. - Fan, Alt. & A.C.	3973819	38627	Tensioner Pulley - Fan, Alt. & A.C.	2117895	36164
Idler Pulley	3970945	36283	Idler Pulley - Grooved	1979642	36341
Hose - Upper - Eng. To Pipe		24236	Idler Pulley - Smooth	2078118	36269
Hose - Upper - Pipe To Rad.		24240	Hose - Upper - Eng. To Pipe		24240
Hose - Lower - Eng. To Pipe		24236	Hose - Upper - Pipe To Rad.		24240
Hose - Lower - Pipe To Cooler		24236	Hose - Lower - Eng. To Pipe		24240
Hose - Lower - Cooler To Rad.		21194	Hose - Lower - Pipe To Rad.		24244
2007			378		
Caterpillar C7 Diesel			Belt - Fan, Alt. & A.C.	D8410003082560	♣K081005HD
320			Tensioner Assy. - Fan, Alt. & A.C.	2117895	38590
Idler Pulley - Upper	1979641	36091	Tensioner Pulley - Fan, Alt. & A.C.	2117895	36164
Idler Pulley - Lower	2534525	36096	Idler Pulley - Grooved	1979642	36341
330			Idler Pulley - Smooth	2078118	36269
Belt - Fan, A.C., Alt. & W.P.	D8410001082175	♣K080859HD	379		
Tensioner Assy. - Fan, A.C., Alt. & W.P.	2222880	38586	Belt - Fan, Alt., P.S. & A.C.	D8410006082600	♣K081023HD
Idler Pulley - Upper	1979641	36091	Tensioner Assy. - Fan, Alt., P.S. & A.C.	2117895	38590
Idler Pulley - Lower	2534525	36096	Tensioner Pulley - Fan, Alt., P.S. & A.C.	2117895	36164
			Idler Pulley - Grooved	1979642	36341

♣Standard Belt Available.

≧Cut to Fit.

Medium & Heavy-Duty Trucks
(2001 & Newer)

Belts and Coolant Hose for Medium/Heavy-Duty Trucks (2001 & Newer)

Medium & Heavy-Duty Trucks
(2001 & Newer)

Application	Mfr. Part No.	Our No.	Application	Mfr. Part No.	Our No.
Peterbilt - Continued			Peterbilt - Continued		
2007 - Continued			2007 - Continued		
Caterpillar C13 Diesel - Continued			Cummins ISC Diesel		
379 - Continued			320; 330		
Idler Pulley - Smooth	2078118	36269	Idler Pulley	3970945	36283
385; 386			335		
Belt - Fan, Alt. & A.C.	4080957RPDYC	♣K080956HD	Belt - Fan, Alt. & Hub	3972261	♣K080760HD
Tensioner Assy. - Fan, Alt. & A.C.	2117895	38590	Belt - Fan To A.C.	D11023329	♣9390HD
Tensioner Pulley - Fan, Alt. & A.C.	2117895	36164	Tensioner Assy. - Fan, Alt. & Hub	3936213	38516
Idler Pulley - Grooved	1979642	36341	Tensioner Pulley - Fan, Alt. & Hub	3936213	36093
Idler Pulley - Smooth	2078118	36269	Idler Pulley	3970945	36283
Caterpillar C15 Diesel			Hose - Upper - Eng. To Pipe		
357; 378			Hose - Upper - Pipe To Rad.		
Belt - Fan & Alt.	D8410003122640	♣K121039HD	Hose - Lower - Eng. To Pipe		20748
Belt - Fan To A.C.	D8410003061310	♣K060516HD	Hose - Lower - Pipe To Rad.		21194
Tensioner Assy. - Fan & Alt.	2362301	38609	Hose - Lower - Eng. To Pipe		20748
Tensioner Assy. - Fan To A.C.	2178938	38511	Hose - Lower - Pipe To Rad.		24236
Tensioner Pulley - Fan To A.C.	2178938	36091	Hose - Lower - Cooler To Pipe		24236
Idler Pulley - Grooved	1979642	36341	340		
Idler Pulley - Smooth	1979641	36091	Belt - Fan & W.P.	3972261	♣K080760HD
Hose - Upper - Eng. To Pipe		24240	Tensioner Assy. - Fan & A.C.	3973819	38627
Hose - Upper - Pipe To Rad.		24240	Idler Pulley	3970945	36283
Hose - Lower - Eng. To Pipe		24248	357		
Hose - Lower - Pipe To Pipe		24248	Idler Pulley		
Hose - Lower - Pipe To Rad.		24248	3970945 36283		
379			Cummins ISM Diesel		
Belt - Fan & Alt.; W/8-Ribbed Belt	D8410001082520	♣K080991HD	320		
Belt - Fan & Alt.; W/12-Ribbed Belt	D8410003122640	♣K121039HD	Belt - Fan & Alt.		
Belt - Fan To A.C.; W/52" Belt O.C.	D8410003061310	♣K060516HD	Belt - A.C.		
Belt - Fan To A.C.; W/53" Belt O.C.	D8410003061340	♣K060525HD	Tensioner Assy. - Fan & Alt.		
Tensioner Assy. - Fan & Alt.; W/8-Ribbed Belt	2002279	38569	Tensioner Assy. - A.C.		
Tensioner Assy. - Fan & Alt.; W/12-Ribbed Belt	2362301	38609	Tensioner Pulley - A.C.		
Tensioner Assy. - Fan To A.C.	2178938	38511	Idler Pulley - Fan & Alt.		
Tensioner Pulley - Fan To A.C.	2178938	36091	Idler Pulley - A.C.		
Idler Pulley - Grooved	1979642	36341	3104139 36225		
Idler Pulley - Smooth	1979641	36091	357		
Hose - Upper - Eng. To Pipe		24240	Belt - Fan & Alt.		
Hose - Upper - Pipe To Rad.		24240	Belt - Hub & A.C.		
Hose - Lower - Eng. To Pipe		24248	Tensioner Assy. - Fan & Alt.		
Hose - Lower - Pipe To Pipe		24248	Tensioner Assy. - Hub & A.C.		
Hose - Lower - Pipe To Rad.		24248	Tensioner Pulley - Hub & A.C.		
386			Idler Pulley - Fan & Alt.		
Belt - Fan & Alt.	D8410003122500	K120985HD	Idler Pulley - A.C.		
Belt - A.C.	D11085664	K060568HD	3104139 36225		
Tensioner Assy. - Fan & Alt.	2362301	38609	Hose - Upper - Eng. To Pipe		
Tensioner Assy. - A.C.	2178938	38511	Hose - Upper - Pipe To Rad.		
Idler Pulley - Grooved	1979642	36341	Hose - Lower - Eng. To Pipe		
Idler Pulley - Smooth	1979641	36091	Hose - Lower - Pipe To Pipe		
Hose - Upper - Eng. To Pipe		24240	Hose - Lower - Pipe To Rad.		
Hose - Upper - Pipe To Rad.		24240	24240		
Hose - Lower - Eng. To Pipe		24248	365		
Hose - Lower - Pipe To Rad.		24248	Belt - Fan & Alt.		
387; 388			Belt - Hub & A.C.		
Belt - Fan & Alt.	D8410001082420	♣K080952HD	Tensioner Assy. - Fan & Alt.		
Belt - Fan To A.C.	D8410003061440	K060568HD	Tensioner Assy. - Hub & A.C.		
Tensioner Assy. - Fan & Alt.	2002279	38569	Tensioner Pulley - Hub & A.C.		
Tensioner Assy. - Fan To A.C.	2178938	38511	Idler Pulley - Fan & Alt.		
Tensioner Pulley - Fan To A.C.	2178938	36091	Idler Pulley - A.C.		
Idler Pulley - Grooved	1979642	36341	3104139 36225		
Idler Pulley - Smooth	1979641	36091	Hose - Upper - Eng. To Pipe		
Hose - Upper - Eng. To Rad.		24240	Hose - Upper - Pipe To Rad.		
Hose - Upper - Rad. To Pipe		24240	Hose - Lower - Eng. To Pipe		
Hose - Lower - Eng. To Pipe		24248	Hose - Lower - Pipe To Pipe		
Hose - Lower - Pipe To Pipe		24240	Hose - Lower - Pipe To Rad.		
Hose - Lower - Pipe To Rad.		21891	24240		

♣Standard Belt Available.

♣Cut to Fit.

Belts and Coolant Hose for Medium/Heavy-Duty Trucks (2001 & Newer)

Application	Mfr. Part No.	Our No.	Application	Mfr. Part No.	Our No.
Peterbilt - Continued			Peterbilt - Continued		
2007 - Continued			2006 - Continued		
Cummins ISM Diesel - Continued			Caterpillar C7 Diesel - Continued		
379			320 - Continued		
Idler Pulley - Fan & Alt.	3400884	36308	Idler Pulley - Upper	1979641	36091
385			Idler Pulley - Lower	2534525	36096
Belt - Fan & Alt.		♣K080774HD	Hose - Upper - Rad. To Pipe		≈24240
Belt - Hub & A.C.	4004824	♣K060539HD	Hose - Upper - Pipe To Eng.		≈24232
Tensioner Assy. - Fan & Alt.	3400885	38521	Hose - Lower - Rad. To Pipe		≈24248
Tensioner Assy. - Hub & A.C.	3102888	38505	Hose - Lower - Pipe To Eng.		≈24240
Idler Pulley - Fan & Alt.	3400884	36308	335		
Cummins ISX Diesel			Belt - Fan, A.C., Alt. & W.P.	D8410001082175	♣K080859HD
367			Tensioner Assy. - Fan, A.C., Alt. & W.P.	2222880	38586
Belt - Fan & Alt.		♣K120872HD	Idler Pulley - Upper	1979641	36091
Belt - A.C.	D1108527	♣K060637HD	Idler Pulley - Lower	2534525	36096
Tensioner Assy. - Fan & Alt.	3682946	38587	Hose - Upper - Eng. To Pipe		24232
Tensioner Assy. - A.C.	3682683	38610	Hose - Upper - Pipe To Rad.		20397
Tensioner Pulley - Fan & Alt.	3682946	36165	Hose - Lower - Pipe To Rad.		24236
Idler Pulley - A.C.	3682229	36223	Caterpillar C10 Diesel		
Hose - Upper - Eng. To Pipe		21891	320		
Hose - Upper - Pipe To Rad.		24240	Belt - Serpentine	910K8BLT	♣K080903HD
Hose - Lower - Eng. To Pipe		24240	Tensioner Assy.	1900649	38506
Hose - Lower - Pipe To Rad.		24240	Tensioner Pulley		36091
378; 379			Caterpillar C11 Diesel		
Belt - Fan & Alt.; W/130A. Alt.	D8410001122295	♣K120903HD	357		
Belt - Fan & Alt.; W/135A. Alt.	D11085234	♣K120891HD	Belt - Fan, Alt. & A.C.	D11085891	♣K081020HD
Belt - Hub & A.C.	D8410003061620	♣K060637HD	Tensioner Assy. - Fan, Alt. & A.C.	2117895	38590
Tensioner Assy. - Fan & Alt.	3682946	38587	Tensioner Pulley - Fan, Alt. & A.C.	2117895	36164
Tensioner Assy. - Hub & A.C.	3682683	38610	Idler Pulley - Grooved	1979642	36341
Tensioner Pulley - Fan & Alt.	3682946	36165	Idler Pulley - Smooth	2078118	36269
Idler Pulley - A.C.	3682229	36223	Hose - Upper - Eng. To Pipe		24240
Hose - Upper - Eng. To Pipe		24240	Hose - Upper - Pipe To Rad.		24240
Hose - Upper - Pipe To Rad.		24240	Hose - Lower - Eng. To Pipe		21891
Hose - Lower - Eng. To Pipe		24240	Hose - Lower - Pipe To Pipe		24248
Hose - Lower - Pipe To Rad.		24248	Hose - Lower - Pipe To Rad.		24248
386			378		
Belt - Fan & Alt.	D8410006122215	♣K120872HD	Belt - Fan, Alt. & A.C.	D11085891	♣K081020HD
Belt - Hub & A.C.	D8410006061620	♣K060637HD	Tensioner Assy. - Fan, Alt. & A.C.	2117895	38590
Tensioner Assy. - Fan & Alt.	3682946	38587	Tensioner Pulley - Fan, Alt. & A.C.	2117895	36164
Tensioner Assy. - Hub & A.C.	3682683	38610	Idler Pulley - Grooved	1979642	36341
Tensioner Pulley - Fan & Alt.	3682946	36165	Idler Pulley - Smooth	2078118	36269
Idler Pulley - A.C.	3682229	36223	379		
Hose - Upper - Rad. To Pipe		24240	Belt - Fan, Alt. & A.C.	D11086873	♣K081023HD
Hose - Upper - Pipe To Eng.		21891	Tensioner Assy. - Fan, Alt. & A.C.	2117895	38590
Hose - Lower - Rad. To Pipe		24240	Tensioner Pulley - Fan, Alt. & A.C.	2117895	36164
Hose - Lower - Pipe To Eng.		24240	Idler Pulley - Grooved	1979642	36341
			Idler Pulley - Smooth	2078118	36269
387			Hose - Upper - Eng. To Pipe		24240
Belt - Fan & Alt.	D8410006122215	♣K120872HD	Hose - Upper - Pipe To Rad.		24240
Belt - Hub & A.C.	D8410003061620	♣K060637HD	Hose - Lower - Eng. To Pipe		24240
Tensioner Assy. - Fan & Alt.	3682946	38587	Hose - Lower - Pipe To Rad.		24244
Tensioner Assy. - Hub & A.C.	3104149	38610	385; 387		
Tensioner Pulley - Fan & Alt.	3682946	36165	Idler Pulley - Grooved	1979642	36341
Idler Pulley - A.C.	3682229	36223	Idler Pulley - Smooth	2078118	36269
Hose - Upper - Rad. To Pipe		≈24240	Caterpillar C13 Diesel		
Hose - Upper - Pipe To Eng.		21891	357		
Hose - Lower - Rad. To Pipe		≈24240	Belt - Fan, Alt. & A.C.	D11085891	♣K081020HD
Hose - Lower - Pipe To Eng.		≈24240	Tensioner Assy. - Fan, Alt. & A.C.	2117895	38590
			Tensioner Pulley - Fan, Alt. & A.C.	2117895	36164
Paccar PX-8 Diesel			Idler Pulley - Grooved	1979642	36341
340			Idler Pulley - Smooth	2078118	36269
Idler Pulley	3970945	36283	Hose - Upper - Eng. To Pipe		24240
2006			Hose - Upper - Pipe To Rad.		24240
Caterpillar C7 Diesel			Hose - Lower - Eng. To Pipe		24240
320			Hose - Lower - Pipe To Rad.		24244
Belt - Fan	D8410001082175	♣K080859HD	378		
Tensioner Assy.	2222880	38586	Idler Pulley - Grooved	1979642	36341
Tensioner Pulley	2222880	36091			

Medium & Heavy-Duty Trucks (2001 & Newer)

♣Standard Belt Available.

≈Cut to Fit.

Belts and Coolant Hose for Medium/Heavy-Duty Trucks (2001 & Newer)

Medium & Heavy-Duty Trucks
(2001 & Newer)

Application	Mfr. Part No.	Our No.	Application	Mfr. Part No.	Our No.
Peterbilt - Continued			Peterbilt - Continued		
2006 - Continued			2006 - Continued		
Caterpillar C13 Diesel - Continued			Caterpillar C15 Diesel - Continued		
378 - Continued			378; 379 - Continued		
Idler Pulley - Smooth	2078118	36269	Hose - Lower - Eng. To Pipe		24248
379			Hose - Lower - Pipe To Pipe		24248
Belt - Fan, Alt. & A.C.	D11086873	♣K081023HD	Hose - Lower - Pipe To Rad.		24248
Tensioner Assy. - Fan, Alt. & A.C.	2117895	38590	386		
Tensioner Pulley - Fan, Alt. & A.C.	2117895	36164	Belt - Fan & Alt.	D8410003122500	K120985HD
Idler Pulley - Grooved	1979642	36341	Belt - Fan To A.C.	D11085664	K060568HD
Idler Pulley - Smooth	2078118	36269	Tensioner Assy. - Fan & Alt.	2362301	38609
Hose - Upper - Eng. To Pipe		24240	Tensioner Assy. - Fan To A.C.	2178938	38511
Hose - Upper - Pipe To Rad.		24240	Idler Pulley - Grooved	1979642	36341
Hose - Lower - Eng. To Pipe		24240	Idler Pulley - Smooth	1979641	36091
Hose - Lower - Pipe To Rad.		24244	Hose - Upper - Eng. To Pipe		24240
385			Hose - Upper - Pipe To Rad.		24240
Belt - Fan, Alt. & A.C.	D11085891	♣K081020HD	Hose - Lower - Eng. To Pipe		24248
Tensioner Assy. - Fan, Alt. & A.C.	2117895	38590	Hose - Lower - Pipe To Rad.		24248
Tensioner Pulley - Fan, Alt. & A.C.	2117895	36164	387		
Idler Pulley - Grooved	1979642	36341	Belt - Fan & Alt.	D8410001082420	♣K080952HD
Idler Pulley - Smooth	2078118	36269	Belt - Fan To A.C.	D11085664	K060568HD
Hose - Upper - Eng. To Pipe		24240	Tensioner Assy. - Fan & Alt.	2002279	38569
Hose - Upper - Pipe To Rad.		24240	Tensioner Assy. - Fan To A.C.	2178938	38511
Hose - Lower - Eng. To Pipe		24240	Tensioner Pulley - Fan To A.C.	2178938	36091
Hose - Lower - Pipe To Pipe		24244	Idler Pulley - Grooved	1979642	36341
Hose - Lower - Pipe To Rad.		24244	Idler Pulley - Smooth	1979641	36091
387			Hose - Upper - Eng. To Pipe		24240
Belt - Alt.		♣K060935HD	Hose - Upper - Pipe To Rad.		24240
Belt - Fan & A.C.	D8410001082335	♣K080922HD	Hose - Lower - Eng. To Pipe		24248
Idler Pulley - Grooved	1979642	36341	Hose - Lower - Pipe To Pipe		24240
Idler Pulley - Smooth	2078118	36269	Hose - Lower - Pipe To Rad.		21891
Hose - Upper - Eng. To Pipe		21891	Cummins ISC Diesel		
Hose - Upper - Pipe To Rad.		24240	320		
Hose - Lower - Eng. To Pipe		24240	Idler Pulley	3970945	36283
Hose - Lower - Pipe To Rad.		21891	335		
Caterpillar C15 Diesel			Belt - Fan, Alt. & Hub	3972261	♣K080760HD
357			Belt - Fan To A.C.	D11023329	♣9390HD
Belt - Fan & Alt.; W/8-Ribbed Belt	D8410001082520	♣K080991HD	Tensioner Assy. - Fan, Alt. & Hub	3936213	38516
Belt - Fan & Alt.; W/12-Ribbed Belt	D8410003122640	♣K121039HD	Tensioner Pulley - Fan, Alt. & Hub	3936213	36093
Belt - Fan To A.C.; W/52" Belt O.C.	D8410003061310	♣K060516HD	Idler Pulley	3970945	36283
Belt - Fan To A.C.; W/53" Belt O.C.	D8410003061340	♣K060525HD	Hose - Upper - Eng. To Pipe		20748
Tensioner Assy. - Fan & Alt.; W/8-Ribbed Belt	2002279	38569	Hose - Upper - Pipe To Rad.		♣21194
Tensioner Assy. - Fan & Alt.; W/12-Ribbed Belt	2362301	38609	Hose - Lower - Eng. To Pipe		20748
Tensioner Assy. - Fan To A.C.	2178938	38511	Hose - Lower - Pipe To Rad.		24236
Tensioner Pulley - Fan To A.C.	2178938	36091	Hose - Lower - Cooler To Pipe		24236
Idler Pulley - Grooved	1979642	36341	357		
Idler Pulley - Smooth	1979641	36091	Idler Pulley	3970945	36283
Hose - Upper - Eng. To Pipe		24240	Cummins ISM Diesel		
Hose - Upper - Pipe To Rad.		24240	320		
Hose - Lower - Eng. To Pipe		24248	Belt - Fan & Alt.	D84100003081880	♣K080740HD
Hose - Lower - Pipe To Rad.		24248	Belt - A.C.	4060537	K060535
Hose - Lower - Pipe To Pipe		24248	Tensioner Assy. - Fan & Alt.	3400885	38521
378; 379			Tensioner Assy. - A.C.	3102888	38505
Belt - Fan & Alt.; W/8-Ribbed Belt	D8410001082520	♣K080991HD	Tensioner Pulley - A.C.	3102888	36091
Belt - Fan & Alt.; W/12-Ribbed Belt	D8410003122640	♣K121039HD	Idler Pulley - Fan & Alt.	3400884	36308
Belt - Fan To A.C.; W/52" Belt O.C.	D8410003061310	♣K060516HD	Idler Pulley - A.C.	3104139	36225
Belt - Fan To A.C.; W/53" Belt O.C.	D8410003061340	♣K060525HD	357; 378		
Tensioner Assy. - Fan & Alt.; W/8-Ribbed Belt	2002279	38569	Belt - Fan & Alt.	D11084816	♣K080730HD
Tensioner Assy. - Fan & Alt.; W/12-Ribbed Belt	2362301	38609	Belt - Hub & A.C.	4004824	♣K060539HD
Tensioner Assy. - Fan To A.C.	2178938	38511	Tensioner Assy. - Fan & Alt.	4920105	38622
Tensioner Pulley - Fan To A.C.	2178938	36091	Tensioner Assy. - Hub & A.C.	3102888	38505
Idler Pulley - Grooved	1979642	36341	Tensioner Pulley - Hub & A.C.	3102888	36091
Idler Pulley - Smooth	1979641	36091	Idler Pulley - Fan & Alt.	3400884	36308
Hose - Upper - Eng. To Pipe		24240	Idler Pulley - A.C.	3104139	36225
Hose - Upper - Pipe To Rad.		24240	Hose - Upper - Eng. To Pipe		24240
			Hose - Upper - Pipe To Rad.		24240
			Hose - Lower - Eng. To Pipe		24240

♣Standard Belt Available.

♣Cut to Fit.

Belts and Coolant Hose for Medium/Heavy-Duty Trucks (2001 & Newer)

Application	Mfr. Part No.	Our No.	Application	Mfr. Part No.	Our No.
Peterbilt - Continued			Peterbilt - Continued		
2006 - Continued			2005 - Continued		
Cummins ISM Diesel - Continued			Caterpillar C7 Diesel - Continued		
357; 378 - Continued			335 - Continued		
Hose - Lower - Pipe To Rad.		24240	Hose - Upper - Eng. To Pipe		≈24236
379; 385			Hose - Upper - Pipe To Rad.		
Idler Pulley - Fan & Alt.	3400884	36308	Hose - Lower - Pipe To Rad.		24236
Cummins ISX Diesel			Caterpillar C10 Diesel		
357			320		
Belt - Fan & Alt.	D841000112215	♣K120872HD	Belt - Serpentine	910K8BLT	♣K080903HD
Belt - Hub & A.C.	D8410003061620	♣K060637HD	Tensioner Assy.	1900649	38506
Tensioner Assy. - Fan & Alt.	3682946	38587	Tensioner Pulley		36091
Tensioner Assy. - Hub & A.C.	3682683	38610	Caterpillar C11 Diesel		
Tensioner Pulley - Fan & Alt.	3682946	36165	357; 362; 378		
Idler Pulley - A.C.	3682229	36223	Belt - Fan, Alt. & A.C.		
Hose - Upper - Eng. To Pipe		21891	Tensioner Assy. - Fan, Alt. & A.C.		
Hose - Upper - Pipe To Rad.		24240	Tensioner Pulley - Fan, Alt. & A.C.		
Hose - Lower - Eng. To Pipe		24240	Idler Pulley - Grooved		
Hose - Lower - Pipe To Rad.		21891	Idler Pulley - Smooth		
378; 379			379		
Belt - Fan & Alt.; W/130A. Alt.	D8410001122295	♣K120903HD	Belt - Fan, Alt. & A.C.		
Belt - Fan & Alt.; W/135A. Alt.	D11085234	♣K120891HD	Tensioner Assy. - Fan, Alt. & A.C.		
Belt - Hub & A.C.	D8410003061620	♣K060637HD	Tensioner Pulley - Fan, Alt. & A.C.		
Tensioner Assy. - Fan & Alt.	3682946	38587	Idler Pulley - Grooved		
Tensioner Assy. - Hub & A.C.	3682683	38610	Idler Pulley - Smooth		
Tensioner Pulley - Fan & Alt.	3682946	36165	Hose - Upper - Eng. To Pipe		
Idler Pulley - A.C.	3682229	36223	Hose - Upper - Pipe To Rad.		
Hose - Upper - Eng. To Pipe		24240	Hose - Lower - Eng. To Pipe		
Hose - Upper - Pipe To Rad.		24240	Hose - Lower - Pipe To Rad.		
Hose - Lower - Eng. To Pipe		24240	385		
Hose - Lower - Pipe To Rad.		24248	Idler Pulley - Grooved		
387			Idler Pulley - Smooth		
Belt - Fan & Alt.	D841000112215	♣K120872HD	385		
Belt - Hub & A.C.	D8410003061620	♣K060637HD	Idler Pulley - Grooved		
Tensioner Assy. - Fan & Alt.	3682946	38587	Idler Pulley - Smooth		
Tensioner Assy. - Hub & A.C.	3682683	38610	Caterpillar C13 Diesel		
Tensioner Pulley - Fan & Alt.	3682946	36165	357		
Idler Pulley - A.C.	3682229	36223	Belt - Fan, Alt. & A.C.		
Hose - Upper - Eng. To Pipe		24240	Tensioner Assy. - Fan, Alt. & A.C.		
Hose - Upper - Pipe To Rad.		24240	Tensioner Pulley - Fan, Alt. & A.C.		
Hose - Lower - Eng. To Pipe		24240	Idler Pulley - Grooved		
Hose - Lower - Pipe To Rad.		24240	Idler Pulley - Smooth		
2005			Hose - Upper - Eng. To Pipe		
Caterpillar C7 Diesel			Hose - Upper - Pipe To Rad.		
320			Hose - Lower - Eng. To Pipe		
Belt - Fan	D8410001082175	♣K080859HD	Hose - Lower - Pipe To Rad.		
Tensioner Assy.	2222880	38586	378; 379		
Tensioner Pulley	2222880	36091	Belt - Fan, Alt. & A.C.		
Idler Pulley - Upper	1979641	36091	Tensioner Assy. - Fan, Alt. & A.C.		
Idler Pulley - Lower	2534525	36096	Tensioner Pulley - Fan, Alt. & A.C.		
Hose - Upper - Eng. To Pipe		≈24232	Idler Pulley - Grooved		
Hose - Upper - Pipe To Rad.		≈24240	Idler Pulley - Smooth		
Hose - Lower - Eng. To Pipe		≈24240	Hose - Upper - Eng. To Pipe		
Hose - Lower - Pipe To Rad.		≈24248	Hose - Upper - Pipe To Rad.		
330			Hose - Lower - Eng. To Pipe		
Belt - Fan, A.C., Alt. & W.P.	D8410001082175	♣K080859HD	Hose - Lower - Pipe To Rad.		
Tensioner Assy. - Fan, A.C., Alt. & W.P.	2222880	38586	385		
Idler Pulley - Upper	1979641	36091	Belt - Fan, Alt. & A.C.		
Idler Pulley - Lower	2534525	36096	Tensioner Assy. - Fan, Alt. & A.C.		
Hose - Upper - Eng. To Pipe		24232	Tensioner Pulley - Fan, Alt. & A.C.		
Hose - Upper - Pipe To Rad.		20397	Idler Pulley - Grooved		
Hose - Lower - Pipe To Rad.		24236	Idler Pulley - Smooth		
335			Hose - Upper - Eng. To Pipe		
Belt - Fan, A.C., Alt. & W.P.	D8410001082175	♣K080859HD	Hose - Upper - Pipe To Rad.		
Tensioner Assy. - Fan, A.C., Alt. & W.P.	2222880	38586	Hose - Lower - Eng. To Pipe		
Idler Pulley - Upper	1979641	36091	Hose - Lower - Pipe To Pipe		
Idler Pulley - Lower	2534525	36096	Hose - Lower - Pipe To Rad.		
2006 - Continued			387		
Cummins ISM Diesel - Continued			Belt - Fan, Alt. & A.C.		
357; 378 - Continued			Tensioner Assy. - Fan, Alt. & A.C.		
Hose - Lower - Pipe To Rad.		24240	Tensioner Pulley - Fan, Alt. & A.C.		
379; 385			Idler Pulley - Grooved		
Idler Pulley - Fan & Alt.	3400884	36308	Idler Pulley - Smooth		
Cummins ISX Diesel			Hose - Upper - Eng. To Pipe		
357			Hose - Upper - Pipe To Rad.		
Belt - Fan & Alt.	D841000112215	♣K120872HD	Hose - Lower - Eng. To Pipe		
Belt - Hub & A.C.	D8410003061620	♣K060637HD	Hose - Lower - Pipe To Rad.		
Tensioner Assy. - Fan & Alt.	3682946	38587	378; 379		
Tensioner Assy. - Hub & A.C.	3682683	38610	Belt - Fan, Alt. & A.C.		
Tensioner Pulley - Fan & Alt.	3682946	36165	Tensioner Assy. - Fan, Alt. & A.C.		
Idler Pulley - A.C.	3682229	36223	Tensioner Pulley - Fan, Alt. & A.C.		
Hose - Upper - Eng. To Pipe		21891	Idler Pulley - Grooved		
Hose - Upper - Pipe To Rad.		24240	Idler Pulley - Smooth		
Hose - Lower - Eng. To Pipe		24240	Hose - Upper - Eng. To Pipe		
Hose - Lower - Pipe To Rad.		21891	Hose - Upper - Pipe To Rad.		
378; 379			Hose - Lower - Eng. To Pipe		
Belt - Fan & Alt.; W/130A. Alt.	D8410001122295	♣K120903HD	Hose - Lower - Pipe To Rad.		
Belt - Fan & Alt.; W/135A. Alt.	D11085234	♣K120891HD	378; 379		
Belt - Hub & A.C.	D8410003061620	♣K060637HD	Belt - Fan, Alt. & A.C.		
Tensioner Assy. - Fan & Alt.	3682946	38587	Tensioner Assy. - Fan, Alt. & A.C.		
Tensioner Assy. - Hub & A.C.	3682683	38610	Tensioner Pulley - Fan, Alt. & A.C.		
Tensioner Pulley - Fan & Alt.	3682946	36165	Idler Pulley - Grooved		
Idler Pulley - A.C.	3682229	36223	Idler Pulley - Smooth		
Hose - Upper - Eng. To Pipe		24240	Hose - Upper - Eng. To Pipe		
Hose - Upper - Pipe To Rad.		24240	Hose - Upper - Pipe To Rad.		
Hose - Lower - Eng. To Pipe		24240	Hose - Lower - Eng. To Pipe		
Hose - Lower - Pipe To Rad.		24248	Hose - Lower - Pipe To Rad.		
387			385		
Belt - Fan & Alt.	D841000112215	♣K120872HD	Belt - Fan, Alt. & A.C.		
Belt - Hub & A.C.	D8410003061620	♣K060637HD	Tensioner Assy. - Fan, Alt. & A.C.		
Tensioner Assy. - Fan & Alt.	3682946	38587	Tensioner Pulley - Fan, Alt. & A.C.		
Tensioner Assy. - Hub & A.C.	3682683	38610	Idler Pulley - Grooved		
Tensioner Pulley - Fan & Alt.	3682946	36165	Idler Pulley - Smooth		
Idler Pulley - A.C.	3682229	36223	Hose - Upper - Eng. To Pipe		
Hose - Upper - Eng. To Pipe		24240	Hose - Upper - Pipe To Rad.		
Hose - Upper - Pipe To Rad.		24240	Hose - Lower - Eng. To Pipe		
Hose - Lower - Eng. To Pipe		24240	Hose - Lower - Pipe To Rad.		
Hose - Lower - Pipe To Rad.		24248	378; 379		

♣Standard Belt Available.

≈Cut to Fit.

Medium & Heavy-Duty Trucks
(2001 & Newer)

Belts and Coolant Hose for Medium/Heavy-Duty Trucks (2001 & Newer)

Medium & Heavy-Duty Trucks
(2001 & Newer)

Application	Mfr. Part No.	Our No.
Peterbilt - Continued		
2005 - Continued		
Caterpillar C13 Diesel - Continued		
387 - Continued		
Tensioner Pulley - Fan, Alt. & A.C.	2117895	36164
Idler Pulley - Grooved	1979642	36341
Idler Pulley - Smooth	2078118	36269
Hose - Upper - Eng. To Pipe		24240
Hose - Upper - Pipe To Rad.		21891
Hose - Lower - Eng. To Pipe		24240
Hose - Lower - Pipe To Pipe		24240
Hose - Lower - Pipe To Rad.		21891
Caterpillar C15 Diesel		
357; 378		
Belt - Fan & Alt.	D11085222	▲K121039HD
Belt - Fan To A.C.	D11085658	▲K060516HD
Tensioner Assy. - Fan & Alt.	2002279	38569
Tensioner Assy. - Fan To A.C.	2178938	38511
Tensioner Pulley - Fan To A.C.	2178938	36091
Idler Pulley - Smooth	2249775	36165
Hose - Upper - Eng. To Pipe		24240
Hose - Upper - Pipe To Rad.		24240
Hose - Lower - Eng. To Pipe		24248
Hose - Lower - Pipe To Pipe		24248
Hose - Lower - Pipe To Rad.		24248
379		
Belt - Fan & Alt.; W/8-Ribbed Belt	D8410001082520	▲K080991HD
Belt - Fan & Alt.; W/12-Ribbed Belt	D8410003122640	▲K121039HD
Belt - Fan To A.C.; W/52" Belt O.C.	D8410003061310	▲K060516HD
Belt - Fan To A.C.; W/53" Belt O.C.	D8410003061340	▲K060525HD
Tensioner Assy. - Fan & Alt.; W/8-Ribbed Belt	2002279	38569
Tensioner Assy. - Fan & Alt.; W/12-Ribbed Belt	2362301	38609
Tensioner Assy. - Fan To A.C.	2178938	38511
Tensioner Pulley - Fan To A.C.	2178938	36091
Idler Pulley - Grooved; W/8-Ribbed Belt	1979642	36341
Idler Pulley - Smooth; W/8-Ribbed Belt	1979641	36091
Idler Pulley - Smooth; W/12-Ribbed Belt	2249775	36165
Hose - Upper - Eng. To Pipe		24240
Hose - Upper - Pipe To Rad.		24240
Hose - Lower - Eng. To Pipe		24248
Hose - Lower - Pipe To Pipe		24248
Hose - Lower - Pipe To Rad.		24248
387		
Belt - Fan & Alt.	D8410001082420	▲K080952HD
Belt - Fan To A.C.	D8410003061440	K060568HD
Tensioner Assy. - Fan & Alt.	2002279	38569
Tensioner Assy. - Fan To A.C.	2178938	38511
Tensioner Pulley - Fan To A.C.	2178938	36091
Idler Pulley - Grooved	1979642	36341
Idler Pulley - Smooth	1979641	36091
Hose - Upper - Eng. To Pipe		24240
Hose - Upper - Pipe To Rad.		24240
Hose - Lower - Eng. To Pipe		24248
Hose - Lower - Pipe To Pipe		24248
Hose - Lower - Pipe To Rad.		24248
Cummins ISC Diesel		
320		
Belt - Fan	3289503	▲K080726HD
Belt - A.C.	17395	▲9395HD
Tensioner Assy. - Fan	3937553	38504
330		
Belt - Fan, Alt. & Hub	3944838	▲K080755HD
Belt - Fan To A.C.	D11023329	▲9390HD
Tensioner Assy. - Fan, Alt. & Hub	3945527	38516
Tensioner Pulley - Fan, Alt. & Hub	3945527	36093
Hose - Upper - Eng. To Pipe		21135

▲Standard Belt Available.

Application	Mfr. Part No.	Our No.
Peterbilt - Continued		
2005 - Continued		
Cummins ISC Diesel - Continued		
330 - Continued		
Hose - Upper - Pipe To Rad.		≡21115
Hose - Lower - Pipe To Rad.		24236
335		
Belt - Fan, Alt. & Hub	3289659	▲K080760HD
Belt - Fan To A.C.	D11023329	▲9390HD
Tensioner Assy. - Fan, Alt. & Hub	3936213	38516
Tensioner Pulley - Fan, Alt. & Hub	3936213	36093
Idler Pulley	3970945	36283
Hose - Upper - Eng. To Pipe		20748
Hose - Upper - Pipe To Rad.		≡21194
Hose - Lower - Eng. To Pipe		20748
Hose - Lower - Pipe To Rad.		24236
Hose - Lower - Cooler To Pipe		24236
Cummins ISL Diesel		
357		
Tensioner Assy. - Alt.	3976831	38516
Cummins ISM Diesel		
357		
Belt - Fan & Alt.	D8410001081650	▲K080649HD
Belt - Hub & A.C.	4004824	▲K060539HD
Tensioner Assy. - Fan & Alt.	4920105	38622
Tensioner Assy. - Hub & A.C.	4004933	38505
Tensioner Pulley - Hub & A.C.	4004933	36091
Idler Pulley - Fan & Alt.	3400884	36308
Hose - Upper - Eng. To Pipe		24236
Hose - Upper - Pipe To Rad.		24240
Hose - Lower - Eng. To Pipe		24240
Hose - Lower - Pipe To Cooler		21042
Hose - Lower - Cooler To Rad.		21042
Hose - Lower - Rad. To Cooler		21042
378		
Belt - Fan & Alt.	D11084816	▲K080730HD
Belt - Hub & A.C.	4004824	▲K060539HD
Tensioner Assy. - Fan & Alt.	4920105	38622
Tensioner Assy. - Hub & A.C.	3102888	38505
Tensioner Pulley - Hub & A.C.	3102888	36091
Idler Pulley - Fan & Alt.	3400884	36308
Idler Pulley - A.C.	3104139	36225
Hose - Upper - Eng. To Pipe		24240
Hose - Upper - Pipe To Rad.		24240
Hose - Lower - Eng. To Pipe		24240
Hose - Lower - Pipe To Rad.		24240
385		
Belt - Fan & Alt.		▲K080774HD
Belt - Hub & A.C.	4004824	▲K060539HD
Tensioner Assy. - Fan & Alt.	4920105	38622
Tensioner Assy. - Hub & A.C.		38505
Tensioner Pulley - Hub & A.C.	4004933	36091
Idler Pulley - Fan & Alt.	3400884	36308
Hose - Upper - Eng. To Pipe		24236
Hose - Upper - Pipe To Rad.		24240
Hose - Lower - Eng. To Pipe		24240
Hose - Lower - Pipe To Rad.		24240
Hose - Lower - Rad. To Cooler		21042
Hose - Lower - Pipe To Cooler		21042
Cummins ISX Diesel		
378		
Belt - Fan & Alt.; W/130A. Alt.	D8410001122295	▲K120903HD
Belt - Fan & Alt.; W/135A. Alt.	D11085234	▲K120891HD
Belt - Hub & A.C.	D8410003061620	▲K060637HD
Tensioner Assy. - Fan & Alt.	3682946	38587
Tensioner Assy. - Hub & A.C.	3682683	38610
Tensioner Pulley - Fan & Alt.	3682946	36165

≡Cut to Fit.

Belts and Coolant Hose for Medium/Heavy-Duty Trucks (2001 & Newer)

Application	Mfr. Part No.	Our No.	Application	Mfr. Part No.	Our No.
Peterbilt - Continued			Peterbilt - Continued		
2005 - Continued			2004 - Continued		
Cummins ISX Diesel - Continued			Caterpillar C10 Diesel - Continued		
378 - Continued			357; 378; 379 - Continued		
Idler Pulley - A.C.	3682229	36223	Belt - Fan To A.C.	17461	♣9463HD
Hose - Upper - Eng. To Pipe		24240	Tensioner Assy. - Fan & Alt.	1333545	38506
Hose - Upper - Pipe To Rad.		24240	Tensioner Pulley - Fan & Alt.	1333545	36091
Hose - Lower - Eng. To Pipe		24240	Hose - Upper - Eng. To Pipe		24240
Hose - Lower - Pipe To Rad.		24248	Hose - Upper - Pipe To Rad.		24240
379			Hose - Lower - Eng. To Pipe		24240
Belt - Fan & Alt.; W/130A. Alt.	D8410001122295	♣K120903HD	Hose - Lower - Pipe To Rad.		24248
Belt - Fan & Alt.; W/135A. Alt.	D11085234	♣K120891HD	385		
Belt - Hub & A.C.	D8410003061620	♣K060637HD	Belt - Fan & Alt.	D1102118337	♣K080726HD
Tensioner Assy. - Fan & Alt.	3682946	38587	Belt - Fan To A.C.	17461	♣9463HD
Tensioner Assy. - Hub & A.C.	3682683	38610	Tensioner Assy. - Fan & Alt.	1333545	38506
Tensioner Pulley - Fan & Alt.	3682946	36165	Tensioner Pulley - Fan & Alt.	1333545	36091
Idler Pulley - A.C.	3682229	36223	Hose - Upper - Eng. To Pipe		24240
Hose - Upper - Eng. To Pipe		24240	Hose - Upper - Pipe To Rad.		24240
Hose - Upper - Pipe To Rad.		24240	Hose - Lower - Eng. To Pipe		24240
Hose - Lower - Eng. To Pipe		24240	Hose - Lower - Pipe To Rad.		24248
Hose - Lower - Pipe To Rad.		24240	Caterpillar C11 Diesel		
387			378		
Belt - Fan & Alt.	D8410001122215	♣K120872HD	Idler Pulley - Grooved	1979642	36341
Belt - Hub & A.C.	D8410003061620	♣K060637HD	Idler Pulley - Smooth	2078118	36269
Tensioner Assy. - Fan & Alt.	3682946	38587	Caterpillar C12 Diesel		
Tensioner Assy. - Hub & A.C.	3682683	38610	357; 378; 379		
Tensioner Pulley - Fan & Alt.	3682946	36165	Belt - Fan & Alt.	4080740	♣K080740HD
Idler Pulley - A.C.	3682229	36223	Belt - Fan To A.C.	17461	♣9463HD
Hose - Upper - Eng. To Pipe		24240	Tensioner Assy. - Fan & Alt.	1333545	38506
Hose - Upper - Pipe To Rad.		24240	Tensioner Pulley - Fan & Alt.	1333545	36091
Hose - Lower - Eng. To Pipe		24240	Hose - Upper - Eng. To Pipe		24240
Hose - Lower - Pipe To Rad.		24240	Hose - Upper - Pipe To Rad.		24240
2004			Hose - Lower - Eng. To Pipe		24240
Caterpillar C7 Diesel			Hose - Lower - Pipe To Rad.		24248
320			385		
Belt - Fan	D8410001082175	♣K080859HD	Belt - Fan & Alt.	D1102118337	♣K080726HD
Tensioner Assy.	2222880	38586	Belt - Fan To A.C.	17461	♣9463HD
Tensioner Pulley	2222880	36091	Tensioner Assy. - Fan & Alt.	1333545	38506
Idler Pulley - Upper	1979641	36091	Tensioner Pulley - Fan & Alt.	1333545	36091
Idler Pulley - Lower	2534525	36096	Hose - Upper - Eng. To Pipe		24240
Hose - Upper - Eng. To Pipe		≈<24232	Hose - Upper - Pipe To Rad.		24240
Hose - Upper - Pipe To Rad.		≈<24240	Hose - Lower - Eng. To Pipe		24240
Hose - Lower - Eng. To Pipe		≈<24240	Hose - Lower - Pipe To Rad.		24248
Hose - Lower - Pipe To Rad.		≈<24248	Caterpillar C13 Diesel		
330			379		
Belt - Fan, A.C., Alt. & W.P.	D8410001082175	♣K080859HD	Belt - Fan, Alt. & A.C.	D11086873	♣K081023HD
Tensioner Assy. - Fan, A.C., Alt. & W.P.	2222880	38586	Tensioner Assy. - Fan, Alt. & A.C.	2117895	38590
Idler Pulley - Upper	1979641	36091	Tensioner Pulley - Fan, Alt. & A.C.	2117895	36164
Idler Pulley - Lower	2534525	36096	Idler Pulley - Grooved	1979642	36341
Hose - Upper - Eng. To Pipe		≈<24236	Idler Pulley - Smooth	2078118	36269
Hose - Upper - Pipe To Rad.		20397	Hose - Upper - Eng. To Pipe		24240
Hose - Lower - Pipe To Rad.		24236	Hose - Upper - Pipe To Rad.		24240
Caterpillar C9 Diesel			Hose - Lower - Eng. To Pipe		24240
357			Hose - Lower - Pipe To Rad.		24244
Belt - Fan, Alt. & A.C.	D8410001082040	♣K080806HD	387		
Hose - Upper - Eng. To Pipe		24232	Belt - Fan, Alt. & A.C.	D11084918	♣K080968HD
Hose - Upper - Pipe To Rad.		24240	Tensioner Assy. - Fan, Alt. & A.C.	2117895	38590
Hose - Lower - Eng. To Pipe		24240	Tensioner Pulley - Fan, Alt. & A.C.	2117895	36164
Hose - Lower - Pipe To Rad.		21891	Idler Pulley - Grooved	1979642	36341
Caterpillar C10 Diesel			Idler Pulley - Smooth	2078118	36269
320			Hose - Upper - Eng. To Pipe		24240
Belt - Serpentine	910K8BLT	♣K080903HD	Hose - Upper - Pipe To Rad.		21891
Tensioner Assy.	1900649	38506	Hose - Lower - Eng. To Pipe		24240
Tensioner Pulley		36091	Hose - Lower - Pipe To Pipe		24240
357; 378; 379			Hose - Lower - Pipe To Rad.		21891
Belt - Fan & Alt.	4080740	♣K080740HD			

Medium & Heavy-Duty Trucks
(2001 & Newer)

♣Standard Belt Available.

≈<Cut to Fit.

Belts and Coolant Hose for Medium/Heavy-Duty Trucks (2001 & Newer)

Medium & Heavy-Duty Trucks
(2001 & Newer)

Application	Mfr. Part No.	Our No.
Peterbilt - Continued		
2004 - Continued		
Caterpillar C15 Diesel		
357		
Belt - Fan & Alt.	D11085222	♣K121039HD
Belt - Fan To A.C.	D11085658	♣K060516HD
Tensioner Assy. - Fan & Alt.	2002279	38569
Tensioner Assy. - Fan To A.C.	2178938	38511
Tensioner Pulley - Fan To A.C.	2178938	36091
Idler Pulley - Smooth	1979641	36091
Hose - Upper - Eng. To Pipe		24240
Hose - Upper - Pipe To Rad.		24240
Hose - Lower - Eng. To Pipe		24248
Hose - Lower - Pipe To Pipe		24248
Hose - Lower - Pipe To Rad.		24248
378		
Belt - Fan & Alt.; W/Clean Air Pkg.	D8410001082520	♣K080991HD
Belt - Fan; W/O Clean Air Pkg.	D11024799	TR22553
Belt - Fan To Alt. & A.C.; W/O Clean Air Pkg.		②♣9590HD
Belt - Fan To A.C.; W/Clean Air Pkg.	D8410003061340	♣K060525HD
Tensioner Assy. - Fan & Alt.; W/Clean Air Pkg.	2002279	38569
Tensioner Assy. - Fan To A.C.; W/Clean Air Pkg.	2178938	38511
Tensioner Pulley - Fan To A.C.; W/Clean Air Pkg.	2178938	36091
Idler Pulley - Grooved	1979642	36341
Idler Pulley - Smooth	1979641	36091
Hose - Upper - Eng. To Pipe		24240
Hose - Upper - Pipe To Rad.		24240
Hose - Lower - Eng. To Pipe		24248
Hose - Lower - Pipe To Rad.		24248
379		
Belt - Fan & Alt.; W/Clean Air Pkg.	D8410001082520	♣K080991HD
Belt - Fan; W/O Clean Air Pkg.		②TR22545
Belt - Fan To Alt. & A.C.; W/O Clean Air Pkg.		②♣9590HD
Belt - Fan To A.C.; W/Clean Air Pkg.	D8410003061340	♣K060525HD
Tensioner Assy. - Fan & Alt.; W/Clean Air Pkg.	2002279	38569
Tensioner Assy. - Fan To A.C.; W/Clean Air Pkg.	2178938	38511
Tensioner Pulley - Fan To A.C.; W/Clean Air Pkg.	2178938	36091
Idler Pulley - Grooved	1979642	36341
Idler Pulley - Smooth	1979641	36091
Hose - Upper - Eng. To Pipe		24240
Hose - Upper - Pipe To Rad.		24240
Hose - Lower - Eng. To Pipe		24248
Hose - Lower - Pipe To Rad.		24248
387		
Belt - Fan & Alt.; W/91" Belt O.C.	D8410001082290	♣K080903HD
Belt - Fan & Alt.; W/96" Belt O.C.	D8410001082420	♣K080952HD
Belt - Fan To A.C.	D11026302	♣K060560HD
Tensioner Assy. - Fan & Alt.	2002279	38569
Tensioner Assy. - Fan To A.C.	2178938	38511
Tensioner Pulley - Fan To A.C.	2178938	36091
Idler Pulley - Grooved	1979642	36341
Idler Pulley - Smooth	1979641	36091
Hose - Upper - Eng. To Pipe		24240
Hose - Upper - Pipe To Rad.		24240
Hose - Lower - Eng. To Pipe		24248
Hose - Lower - Pipe To Pipe		24240
Hose - Lower - Pipe To Rad.		21891
Cummins ISC Diesel		
330		
Belt - Fan, Alt. & Hub	3944838	♣K080755HD
Belt - Fan To A.C.		♣9390HD
Tensioner Assy. - Fan, Alt. & Hub	3945527	38516
Tensioner Pulley - Fan, Alt. & Hub	3945527	36093

♣Standard Belt Available.
≠Cut to Fit.

Application	Mfr. Part No.	Our No.
Peterbilt - Continued		
2004 - Continued		
Cummins ISC Diesel - Continued		
330 - Continued		
Hose - Upper - Eng. To Pipe		21135
Hose - Upper - Pipe To Rad.		≠21115
Hose - Lower - Pipe To Rad.		24236
Cummins ISM Diesel		
357		
Belt - Fan & Alt.	D8410001081650	♣K080649HD
Belt - Hub & A.C.	4004824	♣K060539HD
Tensioner Assy. - Fan & Alt.	3400885	38521
Tensioner Assy. - Hub & A.C.	4004933	38505
Tensioner Pulley - Hub & A.C.	4004933	36091
Idler Pulley - Fan & Alt.	3400884	36308
Hose - Upper - Eng. To Pipe		24236
Hose - Upper - Pipe To Rad.		24240
Hose - Lower - Eng. To Pipe		24240
Hose - Lower - Pipe To Rad.		21042
378		
Belt - Fan & Alt.	D11084816	♣K080730HD
Belt - Hub & A.C.	4004824	♣K060539HD
Tensioner Assy. - Fan & Alt.	4920105	38622
Tensioner Assy. - Hub & A.C.	3102888	38505
Tensioner Pulley - Hub & A.C.	3102888	36091
Idler Pulley - Fan & Alt.	3400884	36308
Idler Pulley - A.C.	3104139	36225
Hose - Upper - Eng. To Pipe		24240
Hose - Upper - Pipe To Rad.		24240
Hose - Lower - Eng. To Pipe		24240
Hose - Lower - Pipe To Rad.		24240
385		
Belt - Fan & Alt.		♣K080774HD
Belt - Hub & A.C.	4004824	♣K060539HD
Tensioner Assy. - Fan & Alt.	3400885	38521
Tensioner Assy. - Hub & A.C.		38505
Tensioner Pulley - Hub & A.C.	4004933	36091
Idler Pulley - Fan & Alt.	3400884	36308
Hose - Upper - Eng. To Pipe		24236
Hose - Upper - Pipe To Rad.		24240
Hose - Lower - Eng. To Pipe		24240
Hose - Lower - Pipe To Rad.		24240
Cummins ISX Diesel		
378		
Belt - Fan & Alt.; W/130A. Alt.	D8410001122295	♣K120903HD
Belt - Fan & Alt.; W/135A. Alt.	D11085234	♣K120891HD
Belt - Hub & A.C.	D8410003061620	♣K060637HD
Tensioner Assy. - Fan & Alt.	3682946	38587
Tensioner Assy. - Hub & A.C.	3682683	38610
Tensioner Pulley - Fan & Alt.	3682946	36165
Idler Pulley - A.C.	3682229	36223
Hose - Upper - Eng. To Pipe		24240
Hose - Upper - Pipe To Rad.		24240
Hose - Lower - Eng. To Pipe		24240
Hose - Lower - Pipe To Rad.		24248
379		
Belt - Fan & Alt.	D8410001122295	♣K120903HD
Belt - Hub & A.C.	D8410003061620	♣K060637HD
Tensioner Assy. - Fan & Alt.	3682946	38587
Tensioner Assy. - Hub & A.C.	3682683	38610
Tensioner Pulley - Fan & Alt.	3682946	36165
Idler Pulley - A.C.	3682229	36223
Hose - Upper - Eng. To Pipe		24240
Hose - Upper - Pipe To Rad.		24240
Hose - Lower - Eng. To Pipe		24240
Hose - Lower - Pipe To Rad.		24240
387		
Belt - Fan & Alt.	D8410001122215	♣K120872HD

②Two Required.

Belts and Coolant Hose for Medium/Heavy-Duty Trucks (2001 & Newer)

 Medium & Heavy-Duty Trucks
(2001 & Newer)

Application	Mfr. Part No.	Our No.	Application	Mfr. Part No.	Our No.
Peterbilt - Continued			Peterbilt - Continued		
2004 - Continued			2003 - Continued		
Cummins ISX Diesel - Continued			Caterpillar C15 Diesel - Continued		
387 - Continued			379 - Continued		
Belt - Hub & A.C.	D8410003061620	▲K060637HD	Hose - Lower - Eng. To Pipe		24248
Tensioner Assy. - Fan & Alt.	3682946	38587	Hose - Lower - Pipe To Rad.		24248
Tensioner Assy. - Hub & A.C.	3682683	38610	387		
Tensioner Pulley - Fan & Alt.	3682946	36165	Belt - Fan & Alt.		▲K080922HD
Idler Pulley - A.C.	3682229	36223	Belt - Fan To A.C.	D11026302	▲K060560HD
Hose - Upper - Eng. To Pipe		24240	Tensioner Assy. - Fan & Alt.	1352142	38506
Hose - Upper - Pipe To Rad.		24240	Tensioner Assy. - Fan To A.C.	1382514	38508
Hose - Lower - Eng. To Pipe		24240	Tensioner Pulley - Fan & Alt.	1352142	36091
Hose - Lower - Pipe To Rad.		24240	Tensioner Pulley - Fan To A.C.	1382514	36091
2003			Hose - Upper - Eng. To Pipe		≈21115
Caterpillar 3126 Diesel				or	24240
330			Hose - Lower - Eng. To Pipe		24248
Belt - Fan, Alt. & A.C.	4080803	▲K080806HD	Hose - Lower - Pipe To Pipe		24240
Belt - Fan, A.C., Alt. & W.P.	D8410001082175	▲K080859HD	Hose - Lower - Pipe To Rad.		21891
Belt - W.P.	0366775	▲9341HD	Caterpillar C16 Diesel		
Tensioner Assy. - Fan, Alt. & A.C.	1352151	38511	379		
Tensioner Pulley - Fan, Alt. & A.C.	1352151	36091	Belt - Fan		②TR22545
Hose - Upper - Eng. To Pipe		24232	Belt - Fan To Alt. & A.C.		②▲9590HD
Hose - Upper - Pipe To Rad.		24240	Hose - Upper - Eng. To Pipe		24240
Hose - Lower - Eng. To Pipe		24232	Hose - Upper - Pipe To Rad.		24240
Hose - Lower - Pipe To Rad.		24240	Hose - Lower - Eng. To Pipe		24248
Caterpillar C10 Diesel			Hose - Lower - Pipe To Rad.		24248
357; 378; 379; 385			387		
Belt - Fan & Alt.	4080740	▲K080740HD	Belt - Fan & Alt.		▲K080922HD
Belt - Fan To A.C.	17461	▲9463HD	Belt - Fan To A.C.	D11026302	▲K060560HD
Tensioner Assy. - Fan & Alt.	1333545	38506	Tensioner Assy. - Fan & Alt.	1352142	38506
Tensioner Pulley - Fan & Alt.	1333545	36091	Tensioner Assy. - Fan To A.C.	1382514	38508
Hose - Upper - Eng. To Pipe		24240	Tensioner Pulley - Fan & Alt.	1352142	36091
Hose - Upper - Pipe To Rad.		24240	Tensioner Pulley - Fan To A.C.	1382514	36091
Hose - Lower - Eng. To Pipe		24240	Hose - Upper - Eng. To Pipe		≈21115
Hose - Lower - Pipe To Rad.		24248		or	24240
Caterpillar C12 Diesel			Hose - Lower - Eng. To Pipe		24248
357; 378; 379; 385			Hose - Lower - Pipe To Pipe		24240
Belt - Fan & Alt.	4080740	▲K080740HD	Hose - Lower - Pipe To Rad.		21891
Belt - Fan To A.C.	17461	▲9463HD	Cummins ISC Diesel		
Tensioner Assy. - Fan & Alt.	1333545	38506	330		
Tensioner Pulley - Fan & Alt.	1333545	36091	Belt - Fan, Alt. & Hub	3944838	▲K080755HD
Hose - Upper - Eng. To Pipe		24240	Belt - Fan & A.C.		▲9390HD
Hose - Upper - Pipe To Rad.		24240	Tensioner Assy. - Fan, Alt. & Hub	3945527	38516
Hose - Lower - Eng. To Pipe		24240	Tensioner Pulley - Fan, Alt. & Hub	3945527	36093
Hose - Lower - Pipe To Rad.		24248	Hose - Upper - Eng. To Pipe		21135
Caterpillar C15 Diesel			Hose - Upper - Pipe To Rad.		24240
378			Hose - Lower - Eng. To Pipe		21891
Belt - Fan & Alt.; W/Clean Air Pkg.	D8410001082520	▲K080991HD	Hose - Lower - Pipe To Rad.		24240
Belt - Fan; W/O Clean Air Pkg.	D11024799	TR22553	Cummins ISM Diesel		
Belt - Fan To Alt. & A.C.; W/O Clean Air Pkg.		②▲9590HD	357		
Belt - Fan To A.C.; W/Clean Air Pkg.	D8410003061340	▲K060525HD	Belt - Fan & Alt.	D8410001081650	▲K080649HD
Tensioner Assy. - Fan & Alt.; W/Clean Air Pkg.	2002279	38569	Belt - Hub & A.C.	4004824	▲K060539HD
Tensioner Assy. - Fan To A.C.; W/Clean Air Pkg.	2178938	38511	Tensioner Assy. - Fan & Alt.	3400885	38521
Tensioner Pulley - Fan To A.C.; W/Clean Air Pkg.	2178938	36091	Tensioner Assy. - Hub & A.C.	4004933	38505
Hose - Upper - Eng. To Pipe		24240	Tensioner Pulley - Hub & A.C.	4004933	36091
Hose - Upper - Pipe To Rad.		24240	Idler Pulley - Fan & Alt.	3400884	36308
Hose - Lower - Eng. To Pipe		24248	Hose - Upper - Eng. To Pipe		24236
Hose - Lower - Pipe To Rad.		24248	Hose - Upper - Pipe To Rad.		24240
379			Hose - Lower - Eng. To Pipe		24240
Belt - Fan		②TR22545	Hose - Lower - Pipe To Rad.		24248
Belt - Fan To Alt. & A.C.		②▲9590HD	385		
Hose - Upper - Eng. To Pipe		24240	Belt - Fan & Alt.		▲K080774HD
Hose - Upper - Pipe To Rad.		24240	Belt - Hub & A.C.	4004824	▲K060539HD
			Tensioner Assy. - Fan & Alt.	3400885	38521
			Tensioner Assy. - Hub & A.C.	4004933	38505
			Tensioner Pulley - Hub & A.C.	4004933	36091
			Idler Pulley - Fan & Alt.	3400884	36308

 ▲Standard Belt Available.
 ≈Cut to Fit.

②Two Required.

Belts and Coolant Hose for Medium/Heavy-Duty Trucks (2001 & Newer)

Medium & Heavy-Duty Trucks
(2001 & Newer)

Application	Mfr. Part No.	Our No.	Application	Mfr. Part No.	Our No.
Peterbilt - Continued			Peterbilt - Continued		
2003 - Continued			2002 - Continued		
Cummins ISM Diesel - Continued			Caterpillar C10 Diesel - Continued		
385 - Continued			378; 379 - Continued		
Hose - Upper - Eng. To Pipe		24236	Belt - Fan To A.C.		♣9463HD
Hose - Upper - Pipe To Rad.		24240	Tensioner Assy. - Fan & Alt.	1333545	38506
Hose - Lower - Eng. To Pipe		24240	Tensioner Pulley - Fan & Alt.	1333545	36091
Hose - Lower - Pipe To Rad.		24240	Hose - Upper - Eng. To Pipe		24240
Cummins ISX Diesel			Hose - Upper - Pipe To Rad.		24240
379			Hose - Lower - Eng. To Pipe		24240
Belt - Fan & Alt.	D8410003122315	♣K120911HD	Hose - Lower - Pipe To Rad.		24248
Belt - Hub & A.C.	D8410003061620	♣K060637HD	385		
Tensioner Assy. - Fan & Alt.	3682946	38587	Belt - Fan & Alt.	4080710	♣K080710HD
Tensioner Assy. - Hub & A.C.	3682683	38610	Belt - A.C.		♣9463HD
Tensioner Pulley - Fan & Alt.	3682946	36165	Tensioner Assy. - Fan & Alt.	1333545	38506
Idler Pulley - A.C.	3682229	36223	Tensioner Pulley - Fan & Alt.	1333545	36091
Hose - Upper - Eng. To Pipe		24240	Hose - Upper - Eng. To Pipe		24240
Hose - Upper - Pipe To Rad.		24240	Hose - Upper - Pipe To Rad.		24240
Hose - Lower - Eng. To Pipe		24240	Hose - Lower - Eng. To Pipe		24240
Hose - Lower - Pipe To Rad.		24240	Hose - Lower - Pipe To Rad.		24248
Cummins N14 Diesel			387		
378; 379; 385			Belt - Fan & Alt.	4080805	♣K080806HD
Belt - Alt.		②♣9451HD	Belt - Fan To A.C.	4060560	♣K060560HD
Belt - Fan		②TR28473	Tensioner Assy. - Fan & Alt.	1481974	38506
Belt - A.C.		♣9415HD	Tensioner Pulley - Fan & Alt.	1481974	36091
Belt - Hub & W.P.		♣K060425HD	Idler Pulley - Fan & Alt.; W/Flat Idler Pulley .	1337023	36091
Hose - Upper - Eng. To Pipe		24240	Idler Pulley - Fan & Alt.; W/Multi-Grooved		
Hose - Upper - Pipe To Rad.		24240	Idler Pulley	1731498	36231
Hose - Lower - Eng. To Pipe		24240	Caterpillar C12 Diesel		
Hose - Lower - Pipe To Rad.		24248	357		
2002			Belt - Fan & Alt.	4080710	♣K080710HD
Caterpillar 3126 Diesel			Belt - A.C.		♣9463HD
330			Tensioner Assy. - Fan & Alt.	1333545	38506
Belt - Fan, Alt. & A.C.	4080803	♣K080806HD	Tensioner Pulley - Fan & Alt.	1333545	36091
Belt - W.P.	0366775	♣9341HD	Hose - Upper - Eng. To Pipe		24240
Tensioner Assy. - Fan, Alt. & A.C.	1352151	38511	Hose - Upper - Pipe To Rad.		24240
Tensioner Pulley - Fan, Alt. & A.C.	1352151	36091	Hose - Lower - Eng. To Pipe		24240
Hose - Upper - Eng. To Pipe		24232	Hose - Lower - Pipe To Rad.		24248
Hose - Upper - Pipe To Rad.		24240	378; 379		
Hose - Lower - Eng. To Pipe		24232	Belt - Fan & Alt.		♣K080740HD
Hose - Lower - Pipe To Rad.		24240	Belt - Fan To A.C.		♣9463HD
357			Tensioner Assy. - Fan & Alt.	1333545	38506
Belt - Fan, Alt. & A.C.	4080790	♣K080790HD	Tensioner Pulley - Fan & Alt.	1333545	36091
Belt - W.P.		♣9341HD	Hose - Upper - Eng. To Pipe		24240
Hose - Upper - Eng. To Pipe		24232	Hose - Upper - Pipe To Rad.		24240
Hose - Upper - Pipe To Rad.		24240	Hose - Lower - Eng. To Pipe		24240
Hose - Lower - Eng. To Pipe		24232	Hose - Lower - Pipe To Rad.		24248
Hose - Lower - Pipe To Rad.		24240	385		
Caterpillar C10 Diesel			Belt - Fan & Alt.	4080710	♣K080710HD
320			Belt - A.C.		♣9463HD
Belt - Fan & Alt.	4080910	♣K080910HD	Tensioner Assy. - Fan & Alt.	1333545	38506
Belt - A.C.	4060490	♣K060490HD	Tensioner Pulley - Fan & Alt.	1333545	36091
Tensioner Assy. - Fan & Alt.	1900649	38506	Hose - Upper - Eng. To Pipe		24240
Tensioner Assy. - A.C.	1481974	38506	Hose - Upper - Pipe To Rad.		24240
Idler Pulley	1731498	36231	Hose - Lower - Eng. To Pipe		24240
378; 379			Hose - Lower - Pipe To Rad.		24248
Belt - Fan & Alt.	4080710	♣K080710HD	387		
Belt - A.C.		♣9463HD	Belt - Fan & Alt.	4080805	♣K080806HD
Tensioner Assy. - Fan & Alt.	1333545	38506	Belt - Fan To A.C.	4060560	♣K060560HD
Tensioner Pulley - Fan & Alt.	1333545	36091	Tensioner Assy. - Fan & Alt.	1481974	38506
Hose - Upper - Eng. To Pipe		24240	Tensioner Pulley - Fan & Alt.	1481974	36091
Hose - Upper - Pipe To Rad.		24240	Idler Pulley - Fan & Alt.; W/Flat Idler Pulley .	1337023	36091
Hose - Lower - Eng. To Pipe		24240	Idler Pulley - Fan & Alt.; W/Multi-Grooved		
Hose - Lower - Pipe To Rad.		24248	Idler Pulley	1731498	36231
378; 379			Caterpillar C15 Diesel		
Belt - Fan & Alt.		♣K080740HD	357		
♣Standard Belt Available.			Belt - Fan	011024800	②TR22545
			Belt - Fan To Alt. & A.C.	D11023875	②♣9600HD
			②Two Required.		

Belts and Coolant Hose for Medium/Heavy-Duty Trucks (2001 & Newer)

Application	Mfr. Part No.	Our No.	Application	Mfr. Part No.	Our No.
Peterbilt - Continued			Peterbilt - Continued		
2002 - Continued			2002 - Continued		
Caterpillar C15 Diesel - Continued			Cummins ISM Diesel		
357 - Continued			357		
Hose - Upper - Eng. To Pipe		24240	Belt - Fan & Alt.	5080775	♣K080776HD
Hose - Upper - Pipe To Rad.		24240	Belt - Hub & A.C.	4004824	♣K060539HD
Hose - Lower - Eng. To Pipe		24248	Tensioner Assy. - Fan & Alt.	3400885	38521
Hose - Lower - Pipe To Pipe		24248	Tensioner Assy. - Hub & A.C.	4004933	38505
Hose - Lower - Pipe To Rad.		24248	Idler Pulley - Fan & Alt.	3400884	36308
378; 379			Hose - Upper - Eng. To Pipe		24236
Belt - Fan		②TR22545	Hose - Upper - Pipe To Rad.		24240
Belt - Fan, Alt. & A.C.		②♣9590HD	Hose - Lower - Eng. To Pipe		24240
Hose - Upper - Eng. To Pipe		24240	Hose - Lower - Pipe To Rad.		24248
Hose - Upper - Pipe To Rad.		24240	385		
Hose - Lower - Eng. To Pipe		24052	Belt - Fan & Alt.		♣K080774HD
Hose - Lower - Pipe To Rad.		24052	Belt - Hub & A.C.	4004824	♣K060539HD
387			Tensioner Assy. - Fan & Alt.	3400885	38521
Belt - Fan & Alt.		♣K080922HD	Tensioner Assy. - Hub & A.C.	4004933	38505
Belt - Fan To A.C.	D11026302	♣K060560HD	Tensioner Pulley - Hub & A.C.	4004933	36091
Tensioner Assy. - Fan & Alt.	1352142	38506	Idler Pulley - Fan & Alt.	3400884	36308
Tensioner Assy. - Fan To A.C.	1382514	38508	Hose - Upper - Eng. To Pipe		24236
Tensioner Pulley - Fan & Alt.	1352142	36091	Hose - Upper - Pipe To Rad.		24240
Tensioner Pulley - Fan To A.C.	1382514	36091	Hose - Lower - Eng. To Pipe		24240
Hose - Upper - Eng. To Pipe		♣21115	Hose - Lower - Pipe To Rad.		24240
or		24240	Cummins ISX Diesel		
Hose - Lower - Eng. To Pipe		24248	378; 379		
Hose - Lower - Pipe To Pipe		24240	Belt - Fan & Hub	3682644	♣K120924HD
Hose - Lower - Pipe To Rad.		21891	Belt - Hub, Alt. & A.C.	3682684	♣K060637HD
Caterpillar C16 Diesel			Tensioner Assy. - Fan & Hub	3681240	38535
357			Tensioner Assy. - Hub, Alt. & A.C.	3680194	38532
Belt - Fan	011024800	②TR22545	Tensioner Pulley - Fan & Hub	3681240	36092
Belt - Fan To Alt. & A.C.	D11023875	②♣9600HD	Tensioner Pulley - Hub, Alt. & A.C.	3680194	36095
Hose - Upper - Eng. To Pipe		24240	Idler Pulley - Alt. & A.C.	4026886	36226
Hose - Upper - Pipe To Rad.		24240	Hose - Upper - Eng. To Pipe		24240
Hose - Lower - Eng. To Pipe		24248	Hose - Upper - Pipe To Rad.		24240
Hose - Lower - Pipe To Pipe		24248	Hose - Lower - Eng. To Pipe		24240
Hose - Lower - Pipe To Rad.		24248	Hose - Lower - Pipe To Rad.		24240
379			387		
Belt - Fan		②TR22545	Belt - Fan	3681823	♣K100670HD
Belt - Fan To Alt. & A.C.		②♣9590HD	Belt - Hub, Alt. & A.C.	3682684	♣K060637HD
Hose - Upper - Eng. To Pipe		24240	Tensioner Assy. - Fan	3681240	38535
Hose - Upper - Pipe To Rad.		24240	Tensioner Assy. - Hub, Alt. & A.C.	3680194	38532
Hose - Lower - Eng. To Pipe		24052	Tensioner Pulley - Fan	3681240	36092
Hose - Lower - Pipe To Rad.		24052	Tensioner Pulley - Hub, Alt. & A.C.	3680194	36095
387			Idler Pulley - Alt. & A.C.	4026886	36226
Belt - Fan & Alt.		♣K080922HD	Hose - Upper - Eng. To Pipe		24240
Belt - Fan To A.C.	D11026302	♣K060560HD	Hose - Upper - Pipe To Rad.		24240
Tensioner Assy. - Fan & Alt.	1352142	38506	Hose - Lower - Eng. To Pipe		24240
Tensioner Assy. - Fan To A.C.	1382514	38508	Hose - Lower - Pipe To Rad.		24240
Tensioner Pulley - Fan & Alt.	1352142	36091	Cummins N14 Diesel		
Tensioner Pulley - Fan To A.C.	1382514	36091	378; 379; 385		
Hose - Upper - Eng. To Pipe		♣21115	Belt - Alt.		②♣9451HD
or		24240	Belt - Fan		②TR28473
Hose - Lower - Eng. To Pipe		24248	Belt - A.C.		♣9415HD
Hose - Lower - Pipe To Pipe		24240	Belt - Hub & W.P.		♣K060425HD
Hose - Lower - Pipe To Rad.		21891	Hose - Upper - Eng. To Pipe		24240
Cummins ISC Diesel			Hose - Upper - Pipe To Rad.		24240
330			Hose - Lower - Eng. To Pipe		24240
Belt - Fan, Alt. & Hub	3944838	♣K080755HD	Hose - Lower - Pipe To Rad.		24248
Belt - Fan & A.C.		♣9390HD	Cummins Signature 600 Diesel		
Tensioner Assy. - Fan, Alt. & Hub	3945527	38516	378; 379		
Tensioner Pulley - Fan, Alt. & Hub	3945527	36093	Belt - Fan & Hub	3682644	♣K120924HD
Hose - Upper - Eng. To Pipe		21135	Belt - Hub, Alt. & A.C.	3682684	♣K060637HD
Hose - Upper - Pipe To Rad.		24240	Tensioner Assy. - Fan & Hub	3681240	38535
Hose - Lower - Eng. To Pipe		21891	Tensioner Assy. - Hub, Alt. & A.C.	3680194	38532
Hose - Lower - Pipe To Rad.		24240	Tensioner Pulley - Fan & Hub	3681240	36092
			Tensioner Pulley - Hub, Alt. & A.C.	3680194	36095

Medium & Heavy-Duty Trucks
(2001 & Newer)

②Two Required.
♣Cut to Fit.

♣Standard Belt Available.

Belts and Coolant Hose for Medium/Heavy-Duty Trucks (2001 & Newer)

Medium & Heavy-Duty Trucks
(2001 & Newer)

Application	Mfr. Part No.	Our No.	Application	Mfr. Part No.	Our No.
Peterbilt - Continued			Peterbilt - Continued		
2002 - Continued			2001 - Continued		
Cummins Signature 600 Diesel - Continued			Caterpillar C10 Diesel - Continued		
378; 379 - Continued			387		
Idler Pulley - Alt. & A.C.	4026886	36226	Belt - Fan & Alt.	4080805	♣K080806HD
Hose - Upper - Eng. To Pipe		24240	Belt - Fan To A.C.	4060560	♣K060560HD
Hose - Upper - Pipe To Rad.		24240	Tensioner Assy. - Fan & Alt.	1481974	38506
Hose - Lower - Eng. To Pipe		24240	Tensioner Pulley - Fan & Alt.	1481974	36091
Hose - Lower - Pipe To Rad.		24240	Idler Pulley - Fan & Alt.; W/Flat Idler Pulley .	1337023	36091
387			Idler Pulley - Fan & Alt.; W/Multi-Grooved		
Belt - Fan	3681823	♣K100670HD	Idler Pulley	1731498	36231
Belt - Hub, Alt. & A.C.	3682684	♣K060637HD	Caterpillar C12 Diesel		
Tensioner Assy. - Fan	3681240	38535	357		
Tensioner Assy. - Hub, Alt. & A.C.	3680194	38532	Belt - Fan & Alt.	4080710	♣K080710HD
Tensioner Pulley - Fan	3681240	36092	Belt - A.C.		♣9463HD
Tensioner Pulley - Hub, Alt. & A.C.	3680194	36095	Tensioner Assy. - Fan & Alt.	1333545	38506
Idler Pulley - Alt. & A.C.	4026886	36226	Tensioner Pulley - Fan & Alt.	1333545	36091
Hose - Upper - Eng. To Pipe		24240	Hose - Upper - Eng. To Pipe		24240
Hose - Upper - Pipe To Rad.		24240	Hose - Upper - Pipe To Rad.		24240
Hose - Lower - Eng. To Pipe		24240	Hose - Lower - Eng. To Pipe		24240
Hose - Lower - Pipe To Rad.		24240	Hose - Lower - Pipe To Rad.		24248
2001			378; 379		
Caterpillar 3126 Diesel			Belt - Fan & Alt.		
330			Belt - Fan To A.C.		
Belt - Fan, Alt. & A.C.	4080803	♣K080806HD	Tensioner Assy. - Fan & Alt.		
Belt - W.P.	0366775	♣9341HD	Hose - Upper - Eng. To Pipe		
Tensioner Assy. - Fan, Alt. & A.C.	1352151	38511	Hose - Upper - Pipe To Rad.		
Tensioner Pulley - Fan, Alt. & A.C.	1352151	36091	Hose - Lower - Eng. To Pipe		
Hose - Upper - Eng. To Pipe		24232	Hose - Lower - Pipe To Rad.		
Hose - Upper - Pipe To Rad.		24240	385		
Hose - Lower - Eng. To Pipe		24232	Belt - Fan & Alt.		
Hose - Lower - Pipe To Rad.		24240	Belt - A.C.		
357			Tensioner Assy. - Fan & Alt.		
Belt - Fan, Alt. & A.C.	4080790	♣K080790HD	Tensioner Pulley - Fan & Alt.		
Belt - W.P.	0366775	♣9341HD	Hose - Upper - Eng. To Pipe		
Hose - Upper - Eng. To Pipe		24232	Hose - Upper - Pipe To Rad.		
Hose - Upper - Pipe To Rad.		24240	Hose - Lower - Eng. To Pipe		
Hose - Lower - Eng. To Pipe		24232	Hose - Lower - Pipe To Rad.		
Hose - Lower - Pipe To Rad.		24240	387		
Caterpillar C10 Diesel			Belt - Fan & Alt.		
357			Belt - Fan To A.C.		
Belt - Fan & Alt.	4080710	♣K080710HD	Tensioner Assy. - Fan & Alt.		
Belt - A.C.		♣9463HD	Tensioner Pulley - Fan & Alt.		
Tensioner Assy. - Fan & Alt.	1333545	38506	Idler Pulley - Fan & Alt.; W/Flat Idler Pulley .		
Tensioner Pulley - Fan & Alt.	1333545	36091	Idler Pulley - Fan & Alt.; W/Multi-Grooved		
Hose - Upper - Eng. To Pipe		24240	Idler Pulley		
Hose - Upper - Pipe To Rad.		24240	1731498		
Hose - Lower - Eng. To Pipe		24240	Caterpillar C15 Diesel		
Hose - Lower - Pipe To Rad.		24248	378		
378; 379			Belt - Fan		
Belt - Fan & Alt.	4080740	♣K080740HD	Belt - Fan, Alt. & A.C.		
Belt - Fan To A.C.		♣9463HD	Hose - Upper - Eng. To Pipe		
Tensioner Assy. - Fan & Alt.	1333542	38514	Hose - Upper - Pipe To Rad.		
Hose - Upper - Eng. To Pipe		24240	Hose - Lower - Eng. To Pipe		
Hose - Upper - Pipe To Rad.		24240	Hose - Lower - Pipe To Rad.		
Hose - Lower - Eng. To Pipe		24240	379		
Hose - Lower - Pipe To Rad.		24248	Belt - Fan		
385			Belt - Fan To Alt. & A.C.		
Belt - Fan & Alt.	4080710	♣K080710HD	Hose - Upper - Eng. To Pipe		
Belt - A.C.		♣9463HD	Hose - Upper - Pipe To Rad.		
Tensioner Assy. - Fan & Alt.	1333545	38506	Hose - Lower - Eng. To Pipe		
Tensioner Pulley - Fan & Alt.	1333545	36091	Hose - Lower - Pipe To Rad.		
Hose - Upper - Eng. To Pipe		24240	387		
Hose - Upper - Pipe To Rad.		24240	Belt - Fan & Alt.		
Hose - Lower - Eng. To Pipe		24240	Belt - Fan To A.C.		
Hose - Lower - Pipe To Rad.		24248	Tensioner Assy. - Fan & Alt.		
387			Tensioner Assy. - Fan To A.C.		
Belt - Fan & Alt.	4080805	♣K080806HD	Tensioner Pulley - Fan & Alt.		
Belt - Fan To A.C.	4060560	♣K060560HD	Tensioner Pulley - Fan & Alt.		
Tensioner Assy. - Fan & Alt.	1481974	38506	Tensioner Pulley - Fan & Alt.		
Tensioner Pulley - Fan & Alt.	1481974	36091	Tensioner Pulley - Fan To A.C.		
Idler Pulley - Fan & Alt.; W/Flat Idler Pulley .	1337023	36091	Tensioner Pulley - Fan & Alt.		
Idler Pulley - Fan & Alt.; W/Multi-Grooved			Tensioner Pulley - Fan To A.C.		
Idler Pulley	1731498	36231	Tensioner Pulley - Fan To A.C.		

♣Standard Belt Available.
∞Cut to Fit.

ⓂTwo Required.

Belts and Coolant Hose for Medium/Heavy-Duty Trucks (2001 & Newer)

Application	Mfr. Part No.	Our No.	Application	Mfr. Part No.	Our No.
Peterbilt - Continued			Peterbilt - Continued		
2001 - Continued			2001 - Continued		
Caterpillar C15 Diesel - Continued			Cummins ISM Diesel - Continued		
387 - Continued			357 - Continued		
Hose - Upper - Eng. To Pipe		≧21115	Tensioner Assy. - Hub & A.C.	4004933	38505
	or	24240	Idler Pulley - Fan & Alt.	3400884	36308
Hose - Lower - Eng. To Pipe		24052	Hose - Upper - Eng. To Pipe		24236
Hose - Lower - Pipe To Rad.		24240	Hose - Upper - Pipe To Rad.		24240
Caterpillar C16 Diesel			Hose - Lower - Eng. To Pipe		
378			Hose - Lower - Pipe To Rad.		
Belt - Fan		②TR22545	378		
Belt - Fan, Alt. & A.C.		②▲9590HD	Belt - Fan, Alt. & Hub	4080717	▲K080720HD
Hose - Upper - Eng. To Pipe		24240	Belt - Hub & A.C.	4004824	▲K060539HD
Hose - Upper - Pipe To Rad.		24240	Tensioner Assy. - Fan, Alt. & Hub	3400885	38521
Hose - Lower - Eng. To Pipe		24052	Tensioner Assy. - Hub & A.C.	4004933	38505
Hose - Lower - Pipe To Rad.		24052	Idler Pulley - Fan & Alt.	3400884	36308
379			Tensioner Pulley - Hub & A.C.		
Belt - Fan		②TR22545	Hose - Upper - Eng. To Pipe		
Belt - Fan To Alt. & A.C.		②▲9590HD	Hose - Upper - Pipe To Rad.		
Hose - Upper - Eng. To Pipe		24240	Hose - Lower - Eng. To Pipe		
Hose - Upper - Pipe To Rad.		24240	Hose - Lower - Pipe To Rad.		
Hose - Lower - Eng. To Pipe		24052	Cummins ISX Diesel		
Hose - Lower - Pipe To Rad.		24052	378; 379; 387		
387			Belt - Fan & Hub		
Belt - Fan & Alt.		▲K080922HD	Belt - Hub, Alt. & A.C.		
Belt - Fan To A.C.		▲K060560HD	Tensioner Assy. - Fan & Hub		
Tensioner Assy. - Fan & Alt.	1352142	38506	Tensioner Assy. - Hub, Alt. & A.C.		
Tensioner Assy. - Fan To A.C.	1382514	38508	Tensioner Pulley - Fan & Hub		
Tensioner Pulley - Fan & Alt.	1352142	36091	Tensioner Pulley - Hub, Alt. & A.C.		
Tensioner Pulley - Fan To A.C.	1382514	36091	Idler Pulley - Alt. & A.C.		
Hose - Upper - Eng. To Pipe		≧21115	Hose - Upper - Eng. To Pipe		
	or	24240	Hose - Upper - Pipe To Rad.		
Hose - Lower - Eng. To Pipe		24052	Hose - Lower - Eng. To Pipe		
Hose - Lower - Pipe To Rad.		24240	Hose - Lower - Pipe To Rad.		
Cummins ISB Diesel			Cummins N14 Diesel		
270			378; 379		
Belt - Hub & Alt.	3911579	▲K080675HD	Belt - Alt.; W/130A. Delco Alt.		
Belt - A.C.		▲9480HD	Belt - Alt.; W/135A. Delco Alt.		
Cummins ISC Diesel			Belt - Hub & A.C.		
330			Belt - Hub & Fan		
Belt - Fan, Alt. & Hub	3944838	▲K080755HD	Belt - Hub & W.P.		
Belt - Fan & A.C.		▲9390HD	Hose - Upper - Eng. To Pipe		
Tensioner Assy. - Fan, Alt. & Hub	3945527	38516	Hose - Upper - Pipe To Rad.		
Tensioner Pulley - Fan, Alt. & Hub	3945527	36093	Hose - Lower - Eng. To Pipe		
Hose - Upper - Eng. To Pipe		21135	Hose - Lower - Pipe To Pipe		
Hose - Upper - Pipe To Rad.		24240	Hose - Lower - Pipe To Rad.		
Hose - Lower - Eng. To Pipe; W/Man. Trans.		21891	Cummins Signature 600 Diesel		
Hose - Lower - Pipe To Cooler; W/Auto. Trans.		24236	378; 379; 387		
Hose - Lower - Cooler To Pipe; W/Auto. Trans.		24236	Belt - Fan & Hub		
Hose - Lower - Pipe To Rad.		24240	Belt - Hub, Alt. & A.C.		
357			Tensioner Assy. - Fan & Hub		
Belt - Fan & Alt.	3944839	▲K080765HD	Tensioner Assy. - Hub, Alt. & A.C.		
Tensioner Pulley - A.C.	4004933	36091	Tensioner Pulley - Fan & Hub		
Hose - Upper - Eng. To Pipe		21194	Tensioner Pulley - Hub, Alt. & A.C.		
Hose - Upper - Pipe To Rad.		24240	Idler Pulley - Alt. & A.C.		
Hose - Lower - Eng. To Pipe		21891	Hose - Upper - Eng. To Pipe		
Hose - Lower - Pipe To Rad.		24240	Hose - Upper - Pipe To Rad.		
Cummins ISM Diesel			Hose - Lower - Eng. To Pipe		
320			Hose - Lower - Pipe To Rad.		
Belt - Fan	D8410003081970	▲K080776HD	Detroit Diesel 6-Cyl. 11.1 L Diesel		
Belt - Alt.	4004824	▲K060539HD	379		
Tensioner Assy. - Fan	3102888	38505	Belt - Fan; W/53 1/2" Belt O.C.; Preferred Belt		
357			Belt - Fan; W/53 1/2" Belt O.C.; Optional Belt		
Belt - Fan & Alt.	5080775	▲K080776HD	Belt - Hub & Alt.; W/V-Belt Drive		
Belt - Hub & A.C.	4004824	▲K060539HD	Belt - Hub, Alt. & A.C.; W/V-Ribbed Belt		
Tensioner Assy. - Fan & Alt.	3400885	38521	Drive		

②Two Required.
≧Cut to Fit.

▲Standard Belt Available.
③Three Required.

Medium & Heavy-Duty Trucks
(2001 & Newer)

Belts and Coolant Hose for Medium/Heavy-Duty Trucks (2001 & Newer)

Medium & Heavy-Duty Trucks
(2001 & Newer)

Application	Mfr. Part No.	Our No.	Application	Mfr. Part No.	Our No.
Peterbilt - Continued			Sterling - Continued		
2001 - Continued			2009 - Continued		
Detroit Diesel 6-Cyl. 11.1 L Diesel - Continued			Mercedes-Benz MBE 4000 Diesel		
379 - Continued			A-Line		
Tensioner Assy. - Hub, Alt. & A.C.	23520317	38501	Belt - A.C. & Alt.	0124587002	♣K080855HD
Tensioner Pulley - Hub, Alt. & A.C.		38075	Belt - Fan & W.P.	0127116013	♣K080505HD
Hose - Upper - Eng. To Pipe		24240	Tensioner Assy. - Fan	0127427001	38597
Hose - Upper - Pipe To Rad.		24240	Tensioner Assy. - Alt. & A.C.	0127425000	38501
Hose - Lower - Eng. To Pipe		24240	Idler Pulley - Alt. & A.C.	0127426000	36302
Hose - Lower - Pipe To Rad.		24248	L-Line		
Detroit Diesel 6-Cyl. 12.7 L Diesel			Tensioner Assy. - Fan		
377			Tensioner Assy. - Alt. & A.C.		
Belt - Fan; W/53 1/2" Belt O.C.; Preferred Belt		3/9530PB	Idler Pulley		
Belt - Fan; W/53 1/2" Belt O.C.; Optional Belt		♸9530HD	2008		
Belt - Fan; W/54 1/2" Belt O.C.		♸9540HD	Caterpillar C15 Diesel		
Belt - Fan & A.C.	17544	♣9545HD	L-Line		
Belt - Hub & Alt.; V-Belt	17305	♣9305HD	Belt - Fan & A.C.		
Belt - Hub & Alt.; W/V-Ribbed Belt	23524524	♣K080570HD	Tensioner Assy. - Fan & A.C.		
Hose - Upper - Eng. To Pipe		24240	Tensioner Assy. - Alt.		
Hose - Upper - Pipe To Rad.		24240	Hose - Lower - Eng. To Pipe		
Hose - Lower - Eng. To Pipe		24240	Hose - Lower - Rad. To Pipe		
Hose - Lower - Pipe To Rad.		24248	Cummins ISB-07 Diesel		
379			Acterra		
Belt - Fan; W/53 1/2" Belt O.C.; Preferred Belt		3/9530PB	Belt - Fan, Alt. & A.C.		
Belt - Fan; W/53 1/2" Belt O.C.; Optional Belt		♸9530HD	Tensioner Assy. - Fan, Alt. & A.C.		
Belt - Hub & Alt.; W/V-Belt Drive		♸9305HD	Hose - Lower - Eng. To Pipe		
Belt - Hub, Alt. & A.C.; W/V-Ribbed Belt Drive	23524524	♣K080570HD	Hose - Lower - Rad. To Pipe		
Tensioner Assy. - Hub, Alt. & A.C.	23520317	38501	Bullet		
Tensioner Pulley - Hub, Alt. & A.C.		38075	Belt - A.C. To Fan & W.P.		
Hose - Upper - Eng. To Pipe		24240	Cummins ISC Diesel		
Hose - Upper - Pipe To Rad.		24240	Acterra		
Hose - Lower - Eng. To Pipe		24240	Belt - W.P., Fan, Alt. & A.C.		
Hose - Lower - Pipe To Rad.		24248	Tensioner Assy. - Fan, W.P. & Alt.		
Sterling			Idler Pulley		
2009			Tensioner Pulley - Fan, W.P. & Alt.		
Cummins ISC Diesel			Hose - Upper - Eng. To Pipe		
Acterra			Hose - Upper - Rad. To Pipe		
Belt - Fan, A.C., Alt. & W.P.	0123415100	♣K080820HD	Hose - Lower - Eng. To Pipe		
Tensioner Assy. - Fan, A.C., Alt. & W.P.	3973819	38627	Hose - Lower - Rad. To Pipe		
Idler Pulley - Fan, A.C., Alt. & W.P.	3970945	36283	Detroit Diesel 6-Cyl. 12.7 L Diesel		
Hose - Upper - Eng. To Pipe		♣24636	L-Line		
Hose - Upper - Pipe To Rad.		♣24632	Belt - Fan		
Hose - Lower - Eng. To Pipe		♣24636	Belt - Hub, Alt. & A.C.		
Hose - Lower - Pipe To Rad.		♣24632	Tensioner Assy. - Fan		
L-Line			Tensioner Assy. - Hub, Alt. & A.C.		
Belt - Fan, Alt. & W.P.	0123415036	K080962HD	Tensioner Pulley - Fan		
Tensioner Assy. - Fan, W.P. & Alt.	3973819	38627	Tensioner Pulley - Hub, Alt. & A.C.		
Hose - Lower - Pipe To Rad.		21571	Hose - Upper - Eng. To Pipe		
Detroit Diesel 6-Cyl. 14.0 L Diesel			Hose - Upper - Rad. To Pipe		
L-Line			Hose - Lower - Eng. To Pipe		
Belt - Alt.	0124587006	♣K080570HD	Detroit Diesel 6-Cyl. 14.0 L Diesel		
Belt - Fan	0124894004	♣K100502HD	L-Line		
Tensioner Assy. - Alt.	0127425000	38501	Belt - Fan		
Tensioner Assy. - Fan	0127846000	38503	Belt - Hub, Alt. & A.C.		
Detroit Diesel DD13 Diesel			Tensioner Assy. - Fan		
A-Line; L-Line			Tensioner Assy. - Hub, Alt. & A.C.		
Tensioner Assy.	A4722000570	38667	Tensioner Pulley - Fan		
Detroit Diesel DD15 Diesel			Tensioner Pulley - Hub, Alt. & A.C.		
A-Line; L-Line; Nightshift			Hose - Upper - Eng. To Pipe		
Tensioner Assy.	A4722000570	38667	Hose - Upper - Rad. To Pipe		
			Hose - Lower - Eng. To Pipe		

♣Standard Belt Available.
♸Two Required.

♣Three Required.
♣<Cut to Fit.

Belts and Coolant Hose for Medium/Heavy-Duty Trucks (2001 & Newer)

Application	Mfr. Part No.	Our No.	Application	Mfr. Part No.	Our No.
Sterling - Continued			Sterling - Continued		
2008 - Continued			2007 - Continued		
Mercedes-Benz MBE 4000 Diesel			Caterpillar C15 Diesel - Continued		
A-Line			A-Line - Continued		
Belt - Fan	0127116013	♣K080505HD	Idler Pulley - Grooved	1979642	36341
Belt - W.P., Alt. & A.C.	0124587002	♣K080855HD	L-Line		
Tensioner Assy. - Fan	0127427001	38597	Belt - Fan, Alt. & A.C.; W/Set Back Axle	0123415080	♣K081005HD
Tensioner Assy. - Accessory Drive	0127425000	38501	Belt - Fan, Alt. & A.C.; W/Set Forward Axle	0123415082	♣K081079HD
Hose - Lower - Eng. To Pipe		24045	Tensioner Assy. - Fan, Alt. & A.C.	2117895	38590
2007			Tensioner Pulley - Fan, Alt. & A.C.	2117895	36164
Caterpillar C7 Diesel			Idler Pulley - Smooth	1979641	36091
Acterra			Idler Pulley - Grooved	1979642	36341
Belt - Fan, Alt. & A.C.	0123415098	♣K080694HD	Hose - Upper - Eng. To Rad.		22980
Belt - W.P.	0366775	♣9341HD	Hose - Lower - Eng. To Pipe; W/Set Forward Axle		22980
Idler Pulley - Upper	1979641	36091	Hose - Lower - Pipe To Cooler		21891
Idler Pulley - Lower	2534525	36096	Hose - Lower - Cooler To Pipe		21891
Hose - Upper - Eng. To Pipe		20206	Cummins ISB Diesel		
Hose - Upper - Rad. To Pipe		24232	SC8000		
Hose - Lower - Eng. To Pipe		20206	Belt - Accessory Drive	3290073	♣K080605HD
Hose - Lower - Rad. To Pipe		20206	Tensioner Assy.	3957433	38517
L-Line			Cummins ISC Diesel		
Belt - Fan & Alt.	0123415077	K080813HD	Acterra		
Tensioner Assy. - Fan & Alt.	2222880	38586	Belt - W.P., Fan, Alt. & A.C.	0123415100	♣K080820HD
Idler Pulley - Upper	1979641	36091	Belt - Fan, W.P. & Alt.	3289325	♣K080708HD
Caterpillar C9 Diesel			Belt - Fan To A.C.	2310001067	♣9480HD
A-Line			Tensioner Assy. - Fan, W.P. & Alt.	3936213	38516
Idler Pulley - Smooth	2078118	36269	Idler Pulley	3970945	36283
L-Line			Tensioner Pulley - Fan, W.P. & Alt.	3936213	36093
Belt - Fan, Alt. & A.C.	0123415082	♣K081079HD	Hose - Lower - Rad. To Pipe		20206
Tensioner Assy. - Fan, Alt. & A.C.	2117895	38590	L-Line		
Tensioner Pulley - Fan, Alt. & A.C.	2117895	36164	Idler Pulley	3970945	36283
Idler Pulley	2078118	36269	Cummins ISL Diesel		
Hose - Upper - Eng. To Rad.		22980	Condor		
Hose - Lower - Eng. To Rad.		22952	Belt - Fan & Alt.	0123415094	♣K080765HD
Caterpillar C11 Diesel			Detroit Diesel 6-Cyl. 12.7 L Diesel		
A-Line			L-Line		
Idler Pulley - Smooth	2078118	36269	Belt - Fan	0124894000	♣K100579HD
Idler Pulley - Grooved	1979642	36341	Belt - Hub, Alt. & A.C.	0124587004	♣K080565HD
L-Line			Tensioner Assy. - Fan	0127846000	38503
Belt - Fan, Alt. & A.C.	0123415082	♣K081079HD	Tensioner Assy. - Hub, Alt. & A.C.	0127425000	38501
Tensioner Assy. - Fan, Alt. & A.C.	2117895	38590	Tensioner Pulley - Fan	0127846000	38076
Tensioner Pulley - Fan, Alt. & A.C.	2117895	36164	Tensioner Pulley - Hub, Alt. & A.C.	0127425000	38075
Idler Pulley - Smooth	2078118	36269	Hose - Upper - Rad. To Pipe		21115
Idler Pulley - Grooved	1979642	36341	Hose - Upper - Eng. To Pipe		24240
Hose - Upper - Eng. To Rad.		22980	Hose - Lower - Rad. To Pipe		21135
Hose - Lower - Eng. To Rad.		22952	Hose - Lower - Eng. To Pipe		24236
Caterpillar C13 Diesel			Detroit Diesel 6-Cyl. 14.0 L Diesel		
A-Line			L-Line		
Idler Pulley - Smooth	2078118	36269	Belt - Fan	0124894000	♣K100579HD
Idler Pulley - Grooved	1979642	36341	Belt - Hub, Alt. & A.C.	0124587004	♣K080565HD
L-Line			Tensioner Assy. - Fan	0127846000	38503
Belt - Fan, Alt. & A.C.	0123415082	♣K081079HD	Tensioner Assy. - Hub, Alt. & A.C.	0127425000	38501
Belt - Fan To Alt. & A.C.	0123415080	♣K081005HD	Tensioner Pulley - Fan	0127846000	38076
Tensioner Assy. - Fan, Alt. & A.C.	2117895	38590	Tensioner Pulley - Hub, Alt. & A.C.	0127425000	38075
Tensioner Pulley - Fan, Alt. & A.C.	2117895	36164	Hose - Upper - Eng. To Pipe		24240
Idler Pulley - Smooth	2078118	36269	Hose - Upper - Rad. To Pipe		21115
Idler Pulley - Grooved	1979642	36341	Hose - Lower - Eng. To Pipe		24236
Hose - Upper - Eng. To Rad.		22980	Hose - Lower - Rad. To Pipe		21135
Hose - Lower - Eng. To Pipe		24240	Mercedes-Benz MBE 900 Diesel		
Hose - Lower - Rad. To Pipe		24240	Acterra		
Hose - Lower - Cooler To Pipe		21891	Belt - Hub, Fan, Alt. & A.C.	0129866094	♣K080825HD
Hose - Lower - Pipe To Cooler		21891	Tensioner Assy.	9062002470	38567
Caterpillar C15 Diesel			Hose - Lower - Eng. To Pipe		21559
A-Line			Hose - Lower - Rad. To Cooler		20206
Idler Pulley - Smooth	1979641	36091			

♣Standard Belt Available.

Medium & Heavy-Duty Trucks
(2001 & Newer)

Belts and Coolant Hose for Medium/Heavy-Duty Trucks (2001 & Newer)

Medium & Heavy-Duty Trucks
(2001 & Newer)

Application	Mfr. Part No.	Our No.	Application	Mfr. Part No.	Our No.
Sterling - Continued			Sterling - Continued		
2007 - Continued			2006 - Continued		
Mercedes-Benz MBE 4000 Diesel			Caterpillar C13 Diesel - Continued		
A-Line			Acterra - Continued		
Belt - Fan	0127116017	♣K080570HD	Idler Pulley - Grooved	1979642	36341
Belt - Hub, Alt. & A.C.	0127116004	♣K080855HD	Hose - Upper - Eng. To Rad.		22980
Tensioner Assy. - Fan	0127427001	38597	Hose - Lower - Eng. To Rad.		22952
Tensioner Assy. - Hub, Alt. & A.C.	0127425000	38501	A-Line		
L-Line			Belt - Fan, Alt. & A.C.	0123415080	♣K081005HD
Belt - Fan; W/O P.T.O.	0127116013	♣K080505HD	Tensioner Assy. - Fan, Alt. & A.C.	2117895	38590
Belt - Fan; W/P.T.O.	0127116012	♣K080660HD	Tensioner Pulley - Fan, Alt. & A.C.	2117895	36164
Belt - Hub, Alt. & A.C.	0127116004	♣K080855HD	Idler Pulley - Smooth	2078118	36269
Tensioner Assy. - Fan	0127427001	38597	Idler Pulley - Grooved	1979642	36341
Tensioner Assy. - Hub, Alt. & A.C.	0127425000	38501	Hose - Upper - Eng. To Rad.		22980
Tensioner Pulley - Hub, Alt. & A.C.	0127425000	38075	Condor		
Hose - Upper - Eng. To Pipe		24240	Idler Pulley - Smooth	2078118	36269
Hose - Upper - Rad. To Pipe		21891	Idler Pulley - Grooved	1979642	36341
Hose - Lower - Rad. To Pipe		21135	L-Line		
Mitsubishi Fuso 4M50 Diesel			Belt - Fan, Alt. & A.C.; W/Set Back Axle	0123415080	♣K081005HD
360			Belt - Fan, Alt. & A.C.; W/Set Forward Axle .	0123415082	♣K081079HD
Belt - Alt. & A.C.	ME241670	♣K060480HD	Tensioner Assy. - Fan, Alt. & A.C.	2117895	38590
Hose - Upper - Eng. To Rad.		♣20957	Tensioner Pulley - Fan, Alt. & A.C.	2117895	36164
2006			Idler Pulley - Smooth	2078118	36269
Caterpillar C7 Diesel			Idler Pulley - Grooved	1979642	36341
Acterra			Hose - Upper - Eng. To Rad.		22980
Belt - Fan, Alt. & A.C.	0123415098	♣K080694HD	Hose - Lower - Eng. To Pipe; W/Set Back Axle		21135
Belt - W.P.	0366775	♣9341HD	Hose - Lower - Rad. To Pipe; W/Set Back Axle		21135
Idler Pulley - Upper	1979641	36091	Hose - Lower - Eng. To Rad.; W/Set Forward Axle		22952
Idler Pulley - Lower	2534525	36096	Caterpillar C15 Diesel		
Hose - Upper - Eng. To Pipe		20206	A-Line		
Hose - Upper - Rad. To Pipe		24232	Belt - Fan, Alt. & A.C.	0123415080	♣K081005HD
Hose - Lower - Eng. To Pipe		20206	Tensioner Assy. - Fan, Alt. & A.C.	2117895	38590
Hose - Lower - Rad. To Pipe		20206	Tensioner Pulley - Fan, Alt. & A.C.	2117895	36164
Condor; L-Line			Idler Pulley - Smooth	1979641	36091
Idler Pulley - Upper	1979641	36091	Idler Pulley - Grooved	1979642	36341
Caterpillar C9 Diesel			Hose - Upper - Eng. To Rad.		22980
Acterra; A-Line; Condor			L-Line		
Idler Pulley - Smooth	2078118	36269	Belt - Fan, Alt. & A.C.; W/Set Back Axle	0123415080	♣K081005HD
L-Line			Belt - Fan, Alt. & A.C.; W/Set Forward Axle .	0123415082	♣K081079HD
Tensioner Assy. - Fan, Alt. & A.C.	2117895	38590	Tensioner Assy. - Fan, Alt. & A.C.	2117895	38590
Tensioner Pulley - Fan, Alt. & A.C.	2117895	36164	Tensioner Pulley - Fan, Alt. & A.C.	2117895	36164
Idler Pulley	1979641	36091	Idler Pulley - Smooth	1979641	36091
Caterpillar C11 Diesel			Idler Pulley - Grooved	1979642	36341
A-Line			Hose - Upper - Eng. To Rad.		22980
Belt - Fan, Alt. & A.C.	0123415080	♣K081005HD	Cummins ISB Diesel		
Tensioner Assy. - Fan, Alt. & A.C.	2117895	38590	SC8000		
Tensioner Pulley - Fan, Alt. & A.C.	2117895	36164	Belt - Accessory Drive	3290073	♣K080605HD
Idler Pulley - Smooth	2078118	36269	Tensioner Assy.	3957433	38517
Idler Pulley - Grooved	1979642	36341	Cummins ISC Diesel		
Hose - Upper - Eng. To Rad.		22980	Acterra		
L-Line			Belt - W.P., Fan, Alt. & A.C.	0123415100	♣K080820HD
Belt - Fan, Alt. & A.C.	0123415082	♣K081079HD	Belt - Fan, W.P. & Alt.	3289325	♣K080708HD
Tensioner Assy. - Fan, Alt. & A.C.	2117895	38590	Belt - Fan To A.C.	2310001067	♣9480HD
Tensioner Pulley - Fan, Alt. & A.C.	2117895	36164	Tensioner Assy. - Fan, W.P. & Alt.	3936213	38516
Idler Pulley - Smooth	2078118	36269	Idler Pulley	3970945	36283
Idler Pulley - Grooved	1979642	36341	Tensioner Pulley - Fan, W.P. & Alt.	3936213	36093
Hose - Upper - Eng. To Rad.		22980	Hose - Lower - Rad. To Pipe		20206
Hose - Lower - Eng. To Rad.		22952	L-Line		
Caterpillar C13 Diesel			Idler Pulley	3970945	36283
Acterra			Cummins ISL Diesel		
Belt - Fan & Alt.; W/P.T.O.	0123415083	♣K080926HD	Condor		
Belt - Fan, Alt. & A.C.; W/O P.T.O.	0123415080	♣K081005HD	Belt - Fan & Alt.	0123415094	♣K080765HD
Tensioner Assy.	2117895	38590			
Tensioner Pulley	2117895	36164			
Idler Pulley - Smooth	2078118	36269			

♣Standard Belt Available.

♣Cut to Fit.

Belts and Coolant Hose for Medium/Heavy-Duty Trucks (2001 & Newer)

Application	Mfr. Part No.	Our No.	Application	Mfr. Part No.	Our No.
Sterling - Continued			Sterling - Continued		
2006 - Continued			2005 - Continued		
Detroit Diesel 6-Cyl. 12.7 L Diesel			Caterpillar C9 Diesel		
A-Line; L-Line			A-Line; Condor		
Belt - Fan	0124894000	♣K100579HD	Idler Pulley	2078118	36269
Belt - Hub, Alt. & A.C.	0124587004	♣K080565HD	L-Line		
Tensioner Assy. - Fan	0127846000	38503	Belt - Fan, Alt. & A.C.	0123415080	♣K081005HD
Tensioner Assy. - Hub, Alt. & A.C.	0127425000	38501	Tensioner Assy. - Fan, Alt. & A.C.	2117895	38590
Tensioner Pulley - Fan	0127846000	38076	Tensioner Pulley - Fan, Alt. & A.C.	2117895	36164
Tensioner Pulley - Hub, Alt. & A.C.	0127425000	38075	Idler Pulley	2078118	36269
Hose - Upper - Rad. To Pipe		21115	Hose - Upper - Eng. To Rad.		22980
Hose - Upper - Eng. To Pipe		24240	Caterpillar C11 Diesel		
Hose - Lower - Rad. To Pipe		21135	A-Line		
Hose - Lower - Eng. To Pipe		24236	Belt - Fan, Alt. & A.C.	0123415080	♣K081005HD
Detroit Diesel 6-Cyl. 14.0 L Diesel			Tensioner Assy. - Fan, Alt. & A.C.	2117895	38590
A-Line; L-Line			Tensioner Pulley - Fan, Alt. & A.C.	2117895	36164
Belt - Fan	0124894000	♣K100579HD	Idler Pulley - Smooth	2078118	36269
Belt - Hub, Alt. & A.C.	0124587004	♣K080565HD	Idler Pulley - Grooved	1979642	36341
Tensioner Assy. - Fan	0127846000	38503	Hose - Upper - Eng. To Rad.		22980
Tensioner Assy. - Hub, Alt. & A.C.	0127425000	38501	Condor		
Tensioner Pulley - Fan	0127846000	38076	Idler Pulley - Smooth	2078118	36269
Tensioner Pulley - Hub, Alt. & A.C.	0127425000	38075	Idler Pulley - Grooved	1979642	36341
Hose - Upper - Rad. To Pipe		21115	Hose - Upper - Eng. To Rad.		22980
Hose - Upper - Eng. To Pipe		24240	Hose - Lower - Eng. To Rad.		22952
Hose - Lower - Rad. To Pipe		21135	Caterpillar C13 Diesel		
Hose - Lower - Eng. To Pipe		24236	A-Line		
Mercedes-Benz MBE 900 Diesel			Belt - Fan, Alt. & A.C.	0123415080	♣K081005HD
Acterra			Tensioner Assy. - Fan, Alt. & A.C.	2117895	38590
Belt - Hub, Fan, Alt. & A.C.	0129866094	♣K080825HD	Tensioner Pulley - Fan, Alt. & A.C.	2117895	36164
Tensioner Assy.	9062002470	38567	Idler Pulley - Smooth	2078118	36269
Hose - Upper - Eng. To Rad.		♣21378	Idler Pulley - Grooved	1979642	36341
Hose - Lower - Rad. To Pipe		24232	Hose - Upper - Eng. To Rad.		22980
Mercedes-Benz MBE 4000 Diesel			Hose - Lower - Eng. To Rad.		22952
A-Line; L-Line			Caterpillar C15 Diesel		
Belt - Fan	0127116005	♣K080545HD	A-Line		
Belt - Hub, Alt. & A.C.	0127116004	♣K080855HD	Belt - Fan, Alt. & A.C.	0123415080	♣K081005HD
Tensioner Assy. - Fan	0127427001	38597	Tensioner Assy. - Fan, Alt. & A.C.	2117895	38590
Tensioner Assy. - Hub, Alt. & A.C.	0127425000	38501	Tensioner Pulley - Fan, Alt. & A.C.	2117895	36164
Tensioner Pulley - Hub, Alt. & A.C.	0127425000	38075	Idler Pulley - Smooth	2078118	36269
Hose - Lower - Eng. To Rad.		23014	Idler Pulley - Grooved	1979642	36341
Mitsubishi Fuso 4M50 Diesel			Hose - Upper - Eng. To Rad.		22980
360			Condor		
Belt - Alt. & A.C.	ME241670	♣K060480HD	Idler Pulley - Smooth	2078118	36269
Hose - Upper - Eng. To Rad.		♣20957	Idler Pulley - Grooved	1979642	36341
2005			Hose - Upper - Eng. To Rad.		22980
Caterpillar C7 Diesel			Caterpillar C15 Diesel		
Acterra			A-Line		
Belt - Fan, Alt. & A.C.	0123415044	♣K080734HD	Belt - Fan, Alt. & A.C.	0123415080	♣K081005HD
Belt - W.P.	0366775	♣9341HD	Tensioner Assy. - Fan, Alt. & A.C.	2117895	38590
Idler Pulley - Upper	1979641	36091	Tensioner Pulley - Fan, Alt. & A.C.	2117895	36164
Idler Pulley - Lower	2534525	36096	Idler Pulley - Smooth	1979641	36091
Hose - Upper - Eng. To Rad.		22668	Idler Pulley - Grooved	1979642	36341
Hose - Lower - Eng. To Pipe		20206	Hose - Upper - Eng. To Rad.		22980
Hose - Lower - Rad. To Pipe		20206	L-Line		
Condor			Belt - Fan, Alt. & A.C.	0123415080	♣K081005HD
Belt - Alt.	0127110027	♣K080865HD	Tensioner Assy. - Fan, Alt. & A.C.	2117895	38590
Tensioner Assy. - Alt.	2222880	38586	Tensioner Pulley - Fan, Alt. & A.C.	2117895	36164
Idler Pulley - Upper	1979641	36091	Idler Pulley - Smooth	1979641	36091
L-Line			Idler Pulley - Grooved	1979642	36341
Belt - Fan, Alt. & A.C.; W/140A. Alt.	0123415092	♣K080876HD	Hose - Upper - Eng. To Rad.		22980
Belt - Fan, Alt. & A.C.; W/130A. Alt.	0123415091	K080885HD	Hose - Lower - Eng. To Pipe		24240
Tensioner Assy. - Fan, Alt. & A.C.	2201209	38550	Hose - Lower - Rad. To Pipe		21135
Idler Pulley - Upper	1979641	36091	Hose - Lower - Pipe To Cooler		21891

♣Standard Belt Available.

♣<Cut to Fit.

Medium & Heavy-Duty Trucks
(2001 & Newer)

Belts and Coolant Hose for Medium/Heavy-Duty Trucks (2001 & Newer)

Medium & Heavy-Duty Trucks
(2001 & Newer)

Application	Mfr. Part No.	Our No.	Application	Mfr. Part No.	Our No.
Sterling - Continued			Sterling - Continued		
2005 - Continued			2004		
Caterpillar C15 Diesel - Continued			Caterpillar 3126 Diesel		
L-Line - Continued			Acterra		
Hose - Lower - Cooler To Pipe		21135	Belt - W.P.	0366775	♣9341HD
Cummins ISB Diesel			Belt - Fan, Alt. & A.C.; W/70 1/2" Belt O.C. .	0123415000	♣K080702HD
SC8000			Belt - Fan, Alt. & A.C.; W/78 1/2" Belt O.C. .	F2HT 8620 FA	♣K080780HD
Belt - Accessory Drive	3290073	♣K080605HD	Tensioner Assy. - Fan, Alt. & A.C.	1352151	38511
Tensioner Assy.	3957433	38517	Idler Pulley	1445612	36096
Cummins ISC Diesel			Tensioner Pulley - Fan, Alt. & A.C.	1352151	36091
Acterra			Hose - Upper - Eng. To Pipe		24232
Belt - W.P., Fan, Alt. & A.C.	0123415100	♣K080820HD	Hose - Upper - Pipe To Rad.		24232
Belt - Fan, W.P. & Alt.	3289325	♣K080708HD	Hose - Lower - Eng. To Pipe		21135
Belt - Fan To A.C.	2310001067	♣9480HD	Hose - Lower - Pipe To Rad.		24240
Tensioner Assy. - Fan, W.P. & Alt.	3936213	38516	L-Line		
Idler Pulley	3970945	36283	Belt - W.P.	0366775	♣9341HD
Tensioner Pulley - Fan, W.P. & Alt.	3936213	36093	Belt - Fan, Alt. & A.C.	0123415048	♣K080776HD
Hose - Upper - Eng. To Pipe		24236	Tensioner Assy. - Fan, Alt. & A.C.	1352151	38511
Hose - Upper - Rad. To Pipe		21571	Tensioner Pulley - Fan, Alt. & A.C.	1352151	36091
Hose - Lower - Eng. To Pipe		20206	Hose - Upper - Eng. To Pipe		♣20206
Hose - Lower - Rad. To Pipe		20206	Hose - Upper - Pipe To Rad.		21571
L-Line			Hose - Lower - Eng. To Pipe		21571
Idler Pulley	3970945	36283	Hose - Lower - Pipe To Rad.		24240
Detroit Diesel 6-Cyl. 12.7 L Diesel			Caterpillar C7 Diesel		
A-Line; L-Line			Acterra		
Belt - Fan	0124894000	♣K100579HD	Belt - Fan, Alt. & A.C.	0123415042	♣K080702HD
Belt - Hub, Alt. & A.C.	0124587004	♣K080565HD	Belt - W.P.	0366775	♣9341HD
Tensioner Assy. - Fan	0127846000	38503	Tensioner Assy. - Fan, Alt. & A.C.		38511
Tensioner Assy. - Hub, Alt. & A.C.	0127425000	38501	Idler Pulley - Upper	1979641	36091
Tensioner Pulley - Fan	0127846000	38076	Idler Pulley	1445612	36096
Tensioner Pulley - Hub, Alt. & A.C.	0127425000	38075	Hose - Upper - Eng. To Rad.		22668
Hose - Upper - Eng. To Pipe		24240	Hose - Lower - Eng. To Pipe		21891
Hose - Upper - Rad. To Pipe		24240	Hose - Lower - Rad. To Pipe		21891
Detroit Diesel 6-Cyl. 14.0 L Diesel			Condor		
A-Line; L-Line			Idler Pulley - Upper		
Belt - Fan	0124894000	♣K100579HD		1979641	36091
Belt - Hub, Alt. & A.C.	0124587004	♣K080565HD	L-Line		
Tensioner Assy. - Fan	0127846000	38503	Belt - W.P.	0366775	♣9341HD
Tensioner Assy. - Hub, Alt. & A.C.	0127425000	38501	Belt - Fan, Alt. & A.C.	0123415048	♣K080776HD
Tensioner Pulley - Fan	0127846000	38076	Tensioner Assy. - Fan, Alt. & A.C.	1352151	38511
Tensioner Pulley - Hub, Alt. & A.C.	0127425000	38075	Tensioner Pulley - Fan, Alt. & A.C.	1352151	36091
Hose - Upper - Eng. To Pipe		24240	Caterpillar C9 Diesel		
Hose - Upper - Rad. To Pipe		24240	A-Line		
Mercedes-Benz MBE 900 Diesel			Belt - Fan, Alt. & A.C.		
Acterra			0123415065		
Belt - Hub, Fan, Alt. & A.C.	0126246000	♣K080830HD	Idler Pulley	2078118	♣K080825HD
Tensioner Assy.	9062002470	38567	Hose - Upper - Eng. To Pipe		36269
Hose - Upper - Eng. To Rad.		♣21378	Hose - Upper - Pipe To Rad.		20206
Hose - Lower - Eng. To Pipe		21571	Hose - Lower - Eng. To Pipe		21492
Hose - Lower - Pipe To Cooler		24232	Hose - Lower - Eng. To Pipe		21891
Hose - Lower - Cooler To Pipe		♣20611	Hose - Lower - Pipe To Rad.		24240
L-Line			Condor		
Belt - Fan	0127116011	♣K080615HD	Idler Pulley		
Belt - Alt.	0127110048	♣K080839HD		2078118	36269
Tensioner Assy. - Fan	0130441000	38589	L-Line		
Mercedes-Benz MBE 4000 Diesel			Belt - Fan, Alt. & A.C.		
A-Line; L-Line			0123415065		
Belt - Fan	0127116005	♣K080545HD	Idler Pulley	2078118	♣K080825HD
Belt - Hub, Alt. & A.C.	0127116004	♣K080855HD	Hose - Upper - Eng. To Pipe		36269
Tensioner Assy. - Fan	0127427001	38597	Hose - Upper - Pipe To Rad.		20206
Tensioner Assy. - Hub, Alt. & A.C.	0127425000	38501	Hose - Lower - Eng. To Pipe		21492
Tensioner Pulley - Hub, Alt. & A.C.	0127425000	38075	Hose - Lower - Eng. To Pipe		21891
Hose - Upper - Eng. To Rad.		22850	Hose - Lower - Pipe To Rad.		24240
Hose - Lower - Eng. To Pipe		21891	Caterpillar C10 Diesel		
Hose - Lower - Pipe To Rad.		24240	A-Line		
♣Standard Belt Available.			Belt - Fan & Alt.		
			0127110026		
			♣K080897HD		
			Belt - A.C.		
			0126709002		
			♣K060523HD		
			Tensioner Assy. - Fan & Alt.		
			1900649		
			Tensioner Assy. - A.C.		
			38524		
			Idler Pulley - Fan & Alt.; W/Flat Idler Pulley .		
			1337023		
			Idler Pulley - Fan & Alt.; W/Multi-Grooved		
			Idler Pulley		
			1731498		
			Tensioner Pulley - Fan & Alt.		
			36091		
			♣Cut to Fit.		

Belts and Coolant Hose for Medium/Heavy-Duty Trucks (2001 & Newer)

Application	Mfr. Part No.	Our No.	Application	Mfr. Part No.	Our No.
Sterling - Continued			Sterling - Continued		
2004 - Continued			2004 - Continued		
Caterpillar C10 Diesel - Continued			Caterpillar C13 Diesel - Continued		
A-Line - Continued			Condor		
Tensioner Pulley - A.C.		36091	Idler Pulley - Smooth	2078118	36269
Hose - Upper - Eng. To Pipe		24240	Idler Pulley - Grooved	1979642	36341
Hose - Upper - Rad. To Pipe		24240	L-Line		
Hose - Lower - Eng. To Pipe		24240	Belt - Fan, Alt. & A.C.	0123415080	♣K081005HD
Hose - Lower - Rad. To Pipe		24240	Tensioner Assy. - Fan, Alt. & A.C.	2117895	38590
L-Line			Tensioner Pulley - Fan, Alt. & A.C.	2117895	36164
Belt - Fan	0127115002	♣K140603HD	Idler Pulley - Smooth	2078118	36269
Belt - Fan To Alt.	C5TS 8620 T	♣9440HD	Idler Pulley - Grooved	1979642	36341
Belt - Fan To A.C.	F6HT 8620 AKA	♣9465HD	Hose - Upper - Eng. To Rad.		22980
Hose - Upper - Eng. To Pipe		22773	Caterpillar C15 Diesel		
Hose - Lower - Eng. To Pipe		24240	A-Line; L-Line		
Hose - Lower - Pipe To Rad.		24240	Idler Pulley - Smooth	1979641	36091
Caterpillar C11 Diesel			Idler Pulley - Grooved	1979642	36341
A-Line			Cummins ISB Diesel		
Belt - Fan, Alt. & A.C.	0123415082	♣K081079HD	SC8000		
Tensioner Assy. - Fan, Alt. & A.C.	2117895	38590	Tensioner Assy. - Fan & Alt.		
Tensioner Pulley - Fan, Alt. & A.C.	2117895	36164	3978021		
Idler Pulley - Smooth	2078118	36269	Cummins ISC Diesel		
Idler Pulley - Grooved	1979642	36341	Acterra; L-Line		
Hose - Upper - Eng. To Rad.		22980	Idler Pulley		
Hose - Lower - Eng. To Rad.		22952	3970945		
Condor			Detroit Diesel 6-Cyl. 12.7 L Diesel		
Idler Pulley - Smooth	2078118	36269	A-Line; L-Line		
Idler Pulley - Grooved	1979642	36341	Belt - Fan	0124894000	♣K100579HD
L-Line			Belt - Hub, Alt. & A.C.	0127116005	♣K080545HD
Belt - Fan, Alt. & A.C.	0123415082	♣K081079HD	Tensioner Assy. - Fan	0127846000	38503
Tensioner Assy. - Fan, Alt. & A.C.	2117895	38590	Tensioner Assy. - Hub, Alt. & A.C.	0127425000	38501
Tensioner Pulley - Fan, Alt. & A.C.	2117895	36164	Tensioner Pulley - Fan	0127846000	38076
Idler Pulley - Smooth	2078118	36269	Tensioner Pulley - Hub, Alt. & A.C.	0127425000	38075
Idler Pulley - Grooved	1979642	36341	Hose - Upper - Eng. To Pipe		21891
Hose - Upper - Eng. To Rad.		22980	Hose - Upper		24240
Hose - Lower - Eng. To Rad.		22952	Detroit Diesel 6-Cyl. 14.0 L Diesel		
Caterpillar C12 Diesel			A-Line; L-Line		
A-Line			Belt - Fan	0124894000	♣K100579HD
Belt - Fan & Alt.	0127110026	♣K080897HD	Belt - Hub, Alt. & A.C.	0127116005	♣K080545HD
Belt - A.C.	0126709002	♣K060523HD	Tensioner Assy. - Fan	0127846000	38503
Tensioner Assy. - Fan & Alt.	1900649	38506	Tensioner Assy. - Hub, Alt. & A.C.	0127425000	38501
Tensioner Assy. - A.C.		38524	Tensioner Pulley - Fan	0127846000	38076
Idler Pulley - Fan & Alt.; W/Flat Idler Pulley .	1337023	36091	Tensioner Pulley - Hub, Alt. & A.C.	0127425000	38075
Idler Pulley - Fan & Alt.; W/Multi-Grooved			Hose - Upper - Eng. To Pipe		21891
Idler Pulley	1731498	36231	Hose - Upper		24240
Tensioner Pulley - Fan & Alt.		36091	Mercedes-Benz MBE 900 Diesel		
Tensioner Pulley - A.C.		36091	Acterra		
Hose - Upper - Eng. To Pipe		24240	Belt - Hub, Fan, Alt. & A.C.; W/O P.T.O.		
Hose - Upper - Rad. To Pipe		24240	0126246000		
Hose - Lower - Eng. To Pipe		24240	Belt - Hub, Fan, Alt. & A.C.; W/P.T.O.		
Hose - Lower - Rad. To Pipe		24240	0127116015		
L-Line			Tensioner Assy.		
Belt - Fan	0127115002	♣K140603HD	9062002470		
Belt - Fan To Alt.	C5TS 8620 T	♣9440HD	Hose - Upper - Eng. To Pipe		
Belt - Fan To A.C.	F6HT 8620 AKA	♣9465HD	22701		
Hose - Upper - Eng. To Pipe		22773	Hose - Upper - Pipe To Rad.		
Hose - Lower - Eng. To Pipe		24240	21135		
Hose - Lower - Pipe To Rad.		24240	Hose - Lower - Eng. To Pipe		
Caterpillar C13 Diesel			21571		
Acterra; A-Line			Hose - Lower - Pipe To Rad.		
Belt - Fan, Alt. & A.C.	0123415080	♣K081005HD	22903		
Idler Pulley - Smooth	2078118	36269	Mercedes-Benz MBE 4000 Diesel		
Idler Pulley - Grooved	1979642	36341	A-Line		
Hose - Upper - Eng. To Rad.		22980	Belt - Fan	0127116005	♣K080545HD
Hose - Lower - Eng. To Pipe		24240	Belt - Hub, Alt. & A.C.	0127116004	♣K080855HD
Hose - Lower - Rad. To Pipe		21891	Tensioner Assy. - Fan	0127427001	38597
2004 - Continued			Tensioner Assy. - Hub, Alt. & A.C.	0127425000	38501
Caterpillar C10 Diesel - Continued			Tensioner Pulley - Hub, Alt. & A.C.	0127425000	38075
A-Line - Continued			Hose - Upper - Eng. To Rad.		22850
Tensioner Pulley - A.C.		36091	Hose - Lower - Eng. To Pipe		21891
Hose - Upper - Eng. To Pipe		24240	Hose - Lower - Pipe To Rad.		24240
Hose - Upper - Rad. To Pipe		24240	L-Line		
Hose - Lower - Eng. To Pipe		24240	Belt - Fan	0127116005	♣K080545HD
Hose - Lower - Rad. To Pipe		24240			

♣Standard Belt Available.

Medium & Heavy-Duty Trucks
(2001 & Newer)

Belts and Coolant Hose for Medium/Heavy-Duty Trucks (2001 & Newer)

Medium & Heavy-Duty Trucks
(2001 & Newer)

Application	Mfr. Part No.	Our No.	Application	Mfr. Part No.	Our No.
Sterling - Continued			Sterling - Continued		
2004 - Continued			2003 - Continued		
Mercedes-Benz MBE 4000 Diesel - Continued			Caterpillar C12 Diesel - Continued		
L-Line - Continued			A-Line - Continued		
Belt - Hub, Alt. & A.C.	0127116004	♣K080855HD	Hose - Upper - Rad. To Pipe		24240
Tensioner Assy. - Fan	0127427001	38597	Hose - Lower - Eng. To Pipe		24240
Tensioner Assy. - Hub, Alt. & A.C.	0127425000	38501	Hose - Lower - Rad. To Pipe		24240
Tensioner Pulley - Hub, Alt. & A.C.	0127425000	38075	Condor		
Hose - Upper - Eng. To Rad.		22850	Belt - Fan & Alt.	0124587007	♣K080878HD
Hose - Lower - Eng. To Pipe		21891	Belt - A.C.		♣K060495HD
Hose - Lower - Pipe To Rad.		24240	Tensioner Assy. - Fan & Alt.	1900649	38506
2003			Tensioner Assy. - A.C.	0127846000	38503
Caterpillar 3126 Diesel			Hose - Upper - Eng. To Pipe		21891
Acterra			Hose - Upper - Rad. To Pipe		21135
Belt - W.P.	0366775	♣9341HD	Hose - Lower - Eng. To Pipe		21891
Belt - Fan, Alt. & A.C.; W/70 1/2" Belt O.C. .	0123415000	♣K080702HD	Hose - Lower - Rad. To Pipe		21135
Belt - Fan, Alt. & A.C.; W/78 1/2" Belt O.C. .	F2HT 8620 FA	♣K080780HD	L-Line		
Tensioner Assy. - Fan, Alt. & A.C.	1352151	38511	Belt - Fan	0127115002	♣K140603HD
Idler Pulley	1445612	36096	Belt - Fan To Alt.	C5TS 8620 T	♣9440HD
Tensioner Pulley - Fan, Alt. & A.C.	1352151	36091	Belt - Fan To A.C.	F6HT 8620 AKA	♣9465HD
Hose - Upper - Eng. To Pipe		24232	Hose - Upper - Eng. To Pipe		22773
Hose - Upper - Pipe To Rad.		24232	Hose - Lower - Eng. To Pipe		24240
Hose - Lower - Eng. To Pipe		21135	Hose - Lower - Pipe To Rad.		24240
Hose - Lower - Pipe To Rad.		24240	Cummins ISB Diesel		
L-Line			SC7000; SC8000		
Belt - W.P.	0366775	♣9341HD	Tensioner Assy. - Fan & Alt.	3978021	38517
Belt - Fan, Alt. & A.C.	0123415048	♣K080776HD	Cummins ISC Diesel		
Tensioner Assy. - Fan, Alt. & A.C.	1352151	38511	L-Line		
Tensioner Pulley - Fan, Alt. & A.C.	1352151	36091	Belt - Fan & Alt.	3939897	♣K080730HD
Hose - Upper - Eng. To Pipe		≈20206	Belt - Fan To A.C.	178623	②♣9463HD
Hose - Upper - Pipe To Rad.		21571	Tensioner Assy. - Fan, Alt. & Hub	3936206	38513
Hose - Lower - Eng. To Pipe		21571	Tensioner Pulley - Fan, Alt. & Hub	3936206	36091
Hose - Lower - Pipe To Rad.		24240	Hose - Upper - Eng. To Pipe		24240
Caterpillar C10 Diesel			Hose - Upper - Pipe To Rad.		24240
A-Line			Hose - Lower - Eng. To Pipe		21891
Belt - Fan & Alt.	0127110026	♣K080897HD	Hose - Lower - Pipe To Rad.		24240
Belt - A.C.	0126709002	♣K060523HD	Cummins ISM Diesel		
Tensioner Assy. - Fan & Alt.	1900649	38506	L-Line		
Tensioner Assy. - A.C.		38524	Belt - Fan	F6HT 8620 BA	♣K140516HD
Idler Pulley - Fan & Alt.; W/Flat Idler Pulley .	1337023	36091	Belt - Hub & Alt.	E7HT 8620 GA	♣K050360HD
Idler Pulley - Fan & Alt.; W/Multi-Grooved			Belt - Hub & A.C.	DOHA 8620 JA	♣9480HD
Idler Pulley	1731498	36231	Hose - Upper - Eng. To Rad.		24240
Tensioner Pulley - Fan & Alt.		36091	Hose - Upper - Eng. To Pipe		24240
Tensioner Pulley - A.C.		36091	Hose - Lower - Eng. To Pipe		24232
Hose - Upper - Eng. To Pipe		24240	Hose - Lower - Pipe To Rad.		24240
Hose - Upper - Rad. To Pipe		24240	Cummins N14 Diesel		
Hose - Lower - Eng. To Pipe		24240	A-Line; L-Line		
Hose - Lower - Rad. To Pipe		24240	Belt - Hub & W.P.		♣K060415HD
L-Line			Belt - Alt.	E5HT 8A615 EA	♣9435HD
Belt - Fan	0127115002	♣K140603HD	Belt - Hub & A.C.	C6TA 8620 J	♣9420HD
Belt - Fan To Alt.	C5TS 8620 T	♣9440HD	Hose - Upper - Eng. To Pipe		24240
Belt - Fan To A.C.	F6HT 8620 AKA	♣9465HD	Hose - Upper - Pipe To Rad.		21135
Hose - Upper - Eng. To Pipe		22773	Hose - Lower - Eng. To Pipe		24240
Hose - Lower - Eng. To Pipe		24240	Hose - Lower - Pipe To Rad.		24240
Hose - Lower - Pipe To Rad.		24240	Detroit Diesel 6-Cyl. 12.7 L Diesel		
Caterpillar C12 Diesel			L-Line; Silver Star		
A-Line			Belt - Fan	2310001117	③♣9495HD
Belt - Fan & Alt.	0127110026	♣K080897HD	Belt - Hub, Alt. & A.C.	0124587004	♣K080565HD
Belt - A.C.	0126709002	♣K060523HD	Tensioner Assy. - Hub, Alt. & A.C.	23524436	38502
Tensioner Assy. - Fan & Alt.	1900649	38506	Tensioner Pulley - Hub, Alt. & A.C.	0127425000	38075
Tensioner Assy. - A.C.		38524	Hose - Upper - Eng. To Pipe		21891
Idler Pulley - Fan & Alt.; W/Flat Idler Pulley .	1337023	36091	Hose - Upper - Pipe To Rad.		24240
Idler Pulley - Fan & Alt.; W/Multi-Grooved			Hose - Lower - Eng. To Pipe		21891
Idler Pulley	1731498	36231	Hose - Lower - Pipe To Rad.		24240
Tensioner Pulley - Fan & Alt.		36091			
Tensioner Pulley - A.C.		36091			
Hose - Upper - Eng. To Pipe		24240			

♣Standard Belt Available.
②Two Required.

≈Cut to Fit.
③Three Required.

Belts and Coolant Hose for Medium/Heavy-Duty Trucks (2001 & Newer)

 Medium & Heavy-Duty Trucks
(2001 & Newer)

Application	Mfr. Part No.	Our No.	Application	Mfr. Part No.	Our No.
Sterling - Continued			Sterling - Continued		
2003 - Continued			2002 - Continued		
Detroit Diesel 6-Cyl. 14.0 L Diesel			Caterpillar C10 Diesel - Continued		
L-Line			A-Line - Continued		
Belt - Fan	2310001117	③▲9495HD	Hose - Lower - Rad. To Pipe		24240
Belt - Hub, Alt. & A.C.	0124587004	▲K080565HD	L-Line		
Tensioner Assy. - Hub, Alt. & A.C.	23524436		Belt - Fan	0127115001	▲K140682HD
Tensioner Pulley - Hub, Alt. & A.C.	0127425000	38075	Belt - Fan To Alt.	F7HT 8620 YA	▲9440HD
Hose - Upper - Eng. To Pipe		21891	Belt - Fan To A.C.	C5TS 8620 T	▲9440HD
Hose - Upper - Pipe To Rad.		24240	Hose - Upper - Eng. To Pipe		21135
Hose - Lower - Eng. To Pipe		21891	Hose - Upper - Pipe To Rad.		24240
Hose - Lower - Pipe To Rad.		24240	Hose - Lower - Eng. To Pipe		24240
Mercedes-Benz MBE 900 Diesel			Hose - Lower - Pipe To Rad.		
Acterra			24240		
Belt - Hub, Fan, Alt. & A.C.	0126246000	▲K080830HD	Caterpillar C12 Diesel		
Tensioner Assy.	9062002470	38567	A-Line		
Hose - Upper - Eng. To Pipe		22701	Belt - Fan & Alt.	0127110026	▲K080897HD
Hose - Upper - Pipe To Rad.		21135	Belt - A.C.	0126709002	▲K060523HD
Hose - Lower - Eng. To Pipe		21571	Tensioner Assy. - Fan & Alt.	1900649	38506
Hose - Lower - Pipe To Rad.		22903	Tensioner Assy. - A.C.		38524
Mercedes-Benz MBE 4000 Diesel			Idler Pulley - Fan & Alt.; W/Flat Idler Pulley .		
L-Line			1337023		
Belt - Fan	0127116005	▲K080545HD	Idler Pulley - Fan & Alt.; W/Multi-Grooved		
Belt - Hub, Alt. & A.C.	0127116004	▲K080855HD	Idler Pulley		
Tensioner Assy. - Fan	0127427001	38597	1731498		
Tensioner Assy. - Hub, Alt. & A.C.	0127425000	38501	Tensioner Pulley - Fan & Alt.		
Tensioner Pulley - Hub, Alt. & A.C.	0127425000	38075	36091		
Hose - Upper - Eng. To Pipe		22850	Tensioner Pulley - A.C.		
Hose - Lower - Eng. To Pipe		21891	36091		
Hose - Lower - Pipe To Rad.		24240	Hose - Upper - Eng. To Pipe		
2002			24240		
Caterpillar 3126 Diesel			Hose - Upper - Pipe To Rad.		
Acterra			24240		
Belt - W.P.	0366775	▲9341HD	Hose - Lower - Eng. To Pipe		
Belt - Fan, Alt. & A.C.; W/70 1/2" Belt O.C. .	0123415000	▲K080702HD	24240		
Belt - Fan, Alt. & A.C.; W/78 1/2" Belt O.C. .	F2HT 8620 FA	▲K080780HD	Hose - Lower - Pipe To Rad.		
Tensioner Assy. - Fan, Alt. & A.C.	1352151	38511	24240		
Idler Pulley	1445612	36096	Caterpillar C15 Diesel		
Tensioner Pulley - Fan, Alt. & A.C.	1352151	36091	L-Line		
Hose - Upper - Eng. To Pipe		24232	Belt - Fan		
Hose - Upper - Pipe To Rad.		24232	F6HT 8620 KA		
Hose - Lower - Eng. To Pipe		21135	Belt - Fan To Alt.		
Hose - Lower - Pipe To Rad.		24240	2310001116		
Caterpillar C10 Diesel			Belt - Fan To A.C.		
A-Line			F6HT 8620 AAB		
Belt - Fan & Alt.	0127110026	▲K080897HD	Hose - Upper - Eng. To Pipe		
Belt - A.C.	0126709002	▲K060523HD	24240		
Tensioner Assy. - Fan & Alt.	1900649	38506	Hose - Upper - Pipe To Rad.		
Tensioner Assy. - A.C.		38524	21135		
Idler Pulley - Fan & Alt.; W/Flat Idler Pulley .	1337023	36091	Hose - Lower - Eng. To Pipe		
Idler Pulley - Fan & Alt.; W/Multi-Grooved			21891		
Idler Pulley	1731498	36231	Hose - Lower - Pipe To Rad.		
Tensioner Pulley - Fan & Alt.		36091	24240		
Tensioner Pulley - A.C.		36091	Cummins ISB Diesel		
Hose - Upper - Eng. To Pipe		24240	SC7000; SC8000		
Hose - Upper - Rad. To Pipe		24240	Tensioner Assy. - Fan & Alt.		
Hose - Lower - Eng. To Pipe		24240	3978021		
Hose - Lower - Pipe To Rad.		24240	38517		
Caterpillar C10 Diesel			Cummins ISM Diesel		
A-Line			A-Line		
Belt - Fan & Alt.	0127110026	▲K080897HD	Belt - Fan		
Belt - A.C.	0126709002	▲K060523HD	0127115006		
Tensioner Assy. - Fan & Alt.	1900649	38506	Belt - Hub & Alt.		
Tensioner Assy. - A.C.		38524	0127246000		
Idler Pulley - Fan & Alt.; W/Flat Idler Pulley .	1337023	36091	Belt - Hub & A.C.		
Idler Pulley - Fan & Alt.; W/Multi-Grooved			17482		
Idler Pulley	1731498	36231	Hose - Upper - Eng. To Rad.		
Tensioner Pulley - Fan & Alt.		36091	24240		
Tensioner Pulley - A.C.		36091	Hose - Upper - Eng. To Pipe		
Hose - Upper - Eng. To Pipe		24240	24240		
Hose - Upper - Rad. To Pipe		24240	Hose - Lower - Eng. To Pipe		
Hose - Lower - Eng. To Pipe		24240	24232		
Hose - Lower - Pipe To Rad.		24240	Hose - Lower - Pipe To Rad.		
			24240		

▲Standard Belt Available.

≧<Cut to Fit.

Belts and Coolant Hose for Medium/Heavy-Duty Trucks (2001 & Newer)

Medium & Heavy-Duty Trucks
(2001 & Newer)

Application	Mfr. Part No.	Our No.	Application	Mfr. Part No.	Our No.
Sterling - Continued			Sterling - Continued		
2002 - Continued			2001 - Continued		
Cummins ISX Diesel			Caterpillar 3406 Diesel		
Silver Star			A-Line		
Idle Pulley - Alt. & A.C.	4026886	36226	Belt - Fan	F6H6 8620 KA	♣K140580HD
Cummins N14 Diesel			Belt - Alt.	F6HT 8620 ANA	②♣9480HD
A-Line; L-Line; Silver Star			Belt - A.C.	F6HT 8620 AAB	♣9485HD
Belt - Hub & W.P.		♣K060415HD	Hose - Upper		24240
Belt - Alt.	E5HT 8A615 EA	♣9435HD	Hose - Lower - Eng. To Pipe		24248
Belt - Hub & A.C.	C6TA 8620 J	♣9420HD	Hose - Lower - Pipe To Rad.		24240
Hose - Upper - Eng. To Pipe		24240	L-Line		
Hose - Upper - Pipe To Rad.		21135	Belt - Fan	F7HT 8620 KA	♣K140662HD
Hose - Lower - Eng. To Pipe		24240	Belt - Fan To Alt.	2310001028	②♣9451HD
Hose - Lower - Pipe To Rad.		24240	Belt - Fan To A.C.	C6TA 8620 J	♣9420HD
Detroit Diesel 6-Cyl. 11.1 L Diesel			Hose - Upper - Eng. To Pipe		24240
A-Line; L-Line			Hose - Upper - Pipe To Rad.		24240
Belt - Fan	0127115010	♣K140496HD	Hose - Lower - Eng. To Pipe		24248
Belt - Hub To Alt. & A.C.	0124587004	♣K080565HD	Hose - Lower - Pipe To Rad.		24240
Tensioner Assy. - Hub, Alt. & A.C.	23520317	38501	Caterpillar C10 Diesel		
Hose - Upper - Eng. To Pipe		24240	A-Line; L-Line		
Hose - Upper - Pipe To Rad.		21891	Belt - Fan	F6HT 8620 JA	♣K140603HD
Hose - Lower - Eng. To Pipe		21891	Belt - Fan To Alt.	C5TS 8620 T	②♣9440HD
Hose - Lower - Pipe To Rad.		24240	Belt - Fan To A.C.	F6HT 8620 AKA	♣9465HD
Detroit Diesel 6-Cyl. 12.7 L Diesel			Hose - Upper - Eng. To Pipe		21135
A-Line; L-Line; Silver Star			Hose - Upper - Pipe To Rad.		24240
Belt - Fan	0127115010	♣K140496HD	Hose - Lower - Eng. To Pipe		24240
Belt - Hub To Alt. & A.C.	0124587004	♣K080565HD	Hose - Lower - Pipe To Rad.		24240
Tensioner Assy. - Hub, Alt. & A.C.	23520317	38501	Caterpillar C12 Diesel		
Hose - Upper - Eng. To Pipe		24240	A-Line; L-Line		
Hose - Upper - Pipe To Rad.		21891	Belt - Fan	F6HT 8620 JA	♣K140603HD
Hose - Lower - Eng. To Pipe		21891	Belt - Fan To Alt.	C5TS 8620 T	②♣9440HD
Hose - Lower - Pipe To Rad.		24240	Belt - Fan To A.C.	F6HT 8620 AKA	♣9465HD
Mercedes-Benz MBE 900 Diesel			Hose - Upper - Eng. To Pipe		21135
Acterra			Hose - Upper - Pipe To Rad.		24240
Belt - Hub, Fan, Alt. & A.C.	0126246000	♣K080830HD	Hose - Lower - Eng. To Pipe		24240
Tensioner Assy.	9062002470	38567	Hose - Lower - Pipe To Rad.		24240
Hose - Upper - Eng. To Pipe		22701	Caterpillar C15 Diesel		
Hose - Upper - Pipe To Rad.		21135	A-Line; L-Line		
Hose - Lower - Eng. To Pipe		21571	Belt - Fan	F6HT 8620 KA	♣K140580HD
Hose - Lower - Pipe To Rad.		22903	Belt - Fan To Alt.	2310001116	♣9470HD
2001			Belt - Fan To A.C.	F6HT 8620 AAB	♣9485HD
Caterpillar 3126 Diesel			Hose - Upper - Eng. To Pipe		24240
Acterra			Hose - Upper - Pipe To Rad.		21135
Belt - W.P.	0366775	♣9341HD	Hose - Lower - Eng. To Pipe		21891
Belt - Fan, Alt. & A.C.; W/70 1/2" Belt O.C. .	0123415000	♣K080702HD	Hose - Lower - Pipe To Rad.		24240
Belt - Fan, Alt. & A.C.; W/78 1/2" Belt O.C. .	F2HT 8620 FA	♣K080780HD	Caterpillar C16 Diesel		
Tensioner Assy. - Fan, Alt. & A.C.	1352151	38511	L-Line		
Idle Pulley	1445612	36096	Belt - Fan	F6HT 8620 KA	♣K140580HD
Tensioner Pulley - Fan, Alt. & A.C.	1352151	36091	Belt - Fan To Alt.	2310001116	♣9470HD
Hose - Upper - Eng. To Pipe		24232	Belt - Fan To A.C.	F6HT 8620 AAB	♣9485HD
Hose - Upper - Pipe To Rad.		24232	Hose - Upper - Eng. To Pipe		24240
Hose - Lower - Eng. To Pipe		21135	Hose - Upper - Pipe To Rad.		21135
Hose - Lower - Pipe To Rad.		24240	Hose - Lower - Eng. To Pipe		21891
L-Line			Hose - Lower - Pipe To Rad.		24240
Belt - W.P.	0366775	♣9341HD	Cummins ISB Diesel		
Belt - Fan, Alt. & A.C.	F2HT 8620 FA	♣K080780HD	SC7000; SC8000		
Tensioner Assy. - Fan, Alt. & A.C.	1352151	38511	Belt - Alt. & A.C.	3922828	♣K080580HD
Tensioner Pulley - Fan, Alt. & A.C.	1352151	36091	Tensioner Assy. - Fan & Alt.	3978021	38517
Hose - Upper - Eng. To Pipe		24232	Cummins ISC Diesel		
Hose - Upper - Pipe To Rad.		24232	L-Line		
Hose - Lower - Eng. To Pipe		21135	Belt - Fan, Alt. & Hub	3918095	♣K080733HD
Hose - Lower - Pipe To Rad.		24240	Belt - Fan To A.C.	3639613	②♣9463HD
2001			Belt - Fan & Hub	3681822	♣K100810HD
Caterpillar 3126 Diesel			Belt - Hub, Alt. & A.C.	3681812	♣K060685HD
Acterra			Tensioner Assy. - Fan, Alt. & Hub	3936206	38513
Belt - W.P.	0366775	♣9341HD			
Belt - Fan, Alt. & A.C.; W/70 1/2" Belt O.C. .	0123415000	♣K080702HD			
Belt - Fan, Alt. & A.C.; W/78 1/2" Belt O.C. .	F2HT 8620 FA	♣K080780HD			
Tensioner Assy. - Fan, Alt. & A.C.	1352151	38511			
Idle Pulley	1445612	36096			
Tensioner Pulley - Fan, Alt. & A.C.	1352151	36091			
Hose - Upper - Eng. To Pipe		24232			
Hose - Upper - Pipe To Rad.		24232			
Hose - Lower - Eng. To Pipe		21135			
Hose - Lower - Pipe To Rad.		24240			

♣Standard Belt Available.

②Two Required.

Belts and Coolant Hose for Medium/Heavy-Duty Trucks (2001 & Newer)

Application	Mfr. Part No.	Our No.	Application	Mfr. Part No.	Our No.
Sterling - Continued			Sterling - Continued		
2001 - Continued			2001 - Continued		
Cummins ISC Diesel - Continued			Detroit Diesel 6-Cyl. 11.1 L Diesel - Continued		
L-Line - Continued			A-Line - Continued		
Tensioner Pulley - Fan, Alt. & Hub	3936206	36091	Tensioner Assy. - Hub, Alt. & A.C.	23520317	38501
Hose - Upper - Eng. To Pipe		24240	Tensioner Pulley - Hub, Alt. & A.C.		38075
Hose - Upper - Pipe To Rad.		24240	Hose - Upper - Pipe To Rad.		24240
Hose - Lower - Eng. To Pipe		21891	Hose - Lower - Eng. To Pipe		24240
Hose - Lower - Pipe To Rad.		24240	Hose - Lower - Pipe To Rad.		24240
Cummins ISM Diesel			L-Line		
A-Line; L-Line			Belt - Fan		
Belt - Fan	F6HT 8620 BA	♣K140516HD	Belt - Fan	F6HT 8620 LA	♣K140496HD
Belt - Hub & Alt.	E7HT 8620 GA	♣K050360HD	Belt - Hub & Alt.; W/V-Belt Drive	F7HT 8620 VA	2/9485FPB
Belt - Hub & A.C.	D0HA 8620 JA	♣9480HD	Belt - Hub & Alt.; W/V-Ribbed Belt Drive	23521143	♣K060420HD
Hose - Upper - Eng. To Rad.		24240	Belt - Hub & A.C.	C8TA 8620 D	♣9370HD
Hose - Upper - Eng. To Pipe		24240	Tensioner Assy. - Hub & Alt.	23524436	38502
Hose - Lower - Eng. To Pipe		24232	Tensioner Pulley - Hub & Alt.		38075
Hose - Lower - Pipe To Rad.		24240	Hose - Upper - Pipe To Rad.		24240
Cummins ISX Diesel			Hose - Lower - Eng. To Pipe		
L-Line			Hose - Lower - Pipe To Rad.		
Belt - Fan	3681822	♣K100810HD	Detroit Diesel 6-Cyl. 12.7 L Diesel		
Belt - Hub, Alt. & A.C.	3681812	♣K060685HD	A-Line		
Tensioner Assy. - Fan	3681240	38535	Belt - Fan	F6HT 8620 LA	♣K140496HD
Tensioner Assy. - Hub, Alt. & A.C.	3680194	38532	Belt - Hub To Alt. & A.C.	0124587004	♣K080565HD
Idler Pulley - Alt. & A.C.	4026886	36226	Tensioner Assy. - Hub, Alt. & A.C.	23520317	38501
Tensioner Pulley - Fan	3681240	36092	Tensioner Pulley - Hub, Alt. & A.C.		38075
Tensioner Pulley - Hub, Alt. & A.C.	3680194	36095	Hose - Upper - Pipe To Rad.		24240
Hose - Upper - Eng. To Pipe		24240	Hose - Lower - Eng. To Pipe		24240
Hose - Upper - Pipe To Rad.		≠21135	Hose - Lower - Pipe To Rad.		24240
Hose - Lower - Eng. To Pipe		≠21894	L-Line		
Hose - Lower - Pipe To Rad.		≠21135	Belt - Fan	F6HT 8620 LA	♣K140496HD
Cummins N14 Diesel			Belt - Hub & Alt.; W/V-Belt Drive	F7HT 8620 VA	2/9485FPB
A-Line; L-Line			Belt - Hub & Alt.; W/V-Ribbed Belt Drive	23521143	♣K060420HD
Belt - Hub & W.P.		♣K060415HD	Belt - Hub & A.C.	C8TA 8620 D	♣9370HD
Belt - Hub & Fan	F6HT 8620 DA	♣K140429HD	Tensioner Assy. - Hub & Alt.	23524436	38075
Belt - Alt.	E5HT 8A615 EA	♣9435HD	Tensioner Pulley - Hub & Alt.		38075
Belt - Hub & A.C.	C6TA 8620 J	♣9420HD	Hose - Upper - Pipe To Rad.		24240
Hose - Upper - Eng. To Pipe		24240	Hose - Lower - Eng. To Pipe		24240
Hose - Upper - Pipe To Rad.		21135	Hose - Lower - Pipe To Rad.		24240
Hose - Lower - Eng. To Pipe		24240	Silver Star		
Hose - Lower - Pipe To Rad.		24240	Belt - Hub & W.P.		
Silver Star			Belt - Alt.		
Belt - Hub & W.P.			Belt - Hub & A.C.		
Belt - Alt.			Hose - Upper - Eng. To Pipe		
Belt - Hub & A.C.			Hose - Upper - Pipe To Rad.		
Hose - Upper - Eng. To Pipe			Hose - Lower - Eng. To Pipe		
Hose - Upper - Pipe To Rad.			Hose - Lower - Pipe To Rad.		
Hose - Lower - Eng. To Pipe			Cummins Signature 600 Diesel		
Hose - Lower - Pipe To Rad.			L-Line; Silver Star		
Mercedes-Benz MBE 900 Diesel			Belt - Fan		
Acterra			Belt - Hub, Alt. & A.C.		
Belt - Hub, Fan, Alt. & A.C.			Tensioner Assy.		
0126246000			Hose - Upper - Eng. To Pipe		
♣K080830HD			Hose - Upper - Pipe To Rad.		
38567			Hose - Lower - Eng. To Pipe		
22701			Hose - Lower - Pipe To Rad.		
21135			UD (Nissan)		
21571			2013 - 2011		
22903			Nissan GH7 Diesel		
24240			UD1800; UD2000; UD2300DH; UD2300LP		
24240			Belt - Fan & Alt.		
24240			Belt - A.C.		
24240			Hose - Upper		
24240			Hose - Lower; W/Man. Trans.		
24240			Hose - Lower; W/Auto. Trans.		
24240			Hose - Pressure - Tank To Pump		
24240			Hose - Pump To Exhaust		
24240			Belt - Fan & Alt.		
24240			Belt - A.C.		
24240			Hose - Upper		
24240			Hose - Lower; W/Man. Trans.		
24240			Hose - Lower; W/Auto. Trans.		
24240			Hose - Pressure - Tank To Pump		
24240			Hose - Pump To Exhaust		
24240			Belt - Fan		
24240			Belt - Hub To Alt. & A.C.		
24240			Tensioner Assy. - Fan		
24240			Tensioner Assy. - Hub, Alt. & A.C.		
24240			Idler Pulley - Alt. & A.C.		
24240			Tensioner Pulley - Fan		
24240			Tensioner Pulley - Hub, Alt. & A.C.		
24240			Hose - Upper - Eng. To Pipe		
24240			Hose - Upper - Pipe To Rad.		
24240			Hose - Lower - Eng. To Pipe		
24240			Hose - Lower - Pipe To Rad.		
24240			Detroit Diesel 6-Cyl. 11.1 L Diesel		
24240			A-Line		
24240			Belt - Fan		
24240			Belt - Hub To Alt. & A.C.		
24240			Tensioner Assy. - Fan		
24240			Tensioner Assy. - Hub, Alt. & A.C.		
24240			Idler Pulley - Alt. & A.C.		
24240			Tensioner Pulley - Fan		
24240			Tensioner Pulley - Hub, Alt. & A.C.		
24240			Hose - Upper - Eng. To Pipe		
24240			Hose - Upper - Pipe To Rad.		
24240			Hose - Lower - Eng. To Pipe		
24240			Hose - Lower - Pipe To Rad.		
24240			♣Standard Belt Available.		
24240			≠Cut to Fit.		

Medium & Heavy-Duty Trucks
(2001 & Newer)

Belts and Coolant Hose for Medium/Heavy-Duty Trucks (2001 & Newer)

Medium & Heavy-Duty Trucks
(2001 & Newer)

Application	Mfr. Part No.	Our No.	Application	Mfr. Part No.	Our No.
UD (Nissan) - Continued			UD (Nissan) - Continued		
2013 - 2011 - Continued			2008 - Continued		
Nissan GH7 Diesel - Continued			Nissan MD-230 Diesel - Continued		
UD2600; UD2600LP; UD3300			UD1800HD; UD2000; UD2300DH; UD2300LP; UD2600; UD2600LP; UD3300 - Continued		
Belt - Fan & Alt.	21140NK00C	K070529HD	Hose - Lower		24010
Belt - A.C.	21140NK00B	▲K040445HD	2007		
Hose - Upper		24015	Nissan MD-175 Diesel		
Hose - Lower; W/Man. Trans.		24021	UD1300; UD1400		
Hose - Lower; W/5-Speed Auto. Trans.		24021	Belt - Alt. & W.P.	21140Z5075	A45
Hose - Lower; W/6-Speed Auto. Trans.		24019	Belt - A.C.	1192036D00	A37
Hose - Pump To Exhaust	2042030Z6D	DEF7011	Hose - Upper		23754
Hose - Pressure - Tank To Pump; W/5 Gal. DEF Tank	2042030Z6E	DEF7009	Hose - Lower		24011
Hose - Pressure - Tank To Pump; W/13 Gal. DEF Tank	2042030Z7A	DEF7010	UD1800CS		
2010			Belt - Alt. & W.P.	21140Z5075	A45
Nissan MD-175 Diesel			Belt - A.C.	1192036D00	A37
UD1400			Hose - Lower; W/Auto. Trans.		24013
Belt - Alt. & W.P.	21131Z500D	②A46	Nissan MD-230 Diesel		
Belt - A.C.	1192036D00	A37	UD1800HD; UD2000; UD2300DH; UD2300LP		
UD1800CS			Belt - Alt. & W.P.	21140Z5074	K080553HD
Belt - Alt. & W.P.	21131Z500D	②A46	Belt - A.C.	1192036D01	A38
Belt - A.C.	1192036D00	A37	Tensioner Assy. - Alt. & W.P.	21100Z501C	38659
Hose - Lower; W/Auto. Trans.		24013	Hose - Upper		23753
Nissan MD-230 Diesel			Hose - Lower; W/Auto. Trans.		23752
UD2000; UD2300DH; UD2300LP; UD2600; UD3300			UD2600; UD2600LP; UD3300		
Belt - Alt. & W.P.	21140Z502A	K080539HD	Belt - Alt. & W.P.	21140Z5074	K080553HD
Belt - A.C.	1192036D01	A38	Belt - A.C.	1192036D01	A38
Idler Pulley - Alt. & A.C.	21100Z501A	36355	Tensioner Assy. - Alt. & W.P.	21100Z501C	38659
Hose - Upper		24017	Hose - Upper		23753
Hose - Lower		24010	Hose - Lower; W/Man. Trans.		23751
2009			Hose - Lower; W/Auto. Trans.		23752
Nissan MD-175 Diesel			2006		
UD1400			Nissan MD-175 Diesel		
Belt - Alt. & W.P.	21131Z500D	②A46	UD1300; UD1400		
Belt - A.C.	1192036D00	A37	Belt - Alt. & W.P.	21140Z5075	A45
UD1800CS			Belt - A.C.	1192036D00	A37
Belt - Alt. & W.P.	21131Z500D	②A46	Hose - Upper		23754
Belt - A.C.	1192036D00	A37	Hose - Lower		24011
Hose - Lower; W/Auto. Trans.		24013	UD1800CS		
Nissan MD-230 Diesel			Belt - Alt. & W.P.	21140Z5075	A45
UD1800HD; UD2000; UD2300DH; UD2300LP; UD2600; UD3300			Belt - A.C.	1192036D00	A37
Belt - Alt. & W.P.	21140Z502A	K080539HD	Tensioner Assy. - Alt. & W.P.	21100Z501C	38659
Belt - A.C.	1192036D01	A38	Hose - Lower; W/Auto. Trans.		24013
Idler Pulley - Alt. & A.C.	21100Z501A	36355	Nissan MD-230 Diesel		
Hose - Upper		24017	UD1800HD; UD2000; UD2300DH; UD2300LP		
Hose - Lower		24010	Belt - Alt. & W.P.	21140Z5074	K080553HD
2008			Belt - A.C.	1192036D01	A38
Nissan MD-175 Diesel			Tensioner Assy. - Alt. & W.P.	21100Z501C	38659
UD1400			Hose - Upper		23753
Belt - Alt. & W.P.	21131Z500D	②A46	Hose - Lower; W/Auto. Trans.		23752
Belt - A.C.	1192036D00	A37	UD2600; UD3300		
UD1800CS			Belt - Alt. & W.P.	21140Z5074	K080553HD
Belt - Alt. & W.P.	21131Z500D	②A46	Belt - A.C.	1192036D01	A38
Belt - A.C.	1192036D00	A37	Tensioner Assy. - Alt. & W.P.	21100Z501C	38659
Hose - Lower; W/Auto. Trans.		24013	Hose - Upper		23753
Nissan MD-230 Diesel			Hose - Lower; W/Man. Trans.		23751
UD1800HD; UD2000; UD2300DH; UD2300LP; UD2600; UD2600LP; UD3300			Hose - Lower; W/Auto. Trans.		23752
Belt - Alt. & W.P.	21140Z502A	K080539HD	2005		
Belt - A.C.	1192036D01	A38	Nissan MD-175 Diesel		
Idler Pulley - Alt. & A.C.	21100Z501A	36355	UD1300; UD1400		
Hose - Upper		24017	Belt - Alt. & W.P.	21140Z5075	A45
Hose - Lower		24010	Belt - A.C.	1192036D00	A37
2008			Hose - Upper		23754
Nissan MD-175 Diesel			Hose - Lower		24011
UD1300; UD1400					
Belt - Alt. & W.P.	21131Z500D	②A46			
Belt - A.C.	1192036D00	A37			
UD1800CS					
Belt - Alt. & W.P.	21131Z500D	②A46			
Belt - A.C.	1192036D00	A37			
Hose - Lower; W/Auto. Trans.		24013			
Nissan MD-230 Diesel					
UD1800HD; UD2000; UD2300DH; UD2300LP; UD2600; UD2600LP; UD3300					
Belt - Alt. & W.P.	21140Z502A	K080539HD			
Belt - A.C.	1192036D01	A38			
Idler Pulley - Alt. & A.C.	21100Z501A	36355			
Hose - Upper		24017			
Hose - Lower		24010			

▲Standard Belt Available.

②Two Required.

Belts and Coolant Hose for Medium/Heavy-Duty Trucks (2001 & Newer)

Application	Mfr. Part No.	Our No.	Application	Mfr. Part No.	Our No.
UD (Nissan) - Continued			Volvo - Continued		
2005 - Continued			2014 - Continued		
Nissan MD-175 Diesel - Continued			Volvo D11 Diesel - Continued		
UD1800CS			VN Series - Continued		
Belt - Alt. & W.P.	21140Z5075	A45	Belt - Fan & W.P.	20883508	K100604HD
Belt - A.C.	1192036D00	A37	Belt - Alt. & A.C.; W/62 7/8" Belt O.C.	21460410	▲K080623HD
Hose - Lower; W/Auto. Trans.		24013	Belt - Alt. & A.C.; W/63 5/8" Belt O.C.	20582552	▲K080630HD
Nissan MD-230 Diesel			Tensioner Assy. - Fan	20935521	38607
UD1800HD; UD2000; UD2300DH; UD2300LP			Tensioner Assy. - Alt. & A.C.; W/62 7/8" Belt O.C.	21454379	38671
Belt - Alt. & W.P.	21140Z5074	K080553HD	Tensioner Assy. - Alt. & A.C.; W/63 5/8" Belt O.C.	21404578	38671
Belt - A.C.	1192036D01	A38	Hose - Upper - Rad. To Pipe		24007
Tensioner Assy. - Alt. & W.P.	21100Z501C	38659	Hose - Upper - Pipe To Eng.		22714
Hose - Upper		23753	Hose - Lower		24200
Hose - Lower; W/Auto. Trans.		23752	Hose - Supply & Return Assy.	21483642	DEF7015
UD2600; UD3300			Hose - Pressure - Pump To Injector	21483633	DEF7016
Belt - Alt. & W.P.	21140Z5074	K080553HD	Hose - Turbo To Pipe (Hot Side)	20550690	26201
Belt - A.C.	1192036D01	A38	Hose - Pipe To Intercooler (Hot Side)	20550690	26201
Tensioner Assy. - Alt. & W.P.	21100Z501C	38659	Volvo D13 Diesel		
Hose - Upper		23753	VN Series		
Hose - Lower; W/Man. Trans.		23751	Belt - Serpentine Enhancement Kit - Alt. & A.C.; For Improved Belt Drive Design ...	21568414	ACK080630HD
Hose - Lower; W/Auto. Trans.		23752	Belt - Fan	20582557	K120640HD
2004 - 2001			Belt - Alt.	21556639	▲K080630HD
Nissan FD46TA Diesel			Tensioner Assy. - Fan	21461221	38633
UD1200; UD1400; UD1800CS			Tensioner Assy. - Alt.	21454379	38671
Belt - Fan & Alt.		▲K090500HD	Hose - Upper - Rad. To Pipe		23564
Belt - Fan & A.C.		▲K040388HD	Hose - Upper - Pipe To Eng.		24202
Nissan FE6TA Diesel			Hose - Lower		24200
UD1800HD; UD2000; UD2300DH; UD2300LP; UD2600; UD3300			Hose - Supply & Return Assy.	21483642	DEF7015
Belt - Fan & Alt.		▲K090500HD	Hose - Pressure - Pump To Injector	21483633	DEF7016
Belt - Fan & A.C.		▲K040388HD	Hose - Turbo To Pipe (Hot Side)	20550690	26201
Volvo			Hose - Pipe To Intercooler (Hot Side)	20550690	26201
2015			Hose - Pipe To Engine (Cold Side)	20550690	26201
Volvo D13 Diesel			Volvo D16 Diesel		
VN Series			VN Series		
Belt - Serpentine Enhancement Kit - Alt. & A.C.; For Improved Belt Drive Design ...	21568414	ACK080630HD	Belt - Serpentine Enhancement Kit - Alt. & A.C.; For Improved Belt Drive Design ...		ACK080550HD
Belt - Fan	20582557	K120640HD	Belt - Fan & W.P.	20882779	K100578HD
Belt - Alt.	21556639	▲K080630HD	Belt - Alt. & A.C.	20464710	▲K080550HD
Tensioner Assy. - Fan	21461221	38633	Tensioner Assy. - Fan & W.P.	21631484	38581
Tensioner Assy. - Alt.	21454379	38671	Tensioner Assy. - Alt. & A.C.	21422767	38585
2014			Hose - Upper - Rad. To Pipe		24009
Cummins ISX15 Diesel			Hose - Lower		24006
VN Series			Hose - Supply & Return Assy.	21483642	DEF7015
Belt - Fan	21189554	▲K120842HD	Hose - Pressure - Pump To Injector	21483633	DEF7016
Belt - Alt. & A.C.	20457273	▲K060637HD	2013		
Tensioner Assy. - Fan	4299051	38587	Cummins ISX15 Diesel		
Tensioner Assy. - Alt. & A.C.	2891940	38610	VN Series		
Idler Pulley - Alt. & A.C.	3682229	36223	Belt - Fan	21189554	▲K120842HD
Hose - Upper - Rad. To Pipe		24003	Belt - A.C.	20457273	▲K060637HD
Hose - Upper - Pipe To Eng.		24004	Tensioner Assy. - Fan	2871293	38587
Hose - Lower - Rad. To Pipe		24002	Tensioner Assy. - A.C.	3104149	38610
Hose - Lower - Pipe To Eng.		≧24244	Idler Pulley - A.C.	3682229	36223
Hose - Turbo To Pipe (Hot Side)	20550690	26201	Hose - Upper - Rad. To Pipe		24003
Hose - Pipe To Intercooler (Hot Side)	20550690	26201	Hose - Upper - Pipe To Eng.		24004
Hose - Intercooler To Pipe (Cold Side)	20550690	26201	Hose - Lower - Rad. To Pipe		24002
Hose - Pipe To Engine (Cold Side)	20550690	26201	Hose - Lower - Pipe To Eng.		≧24244
Volvo D11 Diesel			Hose - Turbo To Pipe (Hot Side)	20550690	26201
VN Series			Hose - Pipe To Intercooler (Hot Side)	20550690	26201
Belt - Serpentine Enhancement Kit - Alt. & A.C.; W/62 7/8" Belt O.C.	21568410	ACK080623HD	Hose - Intercooler To Pipe (Cold Side)	20550690	26201
Belt - Serpentine Enhancement Kit - Alt. & A.C.; For Improved Belt Drive Design; W/63 5/8" Belt O.C.	21568414	ACK080630HD	Hose - Pipe To Engine (Cold Side)	20550690	26201

Medium & Heavy-Duty Trucks (2001 & Newer)

▲Standard Belt Available.

≧Cut to Fit.

Belts and Coolant Hose for Medium/Heavy-Duty Trucks (2001 & Newer)

Medium & Heavy-Duty Trucks
(2001 & Newer)

Application	Mfr. Part No.	Our No.	Application	Mfr. Part No.	Our No.
Volvo - Continued			Volvo - Continued		
2013 - Continued			2013 - Continued		
Volvo D11 Diesel			Volvo D16 Diesel		
VHD			VN Series		
Belt - Serpentine Enhancement Kit - Alt. & A.C.; W/62 7/8" Belt O.C.	21568410	ACK080623HD	Belt - Serpentine Enhancement Kit - Alt. & A.C.; For Improved Belt Drive Design		ACK080550HD
Belt - Serpentine Enhancement Kit - Alt. & A.C.; For Improved Belt Drive Design; W/63 5/8" Belt O.C.	21568414	ACK080630HD	Belt - Fan & W.P.	20882779	K100578HD
Belt - Alt. & A.C.; W/62 7/8" Belt O.C.	21460410	▲K080623HD	Belt - Alt. & A.C.	20464710	▲K080550HD
Belt - Alt. & A.C.; W/63 5/8" Belt O.C.	20582552	▲K080630HD	Tensioner Assy. - Fan & W.P.	21631484	38581
Tensioner Assy. - Fan	21422765	38607	Tensioner Assy. - Alt. & A.C.	21422767	38585
Tensioner Assy. - Alt. & A.C.; W/62 7/8" Belt O.C.	21454379	38671	Hose - Upper - Rad. To Pipe		24009
Tensioner Assy. - Alt. & A.C.; W/63 5/8" Belt O.C.	21404578	38671	Hose - Lower		24006
Idler Pulley - Fan (Upper)	20953521	36286	Hose - Supply & Return Assy.	21483642	DEF7015
Hose - Upper - Pipe To Eng.		22714	Hose - Pressure - Pump To Injector	21483633	DEF7016
Hose - Trans. Oil Cooler Inlet; W/Allison Trans.		28358			
Hose - Trans. Oil Cooler Outlet; W/Allison Trans.		28357			
Hose - Supply & Return Assy.	21483642	DEF7015			
VN Series			2012		
Belt - Serpentine Enhancement Kit - Alt. & A.C.; W/62 7/8" Belt O.C.	21568410	ACK080623HD	Cummins ISX15 Diesel		
Belt - Serpentine Enhancement Kit - Alt. & A.C.; For Improved Belt Drive Design; W/63 5/8" Belt O.C.	21568414	ACK080630HD	VN Series		
Belt - Fan & W.P.	20883508	K100604HD	Belt - Fan	21189554	▲K120842HD
Belt - Alt. & A.C.; W/62 7/8" Belt O.C.	21460410	▲K080623HD	Belt - A.C.	20457273	▲K060637HD
Belt - Alt. & A.C.; W/63 5/8" Belt O.C.	20582552	▲K080630HD	Tensioner Assy. - Fan	2871293	38587
Tensioner Assy. - Fan & W.P.	20935521	38607	Tensioner Assy. - A.C.	3104149	38610
Tensioner Assy. - Alt. & A.C.; W/62 7/8" Belt O.C.	21454379	38671	Idler Pulley - A.C.	3682229	36223
Tensioner Assy. - Alt. & A.C.; W/63 5/8" Belt O.C.	21404578	38671	Hose - Upper - Rad. To Pipe		24003
Idler Pulley - Upper	20953521	36286	Hose - Upper - Pipe To Eng.		24004
Hose - Upper - Rad. To Pipe		24007	Hose - Lower - Rad. To Pipe		24002
Hose - Upper - Pipe To Eng.		22714	Hose - Lower - Pipe To Eng.		24244
Hose - Lower		24200			
Hose - Supply & Return Assy.	21483642	DEF7015			
Hose - Pressure - Pump To Injector	21483633	DEF7016			
Volvo D13 Diesel			Volvo D11 Diesel		
VHD			VHD		
Belt - Serpentine Enhancement Kit - Alt. & A.C.; For Improved Belt Drive Design ...	21568413	ACK080630HD	Belt - Serpentine Enhancement Kit - Alt. & A.C.; W/62 7/8" Belt O.C.	21568410	ACK080623HD
Belt - Fan	21379938	K120786HD	Belt - Serpentine Enhancement Kit - Alt. & A.C.; For Improved Belt Drive Design; W/63 5/8" Belt O.C.	21568414	ACK080630HD
Belt - Alt. & A.C.	21556639	▲K080630HD	Belt - Alt. & A.C.; W/62 7/8" Belt O.C.	21460410	▲K080623HD
Tensioner Assy. - Fan	21714847	38633	Belt - Alt. & A.C.; W/63 5/8" Belt O.C.	20582552	▲K080630HD
Tensioner Assy. - Alt. & A.C.	21454379	38671	Tensioner Assy. - Fan	21422765	38607
Hose - Upper - Rad. To Pipe		23563	Tensioner Assy. - Alt. & A.C.; W/62 7/8" Belt O.C.	21454379	38671
Hose - Upper - Pipe To Eng.		24202	Tensioner Assy. - Alt. & A.C.; W/63 5/8" Belt O.C.	21404578	38671
Hose - Trans. Oil Cooler Outlet; W/Allison Trans.		28357	Idler Pulley - Fan (Upper)	20953521	36286
Hose - Trans. Oil Cooler Inlet; W/Allison Trans.		28358	Hose - Upper - Pipe To Eng.		22714
Hose - Supply & Return Assy.	21483642	DEF7015	Hose - Trans. Oil Cooler Inlet; W/Allison Trans.		28358
Hose - Turbo To Pipe (Hot Side)	20550690	26201	Hose - Trans. Oil Cooler Outlet; W/Allison Trans.		28357
Hose - Pipe To Intercooler (Hot Side)	20550690	26201	Hose - Supply & Return Assy.	21483642	DEF7015
VN Series			VN Series		
Belt - Serpentine Enhancement Kit - Alt. & A.C.; For Improved Belt Drive Design ...	21568414	ACK080630HD	Belt - Serpentine Enhancement Kit - Alt. & A.C.; W/62 7/8" Belt O.C.	21568410	ACK080623HD
Belt - Fan	20582557	K120640HD	Belt - Serpentine Enhancement Kit - Alt. & A.C.; For Improved Belt Drive Design; W/63 5/8" Belt O.C.	21568414	ACK080630HD
Belt - Alt.	21556639	▲K080630HD	Belt - Fan & W.P.	20883508	K100604HD
Tensioner Assy. - Fan	21461221	38633	Belt - Alt. & A.C.; W/62 7/8" Belt O.C.	21460410	▲K080623HD
Tensioner Assy. - Alt.	21454379	38671	Belt - Alt. & A.C.; W/63 5/8" Belt O.C.	20582552	▲K080630HD
Hose - Upper - Rad. To Pipe		23564	Tensioner Assy. - Alt. & A.C.; W/62 7/8" Belt O.C.	21454379	38671
Hose - Upper - Pipe To Eng.		24202	Tensioner Assy. - Alt. & A.C.; W/63 5/8" Belt O.C.	21404578	38671
Hose - Lower		24200	Tensioner Assy. - Fan & W.P.	20935521	38607
Hose - Supply & Return Assy.	21483642	DEF7015	Idler Pulley - Upper	20953521	36286
Hose - Pressure - Pump To Injector	21483633	DEF7016	Hose - Upper - Rad. To Pipe		24007
			Hose - Upper - Pipe To Eng.		22714
			Hose - Lower		24200
			Hose - Supply & Return Assy.	21483642	DEF7015
			Hose - Pressure - Pump To Injector	21483633	DEF7016

▲Standard Belt Available.

Belts and Coolant Hose for Medium/Heavy-Duty Trucks (2001 & Newer)

Application	Mfr. Part No.	Our No.	Application	Mfr. Part No.	Our No.
Volvo - Continued			Volvo - Continued		
2012 - Continued			2011 - Continued		
Volvo D13 Diesel			Volvo D11 Diesel - Continued		
VHD			VN Series - Continued		
Belt - Serpentine Enhancement Kit - Alt. & A.C.; For Improved Belt Drive Design ...	21568414	ACK080630HD	Belt - Serpentine Enhancement Kit - Alt. & A.C.; W/63 5/8" Belt O.C.	21568414	ACK080630HD
Belt - Fan	21379938	K120786HD	Belt - Fan & W.P.	20883508	K100604HD
Belt - Alt. & A.C.	21556639	▲K080630HD	Belt - Alt. & A.C.; W/62 7/8" Belt O.C.	21460410	▲K080623HD
Tensioner Assy.	21461221	38633	Belt - Alt. & A.C.; W/63 5/8" Belt O.C.	20582552	▲K080630HD
Tensioner Assy. - Alt. & A.C.	21454379	38671	Tensioner Assy. - Fan & W.P.	21422765	38607
Hose - Upper - Rad. To Pipe		23564	Tensioner Assy. - Alt. & A.C.; W/62 7/8" Belt O.C.	21454379	38671
Hose - Upper - Pipe To Rad.		24202	Tensioner Assy. - Alt. & A.C.; W/63 5/8" Belt O.C.	21404578	38671
Hose - Lower		24200	Hose - Upper - Rad. To Pipe		24007
Hose - Pressure - Pump To Injector	21483633	DEF7016	Hose - Upper - Pipe To Eng.		22714
VN Series			Hose - Supply & Return Assy.	21483642	DEF7015
Belt - Serpentine Enhancement Kit - Alt. & A.C.; For Improved Belt Drive Design ...	21568414	ACK080630HD	Hose - Pressure - Pump To Injector	21483633	DEF7016
Belt - Fan & W.P.	20582557	K120640HD	Volvo D13 Diesel		
Belt - Alt. & A.C.	21556639	▲K080630HD	VHD		
Tensioner Assy. - Fan & W.P.	21461221	38633	Belt - Serpentine Enhancement Kit - Alt. & A.C.; For Improved Belt Drive Design ...	21568414	ACK080630HD
Tensioner Assy. - Alt. & A.C.	21454379	38671	Belt - Fan & W.P.	20582559	K120786HD
Hose - Upper - Rad. To Pipe		23564	Belt - Alt. & A.C.	20582552	▲K080630HD
Hose - Upper - Pipe To Rad.		24202	Tensioner Assy. - Fan & W.P.	21461221	38633
Hose - Lower		24200	Tensioner Assy. - Alt. & A.C.	21454379	38671
Hose - Supply & Return Assy.	21483642	DEF7015	Hose - Upper - Rad. To Pipe		23563
Hose - Pressure - Pump To Injector	21483633	DEF7016	Hose - Upper - Eng. To Pipe		24202
Volvo D16 Diesel			VN Series		
VN Series			Belt - Serpentine Enhancement Kit - Alt. & A.C.; For Improved Belt Drive Design ...	21568414	ACK080630HD
Belt - Serpentine Enhancement Kit - Alt. & A.C.; For Improved Belt Drive Design ...		ACK080550HD	Belt - Fan & W.P.	20582557	K120640HD
Belt - Fan & W.P.	20882779	K100578HD	Belt - Alt. & A.C.	21556639	▲K080630HD
Belt - Alt. & A.C.	20464710	▲K080550HD	Tensioner Assy. - Fan & W.P.	21461221	38633
Tensioner Assy. - Fan & W.P.	21155561	38581	Tensioner Assy. - Alt. & A.C.	21454379	38671
Tensioner Assy. - Alt. & A.C.	21422767	38585	Hose - Upper - Rad. To Pipe		23563
Idler Pulley - Fan (Lower)	20747516	36285	Hose - Upper - Eng. To Pipe		24202
Hose - Upper - Rad. To Pipe		24009	Hose - Pressure - Pump To Injector	21483633	DEF7016
Hose - Lower		24006	Hose - Supply & Return Assy.	21483642	DEF7015
Hose - Supply & Return Assy.	21483642	DEF7015	Volvo D16 Diesel		
Hose - Pressure - Pump To Injector	21483633	DEF7016	VN Series		
2011			Belt - Serpentine Enhancement Kit - Alt. & A.C.; For Improved Belt Drive Design ...		ACK080550HD
Cummins ISX15 Diesel			Belt - Fan	20882779	K100578HD
VN Series			Belt - Alt. & A.C.	20464710	▲K080550HD
Belt - Fan	21189554	▲K120842HD	Tensioner Assy. - Fan	21631484	38581
Belt - A.C.	20457273	▲K060637HD	Tensioner Assy. - Alt. & A.C.	21422767	38585
Tensioner Assy. - Fan	2871293	38587	Idler Pulley - Fan (Lower)	20747516	36285
Tensioner Assy. - A.C.	3104149	38610	Hose - Upper - Rad. To Pipe		24009
Idler Pulley - A.C.	3682229	36223	Hose - Lower		24006
Hose - Lower - Rad. To Pipe		24002	Hose - Pressure - Pump To Injector	21483633	DEF7016
Hose - Lower - Pipe To Eng.		≅24244	Hose - Supply & Return Assy.	21483642	DEF7015
Volvo D11 Diesel			2010		
VHD			Cummins ISX15 Diesel		
Belt - Serpentine Enhancement Kit - Alt. & A.C.; W/62 7/8" Belt O.C.	21568410	ACK080623HD	VN Series		
Belt - Serpentine Enhancement Kit - Alt. & A.C.; W/63 5/8" Belt O.C.	21568414	ACK080630HD	Belt - Fan	21189554	▲K120842HD
Belt - Alt. & A.C.; W/62 7/8" Belt O.C.	21460410	▲K080623HD	Belt - A.C.	20457273	▲K060637HD
Belt - Alt. & A.C.; W/63 5/8" Belt O.C.	20582552	▲K080630HD	Tensioner Assy. - Fan	2871293	38587
Tensioner Assy. - Fan	20935521	38607	Tensioner Assy. - A.C.	3104149	38610
Tensioner Assy. - Alt. & A.C.; W/62 7/8" Belt O.C.	21454379	38671	Idler Pulley - A.C.	3682229	36223
Tensioner Assy. - Alt. & A.C.; W/63 5/8" Belt O.C.	21404578	38671	Hose - Upper - Pipe To Eng.		24004
Hose - Supply & Return Assy.	21483642	DEF7015	Hose - Lower - Rad. To Pipe		24002
VN Series			Hose - Lower - Pipe To Eng.		≅24244
Belt - Serpentine Enhancement Kit - Alt. & A.C.; W/62 7/8" Belt O.C.	21568410	ACK080623HD	VT Series		
2012 - Continued			Belt - Fan & Alt.	21189554	▲K120842HD
Volvo D13 Diesel			Belt - A.C.	20457273	▲K060637HD
VN Series			Tensioner Assy. - Fan	2871293	38587
Belt - Serpentine Enhancement Kit - Alt. & A.C.; For Improved Belt Drive Design ...	21568414	ACK080630HD	Tensioner Assy. - A.C.	3104149	38610
Belt - Fan & W.P.	20582557	K120640HD	Idler Pulley - A.C.	3682229	36223
Belt - Alt. & A.C.	21556639	▲K080630HD	Hose - Upper - Pipe To Eng.		24004
Tensioner Assy. - Fan & W.P.	21461221	38633	Hose - Lower - Rad. To Pipe		24002
Tensioner Assy. - Alt. & A.C.	21454379	38671	Hose - Lower - Pipe To Eng.		≅24244
Hose - Upper - Rad. To Pipe		23564	Volvo D11 Diesel		
Hose - Upper - Pipe To Rad.		24202	VN Series		
Hose - Lower		24200	Belt - Serpentine Enhancement Kit - Alt. & A.C.; W/62 7/8" Belt O.C.	21568410	ACK080623HD
Hose - Supply & Return Assy.	21483642	DEF7015	2011		
Hose - Pressure - Pump To Injector	21483633	DEF7016	Cummins ISX15 Diesel		

Medium & Heavy-Duty Trucks (2001 & Newer)

▲Standard Belt Available.

≅Cut to Fit.

Belts and Coolant Hose for Medium/Heavy-Duty Trucks (2001 & Newer)

 Medium & Heavy-Duty Trucks
(2001 & Newer)

Application	Mfr. Part No.	Our No.	Application	Mfr. Part No.	Our No.
Volvo - Continued			Volvo - Continued		
2010 - Continued			2010 - Continued		
Cummins ISX15 Diesel - Continued			Volvo D16 Diesel - Continued		
VT Series - Continued			VN Series - Continued		
Tensioner Assy. - A.C.	3104149	38610	Hose - Lower		24006
Idler Pulley - A.C.	3682229	36223	2009		
Hose - Lower - Pipe To Rad.		24006	Cummins ISX Diesel		
Volvo D11 Diesel			VN Series		
VHD			Belt - Fan, A.C., Alt. & W.P. 20481362 ♣K120842HD		
Belt - Serpentine Enhancement Kit - Alt. & A.C.; W/62 7/8" Belt O.C.	21568410	ACK080623HD	Tensioner Assy. - Fan, A.C., Alt. & W.P. (Left)	3104149	38610
Belt - Serpentine Enhancement Kit - Alt. & A.C.; W/63 5/8" Belt O.C.	21568414	ACK080630HD	Tensioner Assy. - Fan, A.C., Alt. & W.P. (Right)	3682946	38587
Belt - Alt. & A.C.; W/62 7/8" Belt O.C.	21460410	♣K080623HD	Tensioner Pulley - Fan, A.C., Alt. & W.P. (Right)	3682946	36165
Belt - Alt. & A.C.; W/63 5/8" Belt O.C.	20582552	♣K080630HD	Idler Pulley - Fan	20953521	36286
Tensioner Assy. - Fan	20935521	38607	Hose - Lower - Rad. To Pipe		24002
Tensioner Assy. - Alt. & A.C.; W/62 7/8" Belt O.C.	21454379	38671	Hose - Lower - Pipe To Eng.		≈<24244
Tensioner Assy. - Alt. & A.C.; W/63 5/8" Belt O.C.	21404578	38671	VT Series		
Hose - Upper - Rad. To Pipe		24007	Belt - Fan & Alt.	20481362	♣K120842HD
Hose - Upper - Pipe To Eng.		22714	Belt - Hub & A.C.	20457273	♣K060637HD
Hose - Supply & Return Assy.	21483642	DEF7015	Tensioner Assy. - Hub & A.C.	3682683	38610
VN Series			Tensioner Assy. - Fan & Alt.	3682946	38587
Belt - Serpentine Enhancement Kit - Alt. & A.C.; W/62 7/8" Belt O.C.	21568410	ACK080623HD	Tensioner Pulley - Fan & Alt.	3682946	36165
Belt - Serpentine Enhancement Kit - Alt. & A.C.; For Improved Belt Drive Design; W/63 5/8" Belt O.C.	21568414	ACK080630HD	Idler Pulley - Fan	20953521	36286
Belt - Fan & W.P.	20883508	K100604HD	Idler Pulley - A.C.	3682229	36223
Belt - Alt. & A.C.; W/62 7/8" Belt O.C.	21460410	♣K080623HD	Hose - Upper - Pipe To Eng.		24004
Belt - Alt. & A.C.; W/63 5/8" Belt O.C.	20582552	♣K080630HD	Hose - Lower - Pipe To Eng.		≈<24244
Tensioner Assy. - Fan & W.P.	21422765	38607	Volvo D11 Diesel		
Tensioner Assy. - Alt. & A.C.; W/62 7/8" Belt O.C.	21454379	38671	VN Series		
Tensioner Assy. - Alt. & A.C.; W/63 5/8" Belt O.C.	21404578	38671	Belt - Serpentine Enhancement Kit - Alt. & A.C.; W/62 7/8" Belt O.C.	21568410	ACK080623HD
Hose - Upper - Rad. To Pipe		24007	Belt - Serpentine Enhancement Kit - Alt. & A.C.; For Improved Belt Drive Design; W/63 3/8" Belt O.C.	21568414	ACK080630HD
Hose - Upper - Pipe To Eng.		22714	Belt - Fan & W.P.	20883508	K100604HD
Volvo D13 Diesel			Belt - Alt. & A.C.; W/62 7/8" Belt O.C.	21460410	♣K080623HD
VHD			Belt - Alt. & A.C.; W/63 5/8" Belt O.C.	20582552	♣K080630HD
Belt - Serpentine Enhancement Kit - Alt. & A.C.; For Improved Belt Drive Design ...	21568414	ACK080630HD	Tensioner Assy. - Fan & W.P.	21422765	38607
Belt - Fan & W.P.	20582559	K120786HD	Tensioner Assy. - Alt. & A.C.; W/62 7/8" Belt O.C.	21454379	38671
Belt - Alt. & A.C.	20582552	♣K080630HD	Tensioner Assy. - Alt. & A.C.; W/63 5/8" Belt O.C.	21404578	38671
Tensioner Assy. - Fan & W.P.	21461221	38633	Hose - Upper - Rad. To Pipe		24007
Tensioner Assy. - Alt. & A.C.	21454379	38671	Hose - Upper - Pipe To Eng.		22714
Hose - Upper - Rad. To Pipe		23563	Volvo D13 Diesel		
Hose - Upper - Eng. To Pipe		24202	VHD		
VN Series			Belt - Serpentine Enhancement Kit - Alt. & A.C.; For Improved Belt Drive Design ...		
Belt - Serpentine Enhancement Kit - Alt. & A.C.; For Improved Belt Drive Design ...	21568414	ACK080630HD	Belt - Fan & W.P.	20582559	K120786HD
Belt - Fan & W.P.	20582557	K120640HD	Belt - Alt. & A.C.	20582552	♣K080630HD
Belt - Alt. & A.C.	20582552	♣K080630HD	Tensioner Assy. - Alt. & A.C.	21454379	38671
Tensioner Assy. - Fan & W.P.	21461221	38633	Tensioner Assy. - Fan	20860873	38633
Tensioner Assy. - Alt. & A.C.	21454379	38671	Hose - Upper - Rad. To Pipe		23563
Hose - Upper - Rad. To Pipe		23563	Hose - Upper - Eng. To Pipe		24202
Hose - Upper - Eng. To Pipe		24202	Hose - Lower - Rad. To Pipe		23564
Hose - Lower - Rad. To Pipe		23564	VN Series		
Volvo D16 Diesel			Belt - Serpentine Enhancement Kit - Alt. & A.C.; For Improved Belt Drive Design ...		
VN Series			Belt - Fan & W.P.		
Belt - Serpentine Enhancement Kit - Alt. & A.C.; For Improved Belt Drive Design ...		ACK080550HD	Belt - Alt. & A.C.	20582552	♣K080630HD
Belt - Fan	20882779	K100578HD	Tensioner Assy. - Alt. & A.C.	21454379	38671
Belt - Alt. & A.C.	20464710	♣K080550HD	Tensioner Assy. - Fan & Hub	20860873	38633
Tensioner Assy. - Fan	20491753	38581	Hose - Upper - Rad. To Pipe		23563
Tensioner Assy. - Alt. & A.C.	21422767	38585	Hose - Upper - Eng. To Pipe		24202
Idler Pulley - Fan (Lower)	20747516	36285	Hose - Lower - Rad. To Pipe		23564

♣Standard Belt Available.

≈<Cut to Fit.

Belts and Coolant Hose for Medium/Heavy-Duty Trucks (2001 & Newer)

Application	Mfr. Part No.	Our No.	Application	Mfr. Part No.	Our No.
Volvo - Continued			Volvo - Continued		
2009 - Continued			2008 - Continued		
Volvo D16 Diesel			Volvo D11 Diesel		
VN Series			VN Series		
Belt - Serpentine Enhancement Kit - Alt. & A.C.; For Improved Belt Drive Design		ACK080550HD	Belt - Serpentine Enhancement Kit - Alt. & A.C.; W/62 7/8" Belt O.C.	21568410	ACK080623HD
Belt - Fan	20882779	K100578HD	Belt - Serpentine Enhancement Kit - Alt. & A.C.; For Improved Belt Drive Design; W/63 5/8" Belt O.C.	21568414	ACK080630HD
Belt - Alt. & A.C.	20464710	♣K080550HD	Belt - Fan & W.P.	20883508	K100604HD
Tensioner Assy. - Fan	20491753	38581	Belt - Alt. & A.C.; W/62 7/8" Belt O.C.	21460410	♣K080623HD
Tensioner Assy. - Alt. & A.C.	21422767	38585	Belt - Alt. & A.C.; W/63 5/8" Belt O.C.	20582552	♣K080630HD
Idler Pulley - Fan (Lower)	20747516	36285	Tensioner Assy. - Fan	20739751	38607
Hose - Lower		24006	Tensioner Assy. - Alt. & A.C.; W/62 7/8" Belt O.C.	21454379	38671
VT Series			Tensioner Assy. - Alt. & A.C.; W/63 5/8" Belt O.C.	21404578	38671
Belt - Fan	20882779	K100578HD	Hose - Upper - Rad. To Pipe		24007
Belt - Alt. & A.C.	20464710	♣K080550HD	Hose - Upper - Pipe To Rad.		22714
Tensioner Assy. - Fan	20491753	38581	Hose - Upper - Pipe To Eng.		22714
Tensioner Assy. - Alt. & A.C.	21422767	38585			
Idler Pulley - Lower	20747516	36285			
Hose - Lower - Pipe To Rad.		24006			
Volvo VE D12 Diesel			Volvo D13 Diesel		
VHD			VHD		
Belt - Fan	20440066	♣K100572HD	Belt - Serpentine Enhancement Kit - Alt. & A.C.; For Improved Belt Drive Design ...	21568414	ACK080630HD
Belt - Hub To Alt. & A.C.	20451458	♣K080565HD	Belt - Fan & W.P.	20582559	K120786HD
Tensioner Assy. - Fan	20491753	38581	Belt - Alt. & A.C.	20582552	♣K080630HD
Tensioner Assy. - Alt. & A.C.	8149855	38585	Tensioner Assy. - Alt. & A.C.	21454379	38671
Idler Pulley - Fan	20457029	36286	Tensioner Assy. - Fan	20860873	38633
Volvo VE D16 Diesel			Hose - Upper - Rad. To Pipe		23563
VN Series			Hose - Upper - Eng. To Pipe		24202
Belt - Serpentine Enhancement Kit - Alt. & A.C.; For Improved Belt Drive Design		ACK080550HD	Hose - Lower - Rad. To Pipe		23564
Belt - Fan	20882779	K100578HD	VN Series		
Belt - Alt.	20464710	♣K080550HD	Belt - Serpentine Enhancement Kit - Alt. & A.C.; For Improved Belt Drive Design ...	21568414	ACK080630HD
Tensioner Assy. - Fan	21155561	38581	Belt - Fan	20582557	K120640HD
Tensioner Assy. - Alt. & A.C.	21422767	38585	Belt - Alt. & A.C.	20582552	♣K080630HD
Idler Pulley - Lower	20747516	36285	Tensioner Assy. - Fan	20860873	38633
Hose - Upper - Rad. To Pipe		24009	Tensioner Assy. - Alt. & A.C.	20762060	38671
Hose - Lower		24006	Hose - Upper - Rad. To Pipe		23563
VT Series			Hose - Upper - Eng. To Pipe		24202
Belt - Fan	20882779	K100578HD	Hose - Lower - Rad. To Pipe		23564
Belt - Alt. & A.C.	20464710	♣K080550HD			
Tensioner Assy. - Fan	20491753	38581	Volvo D16 Diesel		
Tensioner Assy. - Alt. & A.C.	21422767	38585	VN Series		
Idler Pulley - Lower	20747516	36285	Belt - Serpentine Enhancement Kit - Alt. & A.C.; For Improved Belt Drive Design		ACK080550HD
Hose - Lower - Pipe To Rad.		24006	Belt - Fan & W.P.	20878554	♣K120610HD
2008			Belt - Alt. & A.C.	20464710	♣K080550HD
Cummins ISX Diesel			Tensioner Assy. - Fan	20491753	38581
VN Series			Tensioner Assy. - Alt. & A.C.	8149855	38585
Belt - Fan & Alt.	20481362	♣K120842HD	Idler Pulley	20747516	36285
Belt - A.C.	20457273	♣K060637HD	Hose - Upper - Eng. To Pipe		21891
Tensioner Assy. - Fan & Alt.	3682946	38587	Hose - Upper - Rad. To Pipe		24009
Tensioner Assy. - A.C.	3682683	38610			
Tensioner Pulley - Fan & Alt.	3682946	36165	Volvo VE D12 Diesel		
Idler Pulley - Fan	20953521	36286	VHD		
Idler Pulley - A.C.	3682229	36223	Belt - Fan	20440066	♣K100572HD
Hose - Lower - Eng. To Pipe		24244	Belt - Hub To Alt. & A.C.	20451458	♣K080565HD
VT Series			Tensioner Assy. - Fan	20491753	38581
Belt - Fan & Alt.	20481362	♣K120842HD	Tensioner Assy. - Alt. & A.C.	8149855	38585
Belt - Hub & A.C.	20457273	♣K060637HD	Idler Pulley - Fan	20953521	36286
Tensioner Assy. - Fan & Alt.	3682946	38587	VN Series		
Tensioner Assy. - Hub & A.C.	3682683	38610	Belt - Fan	20491756	K100582HD
Tensioner Pulley - Fan & Alt.	3682946	36165	Belt - Alt. & A.C.	20430368	K080385HD
Idler Pulley - Fan	20953521	36286	Tensioner Assy. - Fan	20491753	38581
Idler Pulley - A.C.	3682229	36223	Tensioner Assy. - Alt. & A.C.	8149855	38585
Hose - Upper - Pipe To Eng.		24004	Idler Pulley - Fan	20457029	36286
Hose - Lower - Pipe To Eng.		♣24244	Hose - Upper		22709

Medium & Heavy-Duty Trucks (2001 & Newer)

♣Standard Belt Available.

♣<Cut to Fit.

Belts and Coolant Hose for Medium/Heavy-Duty Trucks (2001 & Newer)

Medium & Heavy-Duty Trucks
(2001 & Newer)

Application	Mfr. Part No.	Our No.
Volvo - Continued		
2008 - Continued		
Volvo VE D16 Diesel		
VN Series		
Belt - Serpentine Enhancement Kit - Alt. & A.C.; For Improved Belt Drive Design		ACK080550HD
Belt - Fan & W.P.	21133804	K100551HD
Belt - Alt. & A.C.	20464710	▲K080550HD
Tensioner Assy. - Fan	20491753	38581
Tensioner Assy. - Alt. & A.C.	8149855	38585
Idler Pulley	20747516	36285
Hose - Upper - Pipe To Eng.		24009
Hose - Lower		24006
VT Series		
Belt - Fan & W.P.	21133804	K100551HD
Belt - Alt. & A.C.	20464710	▲K080550HD
Tensioner Assy. - Fan	20491753	38581
Tensioner Assy. - Alt. & A.C.	8149855	38585
Idler Pulley	20747516	36285
Hose - Upper - Eng. To Rad.		28360
2007		
Cummins ISX Diesel		
VN Series		
Belt - Fan & Alt.	20481362	▲K120842HD
Belt - A.C.	20457273	▲K060637HD
Tensioner Assy. - Fan & Alt.	3682946	38587
Tensioner Assy. - A.C.	3682683	38610
Tensioner Pulley - Fan & Alt.	3682946	36165
Idler Pulley - Fan	20953521	36286
Idler Pulley - A.C.	3682229	36223
Hose - Lower - Eng. To Pipe		24244
VT Series		
Belt - Fan & Alt.	20481362	▲K120842HD
Belt - Hub & A.C.	20457273	▲K060637HD
Tensioner Assy. - Fan & Alt.	3682946	38587
Tensioner Assy. - Hub & A.C.	3682683	38610
Tensioner Pulley - Fan & Alt.	3682946	36165
Idler Pulley - Fan	20953521	36286
Idler Pulley - A.C.	3682229	36223
Hose - Upper		24001
Hose - Lower - Pipe To Eng.		24244
Volvo D11 Diesel		
VN Series		
Belt - Serpentine Enhancement Kit - Alt. & A.C.; For Improved Belt Drive Design; W/62 7/8" Belt O.C.	21568410	ACK080623HD
Belt - Serpentine Enhancement Kit - Alt. & A.C.; For Improved Belt Drive Design; W/63 5/8" Belt O.C.	21568414	ACK080630HD
Belt - Fan & W.P.	20883508	K100604HD
Belt - Alt. & A.C.; W/62 7/8" Belt O.C.	21460410	▲K080623HD
Belt - Alt. & A.C.; W/63 5/8" Belt O.C.	20582552	▲K080630HD
Tensioner Assy. - Fan	20739751	38607
Tensioner Assy. - Alt. & A.C.; W/62 7/8" Belt O.C.	21454379	38671
Tensioner Assy. - Alt. & A.C.; W/63 5/8" Belt O.C.	21404578	38671
Hose - Upper - Rad. To Pipe		24007
Hose - Upper - Pipe To Eng.		22714
Volvo D13 Diesel		
VHD		
Belt - Serpentine Enhancement Kit - Alt. & A.C.; For Improved Belt Drive Design ...	21568414	ACK080630HD
Belt - Fan & W.P.	20582559	K120786HD
Belt - Alt. & A.C.	20582552	▲K080630HD
Tensioner Assy. - Fan	20860873	38633
Tensioner Assy. - Alt.	20762060	38671
Hose - Upper - Rad. To Pipe		23563
Hose - Upper - Pipe To Eng.		24202

Application	Mfr. Part No.	Our No.
Volvo - Continued		
2007 - Continued		
Volvo D13 Diesel - Continued		
VHD - Continued		
Hose - Upper - Rad. To Pipe		23563
Hose - Upper - Eng. To Pipe		24202
Hose - Lower - Rad. To Pipe		23564
VN Series		
Belt - Serpentine Enhancement Kit - Alt. & A.C.; For Improved Belt Drive Design ...	21568414	ACK080630HD
Belt - Fan	20582557	K120640HD
Belt - Alt.	20582552	▲K080630HD
Tensioner Assy. - Fan	20860873	38633
Tensioner Assy. - Alt.	20762060	38671
Hose - Upper - Rad. To Pipe		23564
Hose - Upper - Pipe To Eng.		24202
Volvo VE D12 Diesel		
VHD		
Belt - Fan; W/57 7/8" Belt O.C.	20440066	▲K100572HD
Belt - Fan; W/58 3/8" Belt O.C.	20430385	K100578HD
Belt - Hub To Alt. & A.C.; W/130A. Alt.	20451458	▲K080565HD
Belt - Hub To Alt. & A.C.; W/145A. Alt.	20430368	K080385HD
Tensioner Assy. - Fan	20491753	38581
Tensioner Assy. - Alt. & A.C.	8149855	38585
Idler Pulley - Smooth	20953521	36286
VN Series		
Belt - Fan	20491756	K100582HD
Belt - Alt. & A.C.	20430368	K080385HD
Tensioner Assy. - Fan	20491753	38581
Tensioner Assy. - Alt. & A.C.	8149855	38585
Idler Pulley - Fan	20457029	36286
Idler Pulley - Smooth	20953521	36286
Hose - Upper - Eng. To Rad.		22709
Hose - Lower - Eng. To Rad.		≈22710
Volvo VE D13 Diesel		
VHD		
Belt - Serpentine Enhancement Kit - Alt. & A.C.; For Improved Belt Drive Design ...	21568414	ACK080630HD
Belt - Fan	20582559	K120786HD
Belt - Alt.	20582552	▲K080630HD
Tensioner Assy. - Fan	20860873	38633
Tensioner Assy. - Alt.	20762060	38671
Hose - Upper - Rad. To Pipe		23563
Hose - Upper - Pipe To Eng.		24202
Volvo VE D16 Diesel		
VN Series		
Belt - Fan & W.P.	21133804	K100551HD
Belt - Alt. & A.C.	20464710	▲K080550HD
Tensioner Assy. - Fan	20491753	38581
Tensioner Assy. - Alt. & A.C.	8149855	38585
Idler Pulley	20747516	36285
VT Series		
Belt - Fan & W.P.	21133804	K100551HD
Belt - Alt. & A.C.	20464710	▲K080550HD
Tensioner Assy. - Fan	20491753	38581
Tensioner Assy. - Alt. & A.C.	8149855	38585
Idler Pulley	20747516	36285
Hose - Upper		28360
Hose - Lower		24005
2006		
Cummins ISX Diesel		
VN Series		
Belt - Fan & Alt.	20481362	▲K120842HD
Belt - Hub & A.C.	20457273	▲K060637HD
Tensioner Assy. - Fan & Alt.	3682946	38587
Tensioner Assy. - Hub & A.C.	3682683	38610

▲Standard Belt Available.

≈Cut to Fit.

Belts and Coolant Hose for Medium/Heavy-Duty Trucks (2001 & Newer)

Application	Mfr. Part No.	Our No.	Application	Mfr. Part No.	Our No.
Volvo - Continued			Volvo - Continued		
2006 - Continued			2005 - Continued		
Cummins ISX Diesel - Continued			Cummins ISX Diesel - Continued		
VN Series - Continued			VN Series - Continued		
Tensioner Pulley - Fan & Alt.	3682946	36165	Hose - Lower - Rad. To Pipe		22717
Idler Pulley - Fan	20953521	36286	Hose - Lower - Eng. To Pipe		24244
Idler Pulley - A.C.	3682229	36223	Volvo VE D12 Diesel		
Hose - Lower - Eng. To Pipe		24244	VHD		
VT Series			Belt - Fan	20440066	▲K100579HD
Belt - Fan & Alt.	20481362	▲K120842HD	Belt - Alt. & A.C.	20430368	K080385HD
Belt - A.C.	20457273	▲K060637HD	Tensioner Assy. - Fan	20491753	38581
Tensioner Assy. - Fan & Alt.	3682946	38587	Tensioner Assy. - Alt. & A.C.	8149855	38585
Tensioner Assy. - A.C.	3682683	38610	Idler Pulley - Fan	20457029	36286
Tensioner Pulley - Fan & Alt.	3682946	36165	VN Series		
Idler Pulley - Fan	20953521	36286	Belt - Fan	20491756	K100582HD
Idler Pulley - A.C.	3682229	36223	Belt - Alt. & A.C.	20430368	K080385HD
Hose - Upper		24001	Tensioner Assy. - Fan	20491753	38581
Hose - Lower - Eng. To Pipe		24244	Tensioner Assy. - Alt. & A.C.	8149855	38585
Volvo VE D12 Diesel			Idler Pulley - Fan	20457029	36286
VHD			Hose - Upper - Eng. To Rad.		22709
Belt - Fan; W/57 1/2" Belt O.C.	20440066	▲K100572HD	Hose - Lower - Eng. To Rad.		≈22710
Belt - Hub To Fan; W/58" Belt O.C.	20430385	K100578HD	2004		
Belt - Alt. & A.C.; W/39" Belt O.C.	20430368	K080385HD	Cummins ISL Diesel		
Belt - Hub To Alt. & A.C.; W/57" Belt O.C. ...	20451458	▲K080565HD	VHD		
Tensioner Assy. - Fan	20491753	38581	Belt - Alt.	20484570	▲K080774HD
Tensioner Assy. - Alt. & A.C.	8149855	38585	Tensioner Assy.	21631484	38581
Idler Pulley - Fan	20457029	36286	Idler Pulley	20457029	36286
VN Series			Cummins ISX Diesel		
Belt - Fan	20491756	K100582HD	VN Series		
Belt - Alt. & A.C.	20430368	K080385HD	Belt - Fan & Alt.	20481362	▲K120842HD
Tensioner Assy. - Fan	20491753	38581	Belt - A.C.	20457273	▲K060637HD
Tensioner Assy. - Alt. & A.C.	8149855	38585	Tensioner Assy. - Fan & Alt.	3682946	38587
Idler Pulley - Fan	20457029	36286	Tensioner Assy. - A.C.	3682683	38610
Hose - Upper - Eng. To Rad.		22709	Tensioner Pulley - Fan & Alt.	3682946	36165
Hose - Lower - Eng. To Rad.		≈22710	Idler Pulley - Fan	20953521	36286
Volvo VE D16 Diesel			Idler Pulley - A.C.	3682229	36223
VN Series			Hose - Upper		24001
Belt - Fan & W.P.	21133804	K100551HD	Hose - Lower - Rad. To Pipe		22717
Belt - Alt. & A.C.	20464710	▲K080550HD	Hose - Lower - Eng. To Pipe		≈24244
Tensioner Assy. - Fan	20491753	38581	Volvo VE D12 Diesel		
Tensioner Assy. - Alt. & A.C.	8149855	38585	VHD		
Idler Pulley	20747516	36285	Belt - Fan	20430382	▲K100437HD
VT Series			Belt - Hub, Alt. & A.C.	978238	▲K080375HD
Belt - Fan & W.P.	21133804	K100551HD	Tensioner Assy. - Fan	20491753	38581
Belt - Alt. & A.C.	20464710	▲K080550HD	Hose - Upper - Eng. To Rad.		22709
Tensioner Assy. - Fan	20491753	38581	Hose - Lower - Eng. To Rad.		22710
Tensioner Assy. - Alt. & A.C.	8149855	38585	VN Series		
Idler Pulley	20747516	36285	Belt - Fan	20491756	K100582HD
Hose - Upper		28360	Belt - Alt. & A.C.	20430367	▲K080384HD
Hose - Lower		24005	Tensioner Assy. - Fan	20491753	38581
2005			Tensioner Assy. - Alt. & A.C.	8149855	38585
Cummins ISL Diesel			Idler Pulley - Fan	20457029	36286
VHD			Hose - Upper - Eng. To Rad.		22709
Belt - Alt.	20484570	▲K080774HD	Hose - Lower - Eng. To Rad.		≈22710
Tensioner Assy.	21631484	38581	2003		
Idler Pulley	20457029	36286	Cummins ISM Diesel		
Cummins ISX Diesel			VHD		
VN Series			Belt - Fan & Alt.	982186	▲K100891HD
Belt - Fan & Alt.	20481362	▲K120842HD	Belt - Hub & A.C.	982351	▲K060532HD
Belt - A.C.	20457273	▲K060637HD	Tensioner Assy. - Fan & Alt.	8086969	38539
Tensioner Assy. - Fan & Alt.	3682946	38587	Tensioner Assy. - Hub & A.C.	3979979	38607
Tensioner Assy. - A.C.	3682683	38610	Tensioner Pulley - Fan & Alt.	8086969	36092
Tensioner Pulley - Fan & Alt.	3682946	36165	Hose - Upper - Eng. To Rad.		22711
Idler Pulley - Fan	20953521	36286	Hose - Lower - Eng. To Rad.		22712
Idler Pulley - A.C.	3682229	36223			
Hose - Upper		24001			

▲Standard Belt Available.

≈Cut to Fit.

Medium & Heavy-Duty Trucks
(2001 & Newer)

Belts and Coolant Hose for Medium/Heavy-Duty Trucks (2001 & Newer)

Medium & Heavy-Duty Trucks
(2001 & Newer)

Application	Mfr. Part No.	Our No.	Application	Mfr. Part No.	Our No.
Volvo - Continued			Volvo - Continued		
2003 - Continued			2003 - Continued		
Cummins ISM Diesel - Continued			Volvo VE D7 Diesel		
VN Series			VHD		
Belt - Fan & Alt.	981633	♣K100665HD	Tensioner Assy. - Fan	3979980	38547
Belt - Hub & A.C.	981634	♣K060415HD	Tensioner Assy. - Alt. & A.C.	3979979	38607
Hose - Upper Assy. - Fan & Alt.	8086969	38539	Volvo VE D12 Diesel		
Tensioner Assy. - Smooth	3979979	38607	VHD		
Tensioner Assy. - Grooved	20461113	38545	Belt - Fan; W/44 1/4" Belt O.C.	20430382	♣K100437HD
Tensioner Pulley - Fan & Alt.	8086969	36092	Belt - Hub, Alt. & A.C.; W/38 1/8" Belt O.C.	978238	♣K080375HD
Hose - Upper - Eng. To Pipe	24236	24236	Belt - Fan; W/58 1/2" Belt O.C.	982356	♣K100579HD
Hose - Upper - Pipe To Rad.	24236	24240	Tensioner Assy. - Fan	20491753	38581
Hose - Lower - Eng. To Pipe	24240	24240	Tensioner Assy. - Alt.	8149855	38585
Hose - Lower - Pipe To Rad.	24240	24240	Hose - Upper - Eng. To Rad.		22709
Cummins ISX Diesel			Hose - Lower - Eng. To Rad.		22710
VN Series			VN Series		
Belt - Fan; W/Clean Air Pkg.	20481362	♣K120842HD	Belt - Fan	981335	♣K100437HD
Belt - Fan; W/O Clean Air Pkg.	3681820	♣K100510HD	Belt - Hub, Alt. & A.C.	978238	♣K080375HD
Belt - Hub, Alt. & A.C.; W/Clean Air Pkg.	20457273	♣K060637HD	Tensioner Assy. - Fan	21257889	38547
Belt - Hub, Alt. & A.C.; W/O Clean Air Pkg.	3681812	♣K060685HD	Hose - Upper - Eng. To Rad.		22709
Tensioner Assy. - Fan & Alt.; W/Clean Air Pkg.	3682946	38587	Hose - Lower - Eng. To Rad.		22710
Tensioner Assy. - A.C.; W/Clean Air Pkg.	3682683	38610	2002		
Tensioner Assy. - Fan; W/O Clean Air Pkg.	3681240	38535	Cummins ISM Diesel		
Tensioner Assy. - Hub, Alt. & A.C.; W/O Clean Air Pkg.	3680194	38532	VHD		
Tensioner Pulley - Fan & Alt.; W/Clean Air Pkg.	3682946	36165	Belt - Fan & Alt.	982186	♣K100891HD
Tensioner Pulley - Fan; W/O Clean Air Pkg.	3681240	36092	Belt - Hub & A.C.	982351	♣K060532HD
Tensioner Pulley - Hub, Alt. & A.C.; W/O Clean Air Pkg.	3680194	36095	Tensioner Assy. - Fan & Alt.	8086969	38539
Idler Pulley - Alt. & A.C.	4026886	36226	Tensioner Assy. - Hub & A.C.	3979979	38607
Idler Pulley; W/Clean Air Pkg.	3682229	36223	Tensioner Pulley - Fan & Alt.	8086969	36092
Hose - Lower - Eng. To Pipe	24240	24240	Hose - Upper - Eng. To Rad.		22711
Cummins N14 Diesel			Hose - Lower - Eng. To Rad.		22712
VN Series			VN Series		
Belt - Fan	3164780	♣K100630HD	Belt - Fan & Alt.	982186	♣K100891HD
Belt - Alt.	981953	K050418	Belt - Hub & A.C.	982351	♣K060532HD
Belt - Hub & W.P.		♣K060425HD	Tensioner Assy. - Fan & Alt.	8086969	38539
Belt - Hub & A.C.	8029802	♣9370HD	Tensioner Assy. - Smooth	3979979	38607
Tensioner Pulley - Fan	20461114	36098	Tensioner Assy. - Grooved	20461113	38545
Hose - Upper - Eng. To Pipe	24240	24240	Tensioner Pulley - Fan & Alt.	8086969	36092
Hose - Upper - Pipe To Rad.	24240	24240	Cummins ISX Diesel		
Hose - Lower - Eng. To Pipe	24240	24240	VN Series		
Hose - Lower - Pipe To Rad.	24240	24240	Belt - Fan	3681820	♣K100510HD
Cummins Signature 600 Diesel			Belt - Hub, Alt. & A.C.	3681812	♣K060685HD
VN Series			Tensioner Assy. - Fan	3681240	38535
Belt - Fan; W/Clean Air Pkg.	20481362	♣K120842HD	Tensioner Assy. - Hub, Alt. & A.C.	3680194	38532
Belt - Fan; W/O Clean Air Pkg.	3681820	♣K100510HD	Tensioner Pulley - Fan	3681240	36092
Belt - Hub, Alt. & A.C.; W/Clean Air Pkg.	20457273	♣K060637HD	Tensioner Pulley - Hub, Alt. & A.C.	3680194	36095
Belt - Hub, Alt. & A.C.; W/O Clean Air Pkg.	3681812	♣K060685HD	Idler Pulley - Alt. & A.C.	4026886	36226
Tensioner Assy. - Fan & Alt.; W/Clean Air Pkg.	3682946	38587	Hose - Upper - Eng. To Rad.		22716
Tensioner Assy. - A.C.; W/Clean Air Pkg.	3682683	38610	Hose - Lower - Eng. To Pipe		24240
Tensioner Assy. - Fan; W/O Clean Air Pkg.	3681240	38535	Hose - Lower - Pipe To Rad.		22717
Tensioner Assy. - Hub, Alt. & A.C.; W/O Clean Air Pkg.	3680194	38532	Cummins N14 Diesel		
Tensioner Pulley - Fan & Alt.; W/Clean Air Pkg.	3682946	36165	VN Series		
Tensioner Pulley - Fan; W/O Clean Air Pkg.	3681240	36092	Belt - Fan	3164780	♣K100630HD
Tensioner Pulley - Hub, Alt. & A.C.; W/O Clean Air Pkg.	3680194	36095	Belt - Alt.	981953	K050418
Idler Pulley - Alt. & A.C.	4026886	36226	Belt - Hub & W.P.		♣K060425HD
Hose - Lower - Eng. To Pipe	24240	24240	Belt - Hub & A.C.	8029802	♣9370HD
			Tensioner Assy. - Fan	3164793	38536
			Tensioner Pulley - Fan	3164793	36098
			Hose - Upper - Eng. To Rad.		22726
			Hose - Upper - Eng. To Pipe		24240
			Hose - Upper - Pipe To Rad.		24240
			Hose - Lower - Eng. To Pipe		24240
			Hose - Lower - Pipe To Rad.		24240

♣Standard Belt Available.

Belts and Coolant Hose for Medium/Heavy-Duty Trucks (2001 & Newer)

Application	Mfr. Part No.	Our No.	Application	Mfr. Part No.	Our No.
Volvo - Continued			Volvo - Continued		
2002 - Continued			2001 - Continued		
Volvo VE 12 Diesel			Cummins ISX Diesel - Continued		
VHD			VN Series - Continued		
Belt - Fan	982356	♣K100579HD	Tensioner Pulley - Hub, Alt. & A.C.	3680194	36095
Belt - Hub To Alt. & A.C.	978242	♣K080382HD	Hose - Upper - Eng. To Rad.		22716
Tensioner Assy. - Fan	20491753	38581	Hose - Lower - Eng. To Pipe		24240
Volvo VE D7 Diesel			Hose - Lower - Pipe To Rad.		
VHD			22717		
Tensioner Assy. - Fan	3979980	38547	Cummins N14 Diesel		
Tensioner Assy. - Alt. & A.C.	3979979	38607	Autocar		
Xpeditor			Belt - Hub & W.P.		
Belt - Fan	978823	♣9610HD	Belt - Hub & Fan	30764921	♣K060425HD
Belt - Alt.	968934	②7425	Belt - Alt.	8057960	♣K080465HD
Volvo VE D12 Diesel			Belt - Hub & A.C.		
VHD			8029802		
Belt - Fan	982356	♣K100579HD	Hose - Upper - Eng. To Pipe		24240
Belt - Hub To Alt. & A.C.; W/Man.			Hose - Upper - Pipe To Rad.		24240
Tensioner	982353	K080558	Hose - Lower - Eng. To Pipe		24240
Belt - Hub To Alt. & A.C.; W/Tensioner			Hose - Lower - Pipe To Rad.		24240
Pulley	20451458	♣K080565HD	VN Series		
Tensioner Assy. - Fan	3979980	38547	Belt - Hub & W.P.		
Tensioner Assy. - Hub, Alt. & A.C.; W/Auto. Tensioner	21422767	38585	Belt - Fan	3164780	♣K100630HD
VN Series			Belt - Alt.	981953	K050418
Belt - Fan	981335	♣K100437HD	Belt - Hub & A.C.	8029802	♣9370HD
Belt - Hub, Alt. & A.C.	978238	♣K080375HD	Tensioner Assy. - Fan	3164793	38536
Tensioner Assy. - Fan	21257889	38547	Tensioner Pulley - Fan	3164793	36098
Hose - Upper - Eng. To Rad.		22709	Hose - Upper - Eng. To Rad.		22726
Hose - Lower - Eng. To Rad.		22710	Hose - Lower - Eng. To Pipe		24240
2001			Hose - Lower - Pipe To Rad.		
Cummins ISM Diesel			24240		
Autocar			WG Series		
Belt - Fan	981938	♣K080645HD	Belt - W.P.		
Belt - Hub & Alt.	3028521	♣K050345HD	Belt - Fan	8060304	♣K080435HD
Belt - Hub & A.C.	027070550	♣9530HD	Detroit Diesel 6-Cyl. 11.1 L Diesel		
Hose - Upper - Eng. To Pipe		24240	Autocar		
Hose - Upper - Pipe To Rad.		24240	Belt - Fan		
Hose - Lower - Eng. To Pipe		24240	③♣9625HD		
Hose - Lower - Pipe To Rad.		24240	Belt - Hub, Alt. & A.C.		
VN Series			②♣9490HD		
Belt - Fan	981937	♣K080610HD	Hose - Upper - Eng. To Pipe		
Belt - Hub & Alt.	3028521	♣K050345HD	24240		
Belt - A.C.	V1091148	♣9530HD	Hose - Upper - Pipe To Rad.		
Tensioner Assy. - A.C.; W/V-Ribbed Belt	8086971	38545	24240		
Hose - Upper - Eng. To Pipe		24240	Hose - Lower - Eng. To Pipe		
Hose - Upper - Pipe To Eng.		24240	24248		
Hose - Lower - Eng. To Pipe		21891	Hose - Lower - Pipe To Rad.		
Hose - Lower - Pipe To Rad.		21891	24248		
WG Series			VN Series		
Belt - Fan	981937	♣K080610HD	Belt - Fan & Alt.		
Belt - Hub & Alt.	3028521	♣K050345HD	8397694		
Belt - Hub & A.C.	027070550	♣9530HD	Belt - Fan & A.C.		
Hose - Upper - Eng. To Pipe		24240	967138		
Hose - Upper - Pipe To Rad.		24240	Tensioner Assy. - Fan & Alt.		
Hose - Lower - Eng. To Pipe		24240	8079517		
Hose - Lower - Pipe To Rad.		♣21042	Tensioner Pulley		
Hose - Lower - Pipe To Pipe		♣21042	8079517		
Cummins ISX Diesel			Hose - Upper - Eng. To Pipe		
VN Series			24240		
Belt - Fan	3681820	♣K100510HD	Hose - Lower - Eng. To Pipe		
Belt - Hub, Alt. & A.C.	3681812	♣K060685HD	24240		
Tensioner Assy. - Fan	3681240	38535	Hose - Lower - Pipe To Rad.		
Tensioner Assy. - Hub, Alt. & A.C.	3680194	38532	24248		
Idler Pulley - Alt. & A.C.	4026886	36226	24240		
Tensioner Pulley - Fan	3681240	36092	24240		

♣Standard Belt Available.
 ♣<Cut to Fit.

②Two Required.
 ③Three Required.

Medium & Heavy-Duty Trucks
(2001 & Newer)

Belts and Coolant Hose for Medium/Heavy-Duty Trucks (2001 & Newer)

Medium & Heavy-Duty Trucks
(2001 & Newer)

Application	Mfr. Part No.	Our No.	Application	Mfr. Part No.	Our No.
Volvo - Continued			Western Star - Continued		
2001 - Continued			2014 - Continued		
Volvo VE D7 Diesel			Cummins ISX15 Diesel - Continued		
VHD			4900SB - Continued		
Tensioner Assy. - Fan	3979980	38547	Hose - Pipe To Intercooler (Hot Side)		26203
Tensioner Assy. - Alt. & A.C.	3979979	38607	Detroit Diesel DD15 Diesel		
Volvo VE D12 Diesel			4900FA		
VHD			Belt - Serpentine - Fan		
Belt - Fan	982356	♣K100579HD	Belt - Serpentine - Alt. & A.C.	0132731635	K100643HD
Belt - Hub To Alt. & A.C.	982353	K080558	Tensioner Assy.	0132732700	K081065HD
Tensioner Assy. - Fan	3979980	38547	EA4722000570 38667		
VN Series			2013		
Belt - Fan	981335	♣K100437HD	Detroit Diesel DD13 Diesel		
Belt - Hub, Alt. & A.C.	978238	♣K080375HD	4700SB; 4700SF; 4800SB; 4800SF; 4800TS; 4900EX; 4900SB; 4900SF; 4900TS; 4900XD		
Tensioner Assy. - Fan	21257889	38547	Tensioner Assy.		
Hose - Upper - Eng. To Rad.		22709	A4722000570 38667		
Hose - Lower - Eng. To Rad.		22710	Detroit Diesel DD15 Diesel		
WG Series			4900EX; 4900SB; 4900SF; 4900TS; 4900XD; 6900TS; 6900XD		
Belt - Fan & Hub	980886	♣K080566HD	Tensioner Assy.		
Belt - Fan - From C.S.	982356	♣K100579HD	A4722000570 38667		
Belt - Hub, Alt. & A.C.	1676272	♣K050380HD	Detroit Diesel DD16 Diesel		
Belt - Alt. & A.C.	978238	♣K080375HD	4900EX; 4900SB; 4900SF; 4900TS; 4900XD; 6900TS; 6900XD		
Tensioner Assy. - Fan & Hub	3154315	38531	Tensioner Assy.		
Tensioner Assy. - Fan	21257889	38547	A4722000570 38667		
Hose - Upper - Eng. To Rad.		22713	2012		
Hose - Lower - Eng. To Pipe		22714	Detroit Diesel DD13 Diesel		
Hose - Lower - Pipe To Rad.		22715	4700SB; 4700SF; 4800SB; 4800SF; 4800TS; 4900EX; 4900FA		
Western Star			Tensioner Assy.		
2015			A4722000570 38667		
Cummins ISX15 Diesel			4900SA		
4900SB			Belt - Fan		
Belt - Serpentine - Fan	0132161200	K120866HD	Belt - Alt.	0132731635	K100643HD
Belt - Serpentine - A.C.	0132162674	♣K060658HD	Tensioner Assy.	0132732680	K081065HD
Tensioner Assy. - Fan	4299051	38587	EA4722000570 38667		
Tensioner Assy. - A.C.	2891940	38610	4900SB; 4900SF; 4900TS; 4900XD		
Idler Pulley - A.C.	3682229	36223	Tensioner Assy.		
Hose - Lower - Pipe To Eng.		≈28200	A4722000570 38667		
Hose - Lower - Rad. To Pipe		24045	Detroit Diesel DD15 Diesel		
Hose - Return - Pump To Tank	0428919000	DEF7003	4900EX; 4900FA; 4900SB; 4900SF		
Hose - Turbo To Pipe (Hot Side)		26203	Belt - Serpentine - Alt. & A.C.		
Detroit Diesel DD13 Diesel			Belt - Serpentine - Fan		
4700SF			Tensioner Assy.		
Belt - Serpentine - A.C.	0132732680	K081055HD	A4722000570 38667		
Belt - Serpentine - Fan	0132731635	K100643HD	Detroit Diesel DD16 Diesel		
Tensioner Assy.	EA4722000570	38667	4900EX; 4900SB; 4900SF; 4900TS; 4900XD; 6900TS; 6900XD		
Hose - Upper - Rad. To Pipe		≈24238	Tensioner Assy.		
		or	A4722000570 38667		
Hose - Upper - Pipe To Eng.		≈24838	2011		
Hose - Lower - Eng. To Pipe		≈28200	Detroit Diesel DD13 Diesel		
Hose - Lower - Rad. To Pipe		≈24640	4900EX; 4900SA		
Hose - Pipe To Intercooler (Hot Side)		≈28200	Tensioner Assy.		
		26204	A4722000570 38667		
2014			Detroit Diesel DD15 Diesel		
Cummins ISX15 Diesel			4900EX		
4900SB			Tensioner Assy.		
Belt - Serpentine - Fan	0132161200	K120866HD	A4722000570 38667		
Belt - Serpentine - A.C.	0132162674	♣K060658HD	4900FA		
Tensioner Assy. - Fan	4299051	38587	Belt - Fan		
Tensioner Assy. - A.C.	2891940	38610	0131893635 K100643HD		
Idler Pulley - A.C.	3682229	36223	Belt - A.C. & Alt.		
Hose - Lower - Pipe To Eng.		≈28200	0132732700 K081065HD		
Hose - Lower - Rad. To Pipe		24045	Tensioner Assy.		
Hose - Return - Pump To Tank	0428919000	DEF7003	A4722000570 38667		
Hose - Turbo To Pipe (Hot Side)		26203	4900SA		
			Belt - Fan		
			0131893635 K100643HD		
			Belt - A.C. & Alt.		
			0132732700 K081065HD		
			Tensioner Assy.		
			EA4722000570 38667		
			6900XD		
			Tensioner Assy.		
			A4722000570 38667		

♣Standard Belt Available.

≈Cut to Fit.

Belts and Coolant Hose for Medium/Heavy-Duty Trucks (2001 & Newer)

Application	Mfr. Part No.	Our No.	Application	Mfr. Part No.	Our No.
Western Star - Continued			Western Star - Continued		
2011 - Continued			2009 - Continued		
Detroit Diesel DD16 Diesel			Detroit Diesel DD15 Diesel - Continued		
4900EX; 4900SA; 6900XD			4900SA - Continued		
Tensioner Assy.	A4722000570	38667	Hose - Lower - Eng. To Pipe		≅24440
2010			Hose - Lower - Pipe To Rad.		≅21891
Detroit Diesel DD15 Diesel			2008		
4900EX; 4900FA			Caterpillar C15 Diesel		
Tensioner Assy.	A4722000570	38667	4900FA; 4900SA		
4900SA			Belt - Fan & A.C.	0131008895	K121139HD
Belt - Fan	0131893715	♣K100675HD	Belt - Fan To Alt.	0129730720	♣K060675HD
Tensioner Assy.	A4722000570	38667	Tensioner Assy. - Fan & A.C.	2362301	38609
6900XD			Tensioner Assy. - Fan & Alt.	2790253	38636
Tensioner Assy.	A4722000570	38667	Hose - Upper - Eng. To Pipe		24240
2009			Hose - Upper - Rad. To Pipe		24240
Caterpillar C15 Diesel			Hose - Lower		≅21891
4900EX			Detroit Diesel 6-Cyl. 12.7 L Diesel		
Belt - Fan	0131008895	K121139HD	4900EX		
Belt - Alt.	0129730720	♣K060675HD	Belt - Fan		
4900FA			Belt - Alt. & A.C.	0124894002	♣K100675HD
Belt - Fan & A.C.	0131008895	K121139HD	Tensioner Assy. - Fan	0124587004	♣K080565HD
Belt - Alt.	0129730720	♣K060675HD	Tensioner Assy. - Fan	0127846000	38503
Tensioner Assy. - Fan & A.C.	2790253	38636	Tensioner Assy. - Alt. & A.C.	0127425000	38501
Tensioner Assy. - Alt.	3368955	38609	Hose - Upper - Eng. To Pipe		24240
Idler Pulley - A.C. (Upper)	2790252	36230	Hose - Upper - Rad. To Pipe		24240
Idler Pulley - A.C. (Lower)	2790252	36230	Hose - Lower - Eng. To Pipe		24240
Idler Pulley - Alt. (Lower)	2850277	36282	Hose - Lower - Rad. To Pipe		24240
4900SA			Detroit Diesel 6-Cyl. 14.0 L Diesel		
Belt - Fan & A.C.	0131008895	K121139HD	4900EX; 4900FA; 4900SA		
Belt - Alt.	0129730720	♣K060675HD	Belt - Fan		
Tensioner Assy. - Fan & A.C.	2362301	38609	Belt - Alt. & A.C.	0124587004	♣K080565HD
Tensioner Assy. - Alt.	2790253	38636	Tensioner Assy. - Fan	0127846000	38503
Idler Pulley - A.C. (Upper)	2850273	36164	Tensioner Assy. - Alt. & A.C.	0127425000	38501
Idler Pulley - A.C. (Lower)	2850277	36282	Hose - Upper - Eng. To Pipe		24240
Idler Pulley - Alt. (Upper)	2790252	36230	Hose - Upper - Rad. To Pipe		24240
Idler Pulley - Alt. (Lower)	2790252	36230	Hose - Lower - Eng. To Pipe		24240
Hose - Upper - Eng. To Pipe		≅24440	Hose - Lower - Rad. To Pipe		24240
Hose - Upper - Pipe To Rad.		≅24440	Mercedes-Benz MBE 4000 Diesel		
Hose - Lower - Eng. To Pipe		≅21891	4900FA		
Hose - Lower - Pipe To Rad.		≅21135	Belt - Alt.		
Detroit Diesel 6-Cyl. 14.0 L Diesel			Belt - Alt.		
4900EX			0127116004		
Belt - Fan	0124894002	♣K100675HD	Tensioner Assy. - Alt.		
Belt - Alt. & A.C.	0124587004	♣K080565HD	0127425000		
Tensioner Assy. - Fan	0127846000	38503	Tensioner Assy. - Fan		
Tensioner Assy. - Alt. & A.C.	0127425000	38501	0127427001		
Hose - Upper - Eng. To Pipe		≅24440	2007		
Hose - Upper - Pipe To Rad.		≅24440	Caterpillar C13 Diesel		
Hose - Lower - Eng. To Pipe		≅24440	4900SA		
Hose - Lower - Pipe To Rad.		≅24440	Belt - Fan, Alt. & A.C.		
4900FA			Tensioner Assy. - Fan, Alt. & A.C.		
Belt - Fan	0124894002	♣K100675HD	Tensioner Pulley - Fan, Alt. & A.C.		
Belt - Alt. & A.C.	0124587004	♣K080565HD	Idler Pulley - Smooth		
Tensioner Assy. - Fan	0127846000	38503	Idler Pulley - Grooved		
Tensioner Assy. - Alt. & A.C.	0127425000	38501	Hose - Upper - Eng. To Pipe		
4900SA			Hose - Upper - Rad. To Pipe		
Belt - Fan	0124894002	♣K100675HD	Hose - Lower - Eng. To Pipe		
Belt - Alt. & A.C.	0124587004	♣K080565HD	Hose - Lower - Rad. To Pipe		
Tensioner Assy. - Fan	0127846000	38503	Caterpillar C15 Diesel		
Tensioner Assy. - Alt. & A.C.	0127425000	38501	4900EX; 4900FA		
Detroit Diesel DD15 Diesel			Belt - Fan & Alt.		
4900SA			0123415073		
Belt - Fan	0131893715	♣K100675HD	Belt - Fan To A.C.		
Belt - W.P., Alt. & A.C.	0131894642	♣K081035HD	0127177007		
Tensioner Assy.	A4722000570	38667	Tensioner Assy. - Fan & Alt.		
Hose - Upper - Eng. To Pipe		≅24440	2002279		
Hose - Upper - Pipe To Rad.		≅24440	Tensioner Assy. - Fan To A.C.		
			2178938		
			Idler Pulley - Smooth		
			1979641		
			Idler Pulley - Grooved		
			1979642		
			Tensioner Pulley - Fan To A.C.		
			2178938		
			Hose - Upper - Eng. To Pipe		
			24240		
			Hose - Upper - Rad. To Pipe		
			24240		

Medium & Heavy-Duty Trucks (2001 & Newer)

♣Standard Belt Available.

≅Cut to Fit.

Belts and Coolant Hose for Medium/Heavy-Duty Trucks (2001 & Newer)

Medium & Heavy-Duty Trucks
(2001 & Newer)

Application	Mfr. Part No.	Our No.	Application	Mfr. Part No.	Our No.
Western Star - Continued			Western Star - Continued		
2007 - Continued			2007 - Continued		
Caterpillar C15 Diesel - Continued			Detroit Diesel 6-Cyl. 14.0 L Diesel - Continued		
4900EX; 4900FA - Continued			4900SA - Continued		
Hose - Lower - Eng. To Pipe		24240	Hose - Lower - Rad. To Pipe		24240
Hose - Lower - Rad. To Pipe		24240	2006		
4900SA			Caterpillar C13 Diesel		
Belt - Fan & Alt.	0123415073	♣K081088HD	4900SA		
Belt - Fan To A.C.	0129730314	♣K060516HD	Belt - Fan, Alt. & A.C.	0127110059	♣K081124HD
Tensioner Assy. - Fan & Alt.	2002279	38569	Tensioner Assy. - Fan, Alt. & A.C.	2117895	38590
Tensioner Assy. - Fan To A.C.	2178938	38511	Tensioner Pulley - Fan, Alt. & A.C.	2117895	36164
Idler Pulley - Smooth	1979641	36091	Idler Pulley - Smooth	2078118	36269
Idler Pulley - Grooved	1979642	36341	Idler Pulley - Grooved	1979642	36341
Tensioner Pulley - Fan To A.C.	2178938	36091	Hose - Upper - Eng. To Pipe		24240
Hose - Upper - Eng. To Pipe		24240	Hose - Upper - Rad. To Pipe		24240
Hose - Upper - Rad. To Pipe		24240	Hose - Lower - Eng. To Pipe		24240
Hose - Lower - Eng. To Pipe		24240	Hose - Lower - Rad. To Pipe		24240
Hose - Lower - Rad. To Pipe		24240	Caterpillar C15 Diesel		
6900XD			4900EX; 4900FA; 4900SA		
Idler Pulley - Smooth	1979641	36091	Belt - Fan & Alt.	0123415073	♣K081088HD
Idler Pulley - Grooved	1979642	36341	Belt - Fan To A.C.	0127177007	♣K060547HD
Detroit Diesel 6-Cyl. 12.7 L Diesel			Tensioner Assy. - Fan & Alt.		
4900FA			Tensioner Assy. - Fan To A.C.		
Belt - Fan	0124894002	♣K100675HD	Idler Pulley - Smooth	1979641	36091
Belt - Hub, Alt. & A.C.	0124587004	♣K080565HD	Idler Pulley - Grooved	1979642	36341
Tensioner Assy. - Fan	0127846000	38503	Tensioner Pulley - Fan To A.C.	2178938	36091
Tensioner Assy. - Hub, Alt. & A.C.	0127425000	38501	Hose - Upper - Eng. To Pipe		24240
Tensioner Pulley - Fan	0127846000	38076	Hose - Upper - Rad. To Pipe		24240
Tensioner Pulley - Hub, Alt. & A.C.	0127425000	38075	Hose - Lower - Eng. To Pipe		24240
Hose - Upper - Eng. To Pipe		24240	Hose - Lower - Rad. To Pipe		24240
Hose - Upper - Rad. To Pipe		24240	6900XD		
Hose - Lower - Eng. To Pipe		24240	Idler Pulley - Smooth	1979641	36091
Hose - Lower - Rad. To Pipe		24240	Idler Pulley - Grooved	1979642	36341
Hose - Lower - Pipe To Pipe		24240	Detroit Diesel 6-Cyl. 12.7 L Diesel		
4900SA			4900EX; 4900FA		
Belt - Fan	0124894002	♣K100675HD	Belt - Fan	0124894002	♣K100675HD
Belt - Hub, Alt. & A.C.	0124587004	♣K080565HD	Belt - Hub, Alt. & A.C.	0124587004	♣K080565HD
Tensioner Assy. - Fan	0127846000	38503	Tensioner Assy. - Fan	0127846000	38503
Tensioner Assy. - Hub, Alt. & A.C.	0127425000	38501	Tensioner Assy. - Hub, Alt. & A.C.	0127425000	38501
Tensioner Pulley - Fan	0127846000	38076	Tensioner Pulley - Fan	0127846000	38076
Tensioner Pulley - Hub, Alt. & A.C.	0127425000	38075	Tensioner Pulley - Hub, Alt. & A.C.	0127425000	38075
Hose - Upper - Eng. To Pipe		24240	Hose - Upper - Eng. To Pipe		24240
Hose - Upper - Rad. To Pipe		24240	Hose - Upper - Rad. To Pipe		24240
Hose - Lower - Eng. To Pipe		24240	Hose - Lower - Eng. To Pipe		24240
Hose - Lower - Rad. To Pipe		24240	Hose - Lower - Rad. To Pipe		21891
Hose - Lower - Pipe To Pipe		24240	Hose - Lower - Pipe To Pipe		24240
Detroit Diesel 6-Cyl. 14.0 L Diesel			4900SA		
4900FA			Belt - Fan		
Belt - Fan	0124894002	♣K100675HD	Belt - Fan	0124894002	♣K100675HD
Belt - Hub, Alt. & A.C.	0124587004	♣K080565HD	Belt - Hub, Alt. & A.C.	0124587004	♣K080565HD
Tensioner Assy. - Fan	0127846000	38503	Tensioner Assy. - Fan	0127846000	38503
Tensioner Assy. - Hub, Alt. & A.C.	0127425000	38501	Tensioner Assy. - Hub, Alt. & A.C.	0127425000	38501
Tensioner Pulley - Fan	0127846000	38076	Tensioner Pulley - Fan	0127846000	38076
Tensioner Pulley - Hub, Alt. & A.C.	0127425000	38075	Tensioner Pulley - Hub, Alt. & A.C.	0127425000	38075
Hose - Upper - Eng. To Pipe		24240	Hose - Upper - Eng. To Pipe		24240
Hose - Upper - Rad. To Pipe		24240	Hose - Upper - Rad. To Pipe		24240
Hose - Lower - Eng. To Pipe		24240	Hose - Lower - Eng. To Pipe		24240
Hose - Lower - Rad. To Pipe		21891	Hose - Lower - Rad. To Pipe		24240
Hose - Lower - Pipe To Pipe		24240	Hose - Lower - Rad. To Pipe		24240
4900SA			Detroit Diesel 6-Cyl. 14.0 L Diesel		
4900EX; 4900FA			4900EX; 4900FA		
Belt - Fan	0124894002	♣K100675HD	Belt - Fan	0124894002	♣K100675HD
Belt - Hub, Alt. & A.C.	0124587004	♣K080565HD	Belt - Hub, Alt. & A.C.	0124587004	♣K080565HD
Tensioner Assy. - Fan	0127846000	38503	Tensioner Assy. - Fan	0127846000	38503
Tensioner Assy. - Hub, Alt. & A.C.	0127425000	38501	Tensioner Assy. - Hub, Alt. & A.C.	0127425000	38501
Tensioner Pulley - Fan	0127846000	38076	Tensioner Pulley - Fan	0127846000	38076
Tensioner Pulley - Hub, Alt. & A.C.	0127425000	38075	Tensioner Pulley - Hub, Alt. & A.C.	0127425000	38075
Hose - Upper - Eng. To Pipe		24240	Hose - Upper - Eng. To Pipe		24240
Hose - Upper - Rad. To Pipe		24240	Hose - Upper - Rad. To Pipe		24240
Hose - Lower - Eng. To Pipe		24240	Hose - Lower - Eng. To Pipe		24240
Hose - Lower - Rad. To Pipe		24240	Hose - Lower - Rad. To Pipe		24240
Hose - Lower - Pipe To Pipe		24240	Hose - Lower - Pipe To Pipe		24240

♣Standard Belt Available.

Belts and Coolant Hose for Medium/Heavy-Duty Trucks (2001 & Newer)

Application	Mfr. Part No.	Our No.	Application	Mfr. Part No.	Our No.
Western Star - Continued			Western Star - Continued		
2006 - Continued			2005 - Continued		
Detroit Diesel 6-Cyl. 14.0 L Diesel - Continued			Detroit Diesel 6-Cyl. 12.7 L Diesel - Continued		
4900EX; 4900FA - Continued			4900EX; 4900FA - Continued		
Hose - Upper - Rad. To Pipe		24240	Hose - Lower - Pipe To Pipe		24240
Hose - Lower - Eng. To Pipe		24240	4900SA		
Hose - Lower - Rad. To Pipe		21891	Belt - Fan	0124894002	♣K100675HD
Hose - Lower - Pipe To Pipe		24240	Belt - Hub, Alt. & A.C.	0124587004	♣K080565HD
4900SA			Tensioner Assy. - Fan	0127846000	38503
Belt - Fan	0124894002	♣K100675HD	Tensioner Assy. - Hub, Alt. & A.C.	0127425000	38501
Belt - Hub, Alt. & A.C.	0124587004	♣K080565HD	Tensioner Pulley - Fan	0127846000	38076
Tensioner Assy. - Fan	0127846000	38503	Tensioner Pulley - Hub, Alt. & A.C.	0127425000	38075
Tensioner Assy. - Hub, Alt. & A.C.	0127425000	38501	Hose - Upper - Eng. To Pipe		24240
Tensioner Pulley - Fan	0127846000	38076	Hose - Upper - Rad. To Pipe		24240
Tensioner Pulley - Hub, Alt. & A.C.	0127425000	38075	Hose - Lower - Eng. To Pipe		24240
Hose - Upper - Eng. To Pipe		24240	Hose - Lower - Rad. To Pipe		24240
Hose - Upper - Rad. To Pipe		24240			
Hose - Lower - Eng. To Pipe		24240	Detroit Diesel 6-Cyl. 14.0 L Diesel		
Hose - Lower - Rad. To Pipe		24240	4900EX; 4900FA		
			Belt - Fan	0124894002	♣K100675HD
Mercedes-Benz MBE 4000 Diesel			Belt - Hub, Alt. & A.C.	0124587004	♣K080565HD
4900FA; 4900SA			Tensioner Assy. - Fan	0127846000	38503
Belt - Fan	0127116010	♣K080649HD	Tensioner Assy. - Hub, Alt. & A.C.	0127425000	38501
Belt - W.P., Alt. & A.C.	0127116004	♣K080855HD	Tensioner Pulley - Fan	0127846000	38076
Tensioner Assy. - Fan	0127427001	38597	Tensioner Pulley - Hub, Alt. & A.C.	0127425000	38075
Tensioner Assy. - Hub, Alt. & A.C.	0127425000	38501	Hose - Upper - Eng. To Pipe		24240
Tensioner Pulley - Hub, Alt. & A.C.	0127425000	38075	Hose - Upper - Rad. To Pipe		21135
Hose - Upper - Eng. To Pipe		21135	Hose - Lower - Eng. To Pipe		24240
Hose - Lower - Eng. To Pipe		24240	Hose - Lower - Rad. To Pipe		21891
Hose - Lower - Rad. To Pipe		21135	Hose - Lower - Pipe To Pipe		24240
Hose - Lower - Pipe To Pipe		24240	4900SA		
			Belt - Fan	0124894002	♣K100675HD
2005			Belt - Hub, Alt. & A.C.	0124587004	♣K080565HD
Caterpillar C13 Diesel			Tensioner Assy. - Fan	0127846000	38503
4900FA; 4900SA			Tensioner Assy. - Hub, Alt. & A.C.	0127425000	38501
Belt - Fan, Alt. & A.C.	0127110058	♣K081088HD	Tensioner Pulley - Fan	0127846000	38076
Tensioner Assy. - Fan, Alt. & A.C.	2117895	38590	Tensioner Pulley - Hub, Alt. & A.C.	0127425000	38075
Tensioner Pulley - Fan, Alt. & A.C.	2117895	36164	Hose - Upper - Eng. To Pipe		24240
Idler Pulley - Smooth	2078118	36269	Hose - Upper - Rad. To Pipe		24240
Idler Pulley - Grooved	1979642	36341	Hose - Lower - Eng. To Pipe		24240
			Hose - Lower - Rad. To Pipe		24240
Caterpillar C15 Diesel			Mercedes-Benz MBE 4000 Diesel		
4900EX; 4900FA; 4900SA			4900FA; 4900SA		
Belt - Fan & Alt.	0123415073	♣K081088HD	Belt - Fan	0127116010	♣K080649HD
Belt - Fan To A.C.	0127177007	♣K060547HD	Belt - W.P., Alt. & A.C.	0127116004	♣K080855HD
Tensioner Assy. - Fan & Alt.	2002279	38569	Tensioner Assy. - Fan	0127427001	38597
Tensioner Assy. - Fan To A.C.	2178938	38511	Tensioner Assy. - Hub, Alt. & A.C.	0127425000	38501
Idler Pulley - Smooth	1979641	36091	Tensioner Pulley - Hub, Alt. & A.C.	0127425000	38075
Idler Pulley - Grooved	1979642	36341	Hose - Upper - Eng. To Pipe		21135
Tensioner Pulley - Fan To A.C.	2178938	36091	Hose - Lower - Eng. To Pipe		24240
Hose - Upper - Eng. To Pipe		24240	Hose - Lower - Rad. To Pipe		21135
Hose - Upper - Rad. To Pipe		24240	Hose - Lower - Pipe To Pipe		24240
Hose - Lower - Eng. To Pipe		24240			
Hose - Lower - Rad. To Pipe		24240	2004		
6900XD			Caterpillar C12 Diesel		
Idler Pulley - Smooth	1979641	36091	4900FA		
Idler Pulley - Grooved	1979642	36341	Belt - Fan & Alt.	208043494785	♣K080785HD
			Tensioner Assy. - Fan & Alt.	1333545	38506
Detroit Diesel 6-Cyl. 12.7 L Diesel			Caterpillar C13 Diesel		
4900EX; 4900FA			4900SA		
Belt - Fan	0124894002	♣K100675HD	Belt - Fan, Alt. & A.C.	0123415073	♣K081088HD
Belt - Hub, Alt. & A.C.	0124587004	♣K080565HD	Tensioner Assy. - Fan, Alt. & A.C.	2117895	38590
Tensioner Assy. - Fan	0127846000	38503	Tensioner Pulley - Fan, Alt. & A.C.	2117895	36164
Tensioner Assy. - Hub, Alt. & A.C.	0127425000	38501	Idler Pulley - Accessory Drive (Smooth)	2078118	36269
Tensioner Pulley - Fan	0127846000	38076	Idler Pulley - Accessory Drive (Grooved)	1979642	36341
Tensioner Pulley - Hub, Alt. & A.C.	0127425000	38075			
Hose - Upper - Eng. To Pipe		24240			
Hose - Upper - Rad. To Pipe		21135			
Hose - Lower - Eng. To Pipe		24240			
Hose - Lower - Rad. To Pipe		21891			

♣Standard Belt Available.

Medium & Heavy-Duty Trucks
(2001 & Newer)

Belts and Coolant Hose for Medium/Heavy-Duty Trucks (2001 & Newer)

Medium & Heavy-Duty Trucks
(2001 & Newer)

Application	Mfr. Part No.	Our No.
Western Star - Continued		
2004 - Continued		
Caterpillar C15 Diesel		
4900EX; 4900FA; 4900SA		
Belt - Fan & Alt.; W/Clean Air Pkg.	0123415073	♣K081088HD
Belt - Fan To A.C.; W/Clean Air Pkg.	0127177007	♣K060547HD
Belt - Fan; W/O Clean Air Pkg.	208043503624	②TR22625
Belt - Fan To Alt. & A.C.; W/O Clean Air Pkg.	208043502551	②♣9550HD
Tensioner Assy. - Fan & Alt.; W/Clean Air Pkg.	2002279	38569
Tensioner Assy. - Fan To A.C.; W/Clean Air Pkg.	2178938	38511
Idler Pulley - Smooth	1979641	36091
Idler Pulley - Grooved	1979642	36341
Tensioner Pulley - Fan To A.C.; W/Clean Air Pkg.	2178938	36091
Hose - Upper - Eng. To Pipe		21891
Hose - Upper - Pipe To Rad.		21135
Hose - Lower - Eng. To Pipe		24248
Hose - Lower - Pipe To Rad.		21891
Hose - Lower - Pipe To Pipe		24240
Detroit Diesel 6-Cyl. 12.7 L Diesel		
4900EX; 4900FA; 4900SA		
Belt - Fan	0124894002	♣K100675HD
Belt - Hub, Alt. & A.C.	0124587004	♣K080565HD
Tensioner Assy. - Fan	0127846000	38503
Tensioner Assy. - Hub, Alt. & A.C.	0127425000	38501
Tensioner Pulley - Fan	0127846000	38076
Tensioner Pulley - Hub, Alt. & A.C.	0127425000	38075
Hose - Upper - Eng. To Pipe		24240
Hose - Upper - Rad. To Pipe		21135
Hose - Lower - Eng. To Pipe		24240
Hose - Lower - Rad. To Pipe		21891
Hose - Lower - Pipe To Pipe		24240
Detroit Diesel 6-Cyl. 14.0 L Diesel		
4900EX; 4900FA; 4900SA		
Belt - Fan	0124894002	♣K100675HD
Belt - Hub, Alt. & A.C.	0124587004	♣K080565HD
Tensioner Assy. - Fan	0127846000	38503
Tensioner Assy. - Hub, Alt. & A.C.	0127425000	38501
Tensioner Pulley - Fan	0127846000	38076
Tensioner Pulley - Hub, Alt. & A.C.	0127425000	38075
Hose - Upper - Eng. To Pipe		24240
Hose - Upper - Rad. To Pipe		21135
Hose - Lower - Eng. To Pipe		24240
Hose - Lower - Rad. To Pipe		21891
Hose - Lower - Pipe To Pipe		24240
Mercedes-Benz MBE 4000 Diesel		
4900EX; 4900FA; 4900SA		
Belt - Fan	0127116010	♣K080649HD
Belt - Hub, Alt. & A.C.	0127116004	♣K080855HD
Tensioner Assy. - Fan	0127427001	38597
Tensioner Assy. - Hub, Alt. & A.C.	0127425000	38501
Tensioner Pulley - Hub, Alt. & A.C.	0127425000	38075
Hose - Upper - Cap To Eng.		21135
Hose - Upper - Rad. To Pipe		21135
2003		
Caterpillar 3406 Diesel		
4900EX; 4900FA; 4900SA		
Belt - Fan	208043503624	②TR22625
Belt - Fan, Alt. & A.C.	208043502551	②♣9550HD
Hose - Upper - Eng. To Pipe		24240
Hose - Upper - Pipe To Rad.		24240
Hose - Lower - Eng. To Pipe		24248
Hose - Lower - Pipe To Rad.		24248

♣Standard Belt Available.

Application	Mfr. Part No.	Our No.
Western Star - Continued		
2003 - Continued		
Caterpillar C15 Diesel		
4900EX; 4900FA; 4900SA		
Belt - Fan & Alt.; W/Clean Air Pkg.	0123415073	♣K081088HD
Belt - Fan To A.C.; W/Clean Air Pkg.	0127177007	♣K060547HD
Belt - Fan; W/O Clean Air Pkg.	208043503624	②TR22625
Belt - Fan To Alt. & A.C.; W/O Clean Air Pkg.	208043502551	②♣9550HD
Tensioner Assy. - Fan & Alt.; W/Clean Air Pkg.	2002279	38569
Tensioner Assy. - Fan To A.C.; W/Clean Air Pkg.	2178938	38511
Tensioner Pulley - Fan To A.C.; W/Clean Air Pkg.	2178938	36091
Hose - Upper - Eng. To Pipe		21891
Hose - Upper - Pipe To Rad.		21135
Hose - Lower - Eng. To Pipe		24248
Hose - Lower - Pipe To Rad.		21891
Hose - Lower - Pipe To Pipe		24240
Caterpillar C16 Diesel		
4900EX		
Belt - Fan	208043503624	②TR20619
Belt - Fan To Alt. & A.C.	208043502551	②♣9550HD
Hose - Upper - Eng. To Pipe		21891
Hose - Upper - Pipe To Rad.		21135
Hose - Lower - Eng. To Pipe		24248
Hose - Lower - Pipe To Rad.		21891
Hose - Lower - Pipe To Pipe		24240
4900FA; 4900SA		
Belt - Fan	208043503624	②TR22625
Belt - Fan To Alt. & A.C.	208043502551	②♣9550HD
Hose - Upper - Eng. To Pipe		21891
Hose - Upper - Pipe To Rad.		21135
Hose - Lower - Eng. To Pipe		24248
Hose - Lower - Pipe To Rad.		21891
Hose - Lower - Pipe To Pipe		24240
Cummins ISX Diesel		
4900EX		
Belt - Fan	3681822	♣K100810HD
Belt - Hub, Alt. & A.C.	3681812	♣K060685HD
Tensioner Assy. - Fan	3681240	38535
Tensioner Assy. - Hub, Alt. & A.C.	3680194	38532
Tensioner Pulley - Fan	3681240	36092
Tensioner Pulley - Hub, Alt. & A.C.	3680194	36095
Idler Pulley - Alt. & A.C.	4026886	36226
Detroit Diesel 6-Cyl. 12.7 L Diesel		
4900EX; 4900FA; 4900SA		
Belt - Fan	0124894002	♣K100675HD
Belt - Hub, Alt. & A.C.	0124587004	♣K080565HD
Tensioner Assy. - Fan	0127846000	38503
Tensioner Assy. - Hub, Alt. & A.C.	0127425000	38501
Tensioner Pulley - Fan	0127846000	38076
Tensioner Pulley - Hub, Alt. & A.C.	0127425000	38075
Hose - Upper - Eng. To Pipe		24240
Hose - Upper - Rad. To Pipe		21135
Hose - Lower - Eng. To Pipe		24240
Hose - Lower - Rad. To Pipe		21891
Hose - Lower - Pipe To Pipe		24240
Detroit Diesel 6-Cyl. 14.0 L Diesel		
4900EX; 4900FA; 4900SA		
Belt - Fan	0124894002	♣K100675HD
Belt - Hub, Alt. & A.C.	0124587004	♣K080565HD
Tensioner Assy. - Fan	0127846000	38503
Tensioner Assy. - Hub, Alt. & A.C.	0127425000	38501
Tensioner Pulley - Fan	0127846000	38076
Tensioner Pulley - Hub, Alt. & A.C.	0127425000	38075

②Two Required.

Belts and Coolant Hose for Medium/Heavy-Duty Trucks (2001 & Newer)

Application	Mfr. Part No.	Our No.	Application	Mfr. Part No.	Our No.
Western Star - Continued			Western Star - Continued		
2003 - Continued			2002 - Continued		
Detroit Diesel 6-Cyl. 14.0 L Diesel - Continued			Caterpillar C15 Diesel - Continued		
4900EX; 4900FA; 4900SA - Continued			4900EX; 4900FA - Continued		
Hose - Upper - Eng. To Pipe		24240	Hose - Upper - Eng. To Pipe		21891
Hose - Upper - Rad. To Pipe		21135	Hose - Upper - Pipe To Rad.		21135
Hose - Lower - Eng. To Pipe		24240	Hose - Lower - Eng. To Pipe		24248
Hose - Lower - Rad. To Pipe		21891	Hose - Lower - Pipe To Rad.		21891
Hose - Lower - Pipe To Pipe		24240	Hose - Lower - Pipe To Pipe		24240
2002			4900SA		
Caterpillar 3406 Diesel			Belt - Fan		
4900 Series			Belt - Fan To Alt. & A.C.		
Belt - Fan	208043503624	②TR22625	Hose - Upper - Eng. To Pipe		24240
Belt - Fan, Alt. & A.C.	208043502551	②▲9550HD	Hose - Upper - Pipe To Rad.		24240
Hose - Upper - Eng. To Pipe		24240	Hose - Lower - Eng. To Pipe		24248
Hose - Upper - Pipe To Rad.		24240	Hose - Lower - Pipe To Rad.		21891
Hose - Lower - Eng. To Pipe		24248	Hose - Lower - Pipe To Pipe		24240
Hose - Lower - Pipe To Rad.		24248	Caterpillar C16 Diesel		
Caterpillar C10 Diesel			4900 Series		
4900SA			Belt - Fan		
Belt - Fan	5080760	▲K080760HD	Belt - Fan To Alt. & A.C.	208043502551	②▲9550HD
Belt - A.C.	17505	▲9505HD	Hose - Upper - Eng. To Pipe		21891
Tensorer Assy.	1333545	38506	Hose - Upper - Pipe To Rad.		21135
Tensorer Pulley		36091	Hose - Lower - Eng. To Pipe		24248
Hose - Upper - Eng. To Pipe		24440	Hose - Lower - Pipe To Rad.		21891
Hose - Upper - Pipe To Rad.		24440	Hose - Lower - Pipe To Pipe		24240
Hose - Lower - Eng. To Pipe		24440	4900SA		
Hose - Lower - Pipe To Rad.		24440	Belt - Fan		
Caterpillar C12 Diesel			Belt - Fan To Alt. & A.C.		
4900 Series			Hose - Upper - Eng. To Pipe		
Belt - Fan & Alt.	2080434	▲K080785HD	Hose - Upper - Pipe To Rad.		24240
Belt - Fan & A.C.	208043502505	▲9505HD	Hose - Lower - Eng. To Pipe		24248
Tensorer Assy. - Fan & Alt.	1333545	38506	Hose - Lower - Pipe To Rad.		21891
Tensorer Pulley - Fan & Alt.	1333545	36091	Hose - Lower - Pipe To Pipe		24240
Hose - Upper - Eng. To Pipe		24240	2001		
Hose - Upper - Pipe To Rad.		24240	Caterpillar 3126 Diesel		
Hose - Lower - Eng. To Pipe		24240	3700 Series		
Hose - Lower - Pipe To Rad.		24240	Belt - Fan, Alt. & A.C.		
5800 Series			Belt - W.P.		
Belt - Fan & Alt.	208043494785	▲K080785HD	Hose - Upper - Eng. To Pipe		
Belt - A.C.	208043502505	▲9505HD	Ⓢ<21194		
5900 Series			Caterpillar 3406 Diesel		
Belt - Fan, Alt. & A.C.	208043494785	▲K080785HD	4900 Series		
Tensorer Assy. - Fan, Alt. & A.C.	1333545	38506	Belt - Fan		
Tensorer Pulley - Fan, Alt. & A.C.	1333545	36091	Belt - Fan, Alt. & A.C.		
Caterpillar C15 Diesel			Hose - Upper - Eng. To Pipe		
4900 Series			Hose - Upper - Pipe To Rad.		
Belt - Fan	208043503624	②TR22625	Hose - Lower - Eng. To Pipe		
Belt - Fan To Alt. & A.C.	208043502551	②▲9550HD	Hose - Lower - Pipe To Rad.		
Hose - Upper - Eng. To Pipe		21891	Hose - Lower - Pipe To Pipe		
Hose - Upper - Pipe To Rad.		21135	4900EX; 4900FA		
Hose - Lower - Eng. To Pipe		24248	Belt - Fan & Alt.; W/Clean Air Pkg.		
Hose - Lower - Pipe To Rad.		21891	Belt - Fan To A.C.; W/Clean Air Pkg.		
Hose - Lower - Pipe To Pipe		24240	Belt - Fan; W/O Clean Air Pkg.		
4900EX; 4900FA			Belt - Fan To Alt. & A.C.; W/O Clean Air Pkg.		
Belt - Fan & Alt.; W/Clean Air Pkg.	0123415073	▲K081088HD	Pkg.		
Belt - Fan To A.C.; W/Clean Air Pkg.	0127177007	▲K060547HD	Tensorer Assy. - Fan & Alt.; W/Clean Air Pkg.		
Belt - Fan; W/O Clean Air Pkg.	208043503624	②TR22625	Pkg.		
Belt - Fan To Alt. & A.C.; W/O Clean Air Pkg.	208043502551	②▲9550HD	Tensorer Assy. - Fan To A.C.; W/Clean Air Pkg.		
Tensorer Assy. - Fan & Alt.; W/Clean Air Pkg.	2002279	38569	Tensorer Pulley - Fan To A.C.; W/Clean Air Pkg.		
Tensorer Assy. - Fan To A.C.; W/Clean Air Pkg.	2178938	38511	Tensorer Assy.		
Tensorer Pulley - Fan To A.C.; W/Clean Air Pkg.	2178938	36091	1333545		
			38506		

②Two Required.
Ⓢ<Cut to Fit.

▲Standard Belt Available.

Medium & Heavy-Duty Trucks
(2001 & Newer)

Belts and Coolant Hose for Medium/Heavy-Duty Trucks (2001 & Newer)

Medium & Heavy-Duty Trucks
(2001 & Newer)

Application	Mfr. Part No.	Our No.
Western Star - Continued		
2001 - Continued		
Caterpillar C12 Diesel - Continued		
4900 Series		
Belt - Fan & Alt.	2080434	♣K080785HD
Belt - Fan & A.C.	208043502505	♣9505HD
Tensioner Assy. - Fan & Alt.	1333545	38506
Tensioner Pulley - Fan & Alt.	1333545	36091
Hose - Upper - Eng. To Pipe		24240
Hose - Upper - Pipe To Rad.		24240
Hose - Lower - Eng. To Pipe		24240
Hose - Lower - Pipe To Rad.		24240
5800 Series		
Belt - Fan & Alt.	208043494785	♣K080785HD
Belt - A.C.	208043502505	♣9505HD
Caterpillar C15 Diesel		
4900 Series		
Belt - Fan	208043503624	ⓂTR22625
Belt - Fan, Alt. & A.C.	208043502551	♣9550HD
Hose - Upper - Eng. To Pipe		24240
Hose - Upper - Pipe To Rad.		24240
Hose - Lower - Eng. To Pipe		24248
Hose - Lower - Pipe To Rad.		24248
Caterpillar C16 Diesel		
4900 Series		
Belt - Fan	208043503624	ⓂTR22625
Belt - Fan, Alt. & A.C.	208043502551	♣9550HD
Hose - Upper - Eng. To Pipe		24240
Hose - Upper - Pipe To Rad.		24240
Hose - Lower - Eng. To Pipe		24248
Hose - Lower - Pipe To Rad.		24248
Cummins ISM Diesel		
4900 Series		
Belt - Fan & Alt.	3099259	♣K080785HD
Belt - A.C.	208043502534	♣9530HD
Tensioner Assy. - Fan & Alt.	3400885	38521
Idler Pulley - Fan & Alt.	3400884	36308
Hose - Upper - Eng. To Pipe		24240
Hose - Upper - Rad. To Pipe		24240
Hose - Lower - Eng. To Pipe		24240
Hose - Lower - Rad. To Pipe		24240
Cummins ISX Diesel		
4900 Series		
Belt - Fan	3681822	♣K100810HD
Belt - Hub, Alt. & A.C.	3681812	♣K060685HD
Tensioner Assy. - Fan	3681240	38535
Tensioner Assy. - Hub, Alt. & A.C.	3680194	38532
Tensioner Pulley - Fan	3681240	36092
Tensioner Pulley - Hub, Alt. & A.C.	3680194	36095
Idler Pulley - Alt. & A.C.	4026886	36226
Hose - Upper - Eng. To Pipe		24240
Hose - Upper - Pipe To Rad.		24240
Hose - Lower - Eng. To Pipe		24240
Hose - Lower - Pipe To Eng.		24240
Cummins N14 Diesel		
4900 Series		
Belt - Hub & W.P.		♣K060415HD
Belt - Fan & Hub	208043504513	ⓂTR28510
Belt - Hub & Alt.		♣9400HD
Belt - Hub & A.C.	208043501495	Ⓜ♣9495HD
Hose - Upper - Eng. To Pipe		24240
Hose - Upper - Pipe To Rad.		24240
Hose - Lower - Eng. To Pipe		24240
Hose - Lower - Pipe To Rad.		24240

♣Standard Belt Available.
ⓂThree Required.

Application	Mfr. Part No.	Our No.
Western Star - Continued		
2001 - Continued		
Cummins Signature 600 Diesel		
4900 Series		
Belt - Fan	3681822	♣K100810HD
Belt - Hub, Alt. & A.C.	3681812	♣K060685HD
Tensioner Assy. - Fan	3681240	38535
Tensioner Assy. - Hub, Alt. & A.C.	3680194	38532
Tensioner Pulley - Fan	3681240	36092
Tensioner Pulley - Hub, Alt. & A.C.	3680194	36095
Idler Pulley - Alt. & A.C.	4026886	36226
Hose - Upper - Eng. To Pipe		24240
Hose - Upper - Pipe To Rad.		24240
Hose - Lower - Eng. To Pipe		24240
Hose - Lower - Pipe To Eng.		24240
Detroit Diesel 6-Cyl. 11.1 L Diesel		
4900 Series		
Belt - Fan	208043502615	Ⓜ♣9620HD
Belt - Hub, Alt. & A.C.	23520615	♣K080580HD
Tensioner Assy. - Hub, Alt. & A.C.	23520317	38501
Tensioner Pulley - Hub, Alt. & A.C.		38075
Hose - Upper - Eng. To Pipe		24240
Hose - Upper - Pipe To Rad.		24240
Hose - Lower - Eng. To Pipe		24240
Hose - Lower - Pipe To Rad.		24240
Detroit Diesel 6-Cyl. 12.7 L Diesel		
4900 Series		
Belt - Fan	208043502615	Ⓜ♣9620HD
Belt - Hub, Alt. & A.C.	23520615	♣K080580HD
Tensioner Assy. - Hub, Alt. & A.C.	23520317	38501
Tensioner Pulley - Hub, Alt. & A.C.		38075
Hose - Upper - Eng. To Pipe		24240
Hose - Upper - Pipe To Rad.		24240
Hose - Lower - Eng. To Pipe		24240
Hose - Lower - Pipe To Rad.		24240
Workhorse		
2008		
GM V-8 4.8 L		
W42		
Belt - Serpentine; W/145A. Alt.	12576753	K060986
Belt - A.C.	12576447	♣K040378HD
Tensioner Assy. - Serpentine	12580162	38158
Tensioner Assy. - A.C.	12565372	38159
Tensioner Pulley - Serpentine	12580162	38009
Tensioner Pulley - A.C.	12565372	36169
Idler Pulley	12580771	36299
Hose - Upper		23184
Hose - Heater To Valve; Cut at 36"		28411
Hose - Valve To Thermostat; Cut at 60"		28411
Hose - Thermostat To Heater; Cut at 60"		28411
Hose - Rad. To Reducer; Cut at 12"		28411
Hose - Reducer To Throttle Body; Cut at 20"		28409
Hose - Rad. To Reservoir; Cut at 20"		28409
2007		
GM V-8 4.8 L		
W42		
Belt - Serpentine; W/145A. Alt.	12576753	K060986
Belt - A.C.	12576447	♣K040378HD
Tensioner Assy. - Serpentine	12580162	38158
Tensioner Assy. - A.C.	12565372	38159
Tensioner Pulley - Serpentine	12580162	38009
Tensioner Pulley - A.C.	12565372	36169
Idler Pulley	12580771	36299
Hose - Upper		23184
Hose - Heater To Valve; Cut at 36"		28411

ⓂTwo Required.

Belts and Coolant Hose for Medium/Heavy-Duty Trucks (2001 & Newer)

Application	Mfr. Part No.	Our No.	Application	Mfr. Part No.	Our No.
Workhorse - Continued			Workhorse - Continued		
2007 - Continued			2006 - Continued		
GM V-8 4.8 L - Continued			International/Navistar VT275 Diesel		
W42 - Continued			P Series		
Hose - Valve To Thermostat; Cut at 60"		28411	Belt - Fan, Alt., P.S. & A.C.	1846055C1	♣K081331HD
Hose - Thermostat To Heater; Cut at 60"		28411	Tensioner Assy.	1844538C1	38257
Hose - Rad. To Reducer; Cut at 12"		28411	2005		
Hose - Reducer To Throttle Body; Cut at 20"		28409	Cummins B Series 3.9 L Diesel		
Hose - Rad. To Reservoir; Cut at 20"		28409	P Series		
International/Navistar MaxxForce 5 Diesel			Belt - Fan, W.P. & Alt.		
W42; W62				3289257	♣K080694HD
Belt - Fan, Alt., P.S. & A.C.	1848715C1	♣K081331HD	Hose - Lower		22237
Tensioner Assy.	1844538C1	38257	GM V-8 4.8 L		
Hose - Lower - Connector To Eng.		21571	P Series		
Hose - Heater To Valve; Cut at 30"		28411	Belt - Fan, Alt. & P.S.		
Hose - Valve To Eng.; Cut at 72"		28411		W0002987	♣K060935HD
Hose - Connector To Heater; Cut at 12"		28442	Belt - A.C.	12576447	♣K040378HD
Hose - Connector To Eng.; Cut at 36"		28442	Tensioner Assy. - Fan & Alt.	12580162	38158
Hose - Reservoir To Connector; Cut at 3"		28409	Tensioner Assy. - A.C.	12580196	38159
2006			Tensioner Pulley - Fan & Alt.	12580162	38009
GM V-8 4.8 L			Tensioner Pulley - A.C.	12580196	36169
P Series			Idler Pulley	12580771	36299
Belt - Serpentine; W/145A. Alt.	12576753	K060986	Hose - Upper - Eng. To Rad.		22436
Belt - A.C.	12576447	♣K040378HD	Hose - Lower - Eng. To Rad.		22437
Tensioner Assy. - Serpentine	12580162	38158	GM V-8 6.0 L		
Tensioner Assy. - A.C.	12565372	38159	P Series		
Tensioner Pulley - Serpentine	12580162	38009	Belt - Fan, Alt. & P.S.		
Tensioner Pulley - A.C.	12565372	36169		W0002987	♣K060935HD
Idler Pulley	12580771	36299	Belt - A.C.	12576447	♣K040378HD
Hose - Upper		22436	Tensioner Assy. - Fan & Alt.	12580162	38158
Hose - Lower		22437	Tensioner Assy. - A.C.	12580196	38159
Hose - Heater To Connector; Cut at 24"		28411	Tensioner Pulley - Fan & Alt.	12580162	38009
Hose - Connector To Thermostat; Cut at 40"		28411	Tensioner Pulley - A.C.	12580196	36169
Hose - Thermostat To Heater; Cut at 60"		28411	Idler Pulley	12580771	36299
Hose - Connector To Heater		28466	Hose - Upper - Rad. To Eng.		22436
Hose - Rad. To Reducer; Cut at 12"		28411	Hose - Lower - Eng. To Rad.		22437
Hose - Reducer To Throttle Body; Cut at 20"		28409	GM V-8 8.1 L		
Hose - Throttle Body To Eng.		18623	P Series		
Hose - Rad. To Reservoir; Cut at 20"		28409	Belt - Serpentine; W/A.C.		
GM V-8 6.0 L				W0000581	♣K061080HD
P Series			Belt - Serpentine; W/O A.C.	12563076	♣K060994HD
Belt - Fan, Alt. & P.S.		♣K060988HD	Tensioner Assy.; W/A.C.	12561094	38103
Belt - A.C.	12576447	♣K040378HD	Tensioner Assy.; W/O A.C.	12581203	38258
Tensioner Assy. - Fan & Alt.	12580162	38158	Tensioner Pulley; W/A.C.	12561094	38008
Tensioner Assy. - A.C.	12580196	38159	Tensioner Pulley; W/O A.C.	12581203	38006
Tensioner Pulley - Fan & Alt.	12580162	38009	Idler Pulley - Smooth; W/A.C.	12555609	36299
Tensioner Pulley - A.C.	12580196	36169	Idler Pulley - Grooved; W/O A.C.	10239930	38008
Idler Pulley	12580771	36299	Hose - Upper		23803
Hose - Upper - Rad. To Eng.		22436	Hose - Lower		21442
Hose - Lower - Eng. To Rad.		22437	Hose - By Pass		19802
GM V-8 8.1 L			2004		
P Series			Cummins B Series 3.9 L Diesel		
Belt - Serpentine; W/A.C.	W0000581	♣K061080HD	P Series		
Belt - Serpentine; W/O A.C.	12563076	♣K060994HD	Belt - Fan, W.P. & Alt.		
Tensioner Assy.; W/A.C.	12561094	38103		3289257	♣K080694HD
Tensioner Assy.; W/O A.C.	12581203	38258	Hose - Lower		22237
Tensioner Pulley; W/A.C.	12561094	38008	GM V-8 4.8 L		
Tensioner Pulley; W/O A.C.	12581203	38006	P Series		
Idler Pulley - Smooth; W/A.C.	12555609	36299	Belt - Fan, Alt. & P.S.		
Idler Pulley - Grooved; W/O A.C.	10239930	38008		W0002987	♣K060935HD
Hose - Upper		23803	Belt - A.C.	12576447	♣K040378HD
Hose - Lower		21442	Tensioner Assy. - Fan & Alt.	12580162	38158
Hose - By Pass		19802	Tensioner Assy. - A.C.	12580196	38159
GM V-8 8.1 L			Tensioner Pulley - Fan & Alt.	12580162	38009
P Series			Tensioner Pulley - A.C.	12580196	36169
Belt - Serpentine; W/A.C.	W0000581	♣K061080HD	Idler Pulley	12580771	36299
Belt - Serpentine; W/O A.C.	12563076	♣K060994HD	Hose - Upper - Eng. To Rad.		22436
Tensioner Assy.; W/A.C.	12561094	38103	Hose - Lower - Eng. To Rad.		22437
Tensioner Assy.; W/O A.C.	12581203	38258	2004		
Tensioner Pulley; W/A.C.	12561094	38008	Cummins B Series 3.9 L Diesel		
Tensioner Pulley; W/O A.C.	12581203	38006	P Series		
Idler Pulley - Smooth; W/A.C.	12555609	36299	Belt - Fan, W.P. & Alt.		
Idler Pulley - Grooved; W/O A.C.	10239930	38008		3289257	♣K080694HD
Hose - Upper		23803	Hose - Lower		22237
Hose - Lower		21442	GM V-8 4.8 L		
Hose - By Pass		19802	P Series		

♣Standard Belt Available.

Medium & Heavy-Duty Trucks
(2001 & Newer)

Belts and Coolant Hose for Medium/Heavy-Duty Trucks (2001 & Newer)

Medium & Heavy-Duty Trucks
(2001 & Newer)

Application	Mfr. Part No.	Our No.	Application	Mfr. Part No.	Our No.
Workhorse - Continued			Workhorse - Continued		
2004 - Continued			2003 - Continued		
GM V-8 5.7 L			GM V-8 6.5 L Diesel - Continued		
P Series			P Series - Continued		
Belt - Fan, Alt. & P.S.; W/200A. Alt.	12564760	♣K060875HD	Hose - Upper		22268
Tensioner Assy. - Fan, Alt. & P.S.	12580296	38103	Hose - Lower		22237
Hose - Upper - Eng. To Rad.		22266	Hose - By Pass		22210
Hose - Lower - Eng. To Rad.		20843	Hose - Heater To Valve; W/Grumman Body; Cut at 36"		28411
Hose - By Pass		19025	Hose - Valve To Eng.; W/Grumman Body; Cut at 32"		28412
Hose - Heater To Connector		20605	Hose - Rad. To Connector; W/Grumman Body; Cut at 9" .		28412
Hose - Connector To W.P.; Cut at 38"		28411	Hose - Connector To Valve; W/Grumman Body; Cut at 11"		28412
Hose - Eng. To Valve; Cut at 28"		28411	Hose - Valve To Heater; W/Grumman Body; Cut at 36"		28411
Hose - Valve To Heater		20605	Hose - Rad. To Reservoir		28465
Hose - Rad. To Reservoir; Cut at 20"		28409			
GM V-8 6.5 L Diesel			GM V-8 8.1 L		
P Series			P Series		
Belt - Serpentine; W/O A.C.; W/105A. Alt. ...	12555009	♣K061010HD	Belt - Serpentine; W/A.C.	W0000581	♣K061080HD
Belt - Serpentine; W/O A.C.; W/145A. Alt. ...	12556338	♣K061020HD	Belt - Serpentine; W/O A.C.	12563076	♣K060994HD
Tensioner Assy.	12561092	38118	Tensioner Assy.; W/A.C.	12561094	38103
Tensioner Pulley	12561092	38006	Tensioner Assy.; W/O A.C.	12581203	38258
Idler Pulley - Grooved; W/O A.C.	14102597	36177	Tensioner Pulley; W/A.C.	12561094	38008
Hose - Upper		22268	Tensioner Pulley; W/O A.C.	12581203	38006
Hose - Lower		22237	Idler Pulley - Smooth; W/A.C.	12555609	36299
Hose - By Pass		22210	Idler Pulley - Grooved; W/O A.C.	10239930	38008
Hose - Heater To Valve; W/Union City Body; Cut at 36"		28411	Hose - Upper		23803
Hose - Valve To Eng.; W/Union City Body; Cut at 22"		28411	Hose - Lower		21442
Hose - Rad. To Valve; W/Union City Body; Cut at 18"		28412	Hose - By Pass		19802
Hose - Valve To Heater; W/Union City Body; Cut at 36" ...		28411			
Hose - Rad. To Reservoir		28465	W22		
			Belt - Serpentine; W/A.C.	W0000581	♣K061080HD
			Belt - Serpentine; W/O A.C.	12563076	♣K060994HD
			Tensioner Assy.; W/A.C.	12561094	38103
			Tensioner Assy.; W/O A.C.	12581203	38258
			Hose - Upper		23803
			Hose - Lower		21442
			Hose - By Pass		19802
GM V-8 8.1 L			2002		
P Series			GM V-6 4.3 L		
Belt - Serpentine; W/A.C.	W0000581	♣K061080HD	P Series		
Belt - Serpentine; W/O A.C.	12563076	♣K060994HD	Belt - Serpentine; W/A.C.; W/105A. Alt.		K060966
Tensioner Assy.; W/A.C.	12561094	38103	Belt - Serpentine; W/O A.C.; W/105A. Alt.		♣K060870HD
Tensioner Assy.; W/O A.C.	12581203	38258	Tensioner Assy.		38103
Tensioner Pulley; W/A.C.	12561094	38008	Tensioner Pulley		38008
Tensioner Pulley; W/O A.C.	12581203	38006	Idler Pulley - Smooth		38001
Idler Pulley - Smooth; W/A.C.	12555609	36299	Idler Pulley - Grooved; W/O A.C.		38008
Idler Pulley - Grooved; W/O A.C.	10239930	38008	Hose - Upper		22266
Hose - Upper		23803	Hose - Lower		22169
Hose - Lower		21442	Hose - By Pass		19025
Hose - By Pass		19802	Hose - Heater To Reducer; Cut at 13"		28412
			Hose - Reducer To W.P.; Cut at 38"		28411
			Hose - Eng. To Valve; Cut at 28"		28411
			Hose - Valve To Heater; Cut at 17"		28411
			Hose - Rad. To Reservoir; Cut at 20"		28409
2003			GM V-8 5.7 L		
GM V-8 5.7 L			P Series		
P Series			P Series		
Belt - Serpentine; W/A.C.; W/105A. Alt.	12564763	♣K060960HD	Belt - Fan, Alt., P.S. & A.C.	12564764	K060966
Belt - Serpentine; W/O A.C.; W/105A. Alt. ...	12564759	♣K060870HD	Belt - Fan, Alt. & P.S.	12564759	♣K060870HD
Tensioner Assy.	12561094	38103	Tensioner Assy. - Fan, Alt. & P.S.	12561094	38103
Tensioner Pulley	12561094	38008	Idler Pulley - Smooth		38001
Idler Pulley - Smooth	12557819	38001	Idler Pulley - Grooved; W/O A.C.		38008
Idler Pulley - Grooved; W/O A.C.	10239930	38008	Hose - Upper		22266
Hose - Upper		22266	Hose - Lower		20843
Hose - Lower		20843	Hose - By Pass		19025
Hose - By Pass		19025	Hose - Heater To Connector		20605
Hose - Heater To Connector		20605	Hose - Connector To W.P.; Cut at 38"		28411
Hose - Connector To W.P.; Cut at 38"		28411	Hose - Eng. To Valve; Cut at 28"		28411
Hose - Eng. To Valve; Cut at 28"		28411	Hose - Valve To Heater		20605
Hose - Valve To Heater		20605	Hose - Rad. To Reservoir; Cut at 20"		28409
Hose - Rad. To Reservoir; Cut at 20"		28409			
GM V-8 6.5 L Diesel			GM V-8 5.7 L		
P Series			P Series		
Belt - Serpentine; W/O A.C.; W/105A. Alt. ...	12555009	♣K061010HD	Belt - Fan, Alt., P.S. & A.C.	12564764	K060966
Belt - Serpentine; W/O A.C.; W/145A. Alt. ...	12556338	♣K061020HD	Belt - Fan, Alt. & P.S.	12564759	♣K060870HD
Tensioner Assy.	12561092	38118	Tensioner Assy. - Fan, Alt. & P.S.	12561094	38103
Tensioner Pulley	12561092	38006	Idler Pulley - Smooth		38001
Idler Pulley - Grooved; W/O A.C.	14102597	36177	Idler Pulley - Grooved; W/O A.C.		38008
			Hose - Upper		22266
			Hose - Lower		20843
			Hose - By Pass		19025
			Hose - Heater To Reducer; Cut at 13"		28412
			Hose - Reducer To W.P.; Cut at 38"		28411
			Hose - Eng. To Valve; Cut at 28"		28411
			Hose - Valve To Heater; Cut at 17"		28411
			Hose - Rad. To Reservoir; Cut at 20"		28409

♣Standard Belt Available.

Belts and Coolant Hose for Medium/Heavy-Duty Trucks (2001 & Newer)

Application	Mfr. Part No.	Our No.	Application	Mfr. Part No.	Our No.
Workhorse - Continued			Workhorse - Continued		
2002 - Continued			2001 - Continued		
GM V-8 6.5 L Diesel			GM V-8 5.7 L - Continued		
P Series			P Series - Continued		
Belt - Serpentine; W/O A.C.; W/105A. Alt. ..	12555009	♣K061010HD	Idler Pulley - Grooved; W/O A.C.		38008
Belt - Serpentine; W/O A.C.; W/145A. Alt. ..	12556338	♣K061020HD	Hose - Upper		22266
Tensioner Assy.	12561092	38118	Hose - Lower		20843
Tensioner Pulley	12561092	38006	Hose - By Pass		19025
Idler Pulley - Grooved; W/O A.C.	14102597	36177	Hose - Heater To Valve; W/Grumman Body; Cut at 6"		28411
Hose - Upper		22268	Hose - Valve To Eng.; W/Grumman Body; Cut at 22"		28411
Hose - Lower		22237	Hose - W.P. To Heater; W/Grumman Body; Cut at 41"		28411
Hose - By Pass		22210	Hose - Heater To Reducer; W/Workhorse Body; Cut at 13"		28412
Hose - Heater To Valve; W/Grumman Body; Cut at 36"		28411	Hose - Reducer To W.P.; W/Workhorse Body; Cut at 38"		28411
Hose - Valve To Eng.; W/Grumman Body; Cut at 32"		28412	Hose - Eng. To Valve; W/Workhorse Body; Cut at 28"		28411
Hose - Rad. To Connector; W/Grumman Body; Cut at 9"		28412	Hose - Valve To Heater; W/Workhorse Body; Cut at 17"		28411
Hose - Connector To Valve; W/Grumman Body; Cut at 11"		28412	Hose - Rad. To Reservoir; Cut at 20"		28409
Hose - Valve To Heater; W/Grumman Body; Cut at 36"		28411			
Hose - Rad. To Reservoir		28465			
GM V-8 7.4 L			GM V-8 6.5 L Diesel		
P Series			P Series		
Belt - Serpentine; W/A.C.; W/124A., 145A. Alt.		♣K061000HD	Belt - Serpentine; W/O A.C.; W/105A. Alt. ..	12555009	♣K061010HD
Belt - Serpentine; W/O A.C.; W/124A., 145A. Alt.		K060919	Belt - Serpentine; W/O A.C.; W/145A. Alt. ..	12556338	♣K061020HD
Tensioner Assy.		38103	Tensioner Assy.	12561092	38118
Tensioner Pulley		38008	Tensioner Pulley	12561092	38006
Idler Pulley - Smooth		38001	Idler Pulley - Grooved; W/O A.C.	14102597	36177
Idler Pulley - Grooved; W/O A.C.		38008	Hose - Upper		22268
Hose - Upper		22265	Hose - Lower		22237
Hose - Lower		21442	Hose - By Pass		22210
Hose - By Pass		♣19670	Hose - Heater To Valve; W/Grumman Body; Cut at 36"		28411
			Hose - Valve To Eng.; W/Grumman Body; Cut at 32"		28411
			Hose - Rad. To Connector; W/Grumman Body; Cut at 9"		28412
			Hose - Connector To Valve; W/Grumman Body; Cut at 11"		28412
			Hose - Valve To Heater; W/Grumman Body; Cut at 36"		28411
			Hose - Rad. To Reservoir		28465
GM V-8 8.1 L			GM V-8 7.4 L		
P Series			P Series		
Belt - Serpentine; W/A.C.	W0000581	♣K061080HD	Belt - Serpentine; W/A.C.; W/124A., 145A. Alt.		♣K061000HD
Belt - Serpentine; W/O A.C.	12563076	♣K060994HD	Belt - Serpentine; W/O A.C.; W/124A., 145A. Alt.		K060919
Tensioner Assy.; W/A.C.	12561094	38103	Tensioner Assy.		38103
Tensioner Assy.; W/O A.C.	12581203	38258	Tensioner Pulley		38008
Tensioner Pulley; W/A.C.	12561094	38008	Idler Pulley - Smooth		38001
Tensioner Pulley; W/O A.C.	12581203	38006	Idler Pulley - Grooved; W/O A.C.		38008
Idler Pulley - Smooth; W/A.C.	12555609	36299	Hose - Upper		22265
Idler Pulley - Grooved; W/O A.C.	10239930	38008	Hose - Lower		21442
Hose - Upper		23803	Hose - By Pass		♣19670
Hose - Lower		21442			
Hose - By Pass		19802			
2001			GM V-8 8.1 L		
GM V-6 4.3 L			P Series		
P Series			Belt - Serpentine; W/A.C.		
Belt - Serpentine; W/A.C.; W/105A. Alt.		K060966	Belt - Serpentine; W/O A.C.; W/105A. Alt.		♣K061080HD
Belt - Serpentine; W/O A.C.; W/105A. Alt.		♣K060870HD	Tensioner Assy.	12561094	38103
Tensioner Assy.		38103	Tensioner Pulley; W/A.C.	12561094	38008
Tensioner Pulley		38008	Idler Pulley - Smooth; W/A.C.	12555609	36299
Idler Pulley - Smooth		38001	Idler Pulley - Grooved; W/O A.C.	10239930	38008
Idler Pulley - Grooved; W/O A.C.		38008	Hose - Upper		23803
Hose - Upper		22266	Hose - Lower		21442
Hose - Lower		22169	Hose - By Pass		19802
Hose - By Pass		19025			
Hose - Heater To Reducer; Cut at 13"		28412			
Hose - Reducer To W.P.; Cut at 38"		28411			
Hose - Eng. To Valve; Cut at 28"		28411			
Hose - Valve To Heater; Cut at 17"		28411			
Hose - Rad. To Reservoir; Cut at 20"		28409			
GM V-8 5.7 L					
P Series					
Belt - Fan, Alt., P.S. & A.C.	12564764	K060966			
Belt - Fan, Alt. & P.S.	12564759	♣K060870HD			
Tensioner Assy. - Fan, Alt. & P.S.	12561094	38103			
Idler Pulley - Smooth		38001			

♣Standard Belt Available.

♣Cut to Fit.

Medium & Heavy-Duty Trucks
(2001 & Newer)

Belts for Truck Refrigeration Units

Order Belts by Our Number. Manufacturers' Part Number is shown for reference only.

Refrigeration Units

Application	Mfr. Part No.	Our No.	Application	Mfr. Part No.	Our No.
Arctic Traveler			Thermo King - Continued		
B			D4M1		
Gen.	S751	♣9370HD	Alt.	78285	Ⓣ♣9470HD
Challenger			Compr.	78385	ⓉB59
Compr.	4750109	ⓉB42	FB2; FB2-M5		
Mtr.	4750108	ⓉB46	Alt.	78317	♣9400HD
FD10			W.P.	78289	♣9319HD
Fan; 1967 & Newer		BX133	Gen.	071242	♣9290HD
Alt.		♣9400HD	GA		
TE750			Starter	78195	♣9330HD
Alt.; 1967 & Newer		♣9400HD	GL		
Carrier			Fan & Compr.		ⓉBX90
Supra 550			HA		
W.P.	253485600	3VX315	Drive	78144	ⓉA66
Supra 622; Supra 644			HK 30; HK 60; HK 100		
Mtr. To Compr.	500016253	AX47	W.P. & Alt.	78272	♣9380HD
Compr.; W/Standby Mtr.	500017823	BX45	HM		
Alt.	506000602	♣9365HD	Drive	78144	ⓉA66
W.P.	506019704	3VX315	J		
Supra 922; Supra 944			Compr.	78164	♣9350HD
Mtr. To Compr.	500017857	BX54	JD-I 30		
Compr.; W/Standby Mtr.	500017858	BX56	W.P.	78679	9279
Alt.	506000602	♣9365HD	JD-I 50		
Thermo King			W.P.	78272	♣9380HD
B1			KD-I		
Drive	78280	Ⓣ3VX450	Fan	78498	AX64
C; CA			W.P.; W/O Alt.		♣9313HD
Gen.		♣9385HD	W.P. & Alt.	78434	♣9440HD
CBCI			Compr.; W/Standby Mtr.	78341	5521
Compr.; W/York or Sanden Compr.	78733	5536	Mtr. To Compr.	78486	2/3VX630
CB-I			KD-II		
Compr.	78544	AX42	Fan - Right Side		3V315
CB-II			Fan & Alt. - Left Side	78684	5508
Compr.	78272	♣9380HD	W.P.		9279
CB-III			Elec. Mtr. To Compr.; Mar. 1988 & Older	78689	5529
Compr.	78544	AX42	Evap. Fan & Alt.	78700	3V300
CG			Mtr. To Compr.	78688	5502
Gen.	78232	♣9341HD	KL 10		
Compr.	78267	♣9350HD	Fan & Compr.	78129	ⓉBX90
Mtr.; W/Electric Mtr.	78244	Ⓣ♣9400HD	KL 20		
CGS1250			Fan & Compr.	78173	BX55
Fan	78297	Ⓣ5516	KL 30; KL 40; KL 40S		
CM			Fan & Compr.	78129	ⓉBX90
Gen.		♣9395HD	KL 50		
Crown 500			Fan & Compr.	78173	BX55
Fan	78322	5524	KL 62		
Alt.	78232	♣9341HD	Fan	78172	BX82
D1 Series			Fan & Compr.; W/Single Phase	78173	BX55
Alt.; W/35A. Alt.	78511	AX37	KLA		
W.P. & Alt.; W/125A. Alt.	78459	AX46	Fan	78172	BX82
D2M2			Alt.	78212	B48
Alt.	78285	Ⓣ♣9470HD	KR		
Compr.	78385	ⓉB59	Compr.	78205	ⓉB58
D3 Series			LC		
W.P. & Alt.	78459	ⓉAX46	Mtr.	78238	B68
			LND 30		
			Fan & Alt.	78608	B71
			W.P.	78513	♣9305HD

♣Standard Belt Available.

ⓉTwo Required.

Belts for Truck Refrigeration Units

Application	Mfr. Part No.	Our No.	Application	Mfr. Part No.	Our No.
Thermo King - Continued			Thermo King - Continued		
LND 30 - Continued			MWC 20		
Idler To Fan Shaft	78606	B30	Alt	78265	9300
Clutch	78628	ⓂBX50	MWC 30		
Mtr. To Idler; W/Single Belt	78607	B81	Alt	78232	♣9341HD
LND 30 PEG			MWC 40; MWC 50		
Fan & Alt.	78608	B71	Alt	78265	9300
W.P.	78513	♣9305HD	MWCL 25; MWCT		
Idler	78606	B30	Drive	78112	Ⓜ6234
Mtr. To Idler	78607	B81	NFD		
LND 50			NSD1-1012		
Fan - From Idler	78671	5510	Gen.	78204	♣9480HD
W.P.; W/31" Belt O.C.		♣9305HD	NWD		
W.P.; W/32" Belt O.C.		♣9313HD	Fan; New Style	78278	5524
Compr.	78628	ⓂBX50	Alt.; New Style	78272	♣9380HD
Mtr. To Idler - Fan	78649	5538	W.P.; New Style	78275	♣9447HD
LND 50 PEG			W.P. & Gen.; Old Style	78204	♣9480HD
W.P.	78513	♣9305HD	Drive; Ser. No. 101 Thru 126	78202	BX128
Mtr. To Idler	78649	5538	Drive; Ser. No. 127 Thru 206	78213	BX124
LR			NWD (Super & Crown)		
Fan & Alt.	78506	5509	Alt	78232	♣9341HD
W.P.	78513	♣9305HD	W.P. & Alt.	78429	♣9420HD
Drive	78518	5500	NWD 30 3000		
Elec. Mtr.; W/220/380V., 50 Hz Mtr.		5513	Fan & Idler	78278	5524
Elec. Mtr.; W/230/460V., 60 Hz Mtr.		5511	Alt	78272	♣9380HD
LR-I			W.P.	78315	9279
Alt	78518	5509	NWD 30 3005		
W.P.; W/31" Belt O.C.		♣9305HD	W.P.	78336	♣9290HD
W.P.; W/32" Belt O.C.		♣9313HD	Alt	78272	♣9380HD
Elec. Mtr. To Compr.; Mtr. No.			NWD 30 3006		
4107D31H02	78512	5513	Alt	78232	♣9341HD
Elec. Mtr. To Compr.; Mtr. No.			NWD 30 3100 Series		
4640C44H02	78509	5511	Fan & Idler	78278	5524
Mtr. To Compr.	78518	5500	Alt	78272	♣9380HD
M13; M15			Alt. To W.P.	78336	♣9290HD
Fan	78214	5525	NWD 30 AM4; NWD 30 AM6		
Alt	78232	♣9341HD	Alt	78110	ⓂA45
M22			NWD 30 AM7		
Compr.	78239	♣9530HD	Alt	78137	BX55
MD-I			NWD 30 M4		
W.P. & Alt.; W/2-Pulley System	78513	♣9305HD	Fan; New Style	78214	5525
W.P. & Alt.; W/3-Pulley System	78503	♣9430HD	Fan; Old Style; W/115" Belt O.C.	78241	BX112
Evap. Fan, Elec. Mtr. & Idler	78436	5520	Fan; Old Style; W/118" Belt O.C.	78214	5525
Compr.; W/Standby Mtr.	78436	5520	Alt. - From Eng.; New Style	78272	♣9380HD
Compr. - From Clutch; 50D	78591	5522	Alt. - From Fan; New Style	78223	♣9580HD
MD-II			W.P.; New Style	78275	♣9447HD
Alt.; W/O KD-II Sheaves	78700	3V300	W.P. & Gen.; Old Style	78204	♣9480HD
Fan - Right Side; W/KD-II Sheaves		3V315	Drive; Old Style	78242	BX120
Fan & Alt. - Left Side; W/KD-II Sheaves	78684	5508	NWD 30 M10A		
W.P.		9279	Fan; W/115" Belt O.C.	78241	BX112
Compr. & Idler; W/O KD-II Sheaves	78688	5502	W.P. & Gen.	78204	♣9480HD
Elec. Mtr. & Compr.; Feb. 1988 & Older	78689	5529	Drive; Old Style	78241	BX112
Elec. Mtr. & Compr.; Jan. 1989 & Newer; W/O KD-II Sheaves	78679	9279	NWD 30 M20		
Evap. Fan & Alt.; W/KD-II Sheaves	78700	3V300	Fan	78241	BX112
Evap. Fan, Alt. & Compr.; W/O KD-II Sheaves	78684	5508	Alt. - From Mtr.	78272	♣9380HD
Mtr. To Compr.; W/KD-II Sheaves	78688	5502	Alt. - From Fan	78223	♣9580HD
MW			W.P.	78275	♣9447HD
Fan	78197	♣9510HD	NWD 30 M22		
Gen.	78111	♣9370HD	Fan	78241	BX112
MWC 10			Alt. - From Mtr.	78272	♣9380HD
Alt	78232	♣9341HD			

ⓂTwo Required.

♣Standard Belt Available.

Refrigeration Units

Belts for Truck Refrigeration Units

Refrigeration Units

Application	Mfr. Part No.	Our No.	Application	Mfr. Part No.	Our No.
Thermo King - Continued			Thermo King - Continued		
NWD 30 M22 - Continued			NWD 62 30M5		
W.P.	78275	♣9447HD	Fan	78242	BX120
NWD 30 M30			NWD 62 50		
Alt. - From Fan	78223	♣9580HD	Fan	78270	BX144
NWD 30 M35			Alt.	78266	6825
Fan	78241	BX112	W.P.	78268	♣9451HD
Alt. - From Mtr.	78272	♣9380HD	NWD 622 30M10A		
Alt. - From Fan	78223	♣9580HD	Fan	78241	BX112
W.P.	78275	♣9447HD	W.P. & Gen.	78204	♣9480HD
NWD 30 M46			NWD-AM1		
Fan	78241	BX112	Alt.	78223	♣9580HD
Alt. - From Mtr.	78272	♣9380HD	Drive: W/30A. Alt.	78214	5525
Alt. - From Fan		♣9570HD	NWD-AM3		
W.P.	78275	♣9447HD	Fan	78278	Ⓢ5524
NWD 30 M50			Alt.; Old Style; W/30A. Alt.	78223	♣9580HD
W.P.	78275	♣9447HD	Alt.; Old Style; W/O 30A. Alt.	78110	ⓈA48
NWD 30 M100; NWD 30 M1212			W.P. & Alt.	78223	♣9580HD
Fan & Idler	78278	5524	W.P. & Gen.	78264	♣9570HD
Alt.	78272	♣9380HD	Drive: W/30A. Alt.	78214	5525
W.P.	78315	9279	NWD-AM4		
NWD 35 AM6; NWD 35 AM7; NWD 35 AM8			Fan	78278	Ⓢ5524
Fan	78278	Ⓢ5524	Alt.; Old Style	78110	ⓈA48
Alt.	78110	ⓈAX48	W.P. & Alt.	78223	♣9580HD
W.P. & Gen.	78264	♣9570HD	W.P. & Gen.	78264	♣9570HD
NWD 35 M4			Drive: Old Style; W/30A. Alt.	78214	5525
Fan	78242	BX120	NWD-AM8		
NWD 35 M5			Alt.; New Style	78110	A45
Fan; Old Style	78242	BX120	Alt.; Old Style	78110	ⓈA48
W.P.; New Style	78275	♣9447HD	NWE MAX		
W.P. & Alt.; New Style	78272	♣9380HD	Fan	78487	A48
W.P. & Gen.; New Style	78204	♣9480HD	NWG		
NWD 35 M21			Fan	78230	BX100
W.P.	78275	♣9447HD	W.P.	78231	TR22386
W.P. & Alt.	78272	♣9380HD	RCD		
W.P. & Gen.	78204	♣9480HD	Fan	78287	A144
NWD 50			W.P.	78328	♣9476HD
Fan; Old Style	78270	BX144	RD-I 30; RD-I 50		
Fan; New Style		A144	Fan	78494	5530
Alt.	78362	9260	Alt.	78434	♣9440HD
W.P.	78275	♣9447HD	W.P.; W/2-Pulley System	78513	♣9305HD
Compr.	78368	ⓈB50	W.P.; W/3-Pulley System	78494	5530
NWD 50 3000			Compr.; W/R12 Coolant	78495	5504
Fan	78287	A144	Compr.; W/R502 Coolant	78500	5512
Alt.	78362	9260	Elec. Mtr. & Compr.; W/R12 Coolant	78436	5520
W.P.	78328	♣9476HD	Elec. Mtr. & Compr.; W/R502 Coolant	78510	5503
Elec. Mtr.		ⓈB50	RD-I SSIV		
NWD 50 3011			W.P.	78513	♣9305HD
Fan	78287	A144	Compr.; W/R12 Coolant	78495	5504
W.P.	78275	♣9447HD	Compr.; W/R502 Coolant	78500	5512
NWD 50 3100 Series			Elec. Mtr. & Compr.; W/R12 Coolant	78436	5520
Fan & Idler	78287	A144	Elec. Mtr. & Compr.; W/R502 Coolant	78510	5503
Alt.	78362	9260	Evap. Fan & Alt.	78666	A53
W.P.	78328	♣9476HD	Evap. Fan, Alt. & Compr.; W/R12 Coolant ..	78494	5530
Elec. Mtr.		ⓈB50	Evap. Fan, Alt. & Compr.; W/R502 Coolant .	78646	AX66
NWD 50 M207			RD-II		
Fan	78287	A144	W.P. & Alt.	78434	♣9440HD
W.P.	78275	♣9447HD	Compr. To Fan	78494	5530
NWD 62			Elec. Mtr. To Compr.	78510	5503
W.P.	78268	♣9451HD	Evap. Fan & Compr.	78698	3VX600
Gen.	78255	AX46	Evap. Fan & Alt.	78666	A53
			Mtr. To Compr.; W/67" Belt O.C.	78500	5512
			Mtr. To Compr.; W/65" Belt O.C.	78495	5504

♣Standard Belt Available.

ⓈTwo Required.

Belts for Truck Refrigeration Units

Application	Mfr. Part No.	Our No.	Application	Mfr. Part No.	Our No.
Thermo King - Continued			Thermo King - Continued		
RL			SB-II 30 PEG - Continued		
Fan & Idler	78132	BX90	Idler; W/O 2-Speed Fan	78604	BX83
Elec. Mtr.	78153	②B44	SB-II 50; SB-II 50 TC		
RL 20; RL 50			Fan & Idler; W/2-Speed Trans.	78731	A84
Fan & Compr.	78132	BX90	Fan & Idler; W/O 2-Speed Trans.	78629	BX84
Clutch	78146	♣9470HD	Alt.	78339	A38
Compr.; Ser. No. 876756	78146	②♣9470HD	W.P.	78289	♣9319HD
Compr.; Old Style	78153	②B44	Compr.	78535	③B49
RLA			SB-II C201		
Drive	78212	B48	Fan	78603	BX59
RLD			W.P. & Alt.; W/37A. Alt.	78751	♣9463HD
Fan	78320	A112	Idler	78604	BX83
W.P. & Alt.	78319	♣9510HD	SB-II Convertible		
ROL 30			Fan; W/Reverse Air	78637	BX61
Fan; Ser. No. 1510 & After	78172	BX82	Fan; W/O Reverse Air	78603	BX59
ROL 40			Fan; W/2-Speed Fan	78695	A58
Fan	78185	BX90	W.P. & Alt.; W/37A. Alt.	78751	♣9463HD
ROL 50			W.P. & Alt.; W/65A., 72A. Alt.	78471	♣9465HD
Fan; Ser. No. 1510 & After	78172	BX82	Idler; W/2-Speed Fan	78694	6884
RT			Idler; W/O 2-Speed Fan	78604	BX83
Blower	78107	A68	SB-II HP		
SB-I 30			Fan	78603	BX59
Fan	78470	5523	Idler	78604	BX83
W.P. & Alt.	78471	♣9465HD	SB-II Max		
SB-I 50			Fan	78629	BX84
Fan & Idler	78577	B190	SB-II Max 30		
Alt.	78521	A26	Fan & Idler; W/2-Speed Fan	78695	A58
W.P.	78267	♣9350HD	Fan & Idler; W/O 2-Speed Fan	78603	BX59
Elec. Mtr.	78535	B49	W.P. & Alt.; W/37A. Alt.	78751	♣9463HD
SB-I 1000; SB-I 1200; SB-I 2000			W.P. & Alt.; W/65A. Alt.	78471	♣9465HD
Fan; W/High Performance Output	78470	5523	Idler; W/2-Speed Fan	78694	6884
Fan; W/O High Performance Output	78553	5535	Idler; W/O 2-Speed Trans.	78604	BX83
W.P. & Alt.; W/47" Belt O.C.	78471	♣9465HD	SB-II Max 50 EEC		
W.P. & Alt.; W/57" Belt O.C.	78556	AX55	Alt.		♣9440HD
SB-I 5300			W.P.		♣9319HD
Fan & Idler	78470	5523	SB-II Max Plus		
Alt. To Compr.	78572	B60	Fan	78603	BX59
W.P. & Alt.	78471	♣9465HD	W.P. & Alt.; W/37A. Alt.	78751	♣9463HD
SB-II 30			Idler	78604	BX83
Fan; W/2-Speed Fan	78695	A58	SB-II PE		
Fan; W/O 2-Speed Fan	78603	BX59	Fan; W/2-Speed Fan	78695	A58
W.P. & Alt.; W/37A. Alt.	78751	♣9463HD	Fan; W/O 2-Speed Fan	78603	BX59
W.P. & Alt.; W/65A., 72A. Alt.	78471	♣9465HD	W.P. & Alt.; W/37A. Alt.	78751	♣9463HD
Idler; W/2-Speed Fan	78694	6884	W.P. & Alt.; W/65A., 72A. Alt.	78471	♣9465HD
Idler; W/O 2-Speed Fan	78604	BX83	Idler; W/2-Speed Fan	78694	6884
SB-II 30 1500 AC; SB-II 30 1500 PEG			Idler; W/O 2-Speed Fan	78604	BX83
Fan	78603	BX59	SB-II Reverse Air		
W.P. & Alt.; Nov. 1, 1987 & Older; W/37A. Alt.	78667	♣9476HD	Fan	78637	BX61
W.P. & Alt.; Nov. 2, 1987 & Newer	78471	♣9465HD	W.P. & Alt.; W/37A. Alt.	78751	♣9463HD
Idler	78604	BX83	W.P. & Alt.; W/65A., 72A. Alt.	78471	♣9465HD
SB-II 30 DELTA			Idler; W/2-Speed Fan	78694	6884
Fan; W/2-Speed Fan	78695	A58	Idler; W/O 2-Speed Fan	78604	BX83
W.P. & Alt.	78751	♣9463HD	SB-II TC		
Idler; W/2-Speed Fan	78694	6884	Fan; W/2-Speed Fan	78695	A58
SB-II 30 PEG			Fan; W/O 2-Speed Fan	78603	BX59
Fan; W/2-Speed Fan	78695	A58	W.P. & Alt.; W/37A. Alt.	78751	♣9463HD
Fan; W/O 2-Speed Fan	78603	BX59	W.P. & Alt.; W/65A., 72A. Alt.	78471	♣9465HD
W.P. & Alt.; W/37A. Alt.	78751	♣9463HD	Idler; W/2-Speed Fan	78694	6884
W.P. & Alt.; W/65A., 72A. Alt.	78471	♣9465HD	Idler; W/O 2-Speed Fan	78604	BX83
Idler; W/2-Speed Fan	78694	6884	SB-II Tracker		

②Two Required.
③Three Required.

♣Standard Belt Available.

Refrigeration Units

Belts for Truck Refrigeration Units

Refrigeration Units

Application	Mfr. Part No.	Our No.	Application	Mfr. Part No.	Our No.
Thermo King - Continued			Thermo King - Continued		
SB-II Tracker - Continued			Sentry 50 2000 - Continued		
W.P. & Alt.; W/37A. Alt.	78751	♣9463HD	Elec. Mtr.	78368	ⓂB50
W.P. & Alt.; W/65A., 72A. Alt.	78471	♣9465HD	Idler	78655	A120
Idler; W/2-Speed Fan	78694	6884	Sentry 50 Convertible		
Idler; W/O 2-Speed Fan	78604	BX83	Fan - From Mtr.	78654	6861
SB-III 30 TC			Fan - From Alt.	78655	A120
Fan	78603	BX59	Alt.; W/13A. Alt.	78580	2210
W.P. & Alt.	78629	BX84	Alt.; W/37A. Alt.; W/Remote Mount		
Idler	78604	BX83	Regulator	78266	6825
SB-III Max 30			Alt. - Evap. Unit	78497	Ⓜ5533
Fan; W/Sound Insulation Pkg.	78637	BX61	Idler	78656	Ⓜ5525
Fan; W/O Sound Insulation Pkg.	78603	BX59	Sentry DI 30		
Fan & Idler	78629	BX84	Fan; W/R12, R22 Coolant	78556	AX55
W.P. & Alt.; W/Sound Insulation Pkg.	78639	A48	Fan; W/R502 Coolant	78560	AX53
SB-III Max 50			W.P. & Alt.	78751	♣9463HD
Alt.	78434	♣9440HD	Sentry DI 30 PE; Sentry DI 30 PEG		
W.P.	78289	♣9319HD	Fan; W/R12 Coolant	78556	AX55
Compr.	78535	ⓂB49	Fan; W/R502 Coolant	78560	AX53
SB-III SR; SB-III SRMP Plus			W.P. & Alt.; W/37A. Alt.; Nov. 2, 1987 & Newer	78751	♣9463HD
Fan	78603	BX59	W.P. & Alt.; W/65A. Alt.; Nov. 2, 1987 & Newer	78471	♣9465HD
W.P. & Alt.; Mar. 1991 & Older	78751	♣9463HD	W.P. & Alt.; Nov. 1, 1987 & Older	78667	♣9476HD
Idler	78629	BX84	Sentry DI 50		
SB-III TC Max			Fan; W/Power Tray	78655	ⓂA120
Fan	78603	BX59	Fan; W/O Power Tray	78654	6861
W.P. & Alt.	78751	♣9463HD	Alt.; W/Power Tray; W/13A. Alt.	78580	2210
Idler	78604	BX83	Alt.; W/Power Tray; W/37A. Alt.; W/Remote Mount Regulator	78266	6825
SD-I 1012; SD-I 1013			W.P.	78648	A29
W.P. & Alt.; W/120A. Alt.	78459	Ⓜ♣9480HD	Idler	78656	5525
W.P. & Alt.; W/125A. Alt.	78397	ⓂA43	Mtr.; W/Power Tray	78617	Ⓜ5533
Sentry 30			Sentry DI Convertible		
Fan; W/High Performance Output	78560	AX53	Fan; W/R502 Coolant	78560	AX53
Fan; W/O High Performance Output	78556	AX55	W.P. & Alt.; W/37A. Alt.	78751	♣9463HD
W.P. & Alt.; W/37A. Alt.	78471	♣9465HD	W.P. & Alt.; W/65A. Alt.		♣9465HD
Idler	78555	5517	Sentry DI Convertible PE		
Sentry 30 1000; Sentry 30 1200			Alt.	78671	Ⓜ5533
Fan; W/High Performance Output	78560	AX53	Sentry DI TC		
Fan; W/O High Performance Output	78556	AX55	Fan	78666	A53
W.P. & Alt.; W/12A. Alt.	78267	♣9350HD	W.P. & Alt.; W/65A. Alt.; Nov. 2, 1987 & Newer	78471	♣9465HD
Idler	78555	5517	W.P. & Alt.; Nov. 1, 1987 & Older	78667	♣9476HD
Sentry 30 2000			Sentry TC Convertible		
Fan; W/High Performance Output	78560	AX53	Fan; W/R12 Coolant	78556	AX55
Fan; W/O High Performance Output	78556	AX55	Fan; W/R502 Coolant	78560	AX53
W.P. & Alt.	78471	♣9465HD	W.P. & Alt.	78751	♣9463HD
Idler	78555	5517	SKF		
Sentry 30 PEG			Drive	78187	A38
Fan; W/High Performance Output	78560	AX53	SRL		
Fan; W/O High Performance Output	78556	AX55	Fan; Old Style	78132	BX90
W.P. & Alt.; W/37A. Alt.	78471	♣9465HD	Fan & Compr.; New Style	78132	BX90
Idler	78555	5517	Fan & Idler; New Style	78132	BX90
Sentry 50 1000; Sentry 50 1200			Elec. Mtr.; New Style	78153	ⓂB44
Fan; W/High Performance Output	78560	AX53	SRL-50		
Fan; W/O High Performance Output	78556	AX55	Fan	78153	B44
Fan - From Alt.	78583	A120	SROL		
Alt.; W/12A. Alt.	78580	2210	Fan	78261	BX82
W.P.	78267	♣9350HD	Compr.	78262	ⓂBX128
Elec. Mtr.	78368	ⓂB50	STB-I; STB-II; STB-III		
Idler	78655	A120	Elec. Mtr. To Compr.; W/1/2" Pulley	78587	AX35
Sentry 50 2000					
Fan; W/High Performance Output	78560	AX53			
Fan; W/O High Performance Output	78556	AX55			
Fan - From Alt.	78583	A120			
Alt.; W/37A. Alt.	78362	9260			
W.P.	78267	♣9350HD			

♣Standard Belt Available.

ⓂTwo Required.

Belts for Truck Refrigeration Units

Application	Mfr. Part No.	Our No.	Application	Mfr. Part No.	Our No.
Thermo King - Continued			Thermo King - Continued		
Super GS			Super NWD 50 - Continued		
Fan & Compr.	78232	▲9341HD	Fan - From Alt.	78287	A144
W.P.	78339	A38	Alt.	78362	9260
Super II 30			W.P.	78328	▲9476HD
Fan	78717	5506	Elec. Mtr.	78368	②B50
W.P. & Alt.; W/37A. Alt.	78751	▲9463HD	Super NWD 50 5000; Super NWD 50 5100		
W.P. & Alt.; W/65A. Alt.	78471	▲9465HD	Fan	78287	A144
Super II 30 Dehumidifier; Super II 30 Max; Super II 30 TC			Alt.	78362	9260
Fan	78717	5506	W.P. & Idler	78339	A38
W.P. & Alt.	78471	▲9465HD	Elec. Mtr.	78368	②B50
Super II 50			Super NWD 50 5200		
Alt.	78266	6825	Fan; W/Power Tray	78655	②A120
W.P.	78648	A29	Fan; W/O Power Tray	78287	A144
Clutch	78723	②BX48	Alt.; W/Power Tray; W/13A. Alt.	78580	2210
Super MAX			Alt.; W/Power Tray; W/37A. Alt.	78362	9260
Fan; W/Reverse Air	78637	BX61	Alt.; W/O Power Tray	78362	9260
Fan; W/O Reverse Air	78603	BX59	W.P.	78267	▲9350HD
Fan; W/2-Speed Fan	78695	A58	W.P. & Idler	78339	A38
W.P. & Alt.; W/37A. Alt.	78695	A58	Clutch	78368	②B50
Idler; W/2-Speed Fan	78694	6884	Mtr.; W/Power Tray	78617	②5533
Idler; W/O 2-Speed Fan	78604	BX83	Super NWD 50 5200 AMG		
Super NWD			Fan	78287	A144
Alt.	78232	▲9341HD	Alt.	78362	9260
Gen.	78397	A43	W.P.	78267	▲9350HD
Super NWD 30			Clutch	78368	②B50
Fan	78278	5524	Mtr.; W/Power Tray	78368	②B50
Fan - From Idler	78556	AX55	Super NWD 50 5237 ESP		
Alt.; W/34 1/2" Belt O.C.	78232	▲9341HD	Fan	78287	A144
Alt.; W/38 1/2" Belt O.C.	78272	▲9380HD	Alt.	78362	9260
W.P.	78453	2300	W.P. & Idler	78339	A38
Super NWD 30 5154 BP			Elec. Mtr.	78368	②B50
Fan & W.P.	78241	BX112	Super NWD 50 5300		
Alt.	78232	▲9341HD	Fan; W/Power Tray	78655	②A120
Super NWD 30 5200 AMG			Fan; W/O Power Tray	78287	A144
Fan & W.P.	78214	5525	Alt.; W/Power Tray; W/13A. Alt.	78580	2210
Alt.; W/55A. Alt.	78467	▲9341HD	Alt.; W/Power Tray; W/37A. Alt.	78583	A120
Alt. - Evap. Unit	78497	②5533	W.P.	78267	▲9350HD
Super NWD 30 5237 ESP			Mtr.; W/Power Tray	78368	②B50
Fan & W.P.	78214	5525	Super NWD 50 5300 AMG		
Alt.	78467	▲9341HD	Fan	78287	A144
Super NWD 30 5300			Alt.	78362	9260
Fan & W.P.	78214	5525	W.P.	78267	▲9350HD
Alt.	78467	▲9341HD	Clutch	78368	②B50
W.P. & Alt.	78471	▲9465HD	Mtr.; W/Power Tray	78368	②B50
Super NWD 30 5300 AMG			Super NWD 50 SS TV		
Fan	78214	5525	Fan	78362	9260
Alt. - Evap. Unit	78497	②5533	W.P.	78339	A38
W.P. & Alt.; W/55A. Alt.	78471	▲9465HD	Clutch	78368	②B50
Super NWD 30 PE 1000; Super NWD 30 PE 1200			Super NWD 5137		
Fan; W/High Performance Output	78214	5525	Fan & W.P.	78214	5525
Fan; W/O High Performance Output	78556	AX55	Alt.	78467	▲9341HD
Alt. - Evap. Unit	78497	②5533	Super NWD 5137 AMG		
W.P. & Alt.		▲9465HD	Fan	78287	A144
Idler	78557	5518	Alt.	78362	9260
Super NWD 30 PE 5000; Super NWD 30 PE 5100; Super NWD 30 PE 5200			W.P. & Idler	78339	A38
Fan & W.P.	78214	5525	Elec. Mtr.	78368	②B50
Alt.	78467	▲9341HD	Super NWD LR		
Super NWD 50			Fan & Alt.		5509
Fan	78287	A144	Elec. Mtr. To Compr.; Mtr. No. 4640C44H02	78509	5511
			Elec. Mtr. To Compr.; Mtr. No. 4107D31H002	78512	5513
			Mtr. To Compr.	78518	5500

▲Standard Belt Available.

②Two Required.

Refrigeration Units

Belts for Truck Refrigeration Units

Refrigeration Units

Application	Mfr. Part No.	Our No.	Application	Mfr. Part No.	Our No.
Thermo King - Continued			Thermo King - Continued		
Super XMT			XMD		
Fan	78339	A38	Fan	78339	A38
Alt.	78232	▲9341HD	Alt.	78449	7375
Compr.	78340	B46	W.P.	78444	▲9350HD
T3M43			Compr.	78340	B46
Compr.	97609500011	5539	Evap. Fan & Idler; W/R12 Coolant	78436	5520
TD			Evap. Fan & Idler; W/R502 Coolant	78485	5500
W.P.	78513	▲9305HD	Mtr. To Compr.; W/R12 Coolant	78432	5522
Elec. Mtr. To Compr.	78436	5520	Mtr. To Compr.; W/R502 Coolant	78486	2/3VX630
Evap. Fan, Alt. & Compr.	78494	5530	XMD 30; XMD 50		
Mtr. To Compr.	78495	5504	Alt.	78449	7375
TD-II			W.P.	78444	▲9350HD
Elec. Mtr. To Compr.; W/R12 Coolant	78510	5503	Mtr. To Fan & Compr.	78436	5520
Evap. Fan & Compr.	78484	5508	XMD 50D		
Evap. Fan & Alt.	78766	3VX250	Fan	78339	A38
Mtr. To Compr.	78500	5512	Alt.	78232	▲9341HD
TWD			Compr.	78340	B46
Fan	78448	2640	XMD-I		
Alt.	78453	2300	W.P.	78444	▲9350HD
W.P.	78324	▲9390HD	XMT		
Compr.	78446	B69	Alt. & Compr.; W/Aenld Mtr.	78232	▲9341HD
Clutch	78447	ⓂB45	Elec. Mtr. & Compr.	78340	B46
UK			Evap. Fan & Idler	78339	A38
Alt.	78240	TR22588	Mtr. To Compr.; W/Aenld Mtr.	78341	5521
US			Mtr. To Compr.; W/OH160 Mtr.	78436	5520
Alt.	78168	TR22508	XNWD; XNWD 30		
Compr.	78173	BX55	Fan	78428	5526
US-50			Alt.	78429	▲9420HD
Alt.	78168	TR22508	XNWE 100		
Compr.	78177	ⓂBX55	Fan	78487	A48
UWD			XROL 10; XROL 10HT		
Fan, Alt. & W.P.	78466	5527	Fan	78301	B86
Alt.	78331	2410	Compr.	78156	ⓂB62
Gen.; Ser. No. 2565 & Before	78222	▲9400HD	XROL 20		
Gen.; Ser. No. 2566 & After	78224	▲9430HD	Fan	78301	B86
UWTD			Compr.	78308	ⓂB90
Fan, Alt. & W.P.	78466	5527	XROL 20HT		
Alt.	78222	▲9400HD	Fan	78301	B86
Windjammer 500			Compr.	78155	ⓂB93
Fan	78428	5526	XROL 30; XROL 30 M5		
Alt.	78429	▲9420HD	Fan	78301	B86
XKL 10; XKL 10LT			Compr. & Clutch; W/Pulley No. 77-347	78302	ⓂBX64
Fan	78301	B86	Compr. & Clutch; W/Pulley No. 77-342	78156	ⓂB62
Compr.	78156	ⓂB62	XROL 30HT		
XKL 20			Fan	78301	B86
Compr.	78308	ⓂB90	Compr.	78156	ⓂB62
XKL 20LT			XROL 50; XROL 50 M5		
Fan	78301	B86	Fan	78301	B86
Compr.	78308	ⓂB90	Compr. & Clutch; W/Pulley No. 77-347	78155	ⓂB93
XKL 30; XKL 30LT			Compr. & Clutch; W/Pulley No. 77-342	78308	ⓂB89
Fan	78301	B86	XROL 50HT		
Compr.	78156	ⓂB62	Fan	78301	B86
XKL 50			Compr.	78155	ⓂB93
Compr.	78308	ⓂB90	XRW; XRW 20D; XRWL		
XKL 50LT			Fan	78376	3VX425
Fan	78301	B86	W.P.	78454	2285
Compr.	78308	ⓂB90	Compr.	78346	Ⓜ3V560
XKW			Eng. To Elec. Mtr.	78342	5501
Fan	78376	3VX425	XUK 50 M4		
Compr.	78346	3V560	Alt.	78333	3490
			Compr.	78137	ⓂBX55

▲Standard Belt Available.

ⓂTwo Required.

Belts for Truck Refrigeration Units

Application	Mfr. Part No.	Our No.	Application	Mfr. Part No.	Our No.
Transicold			Transicold - Continued		
161; 200; 200B; 201; 202; 203; 204			660; 670		
Gen.; W/Hercules Zxb Eng.	5000028	2240	Fan & Alt.; W/Hercules lbx Eng.	5000063	♣9430HD
220; 220B; 221; 222; 223; 224			1001		
Gen.; W/Hercules lbx Eng.	5000026	9260	Fan; W/Perkins 4-Cyl. 99 Eng.; Early	5000028	6824
230; 230B; 230C			Fan; W/Perkins 4-Cyl. 99 Eng.; Late; W/Single Belt	5000020	6833
Fan; W/Perkins 4-Cyl. 99 Eng.; Early	5000028	6824	Fan; W/Perkins 4-Cyl. 99 Eng.; Late; W/Dual Belts	5000020	Ⓜ6833
Fan; W/Perkins 4-Cyl. 99 Eng.; Late; W/Single Belt	5000020	6833	Fan; W/Perkins 4-Cyl. 99 Eng.; Conversion ..	5000062	Ⓜ6823
Fan; W/Perkins 4-Cyl. 99 Eng.; Late; W/Dual Belts	5000020	Ⓜ6833	Gen.; W/Perkins 4-Cyl. 99 Eng.; W/39" Belt O.C.	5000059	♣9385HD
Fan; W/Perkins 4-Cyl. 99 Eng.; Conversion ..	5000062	Ⓜ6823	Gen.; W/Perkins 4-Cyl. 99 Eng.; W/40" Belt O.C.	5000021	♣9395HD
Gen.; W/Perkins 4-Cyl. 99 Eng.; W/39" Belt O.C.	5000059	♣9385HD	1003; 2005		
Gen.; W/Perkins 4-Cyl. 99 Eng.; W/40" Belt O.C.	5000021	♣9395HD	Fan; W/Mercedes-Benz OM636 Eng.	5000062	Ⓜ6823
230CM			Fan; W/Perkins 4-Cyl. 108 Eng.	5000062	Ⓜ6823
Alt.; W/Mercedes-Benz OM636 Eng.	5000077	7480	W.P. & Alt.; W/Mercedes-Benz OM636 Eng.	5000077	7480
230CP			W.P. & Alt.; W/Perkins 4-Cyl. 108 Eng.	5000093	♣9385HD
Fan; W/Mercedes-Benz OM636 Eng.	5000062	Ⓜ6823	6000A		
W.P.; W/Mercedes-Benz OM636 Eng.	5000093	♣9385HD	W.P.; W/Mercedes-Benz OM636 Eng.	5000077	7480
231; 234; 250; 250C			W.P. & Alt.; W/Perkins 4-Cyl. 108 Eng.	5000059	♣9385HD
Fan; W/Perkins 4-Cyl. 99 Eng.; Early	5000028	6824	J.S.; W/Mercedes-Benz OM636 Eng.	5001001	A43
Fan; W/Perkins 4-Cyl. 99 Eng.; Late; W/Single Belt	5000020	6833	J.S.; W/Perkins 4-Cyl. 108 Eng.	5001001	A43
Fan; W/Perkins 4-Cyl. 99 Eng.; Late; W/Dual Belts	5000020	Ⓜ6833	Mtr.; W/Mercedes-Benz OM636 Eng.	5000103	ⓂB53
Fan; W/Perkins 4-Cyl. 99 Eng.; Conversion ..	5000062	Ⓜ6823	6004A		
Gen.; W/Perkins 4-Cyl. 99 Eng.; W/39" Belt O.C.	5000059	♣9385HD	Fan; W/Mercedes-Benz OM636 Eng.; W/Flat Idler Pulley .		♣9395HD
Gen.; W/Perkins 4-Cyl. 99 Eng.; W/40" Belt O.C.	5000021	♣9395HD	Fan; W/Mercedes-Benz OM636 Eng.; W/V-Groove Idler Pulley	5000085	♣9447HD
250CM			Fan; W/Perkins 4-Cyl. 108 Eng.; W/Flat Idler Pulley		♣9395HD
Alt.; W/Mercedes-Benz OM636 Eng.	5000077	7480	Fan; W/Perkins 4-Cyl. 108 Eng.; W/V-Groove Idler Pulley	5000085	♣9447HD
251; 254			Alt.; W/Mercedes-Benz OM636 Eng.	5010048	9279
Fan; W/Perkins 4-Cyl. 99 Eng.; Early	5000028	6824	Fan & Alt.; W/Perkins 4-Cyl. 108 Eng.	5000059	♣9385HD
Fan; W/Perkins 4-Cyl. 99 Eng.; Late; W/Single Belt	5000020	6833	Alt.; W/Perkins 4-Cyl. 108 Eng.; W/Standby Mtr.		A26
Fan; W/Perkins 4-Cyl. 99 Eng.; Late; W/Dual Belts	5000020	Ⓜ6833	Drive; W/Mercedes-Benz OM636 Eng.	5000104	A100
Fan; W/Perkins 4-Cyl. 99 Eng.; Conversion ..	5000062	Ⓜ6823	Mtr.; W/Perkins 4-Cyl. 108 Eng.	5000103	ⓂB53
Gen.; W/Perkins 4-Cyl. 99 Eng.; W/39" Belt O.C.	5000059	♣9385HD	6007; 6007A		
Gen.; W/Perkins 4-Cyl. 99 Eng.; W/40" Belt O.C.	5000021	♣9395HD	Fan & Alt.; W/Mercedes-Benz OM636 Eng. .	5000149	7470
260			Fan & Alt.; W/Perkins 4-Cyl. 108 Eng.	5000059	♣9385HD
Fan; W/Perkins 4-Cyl. 99 Eng.; Early	5000028	6824	6008; 6008A		
Fan; W/Perkins 4-Cyl. 99 Eng.; Late; W/Single Belt	5000020	6833	Compr.; W/Kohler K301S Eng.	500108601	Ⓜ3VX560
Fan; W/Perkins 4-Cyl. 99 Eng.; Late; W/Dual Belts	5000020	Ⓜ6833	Mtr.; W/Kohler K301S Eng.	500108602	Ⓜ3VX450
Fan; W/Perkins 4-Cyl. 99 Eng.; Conversion ..	5000062	Ⓜ6823	Genesis TM1000		
Gen.; W/Hercules lbx Eng.	5000026	9260	Alt.		♣9360HD
Gen.; W/Perkins 4-Cyl. 99 Eng.; W/39" Belt O.C.	5000059	♣9385HD	W.P.		♣9405HD
Gen.; W/Perkins 4-Cyl. 99 Eng.; W/40" Belt O.C.	5000021	♣9395HD	Fan		BX90
270			Compr.		BX64
Gen.; W/Hercules lbx Eng.	5000026	9260	NDB40		
640; 645; 650; 655			Alt.; W/Mercedes-Benz OM636 Eng.	5000162	♣9290HD
Fan & Alt.; W/Mercedes-Benz OM636 Eng. .	5000085	♣9447HD	Alt.; W/Perkins 4-Cyl. 108 Eng.	5000162	♣9290HD
Fan & Alt.; W/Perkins 4-Cyl. 99 Eng.; W/Flat Idler Pulley	5000059	♣9385HD	Compr.; W/Perkins Ct4-114 Eng.	500110101	BX48
Fan & Alt.; W/Perkins 4-Cyl. 99 Eng.; W/V-Groove Idler Pulley	5000085	♣9447HD	W.P.; W/Mercedes-Benz OM636 Eng.	5000149	7470
Drive; W/Mercedes-Benz OM636 Eng.	5000081	A92	W.P.; W/Perkins Ct4-114 Eng.	500016204	A39
Drive; W/Perkins 4-Cyl. 99 Eng.	5000081	A92	W.P.; W/Perkins 4-Cyl. 108 Eng.	5000093	♣9385HD
			Drive; W/Mercedes-Benz OM636 Eng.	5001001	A43
			Drive; W/Perkins Ct4-114 Eng.	500016206	A52
			Drive; W/Perkins 4-Cyl. 108 Eng.	5001001	A43
			NDE40		
			Alt.; W/Perkins 4-Cyl. 108 Eng.	500016202	7330
			W.P.; W/Perkins 4-Cyl. 108 Eng.	5000093	♣9385HD
			NDJ40		
			Fan; W/Perkins 4-Cyl. 108 Eng.	500100112	A65
			W.P.; W/Perkins 4-Cyl. 108 Eng.	5000093	♣9385HD
			Drive; W/Perkins 4-Cyl. 108 Eng.	500100110	A60

Refrigeration Units

ⓂTwo Required.

♣Standard Belt Available.

Belts for Truck Refrigeration Units

Application	Mfr. Part No.	Our No.
Transicold - Continued		
NDS40		
W.P.; W/Perkins 4-Cyl. 108 Eng.	5000093	♣9385HD
Drive; W/Perkins 4-Cyl. 108 Eng.	5000160	ⓂB49
J.S.; W/Perkins 4-Cyl. 108 Eng.	500100103	A46
NDT40		
Fan; W/Perkins 4-Cyl. 108 Eng.	500016203	AX62
Alt.; W/Perkins 4-Cyl. 108 Eng.	500016202	7330
W.P.; W/Perkins 4-Cyl. 108 Eng.	5000093	♣9385HD
Drive; W/Perkins 4-Cyl. 108 Eng.	500100108	A51
TDB; TDS		
Alt.; W/Kubota Zb600C Eng.	5001094	7380
Clutch; W/Kubota Zb600C Eng.	500108603	Ⓜ3VX500
Mtr.; W/Kubota Zb600C Eng.	500108602	Ⓜ3VX450
TGS		
Compr.; W/Kohler K301S Eng.	500108601	Ⓜ3VX560
Mtr.; W/Kohler K301S Eng.	500108602	Ⓜ3VX450
UDE; UDG		
Fan; W/Mercedes-Benz OM636 Eng.	5000062	Ⓜ6823
Fan; W/Perkins 4-Cyl. 108 Eng.	5000062	Ⓜ6823
W.P. & Alt.; W/Mercedes-Benz OM636 Eng.	5000077	7480
W.P. & Alt.; W/Perkins 4-Cyl. 108 Eng.	5000093	♣9385HD

Refrigeration
Units

ⓂTwo Required.

♣Standard Belt Available.

Belts and Coolant Hose for School Buses

Order Belts and Hose by Our Number. Manufacturers' Part Number is shown for reference only.

Application	Mfr. Part No.	Our No.	Application	Mfr. Part No.	Our No.
Amtran			Amtran - Continued		
2003			1998 - Continued		
International/Navistar DT466 Diesel			International/Navistar DT466 Diesel - Continued		
Conventional			Genesis		
Belt - Accessory Belt Drive Kit - Fan, Alt. & Hub		ACK080690HD	Belt - Serpentine		▲K080740HD
Belt - Fan, Alt. & Hub	1830727C2	▲K080690HD	Hose - Upper - Eng. To Rad.		22140
Tensioner Assy. - Fan, Alt. & Hub	1830033C1	38514	Hose - Lower - Eng. To Rad.		22762
Tensioner Pulley - Fan, Alt. & Hub	1830033C1	36091	International/Navistar T444 Diesel		
Hose - Upper - Eng. To Rad.		22776	3800		
Hose - Lower - Eng. To Rad.		21115	Belt - Accessory Belt Drive Kit		ACK081124HD
2002			Belt - Serpentine		▲K081124HD
International/Navistar DT466 Diesel			Tensioner Assy.	1822679C3	38510
Conventional			Hose - Upper - Eng. To Pipe		22159
Belt - Accessory Belt Drive Kit - Fan, Alt. & Hub		ACK080690HD	Hose - Lower - Eng. To Pipe		≧21042
Belt - Fan, Alt. & Hub	1830727C1	▲K080690HD	Hose - Lower - Pipe To Pipe		24248
Tensioner Assy. - Fan, Alt. & Hub	1830033C1	38514	Hose - Lower - Pipe To Rad.		≧21042
Tensioner Pulley - Fan, Alt. & Hub	1830033C1	36091	RE		
FE			Belt - Serpentine	1822832C1	▲K081124HD
Belt - Accessory Belt Drive Kit - Fan, Alt. & Hub		ACK080730HD	1997		
Belt - Fan, Alt. & Hub	1819391C1	▲K080730HD	International/Navistar DT466 Diesel		
Tensioner Assy. - Fan, Alt. & Hub	1830033C1	38514	Genesis		
Tensioner Pulley - Fan, Alt. & Hub	1830033C1	36091	Belt - Serpentine		
Hose - Lower - Eng. To Rad.		22783			
International/Navistar T444 Diesel					
FE					
Belt - Accessory Belt Drive Kit		ACK081124HD			
Belt - Serpentine	1822832C1	▲K081124HD			
Tensioner Assy.	1822679C4	38510			
Tensioner Pulley	1822679C4	36092			
Hose - Lower - Eng. To Rad.		22785			
RE					
Belt - Accessory Belt Drive Kit		ACK081124HD			
Belt - Serpentine	1822832C1	▲K081124HD			
Tensioner Assy.	1822679C4	38510			
Tensioner Pulley	1822679C4	36092			
Hose - Upper - Eng. To Rad.		22781			
Hose - Lower - Eng. To Rad.		22784			
2001 - 1999					
International/Navistar DT466 Diesel					
Genesis					
Belt - Serpentine		▲K080740HD			
International/Navistar T444 Diesel					
3800					
Belt - Accessory Belt Drive Kit		ACK081124HD			
Belt - Serpentine		▲K081124HD			
Tensioner Assy.	1822679C3	38510			
Hose - Upper - Eng. To Pipe		22159			
Hose - Lower - Eng. To Pipe		≧21042			
Hose - Lower - Pipe To Pipe		24248			
Hose - Lower - Pipe To Rad.		≧21042			
RE					
Belt - Serpentine	1822832C1	▲K081124HD			
1998					
International/Navistar DT466 Diesel					
3800					
Belt - Accessory Belt Drive Kit		ACK080726HD			
Belt - Serpentine	1822503C1	▲K080726HD			
Tensioner Assy.	1830033C1	38514			
Tensioner Pulley	1830033C1	36091			
Hose - Upper - Eng. To Rad.		22140			
Hose - Lower - Eng. To Rad.		≧21115			
International/Navistar T444 Diesel					
3800					
Belt - Accessory Belt Drive Kit		ACK081124HD			
Belt - Serpentine		▲K081124HD			
Tensioner Assy.	1822679C3	38510			
Hose - Upper - Eng. To Pipe		22159			
Hose - Lower - Eng. To Pipe		≧21042			
Hose - Lower - Pipe To Pipe		24248			
Hose - Lower - Pipe To Rad.		≧21042			
RE					
Belt - Serpentine	1822832C1	▲K081124HD			
International/Navistar T444 Diesel					
RE					
Belt - Serpentine	1822832C1	▲K081124HD			
1995 - 1994					
International/Navistar DT408 Diesel					
Genesis					
Belt - Fan; Nov. 14, 1994 & Older	1841575C1	▲K080730HD			
Belt - Fan; Nov. 15, 1994 & Newer	1819391C2	▲K080726HD			
Tensioner Assy. - Fan	1830033C2	38514			

School Buses

▲Standard Belt Available.
②Two Required.

≧Cut to Fit.

Belts and Coolant Hose for School Buses

School Buses

Application	Mfr. Part No.	Our No.	Application	Mfr. Part No.	Our No.
Amtran - Continued			Bluebird - Continued		
1995 - 1994 - Continued			2014 - Continued		
International/Navistar DT408 Diesel - Continued			Ford V-10 6.8 L LPG - Continued		
Genesis - Continued			Vision - Continued		
Tensioner Pulley - Fan	1830033C2	36091	Idler Pulley - Alt. (Upper)	3C3E 19A216 EB	36324
Hose - Lower; W/Frame Mounted Rad.		20987	2013		
International/Navistar DT466 Diesel			Cummins ISB6.7 Diesel		
Genesis			All American FE; All American RE; Vision		
Belt - Serpentine		♣K080740HD	Belt - Fan	3967026	K080813HD
International/Navistar T444 Diesel			Idler Pulley	4991240	36093
RE			Cummins ISL-G CNG		
Belt - Serpentine	1822832C1	♣K081124HD	All American RE		
1993			Belt - Accessory Belt Drive Kit		
International/Navistar DT466 Diesel					ACK080694HD1
Genesis			Belt - Serpentine	3289941	♣K080694HD
Belt - Serpentine		♣K080740HD	Tensioner Assy.	3973819	38627
International/Navistar T444 Diesel			Ford V-10 6.8 L LPG		
RE			Vision		
Belt - Serpentine	1822832C1	♣K081124HD	Belt - Fan	P11BB 8620 BA	♣K060883HD
1992 - 1991			Belt - Alt.; W/O A.C.	10020698	♣K081005HD
International/Navistar DT466 Diesel			Tensioner Assy. - Fan	2L3E 6B209 AB	38329
Genesis			Idler Pulley - Alt. (Upper)	3C3E 19A216 EB	36324
Belt - Serpentine		♣K080740HD	2012		
Bluebird			Cummins ISB-10 Diesel		
2016			All American FE; All American RE		
Cummins ISB6.7 Diesel			Belt - Fan	3972384	K080794HD
All American FE; All American RE; Vision			Idler Pulley	4991240	36093
Belt - Serpentine	5267628	♣K080830HD	Vision		
Idler Pulley	4991240	36093	Belt - Fan	3967026	K080813HD
2015			Belt - Main Drive	10021305	♣K080797HD
Cummins ISB6.7 Diesel			Idler Pulley	4991240	36093
All American FE; All American RE; Vision			Cummins ISL-G CNG		
Belt - Serpentine	3972383	♣K080806HD	All American RE		
Idler Pulley	4991240	36093	Belt - Serpentine - Fan, W.P. & Alt.	3289124	♣K080665HD
Cummins ISL-G CNG			Tensioner Assy.	3973819	38627
All American RE			Idler Pulley	4991240	36093
Belt - Accessory Belt Drive Kit		ACK080694HD1	Ford V-10 6.8 L LPG		
Belt - Serpentine	3289941	♣K080694HD	Vision		
Tensioner Assy.	3973819	38627	Belt - Accessory Belt Drive Kit - Fan		ACK060883HD
2014			Belt - Fan	P11BB 8620 BA	♣K060883HD
Cummins ISB6.7 Diesel			Belt - Alt.; W/O A.C.	10020698	♣K081005HD
All American FE; All American RE			Tensioner Assy. - Fan	2L3E 6B209 AB	38329
Belt - Fan	3972383	♣K080806HD	Idler Pulley - Alt. (Upper)	3C3E 19A216 EB	36324
Idler Pulley	4991240	36093	2011		
Vision			Cummins ISB-07 Diesel		
Belt - Fan	3967026	K080813HD	All American FE; All American RE		
Idler Pulley	4991240	36093	Belt - Fan	3967026	K080813HD
Cummins ISL-G CNG			Idler Pulley	4991240	36093
All American RE			Vision		
Belt - Accessory Belt Drive Kit		ACK080694HD1	Belt - Fan	3972384	K080794HD
Belt - Serpentine	3289941	♣K080694HD	Idler Pulley	4991240	36093
Tensioner Assy.	3973819	38627	Cummins ISC Diesel		
2014			All American RE		
Cummins ISB6.7 Diesel			Belt - Accessory Belt Drive Kit - Alt. & W.P.		
All American FE; All American RE					ACK080716HD
Belt - Fan	3972383	♣K080806HD	Belt - Alt. & W.P.	3290018	♣K080716HD
Idler Pulley	4991240	36093	Belt - Fan; W/A.C.	10004148	3/3V879
Vision			Belt - A.C.	10004072	♣K080570HD
Belt - Fan	3967026	K080813HD	Tensioner Assy. - Alt. & W.P.	3976834	38516
Idler Pulley	4991240	36093	Tensioner Assy. - Fan	10009072	38555
Cummins ISL-G CNG			Tensioner Pulley - Fan		36350
All American RE			Ford V-10 6.8 L LPG		
Belt - Accessory Belt Drive Kit		ACK080694HD1	Vision		
Belt - Serpentine	3289941	♣K080694HD	Belt - Fan	P11BB 8620 BA	♣K060883HD
Tensioner Assy.	3973819	38627	Belt - Alt.; W/O A.C.	10020698	♣K081005HD
2014			Tensioner Assy. - Fan	2L3E 6B209 AB	38329
Cummins ISB6.7 Diesel			All American FE; All American RE		
All American FE; All American RE			Belt - Fan	3967026	K080813HD
Belt - Fan	3972383	♣K080806HD	Idler Pulley	4991240	36093
Idler Pulley	4991240	36093	Vision		
Vision			Belt - Fan	3972384	K080794HD
Belt - Fan	3967026	K080813HD	Idler Pulley	4991240	36093
Idler Pulley	4991240	36093	Cummins ISC Diesel		
Cummins ISL-G CNG			All American RE		
All American RE			Belt - Accessory Belt Drive Kit - Alt. & W.P.		
Belt - Accessory Belt Drive Kit		ACK080694HD1			ACK080716HD
Belt - Serpentine	3289941	♣K080694HD	Belt - Alt. & W.P.	3290018	♣K080716HD
Tensioner Assy.	3973819	38627	Belt - Fan; W/A.C.	10004148	3/3V879
2014			Belt - A.C.	10004072	♣K080570HD
Ford V-10 6.8 L LPG			Tensioner Assy. - Alt. & W.P.	3976834	38516
Vision			Tensioner Assy. - Fan	10009072	38555
Belt - Fan	P11BB 8620 BA	♣K060883HD	Tensioner Pulley - Fan		36350
Belt - Alt.; W/O A.C.	10020698	♣K081005HD			
Tensioner Assy. - Fan	2L3E 6B209 AB	38329			

♣Standard Belt Available.

Belts and Coolant Hose for School Buses

Application	Mfr. Part No.	Our No.	Application	Mfr. Part No.	Our No.
Bluebird - Continued			Bluebird - Continued		
2011 - Continued			2008 - Continued		
Cummins ISL-G CNG			Cummins ISB-07 Diesel		
All American RE			All American FE; All American RE		
Belt - Serpentine - Fan, W.P. & Alt.	3289124	♣K080665HD	Belt - Accessory Belt Drive Kit		ACK080817HD
Tensioner Assy.	3976834	38516	Belt - Serpentine	3972382	♣K080817HD
Idler Pulley	4991240	36093	Tensioner Assy.	5264111	38631
2010			Idler Pulley	4991240	36093
Cummins ISB-07 Diesel			Hose - Turbo To Pipe (Hot Side)		26230
All American FE; All American RE			Hose - Pipe To Engine (Cold Side)		26200
Belt - Accessory Belt Drive Kit		ACK080817HD	Vision		
Belt - Alt. & W.P.	3972382	♣K080817HD	Belt - Accessory Belt Drive Kit		ACK080806HD1
Tensioner Assy. - Alt. & W.P.	5264111	38631	Belt - Accessory Drive	4940003	♣K080806HD
Idler Pulley	4991240	36093	Tensioner Assy. - Fan, Alt. & A.C.	4937433	38631
Vision			Idler Pulley	4991240	36093
Belt - Accessory Belt Drive Kit - Fan, Alt. & W.P.		ACK080806HD1	Hose - Turbo To Pipe (Hot Side)		26230
Belt - W.P., Fan & Alt.	4940003	♣K080806HD	Hose - Pipe To Engine (Cold Side)		26200
Belt - A.C.; W/Dual A.C.	5060770	♣K060772HD	Cummins ISC Diesel		
Tensioner Assy. - Fan, W.P. & Alt.	4937433	38631	All American RE		
Idler Pulley	4991240	36093	Belt - Accessory Belt Drive Kit		
Cummins ISC Diesel			Belt - Serpentine		
All American RE			Belt - Serpentine		
Belt - Serpentine	3289941	♣K080694HD	Tensioner Assy.		
Belt - Accessory Belt Drive Kit		ACK080694HD1	Tensioner Assy.		
Tensioner Assy.	3973819	38627	Tensioner Assy.		
2009			2007		
Caterpillar C7 Diesel			Caterpillar C7 Diesel		
All American FE			All American FE		
Belt - Accessory Drive	292-2187	K100686HD	Belt - Accessory Belt Drive Kit - Alt.		ACK080580HD1
Vision			Belt - Accessory Drive	292-2187	K100686HD
Belt - Accessory Belt Drive Kit		ACK080776HD	Belt - Fan & Alt.	1454636	♣K080580HD
Belt - Alt.	0064546	♣K080776HD	Belt - W.P.	0366775	♣9341HD
Tensioner Assy. - Fan, W.P. & Alt.	2201209	38550	Tensioner Assy. - Fan & Alt.	7E3999	38509
Idler Pulley - Grooved	1731498	36231	All American RE		
Hose - Upper		24197	Belt - Accessory Belt Drive Kit		
Hose - Lower		24198	Belt - Fan & Alt.		
Cummins ISB-07 Diesel			Belt - W.P.		
All American FE; All American RE			Tensioner Assy. - Fan & Alt.		
Belt - Accessory Belt Drive Kit		ACK080817HD	Belt - Accessory Belt Drive Kit		
Belt - Alt.	3972382	♣K080817HD	Belt - Fan & Alt.		
Tensioner Assy. - Alt.	4937433	38631	Belt - W.P.		
Idler Pulley	4991240	36093	Tensioner Assy. - Fan & Alt.		
Vision			Belt - Accessory Belt Drive Kit		
Belt - Accessory Belt Drive Kit - Fan, Alt. & W.P.		ACK080806HD1	Belt - Fan & Alt.		
Belt - W.P., Fan & Alt.	4940003	♣K080806HD	Belt - W.P.		
Belt - A.C.; W/Dual A.C.	5060770	♣K060772HD	Tensioner Assy. - Fan & Alt.		
Tensioner Assy. - Fan, W.P. & Alt.	4937433	38631	Belt - Accessory Belt Drive Kit		
Idler Pulley	4991240	36093	Belt - Alt.		
Cummins ISC Diesel			Tensioner Assy. - Fan, W.P. & Alt.		
All American RE			Tensioner Assy. - Alt.		
Belt - Accessory Belt Drive Kit		ACK080694HD1	Idler Pulley - Grooved		
Belt - Serpentine	3289941	♣K080694HD	Hose - Upper		
Tensioner Assy.	3973819	38627	Hose - Lower		
2008			Cummins ISB Diesel		
Caterpillar C7 Diesel			All American FE; All American RE		
All American FE			Belt - Accessory Belt Drive Kit - Fan, Alt. & W.P.		
Belt - Accessory Drive	292-2187	K100686HD	Belt - W.P., Fan & Alt.		
Vision			Tensioner Assy. - Fan, W.P. & Alt.		
Belt - Accessory Belt Drive Kit		ACK080776HD	Idler Pulley		
Belt - Alt.	0064546	♣K080776HD	Hose - Turbo To Pipe (Hot Side)		
Tensioner Assy. - Fan, W.P. & Alt.	2201209	38550	Hose - Pipe To Engine (Cold Side)		
Idler Pulley - Grooved	1731498	36231	Vision		
Cummins ISB-07 Diesel			Belt - Serpentine		
All American FE; All American RE			Belt - Serpentine		
Belt - Accessory Belt Drive Kit		ACK080817HD	Belt - Accessory Belt Drive Kit		
Belt - Alt.	3972382	♣K080817HD	Tensioner Assy.		
Tensioner Assy. - Alt.	4937433	38631	Tensioner Assy.		
Idler Pulley	4991240	36093	Idler Pulley		
Vision			Hose - Turbo To Pipe (Hot Side)		
Belt - Accessory Belt Drive Kit - Fan, Alt. & W.P.		ACK080806HD1	Hose - Pipe To Engine (Cold Side)		
Belt - W.P., Fan & Alt.	4940003	♣K080806HD	Vision		
Belt - A.C.; W/Dual A.C.	5060770	♣K060772HD	Belt - Serpentine		
Tensioner Assy. - Fan, W.P. & Alt.	4937433	38631	Belt - Accessory Belt Drive Kit		
Idler Pulley	4991240	36093	Tensioner Assy.		
Cummins ISC Diesel			Idler Pulley		
All American RE			Hose - Turbo To Pipe (Hot Side)		
Belt - Accessory Belt Drive Kit		ACK080694HD1	Hose - Pipe To Engine (Cold Side)		
Belt - Serpentine	3289941	♣K080694HD	Vision		
Tensioner Assy.	3973819	38627	Belt - Serpentine		
2008			Belt - Accessory Belt Drive Kit		
Caterpillar C7 Diesel			Tensioner Assy.		
All American FE			Idler Pulley		
Belt - Accessory Drive	292-2187	K100686HD	Hose - Turbo To Pipe (Hot Side)		
Vision			Hose - Pipe To Engine (Cold Side)		
Belt - Accessory Belt Drive Kit		ACK080776HD	Cummins ISB-07 Diesel		
Belt - Alt.	0064546	♣K080776HD	All American FE; Vision		
Tensioner Assy. - Fan, W.P. & Alt.	2201209	38550	Belt - Serpentine		
Idler Pulley - Grooved	1731498	36231	Belt - Accessory Belt Drive Kit		
Cummins ISB-07 Diesel			Tensioner Assy.		
All American FE; All American RE			Idler Pulley		
Belt - Accessory Belt Drive Kit		ACK080817HD	Hose - Turbo To Pipe (Hot Side)		
Belt - Alt.	3972382	♣K080817HD	Hose - Pipe To Engine (Cold Side)		
Tensioner Assy. - Alt.	4937433	38631	Vision		
Idler Pulley	4991240	36093	Belt - Serpentine		
Vision			Belt - Accessory Belt Drive Kit		
Belt - Accessory Belt Drive Kit - Fan, Alt. & W.P.		ACK080806HD1	Tensioner Assy.		
Belt - W.P., Fan & Alt.	4940003	♣K080806HD	Idler Pulley		
Belt - A.C.; W/Dual A.C.	5060770	♣K060772HD	Hose - Turbo To Pipe (Hot Side)		
Tensioner Assy. - Fan, W.P. & Alt.	4937433	38631	Hose - Pipe To Engine (Cold Side)		
Idler Pulley	4991240	36093	Vision		
Cummins ISC Diesel			Belt - Serpentine		
All American RE			Belt - Accessory Belt Drive Kit		
Belt - Accessory Belt Drive Kit		ACK080694HD1	Tensioner Assy.		
Belt - Serpentine	3289941	♣K080694HD	Idler Pulley		
Tensioner Assy.	3973819	38627	Hose - Turbo To Pipe (Hot Side)		
2008			Hose - Pipe To Engine (Cold Side)		
Caterpillar C7 Diesel			Cummins ISB-07 Diesel		
All American FE			All American FE; Vision		
Belt - Accessory Drive	292-2187	K100686HD	Belt - Serpentine		
Vision			Belt - Accessory Belt Drive Kit		
Belt - Accessory Belt Drive Kit		ACK080776HD	Tensioner Assy.		
Belt - Alt.	0064546	♣K080776HD	Idler Pulley		
Tensioner Assy. - Fan, W.P. & Alt.	2201209	38550	Hose - Turbo To Pipe (Hot Side)		
Idler Pulley - Grooved	1731498	36231	Hose - Pipe To Engine (Cold Side)		

School Buses

♣Standard Belt Available.

Belts and Coolant Hose for School Buses

Application	Mfr. Part No.	Our No.	Application	Mfr. Part No.	Our No.
Bluebird - Continued			Bluebird - Continued		
2007 - Continued			2005 - Continued		
Cummins ISB-07 Diesel - Continued			International/Navistar DT466 Diesel		
All American FE; Vision - Continued			Conventional		
Hose - Pipe To Engine (Cold Side)		26200	Belt - Serpentine		♣K080740HD
2006			2004		
Caterpillar C7 Diesel			Caterpillar 3126 Diesel		
All American FE			All American FE		
Belt - Accessory Belt Drive Kit - Alt.		ACK080580HD1	Belt - Accessory Belt Drive Kit		ACK080580HD1
Belt - Accessory Drive	292-2187	K100686HD	Belt - Fan & Alt.	1454636	♣K080580HD
Belt - Alt.	1454636	♣K080580HD	Tensioner Assy. - Fan & Alt.	1450261	38509
Belt - W.P.	0366775	♣9341HD	All American RE		
Tensioner Assy. - Alt.	7E3999	38509	Belt - Accessory Belt Drive Kit - Hub & Alt.		ACK080510HD
All American RE			Belt - Hub & Alt.		♣K080510HD
Belt - Accessory Belt Drive Kit - Hub & Alt.		ACK080510HD	Belt - W.P.	0366775	♣9341HD
Belt - Hub & Alt.	5080510	♣K080510HD	Tensioner Assy. - Hub & Alt.	7E3999	38509
Belt - W.P.	0366775	♣9341HD	Tensioner Pulley	7E3999	36091
Tensioner Assy. - Hub & Alt.	7E3999	38509	Vision		
Tensioner Pulley	7E3999	36091	Belt - Alt.	0061258	♣K080700HD
Vision			Belt - W.P.	0366775	♣9341HD
Belt - Accessory Belt Drive Kit		ACK080776HD	Hose - Upper		24197
Belt - Fan, Alt. & W.P.	0064546	♣K080776HD	Hose - Lower		24198
Tensioner Assy. - Fan, W.P. & Alt.	2201209	38550	Caterpillar C7 Diesel		
Idler Pulley - Grooved	1731498	36231	All American FE		
Hose - Upper		24197	Belt - Accessory Belt Drive Kit - Alt.		ACK080580HD1
Hose - Lower		24198	Belt - Accessory Drive	292-2187	K100686HD
Cummins ISB Diesel			Belt - Alt.	1454636	♣K080580HD
Vision			Belt - W.P.	0366775	♣9341HD
Belt - Accessory Belt Drive Kit		ACK080785HD1	Tensioner Assy. - Fan & Alt.	1450261	38509
Belt - Fan & Alt.	4937693	♣K080785HD	Hose - Upper		26509
Tensioner Assy. - Fan & Alt.	3936205	38525	Hose - Lower - Pipe To Rad.		26512
Ford V-8 6.0 L Diesel			Cummins ISB Diesel		
Micro Bird			TC2000		
Belt - Fan, Alt. & A.C.	3C2E 8620 AB	♣K081298HD	Belt - Accessory Belt Drive Kit; W/49 1/8" Belt O.C.		ACK080485HD
John Deere 6-Cyl. 8.1 L Diesel			Belt - Accessory Belt Drive Kit; W/54 3/8" Belt O.C.		ACK080537HD
All American RE			Belt - Accessory Belt Drive Kit - Alt. & W.P.; W/74 5/8" Belt O.C.		ACK080740HD
Belt - Accessory Belt Drive Kit		ACK080680HD	Belt - Accessory Belt Drive Kit - Alt. & W.P.; W/58 5/8" Belt O.C.		ACK080580HD
Belt - Alt.	R128197	♣K080680HD	Belt - Accessory Belt Drive Kit; W/51 1/2" Belt O.C.		ACK080510HD1
Tensioner Assy. - Alt.	RE518097	38507	Belt - Fan & Alt.; W/49 1/8" Belt O.C.		♣K080485HD
2005			Belt - Fan & Alt.; W/51 1/2" Belt O.C.	1454628	♣K080510HD
Caterpillar C7 Diesel			Belt - Fan & Alt.; W/54 3/8" Belt O.C.	1373281	♣K080537HD
All American FE			Belt - Fan & Alt.; W/58 5/8" Belt O.C.	2791517325	♣K080580HD
Belt - Accessory Belt Drive Kit - Alt.		ACK080580HD1	Belt - Fan & Alt.; W/74 5/8" Belt O.C.	1373323	♣K080740HD
Belt - Accessory Drive	292-2187	K100686HD	Tensioner Assy.	3936213	38516
Belt - Alt.	1454636	♣K080580HD	Cummins ISC Diesel		
Belt - W.P.	0366775	♣9341HD	All American RE		
Tensioner Assy. - Alt.	7E3999	38509	Belt - Accessory Belt Drive Kit		ACK080694HD3
All American RE			Belt - Serpentine	3926856	♣K080694HD
Belt - Accessory Belt Drive Kit - Hub & Alt.		ACK080510HD	Tensioner Assy.	3937555	38525
Belt - Hub & Alt.		♣K080510HD	Ford V-8 6.0 L Diesel		
Belt - W.P.	0366775	♣9341HD	Micro Bird		
Tensioner Assy. - Hub & Alt.	7E3999	38509	Belt - Fan, Alt. & A.C.	3C2E 8620 AB	♣K081298HD
Tensioner Pulley	7E3999	36091	International/Navistar DT466 Diesel		
Vision			Conventional		
Belt - Accessory Belt Drive Kit		ACK080776HD	Belt - Accessory Belt Drive Kit		ACK080720HD
Belt - Alt.	0064546	♣K080776HD	Belt - Serpentine	1822503C2	♣K080720HD
Tensioner Assy. - Fan, W.P. & Alt.	2201209	38550	Tensioner Assy.	1830033C1	38514
Idler Pulley - Grooved	1731498	36231	Tensioner Pulley	1830033C1	36091
Hose - Upper		24197	Hose - Upper - Eng. To Rad.		22140
Hose - Lower		24198	Ford V-8 6.0 L Diesel		
Ford V-8 6.0 L Diesel			Micro Bird		
Micro Bird			Belt - Fan, Alt. & A.C.		
Belt - Fan, Alt. & A.C.	3C2E 8620 AB	♣K081298HD			

♣Standard Belt Available.

Belts and Coolant Hose for School Buses

Application	Mfr. Part No.	Our No.	Application	Mfr. Part No.	Our No.
Bluebird - Continued			Bluebird - Continued		
2003			2002 - Continued		
Caterpillar 3126 Diesel			Cummins ISB Diesel - Continued		
All American RE			TC2000 - Continued		
Belt - Accessory Belt Drive Kit - Hub & Alt.		ACK080510HD	Hose - Lower - Pipe To Cooler		≈21194
Belt - Hub & Alt.		♣K080510HD	Hose - Lower - Cooler To Pipe		24236
Belt - W.P.	0366775	♣9341HD	Hose - Lower - Pipe To Rad.		22177
Tensioner Assy. - Hub & Alt.	7E3999	38509	Cummins ISC Diesel		
Tensioner Pulley	7E3999	36091	All American RE		
Cummins ISB Diesel			Belt - Accessory Belt Drive Kit		
TC2000			Belt - Serpentine		
Belt - Accessory Belt Drive Kit; W/49 1/8" Belt O.C.		ACK080485HD	Tensioner Assy.		
Belt - Accessory Belt Drive Kit; W/54 3/8" Belt O.C.		ACK080537HD	Tensioner Pulley		
Belt - Accessory Belt Drive Kit - Alt. & W.P.; W/74 5/8" Belt O.C.		ACK080740HD	Ford V-8 7.3 L 444 CID Diesel		
Belt - Accessory Belt Drive Kit - Alt. & W.P.; W/58 5/8" Belt O.C.		ACK080580HD	Micro Bird		
Belt - Accessory Belt Drive Kit; W/51 1/2" Belt O.C.		ACK080510HD1	Belt - Serpentine		
Belt - Fan & Alt.; W/49 1/8" Belt O.C.		♣K080485HD	International/Navistar DT466 Diesel		
Belt - Fan & Alt.; W/51 1/2" Belt O.C.	1454628	♣K080510HD	Conventional		
Belt - Fan & Alt.; W/54 3/8" Belt O.C.	1373281	♣K080537HD	Belt - Accessory Belt Drive Kit		
Belt - Fan & Alt.; W/58 5/8" Belt O.C.	2791517325	♣K080580HD	Belt - Serpentine		
Belt - Fan & Alt.; W/74 5/8" Belt O.C.	1373323	♣K080740HD	Tensioner Assy.		
Tensioner Assy.	3936213	38516	Tensioner Pulley		
Cummins ISC Diesel			Hose - Upper - Eng. To Rad.		
All American RE			Hose - Lower - Eng. To Rad.		
Belt - Accessory Belt Drive Kit		ACK080690HD1	John Deere 6-Cyl. 8.1 L CNG		
Belt - Serpentine	3911581	♣K080690HD	All American RE		
Tensioner Assy.	3936213	38516	Belt - Serpentine		
Tensioner Pulley	3936213	36093	Belt - Accessory Belt Drive Kit		
International/Navistar DT466 Diesel			Tensioner Assy.		
Conventional			Tensioner Pulley		
Belt - Accessory Belt Drive Kit		ACK080726HD	All American FE		
Belt - Serpentine	1822503C1	♣K080726HD	Belt - Serpentine		
Tensioner Assy.	1830033C1	38514	Conventional		
Tensioner Pulley	1830033C1	36091	Belt - Accessory Belt Drive Kit		
Hose - Upper - Eng. To Rad.		22140	Belt - Alt. & W.P.		
Hose - Lower - Eng. To Rad.		20987	Tensioner Assy. - Alt. & W.P.		
John Deere 6-Cyl. 8.1 L CNG			Tensioner Pulley - Alt. & W.P.		
All American RE			TC2000		
Belt - Accessory Belt Drive Kit		ACK080680HD	Belt - Accessory Belt Drive Kit; W/49 1/8" Belt O.C.		
Belt - Eng. To Alt.	R128197	♣K080680HD	Belt - Accessory Belt Drive Kit; W/54 3/8" Belt O.C.		
Belt - A.C.		BX83	Belt - Accessory Belt Drive Kit - Alt. & W.P.; W/74 5/8" Belt O.C.		
Belt - A.C. To Alt.		♣9476HD	ACK080740HD		
Tensioner Assy. - Eng. To Alt.	RE70535	38507	Belt - Accessory Belt Drive Kit - Alt. & W.P.; W/58 5/8" Belt O.C.		
Tensioner Pulley - Eng. To Alt.	RE70535	36091	ACK080580HD		
2002			Belt - Fan & Alt.; W/49 1/8" Belt O.C.		
Cummins ISB Diesel			♣K080485HD		
All American FE			Belt - Fan & Alt.; W/54 3/8" Belt O.C.		
Belt - Serpentine	3289224	♣K080685HD	1373281		
TC2000			Belt - Fan & Alt.; W/58 5/8" Belt O.C.		
Belt - Accessory Belt Drive Kit; W/49 1/8" Belt O.C.		ACK080485HD	2791517325		
Belt - Accessory Belt Drive Kit; W/54 3/8" Belt O.C.		ACK080537HD	Belt - Fan & Alt.; W/74 5/8" Belt O.C.		
Belt - Accessory Belt Drive Kit - Alt. & W.P.; W/74 5/8" Belt O.C.		ACK080740HD	1373323		
Belt - Accessory Belt Drive Kit - Alt. & W.P.; W/58 5/8" Belt O.C.		ACK080580HD	Tensioner Assy.		
Belt - Fan & Alt.; W/49 1/8" Belt O.C.		♣K080485HD	3936213		
Belt - Fan & Alt.; W/54 3/8" Belt O.C.	1373281	♣K080537HD	Hose - Upper - Eng. To Pipe		
Belt - Fan & Alt.; W/58 5/8" Belt O.C.	2791517325	♣K080580HD	Hose - Upper - Pipe To Rad.		
Belt - Fan & Alt.; W/74 5/8" Belt O.C.	1373323	♣K080740HD	≈21891		
Tensioner Assy.	3936213	38516	Hose - Lower - Eng. To Pipe		
Hose - Upper - Eng. To Pipe		26601	≈21194		
Hose - Upper - Pipe To Rad.		≈21891	Hose - Lower - Pipe To Cooler		
Hose - Lower - Eng. To Pipe		≈21194	Hose - Lower - Cooler To Pipe		
Hose - Lower - Pipe To Cooler		≈21194	Hose - Lower - Pipe To Rad.		
Hose - Lower - Cooler To Pipe		24236	22177		
Hose - Lower - Pipe To Rad.		22177	Cummins ISC Diesel		
Cummins ISC Diesel			All American RE		
All American RE			Belt - Accessory Belt Drive Kit		
Belt - Accessory Belt Drive Kit		ACK080680HD2	Belt - Serpentine		
Belt - Serpentine	3911620	♣K080680HD	Tensioner Assy.		
Tensioner Assy.	3936213	38516	Tensioner Pulley		
Tensioner Pulley	3936213	36093			

♣Standard Belt Available.

≈Cut to Fit.

School Buses

Belts and Coolant Hose for School Buses

School Buses

Application	Mfr. Part No.	Our No.	Application	Mfr. Part No.	Our No.
Bluebird - Continued			Bluebird - Continued		
2001 - Continued			2000 - Continued		
International/Navistar DT466 Diesel			John Deere 6-Cyl. 8.1 L CNG		
Conventional			All American RE		
Belt - Accessory Belt Drive Kit		ACK080726HD	Belt - Serpentine	R128197	♣K080680HD
Belt - Serpentine	1822503C1	♣K080726HD	Belt - Accessory Belt Drive Kit		ACK080680HD
Tensioner Assy.	1830033C1	38514	Tensioner Assy.	RE70535	38507
Tensioner Pulley	1830033C1	36091	Tensioner Pulley	RE70535	36091
Hose - Upper - Eng. To Rad.		22140	Envirobus 2000		
Hose - Lower - Eng. To Rad.		≈<21115	Belt - Serpentine	1682693C1	♣K080708HD
John Deere 6-Cyl. 8.1 L CNG			Hose - Upper		②24232
All American RE			Hose - Lower - Eng. To Pipe		≈<20206
Belt - Serpentine	R128197	♣K080680HD	Hose - Lower - Heat Exch. To Pipe		24232
Belt - Accessory Belt Drive Kit		ACK080680HD	Hose - Lower - Pipe To Heat Exch.		24232
Tensioner Assy.	RE70535	38507	Hose - Lower - Pipe To Pipe		24232
Tensioner Pulley	RE70535	36091	Hose - Lower - Pipe To Rad.		≈<20206
Envirobus 2000			1999		
Belt - Serpentine	1682693C1	♣K080708HD	Cummins ISB Diesel		
Hose - Upper		②24232	All American RE		
Hose - Lower - Eng. To Pipe		≈<20206	Belt - Accessory Belt Drive Kit - Alt. & W.P.		ACK080716HD
Hose - Lower - Heat Exch. To Pipe		24232	Belt - Alt. & W.P.	3922562	♣K080716HD
Hose - Lower - Pipe To Heat Exch.		24232	Belt - A.C.		♣9455HD
Hose - Lower - Pipe To Pipe		24232	Belt - Fan & Alt.; W/64" Belt O.C.		♣K080638HD
Hose - Lower - Pipe To Rad.		≈<20206	Tensioner Assy. - Alt. & W.P.	3945527	38516
2000			Tensioner Pulley - Alt. & W.P.	3945527	36093
Cummins ISB Diesel			Hose - Upper - Eng. To Pipe		20206
All American FE			Hose - Upper - Pipe To Rad.		20172
Belt - Serpentine	3289224	♣K080685HD	TC1000		
TC2000			Belt - Serpentine	3289224	♣K080685HD
Belt - Accessory Belt Drive Kit; W/49 1/8" Belt O.C.		ACK080485HD	TC2000		
Belt - Accessory Belt Drive Kit; W/54 3/8" Belt O.C.		ACK080537HD	Belt - Accessory Belt Drive Kit; W/49 1/8" Belt O.C.		ACK080485HD
Belt - Accessory Belt Drive Kit - Alt. & W.P.; W/74 5/8" Belt O.C.		ACK080740HD	Belt - Accessory Belt Drive Kit; W/54 3/8" Belt O.C.		ACK080537HD
Belt - Accessory Belt Drive Kit - Alt. & W.P.; W/58 5/8" Belt O.C.		ACK080580HD	Belt - Accessory Belt Drive Kit - Alt. & W.P.; W/74 5/8" Belt O.C.		ACK080740HD
Belt - Alt. & W.P.; W/49 1/8" Belt O.C.		♣K080485HD	Belt - Accessory Belt Drive Kit - Alt. & W.P.; W/58 5/8" Belt O.C.		ACK080580HD
Belt - Alt. & W.P.; W/54 3/8" Belt O.C.	1373281	♣K080537HD	Belt - Alt. & W.P.; W/49 1/8" Belt O.C.		♣K080485HD
Belt - Alt. & W.P.; W/58 5/8" Belt O.C.	2791517325	♣K080580HD	Belt - Alt. & W.P.; W/54 3/8" Belt O.C.	1373281	♣K080537HD
Belt - Alt. & W.P.; W/74 5/8" Belt O.C.	1373323	♣K080740HD	Belt - Alt. & W.P.; W/58 5/8" Belt O.C.	2791517325	♣K080580HD
Tensioner Assy. - Alt. & W.P.	3945527	38516	Belt - Alt. & W.P.; W/74 5/8" Belt O.C.	1373323	♣K080740HD
Tensioner Pulley - Alt. & W.P.	3945527	36093	Tensioner Assy. - Alt. & W.P.	3945527	38516
Hose - Upper - Eng. To Pipe		26601	Tensioner Pulley - Alt. & W.P.	3945527	36093
Hose - Upper - Pipe To Rad.		≈<21891	Hose - Upper - Eng. To Pipe		26601
Hose - Lower - Eng. To Pipe		≈<21194	Hose - Upper - Pipe To Rad.		≈<21891
Hose - Lower - Pipe To Cooler		≈<21194	Hose - Lower - Eng. To Pipe		≈<21194
Hose - Lower - Cooler To Pipe		24236	Hose - Lower - Pipe To Cooler		≈<21194
Hose - Lower - Pipe To Rad.		22177	Hose - Lower - Cooler To Pipe		24236
Cummins ISC Diesel			Hose - Lower - Pipe To Rad.		22177
All American RE			Cummins ISC Diesel		
Belt - Accessory Belt Drive Kit; W/61 3/4" Belt O.C.		ACK080610HD	All American RE		
Belt - Accessory Belt Drive Kit - Fan & Alt.; W/63 5/8" Belt O.C.		ACK080630HD1	Belt - Accessory Belt Drive Kit; W/61 3/4" Belt O.C.		ACK080610HD
Belt - Accessory Belt Drive Kit; W/64 1/4" Belt O.C.		ACK080638HD	Belt - Accessory Belt Drive Kit - Fan & Alt.; W/63 5/8" Belt O.C.		ACK080630HD1
Belt - Fan & Alt.; W/61 3/4" Belt O.C.	3911572	♣K080610HD	Belt - Accessory Belt Drive Kit; W/64 1/4" Belt O.C.		ACK080638HD
Belt - Fan & Alt.; W/63 5/8" Belt O.C.		♣K080630HD	Belt - Fan & Alt.; W/61 3/4" Belt O.C.	3911572	♣K080610HD
Belt - Fan & Alt.; W/64 1/4" Belt O.C.	8304073	♣K080638HD	Belt - Fan & Alt.; W/63 5/8" Belt O.C.		♣K080630HD
Tensioner Assy.	3976832	38513	Belt - Fan & Alt.; W/64 1/4" Belt O.C.	8304073	♣K080638HD
Tensioner Pulley	3976832	36091	Tensioner Assy.	3976832	38513
Hose - Upper; Strt. Hose		24236	Tensioner Pulley	3976832	36091
Hose - Upper; Molded Hose		26528	Hose - Upper; Strt. Hose		24236
Hose - Lower		25804	Hose - Upper; Molded Hose		26528
International/Navistar DT466 Diesel			Hose - Lower		25804
Conventional			International/Navistar DT466 Diesel		
Tensioner Assy.	1830033C1	38514	Conventional		
Tensioner Pulley	1830033C1	36091	Belt - Serpentine	1819391C1	♣K080730HD
Hose - Upper - Eng. To Rad.		22140	Belt - Accessory Belt Drive Kit		ACK080730HD
			Tensioner Assy.	1830033C1	38514

♣Standard Belt Available.
②Two Required.

≈<Cut to Fit.

Belts and Coolant Hose for School Buses

Application	Mfr. Part No.	Our No.	Application	Mfr. Part No.	Our No.
Bluebird - Continued			Bluebird - Continued		
1999 - Continued			1998 - Continued		
International/Navistar DT466 Diesel - Continued			GM V-8 5.7 L - Continued		
Conventional - Continued			Mini Bird - Continued		
Tensioner Pulley	1830033C1	36091	Belt - Serpentine; W/A.C.; W/124A., 145A. Alt.		K060966
Hose - Upper - Eng. To Rad.		22140	Belt - Serpentine; W/O A.C.; W/105A. Alt.		♣K060870HD
1998			Belt - Serpentine; W/O A.C.; W/124A., 145A. Alt.		♣K060875HD
Caterpillar 3126 Diesel			Tensioner Assy.		38103
TC2000			Tensioner Pulley		38008
Belt - Accessory Belt Drive Kit		ACK080708HD	Idler Pulley - Smooth		38001
Belt - Fan & Alt.	0123415010	♣K080708HD	Idler Pulley - Grooved; W/O A.C.		38008
Belt - W.P.		♣9335HD	Hose - Upper		♣<21188
Tensioner Assy. - Fan & Alt.	1352151	38511	Hose - Lower		21941
Tensioner Pulley - Fan & Alt.	1352151	36091	Hose - By Pass		19025
Hose - Upper - Eng. To Rad.		20735	John Deere 6-Cyl. 8.1 L CNG		
Cummins ISB Diesel			All American RE		
TC1000			Belt - Serpentine	R128197	♣K080680HD
Belt - Serpentine	3911562	♣K080575HD	Belt - Accessory Belt Drive Kit		ACK080680HD
Hose - Upper - Eng. To Pipe		♣<20151	Tensioner Assy.	RE518097	38507
Hose - Upper - Pipe To Rad.		♣<21893	1997		
Hose - Lower - Eng. To Pipe		♣<20172	Cummins ISB Diesel		
Hose - Lower - Heat Exch. To Pipe		24236	TC2000		
Hose - Lower - Pipe To Heat Exch.		♣<20172	Belt - Serpentine	3288878	♣K080594HD
Hose - Lower - Pipe To Rad.		24232	Tensioner Assy.	3922901	38513
TC2000			Cummins ISC Diesel		
Belt - Accessory Belt Drive Kit; W/49 1/8" Belt O.C.		ACK080485HD	All American RE		
Belt - Accessory Belt Drive Kit; W/54 3/8" Belt O.C.		ACK080537HD	Belt - Accessory Belt Drive Kit; W/61 3/4" Belt O.C.		ACK080610HD
Belt - Accessory Belt Drive Kit - Alt. & W.P.; W/74 5/8" Belt O.C.		ACK080740HD	Belt - Accessory Belt Drive Kit - Fan & Alt.; W/63 5/8" Belt O.C.		ACK080630HD1
Belt - Accessory Belt Drive Kit - Alt. & W.P.; W/58 5/8" Belt O.C.		ACK080580HD	Belt - Accessory Belt Drive Kit; W/64 1/4" Belt O.C.		ACK080638HD
Belt - Alt. & W.P.; W/49 1/8" Belt O.C.		♣K080485HD	Belt - Fan & Alt.; W/61 3/4" Belt O.C.	3911572	♣K080610HD
Belt - Alt. & W.P.; W/54 3/8" Belt O.C.	1373281	♣K080537HD	Belt - Fan & Alt.; W/63 5/8" Belt O.C.		♣K080630HD
Belt - Alt. & W.P.; W/58 5/8" Belt O.C.	2791517325	♣K080580HD	Belt - Fan & Alt.; W/64 1/4" Belt O.C.	8304073	♣K080638HD
Belt - Alt. & W.P.; W/74 5/8" Belt O.C.	1373323	♣K080740HD	Tensioner Assy.	3976832	38513
Tensioner Assy. - Alt. & W.P.	3945527	38516	Tensioner Pulley	3976832	36091
Tensioner Pulley - Alt. & W.P.	3945527	36093	Hose - Upper; Strt. Hose		24236
Hose - Upper - Eng. To Pipe		26601	Hose - Upper; Molded Hose		26528
Hose - Upper - Pipe To Rad.		♣<21891	Hose - Lower		25804
Hose - Lower - Eng. To Pipe		♣<21194	1996		
Hose - Lower - Pipe To Cooler		♣<21194	Cummins B Series 5.9 L Diesel		
Hose - Lower - Cooler To Pipe		24236	TC2000		
Hose - Lower - Pipe To Rad.		22177	Belt - Fan & Alt.; W/49 1/8" Belt O.C.		♣K080485HD
Cummins ISC Diesel			Belt - Fan & Alt.; W/54 3/8" Belt O.C.	1373281	♣K080537HD
All American RE			Belt - Fan & Alt.; W/58 5/8" Belt O.C.	2791517325	♣K080580HD
Belt - Accessory Belt Drive Kit; W/61 3/4" Belt O.C.		ACK080610HD	Belt - Fan & Alt.; W/74 5/8" Belt O.C.	1373323	♣K080740HD
Belt - Accessory Belt Drive Kit - Fan & Alt.; W/63 5/8" Belt O.C.		ACK080630HD1	Tensioner Assy.	3922901	38513
Belt - Accessory Belt Drive Kit; W/64 1/4" Belt O.C.		ACK080638HD	Hose - Upper - Eng. To Pipe		26601
Belt - Alt. & W.P.; W/61 3/4" Belt O.C.	3911572	♣K080610HD	Hose - Upper - Pipe To Rad.		♣<21891
Belt - Alt. & W.P.; W/63 5/8" Belt O.C.		♣K080630HD	Hose - Lower - Eng. To Pipe		♣<21194
Belt - Fan & Alt.; W/64 1/4" Belt O.C.	8304073	♣K080638HD	Hose - Lower - Pipe To Cooler		♣<21194
Belt - A.C. - Right Side		♣9455HD	Hose - Lower - Cooler To Pipe		24236
Belt - A.C. - Left Side		♣9463HD	Hose - Lower - Pipe To Rad.		22177
Tensioner Assy. - Alt. & W.P.	3937556	38513	Cummins C Series 8.3 L Diesel		
Tensioner Pulley - Alt. & W.P.	3937556	36091	All American RE		
Hose - Upper; Strt. Hose		24236	Belt - Accessory Belt Drive Kit; W/61 3/4" Belt O.C.		ACK080610HD
Hose - Upper; Molded Hose		26528	Belt - Accessory Belt Drive Kit - Fan & Alt.; W/63 5/8" Belt O.C.		ACK080630HD1
Hose - Lower		25804	Belt - Fan & Alt.; W/61 3/4" Belt O.C.	3911572	♣K080610HD
GM V-8 5.7 L			Belt - Fan & Alt.; W/63 5/8" Belt O.C.		♣K080630HD
Mini Bird			Tensioner Assy.	3976832	38513
Belt - Accessory Belt Drive Kit; W/A.C.; W/105A. Alt.		ACK060960HD	Tensioner Pulley	3976832	36091
Belt - Accessory Belt Drive Kit; W/O A.C.; W/105A. Alt.		ACK060870HD	Hose - Upper; Strt. Hose		24236
Belt - Accessory Belt Drive Kit; W/O A.C.; W/124A., 140A. Alt.		ACK060875HD	Hose - Upper; Molded Hose		26528
Belt - Serpentine; W/A.C.; W/105A. Alt.		♣K060960HD	Hose - Lower		25804

♣Standard Belt Available.
♣<Protective Sleeve Required.

♣<Cut to Fit.

Belts and Coolant Hose for School Buses

School Buses

Application	Mfr. Part No.	Our No.	Application	Mfr. Part No.	Our No.
Bluebird - Continued			Bluebird - Continued		
1996 - Continued			1994 - Continued		
Cummins C Series 8.3 L Diesel - Continued			GM V-8 5.7 L - Continued		
TC2000			Mini Bird - Continued		
Belt - Accessory Belt Drive Kit		ACK080610HD1	Tensioner Pulley - Fan & Alt.		38037
Belt - Serpentine		♣K080610HD	Hose - Upper; Exc. Cutaway HD		21191
Tensioner Assy. 3934818		38504	Hose - Upper; Cutaway HD		22171
Tensioner Pulley	3934818	36091	Hose - Lower; Exc. Cutaway HD		20843
1995			1993		
Cummins B Series 5.9 L Diesel			Cummins B Series 5.9 L Diesel		
TC2000			All American FE		
Belt - Fan & Alt.; W/49 1/8" Belt O.C.		♣K080485HD	Belt - Eng. To Alt.		♣K080600HD
Belt - Fan & Alt.; W/54 3/8" Belt O.C.	1373281	♣K080537HD	Belt - A.C. - Right Side		♣9435HD
Belt - Fan & Alt.; W/58 5/8" Belt O.C.	2791517325	♣K080580HD	TC2000		
Belt - Fan & Alt.; W/74 5/8" Belt O.C.	1373323	♣K080740HD	Belt - Fan & Alt.; W/49 1/8" Belt O.C.		♣K080485HD
Tensioner Assy. 3922901		38513	Belt - Fan & Alt.; W/54 3/8" Belt O.C.	1373281	♣K080537HD
Hose - Upper - Eng. To Pipe		26601	Belt - Fan & Alt.; W/58 5/8" Belt O.C.	2791517325	♣K080580HD
Hose - Upper - Pipe To Rad.		≈<21891	Belt - Fan & Alt.; W/74 5/8" Belt O.C.	1373323	♣K080740HD
Hose - Lower - Eng. To Pipe		≈<21194	Tensioner Assy. - Fan & Alt.	3922900	38504
Hose - Lower - Pipe To Cooler		≈<21194	Hose - Upper - Eng. To Pipe		22898
Hose - Lower - Cooler To Pipe		24236	Hose - Upper - Pipe To Rad.		≈<21891
Hose - Lower - Pipe To Rad.		22177	Hose - Lower - Eng. To Pipe		≈<21194
Cummins C Series 8.3 L Diesel			Cummins C Series 8.3 L Diesel		
All American RE			All American RE		
Belt - Fan & Alt.; W/61 3/4" Belt O.C.	3911572	♣K080610HD	Belt - Fan & Alt.; W/61 3/4" Belt O.C.	3911572	♣K080610HD
Belt - Fan & Alt.; W/63 5/8" Belt O.C.		♣K080630HD	Belt - Fan & Alt.; W/63 5/8" Belt O.C.		♣K080630HD
Tensioner Assy. 3976832		38513	Tensioner Assy. 3976832		38513
Tensioner Pulley	3976832	36091	Tensioner Pulley	3976832	36091
Hose - Upper; Strt. Hose		24236	Hose - Upper; Strt. Hose		24236
Hose - Upper; Molded Hose		26528	Hose - Upper; Molded Hose		26528
Hose - Lower		25804	Hose - Lower		25804
1994			1992		
Cummins B Series 5.9 L Diesel			Cummins B Series 5.9 L CNG		
All American FE			All American RE		
Belt - Eng. To Alt.		♣K080600HD	Belt - Serpentine		♣K080605HD
Belt - A.C. - Right Side		♣9440HD	Tensioner Assy. 3922901		38513
Belt - A.C. - Left Side		♣9440HD	Tensioner Pulley	3922901	36091
TC2000			Cummins B Series 5.9 L Diesel		
Belt - Fan & Alt.; W/49 1/8" Belt O.C.		♣K080485HD	All American FE		
Belt - Fan & Alt.; W/54 3/8" Belt O.C.	1373281	♣K080537HD	Belt - A.C. - Right Side		♣9451HD
Belt - Fan & Alt.; W/58 5/8" Belt O.C.	2791517325	♣K080580HD	Belt - A.C. - Left Side		♣9455HD
Belt - Fan & Alt.; W/74 5/8" Belt O.C.	1373323	♣K080740HD	Belt - Eng. To Alt.		♣K080580HD
Hose - Upper - Eng. To Pipe		22898	TC2000		
Hose - Upper - Pipe To Rad.		≈<21891	Belt - Fan & Alt.; W/49 1/8" Belt O.C.		♣K080485HD
Hose - Lower - Eng. To Pipe		≈<21194	Belt - Fan & Alt.; W/54 3/8" Belt O.C.	1373281	♣K080537HD
Hose - Lower - Pipe To Cooler		≈<21194	Belt - Fan & Alt.; W/58 5/8" Belt O.C.	2791517325	♣K080580HD
Hose - Lower - Cooler To Pipe		24236	Belt - Fan & Alt.; W/74 5/8" Belt O.C.	1373323	♣K080740HD
Hose - Lower - Pipe To Rad.		22177	Hose - Upper - Eng. To Pipe		22898
Cummins C Series 8.3 L Diesel			Cummins C Series 8.3 L Diesel		
All American RE			All American FE		
Belt - Fan & Alt.; W/61 3/4" Belt O.C.	3911572	♣K080610HD	Belt - Alt. - From Eng.		♣K080605HD
Belt - Fan & Alt.; W/63 5/8" Belt O.C.		♣K080630HD	Belt - A.C. - Right Side		♣9463HD
Tensioner Assy. 3976832		38513	Belt - A.C. - Left Side		♣9451HD
Tensioner Pulley	3976832	36091	All American RE		
Hose - Upper; Strt. Hose		24236	Belt - Fan & Alt.; W/61 3/4" Belt O.C.	3911572	♣K080610HD
Hose - Upper; Molded Hose		26528			
Hose - Lower		25804			
GM V-8 5.7 L					
Mini Bird					
Belt - Fan & Alt.; W/105A. Alt.		K050435			
Belt - Fan & Alt.; W/120A. Alt.		K050446			
Belt - P.S.; W/A.C.		7355			
Belt - Fan & P.S.; W/O A.C.		7440			
Belt - Fan & A.C.		7585			

♣Standard Belt Available.

≈<Cut to Fit.

Belts and Coolant Hose for School Buses

Application	Mfr. Part No.	Our No.	Application	Mfr. Part No.	Our No.
Bluebird - Continued			Bluebird - Continued		
1992 - Continued			1989 - 1987		
Cummins C Series 8.3 L Diesel - Continued			Caterpillar 3208 Diesel		
All American RE - Continued			All American		
Belt - Fan & Alt.; W/63 5/8" Belt O.C.		▲K080630HD	Belt - Fan; Preferred Belt		2/9430PB
Tensioner Assy. 3976832		38513	Belt - Fan; Optional Belt	②▲9430HD	2/9490PB
Tensioner Pulley 3976832		36091	Belt - W.P.; Preferred Belt		2/9490PB
Hose - Upper; Strt. Hose		24236	Belt - W.P.; Optional Belt	②▲9490HD	
Hose - Upper; Molded Hose		26528	Belt - Alt. & Air Brake Compr.; Preferred Belt		2/9660PB
Hose - Lower		25804	Belt - Alt. & Air Brake Compr.; Optional Belt	②▲9660HD	
John Deere 6-Cyl. 6.8 L Diesel			Belt - P.S.; W/37 3/8" Belt O.C.		▲9370HD
All American RE			Belt - P.S.; W/48 7/8" Belt O.C.		▲9485HD
Belt - Serpentine		▲K080653HD	Hose - Upper - Eng. To Pipe		24232
Tensioner Assy. RE70536		38654	Hose - Upper - Pipe To Pipe		24232
John Deere 6-Cyl. 8.1 L CNG			Hose - Lower; Molded Hose	≈<	20731
All American RE			Hose - Lower - Eng. To Pipe		24236
Belt - Serpentine R128197		▲K080680HD	Hose - Lower - Pipe To Pipe		24236
1991			Hose - Lower - Pipe To Cooler		24236
Cummins 6-Cyl. 8.3 L Diesel			Hose - Lower - Cooler To Pipe		24232
All American RE			Hose - Lower - Pipe To Rad.		24232
Belt - Fan & Alt.; W/61 3/4" Belt O.C.	3911572	▲K080610HD	Cummins B Series 5.9 L Diesel		
Belt - Fan & Alt.; W/63 5/8" Belt O.C.		▲K080630HD	TC2000		
Tensioner Assy. 3976832		38513	Belt - Fan & Alt.; W/49 1/8" Belt O.C.		▲K080485HD
Tensioner Pulley 3976832		36091	Belt - Fan & Alt.; W/54 3/8" Belt O.C.	1373281	▲K080537HD
Hose - Upper; Strt. Hose		24236	Belt - Fan & Alt.; W/58 5/8" Belt O.C.	2791517325	▲K080580HD
Hose - Upper; Molded Hose		26528	Belt - Fan & Alt.; W/74 5/8" Belt O.C.	1373323	▲K080740HD
Hose - Lower		25804	Hose - Upper - Eng. To Pipe		22898
Cummins B Series 5.9 L Diesel			Hose - Upper - Pipe To Rad.	≈<	21891
All American FE			Hose - Lower - Eng. To Pipe	≈<	21194
Belt - Eng. To Alt.		▲K080575HD	Hose - Lower - Pipe To Cooler	≈<	21194
Belt - A.C. - Right Side		▲9451HD	Hose - Lower - Cooler To Pipe		24236
Belt - A.C. - Left Side		▲9455HD	Hose - Lower - Pipe To Rad.		22177
TC2000			Cummins V555 Diesel		
Belt - Fan & Alt.; W/49 1/8" Belt O.C.		▲K080485HD	All American		
Belt - Fan & Alt.; W/54 3/8" Belt O.C.	1373281	▲K080537HD	Belt - Fan & Air Brake Compr.		②▲9480HD
Belt - Fan & Alt.; W/58 5/8" Belt O.C.	2791517325	▲K080580HD	Belt - Fan To W.P. & Alt.		②7400
Belt - Fan & Alt.; W/74 5/8" Belt O.C.	1373323	▲K080740HD	Belt - P.S.		▲9585HD
Hose - Upper - Eng. To Pipe		22898	Hose - Upper - Eng. To Tee		24232
Hose - Upper - Pipe To Rad.		≈<	International/Navistar DT466 Diesel		
Hose - Lower - Eng. To Pipe		≈<	Conventional		
Hose - Lower - Pipe To Cooler		≈<	Belt - Fan & Alt.; Chassis No. S1800		②▲◆9660HD
Hose - Lower - Cooler To Pipe		24236	Belt - Fan & Alt.; Exc. Chassis No. S1800		②▲◆9640HD
Hose - Lower - Pipe To Rad.		22177	Belt - P.S.; Chassis No. S1800		▲9755HD
1990			Belt - P.S.; Exc. Chassis No. S1800		②▲9440HD
Cummins 6-Cyl. 8.3 L Diesel			Belt - Air Brake Compr.; Chassis No. S1800		▲9500HD
All American RE			Belt - Air Brake Compr.; Exc. Chassis No. S1800		▲9490HD
Belt - Fan & Alt.; W/61 3/4" Belt O.C.	3911572	▲K080610HD	Hose - Upper - Eng. To Pipe; Chassis No. S1800		24236
Belt - Fan & Alt.; W/63 5/8" Belt O.C.		▲K080630HD	Hose - Upper - Pipe To Rad.; Chassis No. S1800		24240
Hose - Upper; Strt. Hose		24236	Hose - Upper; Exc. Chassis No. S1800		21372
Hose - Upper; Molded Hose		26528	Hose - Lower; Chassis No. S1800		26531
Hose - Lower		25804	Hose - Lower; Exc. Chassis No. S1800		21766
Cummins B Series 5.9 L Diesel			1986 - 1948		
TC2000			Caterpillar 3208 Diesel		
Belt - Fan & Alt.; W/49 1/8" Belt O.C.		▲K080485HD	All American		
Belt - Fan & Alt.; W/54 3/8" Belt O.C.	1373281	▲K080537HD	Belt - Fan; Preferred Belt		2/9430PB
Belt - Fan & Alt.; W/58 5/8" Belt O.C.	2791517325	▲K080580HD	Belt - Fan; Optional Belt	②▲9430HD	
Belt - Fan & Alt.; W/74 5/8" Belt O.C.	1373323	▲K080740HD	Belt - W.P.; Preferred Belt		2/9490PB
Hose - Upper - Eng. To Pipe		22898	Belt - W.P.; Optional Belt	②▲9490HD	
Hose - Upper - Pipe To Rad.		≈<	Belt - Alt. & Air Brake Compr.; Preferred Belt		2/9660PB
Hose - Lower - Eng. To Pipe		21194	Belt - Alt. & Air Brake Compr.; Optional Belt	②▲9660HD	
Hose - Lower - Pipe To Cooler		≈<	Belt - P.S.; W/37 3/8" Belt O.C.		▲9370HD
Hose - Lower - Cooler To Pipe		24236	Belt - P.S.; W/48 7/8" Belt O.C.		▲9485HD
Hose - Lower - Pipe To Rad.		22177	Hose - Upper - Eng. To Pipe		24232
1986 - 1948			Hose - Upper - Pipe To Pipe		24232
Caterpillar 3208 Diesel			Hose - Lower; Molded Hose	≈<	20731
All American			Hose - Lower - Eng. To Pipe		24236
Belt - Fan; Preferred Belt		2/9430PB	Standard Belt Available.		
Belt - Fan; Optional Belt	②▲9430HD		②Two Required.		
Belt - W.P.; Preferred Belt		2/9490PB	≈<Cut to Fit.		
Belt - W.P.; Optional Belt	②▲9490HD		◆PowerBand Belt May Work, Use Template to Check.		
Belt - Alt. & Air Brake Compr.; Preferred Belt		2/9660PB			
Belt - Alt. & Air Brake Compr.; Optional Belt	②▲9660HD				
Belt - P.S.; W/37 3/8" Belt O.C.		▲9370HD			
Belt - P.S.; W/48 7/8" Belt O.C.		▲9485HD			
Hose - Upper - Eng. To Pipe		24232			
Hose - Upper - Pipe To Pipe		24232			
Hose - Lower; Molded Hose	≈<	20731			
Hose - Lower - Eng. To Pipe		24236			

School Buses

▲Standard Belt Available.
②Two Required.

≈<Cut to Fit.
◆PowerBand Belt May Work, Use Template to Check.

Belts and Coolant Hose for School Buses

Application	Mfr. Part No.	Our No.	Application	Mfr. Part No.	Our No.
Bluebird - Continued			Chevrolet - Continued		
1986 - 1948 - Continued			1999 - Continued		
Caterpillar 3208 Diesel - Continued			GM V-8 7.4 L - Continued		
All American - Continued			B7 Series - Continued		
Hose - Lower - Pipe To Pipe		24236	Belt - P.S. & Hyd. Brake	11502405	♣9640HD
Hose - Lower - Pipe To Cooler		24236	Hose - Upper - Eng. To Rad.		22663
Hose - Lower - Cooler To Pipe		24232	Hose - Lower - Eng. To Rad.		22135
Hose - Lower - Pipe To Rad.		24232	1998		
Cummins V555 Diesel			Caterpillar 3116 Diesel		
All American			B7 Series		
Belt - Fan & Air Brake Compr.		②♣9480HD	Belt - Fan & Alt.; W/70" Belt O.C.	15670937	♣K070705HD
Belt - Fan To W.P. & Alt.		②7400	Hose - Upper - Eng. To Rad.		22134
Belt - P.S.		♣9585HD	Hose - Lower - Eng. To Rad.		21985
Hose - Upper - Eng. To Tee		24232	B60 B6P Series		
International/Navistar DT466 Diesel			Belt - Fan & Alt.		
Conventional			Hose - Upper		
Belt - Fan & Alt.; Chassis No. S1800		②♣♠9660HD	Hose - Lower		
Belt - Fan & Alt.; Exc. Chassis No. S1800		②♣♠9640HD	15670937		
Belt - P.S.; Chassis No. S1800		♣9755HD	22134		
Belt - P.S.; Exc. Chassis No. S1800		②♣9440HD	21985		
Belt - Air Brake Compr.; Chassis No. S1800		♣9500HD	Caterpillar 3126 Diesel		
Belt - Air Brake Compr.; Exc. Chassis No. S1800		♣9490HD	B7 Series		
Hose - Upper - Eng. To Pipe; Chassis No. S1800		24236	Belt - Fan & Alt.		
Hose - Upper - Pipe To Rad.; Chassis No. S1800		24240	Belt - W.P.		
Hose - Upper; Exc. Chassis No. S1800		21372	15670937		
Hose - Lower; Chassis No. S1800		26531	0366775		
Hose - Lower; Exc. Chassis No. S1800		21766	♣K070705HD		
Carpenter			♣K070705HD		
1994			♣9341HD		
International/Navistar V-8 7.3 L Diesel			22664		
Classic			21985		
Belt - Fan & P.S.		♣9585HD	B60 B6P Series		
Belt - Alt.		7575	Belt - Fan & Alt.		
Hose - Upper - Eng. To Rad.		21454	15670937		
Hose - Lower - Eng. To Rad.		21455	♣K070705HD		
Chevrolet			22134		
2000			21985		
Caterpillar 3126 Diesel			Caterpillar 3126 Diesel		
B7 Series			B60 B6P Series		
Belt - Fan & Alt.	15670937	♣K070705HD	Belt - Fan & Alt.		
Belt - W.P.	0366775	♣9341HD	15670937		
1999			♣K070705HD		
Caterpillar 3116 Diesel			22134		
B7 Series			21985		
Belt - Fan & Alt.; W/70" Belt O.C.	15670937	♣K070705HD	Caterpillar 3126 Diesel		
B60 B6P Series			B60 B6P Series		
Belt - Fan & Alt.	15670937	♣K070705HD	Belt - Fan & Alt.		
Hose - Upper		22134	15670937		
Hose - Lower		21985	♣K070705HD		
Caterpillar 3126 Diesel			22134		
B7 Series			21985		
Belt - Fan & Alt.	15670937	♣K070705HD	Caterpillar 3116 Diesel		
Belt - W.P.	0366775	♣9341HD	B60 B6P Series		
B60 B6P Series			Belt - Fan & Alt.		
Hose - Upper		22134	15670937		
Hose - Lower		21985	♣K070705HD		
GM V-8 7.4 L			22134		
B7 Series			21985		
Belt - Air Compr.	11502412	♣9680HD	Caterpillar 3126 Diesel		
Belt - P.S. & Air Brake Compr.	9433884	♣9395HD	B60 B6P Series		
Belt - Fan & Gen.	15722647	♣K060660HD	Belt - Fan & Alt.		
			15670937		
			♣K070705HD		
			22134		
			21985		
			GM V-8 6.0 L		
			B60 B6P Series		
			Belt - Fan & Alt.; W/124A., 145A. Alt.		
			15608928		
			♣K060672HD		
			♣9395HD		
			♣9650HD		
			♣K060670HD		
			♣9690HD		
			22136		
			22135		

♣Standard Belt Available.
 ◆PowerBand Belt May Work, Use Template to Check.

②Two Required.

Belts and Coolant Hose for School Buses

Application	Mfr. Part No.	Our No.	Application	Mfr. Part No.	Our No.
Chevrolet - Continued			Chevrolet - Continued		
1996 - Continued			1994 - 1992 - Continued		
GM V-8 7.0 L			Caterpillar 3126 Diesel - Continued		
B60 B6P Series			B60 B6P Series - Continued		
Belt - Fan & Alt.; W/124A., 145A. Alt.	15608928	♣K060672HD	Hose - Lower		21985
Belt - Fan & P.S.; W/Air Brakes	9433884	♣9395HD	GM V-8 6.0 L		
Belt - Fan & P.S.; W/Hyd. Brakes	11502406	♣9650HD	B60 B6P Series		
Belt - Fan & A.C.	10230259	♣K060670HD	Belt - Fan & Alt.; W/124A., 145A. Alt.	15608928	♣K060672HD
Belt - Air Brake Compr.	11502413	♣9690HD	Belt - Fan & P.S.; W/Air Brakes	9433884	♣9395HD
Hose - Upper	22136		Belt - Fan & P.S.; W/Hyd. Brakes	11502406	♣9650HD
Hose - Lower	22135		Belt - Fan & A.C.	10230259	♣K060670HD
GM V-8 7.4 L			Belt - Air Brake Compr.	11502413	♣9690HD
B60 B6P Series			Hose - Upper	22136	
Belt - Fan & Alt.; W/124A., 145A. Alt.	15608928	♣K060672HD	Hose - Lower	22135	
Belt - Fan & P.S.; W/Air Brakes	9433884	♣9395HD	GM V-8 7.0 L		
Belt - Fan & P.S.; W/Hyd. Brakes	11502406	♣9650HD	B60 B6P Series		
Belt - Fan & A.C.	10230259	♣K060670HD	Belt - Fan & Alt.; W/124A., 145A. Alt.	15608928	♣K060672HD
Belt - Air Brake Compr.	11502413	♣9690HD	Belt - Fan & P.S.; W/Air Brakes	9433884	♣9395HD
Hose - Upper	22136		Belt - Fan & P.S.; W/Hyd. Brakes	11502406	♣9650HD
Hose - Lower	22135		Belt - Fan & A.C.	10230259	♣K060670HD
1995			Belt - Air Brake Compr.	11502413	♣9690HD
Caterpillar 3116 Diesel			Hose - Upper	22136	
B60 B6P Series			Hose - Lower	22135	
Belt - Fan & Alt.	15670937	♣K070705HD	GM V-8 7.4 L		
Hose - Upper	22134		B60 B6P Series		
Hose - Lower	21985		Belt - Fan & Alt.; W/124A., 145A. Alt.	15608928	♣K060672HD
GM V-8 6.0 L			Belt - Fan & P.S.; W/Air Brakes	9433884	♣9395HD
B60 B6P Series			Belt - Fan & P.S.; W/Hyd. Brakes	11502406	♣9650HD
Belt - Fan & Alt.; W/124A., 145A. Alt.	15608928	♣K060672HD	Belt - Fan & A.C.	10230259	♣K060670HD
Belt - Fan & P.S.; W/Air Brakes	9433884	♣9395HD	Belt - Air Brake Compr.	11502413	♣9690HD
Belt - Fan & P.S.; W/Hyd. Brakes	11502406	♣9650HD	Hose - Upper	22136	
Belt - Fan & A.C.	10230259	♣K060670HD	Hose - Lower	22135	
Belt - Air Brake Compr.	11502413	♣9690HD	1991		
Hose - Upper	22136		Detroit Diesel V-8 8.2 L Diesel		
Hose - Lower	22135		S60 B6P Series		
GM V-8 7.0 L			Belt - Fan & Alt.; W/71 1/2" Belt O.C.		
B60 B6P Series			Belt - Fan & Alt.; W/97 1/2" Belt O.C.	2056956	②♣9700HD
Belt - Fan & Alt.; W/124A., 145A. Alt.	15608928	♣K060672HD	Belt - Fan & Air Brake Compr.		♣9720HD
Belt - Fan & P.S.; W/Air Brakes	9433884	♣9395HD	Belt - P.S.	11502340	♣9385HD
Belt - Fan & P.S.; W/Hyd. Brakes	11502406	♣9650HD	Hose - Upper - Eng. To Pipe		24232
Belt - Fan & A.C.	10230259	♣K060670HD	Hose - Upper - Pipe To Rad.		21473
Belt - Air Brake Compr.	11502413	♣9690HD	Hose - Lower - Eng. To Pipe		24236
Hose - Upper	22136		Hose - Lower - Pipe To Rad.		24238
Hose - Lower	22135		Hose - By Pass - Left Side		24222
GM V-8 7.4 L			Hose - By Pass - Right Side		21457
B60 B6P Series			GM V-8 6.0 L		
Belt - Fan & Alt.; W/124A., 145A. Alt.	15608928	♣K060672HD	B60 B6P Series		
Belt - Fan & P.S.; W/Air Brakes	9433884	♣9395HD	Hose - Upper	22136	
Belt - Fan & P.S.; W/Hyd. Brakes	11502406	♣9650HD	Hose - Lower	22135	
Belt - Fan & A.C.	10230259	♣K060670HD	S60 B6P Series		
Belt - Air Brake Compr.	11502413	♣9690HD	Belt - Fan & Alt.; W/63A., 108A. Alt.; Preferred Belt		2/9640PB
Hose - Upper	22136		Belt - Fan & Alt.; W/63A., 108A. Alt.; Optional Belt		②♣9640HD
Hose - Lower	22135		Belt - Fan & Alt.; W/80A., 100A. Alt.; Preferred Belt		2/9660PB
1994 - 1992			Belt - Fan & Alt.; W/80A., 100A. Alt.; Optional Belt		②♣9660HD
Caterpillar 3116 Diesel			Belt - Fan & Alt.; W/105A., 130A., 160A. Alt.; Preferred Belt		2/9670PB
B60 B6P Series			Belt - Fan & Alt.; W/105A., 130A., 160A. Alt.; Optional Belt		②♣9670HD
Belt - Fan & Alt.	15670937	♣K070705HD	Belt - Fan & P.S.		♣9630HD
Hose - Upper	22134		Belt - Fan & Hyd. Pump		♣9630HD
Hose - Lower	21985		Belt - Fan & Air Brake Compr.	2027569	5700
Caterpillar 3126 Diesel			Belt - Fan To A.P.	9433881	♣9380HD
B60 B6P Series			Belt - Alt. & A.P.; W/108A. Alt.		♣9630HD
Belt - Fan & Alt.	15670937	♣K070705HD	Belt - Alt. & A.P.; W/80A., 100A. Alt.		♣9640HD
Hose - Upper	22134		Belt - Alt. & A.P.; W/105A., 130A., 160A. Alt.		♣9650HD

School Buses

♣Standard Belt Available.

②Two Required.

Belts and Coolant Hose for School Buses

School Buses

Application	Mfr. Part No.	Our No.	Application	Mfr. Part No.	Our No.
Chevrolet - Continued			Chevrolet - Continued		
1991 - Continued			1990		
GM V-8 6.0 L - Continued			Detroit Diesel V-8 8.2 L Diesel		
S60 B6P Series - Continued			B60 B6P Series		
Belt - P.S.; W/40" Belt O.C.	9433884	♣9395HD	Belt - Fan & Alt.; W/71 1/2" Belt O.C.	2099791	♣9710HD
Belt - P.S.; W/Air Brakes; W/59 1/2" Belt O.C.		♣9590HD	Belt - Fan & Alt.; W/97 1/2" Belt O.C.	2056956	②♣9700HD
Belt - P.S.; W/Hyd. Brakes; W/64 3/4" Belt O.C.		♣9640HD	Belt - Fan & Air Brake Compr.		♣9720HD
Belt - A.P. - From C.S.; W/39" Belt O.C.		♣9385HD	Belt - P.S.	11502340	♣9385HD
Belt - A.P. - From C.S.; W/54 1/2" Belt O.C.	9433913	♣9540HD	Hose - Upper - Eng. To Pipe		24232
Belt - Air Brake Compr.		♣9720HD	Hose - Upper - Pipe To Rad.		21473
GM V-8 7.0 L			Hose - Lower - Eng. To Pipe		24236
B60 B6P Series			Hose - Lower - Pipe To Rad.		24238
Hose - Upper	22136		Hose - By Pass - Left Side		24222
Hose - Lower	22135		Hose - By Pass - Right Side		21457
S60 B6P Series			S7 S7T Series		
Belt - Fan & Alt.; W/63A., 108A. Alt.; Preferred Belt		2/9640PB	Belt - Fan & Alt.; W/71 1/2" Belt O.C.	2099791	♣9710HD
Belt - Fan & Alt.; W/63A., 108A. Alt.; Optional Belt		②♣9640HD	Belt - Fan & Alt.; W/97 1/2" Belt O.C.	2056956	②♣9700HD
Belt - Fan & Alt.; W/80A., 100A. Alt.; Preferred Belt		2/9660PB	Belt - Fan & Air Brake Compr.		♣9720HD
Belt - Fan & Alt.; W/80A., 100A. Alt.; Optional Belt		②♣9660HD	Belt - P.S.	11502340	♣9385HD
Belt - Fan & Alt.; W/105A., 130A., 160A. Alt.; Preferred Belt		2/9670PB	Belt - Air Brake Compr.; W/71 1/2" Belt O.C.	11502416	♣9710HD
Belt - Fan & Alt.; W/105A., 130A., 160A. Alt.; Optional Belt		②♣9670HD	Belt - Air Brake Compr.; W/75" Belt O.C.	11502340	♣9745HD
Belt - Fan & P.S.		♣9630HD	Hose - Upper - Eng. To Pipe		24232
Belt - Fan & Hyd. Pump		♣9630HD	Hose - Upper - Pipe To Rad.		21473
Belt - Fan & Air Brake Compr.	2027569	5700	Hose - Lower - Eng. To Pipe		24236
Belt - Fan To A.P.	9433881	♣9380HD	Hose - Lower - Pipe To Rad.		24238
Belt - Alt. & A.P.; W/108A. Alt.		♣9630HD	Hose - By Pass - Left Side		24222
Belt - Alt. & A.P.; W/80A., 100A. Alt.		♣9640HD	Hose - By Pass - Right Side		21457
Belt - Alt. & A.P.; W/105A., 130A., 160A. Alt.		♣9650HD	GM V-8 5.7 L		
Belt - P.S.; W/40" Belt O.C.	9433884	♣9395HD	B60 B6P Series		
Belt - P.S.; W/Air Brakes; W/59 1/2" Belt O.C.		♣9590HD	Belt - Fan & Alt.; W/70A., 108A. Alt.	11502375	♣9525HD
Belt - P.S.; W/Hyd. Brakes; W/64 3/4" Belt O.C.		♣9640HD	Belt - Fan & Alt.; W/80A., 100A. Alt.	2005476	②♣9550HD
Belt - A.P. - From C.S.; W/39" Belt O.C.		♣9385HD	Belt - Fan & Alt.; W/105A., 130A., 160A. Alt.; Preferred Belt	11502386	2/9570PB
Belt - A.P. - From C.S.; W/54 1/2" Belt O.C.	9433913	♣9540HD	Belt - Fan & Alt.; W/105A., 130A., 160A. Alt.; Optional Belt	11502386	②♣9570HD
Belt - Air Brake Compr.		♣9720HD	Belt - Fan, Alt. & A.P.; W/80A. Alt.	11502410	♣9670HD
GM V-8 7.4 L			Belt - Fan, Alt. & A.P.; W/105A., 130A., 160A. Alt.	11502411	♣9680HD
B60 B6P Series			Belt - Fan & P.S.; W/Hyd. Brakes	9433923	♣9590HD
Hose - Upper	22136		Belt - P.S. & A.P.		♣9640HD
Hose - Lower	22135		Belt - P.S.; W/Air Brakes	9433881	♣9380HD
S60 B6P Series			Belt - Air Brake Compr. & A.P.		♣9670HD
Belt - Fan & Alt.; W/63A., 108A. Alt.; Preferred Belt		2/9640PB	Belt - A.P.		♣9540HD
Belt - Fan & Alt.; W/63A., 108A. Alt.; Optional Belt		②♣9640HD	GM V-8 6.0 L		
Belt - Fan & Alt.; W/80A., 100A. Alt.; Preferred Belt		2/9660PB	B60 B6P Series		
Belt - Fan & Alt.; W/80A., 100A. Alt.; Optional Belt		②♣9660HD	Belt - Fan & Alt.; W/63A., 108A. Alt.; Preferred Belt		2/9640PB
Belt - Fan & Alt.; W/105A., 130A., 160A. Alt.; Preferred Belt		2/9670PB	Belt - Fan & Alt.; W/63A., 108A. Alt.; Optional Belt		②♣9640HD
Belt - Fan & Alt.; W/105A., 130A., 160A. Alt.; Optional Belt		②♣9670HD	Belt - Fan & Alt.; W/80A., 100A. Alt.; Preferred Belt		2/9660PB
Belt - Fan & P.S.		♣9630HD	Belt - Fan & Alt.; W/80A., 100A. Alt.; Optional Belt		②♣9660HD
Belt - Fan & Hyd. Pump		♣9630HD	Belt - Fan & Alt.; W/105A., 130A., 160A. Alt.; Preferred Belt		2/9670PB
Belt - Fan & Air Brake Compr.	2027569	5700	Belt - Fan & Alt.; W/105A., 130A., 160A. Alt.; Optional Belt		②♣9670HD
Belt - Fan To A.P.	9433881	♣9380HD	Belt - Fan & P.S.		♣9630HD
Belt - Alt. & A.P.; W/108A. Alt.		♣9630HD	Belt - Fan & Hyd. Pump		♣9630HD
Belt - Alt. & A.P.; W/80A., 100A. Alt.		♣9640HD	Belt - Fan & Air Brake Compr.	2027569	5700
Belt - Alt. & A.P.; W/105A., 130A., 160A. Alt.		♣9650HD	Belt - Fan To A.P.	9433881	♣9380HD
Belt - P.S.; W/40" Belt O.C.	9433884	♣9395HD	Belt - Alt. & A.P.; W/108A. Alt.		♣9630HD
Belt - P.S.; W/Air Brakes; W/59 1/2" Belt O.C.		♣9590HD	Belt - Alt. & A.P.; W/80A., 100A. Alt.		♣9640HD
Belt - P.S.; W/Hyd. Brakes; W/64 3/4" Belt O.C.		♣9640HD	Belt - Alt. & A.P.; W/105A., 130A., 160A. Alt.		♣9650HD
Belt - A.P. - From C.S.; W/39" Belt O.C.		♣9385HD	Belt - P.S.; W/40" Belt O.C.	9433884	♣9395HD
Belt - A.P. - From C.S.; W/54 1/2" Belt O.C.	9433913	♣9540HD	Belt - P.S.; W/Air Brakes; W/59 1/2" Belt O.C.		♣9590HD
Belt - Air Brake Compr.		♣9720HD	Belt - P.S.; W/Hyd. Brakes; W/64 3/4" Belt O.C.		♣9640HD
			Belt - A.P. - From C.S.; W/39" Belt O.C.		♣9385HD
			Belt - A.P. - From C.S.; W/54 1/2" Belt O.C.	9433913	♣9540HD
			Belt - Air Brake Compr.		♣9720HD
			Hose - Upper - Eng. To Pipe		♣21307

♣Standard Belt Available.
 ◆PowerBand Belt May Work, Use Template to Check.

②Two Required.
 ⚡Cut to Fit.

Belts and Coolant Hose for School Buses

Application	Mfr. Part No.	Our No.	Application	Mfr. Part No.	Our No.
Chevrolet - Continued			Chevrolet - Continued		
1990 - Continued			1990 - Continued		
GM V-8 6.0 L - Continued			GM V-8 7.4 L - Continued		
B60 B6P Series - Continued			B60 B6P Series - Continued		
Hose - Upper - Pipe To Rad.; W/Auto. Trans.		21523	Belt - P.S.; W/Air Brakes; W/59 1/2" Belt O.C.		▲9590HD
Hose - Upper - Pipe To Rad.; W/Man. Trans.		21521	Belt - P.S.; W/Hyd. Brakes; W/64 3/4" Belt O.C.		▲9640HD
Hose - Lower - Eng. To Pipe		24236	Belt - A.P. - From C.S.; W/39" Belt O.C.		▲9385HD
Hose - Lower - Pipe To Rad.		21556	Belt - A.P. - From C.S.; W/54 1/2" Belt O.C.	9433913	▲9540HD
Hose - By Pass		24222	Belt - Air Brake Compr.		▲9720HD
S7 S7T Series			Hose - Upper - Eng. To Pipe		≅21307
Belt - Fan & Alt.		▲9640HD	Hose - Upper - Pipe To Rad.; W/Auto. Trans.		21523
Belt - P.S.	9433923	▲9590HD	Hose - Upper - Pipe To Rad.; W/Man. Trans.		21521
Belt - Air Brake Compr.	11502417	▲9720HD	Hose - Lower - Eng. To Pipe		24236
Belt - A.P.	11502340	▲9385HD	Hose - Lower - Pipe To Rad.		21556
Belt - A.P. & Alt.	11502402	▲9630HD	Hose - By Pass		24222
Hose - Upper - Eng. To Pipe		≅21307	1989 - 1988		
Hose - Upper - Pipe To Rad.; W/Auto. Trans.		21523	Detroit Diesel V-8 8.2 L Diesel		
Hose - Upper - Pipe To Rad.; W/Man. Trans.		21521	B60 B6P Series		
Hose - Lower - Pipe To Rad.		21556	Belt - Fan & Alt.; W/71 1/2" Belt O.C.	2099791	▲9710HD
Hose - By Pass		24222	Belt - Fan & Alt.; W/97 1/2" Belt O.C.	2056956	②▲9700HD
GM V-8 7.0 L			Belt - Fan & Air Brake Compr.		▲9720HD
B60 B6P Series			Belt - P.S.	11502340	▲9385HD
Belt - Fan & Alt.; W/63A., 108A. Alt.; Preferred Belt		2/9640PB	Belt - Air Brake Compr.	11502419	▲9740HD
Belt - Fan & Alt.; W/63A., 108A. Alt.; Optional Belt	②	▲9640HD	Hose - Upper - Eng. To Pipe		24232
Belt - Fan & Alt.; W/80A., 100A. Alt.; Preferred Belt		2/9660PB	Hose - Upper - Pipe To Rad.		21473
Belt - Fan & Alt.; W/80A., 100A. Alt.; Optional Belt	②	▲9660HD	Hose - Lower - Eng. To Pipe		24236
Belt - Fan & Alt.; W/105A., 130A., 160A. Alt.; Preferred Belt		2/9670PB	Hose - Lower - Pipe To Rad.		24238
Belt - Fan & Alt.; W/105A., 130A., 160A. Alt.; Optional Belt	②	▲9670HD	Hose - By Pass - Left Side		24222
Belt - Fan & P.S.		▲9630HD	Hose - By Pass - Right Side		21457
Belt - Fan & Hyd. Pump		▲9630HD	S7 S7T Series		
Belt - Fan & Air Brake Compr.	2027569	5700	Belt - Fan & Alt.; W/71 1/2" Belt O.C.	2099791	▲9710HD
Belt - Fan To A.P.	9433881	▲9380HD	Belt - Fan & Alt.; W/97 1/2" Belt O.C.	2056956	②▲9700HD
Belt - Alt. & A.P.; W/108A. Alt.		▲9630HD	Belt - Fan & Air Brake Compr.		▲9720HD
Belt - Alt. & A.P.; W/80A., 100A. Alt.		▲9640HD	Belt - P.S.	11502340	▲9385HD
Belt - Alt. & A.P.; W/105A., 130A., 160A. Alt.		▲9650HD	Hose - Upper - Eng. To Pipe		24232
Belt - P.S.; W/40" Belt O.C.	9433884	▲9395HD	Hose - Upper - Pipe To Rad.		21473
Belt - P.S.; W/Air Brakes; W/59 1/2" Belt O.C.		▲9590HD	Hose - Lower - Eng. To Pipe		24236
Belt - P.S.; W/Hyd. Brakes; W/64 3/4" Belt O.C.		▲9640HD	Hose - Lower - Pipe To Rad.		24238
Belt - A.P. - From C.S.; W/39" Belt O.C.		▲9385HD	Hose - By Pass - Left Side		24222
Belt - A.P. - From C.S.; W/54 1/2" Belt O.C.	9433913	▲9540HD	Hose - By Pass - Right Side		21457
Belt - Air Brake Compr.		▲9720HD	GM V-8 5.7 L		
Hose - Upper - Eng. To Pipe		≅21307	B60 B6P Series		
Hose - Upper - Pipe To Rad.; W/Auto. Trans.		21523	Belt - Fan & Alt.; W/70A., 108A. Alt.	11502375	▲9525HD
Hose - Upper - Pipe To Rad.; W/Man. Trans.		21521	Belt - Fan & Alt.; W/80A., 100A. Alt.	2005476	②▲◆9550HD
Hose - Lower - Eng. To Pipe		24236	Belt - Fan & Alt.; W/105A., 130A., 160A. Alt.	11502386	②▲◆9570HD
Hose - Lower - Pipe To Rad.		21556	Belt - Fan, Alt. & A.P.; W/80A. Alt.	11502410	▲9670HD
Hose - By Pass		24222	Belt - Fan, Alt. & A.P.; W/105A., 130A., 160A. Alt.	11502411	▲9680HD
GM V-8 7.4 L			Belt - Fan & P.S.; W/Hyd. Brakes	9433923	▲9590HD
B60 B6P Series			Belt - P.S. & A.P.		▲9640HD
Belt - Fan & Alt.; W/63A., 108A. Alt.; Preferred Belt		2/9640PB	Belt - P.S.; W/Air Brakes	9433881	▲9380HD
Belt - Fan & Alt.; W/63A., 108A. Alt.; Optional Belt	②	▲9640HD	Belt - Air Brake Compr. & A.P.		▲9670HD
Belt - Fan & Alt.; W/80A., 100A. Alt.; Preferred Belt		2/9660PB	Belt - A.P.		▲9540HD
Belt - Fan & Alt.; W/80A., 100A. Alt.; Optional Belt	②	▲9660HD	GM V-8 6.0 L		
Belt - Fan & Alt.; W/105A., 130A., 160A. Alt.; Preferred Belt		2/9670PB	B60 B6P Series		
Belt - Fan & Alt.; W/105A., 130A., 160A. Alt.; Optional Belt	②	▲9670HD	Belt - Fan & Alt.; W/63A., 108A. Alt.; Preferred Belt		2/9640PB
Belt - Fan & P.S.		▲9630HD	Belt - Fan & Alt.; W/63A., 108A. Alt.; Optional Belt	②	▲9640HD
Belt - Fan & Hyd. Pump		▲9630HD	Belt - Fan & Alt.; W/80A., 100A. Alt.; Preferred Belt		2/9660PB
Belt - Fan & Air Brake Compr.	2027569	5700	Belt - Fan & Alt.; W/80A., 100A. Alt.; Optional Belt	②	▲9660HD
Belt - Fan To A.P.	9433881	▲9380HD	Belt - Fan & Alt.; W/105A., 130A., 160A. Alt.; Preferred Belt		2/9670PB
Belt - Alt. & A.P.; W/108A. Alt.		▲9630HD	Belt - Fan & Alt.; W/105A., 130A., 160A. Alt.; Optional Belt	②	▲9670HD
Belt - Alt. & A.P.; W/80A., 100A. Alt.		▲9640HD	Belt - Fan & P.S.		▲9630HD
Belt - Alt. & A.P.; W/105A., 130A., 160A. Alt.		▲9650HD	Belt - Fan & Hyd. Pump		▲9630HD
Belt - P.S.; W/40" Belt O.C.	9433884	▲9395HD			

▲Standard Belt Available.
②Two Required.

≅Cut to Fit.
◆PowerBand Belt May Work, Use Template to Check.

School Buses

Belts and Coolant Hose for School Buses

School Buses

Application	Mfr. Part No.	Our No.	Application	Mfr. Part No.	Our No.
Chevrolet - Continued			Chevrolet - Continued		
1989 - 1988 - Continued			1987 - 1986 - Continued		
GM V-8 6.0 L - Continued			GM V-8 5.7 L - Continued		
B60 B6P Series - Continued			B60 B6P Series - Continued		
Belt - Fan & Air Brake Compr.	2027569	5700	Belt - Fan & P.S.; W/Hyd. Brakes	9433923	♣9590HD
Belt - Fan To A.P.	9433881	♣9380HD	Belt - P.S. & A.P.		♣9640HD
Belt - Alt. & A.P.; W/108A. Alt.		♣9630HD	Belt - P.S.; W/Air Brakes	9433881	♣9380HD
Belt - Alt. & A.P.; W/80A., 100A. Alt.		♣9640HD	Belt - Air Brake Compr. & A.P.		♣9670HD
Belt - Alt. & A.P.; W/105A., 130A., 160A. Alt.		♣9650HD	Belt - A.P.		♣9540HD
Belt - P.S.; W/40" Belt O.C.	9433884	♣9395HD	Hose - Upper		21095
Belt - P.S.; W/Air Brakes; W/59 1/2" Belt O.C.		♣9590HD	Hose - Lower		21409
Belt - P.S.; W/Hyd. Brakes; W/64 3/4" Belt O.C.		♣9640HD	Hose - By Pass		≈<20777
Belt - A.P. - From C.S.; W/39" Belt O.C.		♣9385HD			
Belt - A.P. - From C.S.; W/54 1/2" Belt O.C.	9433913	♣9540HD	GM V-8 6.0 L		
Belt - Air Brake Compr.		♣9720HD	B60 B6P Series		
Hose - Upper - Eng. To Pipe		≈<21307	Belt - Fan & Alt.; W/63A., 108A. Alt.		②♣♣9640HD
Hose - Upper - Pipe To Rad.; W/Auto. Trans.		21523	Belt - Fan & Alt.; W/80A., 100A. Alt.		②♣♣9660HD
Hose - Upper - Pipe To Rad.; W/Man. Trans.		21521	Belt - Fan & Alt.; W/105A., 130A., 160A. Alt.		②♣♣9670HD
Hose - Lower - Eng. To Pipe		24236	Belt - Fan & P.S.		♣9630HD
Hose - Lower - Pipe To Rad.		21556	Belt - Fan & Hyd. Pump		♣9630HD
Hose - By Pass		24222	Belt - Fan & Air Brake Compr.	2027569	5700
			Belt - Fan To A.P.	9433881	♣9380HD
S7 S7T Series			Belt - Alt. & A.P.; W/108A. Alt.		♣9630HD
Belt - Fan & Alt.; W/63A., 108A. Alt.		②♣♣9640HD	Belt - Alt. & A.P.; W/80A., 100A. Alt.		♣9640HD
Belt - Fan & Alt.; W/80A., 100A. Alt.		②♣♣9660HD	Belt - Alt. & A.P.; W/105A., 130A., 160A. Alt.		♣9650HD
Belt - Fan & Alt.; W/105A., 130A., 160A. Alt.		②♣♣9670HD	Belt - P.S.; W/40" Belt O.C.	9433884	♣9395HD
Belt - Fan & P.S.		♣9630HD	Belt - P.S.; W/Air Brakes; W/59 1/2" Belt O.C.		♣9590HD
Belt - Fan & Hyd. Pump		♣9630HD	Belt - P.S.; W/Hyd. Brakes; W/64 3/4" Belt O.C.		♣9640HD
Belt - Fan & Air Brake Compr.	2027569	5700	Belt - A.P. - From C.S.; W/39" Belt O.C.		♣9385HD
Belt - Fan To A.P.	9433881	♣9380HD	Belt - A.P. - From C.S.; W/54 1/2" Belt O.C.	9433913	♣9540HD
Belt - Alt. & A.P.; W/108A. Alt.		♣9630HD	Belt - Air Brake Compr.		♣9720HD
Belt - Alt. & A.P.; W/80A., 100A. Alt.		♣9640HD	Hose - Upper - Eng. To Pipe		≈<21307
Belt - Alt. & A.P.; W/105A., 130A., 160A. Alt.		♣9650HD	Hose - Upper - Pipe To Rad.; W/Auto. Trans.		21523
Belt - P.S.; W/40" Belt O.C.	9433884	♣9395HD	Hose - Upper - Pipe To Rad.; W/Man. Trans.		21521
Belt - P.S.; W/Air Brakes; W/59 1/2" Belt O.C.		♣9590HD	Hose - Lower - Eng. To Pipe		24236
Belt - P.S.; W/Hyd. Brakes; W/64 3/4" Belt O.C.		♣9640HD	Hose - Lower - Pipe To Rad.		21556
Belt - A.P. - From C.S.; W/39" Belt O.C.		♣9385HD	Hose - By Pass		24222
Belt - A.P. - From C.S.; W/54 1/2" Belt O.C.	9433913	♣9540HD			
Belt - Air Brake Compr.		♣9720HD	1985 - 1983		
Hose - Upper - Eng. To Pipe		≈<21307	Detroit Diesel V-8 8.2 L Diesel		
Hose - Upper - Pipe To Rad.; W/Auto. Trans.		21523	B60 B6P Series		
Hose - Upper - Pipe To Rad.; W/Man. Trans.		21521	Belt - Fan & Alt.; W/71 1/2" Belt O.C.	2099791	♣9710HD
Hose - Lower - Eng. To Pipe		24236	Belt - Fan & Alt.; W/97 1/2" Belt O.C.	2056956	②♣9700HD
Hose - Lower - Pipe To Rad.		21556	Belt - Fan & Air Brake Compr.		♣9720HD
Hose - By Pass		24222	Belt - P.S.	11502340	♣9385HD
			Hose - Upper - Eng. To Pipe		24232
1987 - 1986			Hose - Upper - Pipe To Rad.		21473
Detroit Diesel V-8 8.2 L Diesel			Hose - Lower - Eng. To Pipe		24236
B60 B6P Series			Hose - Lower - Pipe To Rad.		24238
Belt - Fan & Alt.; W/71 1/2" Belt O.C.	2099791	♣9710HD	Hose - By Pass - Left Side		24222
Belt - Fan & Alt.; W/97 1/2" Belt O.C.	2056956	②♣9700HD	Hose - By Pass - Right Side		21457
Belt - Fan & Air Brake Compr.		♣9720HD			
Belt - P.S.	11502340	♣9385HD	GM V-8 5.7 L		
Hose - Upper - Eng. To Pipe		24232	B60 B6P Series		
Hose - Upper - Pipe To Rad.		21473	Belt - Fan & Alt.; W/70A., 108A. Alt.	11502375	♣9525HD
Hose - Lower - Eng. To Pipe		24236	Belt - Fan & Alt.; W/80A., 100A. Alt.	2005476	②♣♣9550HD
Hose - Lower - Pipe To Rad.		24238	Belt - Fan & Alt.; W/105A., 130A., 160A. Alt.		②♣♣9570HD
Hose - By Pass - Left Side		24222	Alt.	11502386	♣9670HD
Hose - By Pass - Right Side		21457	Belt - Fan, Alt. & A.P.; W/80A. Alt.	11502410	
			Belt - Fan, Alt. & A.P.; W/105A., 130A., 160A. Alt.	11502411	♣9680HD
GM V-8 5.7 L			Belt - Fan & P.S.; W/Hyd. Brakes	9433923	♣9590HD
B60 B6P Series			Belt - P.S. & A.P.		♣9640HD
Belt - Fan & Alt.; W/70A., 108A. Alt.	11502375	♣9525HD	Belt - P.S.; W/Air Brakes	9433881	♣9380HD
Belt - Fan & Alt.; W/80A., 100A. Alt.	2005476	②♣♣9550HD	Belt - Air Brake Compr. & A.P.		♣9670HD
Belt - Fan & Alt.; W/105A., 130A., 160A. Alt.		②♣♣9570HD	Belt - A.P.		♣9540HD
Alt.	11502386	♣9670HD	Hose - Upper		21095
Belt - Fan, Alt. & A.P.; W/80A. Alt.	11502410		Hose - Lower		21409
Belt - Fan, Alt. & A.P.; W/105A., 130A., 160A. Alt.	11502411	♣9680HD	Hose - By Pass		≈<20777

♣Standard Belt Available.
 ◆PowerBand Belt May Work, Use Template to Check.

≈<Cut to Fit.
 ②Two Required.

Belts and Coolant Hose for School Buses

Application	Mfr. Part No.	Our No.	Application	Mfr. Part No.	Our No.
Chevrolet - Continued			Chevrolet - Continued		
1985 - 1983 - Continued			1982 - Continued		
GM V-8 6.0 L			GM V-8 5.7 L - Continued		
B60 B6P Series			B60 B6P Series - Continued		
Belt - Fan & Alt.; W/63A., 108A. Alt.		②◆◆9640HD	Belt - Fan & Alt.; W/105A., 130A., 160A. Alt.	11502386	②◆◆9570HD
Belt - Fan & Alt.; W/80A., 100A. Alt.		②◆◆9660HD	Alt.		◆◆9670HD
Belt - Fan & Alt.; W/105A., 130A., 160A. Alt.		②◆◆9670HD	Belt - Fan, Alt. & A.P.; W/80A. Alt.	11502410	
Belt - Fan & P.S.		◆◆9630HD	Belt - Fan, Alt. & A.P.; W/105A., 130A., 160A. Alt.	11502411	◆◆9680HD
Belt - Fan & Hyd. Pump		◆◆9630HD	Belt - Fan & P.S.; W/Hyd. Brakes	9433923	◆◆9590HD
Belt - Fan & Air Brake Compr.	2027569	5700	Belt - P.S. & A.P.		◆◆9640HD
Belt - Fan To A.P.	9433881	◆◆9380HD	Belt - P.S.; W/Air Brakes	9433881	◆◆9380HD
Belt - Alt. & A.P.; W/108A. Alt.		◆◆9630HD	Belt - Air Brake Compr. & A.P.		◆◆9670HD
Belt - Alt. & A.P.; W/80A., 100A. Alt.		◆◆9640HD	Belt - A.P.		◆◆9540HD
Belt - Alt. & A.P.; W/105A., 130A., 160A. Alt.		◆◆9650HD	Hose - Upper		21095
Belt - P.S.; W/40" Belt O.C.	9433884	◆◆9395HD	Hose - Lower		21409
Belt - P.S.; W/Air Brakes; W/59 1/2" Belt O.C.		◆◆9590HD	Hose - By Pass		≈<20777
Belt - P.S.; W/Hyd. Brakes; W/64 3/4" Belt O.C.		◆◆9640HD			
Belt - A.P. - From C.S.; W/39" Belt O.C.		◆◆9385HD			
Belt - A.P. - From C.S.; W/54 1/2" Belt O.C.	9433913	◆◆9540HD			
Belt - Air Brake Compr.		◆◆9720HD			
Hose - Upper		21107			
Hose - Lower - Eng. To Pipe		24236			
Hose - Lower - Pipe To Rad.		21556			
Hose - By Pass		24222			
GM V-8 7.0 L			GM V-8 6.0 L		
B60 B6P Series			B60 B6P Series		
Belt - Fan & Alt.; W/63A., 108A. Alt.		②◆◆9640HD	Belt - Fan & Alt.; W/63A., 108A. Alt.		②◆◆9640HD
Belt - Fan & Alt.; W/80A., 100A. Alt.		②◆◆9660HD	Belt - Fan & Alt.; W/80A., 100A. Alt.		②◆◆9660HD
Belt - Fan & Alt.; W/105A., 130A., 160A. Alt.		②◆◆9670HD	Belt - Fan & Alt.; W/105A., 130A., 160A. Alt.		②◆◆9670HD
Belt - Fan & P.S.		◆◆9630HD	Belt - Fan & P.S.		◆◆9630HD
Belt - Fan & Hyd. Pump		◆◆9630HD	Belt - Fan & Hyd. Pump		◆◆9630HD
Belt - Fan & Air Brake Compr.	2027569	5700	Belt - Fan & Air Brake Compr.	2027569	5700
Belt - Fan To A.P.	9433881	◆◆9380HD	Belt - Fan To A.P.	9433881	◆◆9380HD
Belt - Alt. & A.P.; W/108A. Alt.		◆◆9630HD	Belt - Alt. & A.P.; W/108A. Alt.		◆◆9630HD
Belt - Alt. & A.P.; W/80A., 100A. Alt.		◆◆9640HD	Belt - Alt. & A.P.; W/80A., 100A. Alt.		◆◆9640HD
Belt - Alt. & A.P.; W/105A., 130A., 160A. Alt.		◆◆9650HD	Belt - Alt. & A.P.; W/105A., 130A., 160A. Alt.		◆◆9650HD
Belt - P.S.; W/40" Belt O.C.	9433884	◆◆9395HD	Belt - P.S.; W/40" Belt O.C.	9433884	◆◆9395HD
Belt - P.S.; W/Air Brakes; W/59 1/2" Belt O.C.		◆◆9590HD	Belt - P.S.; W/Air Brakes; W/59 1/2" Belt O.C.		◆◆9590HD
Belt - P.S.; W/Hyd. Brakes; W/64 3/4" Belt O.C.		◆◆9640HD	Belt - P.S.; W/Hyd. Brakes; W/64 3/4" Belt O.C.		◆◆9640HD
Belt - A.P. - From C.S.; W/39" Belt O.C.		◆◆9385HD	Belt - A.P. - From C.S.; W/39" Belt O.C.		◆◆9385HD
Belt - A.P. - From C.S.; W/54 1/2" Belt O.C.	9433913	◆◆9540HD	Belt - A.P. - From C.S.; W/54 1/2" Belt O.C.	9433913	◆◆9540HD
Belt - Air Brake Compr.		◆◆9720HD	Belt - Air Brake Compr.		◆◆9720HD
Hose - Upper		21107	Hose - Upper		21107
Hose - Lower - Eng. To Pipe		24236	Hose - Lower - Eng. To Pipe		24236
Hose - Lower - Pipe To Rad.		21556	Hose - Lower - Pipe To Rad.		21556
Hose - By Pass		24222	Hose - By Pass		24222
1982			GM V-8 7.0 L		
Detroit Diesel V-8 8.2 L Diesel			B60 B6P Series		
Belt - Fan & Alt.; W/71 1/2" Belt O.C.	2099791	◆◆9710HD	Belt - Fan & Alt.; W/63A., 108A. Alt.		②◆◆9640HD
Belt - Fan & Alt.; W/97 1/2" Belt O.C.	2056956	②◆◆9700HD	Belt - Fan & Alt.; W/80A., 100A. Alt.		②◆◆9660HD
Belt - Fan & Air Brake Compr.; Jan. 10, 1982 & Older	11502414	◆◆9700HD	Belt - Fan & Alt.; W/105A., 130A., 160A. Alt.		②◆◆9670HD
Belt - Fan & Air Brake Compr.; Jan. 11, 1982 & Newer		◆◆9720HD	Belt - Fan & P.S.		◆◆9630HD
Belt - P.S.	11502340	◆◆9385HD	Belt - Fan & Hyd. Pump		◆◆9630HD
Hose - Upper - Eng. To Pipe		24232	Belt - Fan & Air Brake Compr.	2027569	5700
Hose - Upper - Pipe To Rad.		21473	Belt - Fan To A.P.	9433881	◆◆9380HD
Hose - Lower - Eng. To Pipe		24236	Belt - Alt. & A.P.; W/108A. Alt.		◆◆9630HD
Hose - Lower - Pipe To Rad.		24238	Belt - Alt. & A.P.; W/80A., 100A. Alt.		◆◆9640HD
Hose - By Pass - Left Side		24222	Belt - Alt. & A.P.; W/105A., 130A., 160A. Alt.		◆◆9650HD
Hose - By Pass - Right Side		21457	Belt - P.S.; W/40" Belt O.C.	9433884	◆◆9395HD
			Belt - P.S.; W/Air Brakes; W/59 1/2" Belt O.C.		◆◆9590HD
			Belt - P.S.; W/Hyd. Brakes; W/64 3/4" Belt O.C.		◆◆9640HD
			Belt - A.P. - From C.S.; W/39" Belt O.C.		◆◆9385HD
			Belt - A.P. - From C.S.; W/54 1/2" Belt O.C.	9433913	◆◆9540HD
			Belt - Air Brake Compr.		◆◆9720HD
			Hose - Upper		21107
			Hose - Lower - Eng. To Pipe		24236
			Hose - Lower - Pipe To Rad.		21556
			Hose - By Pass		24222
GM V-8 5.7 L			1981 - 1980		
B60 B6P Series			Detroit Diesel V-8 8.2 L Diesel		
Belt - Fan & Alt.; W/70A., 108A. Alt.	11502375	◆◆9525HD	B60 B6P Series		
Belt - Fan & Alt.; W/80A., 100A. Alt.	2005476	②◆◆9550HD	Belt - Fan & Alt.; W/71 1/2" Belt O.C.	2099791	◆◆9710HD

◆ Standard Belt Available.
② Two Required.

◆ PowerBand Belt May Work. Use Template to Check.
≈ Cut to Fit.

School Buses

Belts and Coolant Hose for School Buses

School Buses

Application	Mfr. Part No.	Our No.	Application	Mfr. Part No.	Our No.
Chevrolet - Continued			Chevrolet - Continued		
1981 - 1980 - Continued			1981 - 1980 - Continued		
Detroit Diesel V-8 8.2 L Diesel - Continued			GM V-8 7.0 L - Continued		
B60 B6P Series - Continued			B60 B6P Series - Continued		
Belt - Fan & Alt.; W/97 1/2" Belt O.C.	2056956	②♠9700HD	Belt - A.P. - From C.S.; W/39" Belt O.C.		♠9385HD
Belt - Fan & Air Brake Compr.	11502414	♠9700HD	Belt - A.P. - From C.S.; W/54 1/2" Belt O.C.	9433913	♠9540HD
Belt - P.S.	11502340	♠9385HD	Belt - Air Brake Compr.		♠9720HD
Hose - Upper - Eng. To Pipe		24232	Hose - Upper		21107
Hose - Upper - Pipe To Rad.		21473	Hose - Lower - Eng. To Pipe		24236
Hose - Lower - Eng. To Pipe		24236	Hose - Lower - Pipe To Rad.		21556
Hose - Lower - Pipe To Rad.		24238	Hose - By Pass		24222
Hose - By Pass - Left Side		24222			
Hose - By Pass - Right Side		21457			
GM V-8 5.7 L			1979		
B60 B6P Series			GM 6-Cyl. 292		
Belt - Fan & Alt.; W/70A., 108A. Alt.	11502375	♠9525HD	S60 B6P Series		
Belt - Fan & Alt.; W/80A., 100A. Alt.	2005476	②♠9550HD	Belt - Fan & Alt.; W/Std. Alt.	3887682	②♠9395HD
Belt - Fan & Alt.; W/105A., 130A., 160A. Alt.	11502386	②♠9570HD	Belt - Fan & Alt.; W/80A. Alt.	3911543	②♠9412HD
Belt - Fan, Alt. & A.P.; W/80A. Alt.	11502410	♠9670HD	Belt - Fan & Alt.; W/100A. Alt.	690407	②♠9435HD
Belt - Fan, Alt. & A.P.; W/105A., 130A., 160A. Alt.	11502411	♠9680HD	Belt - Fan, Alt. & P.S.; W/Std. Alt.	3947152	♠9500HD
Belt - Fan & P.S.; W/Hyd. Brakes	9433923	♠9590HD	Belt - Fan, Alt. & P.S.; W/80A. Alt.	3885457	♠9510HD
Belt - P.S. & A.P.		♠9640HD	Belt - Fan & A.P.	3947150	♠9530HD
Belt - P.S.; W/Air Brakes	9433881	♠9380HD	Belt - P.S.	9433884	♠9395HD
Belt - Air Brake Compr. & A.P.		♠9670HD	Belt - Hyd. Brake Boost Pump	9433896	♠9455HD
Belt - A.P.		♠9540HD	Belt - A.C.	3888403	7560
Hose - Upper	21095		Hose - Upper		≈<20686
Hose - Lower	21409		Hose - Lower		20489
Hose - By Pass	≈<20777			or	26611
GM V-8 6.0 L			GM V-8 350		
B60 B6P Series			B60 B6P Series		
Belt - Fan & Alt.; W/63A., 108A. Alt.		②♠9640HD	Belt - Fan & Alt.; W/70A., 108A. Alt.	11502375	♠9525HD
Belt - Fan & Alt.; W/80A., 100A. Alt.		②♠9660HD	Belt - Fan & Alt.; W/80A., 100A. Alt.	2005476	②♠9550HD
Belt - Fan & Alt.; W/105A., 130A., 160A. Alt.		②♠9670HD	Belt - Fan & Alt.; W/105A., 130A., 160A. Alt.	11502386	②♠9570HD
Belt - Fan & P.S.		♠9630HD	Belt - Fan, Alt. & A.P.; W/80A. Alt.	11502410	♠9670HD
Belt - Fan & Hyd. Pump		♠9630HD	Belt - Fan, Alt. & A.P.; W/105A., 130A., 160A. Alt.	11502411	♠9680HD
Belt - Fan & Air Brake Compr.	2027569	5700	Belt - Fan & P.S.; W/Hyd. Brakes	9433923	♠9590HD
Belt - Fan To A.P.	9433881	♠9380HD	Belt - P.S. & A.P.		♠9640HD
Belt - Alt. & A.P.; W/108A. Alt.		♠9630HD	Belt - P.S.; W/Air Brakes	9433881	♠9380HD
Belt - Alt. & A.P.; W/80A., 100A. Alt.		♠9640HD	Belt - Air Brake Compr. & A.P.		♠9670HD
Belt - Alt. & A.P.; W/105A., 130A., 160A. Alt.		♠9650HD	Belt - A.P.		♠9540HD
Belt - P.S.; W/40" Belt O.C.	9433884	♠9395HD	Hose - Upper		21095
Belt - P.S.; W/Air Brakes; W/59 1/2" Belt O.C.		♠9590HD	Hose - Lower		21409
Belt - P.S.; W/Hyd. Brakes; W/64 3/4" Belt O.C.		♠9640HD	Hose - By Pass		≈<20777
Belt - A.P. - From C.S.; W/39" Belt O.C.		♠9385HD	GM V-8 366		
Belt - A.P. - From C.S.; W/54 1/2" Belt O.C.	9433913	♠9540HD	B60 B6P Series		
Belt - Air Brake Compr.		♠9720HD	Belt - Fan & Alt.; W/63A., 108A. Alt.		②♠9640HD
Hose - Upper		21107	Belt - Fan & Alt.; W/80A., 100A. Alt.		②♠9660HD
Hose - Lower - Eng. To Pipe		24236	Belt - Fan & Alt.; W/105A., 130A., 160A. Alt.		②♠9670HD
Hose - Lower - Pipe To Rad.		21556	Belt - Fan & P.S.		♠9630HD
Hose - By Pass		24222	Belt - Fan & Hyd. Pump		♠9630HD
GM V-8 7.0 L			Belt - Fan & Air Brake Compr.		
B60 B6P Series			2027569		
Belt - Fan & Alt.; W/63A., 108A. Alt.		②♠9640HD	Belt - Fan To A.P.	9433881	♠9380HD
Belt - Fan & Alt.; W/80A., 100A. Alt.		②♠9660HD	Belt - Alt. & A.P.; W/108A. Alt.		♠9630HD
Belt - Fan & Alt.; W/105A., 130A., 160A. Alt.		②♠9670HD	Belt - Alt. & A.P.; W/80A., 100A. Alt.		♠9640HD
Belt - Fan & P.S.		♠9630HD	Belt - Alt. & A.P.; W/105A., 130A., 160A. Alt.		♠9650HD
Belt - Fan & Hyd. Pump		♠9630HD	Belt - P.S.; W/40" Belt O.C.	9433884	♠9395HD
Belt - Fan & Air Brake Compr.	2027569	5700	Belt - P.S.; W/Air Brakes; W/59 1/2" Belt O.C.		♠9590HD
Belt - Fan To A.P.	9433881	♠9380HD	Belt - P.S.; W/Hyd. Brakes; W/64 3/4" Belt O.C.		♠9640HD
Belt - Alt. & A.P.; W/108A. Alt.		♠9630HD	Belt - A.P. - From C.S.; W/39" Belt O.C.		♠9385HD
Belt - Alt. & A.P.; W/80A., 100A. Alt.		♠9640HD	Belt - A.P. - From C.S.; W/54 1/2" Belt O.C.	9433913	♠9540HD
Belt - Alt. & A.P.; W/105A., 130A., 160A. Alt.		♠9650HD	Belt - Air Brake Compr.		♠9720HD
Belt - P.S.; W/40" Belt O.C.	9433884	♠9395HD	Hose - Upper		21107
Belt - P.S.; W/Air Brakes; W/59 1/2" Belt O.C.		♠9590HD			
Belt - P.S.; W/Hyd. Brakes; W/64 3/4" Belt O.C.		♠9640HD			

♠Standard Belt Available.
②Two Required.

◆PowerBand Belt May Work, Use Template to Check.
≈<Cut to Fit.

Belts and Coolant Hose for School Buses

Application	Mfr. Part No.	Our No.	Application	Mfr. Part No.	Our No.
Chevrolet - Continued			Chevrolet - Continued		
1979 - Continued			1978 - 1977 - Continued		
GM V-8 366 - Continued			GM 6-Cyl. 292 - Continued		
B60 B6P Series - Continued			SS60 - Continued		
Hose - Lower - Eng. To Pipe		24236	Hose - Lower		20489
Hose - Lower - Pipe To Rad.		21556	or		26611
Hose - By Pass		24222	Hose - By Pass		20563
GM V-8 427			Hose - Heater Inlet		28442
B60 B6P Series			Hose - Heater Outlet		28441
Belt - Fan & Alt.; W/63A., 108A. Alt.	②♠◆9640HD		GM V-8 350		
Belt - Fan & Alt.; W/80A., 100A. Alt.	②♠◆9660HD		SE60		
Belt - Fan & Alt.; W/105A., 130A., 160A. Alt.	②♠◆9670HD		Belt - Fan & Alt.; W/65A., 70A. Alt.	9433915	②♠◆9550HD
Belt - Fan & P.S.	♠9630HD		Belt - Fan & Alt.; W/105A., 130A. Alt.	3887691	②♠◆9570HD
Belt - Fan & Hyd. Pump	♠9630HD		Belt - P.S.		♠9385HD
Belt - Fan & Air Brake Compr.	2027569	5700	Belt - Hyd. Brake Boost Pump; W/56 1/4" Belt O.C.	9433917	♠9560HD
Belt - Fan To A.P.	9433881	♠9380HD	Belt - Hyd. Brake Boost Pump; W/59 1/4" Belt O.C.	9433923	♠9590HD
Belt - Alt. & A.P.; W/108A. Alt.		♠9630HD	Belt - Hyd. Brake Boost Pump & A.P.; W/65 1/4" Belt O.C.	9433935	♠9650HD
Belt - Alt. & A.P.; W/80A., 100A. Alt.		♠9640HD	Belt - Hyd. Brake Boost Pump & A.P.; W/68 1/4" Belt O.C.	2027569	♠9680HD
Belt - Alt. & A.P.; W/105A., 130A., 160A. Alt.		♠9650HD	Belt - Air Brake Compr.	3888480	♠9560HD
Belt - P.S.; W/40" Belt O.C.	9433884	♠9395HD	Belt - A.P.		♠9530HD
Belt - P.S.; W/Air Brakes; W/59 1/2" Belt O.C.		♠9590HD	Hose - Upper		21095
Belt - P.S.; W/Hyd. Brakes; W/64 3/4" Belt O.C.		♠9640HD	or		25487
Belt - A.P. - From C.S.; W/39" Belt O.C.		♠9385HD	Hose - Lower		21409
Belt - A.P. - From C.S.; W/54 1/2" Belt O.C.	9433913	♠9540HD	Hose - By Pass - Left Side		20565
Belt - Air Brake Compr.		♠9720HD	Hose - By Pass - Right Side		≈20777
Hose - Upper		21107	GM V-8 366		
Hose - Lower - Eng. To Pipe		24236	SE60		
Hose - Lower - Pipe To Rad.		21556	Belt - Fan & Alt.; W/61A. Alt.		②♠9560HD
Hose - By Pass		24222	Belt - Fan & Alt.; W/A.P.; W/61A. Alt.	9433936	♠9660HD
GM V-8 454			Belt - Fan & Alt.; W/A.P.; W/100A., 105A., 130A. Alt.	9433937	♠9670HD
B60 B6P Series			Belt - Fan & Alt.; W/O A.P.; W/80A. Alt.	9433936	②♠◆9660HD
Belt - Fan & Alt.; W/63A., 108A. Alt.	②♠◆9640HD		Belt - Fan & Alt.; W/O A.P.; W/100A., 105A., 130A. Alt.	9433937	②♠◆9670HD
Belt - Fan & Alt.; W/80A., 100A. Alt.	②♠◆9660HD		Belt - Fan & A.P.	9433932	♠9630HD
Belt - Fan & Alt.; W/105A., 130A., 160A. Alt.	②♠◆9670HD		Belt - Fan & V.P.	3883005	♠9690HD
Belt - Fan & P.S.	♠9630HD		Belt - P.S.	9433884	♠9395HD
Belt - Fan & Hyd. Pump	♠9630HD		Belt - Air Brake Compr.	2027569	5700
Belt - Fan & Air Brake Compr.	2027569	5700	Belt - Air Brake Compr. & A.P.		♠9720HD
Belt - Fan To A.P.	9433881	♠9380HD	Belt - Hyd. Brake Boost Pump	9433929	♠9620HD
Belt - Alt. & A.P.; W/108A. Alt.		♠9630HD	Belt - A.P.	9433881	♠9380HD
Belt - Alt. & A.P.; W/80A., 100A. Alt.		♠9640HD	Hose - Upper		≈20933
Belt - Alt. & A.P.; W/105A., 130A., 160A. Alt.		♠9650HD	Hose - Lower		21011
Belt - P.S.; W/40" Belt O.C.	9433884	♠9395HD	Hose - By Pass		24228
Belt - P.S.; W/Air Brakes; W/59 1/2" Belt O.C.		♠9590HD	GM V-8 427		
Belt - P.S.; W/Hyd. Brakes; W/64 3/4" Belt O.C.		♠9640HD	SE60		
Belt - A.P. - From C.S.; W/39" Belt O.C.		♠9385HD	Belt - Fan & Alt.; W/61A. Alt.		②♠9560HD
Belt - A.P. - From C.S.; W/54 1/2" Belt O.C.	9433913	♠9540HD	Belt - Fan & Alt.; W/A.P.; W/61A. Alt.	9433936	♠9660HD
Belt - Air Brake Compr.		♠9720HD	Belt - Fan & Alt.; W/A.P.; W/100A., 105A., 130A. Alt.	9433937	♠9670HD
Hose - Upper		21107	Belt - Fan & Alt.; W/O A.P.; W/80A. Alt.	9433936	②♠◆9660HD
Hose - Lower - Eng. To Pipe		24236	Belt - Fan & Alt.; W/O A.P.; W/100A., 105A., 130A. Alt.	9433937	②♠◆9670HD
Hose - Lower - Pipe To Rad.		21556	Belt - Fan & A.P.	9433932	♠9630HD
Hose - By Pass		24222	Belt - Fan & V.P.	3883005	♠9690HD
1978 - 1977			Belt - P.S.	9433884	♠9395HD
GM 6-Cyl. 292			Belt - Air Brake Compr.	2027569	5700
SS60			Belt - Air Brake Compr. & A.P.		♠9720HD
Belt - Fan & Alt.; W/Std. Alt.	3887682	②♠9395HD	Belt - Hyd. Brake Boost Pump	9433929	♠9620HD
Belt - Fan & Alt.; W/80A. Alt.	3911543	②♠9412HD	Belt - A.P.	9433881	♠9380HD
Belt - Fan & Alt.; W/100A. Alt.	690407	②♠9435HD	Hose - Upper		≈20933
Belt - Fan, Alt. & P.S.; W/Std. Alt.	3947152	♠9500HD	Hose - Lower		21011
Belt - Fan, Alt. & P.S.; W/80A. Alt.	3885457	♠9510HD	Hose - By Pass		24228
Belt - Fan & A.P.	3947150	♠9530HD	GM V-8 427		
Belt - P.S.	9433884	♠9395HD	SE60		
Belt - Hyd. Brake Boost Pump	9433896	♠9455HD	Belt - Fan & Alt.; W/61A. Alt.		②♠9560HD
Belt - A.C.	3888403	7560	Belt - Fan & Alt.; W/A.P.; W/61A. Alt.	9433936	♠9660HD
Hose - Upper		≈20686	Belt - Fan & Alt.; W/A.P.; W/100A., 105A., 130A. Alt.	9433937	♠9670HD
			Belt - Fan & Alt.; W/O A.P.; W/80A. Alt.	9433936	②♠◆9660HD
			Belt - Fan & Alt.; W/O A.P.; W/100A., 105A., 130A. Alt.	9433937	②♠◆9670HD
			Belt - Fan & A.P.	9433932	♠9630HD
			Belt - Fan & V.P.	3883005	♠9690HD
			Belt - P.S.	9433884	♠9395HD
			Belt - Air Brake Compr.	2027569	5700
			Belt - Air Brake Compr. & A.P.		♠9720HD
			Belt - Hyd. Brake Boost Pump	9433929	♠9620HD
			Belt - A.P.	9433881	♠9380HD
			Hose - Upper		≈20933
			Hose - Lower		21011
			Hose - By Pass		24228

♠Standard Belt Available.
②Two Required.

◆PowerBand Belt May Work, Use Template to Check.
≈Cut to Fit.

Belts and Coolant Hose for School Buses

Application	Mfr. Part No.	Our No.	Application	Mfr. Part No.	Our No.
Chevrolet - Continued			Chevrolet - Continued		
1978 - 1977 - Continued			1976 - Continued		
GM V-8 454			GM V-8 366 - Continued		
SE60			SE60 - Continued		
Belt - Fan & Alt.; W/61A. Alt.		②♣9560HD	Belt - Air Brake Compr. & A.P.		♣9720HD
Belt - Fan & Alt.; W/A.P.; W/61A. Alt.	9433936	♣9660HD	Belt - Hyd. Brake Boost Pump		♣9630HD
Belt - Fan & Alt.; W/A.P.; W/100A., 105A., 130A. Alt.	9433937	♣9670HD	Belt - A.P.	2459498	♣9370HD
Belt - Fan & Alt.; W/O A.P.; W/80A. Alt.	9433936	②♣♠9660HD	Hose - Upper		≈<20933
Belt - Fan & Alt.; W/O A.P.; W/100A., 105A., 130A. Alt.	9433937	②♣♠9670HD	Hose - Lower		21011
Belt - Fan & A.P.	9433932	♣9630HD	Hose - By Pass		24228
Belt - Fan & V.P.	3883005	♣9690HD	GM V-8 427		
Belt - P.S.	9433884	♣9395HD	SE60		
Belt - Air Brake Compr.	2027569	5700	Belt - Fan & Alt.; W/61A. Alt.; W/Single Belt .	690409	♣9510HD
Belt - Air Brake Compr. & A.P.		♣9720HD	Belt - Fan & Alt.; W/61A. Alt.; W/Dual Belts .	3891365	②♣♠9610HD
Belt - Hyd. Brake Boost Pump	9433929	♣9620HD	Belt - Fan & Alt.; W/80A. Alt.		♣9560HD
Belt - A.P.	9433881	♣9380HD	Belt - Fan & Alt.; W/A.P.; W/100A., 105A., 130A. Alt.	9433921	♣9580HD
Hose - Upper		≈<20933	Belt - Fan & Alt.; W/O A.P.; W/100A., 105A., 130A. Alt.	9433921	②♣9580HD
Hose - Lower		21011	Belt - Fan & P.S.	9433884	♣9560HD
Hose - By Pass		24228	Belt - Fan & A.P.	9433921	♣9580HD
1976			Belt - P.S.	9433884	♣9395HD
GM 6-Cyl. 292			Belt - Air Brake Compr.	3883005	♣9690HD
SS60			Belt - Air Brake Compr. & A.P.		♣9720HD
Belt - Fan & Alt.; W/Std. Alt.	3887682	②♣9395HD	Belt - Hyd. Brake Boost Pump		♣9630HD
Belt - Fan & Alt.; W/80A. Alt.	3911543	②♣9412HD	Belt - A.P.	2459498	♣9370HD
Belt - Fan & Alt.; W/100A. Alt.	690407	②♣9435HD	Hose - Upper		≈<20933
Belt - Fan, Alt. & P.S.; W/Std. Alt.	3947152	♣9500HD	Hose - Lower		21011
Belt - Fan, Alt. & P.S.; W/80A. Alt.	3885457	♣9510HD	Hose - By Pass		24228
Belt - Fan & A.P.	3947150	♣9530HD	GM V-8 454		
Belt - P.S.	9433884	♣9395HD	SE60		
Belt - Hyd. Brake Boost Pump	9433896	♣9455HD	Belt - Fan & Alt.; W/61A. Alt.; W/Single Belt .	690409	♣9510HD
Belt - A.C.	3888403	7560	Belt - Fan & Alt.; W/61A. Alt.; W/Dual Belts .	3891365	②♣♠9610HD
Hose - Upper		≈<20686	Belt - Fan & Alt.; W/80A. Alt.		♣9560HD
Hose - Lower		20489	Belt - Fan & Alt.; W/A.P.; W/100A., 105A., 130A. Alt.	9433921	♣9580HD
		or	Belt - Fan & Alt.; W/O A.P.; W/100A., 105A., 130A. Alt.	9433921	②♣9580HD
		26611	Belt - Fan & P.S.	9433884	♣9560HD
Hose - By Pass		20563	Belt - Fan & A.P.	9433921	♣9580HD
Hose - Heater Inlet		28442	Belt - P.S.	9433884	♣9395HD
Hose - Heater Outlet		28441	Belt - Air Brake Compr.	3883005	♣9690HD
GM V-8 350			Belt - Air Brake Compr. & A.P.		♣9720HD
SE60			Belt - Hyd. Brake Boost Pump		♣9630HD
Belt - Fan & Alt.; W/56 3/8" Belt O.C.		♣9560HD	Belt - A.P.	2459498	♣9370HD
Belt - Fan & Alt.; W/58 3/8" Belt O.C.	3891359	♣9580HD	Hose - Upper		≈<20933
Belt - P.S.		♣9385HD	Hose - Lower		21011
Belt - Hyd. Brake Boost Pump	9433923	♣9590HD	Hose - By Pass		24228
Belt - Hyd. Brake Boost Pump & A.P.	2027569	♣9680HD	1975		
Belt - Air Brake Compr.		♣9640HD	GM 6-Cyl. 292		
Belt - A.P.		♣9530HD	SS60		
Hose - Upper		20607	Belt - Fan & Alt.; W/Std. Alt.	3887682	②♣9395HD
		or	Belt - Fan & Alt.; W/80A. Alt.	3911543	②♣9412HD
		25484	Belt - Fan & Alt.; W/100A. Alt.	690407	②♣9435HD
Hose - Lower; W/Hyd. Brakes		20558	Belt - Fan, Alt. & P.S.; W/Std. Alt.	3947152	♣9500HD
		or	Belt - Fan, Alt. & P.S.; W/80A. Alt.	3885457	♣9510HD
		26611	Belt - Fan & A.P.	3947150	♣9530HD
Hose - By Pass - Left Side		20565	Belt - P.S.	9433884	♣9395HD
Hose - By Pass - Right Side		20566	Belt - Hyd. Brake Boost Pump	9433896	♣9455HD
GM V-8 366			Belt - A.C.	3888403	7560
SE60			Hose - Upper		≈<20686
Belt - Fan & Alt.; W/61A. Alt.; W/Single Belt .	690409	♣9510HD	Hose - Lower		20489
Belt - Fan & Alt.; W/61A. Alt.; W/Dual Belts .	3891365	②♣♠9610HD			or
Belt - Fan & Alt.; W/80A. Alt.		♣9560HD			26611
Belt - Fan & Alt.; W/A.P.; W/100A., 105A., 130A. Alt.	9433921	♣9580HD	Hose - By Pass		20563
Belt - Fan & Alt.; W/O A.P.; W/100A., 105A., 130A. Alt.	9433921	②♣9580HD	Hose - Heater Inlet		28442
Belt - Fan & P.S.	9433884	♣9560HD	Hose - Heater Outlet		28441
Belt - Fan & A.P.	9433921	♣9580HD			
Belt - P.S.	9433884	♣9395HD			
Belt - Air Brake Compr.	3883005	♣9690HD			

♣Standard Belt Available.
②Two Required.

♠PowerBand Belt May Work, Use Template to Check.
≈<Cut to Fit.

Belts and Coolant Hose for School Buses

Application	Mfr. Part No.	Our No.	Application	Mfr. Part No.	Our No.
Chevrolet - Continued			Chevrolet - Continued		
1975 - Continued			1975 - Continued		
GM V-8 350			GM V-8 454 - Continued		
SE60			SE60 - Continued		
Belt - Fan & Alt.; W/56 3/8" Belt O.C.		♣9560HD	Belt - Air Brake Compr. & A.P.		♣9720HD
Belt - Fan & Alt.; W/58 3/8" Belt O.C.	3891359	♣9580HD	Belt - Hyd. Brake Boost Pump		♣9630HD
Belt - P.S.		♣9385HD	Belt - A.P.	2459498	♣9370HD
Belt - Hyd. Brake Boost Pump	9433923	♣9590HD	Hose - Upper		≈<20933
Belt - Hyd. Brake Boost Pump & A.P.	2027569	♣9680HD	Hose - Lower		21011
Belt - Air Brake Compr.		♣9640HD	Hose - By Pass		24228
Belt - A.P.		♣9530HD			
Hose - Upper		20607	GMC V-6 478 Diesel		
		or	SG60		
		25484	Belt - Fan & Alt.	2483870	②♣♠9590HD
Hose - Lower; W/Hyd. Brakes		20558	Belt - P.S.	3887676	♣9451HD
		or	Belt - Air Brake Compr.	3883002	♣9600HD
		26611	Belt - V.P.	3905091	♣9580HD
Hose - By Pass - Left Side		20565			
Hose - By Pass - Right Side		20566			
GM V-8 366			1974		
SE60			GM 6-Cyl. 292		
Belt - Fan & Alt.; W/61A. Alt.; W/Single Belt .690409		♣9510HD	SS60		
Belt - Fan & Alt.; W/61A. Alt.; W/Dual Belts .3891365		②♣♠9610HD	Belt - Fan & Alt.; W/Std. Alt.	3887682	②♣9395HD
Belt - Fan & Alt.; W/80A. Alt.		♣9560HD	Belt - Fan & Alt.; W/80A. Alt.	3911543	②♣9412HD
Belt - Fan & Alt.; W/A.P.; W/100A., 105A., 130A. Alt.	9433921	♣9580HD	Belt - Fan & Alt.; W/100A. Alt.	690407	②♣9435HD
Belt - Fan & Alt.; W/O A.P.; W/100A., 105A., 130A. Alt.	9433921	②♣9580HD	Belt - Fan, Alt. & P.S.; W/Std. Alt.	3947152	♣9500HD
Belt - Fan & P.S.	9433884	♣9560HD	Belt - Fan, Alt. & P.S.; W/80A. Alt.	3885457	♣9510HD
Belt - Fan & A.P.	9433921	♣9580HD	Belt - Fan & A.P.	3947150	♣9530HD
Belt - P.S.	9433884	♣9395HD	Belt - P.S.	9433884	♣9395HD
Belt - Air Brake Compr.	3883005	♣9690HD	Belt - Hyd. Brake Boost Pump	9433896	♣9455HD
Belt - Air Brake Compr. & A.P.		♣9720HD	Belt - A.C.	3888403	7560
Belt - Hyd. Brake Boost Pump		♣9630HD	Hose - Upper		≈<20686
Belt - A.P.	2459498	♣9370HD	Hose - Lower		20489
Hose - Upper		≈<20933			or
Hose - Lower		21011	Hose - By Pass		26611
Hose - By Pass		24228	Hose - Heater Inlet		20563
			Hose - Heater Outlet		28442
					28441
GM V-8 427			GM V-8 350		
SE60			SE60		
Belt - Fan & Alt.; W/61A. Alt.; W/Single Belt .690409		♣9510HD	Belt - Fan & Alt.; W/56 3/8" Belt O.C.		♣9560HD
Belt - Fan & Alt.; W/61A. Alt.; W/Dual Belts .3891365		②♣♠9610HD	Belt - Fan & Alt.; W/58 3/8" Belt O.C.	3891359	♣9580HD
Belt - Fan & Alt.; W/80A. Alt.		♣9560HD	Belt - P.S.		♣9385HD
Belt - Fan & Alt.; W/A.P.; W/100A., 105A., 130A. Alt.	9433921	♣9580HD	Belt - Hyd. Brake Boost Pump	9433923	♣9590HD
Belt - Fan & Alt.; W/O A.P.; W/100A., 105A., 130A. Alt.	9433921	②♣9580HD	Belt - Hyd. Brake Boost Pump & A.P.	2027569	♣9680HD
Belt - Fan & P.S.	9433884	♣9560HD	Belt - Air Brake Compr.		♣9640HD
Belt - Fan & A.P.	9433921	♣9580HD	Belt - A.P.		♣9530HD
Belt - P.S.	9433884	♣9395HD	Hose - Upper		20607
Belt - Air Brake Compr.	3883005	♣9690HD			or
Belt - Air Brake Compr. & A.P.		♣9720HD			25484
Belt - Hyd. Brake Boost Pump		♣9630HD	Hose - Lower; W/Hyd. Brakes		20558
Belt - A.P.	2459498	♣9370HD			or
Hose - Upper		≈<20933			26611
Hose - Lower		21011	Hose - By Pass - Left Side		20565
Hose - By Pass		24228	Hose - By Pass - Right Side		20566
GM V-8 454			GM V-8 366		
SE60			SE60		
Belt - Fan & Alt.; W/61A. Alt.; W/Single Belt .690409		♣9510HD	Belt - Fan & Alt.; W/61A. Alt.; W/Single Belt .690409		♣9510HD
Belt - Fan & Alt.; W/61A. Alt.; W/Dual Belts .3891365		②♣♠9610HD	Belt - Fan & Alt.; W/61A. Alt.; W/Dual Belts .3891365		②♣♠9610HD
Belt - Fan & Alt.; W/80A. Alt.		♣9560HD	Belt - Fan & Alt.; W/80A. Alt.		♣9560HD
Belt - Fan & Alt.; W/A.P.; W/100A., 105A., 130A. Alt.	9433921	♣9580HD	Belt - Fan & Alt.; W/A.P.; W/100A., 105A., 130A. Alt.	9433921	♣9580HD
Belt - Fan & Alt.; W/O A.P.; W/100A., 105A., 130A. Alt.	9433921	②♣9580HD	Belt - Fan & Alt.; W/O A.P.; W/100A., 105A., 130A. Alt.	9433921	②♣9580HD
Belt - Fan & P.S.	9433884	♣9560HD	Belt - Fan & P.S.	9433884	♣9560HD
Belt - Fan & A.P.	9433921	♣9580HD	Belt - Fan & A.P.	9433921	♣9580HD
Belt - P.S.	9433884	♣9395HD	Belt - P.S.	9433884	♣9395HD
Belt - Air Brake Compr.	3883005	♣9690HD	Belt - Air Brake Compr.	3883005	♣9690HD
Belt - Air Brake Compr. & A.P.		♣9720HD	Belt - Air Brake Compr. & A.P.		♣9720HD
Belt - Hyd. Brake Boost Pump		♣9630HD	Belt - Hyd. Brake Boost Pump		♣9630HD
Belt - A.P.	2459498	♣9370HD	Belt - A.P.	2459498	♣9370HD
Hose - Upper		≈<20933			
Hose - Lower		21011			
Hose - By Pass		24228			

♣Standard Belt Available.
②Two Required.

♠PowerBand Belt May Work, Use Template to Check.
≈<Cut to Fit.

Belts and Coolant Hose for School Buses

Application	Mfr. Part No.	Our No.	Application	Mfr. Part No.	Our No.
Chevrolet - Continued			Chevrolet - Continued		
1974 - Continued			1973 - Continued		
GM V-8 427			GM V-8 307 - Continued		
SE60			SE60 - Continued		
Belt - Fan & Alt.; W/61A. Alt.; W/Single Belt .690409		♣9510HD	Belt - Air Brake Compr.		♣9640HD
Belt - Fan & Alt.; W/61A. Alt.; W/Dual Belts .3891365		②♣♠9610HD	Belt - A.P.		♣9530HD
Belt - Fan & Alt.; W/80A. Alt.		♣9560HD	Hose - Upper		20607
Belt - Fan & Alt.; W/A.P.; W/100A., 105A., 130A. Alt.	9433921	♣9580HD		or	25484
Belt - Fan & Alt.; W/O A.P.; W/100A., 105A., 130A. Alt.	9433921	②♣9580HD	Hose - Lower; W/Hyd. Brakes		20558
Belt - Fan & P.S.	9433884	♣9560HD		or	26611
Belt - Fan & A.P.	9433921	♣9580HD	Hose - By Pass - Left Side		20565
Belt - P.S.	9433884	♣9395HD	Hose - By Pass - Right Side		20566
Belt - Air Brake Compr.	3883005	♣9690HD	GM V-8 350		
Belt - Air Brake Compr. & A.P.		♣9720HD	SE60		
Belt - Hyd. Brake Boost Pump		♣9630HD	Belt - Fan & Alt.; W/56 3/8" Belt O.C.		♣9560HD
Belt - A.P.	2459498	♣9370HD	Belt - Fan & Alt.; W/58 3/8" Belt O.C.	3891359	♣9580HD
GM V-8 454			Belt - P.S.		♣9385HD
SE60			Belt - Hyd. Brake Boost Pump	9433923	♣9590HD
Belt - Fan & Alt.; W/61A. Alt.; W/Single Belt .690409		♣9510HD	Belt - Hyd. Brake Boost Pump & A.P.	2027569	♣9680HD
Belt - Fan & Alt.; W/61A. Alt.; W/Dual Belts .3891365		②♣♠9610HD	Belt - Air Brake Compr.		♣9640HD
Belt - Fan & Alt.; W/80A. Alt.		♣9560HD	Belt - A.P.		♣9530HD
Belt - Fan & Alt.; W/A.P.; W/100A., 105A., 130A. Alt.	9433921	♣9580HD	Hose - Upper		20607
Belt - Fan & Alt.; W/O A.P.; W/100A., 105A., 130A. Alt.	9433921	②♣9580HD		or	25484
Belt - Fan & P.S.	9433884	♣9560HD	Hose - Lower; W/Hyd. Brakes		20558
Belt - Fan & A.P.	9433921	♣9580HD		or	26611
Belt - P.S.	9433884	♣9395HD	Hose - By Pass - Left Side		20565
Belt - Air Brake Compr.	3883005	♣9690HD	Hose - By Pass - Right Side		20566
Belt - Air Brake Compr. & A.P.		♣9720HD	GM V-8 366		
Belt - Hyd. Brake Boost Pump		♣9630HD	SE60		
Belt - A.P.	2459498	♣9370HD	Belt - Fan & Alt.; W/61A. Alt.; W/Single Belt .690409		♣9510HD
GMC V-6 478 Diesel			Belt - Fan & Alt.; W/61A. Alt.; W/Dual Belts .3891365		②♣♠9610HD
SG60			Belt - Fan & Alt.; W/80A. Alt.		♣9560HD
Belt - Fan & Alt.	2483870	②♣♠9590HD	Belt - Fan & Alt.; W/A.P.; W/100A., 105A., 130A. Alt.	9433921	♣9580HD
Belt - P.S.	3887676	♣9451HD	Belt - Fan & Alt.; W/O A.P.; W/100A., 105A., 130A. Alt.	9433921	②♣9580HD
Belt - Air Brake Compr.	3883002	♣9600HD	Belt - Fan & P.S.	9433884	♣9560HD
Belt - V.P.	3905091	♣9580HD	Belt - Fan & A.P.	9433921	♣9580HD
Hose - Upper		26611	Belt - P.S.	9433884	♣9395HD
1973			Belt - Air Brake Compr.	3883005	♣9690HD
GM 6-Cyl. 292			Belt - Air Brake Compr. & A.P.		♣9720HD
SS60			Belt - Hyd. Brake Boost Pump		♣9630HD
Belt - Fan & Alt.; W/Std. Alt.	3887682	②♣9395HD	Belt - A.P.	2459498	♣9370HD
Belt - Fan & Alt.; W/80A. Alt.	3911543	②♣9412HD	GM V-8 427		
Belt - Fan & Alt.; W/100A. Alt.	690407	②♣9435HD	SE60		
Belt - Fan, Alt. & P.S.; W/Std. Alt.	3947152	♣9500HD	Belt - Fan & Alt.; W/61A. Alt.; W/Single Belt .690409		♣9510HD
Belt - Fan, Alt. & P.S.; W/80A. Alt.	3885457	♣9510HD	Belt - Fan & Alt.; W/61A. Alt.; W/Dual Belts .3891365		②♣♠9610HD
Belt - Fan & A.P.	3947150	♣9530HD	Belt - Fan & Alt.; W/80A. Alt.		♣9560HD
Belt - P.S.	9433884	♣9395HD	Belt - Fan & Alt.; W/A.P.; W/100A., 105A., 130A. Alt.	9433921	♣9580HD
Belt - Hyd. Brake Boost Pump	9433896	♣9455HD	Belt - Fan & Alt.; W/O A.P.; W/100A., 105A., 130A. Alt.	9433921	②♣9580HD
Belt - A.C.	3888403	7560	Belt - Fan & P.S.	9433884	♣9560HD
Hose - Upper		≈20686	Belt - Fan & A.P.	9433921	♣9580HD
Hose - Lower		20489	Belt - P.S.	9433884	♣9395HD
		or	Belt - Air Brake Compr.	3883005	♣9690HD
Hose - By Pass		20563	Belt - Air Brake Compr. & A.P.		♣9720HD
Hose - Heater Inlet		28442	Belt - Hyd. Brake Boost Pump		♣9630HD
Hose - Heater Outlet		28441	Belt - A.P.	2459498	♣9370HD
GM V-8 307			GM V-8 454		
SE60			SE60		
Belt - Fan & Alt.; W/56 3/8" Belt O.C.		♣9560HD	Belt - Fan & Alt.; W/61A. Alt.; W/Single Belt .690409		♣9510HD
Belt - Fan & Alt.; W/58 3/8" Belt O.C.	3891359	♣9580HD	Belt - Fan & Alt.; W/61A. Alt.; W/Dual Belts .3891365		②♣♠9610HD
Belt - P.S.		♣9385HD	Belt - Fan & Alt.; W/80A. Alt.		♣9560HD
Belt - Hyd. Brake Boost Pump	9433923	♣9590HD	Belt - Fan & Alt.; W/A.P.; W/100A., 105A., 130A. Alt.	9433921	♣9580HD
Belt - Hyd. Brake Boost Pump & A.P.	2027569	♣9680HD			

♣Standard Belt Available.
②Two Required.

♠PowerBand Belt May Work, Use Template to Check.
≈Cut to Fit.

Belts and Coolant Hose for School Buses

Application	Mfr. Part No.	Our No.	Application	Mfr. Part No.	Our No.
Chevrolet - Continued			Chevrolet - Continued		
1973 - Continued			1971 - Continued		
GM V-8 454 - Continued			GM 6-Cyl. 292 - Continued		
SE60 - Continued			SS50 - Continued		
Belt - Fan & Alt.; W/O A.P.; W/100A., 105A., 130A. Alt.	9433921	②▲9580HD	Belt - Fan & Air Brake Compr.	3943162	▲9660HD
Belt - Fan & P.S.	9433884	▲9560HD	Hose - Upper		≈<20686
Belt - Fan & A.P.	9433921	▲9580HD	Hose - Lower		20489
Belt - P.S.	9433884	▲9395HD		or	26611
Belt - Air Brake Compr.	3883005	▲9690HD	Hose - By Pass		20563
Belt - Air Brake Compr. & A.P.		▲9720HD	Hose - Heater Inlet		28442
Belt - Hyd. Brake Boost Pump		▲9630HD	Hose - Heater Outlet		28441
Belt - A.P.	2459498	▲9370HD			
GMC V-6 478 Diesel			GM V-8 307		
SG60			S50; SE50		
Belt - Fan & Alt.	2483870	②▲◆9590HD	Belt - Fan & Alt.; W/42A. Alt.	3888480	②▲9560HD
Belt - P.S.	3887676	▲9451HD	Belt - Fan & Alt.; W/62A., 100A. Alt.	3891358	②▲◆9590HD
Belt - Air Brake Compr.	3883002	▲9600HD	Belt - Fan & Alt.; W/130A. Alt.	3891369	②▲9590HD
Belt - V.P.	3905091	▲9580HD	Belt - P.S.	3888401	▲9412HD
Hose - Upper		26611	Belt - Air Brake Compr.	3885457	▲9510HD
			Belt - Air Brake Compr. & A.P.	3887683	▲9670HD
			Belt - A.P.	3885457	▲9510HD
1972			GM V-8 350		
GM 6-Cyl. 292			S50; SE50		
SS50			Belt - Fan & Alt.; W/42A. Alt.		
Belt - Fan & Alt.	3887682	▲9395HD	Belt - Fan & Alt.; W/62A., 100A. Alt.	3891358	②▲◆9590HD
Belt - Fan, Alt. & P.S.	3947152	▲9500HD	Belt - Fan & Alt.; W/130A. Alt.	3891369	②▲9590HD
Belt - Fan & Air Brake Compr.	3943162	▲9660HD	Belt - P.S.	3888401	▲9412HD
Hose - Upper		≈<20686	Belt - Air Brake Compr.	3885457	▲9510HD
Hose - Lower		20489	Belt - Air Brake Compr. & A.P.	3887683	▲9670HD
	or	26611	Belt - A.P.	3885457	▲9510HD
Hose - By Pass		20563			
Hose - Heater Inlet		28442			
Hose - Heater Outlet		28441			
GM V-8 307			1970		
S50; SE50			GM 6-Cyl. 250		
Belt - Fan & Alt.; W/42A. Alt.	3888480	②▲9560HD	S50		
Belt - Fan & Alt.; W/62A., 100A. Alt.	3891358	②▲◆9590HD	Belt - Alt.; W/O 62A. Alt.; W/O A.C.; W/O P.S.		
Belt - Fan & Alt.; W/130A. Alt.	3891369	②▲9590HD	Belt - Alt.; W/O 62A. Alt.; W/A.C.; W/P.S.		
Belt - P.S.	3888401	▲9412HD	Belt - Alt.; W/62A. Alt.; W/O A.C.; W/O P.S.		
Belt - Air Brake Compr.	3885457	▲9510HD	Belt - Alt.; W/62A. Alt.; W/A.C.; W/P.S.		
Belt - Air Brake Compr. & A.P.	3887683	▲9670HD	Belt - Alt. & P.S.		
Belt - A.P.	3885457	▲9510HD	Hose - Upper		
			Hose - Lower		
			SS40		
			Belt - Fan & Alt.; W/P.S.		
			Belt - Fan & Alt.; W/O P.S.		
			Belt - Fan, Alt. & P.S.		
			Belt - Fan & A.C.		
			Hose - Upper		
			Hose - Lower		
			or		
			26611		
			GM 6-Cyl. 292		
			SS50		
			Belt - Fan & Alt.		
			Belt - Fan, Alt. & P.S.		
			Belt - Fan & Air Brake Compr.		
			Hose - Upper		
			Hose - Lower		
			or		
			26611		
			Hose - By Pass		
			Hose - Heater Inlet		
			Hose - Heater Outlet		
			28441		
			GM V-8 307		
			S50; SE50		
			Belt - Fan & Alt.; W/42A. Alt.		
			Belt - Fan & Alt.; W/62A., 100A. Alt.		
			Belt - Fan & Alt.; W/130A. Alt.		
			Belt - P.S.		

▲Standard Belt Available.
②Two Required.

◆PowerBand Belt May Work, Use Template to Check.
≈<Cut to Fit.

School Buses

Belts and Coolant Hose for School Buses

School Buses

Application	Mfr. Part No.	Our No.	Application	Mfr. Part No.	Our No.
Chevrolet - Continued			Chevrolet - Continued		
1970 - Continued			1969 - Continued		
GM V-8 307 - Continued			GM V-8 350		
S50; SE50 - Continued			S50; SE50		
Belt - Air Brake Compr.	3885457	♣9510HD	Belt - Fan & Alt.; W/42A. Alt.	3888480	②♣9560HD
Belt - Air Brake Compr. & A.P.	3887683	♣9670HD	Belt - Fan & Alt.; W/62A., 100A. Alt.	3891358	②♣♣9590HD
Belt - A.P.	3885457	♣9510HD	Belt - Fan & Alt.; W/130A. Alt.	3891369	②♣9590HD
GM V-8 350			Belt - P.S.		
S50; SE50			3888401		
Belt - Fan & Alt.; W/42A. Alt.	3888480	②♣9560HD	♣9412HD		
Belt - Fan & Alt.; W/62A., 100A. Alt.	3891358	②♣♣9590HD	♣9510HD		
Belt - Fan & Alt.; W/130A. Alt.	3891369	②♣9590HD	♣9510HD		
Belt - P.S.	3888401	♣9412HD	♣9670HD		
Belt - Air Brake Compr.	3885457	♣9510HD	♣9510HD		
Belt - Air Brake Compr. & A.P.	3887683	♣9670HD			
Belt - A.P.	3885457	♣9510HD			
1969			SE60		
GM 6-Cyl. 230			Hose - Upper		
SS40			20607		
Belt - Fan & Alt.; W/P.S.	3850801	7390	or		
Belt - Fan & Alt.; W/O P.S.	3850801	②7390	25484		
Belt - Fan, Alt. & P.S.	3871257	7545	20558		
Belt - Fan, Alt. & A.P.	3861940	7512	or		
Belt - Fan & A.C.	3847709	7550	26611		
Hose - Upper		≈<20686	20565		
Hose - Lower		20489	Hose - By Pass - Right Side		
		or 26611	20566		
GM 6-Cyl. 250			GM V-8 366		
SS40			SE60		
Belt - Fan & Alt.; W/P.S.	3850801	7390	Hose - Upper		
Belt - Fan & Alt.; W/O P.S.	3850801	②7390	20933		
Belt - Fan, Alt. & P.S.	3871257	7545	Hose - Lower; W/Auto. Trans.		
Belt - Fan, Alt. & A.P.	3861940	7512	20587		
Belt - Fan & A.C.	3847709	7550			
Hose - Upper		≈<20686	GM V-8 427		
Hose - Lower		20489	SE60		
		or 26611	Hose - Upper		
GM 6-Cyl. 292			20933		
SS50			Hose - Lower; W/Auto. Trans.		
Belt - Fan & Alt.	3887682	♣9395HD	20587		
Belt - Fan, Alt. & P.S.		♣9530HD			
Belt - Fan & Air Brake Compr.; W/O P.S.	3887683	♣9670HD			
Hose - Upper		≈<20686			
Hose - Lower		20489			
		or 26611			
Hose - By Pass		20563			
Hose - Heater Inlet		28442			
Hose - Heater Outlet		28441			
GM V-8 307			1968		
S50; SE50			GM 6-Cyl. 230		
Belt - Fan & Alt.; W/42A. Alt.	3888480	②♣9560HD	SS40		
Belt - Fan & Alt.; W/62A., 100A. Alt.	3891358	②♣♣9590HD	Belt - Fan & Alt.; W/P.S.		
Belt - Fan & Alt.; W/130A. Alt.	3891369	②♣9590HD	3850801		
Belt - P.S.	3888401	♣9412HD	7390		
Belt - Air Brake Compr.	3885457	♣9510HD	②7390		
Belt - Air Brake Compr. & A.P.	3887683	♣9670HD	7545		
Belt - A.P.	3885457	♣9510HD	7545		
SE60			7512		
Hose - Upper		20607	7550		
		or 25484	≈<20686		
Hose - Lower; W/Hyd. Brakes		20558	20489		
		or 26611	20489		
Hose - By Pass - Left Side		20565	or 26611		
Hose - By Pass - Right Side		20566			
GM V-8 350			GM 6-Cyl. 250		
S50; SE50			SS40		
Belt - Fan & Alt.; W/42A. Alt.	3888480	②♣9560HD	Belt - Fan & Alt.; W/P.S.		
Belt - Fan & Alt.; W/62A., 100A. Alt.	3891358	②♣♣9590HD	3850801		
Belt - Fan & Alt.; W/130A. Alt.	3891369	②♣9590HD	7390		
Belt - P.S.	3888401	♣9412HD	②7390		
Belt - Air Brake Compr.	3885457	♣9510HD	7545		
Belt - Air Brake Compr. & A.P.	3887683	♣9670HD	7545		
Belt - A.P.	3885457	♣9510HD	7512		
SE60			7550		
Hose - Upper		20607	≈<20686		
		or 25484	20489		
Hose - Lower; W/Hyd. Brakes		20558	20489		
		or 26611	or 26611		
Hose - By Pass - Left Side		20565			
Hose - By Pass - Right Side		20566			
GM V-8 307			GM 6-Cyl. 292		
S50; SE50			SS50		
Belt - Fan & Alt.; W/O 62A. Alt.	3888480	②♣9560HD	Belt - Fan & Alt.		
Belt - Fan & Alt.; W/62A. Alt.	3887690	②♣♣9570HD	3887682		
Belt - P.S.	3888401	♣9412HD	♣9530HD		
Belt - Air Brake Compr.		♣9412HD	♣9530HD		
Belt - Air Brake Compr.		♣9640HD	♣9670HD		

♣Standard Belt Available.
 ◆PowerBand Belt May Work, Use Template to Check.

②Two Required.
 ≈<Cut to Fit.

Belts and Coolant Hose for School Buses

Application	Mfr. Part No.	Our No.	Application	Mfr. Part No.	Our No.
Chevrolet - Continued			Chevrolet - Continued		
1968 - Continued			1967 - Continued		
GM V-8 307 - Continued			GM V-6 478		
S50; SE50 - Continued			RM8000		
Belt - Air Brake Compr. & P.S.	3902101	♣9720HD	Belt - W.P. & Alt.; W/60 1/4" Belt O.C.	2485210	②♣9600HD
GM V-8 327			Belt - W.P. & Alt.; W/61 1/4" Belt O.C.	3891365	②♣9610HD
S50; SE50			Belt - W.P. & Alt.; W/62 1/4" Belt O.C.	3888486	②♣9620HD
Belt - Fan & Alt.; W/O 62A. Alt.	3888480	②♣9560HD	Belt - W.P. & Alt.; W/66 1/4" Belt O.C.	2479287	②♣9660HD
Belt - Fan & Alt.; W/62A. Alt.	3887690	②♣9570HD	Belt - W.P. & Alt.; W/67 1/4" Belt O.C.	2483914	②♣9670HD
Belt - P.S.	3888401	♣9412HD	Belt - P.S.; W/39 3/4" Belt O.C.	2477462	♣9395HD
Belt - Air Brake Compr.		♣9640HD	Belt - P.S.; W/40 3/4" Belt O.C.	3887674	♣9405HD
Belt - Air Brake Compr. & P.S.	3902101	♣9720HD	Belt - Air Brake Compr.		♣9660HD
GM V-8 366			GM V-8 283		
SE60			S50; SE50		
Hose - Upper		20933	Belt - Fan & Alt.; W/O 62A. Alt.	3888480	②♣9560HD
Hose - Lower; W/Auto. Trans.		20587	Belt - Fan & Alt.; W/62A. Alt.	3887690	②♣9570HD
GM V-8 427			Belt - P.S.	3888401	♣9412HD
SE60			Belt - Air Brake Compr.	3887683	♣9670HD
Hose - Upper		20933	Belt - Air Brake Compr. & P.S.	3902101	♣9720HD
Hose - Lower; W/Auto. Trans.		20587	GM V-8 327		
1967			S50; SE50		
GM 6-Cyl. 230			Belt - Fan & Alt.; W/O 62A. Alt.		
SS40			Belt - Fan & Alt.; W/62A. Alt.		
Belt - Fan & Alt.; W/P.S.	3850801	7390	Belt - P.S.	3888401	♣9412HD
Belt - Fan & Alt.; W/O P.S.	3850801	②7390	Belt - Air Brake Compr.	3887683	♣9670HD
Belt - Fan, Alt. & P.S.	3871257	7545	Belt - Air Brake Compr. & P.S.	3902101	♣9720HD
Belt - Fan, Alt. & A.P.	3861940	7512	GM V-8 366		
Belt - Fan & A.C.	3847709	7550	SE60		
Hose - Upper		≈20686	Hose - Upper		
Hose - Lower		20489	Hose - Lower; W/Auto. Trans.		
	or	26611			
GM 6-Cyl. 250			1966		
SS40			GM 6-Cyl. 292		
Belt - Fan & Alt.; W/P.S.	3850801	7390	SS50		
Belt - Fan & Alt.; W/O P.S.	3850801	②7390	Hose - Upper; W/Auto. Trans.		
Belt - Fan, Alt. & P.S.	3871257	7545			≈21660
Belt - Fan, Alt. & A.P.	3861940	7512		or	25474
Belt - Fan & A.C.	3847709	7550	Hose - Upper; W/Man. Trans.		
Hose - Upper		≈20686	Hose - Lower		
Hose - Lower		20489			20584
	or	26611			26612
GM 6-Cyl. 292			Hose - By Pass		
SS50			Hose - Heater Inlet		
Belt - Fan & Alt.	3887682	♣9395HD	Hose - Heater Outlet		
Belt - Fan, Alt. & P.S.		♣9530HD			
Belt - Fan & Air Brake Compr.; W/O P.S.	3887683	♣9670HD			
Hose - Upper		≈20686			
Hose - Lower		20489			
	or	26611			
Hose - By Pass		20563			
Hose - Heater Inlet		28442			
Hose - Heater Outlet		28441			
GM V-6 401			GM V-6 401		
RM8000			RM8000		
Belt - W.P. & Alt.; W/60 1/4" Belt O.C.	2485210	②♣9600HD	Belt - W.P. & Alt.; W/60 1/4" Belt O.C.	2485210	②♣9600HD
Belt - W.P. & Alt.; W/61 1/4" Belt O.C.	3891365	②♣9610HD	Belt - W.P. & Alt.; W/61 1/4" Belt O.C.	3891365	②♣9610HD
Belt - W.P. & Alt.; W/62 1/4" Belt O.C.	3888486	②♣9620HD	Belt - W.P. & Alt.; W/62 1/4" Belt O.C.	3888486	②♣9620HD
Belt - W.P. & Alt.; W/66 1/4" Belt O.C.	2479287	②♣9660HD	Belt - W.P. & Alt.; W/66 1/4" Belt O.C.	2479287	②♣9660HD
Belt - W.P. & Alt.; W/67 1/4" Belt O.C.	2483914	②♣9670HD	Belt - W.P. & Alt.; W/67 1/4" Belt O.C.	2483914	②♣9670HD
Belt - P.S.; W/39 3/4" Belt O.C.	2477462	♣9395HD	Belt - P.S.; W/39 3/4" Belt O.C.	2477462	♣9395HD
Belt - P.S.; W/40 3/4" Belt O.C.	3887674	♣9405HD	Belt - P.S.; W/40 3/4" Belt O.C.	3887674	♣9405HD
Belt - Air Brake Compr.		♣9660HD	Belt - Air Brake Compr.		♣9660HD
GM V-6 478			GM V-8 283		
RM8000			S50; SE50		
Belt - W.P. & Alt.; W/60 1/4" Belt O.C.	2485210	②♣9600HD	Belt - Fan & Alt.; 1st Design		
Belt - W.P. & Alt.; W/61 1/4" Belt O.C.	3891365	②♣9610HD	3887684		
Belt - W.P. & Alt.; W/62 1/4" Belt O.C.	3888486	②♣9620HD			
Belt - W.P. & Alt.; W/66 1/4" Belt O.C.	2479287	②♣9660HD			
Belt - W.P. & Alt.; W/67 1/4" Belt O.C.	2483914	②♣9670HD			
Belt - P.S.; W/39 3/4" Belt O.C.	2477462	♣9395HD			
Belt - P.S.; W/40 3/4" Belt O.C.	3887674	♣9405HD			
Belt - Air Brake Compr.		♣9660HD			

♣Standard Belt Available.
 ◆PowerBand Belt May Work, Use Template to Check.

②Two Required.
 ≈Cut to Fit.

Belts and Coolant Hose for School Buses

School Buses

Application	Mfr. Part No.	Our No.	Application	Mfr. Part No.	Our No.
Chevrolet - Continued			Chevrolet - Continued		
1966 - Continued			1964 - Continued		
GM V-8 283 - Continued			GM V-8 348 - Continued		
S50; SE50 - Continued			S60 B6P Series - Continued		
Belt - Fan & Alt.; 2nd Design	3888480	②♠9560HD	Hose - Upper; W/O Rad. Shutters		20420
				or	26511
			Hose - Lower		26536
GM V-8 327			Hose - By Pass - Left Side		20567
S50; SE50			Hose - By Pass - Right Side		20568
Belt - Fan & Alt.; 1st Design	3887684	②♠♠9550HD			
Belt - Fan & Alt.; 2nd Design	3888480	②♠9560HD			
1965			GM V-8 409		
GM 6-Cyl. 292			S60 B6P Series		
SS50			Belt - Fan & Alt.; W/Std. Alt.		②♠9625HD
Hose - Upper; W/Auto. Trans.		≈<21660	Belt - Fan & Alt.; W/62A. Alt.		②♠♠9610HD
	or	25474	Belt - Fan, Alt. & P.S.		②♠9680HD
Hose - Upper; W/Man. Trans.		25530	Hose - Upper; W/Rad. Shutters		≈<20685
Hose - Lower		20584	Hose - Upper; W/O Rad. Shutters		20420
	or	26612		or	26511
Hose - By Pass		20563	Hose - Lower		26536
Hose - Heater Inlet		28442	Hose - By Pass - Left Side		20567
Hose - Heater Outlet		28441	Hose - By Pass - Right Side		20568
GM V-8 283			1963		
S50; SE50			GM V-8 283		
Belt - Fan & Alt.	3826586	②♠♠9550HD	S50; SE50		
GM V-8 327			Belt - Fan & Alt.		
S50; SE50			3826586		②♠♠9550HD
Belt - Fan & Alt.	3826586	②♠♠9550HD	GM V-8 327		
GM V-8 348			S50; SE50		
S60 B6P Series			Belt - Fan & Alt.		
Belt - Fan & Alt.; W/Std. Alt.		②♠9625HD	3826586		②♠♠9550HD
Belt - Fan & Alt.; W/62A. Alt.		②♠♠9610HD	GM V-8 348		
Belt - Fan, Alt. & P.S.		②♠9680HD	S60 B6P Series		
Hose - Upper; W/Rad. Shutters		≈<20685	Hose - Upper; W/Rad. Shutters		
Hose - Upper; W/O Rad. Shutters		20420	Hose - Upper; W/O Rad. Shutters		
	or	26511			≈<20685
Hose - Lower		26536			20420
Hose - By Pass - Left Side		20567			26511
Hose - By Pass - Right Side		20568			26536
GM V-8 409					20567
S60 B6P Series					20568
Belt - Fan & Alt.; W/Std. Alt.		②♠9625HD	GM V-8 409		
Belt - Fan & Alt.; W/62A. Alt.		②♠♠9610HD	S60 B6P Series		
Belt - Fan, Alt. & P.S.		②♠9680HD	Hose - Upper; W/Rad. Shutters		
Hose - Upper; W/Rad. Shutters		≈<20685	Hose - Upper; W/O Rad. Shutters		
Hose - Upper; W/O Rad. Shutters		20420			≈<20685
	or	26511			20420
Hose - Lower		26536			26511
Hose - By Pass - Left Side		20567			26536
Hose - By Pass - Right Side		20568			20567
1964					20568
GM V-8 283			1962		
S50; SE50			GM 6-Cyl. 235		
Belt - Fan & Alt.	3826586	②♠♠9550HD	S60 B6P Series		
GM V-8 327			Belt - Fan & Alt.; W/P.S.		
S50; SE50			Belt - Fan & Alt.; W/O P.S.		
Belt - Fan & Alt.	3826586	②♠♠9550HD	Belt - Fan & Gen.; W/O Air Brake Compr. ...		
GM V-8 348			Belt - Fan & Gen.; W/Air Brakes		
S60 B6P Series			Belt - Fan, Gen. & Air Brake Compr.;		
Belt - Fan & Alt.; W/Std. Alt.		②♠9625HD	W/16,000 Lb. Axle		
Belt - Fan & Alt.; W/62A. Alt.		②♠♠9610HD	Belt - P.S.		
Belt - Fan, Alt. & P.S.		②♠9680HD	Belt - Air Brake Compr.		
Hose - Upper; W/Rad. Shutters		≈<20685	Hose - Upper; W/Man. Trans.		
Hose - Upper; W/O Rad. Shutters		20420			≈<21660
	or	26511			25474
Hose - Lower		26536			20417
Hose - By Pass - Left Side		20567			26612
Hose - By Pass - Right Side		20568	GM 6-Cyl. 261		
1964			S60 B6P Series		
GM V-8 283			Belt - Fan & Alt.; W/P.S.		
S50; SE50			Belt - Fan & Alt.; W/O P.S.		
Belt - Fan & Alt.	3826586	②♠♠9550HD	Belt - Fan & Gen.; W/O Air Brake Compr. ...		
GM V-8 327			3759223		
S50; SE50			3759218		
Belt - Fan & Alt.	3826586	②♠♠9550HD	3759204		
GM V-8 348			3759207		
S60 B6P Series			3761883		
Belt - Fan & Alt.; W/Std. Alt.		②♠9625HD	3771316		
Belt - Fan & Alt.; W/62A. Alt.		②♠♠9610HD	3764984		
Belt - Fan, Alt. & P.S.		②♠9680HD			
Hose - Upper; W/Rad. Shutters		≈<20685			
Hose - Upper; W/O Rad. Shutters		20420			
	or	26511			
Hose - Lower		26536			
Hose - By Pass - Left Side		20567			
Hose - By Pass - Right Side		20568			

♠Standard Belt Available.
②Two Required.

♠PowerBand Belt May Work, Use Template to Check.
≈<Cut to Fit.

Belts and Coolant Hose for School Buses

Application	Mfr. Part No.	Our No.	Application	Mfr. Part No.	Our No.
Chevrolet - Continued			Chevrolet - Continued		
1962 - Continued			1961 - 1960 - Continued		
GM 6-Cyl. 261 - Continued			GM V-8 283		
S60 B6P Series - Continued			S50; SE50		
Belt - Fan & Gen.; W/Air Brakes	3759207	▲9463HD	Belt - Fan & Gen.	3764145	▲9580HD
Belt - Fan, Gen. & Air Brake Compr.; W/16,000 Lb. Axle	3761883	▲9650HD	GM V-8 327		
Belt - P.S.	3771316	▲9600HD	S50; SE50		
Belt - Air Brake Compr.	3764984	▲9625HD	Belt - Fan & Gen.	3764145	▲9580HD
Hose - Upper; W/Man. Trans.		≈<21660	GM V-8 348		
		or 25474	S60 B6P Series		
Hose - Lower; W/Man. Trans.		20417	Belt - Fan & Gen.; W/P.S.		▲9630HD
		or 26612	Belt - Fan & Gen.; W/O P.S.		②▲9640HD
			Belt - Fan & P.S.		▲9600HD
			Hose - Upper; W/Rad. Shutters		≈<20685
			Hose - Upper; W/O Rad. Shutters		20420
					or 26511
			Hose - Lower		26536
			Hose - By Pass - Left Side		20567
			Hose - By Pass - Right Side		20568
			S70		
			Belt - Fan & Gen.		②▲9630HD
			Belt - Air Brake Compr.		▲9660HD
			Hose - Upper; W/Rad. Shutters		≈<20685
			Hose - Upper; W/O Rad. Shutters		20420
					or 26511
			Hose - Lower		26536
			Hose - By Pass - Left Side		20567
			Hose - By Pass - Right Side		20568
			GM V-8 283		
S50; SE50			GM V-8 409		
Belt - Fan & Gen.	3764145	▲9580HD	S60 B6P Series		
GM V-8 327			Belt - Fan & Gen.; W/P.S.		
S50; SE50					
Belt - Fan & Gen.			3764145		
▲9580HD					
GM V-8 348			Belt - Fan & Gen.; W/O P.S.		
S60 B6P Series			Belt - Fan & P.S.		
Hose - Upper; W/Rad. Shutters			≈<20685		
Hose - Upper; W/O Rad. Shutters			20420		
			or 26511		
Hose - Lower			26536		
Hose - By Pass - Left Side			20567		
Hose - By Pass - Right Side			20568		
GM V-8 409			S70		
S60 B6P Series			Belt - Fan & Gen.		
Hose - Upper; W/Rad. Shutters			≈<20685		
Hose - Upper; W/O Rad. Shutters			20420		
			or 26511		
Hose - Lower			26536		
Hose - By Pass - Left Side			20567		
Hose - By Pass - Right Side			20568		
1961 - 1960			GM V-8 409		
GM 6-Cyl. 235			S60 B6P Series		
S60 B6P Series			Belt - Fan & Gen.; W/P.S.		
Belt - Fan & Alt.; W/P.S.			3759223		
Belt - Fan & Alt.; W/O P.S.			3759218		
Belt - Fan & Gen.; W/O Air Brake Compr.			3759204		
Belt - Fan & Gen.; W/Air Brakes			3759207		
Belt - Fan, Gen. & Air Brake Compr.; W/16,000 Lb. Axle			3761883		
Belt - P.S.			3771316		
Belt - Air Brake Compr.			3764984		
Hose - Upper; W/Man. Trans.			≈<21660		
			or 25474		
Hose - Lower; W/Man. Trans.			20417		
			or 26612		
GM 6-Cyl. 261			1959		
S60 B6P Series			GM 6-Cyl. 235		
Belt - Fan & Alt.; W/P.S.			4000 Series (School Bus)		
Belt - Fan & Alt.; W/O P.S.			Belt - Fan & Gen.; W/42 7/8" Belt O.C.		
Belt - Fan & Gen.; W/O Air Brake Compr.			3718614		
Belt - Fan & Gen.; W/Air Brakes			3759205		
Belt - Fan, Gen. & Air Brake Compr.; W/16,000 Lb. Axle			Hose - Upper; 2nd Design		
Belt - P.S.			20267		
Belt - Air Brake Compr.			Hose - Lower; 2nd Design		
Hose - Upper; W/Man. Trans.			≈<20584		
			6000 Series (School Bus)		
			Belt - Fan & Gen.; W/42 7/8" Belt O.C.		
			3718614		
			Belt - Fan & Gen.; W/46 3/8" Belt O.C.		
			3724316		
			Belt - Air Brake Compr.		
			3740516		
			Hose - Upper; 2nd Design		
			20267		
			Hose - Lower; 2nd Design		
			≈<20584		
			GM 6-Cyl. 261		
			4000 Series (School Bus)		
			Belt - Fan & Gen.; W/42 7/8" Belt O.C.		
			3718614		
			Belt - Fan & Gen.; W/44 3/8" Belt O.C.		
			3759205		
			▲9425HD		
			▲9440HD		
			20267		
			≈<20584		
			▲9425HD		
			▲9463HD		
			▲9610HD		
			20267		
			≈<20584		
			▲9425HD		
			▲9440HD		

▲Standard Belt Available.
◆PowerBand Belt May Work, Use Template to Check.

≈<Cut to Fit.
②Two Required.

Belts and Coolant Hose for School Buses

School Buses

Application	Mfr. Part No.	Our No.	Application	Mfr. Part No.	Our No.
Chevrolet - Continued			Chevrolet - Continued		
1959 - Continued			1958 - Continued		
GM 6-Cyl. 261 - Continued			GM 6-Cyl. 261 - Continued		
4000 Series (School Bus) - Continued			4000 Series (School Bus) - Continued		
Hose - Upper; 2nd Design		20267	Belt - Fan & Gen.; W/44 3/8" Belt O.C.	3759205	♣9440HD
Hose - Lower; 2nd Design		≈<20584	Hose - Upper; 2nd Design		20267
6000 Series (School Bus)			6000 Series (School Bus)		
Belt - Fan & Gen.; W/42 7/8" Belt O.C.	3718614	♣9425HD	Hose - Lower; 2nd Design		≈<20584
Belt - Fan & Gen.; W/46 3/8" Belt O.C.	3724316	♣9463HD	6000 Series (School Bus)		
Belt - Air Brake Compr.	3740516	♣9610HD	Belt - Fan & Gen.; W/42 7/8" Belt O.C.	3718614	♣9425HD
Hose - Upper; 2nd Design		20267	Belt - Fan & Gen.; W/46 3/8" Belt O.C.	3724316	♣9463HD
Hose - Lower; 2nd Design		≈<20584	Belt - Air Brake Compr.	3740516	♣9610HD
GM V-8 265			GM V-8 265		
4000 Series (School Bus)			4000 Series (School Bus)		
Belt - Fan & Gen.	3718616	♣9570HD	Belt - Fan & Gen.	3718616	♣9570HD
Belt - Air Brake Compr.	3728664	♣9680HD	Belt - Air Brake Compr.	3728664	♣9680HD
GM V-8 283			GM V-8 283		
4000 Series (School Bus)			4000 Series (School Bus)		
Belt - Fan & Gen.	3718616	♣9570HD	Belt - Fan & Gen.	3718616	♣9570HD
Belt - Air Brake Compr.		♣9680HD	Belt - Air Brake Compr.		♣9680HD
Hose - Upper		≈<20416	Hose - Upper		≈<20416
		or			or
Hose - Lower; W/Man. Trans.		≈<20046	Hose - Lower; W/Man. Trans.		≈<20046
		or			or
		26611			26611
6000 Series (School Bus)			6000 Series (School Bus)		
Belt - Fan & Gen.	3732450	Ⓣ7570	Belt - Fan & Gen.	3732450	Ⓣ7570
Belt - Air Brake Compr.	3759229	♣9630HD	Belt - Air Brake Compr.	3759229	♣9630HD
Hose - Upper		≈<21794			
		or			or
		25478			25478
Hose - Lower		26611			26611
GM V-8 322			GM V-8 322		
10000 Series (School Bus)			10000 Series (School Bus)		
Belt - Fan & Gen.		Ⓣ7575	Belt - Fan & Gen.		Ⓣ7575
Belt - Air Brake Compr.		♣9640HD	Belt - Air Brake Compr.		♣9640HD
			Hose - Upper		25476
			Hose - Lower		25478
GM V-8 327			GM V-8 327		
4000 Series (School Bus)			4000 Series (School Bus)		
Belt - Fan & Gen.	3718616	♣9570HD	Belt - Fan & Gen.	3718616	♣9570HD
Belt - Air Brake Compr.		♣9680HD	Belt - Air Brake Compr.		♣9680HD
Hose - Upper		≈<20416	Hose - Upper		≈<20416
		or			or
		25478			25478
Hose - Lower; W/Man. Trans.		≈<20046	Hose - Lower; W/Man. Trans.		≈<20046
		or			or
		26611			26611
6000 Series (School Bus)			6000 Series (School Bus)		
Belt - Fan & Gen.	3732450	Ⓣ7570	Belt - Fan & Gen.	3732450	Ⓣ7570
Belt - Air Brake Compr.	3759229	♣9630HD	Belt - Air Brake Compr.	3759229	♣9630HD
Hose - Upper		≈<21794			
		or			or
		25478			25478
Hose - Lower		26611			26611
1958			1957		
GM 6-Cyl. 235			GM 6-Cyl. 235		
4000 Series (School Bus)			4000 Series (School Bus)		
Belt - Fan & Gen.; W/42 7/8" Belt O.C.	3718614	♣9425HD	Belt - Fan & Gen.; W/41 3/8" Belt O.C.	3727510	♣9412HD
Belt - Fan & Gen.; W/44 3/8" Belt O.C.	3759205	♣9440HD	Belt - Fan & Gen.; W/42 7/8" Belt O.C.	3718614	♣9425HD
Hose - Upper; 2nd Design		20267	Hose - Upper; 2nd Design		20267
Hose - Lower; 2nd Design		≈<20584	Hose - Lower; 2nd Design		≈<20584
6000 Series (School Bus)			6000 Series (School Bus)		
Belt - Fan & Gen.; W/42 7/8" Belt O.C.	3718614	♣9425HD	Belt - Fan & Gen.; W/42 7/8" Belt O.C.	3718614	♣9425HD
Belt - Fan & Gen.; W/46 3/8" Belt O.C.	3724316	♣9463HD	Belt - Fan & Gen.; W/46 3/8" Belt O.C.	3724316	♣9463HD
Belt - Air Brake Compr.	3740516	♣9610HD	Belt - Air Brake Compr.	3740516	♣9610HD
Hose - Upper; 2nd Design		20267	Hose - Upper; 2nd Design		20267
Hose - Lower; 2nd Design		≈<20584	Hose - Lower; 2nd Design		≈<20584
GM 6-Cyl. 261			GM 6-Cyl. 261		
4000 Series (School Bus)			4000 Series (School Bus)		
Belt - Fan & Gen.; W/42 7/8" Belt O.C.	3718614	♣9425HD	Belt - Fan & Gen.; W/41 3/8" Belt O.C.	3727510	♣9412HD
			Belt - Fan & Gen.; W/42 7/8" Belt O.C.	3718614	♣9425HD
			Hose - Upper; 2nd Design		20267
			Hose - Lower; 2nd Design		≈<20584

≈<Cut to Fit.
ⓉTwo Required.

♣Standard Belt Available.

Belts and Coolant Hose for School Buses

Application	Mfr. Part No.	Our No.	Application	Mfr. Part No.	Our No.
Chevrolet - Continued			Chevrolet - Continued		
1957 - Continued			1956 - Continued		
GM 6-Cyl. 261 - Continued			GM V-8 265 - Continued		
6000 Series (School Bus)			4000 Series (School Bus) - Continued		
Belt - Fan & Gen.; W/42 7/8" Belt O.C.	3718614	♣9425HD	Belt - Air Brake Compr.	3728664	♣9680HD
Belt - Fan & Gen.; W/46 3/8" Belt O.C.	3724316	♣9463HD	Hose - Upper		≈<20416
Belt - Air Brake Compr.	3740516	♣9610HD		or	25477
Hose - Upper; 2nd Design		20267	Hose - Lower		≈<20475
Hose - Lower; 2nd Design		≈<20584		or	26501
GM V-8 265			GM V-8 283		
4000 Series (School Bus)			4000 Series (School Bus)		
Belt - Fan & Gen.	3718616	♣9570HD	Belt - Fan & Gen.	3718616	♣9570HD
Belt - Air Brake Compr.	3728664	♣9680HD	Belt - Air Brake Compr.		♣9680HD
Hose - Upper		≈<20416			
	or	25477			
Hose - Lower		≈<20475			
	or	26501			
GM V-8 283			GM V-8 322		
4000 Series (School Bus)			10000 Series (School Bus)		
Belt - Fan & Gen.	3718616	♣9570HD	Hose - Upper		25476
Belt - Air Brake Compr.		♣9680HD	Hose - Lower		25478
6000 Series (School Bus)			GM V-8 327		
Belt - Fan & Gen.	3732450	②7570	4000 Series (School Bus)		
Belt - Air Brake Compr.	3759229	♣9630HD	Belt - Fan & Gen.	3718616	♣9570HD
GM V-8 322			Belt - Air Brake Compr.		♣9680HD
10000 Series (School Bus)					
Hose - Upper		25476			
Hose - Lower		25478			
GM V-8 327			1955		
4000 Series (School Bus)			GM 6-Cyl. 235		
Belt - Fan & Gen.	3718616	♣9570HD	4000 Series (School Bus); 6000 Series (School Bus)		
Belt - Air Brake Compr.		♣9680HD	Hose - Upper; 2nd Design		20267
6000 Series (School Bus)			Hose - Lower; 2nd Design		≈<20584
Belt - Fan & Gen.	3732450	②7570	GM 6-Cyl. 261		
Belt - Air Brake Compr.	3759229	♣9630HD	4000 Series (School Bus); 6000 Series (School Bus)		
1956			Hose - Upper; 2nd Design		20267
GM 6-Cyl. 235			Hose - Lower; 2nd Design		≈<20584
4000 Series (School Bus)			GM V-8 265		
Belt - Fan & Gen.; W/41 3/8" Belt O.C.	3727510	♣9412HD	4000 Series (School Bus)		
Belt - Fan & Gen.; W/42 7/8" Belt O.C.	3718614	♣9425HD	Belt - Fan & Gen.	3718616	♣9570HD
Hose - Upper; 2nd Design		20267	Belt - Air Brake Compr.	3728664	♣9680HD
Hose - Lower; 2nd Design		≈<20584	Hose - Upper		≈<20416
6000 Series (School Bus)				or	25477
Belt - Fan & Gen.; W/42 7/8" Belt O.C.	3718614	♣9425HD	Hose - Lower		≈<20475
Belt - Fan & Gen.; W/46 3/8" Belt O.C.	3724316	♣9463HD		or	26501
Belt - Air Brake Compr.	3740516	♣9610HD	GM V-8 283		
Hose - Upper; 2nd Design		20267	4000 Series (School Bus)		
Hose - Lower; 2nd Design		≈<20584	Belt - Fan & Gen.	3718616	♣9570HD
GM 6-Cyl. 261			Belt - Air Brake Compr.		♣9680HD
4000 Series (School Bus)					
Belt - Fan & Gen.; W/41 3/8" Belt O.C.	3727510	♣9412HD	GM V-8 327		
Belt - Fan & Gen.; W/42 7/8" Belt O.C.	3718614	♣9425HD	4000 Series (School Bus)		
Hose - Upper; 2nd Design		20267	Belt - Fan & Gen.	3718616	♣9570HD
Hose - Lower; 2nd Design		≈<20584	Belt - Air Brake Compr.		♣9680HD
6000 Series (School Bus)					
Belt - Fan & Gen.; W/42 7/8" Belt O.C.	3718614	♣9425HD	Collins		
Belt - Fan & Gen.; W/46 3/8" Belt O.C.	3724316	♣9463HD	2005		
Belt - Air Brake Compr.	3740516	♣9610HD	GM V-8 4.8 L		
Hose - Upper; 2nd Design		20267	Bantam		
Hose - Lower; 2nd Design		≈<20584	Belt - Accessory Belt Drive Kit - Alt. & W.P.		
GM V-8 265			Belt - Alt. & W.P.		
4000 Series (School Bus)			Tensioner Assy. - Alt. & W.P.		
Belt - Fan & Gen.	3718616	♣9570HD	12576451		
			12580162		
			38158		
1957 - Continued			2002		
GM 6-Cyl. 261			Ford V-8 7.3 L Diesel		
4000 Series (School Bus)			Grand Bantam		
Belt - Fan & Gen.; W/41 3/8" Belt O.C.	3727510	♣9412HD	Belt - Serpentine		
Belt - Fan & Gen.; W/42 7/8" Belt O.C.	3718614	♣9425HD	1C2E 8620 JA		
Hose - Upper; 2nd Design		20267	♣K081223HD		
Hose - Lower; 2nd Design		≈<20584			
6000 Series (School Bus)					
Belt - Fan & Gen.; W/42 7/8" Belt O.C.	3718614	♣9425HD			
Belt - Fan & Gen.; W/46 3/8" Belt O.C.	3724316	♣9463HD			
Belt - Air Brake Compr.	3740516	♣9610HD			
Hose - Upper; 2nd Design		20267			
Hose - Lower; 2nd Design		≈<20584			
GM V-8 265					
4000 Series (School Bus)					
Belt - Fan & Gen.	3718616	♣9570HD			

♣Standard Belt Available.
②Two Required.

≈<Cut to Fit.

School Buses

Belts and Coolant Hose for School Buses

School Buses

Application	Mfr. Part No.	Our No.	Application	Mfr. Part No.	Our No.
Collins - Continued			Crown Coach - Continued		
2002 - Continued			1996 - 1992 - Continued		
GM V-8 5.7 L			Cummins B Series 5.9 L Diesel		
Bantam			Counselor FE		
Belt - Accessory Belt Drive Kit		ACK060960HD	Belt - Serpentine	3921753	♣K080550HD
Belt - Serpentine	12564763	♣K060960HD	Hose - Upper		②24228
Tensioner Assy.	12561094	38103	Hose - Lower - Eng. To Pipe		24228
Tensioner Pulley		38008	Hose - Lower - Pipe To Rad.		24232
Hose - Upper - Eng. To Rad.		22357	1991		
1998 - 1997			Cummins B Series 3.9 L Diesel		
Ford V-8 7.3 L Diesel			Counselor FE		
Grand Bantam			Belt - Serpentine	3921753	♣K080550HD
Belt - Serpentine; W/Ambulance Prep. Pkg.		♣K081196HD	Hose - Upper		②24228
Belt - Serpentine; W/O Ambulance Prep. Pkg.		♣K081177HD	Hose - Lower - Eng. To Pipe		24228
Hose - Upper		23308	Hose - Lower - Pipe To Rad.		24232
Hose - Lower		22319	Cummins B Series 5.9 L Diesel		
Corbeil			Counselor FE		
2003			Belt - Serpentine	3921753	♣K080550HD
Ford V-8 7.3 L Diesel			Hose - Upper		②24228
Corbeil Ford			Hose - Lower - Eng. To Pipe		24228
Belt - Accessory Belt Drive Kit; W/O Ambulance Prep. Pkg.; W/Single Alt.; W/122.2" Belt O.C.		ACK081223HD	Hose - Lower - Pipe To Rad.		24232
Belt - Accessory Belt Drive Kit; W/Ambulance Prep. Pkg.; W/Dual Alts.		ACK081377HD	Detroit Diesel 6-71 Diesel		
Belt - Serpentine; W/O Ambulance Prep. Pkg.; W/Single Alt.; W/122.2" Belt O.C. . 1C2Z 8620 LA		♣K081223HD	A426-10; A426-11		
Belt - Serpentine; W/121.3" Belt O.C. 1C2Z 8620 NA		♣K081213HD	Belt - Fan		②AX85
Belt - Serpentine; W/Ambulance Prep. Pkg.; W/Dual Alts. F8TZ 8620 GC		♣K081377HD	Belt - Alt.		②♣♣9500HD
Belt - Accessory Belt Drive Kit; W/121.3" Belt O.C.		ACK081213HD	1990 - 1985		
Tensioner Assy. F8TZ 6B209 BA		38191	Detroit Diesel 6-71 Diesel		
Tensioner Pulley - Smooth		38023	A426-10; A426-11		
GM V-8 6.5 L Diesel			Belt - Fan		②AX85
Corbeil GM/Chevrolet			Belt - Alt.		②♣♣9500HD
Belt - Accessory Belt Drive Kit; W/O A.C.; W/145A. Alt.		ACK061020HD	1984 - 1979		
Belt - Serpentine; W/O A.C.; W/145A. Alt. ... 12556338		♣K061020HD	Detroit Diesel 6-71 Diesel		
Tensioner Assy. 12561092		38118	A426-10; A426-11		
Idler Pulley - Grooved; W/O A.C. 14102597		36177	Belt - Fan		②AX85
Tensioner Pulley		38006	Belt - Alt.		②♣♣9500HD
Crown Coach			International/Navistar RD450 Diesel		
1999 - 1997			R450		
Cummins B Series 3.9 L Diesel			Belt - Fan		TR30543
Counselor FE			Belt - W.P. & Gen.		②TR24562
Belt - Serpentine	3921753	♣K080550HD	Belt - Air Brake Compr.		TR32571
Hose - Upper		②24228	1978 - 1975		
Hose - Lower - Eng. To Pipe		24228	Cummins NH220 Diesel		
Hose - Lower - Pipe To Rad.		24232	A743-31; A743T-11		
Cummins ISB Diesel			Belt - Fan		C78
Counselor FE			Belt - W.P.		TR22363
Belt - Serpentine	3921753	♣K080550HD	Belt - P.S.		TR28376
Hose - Upper		②24228	Cummins NHHB Diesel		
Hose - Lower - Eng. To Pipe		24228	AD743-11		
Hose - Lower - Pipe To Rad.		24232	Belt - Fan		C78
1996 - 1992			Belt - W.P.	69585	7470
Cummins B Series 3.9 L Diesel			Belt - Gen. & Air Brake Compr.		②TR28616
Counselor FE			Cummins NHHTC Diesel		
Belt - Serpentine	3921753	♣K080550HD	2A855T-11; A855T-11		
Hose - Upper		②24228	Belt - W.P.		②6596
Hose - Lower - Eng. To Pipe		24228	Belt - Alt.		②♣9480HD
Hose - Lower - Pipe To Rad.		24232	Detroit Diesel 6-71 Diesel		
Cummins B Series 3.9 L Diesel			A426-10; A426-11		
Counselor FE			Belt - Fan		②AX85
Belt - Serpentine	3921753	♣K080550HD	Belt - Alt.		②♣♣9500HD
Hose - Upper		②24228			
Hose - Lower - Eng. To Pipe		24228			
Hose - Lower - Pipe To Rad.		24232			

♣Standard Belt Available.
 ◆PowerBand Belt May Work, Use Template to Check.

②Two Required.

Belts and Coolant Hose for School Buses

Application	Mfr. Part No.	Our No.	Application	Mfr. Part No.	Our No.
Crown Coach - Continued			Crown Coach - Continued		
1978 - 1975 - Continued			1960 - 1951 - Continued		
International/Navistar RD450 Diesel			International/Navistar RD501 Diesel		
R450			A501-10; A501-11		
Belt - Fan		TR30543	Belt - W.P. & Gen.		②TR22508
Belt - W.P. & Gen.		②TR24562	Belt - P.S.		TR28376
Belt - Air Brake Compr.		TR32571	1950		
1974 - 1973			Detroit Diesel 6V-71 Diesel		
Cummins NH220 Diesel			RD6V71-11		
A743-31; A743T-11			Belt - Gen.; W/41 3/4" Belt O.C.		
Belt - Fan		C78	♣9415HD		
Belt - W.P.		TR22363	Belt - Gen.; W/42 3/4" Belt O.C.		
Belt - P.S.		TR28376	♣9425HD		
Cummins NHHB Diesel			Detroit Diesel 8V-71 Diesel		
AD743-11			RD8V71-11		
Belt - Fan		C78	Belt - Gen.; W/41 3/4" Belt O.C.		
Belt - W.P.	69585	7470	♣9415HD		
Belt - Gen. & Air Brake Compr.		②TR28616	Belt - Gen.; W/42 3/4" Belt O.C.		
Cummins NHHTC Diesel			Hall Scott 190 Diesel		
2A855T-11; A855T-11			A190-11		
Belt - W.P.		②6596	Belt - W.P. & Gen.		
Belt - Alt.		②♣9480HD	②TR22517		
Detroit Diesel 6-71 Diesel			Belt - Gen.; W/Reverse Gen.		
A426-10; A426-11			②BX54		
Belt - Fan		②AX85	Belt - Air Brake Compr.		
Belt - Alt.		②♣9500HD	TR28429		
1972 - 1966			Hall Scott 504 Diesel		
Cummins NH220 Diesel			A504-11		
A743-31; A743T-11			Belt - W.P. & Gen.		
Belt - Fan		C78	②TR22517		
Belt - W.P.		TR22363	Belt - Gen.; W/Reverse Gen.		
Belt - P.S.		TR28376	②BX54		
Cummins NHHB Diesel			Belt - Air Brake Compr.		
AD743-11			TR28429		
Belt - Fan		C78	Hall Scott 590 Diesel		
Belt - W.P.	69585	7470	A590-10		
Belt - Gen. & Air Brake Compr.		②TR28616	Belt - Alt. & Air Brake Compr.		
Cummins NHHTC Diesel			②TR28514		
2A855T-11; A855T-11			Belt - P.S.		
Belt - W.P.		②6596	TR28666		
Belt - Alt.		②♣9480HD	International/Navistar RD450 Diesel		
1960 - 1951			A450-11		
Detroit Diesel 6V-71 Diesel			Belt - W.P. & Gen.		
RD6V71-11			②TR22508		
Belt - Gen.; W/41 3/4" Belt O.C.		♣9415HD	Belt - P.S.		
Belt - Gen.; W/42 3/4" Belt O.C.		♣9425HD	TR28376		
Detroit Diesel 8V-71 Diesel			A450C		
RD8V71-11			Belt - Fan		
Belt - Gen.; W/41 3/4" Belt O.C.		♣9415HD	TR28616		
Belt - Gen.; W/42 3/4" Belt O.C.		♣9425HD	Belt - W.P. & Gen.		
International/Navistar RD450 Diesel			②TR22517		
A450-11			Belt - Air Brake Compr.		
Belt - W.P. & Gen.		②TR22508	TR30448		
Belt - P.S.		TR28376	International/Navistar RD501 Diesel		
A450C			A501-10; A501-11		
Belt - Fan		TR28616	Belt - W.P. & Gen.		
Belt - W.P. & Gen.		②TR22517	②TR22508		
Belt - Air Brake Compr.		TR30448	Belt - P.S.		
1960 - 1951			TR28376		
Detroit Diesel 6V-71 Diesel			Dodge		
RD6V71-11			1977 - 1976		
Belt - Gen.; W/41 3/4" Belt O.C.		♣9415HD	Dodge V-8 318		
Belt - Gen.; W/42 3/4" Belt O.C.		♣9425HD	S600		
Detroit Diesel 8V-71 Diesel			Belt - Fan & Alt.; W/Cast Iron W.P.		
RD8V71-11			2846941		
Belt - Gen.; W/41 3/4" Belt O.C.		♣9415HD	②♣9470HD		
Belt - Gen.; W/42 3/4" Belt O.C.		♣9425HD	②7480		
International/Navistar RD450 Diesel			Belt - Fan & Alt.; W/Aluminum W.P.		
A450-11			3671524		
Belt - W.P. & Gen.		②TR22508	Belt - Fan & Alt.; W/105A. Alt.		
Belt - P.S.		TR28376	3462082		
A450C			Belt - Fan & P.S.; W/Cast Iron W.P.		
Belt - Fan		TR28616	3641756		
Belt - W.P. & Gen.		②TR22517	Belt - Fan & P.S.; W/Aluminum W.P.		
Belt - Air Brake Compr.		TR30448	2951893		
1960 - 1951			Belt - P.S.		
Detroit Diesel 6V-71 Diesel			2268386		
RD6V71-11			Belt - Air Brake Compr.		
Belt - Gen.; W/41 3/4" Belt O.C.		♣9415HD	3736858		
Belt - Gen.; W/42 3/4" Belt O.C.		♣9425HD	Belt - A.P.		
Detroit Diesel 8V-71 Diesel			4037161		
RD8V71-11			Hose - Upper; W/Std. Cool.		
Belt - Gen.; W/41 3/4" Belt O.C.		♣9415HD	21113		
Belt - Gen.; W/42 3/4" Belt O.C.		♣9425HD	or		
International/Navistar RD450 Diesel			25484		
A450-11			25482		
Belt - W.P. & Gen.		②TR22508	Hose - Upper; W/X.C.		
Belt - P.S.		TR28376	Hose - Lower; W/Std. Cool.		
A450C			20974		
Belt - Fan		TR28616	Hose - Lower; W/X.C.		
Belt - W.P. & Gen.		②TR22517	20559		
Belt - Air Brake Compr.		TR30448	or		
1960 - 1951			25528		
Detroit Diesel 6V-71 Diesel			20693		
RD6V71-11					
Belt - Gen.; W/41 3/4" Belt O.C.		♣9415HD			
Belt - Gen.; W/42 3/4" Belt O.C.		♣9425HD			
Detroit Diesel 8V-71 Diesel					
RD8V71-11					
Belt - Gen.; W/41 3/4" Belt O.C.		♣9415HD			
Belt - Gen.; W/42 3/4" Belt O.C.		♣9425HD			
International/Navistar RD450 Diesel					
A450-11					
Belt - W.P. & Gen.		②TR22508			
Belt - P.S.		TR28376			
A450C					
Belt - Fan		TR28616			
Belt - W.P. & Gen.		②TR22517			
Belt - Air Brake Compr.		TR30448			

②Two Required.

♣PowerBand Belt May Work, Use Template to Check.

♣Standard Belt Available.

School Buses

Belts and Coolant Hose for School Buses

School Buses

Application	Mfr. Part No.	Our No.	Application	Mfr. Part No.	Our No.
Dodge - Continued			Dodge - Continued		
1977 - 1976 - Continued			1975 - Continued		
Dodge V-8 360			Dodge V-8 413 - Continued		
S600; S700			S600; S700 - Continued		
Belt - Fan & Alt.	②◆◆9470HD		Hose - Upper	③<20611	
Belt - P.S.	◆9463HD		or	26509	
Hose - Lower	20559		Hose - Lower	26531	
or	25528				
Hose - By Pass	20693		Perkins 6-Cyl. 354 Diesel		
Dodge V-8 361			S600		
S600; S700			Belt - Fan & Alt.	3634904	◆9540HD
Belt - Fan & Alt.	②◆◆9650HD		Belt - P.S.	3641909	◆9660HD
Belt - P.S.	◆9412HD		1974		
Belt - Air Brake Compr.	◆9755HD		Dodge V-8 318		
Hose - Upper	③<20611		S600		
or	26509		Belt - Fan & Alt.; W/Cast Iron W.P.	2846941	②◆◆9470HD
Hose - Lower	26531		Belt - Fan & Alt.; W/Aluminum W.P.	3671524	②7480
Dodge V-8 413			Belt - Fan & Alt.; W/105A. Alt.	3462082	②◆◆9570HD
S600; S700			Belt - Fan & P.S.	3733345	◆9470HD
Belt - Fan & Alt.	②◆◆9650HD		Belt - Air Brake Compr.	2946719	◆9740HD
Belt - P.S.	◆9412HD		Hose - Upper; W/Std. Cool.		25484
Belt - Air Brake Compr.	◆9755HD		Hose - Lower; W/Std. Cool.		20974
Hose - Upper	③<20611		or	26501	
or	26509		Hose - Lower; W/H.D. W.P.		20931
Hose - Lower	26531		or	25530	
Perkins 6-Cyl. 354 Diesel			Hose - By Pass		20693
S600			Dodge V-8 360		
Belt - Fan & Alt.	3634904	◆9540HD	S600		
Belt - P.S.	3641909	◆9660HD	Belt - Fan & Alt.		②◆◆9470HD
1975			Belt - P.S.		◆9463HD
Dodge V-8 318			Hose - Lower		20559
S600			or	25528	
Belt - Fan & Alt.; W/Cast Iron W.P.	2846941	②◆◆9470HD	Hose - By Pass		20693
Belt - Fan & Alt.; W/Aluminum W.P.	3671524	②7480	Dodge V-8 361		
Belt - Fan & Alt.; W/105A. Alt.	3462082	②◆◆9570HD	S600		
Belt - Fan & P.S.; W/Cast Iron W.P.	3638926	◆9463HD	Belt - Fan & Alt.		②◆◆9650HD
Belt - Fan & P.S.; W/Aluminum W.P.	2951893	7470	Belt - P.S.		◆9412HD
Belt - Air Brake Compr.	3736858	◆9680HD	Belt - Air Brake Compr.		◆9755HD
Hose - Upper; W/Std. Cool.		25484	Hose - Upper		③<20611
Hose - Lower; W/Std. Cool.		20974	or	26510	
or	26501		Hose - Lower		③<20760
Hose - Lower; W/H.D. W.P.		20931	or	26529	
or	25530		Dodge V-8 413		
Hose - By Pass	20693		S600		
Dodge V-8 360			Belt - Fan & Alt.		②◆◆9650HD
S700			Belt - P.S.		◆9412HD
Belt - Fan & Alt.	②◆◆9470HD		Belt - Air Brake Compr.		◆9755HD
Belt - P.S.	◆9463HD		Hose - Upper		③<20611
Hose - Lower	20559		or	26510	
or	25528		Hose - Lower		③<20760
Hose - By Pass	20693		or	26529	
Dodge V-8 361			Perkins 6-Cyl. 354 Diesel		
S600; S700			S600		
Belt - Fan & Alt.	②◆◆9650HD		Belt - Fan & Alt.	3634904	◆9540HD
Belt - P.S.	◆9412HD		Belt - P.S.	3641909	◆9660HD
Belt - Air Brake Compr.	◆9755HD		1973 - 1972		
Hose - Upper	③<20611		Dodge V-8 318		
or	26509		S600		
Hose - Lower	26531		Belt - Fan & Alt.; W/Cast Iron W.P.	2846941	②◆◆9470HD
Dodge V-8 413			Belt - Fan & Alt.; W/Aluminum W.P.	3671524	②7480
S600; S700			Belt - Fan & Alt.; W/105A. Alt.	3462082	②◆◆9570HD
Belt - Fan & Alt.	②◆◆9650HD		Belt - Fan & P.S.	3733345	◆9470HD
Belt - P.S.	◆9412HD		Belt - Air Brake Compr.	2946719	◆9740HD
Belt - Air Brake Compr.	◆9755HD		Hose - Upper; W/Std. Cool.		25480

◆Standard Belt Available.
②Two Required.

◆PowerBand Belt May Work, Use Template to Check.
③<Cut to Fit.

Belts and Coolant Hose for School Buses

Application	Mfr. Part No.	Our No.	Application	Mfr. Part No.	Our No.
Dodge - Continued			Dodge - Continued		
1973 - 1972 - Continued			1969		
Dodge V-8 318 - Continued			Dodge 6-Cyl. 225		
S600 - Continued			S500		
Hose - Upper; W/X.C.		≈20620	Belt - Fan & Alt.		7570
Hose - Lower		25528	Belt - P.S.		7390
Hose - By Pass		20693	Hose - Upper		≈21660
Dodge V-8 361				or	25474
S600			Hose - Lower		20229
Belt - Fan & Alt.	②◆◆9650HD			or	25482
Belt - P.S.	◆9412HD		Dodge V-8 318		
Belt - Air Brake Compr.	◆9755HD		S500; S600		
Hose - Upper	≈20611		Belt - Fan & Alt.; W/Cast Iron W.P.	2846941	②◆◆9470HD
	or	26510	Belt - Fan & Alt.; W/Aluminum W.P.	3671524	②7480
Hose - Lower	≈20760		Belt - Fan & Alt.; W/105A. Alt.	3462082	②◆◆9570HD
	or	26529	Belt - Fan & P.S.	2206417	◆9447HD
Dodge V-8 413			Hose - Upper		20620
S600			Hose - Lower		20559
Belt - Fan & Alt.	②◆◆9650HD			or	25527
Belt - P.S.	◆9412HD		Hose - By Pass		20693
Belt - Air Brake Compr.	◆9755HD		Dodge V-8 361		
Hose - Upper	≈20611		S500; S600		
	or	26510	Belt - Fan & Alt.		②◆◆9650HD
Hose - Lower	≈20760		Belt - P.S.		◆9412HD
	or	26529	Belt - Air Brake Compr.		◆9755HD
1971 - 1970			Hose - Upper		≈20611
Dodge 6-Cyl. 225				or	26510
S500			Hose - Lower		≈20760
Belt - Fan & Alt.		7570		or	26529
Belt - P.S.		7390	Dodge V-8 413		
Hose - Upper		≈21660	S500; S600		
	or	25474	Belt - Fan & Alt.		②◆◆9650HD
Hose - Lower		20229	Belt - P.S.		◆9412HD
	or	25482	Belt - Air Brake Compr.		◆9755HD
Dodge V-8 318			Hose - Upper		≈20611
S500; S600				or	26510
Belt - Fan & Alt.; W/Cast Iron W.P.	2846941	②◆◆9470HD	Hose - Lower		≈20760
Belt - Fan & Alt.; W/Aluminum W.P.	3671524	②7480		or	26529
Belt - Fan & Alt.; W/105A. Alt.	3462082	②◆◆9570HD	1968		
Belt - Fan & P.S.	2206417	◆9447HD	Dodge 6-Cyl. 225		
Hose - Upper; W/Std. Cool.		25480	S500		
Hose - Upper; W/X.C.		≈20620	Belt - Fan & Alt.		
Hose - Lower		25528	Belt - P.S.		
Hose - By Pass		20693	Hose - Upper		
Dodge V-8 361				or	25474
S500; S600			Hose - Lower		20229
Belt - Fan & Alt.	②◆◆9650HD			or	25482
Belt - P.S.	◆9412HD		Dodge V-8 318		
Belt - Air Brake Compr.	◆9755HD		S500; S550; S600		
Hose - Upper	≈20611		Belt - Fan & Alt.; W/Cast Iron W.P.	2846941	②◆◆9470HD
	or	26510	Belt - Fan & Alt.; W/Aluminum W.P.	3671524	②7480
Hose - Lower	≈20760		Belt - Fan & Alt.; W/105A. Alt.	3462082	②◆◆9570HD
	or	26529	Belt - Fan & P.S.	2206417	◆9447HD
Dodge V-8 413			Hose - Upper		20620
S500; S600			Hose - Lower		20559
Belt - Fan & Alt.	②◆◆9650HD			or	25527
Belt - P.S.	◆9412HD		Hose - By Pass		20693
Belt - Air Brake Compr.	◆9755HD		Dodge V-8 361		
Hose - Upper	≈20611		S500; S550; S600		
	or	26510	Belt - Fan & Alt.		②◆◆9660HD
Hose - Lower	≈20760		Belt - P.S.		◆9400HD
	or	26529	Hose - Upper		≈20611
				or	26509

◆Standard Belt Available.
②Two Required.

◆PowerBand Belt May Work, Use Template to Check.
≈Cut to Fit.

School Buses

Belts and Coolant Hose for School Buses

School Buses

Application	Mfr. Part No.	Our No.	Application	Mfr. Part No.	Our No.
Dodge - Continued			Dodge - Continued		
1968 - Continued			1966 - 1963 - Continued		
Dodge V-8 361 - Continued			Dodge V-8 318 - Continued		
S500; S550; S600 - Continued			S400; S500; S550; S600 - Continued		
Hose - Lower		21256	Belt - P.S.	2206417	◆9447HD
	or	26504	Hose - Upper		20452
Dodge V-8 413			Hose - Lower		
S500; S600				or	20559
Belt - Fan & Alt.	②◆◆9660HD				25527
Belt - P.S.	◆9400HD		Dodge V-8 361		
Hose - Upper	≈<20611		S500; S550; S600		
	or	26509	Belt - Fan & Alt.		
Hose - Lower		21256	Belt - P.S.		
	or	26504	Hose - Upper		
1967			Hose - Lower		
Dodge 6-Cyl. 225			or		
S500			21256		
Belt - Fan & Alt.		7570	26504		
Belt - P.S.		7360	Dodge V-8 413		
Hose - Upper		≈<21660	S500; S600		
	or	25474	Belt - Fan & Alt.		
Hose - Lower		20229	Belt - P.S.		
	or	25482	Hose - Upper		
Dodge V-8 318			Hose - Lower		
S400; S500; S550; S600			or		
Belt - Fan & Alt.	2202795	②◆◆9550HD	21256		
Belt - P.S.	2206417	◆9447HD	26504		
Hose - Upper		20620	Perkins 6-Cyl. 354 Diesel		
Hose - Lower		20559	S600		
	or	25527	Belt - Fan & Alt.; W/O P.S.		
Hose - By Pass		20693	◆9550HD		
Dodge V-8 361			1962		
S500; S550; S600			Dodge 6-Cyl. 225		
Belt - Fan & Alt.	②◆◆9660HD		S500		
Belt - P.S.	◆9400HD		Belt - Fan & Alt.		
Hose - Upper	≈<20611		Belt - P.S.		
	or	26509	21256		
Hose - Lower		21256	26504		
	or	26504	Dodge V-8 318		
Dodge V-8 413			S400; S500; S550; S600		
S500; S600			Belt - Fan & Alt.		
Belt - Fan & Alt.	②◆◆9660HD		2202795		
Belt - P.S.	◆9400HD		2206417		
Hose - Upper	≈<20611		◆9447HD		
	or	26509	20452		
Hose - Lower		21256	20559		
	or	26504	25527		
Perkins 6-Cyl. 354 Diesel			Dodge V-8 361		
S600			S500; S550; S600		
Belt - Fan & Alt.; W/O P.S.		◆9550HD	Belt - Fan & Alt.		
1966 - 1963			②◆◆9660HD		
Dodge 6-Cyl. 225			◆9400HD		
S500			≈<20611		
Belt - Fan & Alt.		7570	or		
Belt - P.S.		7360	26509		
Hose - Upper		≈<21660	21256		
	or	25474	26504		
Hose - Lower		20229	Perkins 6-Cyl. 354 Diesel		
	or	25482	S600		
Dodge V-8 318			Belt - Fan & Alt.; W/O P.S.		
S400; S500; S550; S600			◆9550HD		
Belt - Fan & Alt.	2202795	②◆◆9550HD			

◆Standard Belt Available.
②Two Required.

◆PowerBand Belt May Work, Use Template to Check.
≈<Cut to Fit.

Belts and Coolant Hose for School Buses

Application	Mfr. Part No.	Our No.	Application	Mfr. Part No.	Our No.
Dodge - Continued			Dodge - Continued		
1961			1960 - Continued		
Dodge 6-Cyl. 225			Dodge V-8 318 - Continued		
S500			S400; S500; S600 - Continued		
Belt - Fan & Alt.		7570	Belt - P.S.	1855867	▲9610HD
Belt - P.S.		7360	Belt - Air Brake Compr.	1947372	9765
Dodge V-8 318			Hose - Upper		25527
S400; S500; S600			Hose - Lower		≈20386
Belt - Fan & Alt.	2202795	②▲◆9550HD		or	25476
Belt - P.S.	2206417	▲9447HD	Hose - By Pass		≈20618
Hose - Upper		20452		or	28442
Hose - Lower		20559	Dodge V-8 361		
		or 25527	S500; S600		
Dodge V-8 361			Belt - Fan & Gen.		
S500; S600			Belt - P.S.		
Belt - Fan & Alt.		②▲◆9660HD	Belt - Air Brake Compr.		
Belt - P.S.		▲9400HD			
Hose - Upper		≈20611			
		or 26509	Dodge V-8 413		
Hose - Lower		21256	S500; S600		
		or 26504	Belt - Fan & Gen.		
Dodge V-8 413			Belt - P.S.		
S500; S600			Belt - Air Brake Compr.		
Belt - Fan & Alt.		②▲◆9660HD			
Belt - P.S.		▲9400HD			
Hose - Upper		≈20611			
		or 26509	1959		
Hose - Lower		21256	Dodge 6-Cyl. 251		
		or 26504	S400; S500; S600		
Perkins 6-Cyl. 354 Diesel			Belt - Fan & Gen.; W/50 5/8" Belt O.C.		
S600			Belt - Fan & Gen.; W/54 3/8" Belt O.C.		
Belt - Fan & Alt.; W/O P.S.		▲9550HD	Belt - Fan & Gen.; W/52" Belt O.C.		
1960			Belt - P.S.		
Dodge 6-Cyl. 251			Hose - Upper		
S400			Hose - Lower		
Belt - Fan & Gen.; W/50 5/8" Belt O.C.		TR24500	Hose - By Pass		
Belt - Fan & Gen.; W/54 3/8" Belt O.C.		TR24538			
Belt - Fan & Gen.; W/52" Belt O.C.		TR24515			
Belt - P.S.		▲9505HD			
Hose - Upper		26603			
Hose - Lower		25480			
Hose - By Pass		≈20568			
S500; S600			Dodge 6-Cyl. 265		
Belt - Fan & Gen.; W/50 5/8" Belt O.C.		TR24500	S400; S500; S600		
Belt - Fan & Gen.; W/54 3/8" Belt O.C.		TR24538	Belt - Fan & Gen.; W/50 5/8" Belt O.C.		
Belt - Fan & Gen.; W/52" Belt O.C.		TR24515	Belt - Fan & Gen.; W/54 3/8" Belt O.C.		
Belt - P.S.		▲9505HD	Belt - Fan & Gen.; W/52" Belt O.C.		
Hose - Upper		26603	Belt - P.S.		
Hose - Lower		25480	Hose - Upper		
Hose - By Pass		≈20568	Hose - Lower		
Dodge 6-Cyl. 265			Hose - By Pass		
S400; S500; S600			≈20568		
Belt - Fan & Gen.; W/50 5/8" Belt O.C.		TR24500	Dodge V-8 315		
Belt - Fan & Gen.; W/54 3/8" Belt O.C.		TR24538	S400; S500		
Belt - Fan & Gen.; W/52" Belt O.C.		TR24515	Belt - Fan & Gen.; W/35A, 40A. Alt.		
Belt - P.S.		▲9505HD	Belt - Fan & Gen.; W/O 35A, 40A. Alt.		
Hose - Upper		26603	Belt - P.S.		
Hose - Lower		25480	Belt - Air Brake Compr.		
Hose - By Pass		≈20568	Hose - Upper		
S500; S600			or 26501		
Belt - Fan & Gen.; W/50 5/8" Belt O.C.		TR24500	Hose - Lower; W/Man. Trans.		
Belt - Fan & Gen.; W/54 3/8" Belt O.C.		TR24538	or 25476		
Belt - Fan & Gen.; W/52" Belt O.C.		TR24515	Hose - Lower; W/Auto. Trans.		
Belt - P.S.		▲9505HD	or 20386		
Hose - Upper		26603	or 25478		
Hose - Lower		25480			
Hose - By Pass		≈20568			
Dodge 6-Cyl. 265					
S400; S500; S600					
Belt - Fan & Gen.; W/50 5/8" Belt O.C.		TR24500			
Belt - Fan & Gen.; W/54 3/8" Belt O.C.		TR24538			
Belt - Fan & Gen.; W/52" Belt O.C.		TR24515			
Belt - P.S.		▲9505HD			
Hose - Upper		26603			
Hose - Lower		25480			
Hose - By Pass		≈20568			
Dodge V-8 318					
S400; S500; S600					
Belt - Fan & Gen.; W/35A, 40A. Alt.	1851525	②▲◆9680HD			
Belt - Fan & Gen.; W/O 35A, 40A. Alt.	1852208	②▲◆9670HD			

▲Standard Belt Available.
②Two Required.

◆PowerBand Belt May Work, Use Template to Check.
≈Cut to Fit.

School Buses

Belts and Coolant Hose for School Buses

School Buses

Application	Mfr. Part No.	Our No.	Application	Mfr. Part No.	Our No.
Dodge - Continued			Dodge - Continued		
1959 - Continued			1958 - Continued		
Dodge V-8 318			Dodge V-8 315 - Continued		
S400; S500; S600			S600 - Continued		
Belt - Fan & Gen.; W/35A., 40A. Alt.	1851525	②♠9680HD	Belt - P.S.		♠9610HD
Belt - Fan & Gen.; W/O 35A., 40A. Alt.	1852208	②♠♠9670HD	Belt - Air Brake Compr.		♠9440HD
Belt - P.S.	1855867	♠9610HD	Hose - Upper; W/Man. Trans.		♠<20046
Belt - Air Brake Compr.	1614690	♠9440HD		or	26501
Hose - Upper		25527	Hose - Upper; W/Auto. Trans.		♠<20957
Hose - Lower		20386		or	26501
		25478	Hose - Lower		♠<20763
Hose - By Pass		♠<20618		or	25476
		28442			
Dodge V-8 331			Dodge V-8 331		
S700			S700		
Belt - Fan & Gen.		②BX65	Belt - Fan & Gen.		②BX65
Belt - P.S.	1855482	②7619	Belt - P.S.	1855482	②7619
Belt - Air Brake Compr.	1117611	TR24438	Belt - Air Brake Compr.	1117611	TR24438
Hose - Upper; W/Auto. Trans.		♠<20957	Hose - Upper; W/Auto. Trans.		♠<20957
		26501		or	26501
Hose - Lower; W/Auto. Trans.		♠<20763	Hose - Lower; W/Auto. Trans.		♠<20763
Hose - Lower; W/Man. Trans.		20145	Hose - Lower; W/Man. Trans.		20145
Hose - By Pass		♠<21942	Hose - By Pass		♠<21942
Dodge V-8 354			Dodge V-8 354		
S700			S700		
Belt - Fan & Gen.		②BX65	Belt - Fan & Gen.		②BX65
Belt - P.S.	1855482	②7619	Belt - P.S.	1855482	②7619
Belt - Air Brake Compr.	1117611	TR24438	Belt - Air Brake Compr.	1117611	TR24438
Hose - Upper; W/Auto. Trans.		♠<20957	Hose - Upper; W/Auto. Trans.		♠<20957
		26501		or	26501
Hose - Lower; W/Auto. Trans.		♠<20763	Hose - Lower; W/Auto. Trans.		♠<20763
Hose - Lower; W/Man. Trans.		20145	Hose - Lower; W/Man. Trans.		20145
Hose - By Pass		♠<21942	Hose - By Pass		♠<21942
1958			1957		
Dodge 6-Cyl. 251			Dodge 6-Cyl. 251		
S400; S500; S600			S400; S500; S600		
Belt - Fan & Gen.; W/40A. Alt.		TR24515	Belt - Fan & Gen.; W/50 5/8" Belt O.C.		TR24500
Belt - Fan & Gen.; W/O 40A. Alt.		TR24500	Belt - Fan & Gen.; W/52" Belt O.C.		TR24515
Belt - P.S.		7390	Belt - P.S.		7370
Hose - Upper		26603	Hose - Upper		26603
Hose - Lower		25480	Hose - Lower		25480
Hose - By Pass		♠<20568	Hose - By Pass		♠<20568
Dodge 6-Cyl. 265			Dodge 6-Cyl. 265		
S400; S500; S600			S400; S500; S600		
Belt - Fan & Gen.; W/40A. Alt.		TR24515	Belt - Fan & Gen.; W/50 5/8" Belt O.C.		TR24500
Belt - Fan & Gen.; W/O 40A. Alt.		TR24500	Belt - Fan & Gen.; W/52" Belt O.C.		TR24515
Belt - P.S.		7390	Belt - P.S.		7370
Hose - Upper		26603	Hose - Upper		26603
Hose - Lower		25480	Hose - Lower		25480
Hose - By Pass		♠<20568	Hose - By Pass		♠<20568
Dodge V-8 315			Dodge V-8 315		
S400; S500			S400; S500		
Belt - Fan & Gen.; W/35A., 40A. Alt.		②♠9680HD	Belt - Fan & Gen.; W/65 3/8" Belt O.C.		②♠♠9650HD
Belt - Fan & Gen.; W/O 35A., 40A. Alt.		②♠♠9670HD	Belt - Fan & Gen.; W/66 3/8" Belt O.C.		②♠♠9660HD
Belt - P.S.		♠9610HD	Belt - P.S.		♠9580HD
Belt - Air Brake Compr.		♠9440HD	Belt - Air Brake Compr.		♠9440HD
Hose - Upper		♠<20046	Hose - Upper		♠<20046
		26501		or	26501
Hose - Lower; W/Man. Trans.		♠<20763	Hose - Lower; W/Man. Trans.		♠<20763
		25476		or	25476
Hose - Lower; W/Auto. Trans.		20386	Hose - Lower; W/Auto. Trans.		20386
		25478		or	25478
S600			S600		
Belt - Fan & Gen.; W/35A., 40A. Alt.		②♠9680HD	Belt - Fan & Gen.; W/65 3/8" Belt O.C.		②♠♠9650HD
Belt - Fan & Gen.; W/O 35A., 40A. Alt.		②♠♠9670HD	Belt - Fan & Gen.; W/66 3/8" Belt O.C.		②♠♠9660HD
			Belt - P.S.		♠9580HD

♠Standard Belt Available.
②Two Required.

♠PowerBand Belt May Work, Use Template to Check.
♠<Cut to Fit.

Belts and Coolant Hose for School Buses

Application	Mfr. Part No.	Our No.	Application	Mfr. Part No.	Our No.
Dodge - Continued			Ford - Continued		
1957 - Continued			1994 - Continued		
Dodge V-8 315 - Continued			Ford 6-Cyl. 6.6 L Diesel - Continued		
S600 - Continued			B700 - Continued		
Belt - Air Brake Compr.		♣9440HD	Belt - Fan & Alt.; W/60A., 75A., 90A. Alt.; W/O W.P. Mtd. Fan; Optional Belt FOHZ 8620 G		②♣9690HD
Hose - Upper; W/Man. Trans.		≧20046	Belt - Fan & Alt.; W/130A. Alt.; W/O W.P. Mtd. Fan D8PZ 8620 Y		②♣9570HD
	or	26501	Belt - P.S.; W/O W.P. Mtd. Fan E8HZ 8620 Y		♣9630HD
Hose - Upper; W/Auto. Trans.		≧20957	Belt - P.S.; W/W.P. Mtd. Fan E6HZ 8620 E		♣9545HD
	or	26501	Belt - Hyd. Brake Boost Pump E8HZ 8620 H		♣9640HD
Hose - Lower ≧20763		25476	Belt - Air Brake Compr.; W/Auto. Trans.; W/2150 Air Brake Compr. E7HZ 8620 B		♣9635HD
	or		Belt - Air Brake Compr.; W/Man. Trans.; W/A.C.; W/2150 Air Brake Compr. E7HZ 8620 B		♣9635HD
Dodge V-8 331			Belt - Air Brake Compr.; W/Man. Trans.; W/O A.C.; W/2150 Air Brake Compr. C9PZ 8620 GN		♣9550HD
S700			Belt - Air Brake Compr.; W/550 Air Brake Compr. E3AZ 8620 D		♣9565HD
Belt - Fan & Gen.		②BX65	Belt - A.C.; W/59 1/2" Belt O.C. E8HZ 8620 N		♣9590HD
Belt - P.S.; W/Air Brakes 1393494		TR24562	Belt - A.C.; W/57 1/8" Belt O.C. D9PZ 8620 E		7565
Belt - P.S.; W/O Air Brakes 1191449		TR24476	Hose - Upper; W/O Air To Air Aftercooler		21943
Belt - Air Brake Compr. 1117611		TR24438	Hose - Upper; W/Air To Air Aftercooler		≧21943
Hose - Lower 26510		26510	Hose - Lower; W/Auto. Trans.; W/210 H.P.		22034
Dodge V-8 354			Hose - Lower; W/Man. Trans.; W/O Aftercooler		22033
S700			Hose - Lower; W/Auto. Trans.; W/O 210 H.P.		21961
Belt - Fan & Gen.		②BX65	Hose - Lower; W/Man. Trans.; W/O P.T.O.		21845
Belt - P.S.; W/Air Brakes 1393494		TR24562	Hose - Heater		28441
Belt - P.S.; W/O Air Brakes 1191449		TR24476	Ford 6-Cyl. 7.8 L Diesel		
Belt - Air Brake Compr. 1117611		TR24438	B700		
Hose - Lower 26510		26510	Belt - Fan & Alt.; W/O W.P. Mtd. Fan; Preferred Belt E8HZ 8620 B		2/9710PB
Ford			Belt - Fan & Alt.; W/O W.P. Mtd. Fan; Optional Belt E8HZ 8620 B		②♣9710HD
1998 - 1997			Belt - Hyd. Brake Boost Pump E8HZ 8620 H		♣9640HD
Ford FD1060 Diesel			Belt - Air Brake Compr. E8HZ 8620 Y		♣9630HD
B800			Belt - A.C.; W/59 1/2" Belt O.C. E8HZ 8620 N		♣9590HD
Belt - Accessory Belt Drive Kit		ACK080830HD	Belt - A.C.; W/57 1/8" Belt O.C. D7PZ 8620 J		7575
Belt - Alt., W.P. & P.S. JK8836		♣K080830HD	Hose - Upper; W/O Air To Air Aftercooler		21943
Belt - A.C. F4HT 8620 GA		♣9412HD	Hose - Upper; W/Air To Air Aftercooler		≧21943
Tensioner Assy. - Alt., W.P. & P.S. 3978021		38517	Hose - Lower; W/Auto. Trans.; W/210 H.P.		22034
Hose - Upper - Eng. To Rad.		24226	Hose - Lower; W/Auto. Trans.; W/O 210 H.P.		21961
1996			Hose - Lower; W/Man. Trans.; W/O Aftercooler		22033
Ford FD1060 Diesel			Hose - Lower; W/Man. Trans.; W/O P.T.O.		21845
B800			Hose - Heater		28441
Belt - Accessory Belt Drive Kit		ACK080830HD	Ford FD1060 Diesel		
Belt - Alt., W.P. & P.S. JK8-836		♣K080830HD	B600; B700		
Belt - A.C. F3HZ 8620 A		♣9420HD	Belt - Fan & Alt. 1822630C1		
Tensioner Assy. - Alt., W.P. & P.S. 3978021		38517	♣K080893HD		
Ford V-8 7.3 L Diesel			1993 - 1992		
B600; B700			Ford 6-Cyl. 6.6 L Diesel		
Belt - Fan & Alt. 1822630C1		♣K080893HD	B600; B700		
1995			Belt - Fan & Alt.; W/60A., 75A., 90A. Alt.; W/W.P. Mtd. Fan; Preferred Belt C9PZ 8620 DF		
Ford FD1060 Diesel			Belt - Fan & Alt.; W/60A., 75A., 90A. Alt.; W/W.P. Mtd. Fan; Optional Belt C9PZ 8620 DF		
B800			Belt - Fan & Alt.; W/130A. Alt.; W/W.P. Mtd. Fan D8PZ 8620 N		
Belt - Alt., W.P. & P.S. JK8-836		♣K080830HD	Belt - Fan & Alt.; W/60A., 75A., 90A. Alt.; W/O W.P. Mtd. Fan; Preferred Belt FOHZ 8620 G		
Belt - A.C. F3HZ 8620 A		♣9420HD	Belt - Fan & Alt.; W/60A., 75A., 90A. Alt.; W/O W.P. Mtd. Fan; Optional Belt FOHZ 8620 G		
Tensioner Assy. - Alt., W.P. & P.S. 3978021		38517	Belt - Fan & Alt.; W/130A. Alt.; W/O W.P. Mtd. Fan D8PZ 8620 Y		
1994			Belt - P.S.; W/O W.P. Mtd. Fan E8HZ 8620 Y		
Ford 6-Cyl. 6.6 L Diesel			Belt - P.S.; W/W.P. Mtd. Fan E6HZ 8620 E		
B700			Belt - Hyd. Brake Boost Pump E8HZ 8620 H		
Belt - Fan & Alt.; W/60A., 75A., 90A. Alt.; W/W.P. Mtd. Fan; Preferred Belt C9PZ 8620 DF		2/9610PB	Belt - Air Brake Compr.; W/Auto. Trans.; W/2150 Air Brake Compr. E7HZ 8620 B		
Belt - Fan & Alt.; W/60A., 75A., 90A. Alt.; W/W.P. Mtd. Fan; Optional Belt C9PZ 8620 DF		②♣9610HD	♣9635HD		
Belt - Fan & Alt.; W/130A. Alt.; W/W.P. Mtd. Fan D8PZ 8620 N		②♣9625HD			
Belt - Fan & Alt.; W/60A., 75A., 90A. Alt.; W/O W.P. Mtd. Fan; Preferred Belt FOHZ 8620 G		2/9690PB			
Belt - Fan & Alt.; W/60A., 75A., 90A. Alt.; W/O W.P. Mtd. Fan; Optional Belt FOHZ 8620 G		②♣9690HD			
Belt - Fan & Alt.; W/130A. Alt.; W/O W.P. Mtd. Fan D8PZ 8620 Y		②♣9570HD			
Belt - P.S.; W/O W.P. Mtd. Fan E8HZ 8620 Y		♣9630HD			
Belt - P.S.; W/W.P. Mtd. Fan E6HZ 8620 E		♣9545HD			
Belt - Hyd. Brake Boost Pump E8HZ 8620 H		♣9640HD			
Belt - Air Brake Compr.; W/Auto. Trans.; W/2150 Air Brake Compr. E7HZ 8620 B		♣9635HD			

≧Cut to Fit.
♣Standard Belt Available.

②Two Required.

School Buses

Belts and Coolant Hose for School Buses

Application	Mfr. Part No.	Our No.	Application	Mfr. Part No.	Our No.
Ford - Continued			Ford - Continued		
1993 - 1992 - Continued			1991 - Continued		
Ford 6-Cyl. 6.6 L Diesel - Continued			Ford 6-Cyl. 6.6 L Diesel - Continued		
B600; B700 - Continued			B600; B700 - Continued		
Belt - Air Brake Compr.; W/Man. Trans.; W/A.C.; W/2150 Air Brake Compr.	E7HZ 8620 B	♣9635HD	Hose - Upper; W/Air To Air Aftercooler		♣21943
Belt - Air Brake Compr.; W/Man. Trans.; W/O A.C.; W/2150 Air Brake Compr.	C9PZ 8620 GN	♣9550HD	Hose - Lower; W/Auto. Trans.; W/210 H.P.		22034
Belt - Air Brake Compr.; W/550 Air Brake Compr.	E3AZ 8620 D	♣9565HD	Hose - Lower; W/Man. Trans.; W/O Aftercooler		22033
Belt - A.C.; W/59 1/2" Belt O.C.	E8HZ 8620 N	♣9590HD	Hose - Lower; W/Auto. Trans.; W/O 210 H.P.		21961
Belt - A.C.; W/57 1/8" Belt O.C.	D9PZ 8620 E	7565	Hose - Lower; W/Man. Trans.; W/O P.T.O.		21845
Hose - Upper; W/O Air To Air Aftercooler		21943	Hose - Heater		28441
Hose - Upper; W/Air To Air Aftercooler		♣21943			
Hose - Lower; W/Auto. Trans.; W/210 H.P.		22034			
Hose - Lower; W/Man. Trans.; W/O Aftercooler		22033			
Hose - Lower; W/Auto. Trans.; W/O 210 H.P.		21961			
Hose - Lower; W/Man. Trans.; W/O P.T.O.		21845			
Hose - Heater		28441			
Ford 6-Cyl. 7.8 L Diesel			Ford 6-Cyl. 7.8 L Diesel		
B700			B700		
Belt - Fan & Alt.; W/O W.P. Mtd. Fan; Preferred Belt	E8HZ 8620 B	2/9710PB	Belt - Fan & Alt.; W/O W.P. Mtd. Fan; Preferred Belt	E8HZ 8620 B	2/9710PB
Belt - Fan & Alt.; W/O W.P. Mtd. Fan; Optional Belt	E8HZ 8620 B	②♣9710HD	Belt - Fan & Alt.; W/O W.P. Mtd. Fan; Optional Belt	E8HZ 8620 B	②♣9710HD
Belt - Hyd. Brake Boost Pump	E8HZ 8620 H	♣9640HD	Belt - Hyd. Brake Boost Pump	E8HZ 8620 H	♣9640HD
Belt - Air Brake Compr.	E8HZ 8620 Y	♣9630HD	Belt - Air Brake Compr.	E8HZ 8620 Y	♣9630HD
Belt - A.C.; W/59 1/2" Belt O.C.	E8HZ 8620 N	♣9590HD	Belt - A.C.; W/59 1/2" Belt O.C.	E8HZ 8620 N	♣9590HD
Belt - A.C.; W/57 1/8" Belt O.C.	D7PZ 8620 J	7575	Belt - A.C.; W/57 1/8" Belt O.C.	D7PZ 8620 J	7575
Hose - Upper; W/O Air To Air Aftercooler		21943	Hose - Upper; W/O Air To Air Aftercooler		21943
Hose - Upper; W/Air To Air Aftercooler		♣21943	Hose - Upper; W/Air To Air Aftercooler		♣21943
Hose - Lower; W/Auto. Trans.; W/210 H.P.		22034	Hose - Lower; W/Auto. Trans.; W/210 H.P.		22034
Hose - Lower; W/Auto. Trans.; W/O 210 H.P.		21961	Hose - Lower; W/Auto. Trans.; W/O 210 H.P.		21961
Hose - Lower; W/Man. Trans.; W/O Aftercooler		22033	Hose - Lower; W/Man. Trans.; W/O Aftercooler		22033
Hose - Lower; W/Man. Trans.; W/O P.T.O.		21845	Hose - Lower; W/Man. Trans.; W/O P.T.O.		21845
Hose - Heater		28441	Hose - Heater		28441
Ford FD1060 Diesel			1990		
B600; B700			Ford 6-Cyl. 6.6 L Diesel		
Belt - Fan & Alt.	F3HZ 8620 B	♣K080830HD	B600; B700		
1991			Belt - Fan & Alt.; W/60A., 75A., 90A. Alt.; W/W.P. Mtd. Fan; Preferred Belt		
Ford 6-Cyl. 6.6 L Diesel			C9PZ 8620 DF		
B600; B700			2/9610PB		
Belt - Fan & Alt.; W/60A., 75A., 90A. Alt.; W/W.P. Mtd. Fan; Preferred Belt	C9PZ 8620 DF	2/9610PB	Belt - Fan & Alt.; W/60A., 75A., 90A. Alt.; W/W.P. Mtd. Fan; Preferred Belt	C9PZ 8620 DF	2/9610PB
Belt - Fan & Alt.; W/60A., 75A., 90A. Alt.; W/W.P. Mtd. Fan; Optional Belt	C9PZ 8620 DF	②♣9610HD	Belt - Fan & Alt.; W/60A., 75A., 90A. Alt.; W/W.P. Mtd. Fan; Optional Belt	C9PZ 8620 DF	②♣9610HD
Belt - Fan & Alt.; W/130A. Alt.; W/W.P. Mtd. Fan	D8PZ 8620 N	②♣9625HD	Belt - Fan & Alt.; W/130A. Alt.; W/W.P. Mtd. Fan	D8PZ 8620 N	②♣9625HD
Belt - Fan & Alt.; W/60A., 75A., 90A. Alt.; W/O W.P. Mtd. Fan; Preferred Belt	F0HZ 8620 G	2/9690PB	Belt - Fan & Alt.; W/60A., 75A., 90A. Alt.; W/O W.P. Mtd. Fan; Preferred Belt	F0HZ 8620 G	2/9690PB
Belt - Fan & Alt.; W/60A., 75A., 90A. Alt.; W/O W.P. Mtd. Fan; Preferred Belt	F0HZ 8620 G	②♣9690HD	Belt - Fan & Alt.; W/60A., 75A., 90A. Alt.; W/O W.P. Mtd. Fan; Preferred Belt	F0HZ 8620 G	②♣9690HD
Belt - Fan & Alt.; W/130A. Alt.; W/O W.P. Mtd. Fan	D8PZ 8620 Y	②♣9570HD	Belt - Fan & Alt.; W/130A. Alt.; W/O W.P. Mtd. Fan	D8PZ 8620 Y	②♣9570HD
Belt - P.S.; W/O W.P. Mtd. Fan	E8HZ 8620 Y	♣9630HD	Belt - P.S.; Dec. 1, 1990 & Older	E8HZ 8620 Y	♣9630HD
Belt - P.S.; W/W.P. Mtd. Fan	E6HZ 8620 E	♣9545HD	Belt - P.S.; Dec. 2, 1990 & Newer; W/O W.P. Mtd. Fan	E8HZ 8620 Y	♣9630HD
Belt - Hyd. Brake Boost Pump	E8HZ 8620 H	♣9640HD	Belt - P.S.; Dec. 2, 1990 & Newer; W/W.P. Mtd. Fan	E6HZ 8620 E	♣9545HD
Belt - Air Brake Compr.; W/Auto. Trans.; W/2150 Air Brake Compr.	E7HZ 8620 B	♣9635HD	Belt - Hyd. Brake Boost Pump	E8HZ 8620 H	♣9640HD
Belt - Air Brake Compr.; W/Man. Trans.; W/A.C.; W/2150 Air Brake Compr.	E7HZ 8620 B	♣9635HD	Belt - Air Brake Compr.; Oct. 1, 1990 & Older	E7HZ 8620 C	♣9640HD
Belt - Air Brake Compr.; W/Man. Trans.; W/O A.C.; W/2150 Air Brake Compr.	C9PZ 8620 GN	♣9550HD	Belt - Air Brake Compr.; W/Auto. Trans.; W/2150 Air Brake Compr.; Oct. 2, 1990 & Newer	E7HZ 8620 B	♣9635HD
Belt - Air Brake Compr.; W/550 Air Brake Compr.	E3AZ 8620 D	♣9565HD	Belt - Air Brake Compr.; W/Man. Trans.; W/A.C.; W/2150 Air Brake Compr.; Oct. 2, 1990 & Newer	E7HZ 8620 B	♣9635HD
Belt - A.C.; W/59 1/2" Belt O.C.	E8HZ 8620 N	♣9590HD	Belt - Air Brake Compr.; W/Man. Trans.; W/O A.C.; W/2150 Air Brake Compr.; Oct. 2, 1990 & Newer	C9PZ 8620 GN	♣9550HD
Belt - A.C.; W/57 1/8" Belt O.C.	D9PZ 8620 E	7565	Belt - Air Brake Compr.; W/550 Air Brake Compr.; Dec. 1, 1990 & Newer	E3AZ 8620 D	♣9565HD
Hose - Upper; W/O Air To Air Aftercooler		21943	Belt - A.C.; W/59 1/2" Belt O.C.	E8HZ 8620 N	♣9590HD
Hose - Upper; W/Air To Air Aftercooler		♣21943	Belt - A.C.; W/57 1/8" Belt O.C.	D9PZ 8620 E	7565
Hose - Lower; W/Auto. Trans.; W/210 H.P.		22034	Hose - Upper; W/O Air To Air Aftercooler		21943
Hose - Lower; W/Man. Trans.; W/O Aftercooler		22033	Hose - Upper; W/Air To Air Aftercooler		♣21943
Hose - Lower; W/Auto. Trans.; W/O 210 H.P.		21961	Hose - Lower; W/Auto. Trans.; W/210 H.P.		22034
Hose - Lower; W/Man. Trans.; W/O P.T.O.		21845	Hose - Lower; W/Man. Trans.; W/O Aftercooler		22033
			Hose - Lower; W/Auto. Trans.; W/O 210 H.P.		21961
			Hose - Lower; W/Man. Trans.; W/O P.T.O.		21845

♣Standard Belt Available.
②Two Required.

♣Cut to Fit.

Belts and Coolant Hose for School Buses

Application	Mfr. Part No.	Our No.	Application	Mfr. Part No.	Our No.
Ford - Continued			Ford - Continued		
1990 - Continued			1989 - Continued		
Ford 6-Cyl. 6.6 L Diesel - Continued			Ford V-8 6.1 L - Continued		
B600; B700 - Continued			B600; B700 - Continued		
Hose - Heater		28441	Belt - Fan, P.S. & A.P.	②◆◆9650HD	
Ford 6-Cyl. 7.8 L Diesel			Belt - Fan, A.P. & Air Brake Compr.	◆9640HD	
B700			Belt - Fan, A.P. & Hyd. Brake Boost Pump . EOTE 8620 KA	◆9610HD	
Belt - Fan & Alt.; W/O W.P. Mtd. Fan; Preferred Belt	E8HZ 8620 B	2/9710PB	Belt - A.P.	◆9330HD	
Belt - Fan & Alt.; W/O W.P. Mtd. Fan; Optional Belt	E8HZ 8620 B	②◆9710HD	Hose - Upper; W/Auto. Trans.	≈21936	
Belt - Hyd. Brake Boost Pump	E8HZ 8620 H	◆9640HD	or	26512	
Belt - Air Brake Compr.; Dec. 1, 1990 & Older	E8HZ 8620 M	◆9650HD	Hose - Upper; W/Man. Trans.	21305	
Belt - Air Brake Compr.; Dec. 2, 1990 & Newer	E8HZ 8620 Y	◆9630HD	or	26512	
Belt - A.C.; W/59 1/2" Belt O.C.	E8HZ 8620 N	◆9590HD	Hose - Lower - Eng. To Pipe	21969	
Belt - A.C.; W/57 1/8" Belt O.C.	D7PZ 8620 J	7575	Hose - Lower - Pipe To Rad.; W/Auto. Trans.	21368	
Hose - Upper; W/O Air To Air Aftercooler		21943	Hose - Lower - Pipe To Rad.; W/Man. Trans.	≈20452	
Hose - Upper; W/Air To Air Aftercooler		≈21943	Hose - By Pass	≈21942	
Hose - Lower; W/Auto. Trans.; W/210 H.P.		22034	Hose - Heater	24216	
Hose - Lower; W/Auto. Trans.; W/O 210 H.P.		21961	Ford V-8 7.0 L		
Hose - Lower; W/Man. Trans.; W/O Aftercooler		22033	B600; B700		
Hose - Lower; W/Man. Trans.; W/O P.T.O.		21845	Belt - Fan & Alt.; W/60A. Alt.; W/O Fan Clutch		
Hose - Heater		28441		D2TE 8620 AEA	◆9451HD
1989			Belt - Fan & Alt.; W/60A. Alt.; W/Fan Clutch		◆9435HD
Ford 6-Cyl. 6.6 L Diesel			Belt - Fan & Alt.; W/75A. Alt.; W/O Fan Clutch		◆9463HD
B600; B700			Belt - Fan & Alt.; W/75A. Alt.; W/Fan Clutch		◆9447HD
Belt - Fan & Alt.; W/60A., 70A., 90A. Alt.; W/W.P. Mtd. Fan	F2HT 8620 FA	②◆◆9610HD	Belt - Fan & Alt.; W/90A., 130A. Alt.; W/O Fan Clutch		◆9463HD
Belt - Fan & Alt.; W/60A., 75A., 90A. Alt.; W/O W.P. Mtd. Fan		②◆9600HD	Belt - Fan & Alt.; W/90A., 130A. Alt.; W/Fan Clutch		◆9451HD
Belt - Fan & Alt.; W/130A. Alt.; W/W.P. Mtd. Fan	D8PZ 8620 N	②◆9625HD	Belt - Fan & P.S.; W/Single A.P.	②◆◆9530HD	
Belt - Fan & Alt.; W/130A. Alt.; W/O W.P. Mtd. Fan	D8PZ 8620 Y	②7570	Belt - Fan, P.S. & A.P.	②◆◆9650HD	
Belt - W.P. & Hyd. Brake Boost Pump	E8HZ 8620 H	◆9640HD	Belt - Fan, A.P. & Air Brake Compr.	◆9640HD	
Belt - P.S.	E8HZ 8620 Y	◆9635HD	Belt - Fan, A.P. & Hyd. Brake Boost Pump . EOTE 8620 KA	◆9610HD	
Belt - Air Brake Compr.	E7HZ 8620 C	◆9640HD	Belt - A.P.	◆9330HD	
Belt - A.C.	D6PZ 8620 E	7565	Hose - Upper	≈21936	
Belt - Idler; W/Air Brake Compr.	E8HZ 8620 H	◆9640HD	or	26512	
Hose - Upper		21810	Hose - Lower - Eng. To Pipe	21969	
Hose - Lower; W/Man. Trans.		21845	Hose - Lower - Pipe To Rad.; W/Auto. Trans.	21368	
Hose - By Pass		24224	Hose - Lower - Pipe To Rad.; W/Man. Trans.	≈20452	
Hose - Heater		28441	Hose - By Pass	≈21942	
Ford 6-Cyl. 7.8 L Diesel			Hose - Heater	24216	
B700			1988		
Belt - Fan & Alt.; W/O W.P. Mtd. Fan	E8HZ 8620 B	②◆◆9710HD	Ford 6-Cyl. 6.6 L Diesel		
Belt - W.P. & Hyd. Brake Boost Pump	E8HZ 8620 H	◆9640HD	B600; B700		
Belt - P.S.	E8HZ 8620 Y	◆9630HD	Belt - Fan & Alt.; W/60A., 70A., 90A. Alt.; W/W.P. Mtd. Fan		
Belt - Air Brake Compr.	E8HZ 8620 M	◆9650HD		F2HT 8620 FA	②◆◆9610HD
Belt - A.C.	D7PZ 8620 J	7575	Belt - Fan & Alt.; W/60A., 75A., 90A. Alt.; W/O W.P. Mtd. Fan		②◆9600HD
Belt - Idler; W/Air Brake Compr.	E8HZ 8620 H	◆9640HD	Belt - Fan & Alt.; W/130A. Alt.; W/W.P. Mtd. Fan	D8PZ 8620 N	②◆9625HD
Hose - Upper		21810	Belt - Fan & Alt.; W/130A. Alt.; W/O W.P. Mtd. Fan	D8PZ 8620 Y	②7570
Hose - Lower; W/Man. Trans.		21845	Belt - W.P. & Hyd. Brake Boost Pump	E8HZ 8620 H	◆9640HD
Hose - By Pass		24224	Belt - P.S.	E8HZ 8620 Y	◆9635HD
Hose - Heater		28441	Belt - Air Brake Compr.	E7HZ 8620 C	◆9640HD
Ford V-8 6.1 L			Belt - A.C.	D6PZ 8620 E	7565
B600; B700			Belt - Idler; W/Air Brake Compr.	E8HZ 8620 H	◆9640HD
Belt - Fan & Alt.; W/60A. Alt.; W/O Fan Clutch	D2TE 8620 AEA	◆9451HD	Hose - Upper		21810
Belt - Fan & Alt.; W/60A. Alt.; W/Fan Clutch		◆9435HD	Hose - Lower; W/Man. Trans.		21845
Belt - Fan & Alt.; W/75A. Alt.; W/O Fan Clutch		◆9463HD	Hose - By Pass		24224
Belt - Fan & Alt.; W/75A. Alt.; W/Fan Clutch		◆9447HD	Hose - Heater		28441
Belt - Fan & Alt.; W/90A., 130A. Alt.; W/O Fan Clutch		◆9463HD	Ford 6-Cyl. 7.8 L Diesel		
Belt - Fan & Alt.; W/90A., 130A. Alt.; W/Fan Clutch		◆9451HD	B700		
Belt - Fan & P.S.; W/Single A.P.		②◆◆9530HD	Belt - Fan & Alt.; W/O W.P. Mtd. Fan		
				E8HZ 8620 B	②◆◆9710HD
			Belt - W.P. & Hyd. Brake Boost Pump	E8HZ 8620 H	◆9640HD
			Belt - P.S.	E8HZ 8620 Y	◆9630HD
			Belt - Air Brake Compr.	E8HZ 8620 M	◆9650HD
			Belt - A.C.	D7PZ 8620 J	7575
			Belt - Idler; W/Air Brake Compr.	E8HZ 8620 H	◆9640HD
			Hose - Upper		21810

◆Standard Belt Available.
≈Cut to Fit.

②Two Required.
◆PowerBand Belt May Work, Use Template to Check.

Belts and Coolant Hose for School Buses

School Buses

Application	Mfr. Part No.	Our No.
Ford - Continued		
1988 - Continued		
Ford 6-Cyl. 7.8 L Diesel - Continued		
B700 - Continued		
Hose - Lower; W/Man. Trans.		21845
Hose - By Pass		24224
Hose - Heater		28441
Ford V-8 6.1 L		
B600; B700		
Belt - Fan & Alt.; W/40A., 60A. Alt.; W/22" Fan Clutch	E0TE 8A615 EA	②◆◆9447HD
Belt - Fan & Alt.; W/40A., 60A. Alt.; W/O 22" Fan Clutch	D2TE 8A615 CA	②◆◆9440HD
Belt - Fan & Alt.; W/40A., 60A. Alt.; W/Fixed Fan	D2TE 8620 AEA	②◆◆9451HD
Belt - Fan & Alt.; W/75A. Alt.; W/22" Fan Clutch	E0TE 8A615 FA	②◆◆9455HD
Belt - Fan & Alt.; W/75A. Alt.; W/O 22" Fan Clutch	D9TE 8A615 AA	②◆◆9447HD
Belt - Fan & Alt.; W/75A. Alt.; W/Fixed Fan	D2TE 8A615 VA	②◆◆9463HD
Belt - Fan & Alt.; W/90A. Alt.; W/22" Fan Clutch	E2TE 8A615 AA	②◆◆9463HD
Belt - Fan & Alt.; W/90A. Alt.; W/O 22" Fan Clutch	D2TE 8A615 MA	②◆◆9451HD
Belt - Fan & Alt.; W/90A. Alt.; W/Fixed Fan	D2TE 8A615 BA	②◆◆9465HD
Belt - Fan & Alt.; W/105A., 130A. Alt.; W/22" Fan Clutch ..		②◆◆9465HD
Belt - Fan & Alt.; W/105A., 130A. Alt.; W/O 22" Fan Clutch		②◆◆9455HD
Belt - Fan & Alt.; W/105A., 130A. Alt.; W/Fixed Fan	D2TE 8A615 VA	②◆◆9463HD
Belt - Fan & P.S.; W/Single A.P.; W/Fan Clutch		②◆◆9530HD
Belt - Fan & P.S.; W/22" Fan Clutch		◆9565HD
Belt - Fan & P.S.; W/O Fan Clutch		◆9530HD
Belt - Fan, P.S. & A.P.		②◆◆9650HD
Belt - Fan, A.P. & Air Brake Compr.		◆9640HD
Belt - Fan, A.P. & Hyd. Brake Boost Pump . EOTE 8620 KA		◆9610HD
Belt - A.C.		◆9330HD
Belt - A.P.; W/Fan Clutch	D4TE 8620 AA	◆9385HD
Belt - A.P.; W/O Fan Clutch	D2TE 8620 BNA	◆9370HD
Hose - Upper; W/Auto. Trans.		≈<21936
	or	26512
Hose - Upper; W/Man. Trans.		21305
	or	26512
Hose - Lower - Eng. To Pipe		21969
Hose - Lower - Pipe To Rad.; W/Auto. Trans.		21368
Hose - Lower - Pipe To Rad.; W/Man. Trans.		≈<20452
Hose - By Pass		≈<21942
Hose - Heater		24216
Ford V-8 7.0 L		
B600; B700		
Belt - Fan & Alt.; W/40A., 60A. Alt.; W/22" Fan Clutch	E0TE 8A615 EA	②◆◆9447HD
Belt - Fan & Alt.; W/40A., 60A. Alt.; W/O 22" Fan Clutch	D2TE 8A615 CA	②◆◆9440HD
Belt - Fan & Alt.; W/40A., 60A. Alt.; W/Fixed Fan	D2TE 8620 AEA	②◆◆9451HD
Belt - Fan & Alt.; W/75A. Alt.; W/22" Fan Clutch	E0TE 8A615 FA	②◆◆9455HD
Belt - Fan & Alt.; W/75A. Alt.; W/O 22" Fan Clutch	D9TE 8A615 AA	②◆◆9447HD
Belt - Fan & Alt.; W/75A. Alt.; W/Fixed Fan	D2TE 8A615 VA	②◆◆9463HD
Belt - Fan & Alt.; W/90A. Alt.; W/22" Fan Clutch	E2TE 8A615 AA	②◆◆9463HD
Belt - Fan & Alt.; W/90A. Alt.; W/O 22" Fan Clutch	D2TE 8A615 MA	②◆◆9451HD
Belt - Fan & Alt.; W/90A. Alt.; W/Fixed Fan	D2TE 8A615 BA	②◆◆9465HD
Belt - Fan & Alt.; W/105A., 130A. Alt.; W/22" Fan Clutch ..		②◆◆9465HD
Belt - Fan & Alt.; W/105A., 130A. Alt.; W/O 22" Fan Clutch		②◆◆9455HD

Application	Mfr. Part No.	Our No.
Ford - Continued		
1988 - Continued		
Ford V-8 7.0 L - Continued		
B600; B700 - Continued		
Belt - Fan & Alt.; W/105A., 130A. Alt.; W/Fixed Fan	D2TE 8A615 VA	②◆◆9463HD
Belt - Fan & P.S.; W/Single A.P.; W/Fan Clutch		②◆◆9530HD
Belt - Fan & P.S.; W/22" Fan Clutch		◆9565HD
Belt - Fan & P.S.; W/O Fan Clutch		◆9530HD
Belt - Fan, P.S. & A.P.		②◆◆9650HD
Belt - Fan, A.P. & Air Brake Compr.		◆9640HD
Belt - Fan, A.P. & Hyd. Brake Boost Pump . EOTE 8620 KA		◆9610HD
Belt - A.C.		◆9330HD
Belt - A.P.; W/Fan Clutch	D4TE 8620 AA	◆9385HD
Belt - A.P.; W/O Fan Clutch	D2TE 8620 BNA	◆9370HD
Hose - Upper		≈<21936
	or	26512
Hose - Lower - Eng. To Pipe		21969
Hose - Lower - Pipe To Rad.; W/Auto. Trans.		21368
Hose - Lower - Pipe To Rad.; W/Man. Trans.		≈<20452
Hose - By Pass		≈<21942
Hose - Heater		24216
1987		
Caterpillar 3208 Diesel		
B7000		
Belt - Fan & P.S.	D3HA 8620 CA	②◆◆9670HD
Belt - W.P. & Alt.; W/Motorola 130A. Alt.		②◆◆9610HD
Belt - W.P. & Alt.; W/O Motorola 130A. Alt.		◆9570HD
Belt - P.S.	D7HT 8620 LA	◆9375HD
Belt - Air Brake Compr.	D5HA 8620 GA	◆9580HD
Belt - A.C.; W/42 7/8" Belt O.C.	E4HT 8620 GB	◆9425HD
Belt - A.C.; W/53 3/8" Belt O.C.		◆9530HD
Belt - Hyd. Brake Boost Pump	C8HA 8620 A	◆9560HD
Belt - V.P.	DOHA 8620 U	◆9550HD
Hose - Upper		21569
Hose - Lower		21562
Hose - Oil Cooler - Front Inlet		21824
Hose - Oil Cooler - Rear Inlet		21381
Hose - Oil Cooler Outlet		21380
Hose - Heater		28441
Detroit Diesel V-8 8.2 L Diesel		
B600; B700		
Belt - Fan & Alt.; W/O A.C.; W/40A., 60A. Alt.	E1HZ 8620 A	②◆◆9660HD
Belt - Fan & Alt.; W/O A.C.; W/70A., 90A. Alt.	E1HZ 8620 B	②◆◆9670HD
Belt - Fan & Alt.; W/A.C.; W/105A., 130A. Alt.		②◆◆9670HD
Belt - P.S.; W/O 5500 Lb. Axle	E0HT 8620 DA	②◆◆9430HD
Belt - P.S.; W/5500 Lb. Axle		②◆◆9395HD
Belt - Air Brake Compr.	E0HT 8620 LA	◆9720HD
Belt - A.C.	E0HZ 8620 R	◆9720HD
Belt - Hyd. Brake Boost Pump; W/69 1/4" Belt O.C.		◆9680HD
Belt - Hyd. Brake Boost Pump; W/70 1/4" Belt O.C.		◆9700HD
Belt - V.P.; W/High Mount V.P.	D9PZ 8620 B	◆9435HD
Belt - V.P.; W/Low Mount V.P.	E0HZ 8620 S	◆9680HD
Hose - Upper; W/A.C.		21470
Hose - Upper; W/O A.C.		≈<21470
Hose - Lower - Eng. To Pipe		21363
Hose - Lower - Pipe To Rad.		21307
Hose - By Pass - Left Side		24222
Hose - By Pass - Right Side		21457
Hose - Oil Cooler		③28443
Hose - Heater		28441
Ford 6-Cyl. 6.6 L Diesel		
B600; B700		
Belt - Fan & Alt.; W/60A., 70A., 90A. Alt.; W/W.P. Mtd. Fan	F2HT 8620 FA	②◆◆9610HD

◆Standard Belt Available.
②Two Required.
③Three Required.

◆PowerBand Belt May Work, Use Template to Check.
≈<Cut to Fit.

Belts and Coolant Hose for School Buses

Application	Mfr. Part No.	Our No.	Application	Mfr. Part No.	Our No.
Ford - Continued			Ford - Continued		
1987 - Continued			1987 - Continued		
Ford 6-Cyl. 6.6 L Diesel - Continued			Ford V-8 6.1 L - Continued		
B600; B700 - Continued			B600; B700 - Continued		
Belt - Fan & Alt.; W/60A., 75A., 90A. Alt.; W/O W.P. Mtd. Fan		②♠9600HD	Hose - Lower - Pipe To Rad.; W/Man. Trans.		≈20452
Belt - Fan & Alt.; W/130A. Alt.; W/W.P. Mtd. Fan	D8PZ 8620 N	②♠9625HD	Hose - By Pass		≈21942
Belt - Fan & Alt.; W/130A. Alt.; W/O W.P. Mtd. Fan	D8PZ 8620 Y	②7570	Hose - Heater		24216
Belt - W.P. & Hyd. Brake Boost Pump	E8HZ 8620 H	♠9640HD	Ford V-8 7.0 L		
Belt - P.S.	E8HZ 8620 Y	♠9635HD	B700		
Belt - Air Brake Compr.	E7HZ 8620 C	♠9640HD	Belt - Fan & Alt.; W/40A., 60A. Alt.; W/22" Fan Clutch	E0TE 8A615 EA	②♠◆9447HD
Belt - A.C.	D6PZ 8620 E	7565	Belt - Fan & Alt.; W/40A., 60A. Alt.; W/O 22" Fan Clutch	D2TE 8A615 CA	②♠9440HD
Belt - Idler; W/Air Brake Compr.	E8HZ 8620 H	♠9640HD	Belt - Fan & Alt.; W/40A., 60A. Alt.; W/Fixed Fan	D2TE 8620 AEA	②♠◆9451HD
Hose - Upper		21810	Belt - Fan & Alt.; W/75A. Alt.; W/22" Fan Clutch	E0TE 8A615 FA	②♠9455HD
Hose - Lower; W/Man. Trans.		21845	Belt - Fan & Alt.; W/75A. Alt.; W/O 22" Fan Clutch	D9TE 8A615 AA	②♠◆9447HD
Hose - By Pass		24224	Belt - Fan & Alt.; W/75A. Alt.; W/Fixed Fan	D2TE 8A615 VA	②♠◆9463HD
Hose - Heater		28441	Belt - Fan & Alt.; W/90A. Alt.; W/22" Fan Clutch	E2TE 8A615 AA	②♠◆9463HD
Ford 6-Cyl. 7.8 L Diesel			Belt - Fan & Alt.; W/90A. Alt.; W/O 22" Fan Clutch	D2TE 8A615 MA	②♠◆9451HD
B700			Belt - Fan & Alt.; W/90A. Alt.; W/Fixed Fan	D2TE 8A615 BA	②♠9465HD
Belt - Fan & Alt.; W/O W.P. Mtd. Fan	E8HZ 8620 B	②♠◆9710HD	Belt - Fan & Alt.; W/105A., 130A. Alt.; W/22" Fan Clutch ..		②♠9465HD
Belt - W.P. & Hyd. Brake Boost Pump	E8HZ 8620 H	♠9640HD	Belt - Fan & Alt.; W/105A., 130A. Alt.; W/O 22" Fan Clutch		②♠9455HD
Belt - P.S.	E8HZ 8620 Y	♠9630HD	Belt - Fan & Alt.; W/105A., 130A. Alt.; W/Fixed Fan	D2TE 8A615 VA	②♠◆9463HD
Belt - Air Brake Compr.	E8HZ 8620 M	♠9650HD	Belt - Fan & P.S.; W/Single A.P.; W/Fan Clutch		②♠◆9530HD
Belt - A.C.	D7PZ 8620 J	7575	Belt - Fan & P.S.; W/22" Fan Clutch		♠9565HD
Belt - Idler; W/Air Brake Compr.	E8HZ 8620 H	♠9640HD	Belt - Fan & P.S.; W/O Fan Clutch		♠9530HD
Hose - Upper		21810	Belt - Fan, P.S. & A.P.		②♠◆9650HD
Hose - Lower; W/Man. Trans.		21845	Belt - Fan, A.P. & Air Brake Compr.		♠9640HD
Hose - By Pass		24224	Belt - Fan, A.P. & Hyd. Brake Boost Pump .	E0TE 8620 KA	♠9610HD
Hose - Heater		28441	Belt - A.C.		♠9330HD
Ford V-8 6.1 L			Belt - A.P.; W/Fan Clutch	D4TE 8620 AA	♠9385HD
B600; B700			Belt - A.P.; W/O Fan Clutch	D2TE 8620 BNA	♠9370HD
Belt - Fan & Alt.; W/40A., 60A. Alt.; W/22" Fan Clutch	E0TE 8A615 EA	②♠◆9447HD	Hose - Upper		≈21936
Belt - Fan & Alt.; W/40A., 60A. Alt.; W/O 22" Fan Clutch	D2TE 8A615 CA	②♠9440HD		or	26512
Belt - Fan & Alt.; W/40A., 60A. Alt.; W/Fixed Fan	D2TE 8620 AEA	②♠◆9451HD	Hose - Lower - Eng. To Pipe		21969
Belt - Fan & Alt.; W/75A. Alt.; W/22" Fan Clutch	E0TE 8A615 FA	②♠9455HD	Hose - Lower - Pipe To Rad.; W/Auto. Trans.		21368
Belt - Fan & Alt.; W/75A. Alt.; W/O 22" Fan Clutch	D9TE 8A615 AA	②♠◆9447HD	Hose - Lower - Pipe To Rad.; W/Man. Trans.		≈20452
Belt - Fan & Alt.; W/75A. Alt.; W/Fixed Fan	D2TE 8A615 VA	②♠◆9463HD	Hose - By Pass		≈21942
Belt - Fan & Alt.; W/90A. Alt.; W/22" Fan Clutch	E2TE 8A615 AA	②♠◆9463HD	Hose - Heater		24216
Belt - Fan & Alt.; W/90A. Alt.; W/O 22" Fan Clutch	D2TE 8A615 MA	②♠◆9451HD	1986		
Belt - Fan & Alt.; W/90A. Alt.; W/Fixed Fan	D2TE 8A615 BA	②♠9465HD	Caterpillar 3208 Diesel		
Belt - Fan & Alt.; W/105A., 130A. Alt.; W/22" Fan Clutch ..		②♠9465HD	B7000		
Belt - Fan & Alt.; W/105A., 130A. Alt.; W/O 22" Fan Clutch		②♠9455HD	Belt - Fan & P.S.	D3HA 8620 CA	②♠◆9670HD
Belt - Fan & Alt.; W/105A., 130A. Alt.; W/Fixed Fan	D2TE 8A615 VA	②♠◆9463HD	Belt - W.P. & Alt.; W/Motorola 130A. Alt.		②♠◆9610HD
Belt - Fan & P.S.; W/Single A.P.; W/Fan Clutch		②♠◆9530HD	Belt - W.P. & Alt.; W/O Motorola 130A. Alt.		♠9570HD
Belt - Fan & P.S.; W/22" Fan Clutch		♠9565HD	Belt - P.S.	D7HT 8620 LA	♠9375HD
Belt - Fan & P.S.; W/O Fan Clutch		♠9530HD	Belt - Air Brake Compr.	D5HA 8620 GA	♠9580HD
Belt - Fan, P.S. & A.P.		②♠◆9650HD	Belt - A.C.; W/42 7/8" Belt O.C.	E4HT 8620 GB	♠9425HD
Belt - Fan, A.P. & Air Brake Compr.		♠9640HD	Belt - A.C.; W/53 3/8" Belt O.C.		♠9530HD
Belt - Fan, A.P. & Hyd. Brake Boost Pump .	E0TE 8620 KA	♠9610HD	Belt - Hyd. Brake Boost Pump	C8HA 8620 A	♠9560HD
Belt - A.C.		♠9330HD	Belt - V.P.	D0HA 8620 U	♠9550HD
Belt - A.P.; W/Fan Clutch	D4TE 8620 AA	♠9385HD	Hose - Upper		21569
Belt - A.P.; W/O Fan Clutch	D2TE 8620 BNA	♠9370HD	Hose - Lower		21562
Hose - Upper; W/Auto. Trans.		≈21936	Hose - Oil Cooler - Front Inlet		21824
	or	26512	Hose - Oil Cooler - Rear Inlet		21381
Hose - Upper; W/Man. Trans.		21305	Hose - Oil Cooler Outlet		21380
	or	26512	Hose - Heater		28441
Hose - Lower - Eng. To Pipe		21969	Detroit Diesel V-8 8.2 L Diesel		
Hose - Lower - Pipe To Rad.; W/Auto. Trans.		21368	B600; B700		
			Belt - Fan & Alt.; W/O A.C.; W/40A., 60A. Alt.	E1HZ 8620 A	②♠◆9660HD

♠Standard Belt Available.
◆PowerBand Belt May Work, Use Template to Check.

②Two Required.
≈Cut to Fit.

Belts and Coolant Hose for School Buses

School Buses

Application	Mfr. Part No.	Our No.	Application	Mfr. Part No.	Our No.
Ford - Continued			Ford - Continued		
1986 - Continued			1986 - Continued		
Detroit Diesel V-8 8.2 L Diesel - Continued			Ford V-8 7.0 L - Continued		
B600; B700 - Continued			B700 - Continued		
Belt - Fan & Alt.; W/O A.C.; W/70A., 90A. Alt. E1HZ 8620 B		②◆◆9670HD	Belt - Fan & Alt.; W/40A., 60A. Alt.; W/O 22" Fan Clutch	D2TE 8A615 CA	②◆9440HD
Belt - Fan & Alt.; W/A.C.; W/105A., 130A. Alt.		②◆◆9670HD	Belt - Fan & Alt.; W/40A., 60A. Alt.; W/Fixed Fan	D2TE 8620 AEA	②◆◆9451HD
Belt - P.S.; W/5500 Lb. Axle		②◆9395HD	Belt - Fan & Alt.; W/75A. Alt.; W/22" Fan Clutch	E0TE 8A615 FA	②◆9455HD
Belt - P.S.; W/O 5500 Lb. Axle	E0HT 8620 DA	②◆◆9430HD	Belt - Fan & Alt.; W/75A. Alt.; W/O 22" Fan Clutch	D9TE 8A615 AA	②◆◆9447HD
Belt - Air Brake Compr.; W/70 1/4" Belt O.C.		◆9700HD	Belt - Fan & Alt.; W/75A. Alt.; W/Fixed Fan ..	D2TE 8A615 VA	②◆◆9463HD
Belt - Air Brake Compr.; W/71 1/4" Belt O.C.		◆9710HD	Belt - Fan & Alt.; W/90A. Alt.; W/22" Fan Clutch	E2TE 8A615 AA	②◆◆9463HD
Belt - A.C.	E0HZ 8620 R	◆9720HD	Belt - Fan & Alt.; W/90A. Alt.; W/O 22" Fan Clutch	D2TE 8A615 MA	②◆◆9451HD
Belt - Hyd. Brake Boost Pump; W/69 1/4" Belt O.C.		◆9680HD	Belt - Fan & Alt.; W/90A. Alt.; W/Fixed Fan ..	D2TE 8A615 BA	②◆9465HD
Belt - Hyd. Brake Boost Pump; W/70 1/4" Belt O.C.		◆9700HD	Belt - Fan & Alt.; W/105A., 130A. Alt.; W/22" Fan Clutch ..		②◆9465HD
Belt - V.P.; W/High Mount V.P.	D9PZ 8620 B	◆9435HD	Belt - Fan & Alt.; W/105A., 130A. Alt.; W/O 22" Fan Clutch		②◆9455HD
Belt - V.P.; W/Low Mount V.P.	E0HZ 8620 S	◆9680HD	Belt - Fan & Alt.; W/105A., 130A. Alt.; W/Fixed Fan	D2TE 8A615 VA	②◆◆9463HD
Hose - Upper; W/A.C.		21470	Belt - Fan & P.S.; W/Single A.P.; W/Fan Clutch		②◆◆9530HD
Hose - Upper; W/O A.C.		≈21470	Belt - Fan & P.S.; W/22" Fan Clutch		◆9565HD
Hose - Lower - Eng. To Pipe		21363	Belt - Fan & P.S.; W/O Fan Clutch		◆9530HD
Hose - Lower - Pipe To Rad		21307	Belt - Fan, P.S. & A.P.		②◆◆9650HD
Hose - By Pass - Left Side		24222	Belt - Fan, A.P. & Air Brake Compr.		◆9640HD
Hose - By Pass - Right Side		21457	Belt - Fan, A.P. & Hyd. Brake Boost Pump .	E0TE 8620 KA	◆9610HD
Hose - Oil Cooler		③28443	Belt - A.C.		◆9330HD
Hose - Heater		28441	Belt - A.P.; W/Fan Clutch	D4TE 8620 AA	◆9385HD
			Belt - A.P.; W/O Fan Clutch	D2TE 8620 BNA	◆9370HD
			Hose - Upper		≈21936
				or	26512
			Hose - Lower - Eng. To Pipe		21969
			Hose - Lower - Pipe To Rad.; W/Auto. Trans.		21368
			Hose - Lower - Pipe To Rad.; W/Man. Trans.		≈20452
			Hose - By Pass		≈21942
			Hose - Heater		24216
Ford V-8 6.1 L			1985		
B600; B700			Caterpillar 3208 Diesel		
Belt - Fan & Alt.; W/40A., 60A. Alt.; W/22" Fan Clutch	E0TE 8A615 EA	②◆◆9447HD	B7000		
Belt - Fan & Alt.; W/40A., 60A. Alt.; W/O 22" Fan Clutch	D2TE 8A615 CA	②◆9440HD	Belt - Fan & P.S.	D3HA 8620 CA	②◆◆9670HD
Belt - Fan & Alt.; W/40A., 60A. Alt.; W/Fixed Fan	D2TE 8620 AEA	②◆◆9451HD	Belt - W.P. & Alt.; W/Motorola 130A. Alt.		②◆◆9610HD
Belt - Fan & Alt.; W/75A. Alt.; W/22" Fan Clutch	E0TE 8A615 FA	②◆9455HD	Belt - W.P. & Alt.; W/O Motorola 130A. Alt.		◆9570HD
Belt - Fan & Alt.; W/75A. Alt.; W/O 22" Fan Clutch	D9TE 8A615 AA	②◆◆9447HD	Belt - P.S.	D7HT 8620 LA	◆9375HD
Belt - Fan & Alt.; W/75A. Alt.; W/Fixed Fan ..	D2TE 8A615 VA	②◆◆9463HD	Belt - Air Brake Compr.	D5HA 8620 GA	◆9580HD
Belt - Fan & Alt.; W/90A. Alt.; W/22" Fan Clutch	E2TE 8A615 AA	②◆◆9463HD	Belt - A.C.; W/42 7/8" Belt O.C.	E4HT 8620 GB	◆9425HD
Belt - Fan & Alt.; W/90A. Alt.; W/O 22" Fan Clutch	D2TE 8A615 MA	②◆◆9451HD	Belt - A.C.; W/53 3/8" Belt O.C.		◆9530HD
Belt - Fan & Alt.; W/90A. Alt.; W/Fixed Fan ..	D2TE 8A615 BA	②◆9465HD	Belt - Hyd. Brake Boost Pump	C8HA 8620 A	◆9560HD
Belt - Fan & Alt.; W/105A., 130A. Alt.; W/22" Fan Clutch ..		②◆9465HD	Belt - V.P.	DOHA 8620 U	◆9550HD
Belt - Fan & Alt.; W/105A., 130A. Alt.; W/O 22" Fan Clutch		②◆9455HD	Hose - Upper		21569
Belt - Fan & Alt.; W/105A., 130A. Alt.; W/Fixed Fan	D2TE 8A615 VA	②◆◆9463HD	Hose - Lower		21562
Belt - Fan & P.S.; W/Single A.P.; W/Fan Clutch		②◆◆9530HD	Hose - Oil Cooler - Front Inlet		21824
Belt - Fan & P.S.; W/22" Fan Clutch		◆9565HD	Hose - Oil Cooler - Rear Inlet		21381
Belt - Fan & P.S.; W/O Fan Clutch		◆9530HD	Hose - Oil Cooler Outlet		21380
Belt - Fan, P.S. & A.P.		②◆◆9650HD	Hose - Heater		28441
Belt - Fan, A.P. & Air Brake Compr.		◆9640HD			
Belt - Fan, A.P. & Hyd. Brake Boost Pump .	E0TE 8620 KA	◆9610HD	Detroit Diesel V-8 8.2 L Diesel		
Belt - A.C.		◆9330HD	B600; B700		
Belt - A.P.; W/Fan Clutch	D4TE 8620 AA	◆9385HD	Belt - Fan & Alt.; W/O A.C.; W/40A., 60A. Alt.	E1HZ 8620 A	②◆◆9660HD
Belt - A.P.; W/O Fan Clutch	D2TE 8620 BNA	◆9370HD	Belt - Fan & Alt.; W/70A., 90A. Alt.	E1HZ 8620 B	②◆◆9670HD
Hose - Upper; W/Auto. Trans.		≈21936	Belt - Fan & Alt.; W/105A., 130A. Alt.		②◆◆9670HD
	or	26512	Belt - P.S.; W/5500 Lb. Axle		②◆9395HD
Hose - Upper; W/Man. Trans.		21305	Belt - P.S.; W/O 5500 Lb. Axle		②◆9425HD
	or	26512	Belt - Air Brake Compr.; W/70 1/4" Belt O.C.		◆9700HD
Hose - Lower - Eng. To Pipe		21969	Belt - Air Brake Compr.; W/72 1/4" Belt O.C.	E0HT 8620 LA	◆9720HD
Hose - Lower - Pipe To Rad.; W/Auto. Trans.		21368	Belt - A.C.	E0HZ 8620 R	◆9720HD
Hose - Lower - Pipe To Rad.; W/Man. Trans.		≈20452			
Hose - By Pass		≈21942			
Hose - Heater		24216			
Ford V-8 7.0 L					
B700					
Belt - Fan & Alt.; W/40A., 60A. Alt.; W/22" Fan Clutch	E0TE 8A615 EA	②◆◆9447HD			

◆Standard Belt Available.
②Two Required.
③Three Required.

◆PowerBand Belt May Work, Use Template to Check.
≈Cut to Fit.

Belts and Coolant Hose for School Buses

Application	Mfr. Part No.	Our No.	Application	Mfr. Part No.	Our No.
Ford - Continued			Ford - Continued		
1985 - Continued			1985 - Continued		
Detroit Diesel V-8 8.2 L Diesel - Continued			Ford V-8 7.0 L - Continued		
B600; B700 - Continued			B700 - Continued		
Belt - Hyd. Brake Boost Pump; W/69 1/4" Belt O.C.		▲9680HD	Belt - Fan & Alt.; W/90A. Alt.; W/22" Fan Clutch	E2TE 8A615 AA	②▲◆9463HD
Belt - Hyd. Brake Boost Pump; W/70 1/4" Belt O.C.		▲9700HD	Belt - Fan & Alt.; W/90A. Alt.; W/O 22" Fan Clutch	D2TE 8A615 MA	②▲◆9451HD
Belt - V.P.; W/High Mount V.P.	D9PZ 8620 B	▲9435HD	Belt - Fan & Alt.; W/90A. Alt.; W/Fixed Fan . D2TE 8A615 BA		②▲9465HD
Belt - V.P.; W/Low Mount V.P.	E0HZ 8620 S	▲9680HD	Belt - Fan & Alt.; W/105A., 130A. Alt.; W/22" Fan Clutch ..		②▲9465HD
Hose - Upper; W/A.C.		21470	Belt - Fan & Alt.; W/105A., 130A. Alt.; W/O 22" Fan Clutch		②▲9455HD
Hose - Upper; W/O A.C.		≈21470	Belt - Fan & Alt.; W/105A., 130A. Alt.; W/Fixed Fan	D2TE 8A615 VA	②▲◆9463HD
Hose - Lower - Eng. To Pipe		21363	Belt - Fan & P.S.; W/Single A.P.; W/Fan Clutch		②▲◆9530HD
Hose - Lower - Pipe To Rad.		21307	Belt - Fan & P.S.; W/22" Fan Clutch		▲9565HD
Hose - By Pass - Left Side		24222	Belt - Fan & P.S.; W/O Fan Clutch		▲9530HD
Hose - By Pass - Right Side		21457	Belt - Fan, P.S. & A.P.		②▲◆9650HD
Hose - Oil Cooler		③28443	Belt - Fan, A.P. & Air Brake Compr.		▲9640HD
Hose - Heater		28441	Belt - Fan, A.P. & Hyd. Brake Boost Pump . E0TE 8620 KA		▲9610HD
Ford V-8 6.1 L			Belt - A.C.		
B600; B700			▲9330HD		
Belt - Fan & Alt.; W/40A., 60A. Alt.; W/22" Fan Clutch	E0TE 8A615 EA	②▲◆9447HD	Belt - A.P.; W/Fan Clutch	D4TE 8620 AA	▲9385HD
Belt - Fan & Alt.; W/40A., 60A. Alt.; W/O 22" Fan Clutch	D2TE 8A615 CA	②▲9440HD	Belt - A.P.; W/O Fan Clutch	D2TE 8620 BNA	▲9370HD
Belt - Fan & Alt.; W/40A., 60A. Alt.; W/Fixed Fan	D2TE 8620 AEA	②▲◆9451HD	Hose - Upper		≈21936
Belt - Fan & Alt.; W/75A. Alt.; W/22" Fan Clutch	E0TE 8A615 FA	②▲9455HD		or	26512
Belt - Fan & Alt.; W/75A. Alt.; W/O 22" Fan Clutch	D9TE 8A615 AA	②▲◆9447HD	Hose - Lower - Eng. To Pipe		21969
Belt - Fan & Alt.; W/75A. Alt.; W/Fixed Fan . D2TE 8A615 VA		②▲◆9463HD	Hose - Lower - Pipe To Rad.; W/Auto. Trans.		21368
Belt - Fan & Alt.; W/90A. Alt.; W/22" Fan Clutch	E2TE 8A615 AA	②▲◆9463HD	Hose - Lower - Pipe To Rad.; W/Man. Trans.		≈20452
Belt - Fan & Alt.; W/90A. Alt.; W/O 22" Fan Clutch	D2TE 8A615 MA	②▲◆9451HD	Hose - By Pass		≈21942
Belt - Fan & Alt.; W/90A. Alt.; W/Fixed Fan . D2TE 8A615 BA		②▲9465HD	Hose - Heater		24216
Belt - Fan & Alt.; W/105A., 130A. Alt.; W/22" Fan Clutch ..		②▲9465HD	1984		
Belt - Fan & Alt.; W/105A., 130A. Alt.; W/O 22" Fan Clutch		②▲9455HD	Caterpillar 3208 Diesel		
Belt - Fan & Alt.; W/105A., 130A. Alt.; W/Fixed Fan	D2TE 8A615 VA	②▲◆9463HD	B7000		
Belt - Fan, P.S. & A.P.		②▲◆9650HD	Belt - Fan & P.S.	D3HA 8620 CA	②▲◆9670HD
Belt - Fan, A.P. & Air Brake Compr.		▲9640HD	Belt - W.P. & Alt.; W/Motorola 130A. Alt.		②▲◆9610HD
Belt - Fan, A.P. & Hyd. Brake Boost Pump . E0TE 8620 KA		▲9610HD	Belt - W.P. & Alt.; W/O Motorola 130A. Alt.		▲9570HD
Belt - A.C.		▲9330HD	Belt - P.S.	D7HT 8620 LA	▲9375HD
Belt - A.P.; W/Fan Clutch	D4TE 8620 AA	▲9385HD	Belt - Air Brake Compr.	D5HA 8620 GA	▲9580HD
Belt - A.P.; W/O Fan Clutch	D2TE 8620 BNA	▲9370HD	Belt - A.C.; W/42 7/8" Belt O.C.	E4HT 8620 GB	▲9425HD
Hose - Upper; W/Auto. Trans.		≈21936	Belt - A.C.; W/53 3/8" Belt O.C.		▲9530HD
	or	26512	Belt - Hyd. Brake Boost Pump	C8HA 8620 A	▲9560HD
Hose - Upper; W/Man. Trans.		21305	Belt - V.P.	D0HA 8620 U	▲9550HD
	or	26512	Hose - Upper		21569
Hose - Lower - Eng. To Pipe		21969	Hose - Lower		21562
Hose - Lower - Pipe To Rad.; W/Auto. Trans.		21368	Hose - Oil Cooler - Front Inlet		21824
Hose - Lower - Pipe To Rad.; W/Man. Trans.		≈20452	Hose - Oil Cooler - Rear Inlet		21381
Hose - By Pass		≈21942	Hose - Oil Cooler Outlet		21380
Hose - Heater		24216	Hose - Heater		28441
Ford V-8 7.0 L			Detroit Diesel V-8 8.2 L Diesel		
B700			B600; B700		
Belt - Fan & Alt.; W/40A., 60A. Alt.; W/22" Fan Clutch	E0TE 8A615 EA	②▲◆9447HD	Belt - Fan & Alt.; W/O A.C.; W/40A., 60A. Alt.	E1HZ 8620 A	②▲◆9660HD
Belt - Fan & Alt.; W/40A., 60A. Alt.; W/O 22" Fan Clutch	D2TE 8A615 CA	②▲9440HD	Belt - Fan & Alt.; W/70A., 90A. Alt.	E1HZ 8620 B	②▲◆9670HD
Belt - Fan & Alt.; W/40A., 60A. Alt.; W/Fixed Fan	D2TE 8620 AEA	②▲◆9451HD	Belt - Fan & Alt.; W/105A., 130A. Alt.; Aug. 1984 & Older	E0HZ 8620 P	②▲9680HD
Belt - Fan & Alt.; W/75A. Alt.; W/22" Fan Clutch	E0TE 8A615 FA	②▲9455HD	Belt - Fan & Alt.; W/105A., 130A. Alt.; Sept. 1984 & Newer		②▲◆9670HD
Belt - Fan & Alt.; W/75A. Alt.; W/O 22" Fan Clutch	D9TE 8A615 AA	②▲◆9447HD	Belt - P.S.; W/5500 Lb. Axle		②▲9395HD
Belt - Fan & Alt.; W/75A. Alt.; W/Fixed Fan . D2TE 8A615 VA		②▲◆9463HD	Belt - P.S.; W/O 5500 Lb. Axle		②▲9425HD
▲Standard Belt Available.			Belt - Air Brake Compr.; W/70 1/4" Belt O.C.		
③Three Required.			▲9700HD		
②Two Required.			Belt - Air Brake Compr.; W/72 1/4" Belt O.C.		
			E0HT 8620 LA		
			▲9720HD		
			Belt - A.C.		
			E0HZ 8620 R		
			▲9720HD		
			Belt - Hyd. Brake Boost Pump; W/69 1/4" Belt O.C.		
			▲9680HD		
			Belt - Hyd. Brake Boost Pump; W/70 1/4" Belt O.C.		
			▲9700HD		
			Belt - V.P.; W/High Mount V.P.		
			D9PZ 8620 B		
			▲9435HD		
			Belt - V.P.; W/Low Mount V.P.		
			E0HZ 8620 S		
			▲9680HD		
			Hose - Upper; W/A.C.		
			21470		

▲Standard Belt Available.
 ③Three Required.
 ②Two Required.

≈Cut to Fit.
 ◆PowerBand Belt May Work, Use Template to Check.

School Buses

Belts and Coolant Hose for School Buses

School Buses

Application	Mfr. Part No.	Our No.
Ford - Continued		
1984 - Continued		
Detroit Diesel V-8 8.2 L Diesel - Continued		
B600; B700 - Continued		
Hose - Upper; W/O A.C.		≈21470
Hose - Lower - Eng. To Pipe		21363
Hose - Lower - Pipe To Rad.		21307
Hose - By Pass - Left Side		24222
Hose - By Pass - Right Side		21457
Hose - Oil Cooler	③28443	
Hose - Heater		28441
Ford V-8 6.1 L		
B600; B700		
Belt - Fan & Alt.; W/40A., 60A. Alt.; W/22" Fan Clutch	E0TE 8A615 EA	②◆◆9447HD
Belt - Fan & Alt.; W/40A., 60A. Alt.; W/O 22" Fan Clutch	D2TE 8A615 CA	②◆9440HD
Belt - Fan & Alt.; W/40A., 60A. Alt.; W/Fixed Fan	D2TE 8620 AEA	②◆◆9451HD
Belt - Fan & Alt.; W/75A. Alt.; W/22" Fan Clutch	E0TE 8A615 FA	②◆9455HD
Belt - Fan & Alt.; W/75A. Alt.; W/O 22" Fan Clutch	D9TE 8A615 AA	②◆◆9447HD
Belt - Fan & Alt.; W/75A. Alt.; W/Fixed Fan	D2TE 8A615 VA	②◆◆9463HD
Belt - Fan & Alt.; W/90A. Alt.; W/22" Fan Clutch	E2TE 8A615 AA	②◆◆9463HD
Belt - Fan & Alt.; W/90A. Alt.; W/O 22" Fan Clutch	D2TE 8A615 MA	②◆◆9451HD
Belt - Fan & Alt.; W/90A. Alt.; W/Fixed Fan	D2TE 8A615 BA	②◆9465HD
Belt - Fan & Alt.; W/105A., 130A. Alt.; W/22" Fan Clutch ..		②◆9465HD
Belt - Fan & Alt.; W/105A., 130A. Alt.; W/O 22" Fan Clutch		②◆9455HD
Belt - Fan & Alt.; W/105A., 130A. Alt.; W/Fixed Fan	D2TE 8A615 VA	②◆◆9463HD
Belt - Fan & P.S.; W/Single A.P.; W/Fan Clutch		②◆◆9530HD
Belt - Fan & P.S.; W/22" Fan Clutch		◆9565HD
Belt - Fan & P.S.; W/O Fan Clutch		◆9530HD
Belt - Fan, P.S. & A.P.		②◆◆9650HD
Belt - Fan, A.P. & Air Brake Compr.		◆9640HD
Belt - Fan, A.P. & Hyd. Brake Boost Pump . E0TE 8620 KA		◆9610HD
Belt - A.C.		◆9330HD
Belt - A.P.; W/Fan Clutch	D4TE 8620 AA	◆9385HD
Belt - A.P.; W/O Fan Clutch	D2TE 8620 BNA	◆9370HD
Hose - Upper; W/Auto. Trans.		≈21936
	or	26512
Hose - Upper; W/Man. Trans.		21305
	or	26512
Hose - Lower - Eng. To Pipe		21969
Hose - Lower - Pipe To Rad.; W/Auto. Trans.		21368
Hose - Lower - Pipe To Rad.; W/Man. Trans.		≈20452
Hose - By Pass		≈21942
Hose - Heater		24216
Ford V-8 7.0 L		
B700		
Belt - Fan & Alt.; W/40A., 60A. Alt.; W/22" Fan Clutch	E0TE 8A615 EA	②◆◆9447HD
Belt - Fan & Alt.; W/40A., 60A. Alt.; W/O 22" Fan Clutch	D2TE 8A615 CA	②◆9440HD
Belt - Fan & Alt.; W/40A., 60A. Alt.; W/Fixed Fan	D2TE 8620 AEA	②◆◆9451HD
Belt - Fan & Alt.; W/75A. Alt.; W/22" Fan Clutch	E0TE 8A615 FA	②◆9455HD
Belt - Fan & Alt.; W/75A. Alt.; W/O 22" Fan Clutch	D9TE 8A615 AA	②◆◆9447HD
Belt - Fan & Alt.; W/75A. Alt.; W/Fixed Fan	D2TE 8A615 VA	②◆◆9463HD
Belt - Fan & Alt.; W/90A. Alt.; W/22" Fan Clutch	E2TE 8A615 AA	②◆◆9463HD
Belt - Fan & Alt.; W/90A. Alt.; W/O 22" Fan Clutch	D2TE 8A615 MA	②◆◆9451HD
Belt - Fan & Alt.; W/90A. Alt.; W/Fixed Fan	D2TE 8A615 BA	②◆9465HD

③Three Required.
◆PowerBand Belt May Work, Use Template to Check.
≈Cut to Fit.

Application	Mfr. Part No.	Our No.
Ford - Continued		
1984 - Continued		
Ford V-8 7.0 L - Continued		
B700 - Continued		
Belt - Fan & Alt.; W/105A., 130A. Alt.; W/22" Fan Clutch ..		②◆9465HD
Belt - Fan & Alt.; W/105A., 130A. Alt.; W/O 22" Fan Clutch		②◆9455HD
Belt - Fan & Alt.; W/105A., 130A. Alt.; W/Fixed Fan	D2TE 8A615 VA	②◆◆9463HD
Belt - Fan & P.S.; W/Single A.P.; W/Fan Clutch		②◆◆9530HD
Belt - Fan & P.S.; W/22" Fan Clutch		◆9565HD
Belt - Fan & P.S.; W/O Fan Clutch		◆9530HD
Belt - Fan, P.S. & A.P.		②◆◆9650HD
Belt - Fan, A.P. & Air Brake Compr.		◆9640HD
Belt - Fan, A.P. & Hyd. Brake Boost Pump . E0TE 8620 KA		◆9610HD
Belt - A.C.		◆9330HD
Belt - A.P.; W/Fan Clutch	D4TE 8620 AA	◆9385HD
Belt - A.P.; W/O Fan Clutch	D2TE 8620 BNA	◆9370HD
Hose - Upper		≈21936
	or	26512
Hose - Lower - Eng. To Pipe		21969
Hose - Lower - Pipe To Rad.; W/Auto. Trans.		21368
Hose - Lower - Pipe To Rad.; W/Man. Trans.		≈20452
Hose - By Pass		≈21942
Hose - Heater		24216
1983		
Caterpillar 3208 Diesel		
B7000		
Belt - Fan & P.S.; Apr. 1983 & Older		②◆◆9650HD
Belt - Fan & P.S.; May 1983 & Newer	D3HA 8620 CA	②◆◆9670HD
Belt - W.P. & Alt.; W/Motorola 130A. Alt.		②◆◆9610HD
Belt - W.P. & Alt.; W/O Motorola 130A. Alt.		◆9570HD
Belt - P.S.	D7HT 8620 LA	◆9375HD
Belt - Air Brake Compr.	D5HA 8620 GA	◆9580HD
Belt - A.C.; W/42 7/8" Belt O.C.	E4HT 8620 GB	◆9425HD
Belt - A.C.; W/53 3/8" Belt O.C.		◆9530HD
Belt - Hyd. Brake Boost Pump	C8HA 8620 A	◆9560HD
Belt - V.P.	DOHA 8620 U	◆9550HD
Hose - Upper		21569
Hose - Lower		21562
Hose - Oil Cooler - Front Inlet		21824
Hose - Oil Cooler - Rear Inlet		21381
Hose - Oil Cooler Outlet		21380
Hose - Heater		28441
Detroit Diesel V-8 8.2 L Diesel		
B600; B700		
Belt - Fan & Alt.; W/O A.C.; W/40A., 60A. Alt.	E1HZ 8620 A	②◆◆9660HD
Belt - Fan & Alt.; W/70A., 90A. Alt.	E1HZ 8620 B	②◆◆9670HD
Belt - Fan & Alt.; W/105A., 130A. Alt.	E0HZ 8620 P	②◆9680HD
Belt - P.S.; W/5500 Lb. Axle		②◆9395HD
Belt - P.S.; W/O 5500 Lb. Axle		②◆9425HD
Belt - Air Brake Compr.; W/70 1/4" Belt O.C.		◆9700HD
Belt - Air Brake Compr.; W/71 1/4" Belt O.C.		◆9710HD
Belt - Air Brake Compr.; W/72 1/4" Belt O.C.	E0HT 8620 LA	◆9720HD
Belt - A.C.	E0HZ 8620 R	◆9720HD
Belt - Hyd. Brake Boost Pump; W/69 1/4" Belt O.C.		◆9680HD
Belt - Hyd. Brake Boost Pump; W/70 1/4" Belt O.C.		◆9700HD
Belt - V.P.; W/High Mount V.P.	D9PZ 8620 B	◆9435HD
Belt - V.P.; W/Low Mount V.P.	E0HZ 8620 S	◆9680HD
Hose - Upper; W/A.C.		21470
Hose - Upper; W/O A.C.		≈21470
Hose - Lower - Eng. To Pipe		21363
Hose - Lower - Pipe To Rad.		21307
Hose - By Pass - Left Side		24222
Hose - By Pass - Right Side		21457
Hose - Oil Cooler		③28443

◆Standard Belt Available.
②Two Required.

Belts and Coolant Hose for School Buses

Application	Mfr. Part No.	Our No.	Application	Mfr. Part No.	Our No.
Ford - Continued			Ford - Continued		
1983 - Continued			1982 - 1981 - Continued		
Detroit Diesel V-8 8.2 L Diesel - Continued			Detroit Diesel V-8 8.2 L Diesel - Continued		
B600; B700 - Continued			B600; B700 - Continued		
Hose - Heater		28441	Belt - A.C.	E0HZ 8620 R	▲9720HD
Ford V-8 6.1 L			Belt - Hyd. Brake Boost Pump		▲9700HD
B600; B700			Belt - V.P.; W/High Mount V.P.	D9PZ 8620 B	▲9435HD
Belt - Fan & Alt.; W/40A., 60A. Alt.; W/22" Fan	D2AE 8620 CAA	②▲◆9447HD	Belt - V.P.; W/Low Mount V.P.	E0HZ 8620 S	▲9680HD
Belt - Fan & Alt.; W/40A., 60A. Alt.; W/O 22" Fan Clutch ..		②▲◆9435HD	Hose - Upper		21469
Belt - Fan & Alt.; W/70A., 90A. Alt.; W/22" Fan	D2DE 8620 GA	②▲9455HD	or		26512
Belt - Fan & Alt.; W/70A., 90A. Alt.; W/O 22" Fan Clutch ..		②▲◆9447HD	Hose - Lower - Eng. To Pipe		21363
Belt - Fan & Alt.; W/105A., 130A. Alt.		②▲◆9463HD	Hose - Lower - Pipe To Rad.		21307
Belt - Fan & P.S.	D2ZE 8620 AHA	▲9525HD	Hose - By Pass - Left Side		24222
Belt - Fan & A.P.; W/O Air Brakes		▲9720HD	Hose - By Pass - Right Side		21457
Belt - A.C.		▲9330HD	Hose - Oil Cooler		③28443
Belt - Air Brake Compr. & A.P.; W/7 1/4 Cu. Ft. Air Brake Compr.	E0TE 8620 MA	▲9650HD	Hose - Heater		28441
Belt - Air Brake Compr. & A.P.; W/12 Cu. Ft. Air Brake Compr.	D9TE 8620 CB	▲9640HD	Ford V-8 6.1 L		
Belt - Hyd. Brake Boost Pump & A.P.	E0TE 8620 KA	▲9610HD	B600; B700		
Belt - A.P.; W/Fan Clutch	C9PZ 8620 BH	▲9370HD	Belt - Fan & Alt.; W/40A., 60A. Alt.; W/22" Fan	D2AE 8620 CAA	②▲◆9447HD
Belt - A.P.; W/O Fan Clutch	D7PZ 8620 P	▲9390HD	Belt - Fan & Alt.; W/40A., 60A. Alt.; W/O 22" Fan Clutch ..		②▲◆9435HD
Hose - Upper; W/Auto. Trans.		≈21936	Belt - Fan & Alt.; W/70A., 90A. Alt.; W/22" Fan	D2DE 8620 GA	②▲9455HD
or		26512	Belt - Fan & Alt.; W/70A., 90A. Alt.; W/O 22" Fan Clutch ..		②▲◆9447HD
Hose - Upper; W/Man. Trans.		21305	Belt - Fan & Alt.; W/105A., 130A. Alt.		②▲◆9463HD
or		26512	Belt - Fan & P.S.	D2ZE 8620 AHA	▲9525HD
Hose - Lower - Eng. To Pipe		21969	Belt - Fan & A.P.; W/O Air Brakes		▲9720HD
Hose - Lower - Pipe To Rad.; W/Auto. Trans.		21368	Belt - A.C.		▲9330HD
Hose - Lower - Pipe To Rad.; W/Man. Trans.		≈20452	Belt - Air Brake Compr. & A.P.; W/7 1/4 Cu. Ft. Air Brake Compr.	E0TE 8620 MA	▲9650HD
Hose - By Pass		≈21942	Belt - Air Brake Compr. & A.P.; W/12 Cu. Ft. Air Brake Compr.	D9TE 8620 CB	▲9640HD
Hose - Heater		24216	Belt - Hyd. Brake Boost Pump & A.P.	E0TE 8620 KA	▲9610HD
Ford V-8 7.0 L			Belt - A.P.; W/Fan Clutch	C9PZ 8620 BH	▲9370HD
B700			Belt - A.P.; W/O Fan Clutch	D7PZ 8620 P	▲9390HD
Belt - Fan & Alt.; W/40A., 60A. Alt.; W/22" Fan Clutch	D2AE 8620 CAA	②▲◆9447HD	Hose - Upper; W/Auto. Trans.		≈21936
Belt - Fan & Alt.; W/40A., 60A. Alt.; W/O 22" Fan Clutch ..		②▲◆9435HD	or		26512
Belt - Fan & Alt.; W/70A., 90A. Alt.; W/22" Fan Clutch	D2DE 8620 GA	②▲9455HD	Hose - Upper; W/Man. Trans.		21305
Belt - Fan & Alt.; W/70A., 90A. Alt.; W/O 22" Fan Clutch ..		②▲◆9447HD	or		26512
Belt - Fan & Alt.; W/105A., 130A. Alt.		②▲◆9463HD	Hose - Lower - Eng. To Pipe		21969
Belt - Fan & P.S.	D2ZE 8620 AHA	▲9525HD	Hose - Lower - Pipe To Rad.; W/Auto. Trans.		21368
Belt - Fan & A.P.; W/O Air Brakes		▲9720HD	Hose - Lower - Pipe To Rad.; W/Man. Trans.		≈20452
Belt - A.C.		▲9330HD	Hose - By Pass		≈21942
Belt - Air Brake Compr. & A.P.; W/7 1/4 Cu. Ft. Air Brake Compr.	E0TE 8620 MA	▲9650HD	Hose - Heater		24216
Belt - Air Brake Compr. & A.P.; W/12 Cu. Ft. Air Brake Compr.	D9TE 8620 CB	▲9640HD	Ford V-8 7.0 L		
Belt - Hyd. Brake Boost Pump & A.P.	E0TE 8620 KA	▲9610HD	B700		
Belt - A.P.; W/Fan Clutch	C9PZ 8620 BH	▲9370HD	Belt - Fan & Alt.; W/40A., 60A. Alt.; W/22" Fan Clutch	D2AE 8620 CAA	②▲◆9447HD
Belt - A.P.; W/O Fan Clutch	D7PZ 8620 P	▲9390HD	Belt - Fan & Alt.; W/40A., 60A. Alt.; W/O 22" Fan Clutch ..		②▲◆9435HD
Hose - Upper		≈21936	Belt - Fan & Alt.; W/70A., 90A. Alt.; W/22" Fan	D2DE 8620 GA	②▲9455HD
or		26512	Belt - Fan & Alt.; W/70A., 90A. Alt.; W/O 22" Fan Clutch ..		②▲◆9447HD
Hose - Lower - Eng. To Pipe		21969	Belt - Fan & Alt.; W/105A., 130A. Alt.		②▲◆9463HD
Hose - Lower - Pipe To Rad.; W/Auto. Trans.		21368	Belt - Fan & P.S.	D2ZE 8620 AHA	▲9525HD
Hose - Lower - Pipe To Rad.; W/Man. Trans.		≈20452	Belt - Fan & A.P.; W/O Air Brakes		▲9720HD
Hose - By Pass		≈21942	Belt - A.C.		▲9330HD
Hose - Heater		24216	Belt - Air Brake Compr. & A.P.; W/7 1/4 Cu. Ft. Air Brake Compr.	E0TE 8620 MA	▲9650HD
1982 - 1981			Belt - Air Brake Compr. & A.P.; W/12 Cu. Ft. Air Brake Compr.	D9TE 8620 CB	▲9640HD
Detroit Diesel V-8 8.2 L Diesel			Belt - Hyd. Brake Boost Pump & A.P.	E0TE 8620 KA	▲9610HD
B600; B700			Belt - A.P.; W/Fan Clutch	C9PZ 8620 BH	▲9370HD
Belt - Fan & Alt.; W/40A., 60A. Alt.	E1HZ 8620 A	②▲◆9660HD	Belt - A.P.; W/O Fan Clutch	D7PZ 8620 P	▲9390HD
Belt - Fan & Alt.; W/70A., 90A. Alt.	E1HZ 8620 B	②▲◆9670HD	Hose - Upper		≈21936
Belt - Fan & Alt.; W/105A., 130A. Alt.	E0HZ 8620 P	②▲9680HD	or		26512
Belt - P.S.; W/5500 Lb. Axle		②▲9395HD	Hose - Lower - Eng. To Pipe		21969
Belt - P.S.; W/O 5500 Lb. Axle		②▲9425HD	Hose - Lower - Pipe To Rad.; W/Auto. Trans.		21368
Belt - Air Brake Compr.		▲9700HD	Hose - Lower - Pipe To Rad.; W/Man. Trans.		≈20452
			Hose - By Pass		≈21942

▲Standard Belt Available.
 ②Two Required.
 ③Three Required.

◆PowerBand Belt May Work. Use Template to Check.
 ≈Cut to Fit.

School Buses

Belts and Coolant Hose for School Buses

Application	Mfr. Part No.	Our No.	Application	Mfr. Part No.	Our No.
Ford - Continued			Ford - Continued		
1982 - 1981 - Continued			1980 - Continued		
Ford V-8 7.0 L - Continued			Ford V-8 7.0 L - Continued		
B700 - Continued			B700 - Continued		
Hose - Heater		24216	Hose - Lower - Eng. To Pipe		21969
1980			Hose - Lower - Pipe To Rad.; W/Auto. Trans.		21368
Detroit Diesel V-8 8.2 L Diesel			Hose - Lower - Pipe To Rad.; W/Man. Trans.		≈20452
B600; B700			Hose - By Pass		≈21942
Belt - Fan & Alt.; W/40A., 60A. Alt.	E1HZ 8620 A	②◆◆9660HD	Hose - Heater		24216
Belt - Fan & Alt.; W/70A., 90A. Alt.	E1HZ 8620 B	②◆◆9670HD	1979		
Belt - Fan & Alt.; W/105A., 130A. Alt.	E0HZ 8620 P	②◆◆9680HD	Caterpillar 3208 Diesel		
Belt - P.S.; W/5500 Lb. Axle		②◆◆9395HD	B7000		
Belt - P.S.; W/O 5500 Lb. Axle		②◆◆9425HD	Belt - Fan & Alt.; W/42A., 55A., 61A., 70A. Alt.		②◆◆9610HD
Belt - Air Brake Compr.		◆9700HD	D0HA 8620 AA		②◆◆9610HD
Belt - A.C.	E0HZ 8620 R	◆9720HD	Belt - Fan & Alt.; W/65A. Alt.		②◆◆9620HD
Belt - Hyd. Brake Boost Pump		◆9700HD	Belt - Fan & Alt.; W/105A. Leece Neville Alt.		②◆◆9630HD
Belt - V.P.; W/High Mount V.P.	D9PZ 8620 B	◆9435HD	Belt - P.S.	D7HT 8620 LA	◆9375HD
Belt - V.P.; W/Low Mount V.P.	E0HZ 8620 S	◆9680HD	Belt - Air Brake Compr.	D0HA 8620 U	◆9550HD
Hose - Upper		21469	Belt - Hyd. Brake Boost Pump	D0HA 8620 U	◆9550HD
or		26512	Belt - V.P.	D0HA 8620 AG	◆9525HD
Hose - Lower - Eng. To Pipe		21363	Hose - Upper		≈21256
Hose - Lower - Pipe To Rad.		21307	Hose - Lower		≈21379
Hose - By Pass - Left Side		24222	Hose - Oil Cooler - Front Inlet		21824
Hose - By Pass - Right Side		21457	Hose - Oil Cooler - Rear Inlet		21381
Hose - Oil Cooler	③28443		Hose - Oil Cooler Outlet		21380
Hose - Heater	28441		Hose - Heater		28441
Ford V-8 6.1 L			Ford 6-Cyl. 300		
B600; B700			B600		
Belt - Fan & Alt.; W/40A., 60A. Alt.		②◆◆9435HD	Belt - Fan & Alt.; W/42A., 55A. Alt.	C9PZ 8620 V	②7417
Belt - Fan & Alt.; W/70A., 90A. Alt.		②◆◆9447HD	Belt - Fan & Alt.; W/70A. Alt.	C9PZ 8620 GJ	②7435
Belt - Fan & Alt.; W/105A., 130A. Alt.		②◆◆9455HD	Belt - A.P.	C9PZ 8620 BH	◆9370HD
Belt - Fan & P.S.	D2ZE 8620 AHA	◆9525HD	Belt - A.P.	D5PZ 8620 B	7381
Belt - Fan, A.P. & Air Brake Compr.		◆9640HD	Hose - Upper		≈20450
Belt - A.C.		◆9330HD	or		25476
Belt - A.P.; W/Fan Clutch		◆9370HD	Hose - Lower		20475
Belt - A.P.; W/O Fan Clutch		◆9385HD	or		26502
Belt - Hyd. Brake Boost Pump & A.P.		◆9640HD	Ford V-8 361		
Hose - Upper; W/Auto. Trans.		≈21936	B700		
or		26512	Belt - Fan & Alt.; W/40A., 42A., 55A., 60A., 61A. Alt.		②◆◆9447HD
Hose - Upper; W/Man. Trans.		21305	Belt - Fan & Alt.; W/70A., 90A., 105A. Alt.; W/O Noise Restrictions	C9PZ 8620 BV	②◆◆9440HD
or		26512	Belt - Fan & Alt.; W/70A., 90A., 105A. Alt.; W/Noise Restriction	C9PZ 8620 CB	②◆◆9463HD
Hose - Lower - Eng. To Pipe		21969	Belt - P.S.	C9PZ 8620 BM	◆9400HD
Hose - Lower - Pipe To Rad.; W/Auto. Trans.		21368	Belt - Air Brake Compr.	C9PZ 8620 CM	◆9520HD
Hose - Lower - Pipe To Rad.; W/Man. Trans.		≈20452	Belt - A.C.	D5PZ 8620 W	◆9360HD
Hose - By Pass		≈21942	Belt - A.P.	D4PZ 8620 C	7348
Hose - Heater		24216	Hose - Upper; Single I.D. Hose		≈20957
Ford V-8 7.0 L			Hose - Upper; Dual I.D. Hose; W/1 3/4" Offset		21118
B700			Hose - Upper; Dual I.D. Hose; W/3 5/8" Offset		21078
Belt - Fan & Alt.; W/40A., 60A. Alt.; W/22" Fan Clutch	D2AE 8620 CAA	②◆◆9447HD	Hose - Lower - Eng. To Pipe; Strt. Hose		24232
Belt - Fan & Alt.; W/40A., 60A. Alt.; W/O 22" Fan Clutch ..		②◆◆9435HD	Hose - Lower - Eng. To Pipe; Molded Hose		≈20685
Belt - Fan & Alt.; W/70A., 90A. Alt.; W/22" Fan Clutch	D2DE 8620 GA	②◆◆9455HD	Hose - Lower - Pipe To Rad.		≈20685
Belt - Fan & Alt.; W/70A., 90A. Alt.; W/O 22" Fan Clutch ..		②◆◆9447HD	Hose - By Pass - Left Side; Ser. No. T40001 & After		21257
Belt - Fan & Alt.; W/105A., 130A. Alt.		②◆◆9463HD	or		28441
Belt - Fan & P.S.	D2ZE 8620 AHA	◆9525HD	Hose - By Pass - Right Side; Ser. No. T40001 & After		21258
Belt - Fan & A.P.; W/O Air Brakes		◆9720HD	Ford V-8 370		
Belt - A.C.		◆9330HD	B600; B700		
Belt - Air Brake Compr. & A.P.; W/7 1/4 Cu. Ft. Air Brake Compr.	E0TE 8620 MA	◆9650HD	Belt - Fan & Alt.; W/40A., 60A. Alt.		②◆◆9435HD
Belt - Air Brake Compr. & A.P.; W/12 Cu. Ft. Air Brake Compr.	D9TE 8620 CB	◆9640HD	Belt - Fan & Alt.; W/70A., 90A. Alt.		②◆◆9447HD
Belt - Hyd. Brake Boost Pump & A.P.	E0TE 8620 KA	◆9610HD	Belt - Fan & Alt.; W/105A., 130A. Alt.		②◆◆9455HD
Belt - A.P.; W/Fan Clutch	C9PZ 8620 BH	◆9370HD	Belt - Fan & P.S.	D2ZE 8620 AHA	◆9525HD
Belt - A.P.; W/O Fan Clutch	D7PZ 8620 P	◆9390HD	Belt - Fan, A.P. & Air Brake Compr.		◆9640HD
Hose - Upper		≈21936	Belt - A.C.		◆9330HD
or		26512	Belt - A.P.; W/Fan Clutch		◆9370HD

◆Standard Belt Available.
②Two Required.
≈Cut to Fit.

◆PowerBand Belt May Work, Use Template to Check.
③Three Required.

Belts and Coolant Hose for School Buses

Application	Mfr. Part No.	Our No.	Application	Mfr. Part No.	Our No.
Ford - Continued			Ford - Continued		
1979 - Continued			1978 - Continued		
Ford V-8 370 - Continued			Ford 6-Cyl. 300		
B600; B700 - Continued			B600		
Belt - A.P.; W/O Fan Clutch		▲9385HD	Belt - Fan & Alt.; W/42A., 55A. Alt.	C9PZ 8620 V	②7417
Belt - Hyd. Brake Boost Pump & A.P.		▲9640HD	Belt - Fan & Alt.; W/70A. Alt.	C9PZ 8620 GJ	②7435
Hose - Upper; W/2V. Carb.		≠21944	Belt - P.S.	C9PZ 8620 BH	▲9370HD
Hose - Upper; W/4V. Carb.; W/Std. Cool.		≠20579	Belt - A.P.	D5PZ 8620 B	7381
Hose - Upper; W/4V. Carb.; W/X.C.		≠21944	Hose - Upper		≠20450
Hose - Lower - Pipe To Rad.		≠20520		or	25476
Hose - By Pass		≠21942	Hose - Lower		20475
Hose - Heater		28441		or	26502
Ford V-8 391			Ford V-8 330		
B700			B600; B700		
Belt - Fan & Alt.; W/40A., 42A., 55A., 60A., 61A. Alt.	②▲◆9447HD		Belt - Fan & Alt.; W/40A., 42A., 55A., 60A., 61A. Alt.	②▲◆9447HD	
Belt - Fan & Alt.; W/70A., 90A., 105A. Alt.;			Belt - Fan & Alt.; W/70A., 90A., 105A. Alt.;		
W/O Noise Restrictions	C9PZ 8620 BV	②▲9440HD	W/O Noise Restrictions	C9PZ 8620 BV	②▲9440HD
Belt - Fan & Alt.; W/70A., 90A., 105A. Alt.;			Belt - Fan & Alt.; W/70A., 90A., 105A. Alt.;		
W/Noise Restriction	C9PZ 8620 CB	②▲◆9463HD	W/Noise Restriction	C9PZ 8620 CB	②▲◆9463HD
Belt - P.S.	C9PZ 8620 BM	▲9400HD	Belt - P.S.	C9PZ 8620 BM	▲9400HD
Belt - Air Brake Compr.	C9PZ 8620 CM	▲9520HD	Belt - Air Brake Compr.	C9PZ 8620 CM	▲9520HD
Belt - A.C.	D5PZ 8620 W	▲9360HD	Belt - A.C.	D5PZ 8620 W	▲9360HD
Belt - A.P.	D4PZ 8620 C	7348	Belt - A.P.	D4PZ 8620 C	7348
Hose - Upper; Single I.D. Hose		≠20957	Hose - Upper; Single I.D. Hose		≠20957
Hose - Upper; Dual I.D. Hose; W/1 3/4" Offset		21118	Hose - Upper; Dual I.D. Hose; W/1 3/4" Offset		21118
Hose - Upper; Dual I.D. Hose; W/3 5/8" Offset		21078	Hose - Upper; Dual I.D. Hose; W/3 5/8" Offset		21078
Hose - Lower - Eng. To Pipe; Strt. Hose		24232	Hose - Lower - Eng. To Pipe; Strt. Hose		24232
Hose - Lower - Eng. To Pipe; Molded Hose		≠20685	Hose - Lower - Eng. To Pipe; Molded Hose		≠20685
Hose - Lower - Pipe To Rad.		≠20685	Hose - Lower - Pipe To Rad.		≠20685
Hose - By Pass - Left Side; Ser. No. T40001 & After		21257	Hose - By Pass - Left Side; Ser. No. T40001 & After		21257
	or	28441		or	28441
Hose - By Pass - Right Side; Ser. No. T40001 & After		21258	Hose - By Pass - Right Side; Ser. No. T40001 & After		21258
Ford V-8 429			Ford V-8 361		
B600; B700			B600; B700		
Belt - Fan & Alt.; W/40A., 60A. Alt.	②▲◆9435HD		Belt - Fan & Alt.; W/40A., 42A., 55A., 60A., 61A. Alt.	②▲◆9447HD	
Belt - Fan & Alt.; W/70A., 90A. Alt.	②▲◆9447HD		Belt - Fan & Alt.; W/70A., 90A., 105A. Alt.;		
Belt - Fan & Alt.; W/105A., 130A. Alt.	②▲9455HD		W/O Noise Restrictions	C9PZ 8620 BV	②▲9440HD
Belt - Fan & P.S.	D2ZE 8620 AHA	▲9525HD	Belt - Fan & Alt.; W/70A., 90A., 105A. Alt.;		
Belt - Fan, A.P. & Air Brake Compr.		▲9640HD	W/Noise Restriction	C9PZ 8620 CB	②▲◆9463HD
Belt - A.C.		▲9330HD	Belt - P.S.	C9PZ 8620 BM	▲9400HD
Belt - A.P.; W/Fan Clutch		▲9370HD	Belt - Air Brake Compr.	C9PZ 8620 CM	▲9520HD
Belt - A.P.; W/O Fan Clutch		▲9385HD	Belt - A.C.	D5PZ 8620 W	▲9360HD
Belt - Hyd. Brake Boost Pump & A.P.		▲9640HD	Belt - A.P.	D4PZ 8620 C	7348
Hose - Upper		≠21944	Hose - Upper; Single I.D. Hose		≠20957
Hose - Lower - Pipe To Rad.		≠20520	Hose - Upper; Dual I.D. Hose; W/1 3/4" Offset		21118
Hose - By Pass		≠21942	Hose - Upper; Dual I.D. Hose; W/3 5/8" Offset		21078
Hose - Heater		28441	Hose - Lower - Eng. To Pipe; Strt. Hose		24232
1978			Hose - Lower - Eng. To Pipe; Molded Hose		
Caterpillar 3208 Diesel			Hose - Lower - Pipe To Rad.		
B7000			Hose - Lower - Eng. To Pipe; Molded Hose		
Belt - Fan & Alt.; W/42A., 55A., 61A., 70A. Alt.	D0HA 8620 AA	②▲◆9610HD	Hose - By Pass - Left Side; Ser. No. T40001 & After		21257
Belt - Fan & Alt.; W/65A. Alt.	C9PZ 8620 DG	②▲9620HD		or	28441
Belt - Fan & Alt.; W/105A. Leece Neville Alt.	C9PZ 8620 GV	②▲9630HD	Hose - By Pass - Right Side; Ser. No. T40001 & After		21258
Belt - P.S.	D7HT 8620 LA	▲9375HD	Ford V-8 391		
Belt - Air Brake Compr.	D0HA 8620 U	▲9550HD	B700		
Belt - Hyd. Brake Boost Pump	D0HA 8620 U	▲9550HD	Belt - Fan & Alt.; W/40A., 42A., 55A., 60A., 61A. Alt.	②▲◆9447HD	
Belt - V.P.	D0HA 8620 AG	▲9525HD	Belt - Fan & Alt.; W/70A., 90A., 105A. Alt.;		
Hose - Upper		≠21256	W/O Noise Restrictions	C9PZ 8620 BV	②▲9440HD
Hose - Lower		≠21379	Belt - Fan & Alt.; W/70A., 90A., 105A. Alt.;		
Hose - Oil Cooler - Front Inlet		21824	W/Noise Restriction	C9PZ 8620 CB	②▲◆9463HD
Hose - Oil Cooler - Rear Inlet		21381	Belt - P.S.	C9PZ 8620 BM	▲9400HD
Hose - Oil Cooler Outlet		21380	Belt - Air Brake Compr.	C9PZ 8620 CM	▲9520HD
Hose - Heater		28441	Belt - A.C.	D5PZ 8620 W	▲9360HD
			Belt - A.P.	D4PZ 8620 C	7348
			Hose - Upper; Single I.D. Hose		≠20957
			Hose - Upper; Dual I.D. Hose; W/1 3/4" Offset		21118
			Hose - Upper; Dual I.D. Hose; W/3 5/8" Offset		21078
			Hose - Lower - Eng. To Pipe; Strt. Hose		24232
			Hose - Lower - Eng. To Pipe; Molded Hose		≠20685

▲Standard Belt Available.
◆PowerBand Belt May Work, Use Template to Check.

≠Cut to Fit.
②Two Required.

Belts and Coolant Hose for School Buses

Application	Mfr. Part No.	Our No.	Application	Mfr. Part No.	Our No.
Ford - Continued			Ford - Continued		
1978 - Continued			1977 - Continued		
Ford V-8 391 - Continued			Ford V-8 361		
B700 - Continued			B600; B700; B750		
Hose - Lower - Pipe To Rad.		≈20685	Belt - Fan & Alt.; W/40A., 42A., 55A., 60A., 61A. Alt.	②◆◆9447HD	
Hose - By Pass - Left Side; Ser. No. T40001 & After		21257	Belt - Fan & Alt.; W/70A., 90A., 105A. Alt.;		
		28441	W/O Noise Restrictions	C9PZ 8620 BV	②◆9440HD
Hose - By Pass - Right Side; Ser. No. T40001 & After		21258	Belt - Fan & Alt.; W/70A., 90A., 105A. Alt.;		
			W/Noise Restriction	C9PZ 8620 CB	②◆◆9463HD
1977			Belt - P.S.	C9PZ 8620 BM	◆9400HD
Caterpillar 3208 Diesel			Belt - Air Brake Compr.	C9PZ 8620 CM	◆9520HD
B7000			Belt - A.C.	D5PZ 8620 W	◆9360HD
Belt - Fan & Alt.; W/42A., 55A., 61A., 70A.			Belt - A.P.	D4PZ 8620 C	7348
Alt.	D0HA 8620 AA	②◆◆9610HD	Hose - Upper; Single I.D. Hose		≈20957
Belt - Fan & Alt.; W/65A. Alt.	C9PZ 8620 DG	②◆9620HD	Hose - Upper; Dual I.D. Hose; W/1 3/4" Offset		21118
Belt - Fan & Alt.; W/105A. Leece Neville			Hose - Upper; Dual I.D. Hose; W/3 5/8" Offset		21078
Alt.	C9PZ 8620 GV	②◆9630HD	Hose - Lower - Eng. To Pipe; Strt. Hose		24232
Belt - P.S.	D7HT 8620 LA	◆9375HD	Hose - Lower - Eng. To Pipe; Molded Hose		≈20685
Belt - Air Brake Compr.	D0HA 8620 U	◆9550HD	Hose - Lower - Pipe To Rad.		≈20685
Belt - Hyd. Brake Boost Pump	D0HA 8620 U	◆9550HD	Hose - By Pass - Left Side; Ser. No. T40001 & After		21257
Belt - V.P.	D0HA 8620 AG	◆9525HD			28441
Hose - Upper		≈21256	Hose - By Pass - Right Side; Ser. No. T40001 & After		21258
Hose - Lower		≈21379	Ford V-8 391		
Hose - Oil Cooler - Front Inlet		21824	B700; B750		
Hose - Oil Cooler - Rear Inlet		21381	Belt - Fan & Alt.; W/40A., 42A., 55A., 60A., 61A. Alt.	②◆◆9447HD	
Hose - Oil Cooler Outlet		21380	Belt - Fan & Alt.; W/70A., 90A., 105A. Alt.;		
Hose - Heater		28441	W/O Noise Restrictions	C9PZ 8620 BV	②◆9440HD
Ford 6-Cyl. 300			Belt - Fan & Alt.; W/70A., 90A., 105A. Alt.;		
B500; B600			W/Noise Restriction	C9PZ 8620 CB	②◆◆9463HD
Belt - Fan & Alt.; W/42A., 55A. Alt.	C9PZ 8620 V	②7417	Belt - P.S.	C9PZ 8620 BM	◆9400HD
Belt - Fan & Alt.; W/70A. Alt.	C9PZ 8620 GJ	②7435	Belt - Air Brake Compr.	C9PZ 8620 CM	◆9520HD
Belt - P.S.	C9PZ 8620 BH	◆9370HD	Belt - A.C.	D5PZ 8620 W	◆9360HD
Belt - A.P.	D5PZ 8620 B	7381	Belt - A.P.	D4PZ 8620 C	7348
Hose - Upper		≈20450	Hose - Upper; Single I.D. Hose		≈20957
		or	Hose - Upper; Dual I.D. Hose; W/1 3/4" Offset		21118
		25476	Hose - Upper; Dual I.D. Hose; W/3 5/8" Offset		21078
Hose - Lower		20475	Hose - Lower - Eng. To Pipe; Strt. Hose		24232
		or	Hose - Lower - Eng. To Pipe; Molded Hose		≈20685
		26502	Hose - Lower - Pipe To Rad.		≈20685
Ford V-8 330			Hose - By Pass - Left Side; Ser. No. T40001 & After		21257
B500					28441
Belt - Fan & Alt.; W/40A., 42A., 55A., 60A., 61A. Alt.	②◆◆9447HD		Hose - By Pass - Right Side; Ser. No. T40001 & After		21258
Belt - Fan & Alt.; W/70A., 90A., 105A. Alt.;			1976		
W/O Noise Restrictions	C9PZ 8620 BV	②◆9440HD	Caterpillar 3208 Diesel		
Belt - Fan & Alt.; W/70A., 90A., 105A. Alt.;			B7000		
W/Noise Restriction	C9PZ 8620 CB	②◆◆9463HD	Belt - Fan & Alt.; W/42A., 55A., 61A., 70A.		
Belt - P.S.	C9PZ 8620 BM	◆9400HD	Alt.	D0HA 8620 AA	②◆◆9610HD
Belt - Air Brake Compr.	C9PZ 8620 CM	◆9520HD	Belt - Fan & Alt.; W/65A. Alt.	C9PZ 8620 DG	②◆9620HD
Belt - A.C.	D5PZ 8620 W	◆9360HD	Belt - Fan & Alt.; W/105A. Leece Neville		
Belt - A.P.	D4PZ 8620 C	7348	Alt.	C9PZ 8620 GV	②◆9630HD
B600; B700; B750			Belt - P.S.	C8TA 8620 F	◆9370HD
Belt - Fan & Alt.; W/40A., 42A., 55A., 60A., 61A. Alt.	②◆◆9447HD		Belt - Air Brake Compr.	D0HA 8620 U	◆9550HD
Belt - Fan & Alt.; W/70A., 90A., 105A. Alt.;			Belt - Hyd. Brake Boost Pump	D0HA 8620 U	◆9550HD
W/O Noise Restrictions	C9PZ 8620 BV	②◆9440HD	Belt - V.P.	D0HA 8620 AG	◆9525HD
Belt - Fan & Alt.; W/70A., 90A., 105A. Alt.;			Hose - Upper		≈21256
W/Noise Restriction	C9PZ 8620 CB	②◆◆9463HD	Hose - Lower		≈21379
Belt - P.S.	C9PZ 8620 BM	◆9400HD	Hose - Oil Cooler - Front Inlet		21824
Belt - Air Brake Compr.	C9PZ 8620 CM	◆9520HD	Hose - Oil Cooler - Rear Inlet		21381
Belt - A.C.	D5PZ 8620 W	◆9360HD	Hose - Oil Cooler Outlet		21380
Belt - A.P.	D4PZ 8620 C	7348	Hose - Heater		28441
Hose - Upper; Single I.D. Hose		≈20957	Ford 6-Cyl. 300		
Hose - Upper; Dual I.D. Hose; W/1 3/4" Offset		21118	B500; B600		
Hose - Upper; Dual I.D. Hose; W/3 5/8" Offset		21078	Belt - Fan & Alt.; W/42A., 55A. Alt.	C9PZ 8620 V	②7417
Hose - Lower - Eng. To Pipe; Strt. Hose		24232	Belt - Fan & Alt.; W/70A. Alt.	C9PZ 8620 GJ	②7435
Hose - Lower - Eng. To Pipe; Molded Hose		≈20685	Belt - P.S.	C9PZ 8620 BH	◆9370HD
Hose - Lower - Pipe To Rad.		≈20685	Belt - A.P.	D5PZ 8620 B	7381
Hose - By Pass - Left Side; Ser. No. T40001 & After		21257			
		28441			
Hose - By Pass - Right Side; Ser. No. T40001 & After		21258			

◆Standard Belt Available.
②Two Required.

◆PowerBand Belt May Work, Use Template to Check.
≈Cut to Fit.

Belts and Coolant Hose for School Buses

Application	Mfr. Part No.	Our No.	Application	Mfr. Part No.	Our No.
Ford - Continued			Ford - Continued		
1976 - Continued			1976 - Continued		
Ford 6-Cyl. 300 - Continued			Ford V-8 391 - Continued		
B500; B600 - Continued			B700; B750 - Continued		
Hose - Upper		≈<20450	Belt - A.P. D4PZ 8620 C		7348
	or	25476	Hose - Upper; Single I.D. Hose		≈<20957
Hose - Lower		20475	Hose - Upper; Dual I.D. Hose; W/1 3/4" Offset		21118
	or	26502	Hose - Upper; Dual I.D. Hose; W/3 5/8" Offset		21078
			Hose - Lower - Eng. To Pipe; Strt. Hose		24232
			Hose - Lower - Eng. To Pipe; Molded Hose		≈<20685
			Hose - Lower - Pipe To Rad.		≈<20685
			Hose - By Pass - Left Side; Ser. No. T40001 & After		21257
				or	28441
			Hose - By Pass - Right Side; Ser. No. T40001 & After		21258
Ford V-8 330			1975		
B500			Caterpillar 3208 Diesel		
Belt - Fan & Alt.; W/40A., 42A., 55A., 60A., 61A. Alt.	②◆◆9447HD		B7000		
Belt - Fan & Alt.; W/70A., 90A., 105A. Alt.;			Belt - Fan & Alt.; W/42A., 55A., 61A., 70A.		
W/O Noise Restrictions	C9PZ 8620 BV	②◆◆9440HD	Alt.	D0HA 8620 AA	②◆◆9610HD
Belt - Fan & Alt.; W/70A., 90A., 105A. Alt.;			Belt - Fan & Alt.; W/65A. Alt.	C9PZ 8620 DG	②◆◆9620HD
W/Noise Restriction	C9PZ 8620 CB	②◆◆9463HD	Belt - Fan & Alt.; W/105A. Leece Neville		
Belt - P.S.	C9PZ 8620 BM	◆9400HD	Alt.	C9PZ 8620 GV	②◆◆9630HD
Belt - Air Brake Compr.	C9PZ 8620 CM	◆9520HD	Belt - P.S.	C8TA 8620 F	◆9370HD
Belt - A.C.	D5PZ 8620 W	◆9360HD	Belt - Air Brake Compr.	D0HA 8620 U	◆9550HD
Belt - A.P.	D4PZ 8620 C	7348	Belt - Hyd. Brake Boost Pump	D0HA 8620 U	◆9550HD
			Belt - V.P.	D0HA 8620 AG	◆9525HD
			Hose - Upper		≈<21256
			Hose - Lower		≈<21379
			Hose - Oil Cooler - Front Inlet		21824
			Hose - Oil Cooler - Rear Inlet		21381
			Hose - Oil Cooler Outlet		21380
			Hose - Heater		28441
			Ford 6-Cyl. 300		
			B500; B600; B700		
			Belt - Fan & Alt.; W/40A., 42A., 55A., 60A., 61A. Alt.	C9PZ 8620 V	②7417
			Belt - Fan & Alt.; W/70A., 90A., 105A. Alt.	C9PZ 8620 GJ	②7435
			Belt - P.S.	C9PZ 8620 BH	◆9370HD
			Belt - A.P.	D5PZ 8620 B	7381
			Hose - Upper		≈<20450
				or	25476
			Hose - Lower		20475
				or	26502
			Ford V-8 330		
			B500		
			Belt - Fan & Alt.; W/40A., 42A., 55A., 60A., 61A. Alt.	②◆◆9447HD	
			Belt - Fan & Alt.; W/70A., 90A., 105A. Alt.;		
			W/O Noise Restrictions	C9PZ 8620 BV	②◆◆9440HD
			Belt - Fan & Alt.; W/70A., 90A., 105A. Alt.;		
			W/Noise Restriction	C9PZ 8620 CB	②◆◆9463HD
			Belt - P.S.	C9PZ 8620 BM	◆9400HD
			Belt - Air Brake Compr.	C9PZ 8620 CM	◆9520HD
			Belt - A.C.	D5PZ 8620 W	◆9360HD
			Belt - A.P.	D4PZ 8620 C	7348
			Hose - Upper; Single I.D. Hose		≈<20957
			Hose - Upper; Dual I.D. Hose; W/1 3/4" Offset		21118
			Hose - Upper; Dual I.D. Hose; W/3 5/8" Offset		21078
			Hose - Lower - Eng. To Pipe; Strt. Hose		24232
			Hose - Lower - Eng. To Pipe; Molded Hose		≈<20685
			Hose - Lower - Pipe To Rad.		≈<20685
			Hose - By Pass - Left Side; Ser. No. T40001 & After		21257
				or	28441
			Hose - By Pass - Right Side; Ser. No. T40001 & After		21258
			Ford V-8 391		
			B700; B750		
			Belt - Fan & Alt.; W/40A., 42A., 55A., 60A., 61A. Alt.	②◆◆9447HD	
			Belt - Fan & Alt.; W/70A., 90A., 105A. Alt.;		
			W/O Noise Restrictions	C9PZ 8620 BV	②◆◆9440HD
			Belt - Fan & Alt.; W/70A., 90A., 105A. Alt.;		
			W/Noise Restriction	C9PZ 8620 CB	②◆◆9463HD
			Belt - P.S.	C9PZ 8620 BM	◆9400HD
			Belt - Air Brake Compr.	C9PZ 8620 CM	◆9520HD
			Belt - A.C.	D5PZ 8620 W	◆9360HD
			Belt - A.P.	D4PZ 8620 C	7348
			Hose - Upper; Single I.D. Hose		≈<20957
			Hose - Upper; Dual I.D. Hose; W/1 3/4" Offset		21118
			Hose - Upper; Dual I.D. Hose; W/3 5/8" Offset		21078
			Hose - Lower - Eng. To Pipe; Strt. Hose		24232

◆Standard Belt Available.
②Two Required.

◆PowerBand Belt May Work, Use Template to Check.
≈<Cut to Fit.

School Buses

Belts and Coolant Hose for School Buses

School Buses

Application	Mfr. Part No.	Our No.	Application	Mfr. Part No.	Our No.
Ford - Continued			Ford - Continued		
1975 - Continued			1974 - 1973 - Continued		
Ford V-8 330 - Continued			Caterpillar V-8 573 Diesel - Continued		
B600; B700 - Continued			B7000 - Continued		
Hose - Lower - Eng. To Pipe; Molded Hose		≈20685	Belt - Fan & Alt.; W/65A. Alt.		②◆◆9620HD
Hose - Lower - Pipe To Rad.		≈20685	Belt - Fan & Alt.; W/105A. Alt.		②◆◆9630HD
Hose - By Pass - Left Side; Ser. No. T40001 & After		21257	Belt - P.S.		◆9370HD
or		28441	Belt - Air Brake Compr.	DOHA 8620 U	◆9550HD
Hose - By Pass - Right Side; Ser. No. T40001 & After		21258	Belt - V.P.	DOHA 8620 AG	◆9525HD
Ford V-8 361			Hose - Lower		≈21379
B600; B700; B750			Hose - Oil Cooler Inlet		21381
Belt - Fan & Alt.; W/40A., 42A., 55A., 60A., 61A. Alt.	②◆◆9447HD		Hose - Oil Cooler Outlet		21380
Belt - Fan & Alt.; W/70A., 90A., 105A. Alt.; W/O Noise Restrictions	C9PZ 8620 BV	②◆◆9440HD	Ford 6-Cyl. 240		
Belt - Fan & Alt.; W/70A., 90A., 105A. Alt.; W/Noise Restriction	C9PZ 8620 CB	②◆◆9463HD	B500; B600		
Belt - P.S.	C9PZ 8620 BM	◆9400HD	Belt - Fan & Alt.; W/38A., 42A., Y45A., 55A. Alt.	C9PZ 8620 V	②7417
Belt - Air Brake Compr.	C9PZ 8620 CM	◆9520HD	Belt - Fan & Alt.; W/65A., 70A. Alt.	C9PZ 8620 GJ	②7430
Belt - A.C.	D5PZ 8620 W	◆9360HD	Belt - P.S.	C9PZ 8620 BH	◆9370HD
Belt - A.P.	D4PZ 8620 C	7348	Belt - Air Brake Compr.	C9PZ 8620 BH	◆9412HD
Hose - Upper; Single I.D. Hose		≈20957	Hose - Upper		≈20450
Hose - Upper; Dual I.D. Hose; W/1 3/4" Offset		21118	or		25476
Hose - Upper; Dual I.D. Hose; W/3 5/8" Offset		21078	Hose - Lower		20475
Hose - Lower - Eng. To Pipe; Strt. Hose		24232	or		26502
Hose - Lower - Eng. To Pipe; Molded Hose		≈20685	Ford 6-Cyl. 300		
Hose - Lower - Pipe To Rad.		≈20685	B500; B600		
Hose - By Pass - Left Side; Ser. No. T40001 & After		21257	Belt - Fan & Alt.; W/38A., 42A., Y45A., 55A. Alt.; W/L.D. Eng.	C9PZ 8620 V	②7417
or		28441	Belt - Fan & Alt.; W/38A., 42A., 45A., 55A. Alt.; W/H.D. Eng.	C9PZ 8620 BS	②◆◆9425HD
Hose - By Pass - Right Side; Ser. No. T40001 & After		21258	Belt - Fan & Alt.; W/65A., 70A. Alt.; W/H.D. Eng.	C9PZ 8620 GJ	②7430
Ford V-8 391			Belt - Fan & Alt.; W/60A., 65A. Alt.; W/H.D. Eng.	C9PZ 8620 BY	②◆◆9447HD
B700; B750			Belt - P.S.	C9PZ 8620 BH	◆9370HD
Belt - Fan & Alt.; W/40A., 42A., 55A., 60A., 61A. Alt.	②◆◆9447HD		Belt - Air Brake Compr.	C9PZ 8620 BH	◆9412HD
Belt - Fan & Alt.; W/70A., 90A., 105A. Alt.; W/O Noise Restrictions	C9PZ 8620 BV	②◆◆9440HD	Hose - Upper		≈20450
Belt - Fan & Alt.; W/70A., 90A., 105A. Alt.; W/Noise Restriction	C9PZ 8620 CB	②◆◆9463HD	or		25476
Belt - P.S.	C9PZ 8620 BM	◆9400HD	Hose - Lower		20475
Belt - Air Brake Compr.	C9PZ 8620 CM	◆9520HD	or		26502
Belt - A.C.	D5PZ 8620 W	◆9360HD	Ford V-8 330		
Belt - A.P.	D4PZ 8620 C	7348	B500		
Hose - Upper; Single I.D. Hose		≈20957	Belt - Fan & Alt.; W/40A., 42A., 55A., 60A., 61A. Alt.	②◆◆9447HD	
Hose - Upper; Dual I.D. Hose; W/1 3/4" Offset		21118	Belt - Fan & Alt.; W/70A., 90A., 105A. Alt.; W/O Noise Restrictions	C9PZ 8620 BV	②◆◆9440HD
Hose - Upper; Dual I.D. Hose; W/3 5/8" Offset		21078	Belt - Fan & Alt.; W/70A., 90A., 105A. Alt.; W/Noise Restriction	C9PZ 8620 CB	②◆◆9463HD
Hose - Lower - Eng. To Pipe; Strt. Hose		24232	Belt - P.S.	C9PZ 8620 BM	◆9400HD
Hose - Lower - Eng. To Pipe; Molded Hose		≈20685	Belt - Air Brake Compr.	C9PZ 8620 CM	◆9520HD
Hose - Lower - Pipe To Rad.		≈20685	Belt - A.C.	D5PZ 8620 W	◆9360HD
Hose - By Pass - Left Side; Ser. No. T40001 & After		21257	Belt - A.P.	D4PZ 8620 C	7348
or		28441	B600; B700; B750		
Hose - By Pass - Right Side; Ser. No. T40001 & After		21258	Belt - Fan & Alt.; W/40A., 42A., 55A., 60A., 61A. Alt.	②◆◆9447HD	
1974 - 1973			Belt - Fan & Alt.; W/70A., 90A., 105A. Alt.; W/O Noise Restrictions	C9PZ 8620 BV	②◆◆9440HD
Caterpillar V-8 522 Diesel			Belt - Fan & Alt.; W/70A., 90A., 105A. Alt.; W/Noise Restriction	C9PZ 8620 CB	②◆◆9463HD
B7000			Belt - P.S.	C9PZ 8620 BM	◆9400HD
Belt - Fan & Alt.; W/40A., 42A., 55A., 60A. 70A. Alt.	C9PZ 8620 DE	②◆◆9610HD	Belt - Air Brake Compr.	C9PZ 8620 CM	◆9520HD
Belt - Fan & Alt.; W/65A. Alt.	C9PZ 8620 DG	②◆◆9625HD	Belt - A.C.	D5PZ 8620 W	◆9360HD
Belt - Fan & Alt.; W/105A. Alt.	C9PZ 8620 GV	②◆◆9630HD	Belt - A.P.	D4PZ 8620 C	7348
Belt - P.S.	C9PZ 8620 BH	◆9370HD	Hose - Upper; Single I.D. Hose		≈20957
Belt - Air Brake Compr.	DOHA 8620 U	◆9550HD	Hose - Upper; Dual I.D. Hose; W/1 3/4" Offset		21118
Belt - Hyd. Brake Boost Pump	DOAZ 8620 E	◆9525HD	Hose - Upper; Dual I.D. Hose; W/3 5/8" Offset		21078
Hose - Lower		≈21379	Hose - Lower - Eng. To Pipe; Strt. Hose		24232
Hose - Oil Cooler Inlet		21381	Hose - Lower - Eng. To Pipe; Molded Hose		≈20685
Hose - Oil Cooler Outlet		21380	Hose - Lower - Pipe To Rad.		≈20685
Hose - Heater		28441	Hose - By Pass - Left Side; Ser. No. T40001 & After		21257
Caterpillar V-8 573 Diesel			or		28441
B7000			Ford 6-Cyl. 240		
Belt - Fan & Alt.; W/42A., 55A., 61A., 70A. Alt.	DOHA 8620 AA	②◆◆9610HD	B500; B600		

≈Cut to Fit.

◆PowerBand Belt May Work, Use Template to Check.

◆Standard Belt Available.

②Two Required.

Belts and Coolant Hose for School Buses

Application	Mfr. Part No.	Our No.	Application	Mfr. Part No.	Our No.
Ford - Continued			Ford - Continued		
1974 - 1973 - Continued			1972		
Ford V-8 330 - Continued			Caterpillar V-8 522 Diesel		
B600; B700; B750 - Continued			B7000		
Hose - By Pass - Right Side; Ser. No. T40001 & After		21258	Belt - Fan & Alt.; W/40A., 42A., 55A., 60A. 70A. Alt.	C9PZ 8620 DE	②◆◆9610HD
Ford V-8 361			Belt - Fan & Alt.; W/65A. Alt.	C9PZ 8620 DG	②◆◆9625HD
B500			Belt - Fan & Alt.; W/105A. Alt.	C9PZ 8620 GV	②◆◆9630HD
Belt - Fan & Alt.; W/40A., 42A., 55A., 60A., 61A. Alt.	②◆◆9447HD		Belt - P.S.	C9PZ 8620 BH	◆9370HD
Belt - Fan & Alt.; W/70A., 90A., 105A. Alt.; W/O Noise Restrictions	C9PZ 8620 BV	②◆◆9440HD	Belt - Air Brake Compr.	DOHA 8620 U	◆9550HD
Belt - Fan & Alt.; W/70A., 90A., 105A. Alt.; W/Noise Restriction	C9PZ 8620 CB	②◆◆9463HD	Belt - Hyd. Brake Boost Pump	DOAZ 8620 E	◆9525HD
Belt - P.S.	C9PZ 8620 BM	◆9400HD	Belt - V.P.	D2AE 8620 HA	◆9580HD
Belt - Air Brake Compr.	C9PZ 8620 CM	◆9520HD	Hose - Lower		≈<21379
Belt - A.C.	D5PZ 8620 W	◆9360HD	Hose - Oil Cooler Inlet		21381
Belt - A.P.	D4PZ 8620 C	7348	Hose - Oil Cooler Outlet		21380
B600; B700; B750			Hose - Heater		28441
Belt - Fan & Alt.; W/40A., 42A., 55A., 60A., 61A. Alt.	②◆◆9447HD		Caterpillar V-8 573 Diesel		
Belt - Fan & Alt.; W/70A., 90A., 105A. Alt.; W/O Noise Restrictions	C9PZ 8620 BV	②◆◆9440HD	B7000		
Belt - Fan & Alt.; W/70A., 90A., 105A. Alt.; W/Noise Restriction	C9PZ 8620 CB	②◆◆9463HD	Belt - Fan & Alt.; W/42A., 55A., 61A., 70A. Alt.	DOHA 8620 AA	②◆◆9610HD
Belt - P.S.	C9PZ 8620 BM	◆9400HD	Belt - Fan & Alt.; W/65A. Alt.		②◆◆9620HD
Belt - Air Brake Compr.	C9PZ 8620 CM	◆9520HD	Belt - Fan & Alt.; W/105A. Alt.		②◆◆9630HD
Belt - A.C.	D5PZ 8620 W	◆9360HD	Belt - P.S.		◆9370HD
Belt - A.P.	D4PZ 8620 C	7348	Belt - Air Brake Compr.	DOHA 8620 U	◆9550HD
Hose - Upper; Single I.D. Hose		≈<20957	Belt - V.P.	DOHA 8620 AG	◆9525HD
Hose - Upper; Dual I.D. Hose; W/1 3/4" Offset		21118	Hose - Lower		≈<21379
Hose - Upper; Dual I.D. Hose; W/3 5/8" Offset		21078	Hose - Oil Cooler Inlet		21381
Hose - Lower - Eng. To Pipe; Strt. Hose		24232	Hose - Oil Cooler Outlet		21380
Hose - Lower - Eng. To Pipe; Molded Hose		≈<20685	Ford 6-Cyl. 240		
Hose - Lower - Pipe To Rad.		≈<20685	B500; B600		
Hose - By Pass - Left Side; Ser. No. T40001 & After		21257	Belt - Fan & Alt.; W/38A., 42A., Y45A., 55A. Alt.	C9PZ 8620 V	②7417
or		28441	Belt - Fan & Alt.; W/65A., 70A. Alt.	C9PZ 8620 GJ	②7430
Hose - By Pass - Right Side; Ser. No. T40001 & After		21258	Belt - P.S.	C9PZ 8620 BH	◆9370HD
Ford V-8 391			Belt - Air Brake Compr.	C9PZ 8620 BH	◆9412HD
B500			Hose - Upper		≈<20450
Belt - Fan & Alt.; W/40A., 42A., 55A., 60A., 61A. Alt.	②◆◆9447HD		or		25476
Belt - Fan & Alt.; W/70A., 90A., 105A. Alt.; W/O Noise Restrictions	C9PZ 8620 BV	②◆◆9440HD	Hose - Lower		20475
Belt - Fan & Alt.; W/70A., 90A., 105A. Alt.; W/Noise Restriction	C9PZ 8620 CB	②◆◆9463HD	or		26502
Belt - P.S.	C9PZ 8620 BM	◆9400HD	Ford 6-Cyl. 300		
Belt - Air Brake Compr.	C9PZ 8620 CM	◆9520HD	B500; B600		
Belt - A.C.	D5PZ 8620 W	◆9360HD	Belt - Fan & Alt.; W/38A., 42A., Y45A., 55A. Alt.; W/L.D. Eng.	C9PZ 8620 V	②7417
Belt - A.P.	D4PZ 8620 C	7348	Belt - Fan & Alt.; W/38A., 42A., 45A., 55A. Alt.; W/H.D. Eng.	C9PZ 8620 BS	②◆◆9425HD
B600; B700; B750			Belt - Fan & Alt.; W/65A., 70A. Alt.; W/H.D. Eng.	C9PZ 8620 GJ	②7430
Belt - Fan & Alt.; W/40A., 42A., 55A., 60A., 61A. Alt.	②◆◆9447HD		Belt - Fan & Alt.; W/60A., 65A. Alt.; W/H.D. Eng.	C9PZ 8620 BY	②◆◆9447HD
Belt - Fan & Alt.; W/70A., 90A., 105A. Alt.; W/O Noise Restrictions	C9PZ 8620 BV	②◆◆9440HD	Belt - P.S.	C9PZ 8620 BH	◆9370HD
Belt - Fan & Alt.; W/70A., 90A., 105A. Alt.; W/Noise Restriction	C9PZ 8620 CB	②◆◆9463HD	Belt - Air Brake Compr.	C9PZ 8620 BH	◆9412HD
Belt - P.S.	C9PZ 8620 BM	◆9400HD	Hose - Upper		≈<20450
Belt - Air Brake Compr.	C9PZ 8620 CM	◆9520HD	or		25476
Belt - A.C.	D5PZ 8620 W	◆9360HD	Hose - Lower		20475
Belt - A.P.	D4PZ 8620 C	7348	or		26502
Hose - Upper; Single I.D. Hose		≈<20957	Ford V-8 330		
Hose - Upper; Dual I.D. Hose; W/1 3/4" Offset		21118	B500		
Hose - Upper; Dual I.D. Hose; W/3 5/8" Offset		21078	Belt - Fan & Alt.; W/42A., 55A., 61A., 65A. Alt.	C9PZ 8620 BV	②◆◆9440HD
Hose - Lower - Eng. To Pipe; Strt. Hose		24232	Belt - Fan & Alt.; W/105A. Alt.	C9PZ 8620 CB	②◆◆9463HD
Hose - Lower - Eng. To Pipe; Molded Hose		≈<20685	Belt - P.S.	C9PZ 8620 BM	◆9400HD
Hose - Lower - Pipe To Rad.		≈<20685	Belt - Air Brake Compr.	C9PZ 8620 CM	◆9520HD
Hose - By Pass - Left Side; Ser. No. T40001 & After		21257	Belt - A.C.	C9PZ 8620 BH	◆9370HD
or		28441	Belt - A.P.	C9PZ 8620 FY	7455
Hose - By Pass - Right Side; Ser. No. T40001 & After		21258	B600; B700; B750		
			Belt - Fan & Alt.; W/42A., 55A., 61A., 65A. Alt.	C9PZ 8620 BV	②◆◆9440HD

◆Standard Belt Available.
②Two Required.

◆PowerBand Belt May Work, Use Template to Check.
≈<Cut to Fit.

School Buses

Belts and Coolant Hose for School Buses

Application	Mfr. Part No.	Our No.	Application	Mfr. Part No.	Our No.
Ford - Continued			Ford - Continued		
1972 - Continued			1972 - Continued		
Ford V-8 330 - Continued			Ford V-8 391 - Continued		
B600; B700; B750 - Continued			B600; B700; B750 - Continued		
Belt - Fan & Alt.; W/105A. Alt.	C9PZ 8620 CB	②◆◆9463HD	Hose - Lower - Eng. To Pipe; Molded Hose		≈<20685
Belt - P.S.	C9PZ 8620 BM	◆9400HD	Hose - Lower - Pipe To Rad.		≈<20685
Belt - Air Brake Compr.	C9PZ 8620 CM	◆9520HD	Hose - By Pass - Left Side; Ser. No. T40001 & After; Molded Hose		21257
Belt - A.C.	C9PZ 8620 BH	◆9370HD	Hose - By Pass - Left Side; Ser. No. T40001 & After; Strt. Hose		28441
Belt - A.P.	C9PZ 8620 FY	7455	Hose - By Pass - Right Side; Ser. No. T40001 & After		21258
Hose - Upper; Single I.D. Hose		≈<20957			
Hose - Upper; Dual I.D. Hose; W/1 3/4" Offset		21118			
Hose - Upper; Dual I.D. Hose; W/3 5/8" Offset		21078			
Hose - Lower - Eng. To Pipe; Strt. Hose		24232			
Hose - Lower - Eng. To Pipe; Molded Hose		≈<20685			
Hose - Lower - Pipe To Rad.		≈<20685			
Hose - By Pass - Left Side; Ser. No. T40001 & After; Molded Hose		21257			
Hose - By Pass - Left Side; Ser. No. T40001 & After; Strt. Hose		28441			
Hose - By Pass - Right Side; Ser. No. T40001 & After		21258			
Ford V-8 361			1971		
B500			Caterpillar V-8 522 Diesel		
Belt - Fan & Alt.; W/42A., 55A., 61A., 65A. Alt.	C9PZ 8620 BV	②◆◆9440HD	B6000; B7000		
Belt - Fan & Alt.; W/105A. Alt.	C9PZ 8620 CB	②◆◆9463HD	Belt - Fan & Alt.; W/40A., 42A., 55A., 60A. 70A. Alt.	C9PZ 8620 DE	②◆◆9610HD
Belt - P.S.	C9PZ 8620 BM	◆9400HD	Belt - Fan & Alt.; W/65A. Alt.	C9PZ 8620 DG	②◆◆9625HD
Belt - Air Brake Compr.	C9PZ 8620 CM	◆9520HD	Belt - Fan & Alt.; W/105A. Alt.	C9PZ 8620 GV	②◆◆9630HD
Belt - A.C.	C9PZ 8620 BH	◆9370HD	Belt - P.S.	C9PZ 8620 BH	◆9370HD
Belt - A.P.	C9PZ 8620 FY	7455	Belt - Air Brake Compr.	DOHA 8620 U	◆9550HD
B600; B700; B750			Belt - A.P.	C7TA 8620 S	◆9530HD
Belt - Fan & Alt.; W/42A., 55A., 61A., 65A. Alt.	C9PZ 8620 BV	②◆◆9440HD	Belt - Hyd. Brake Boost Pump	DOAZ 8620 E	◆9525HD
Belt - Fan & Alt.; W/105A. Alt.	C9PZ 8620 CB	②◆◆9463HD	Hose - Lower		≈<21379
Belt - P.S.	C9PZ 8620 BM	◆9400HD	Hose - Oil Cooler Inlet		21381
Belt - Air Brake Compr.	C9PZ 8620 CM	◆9520HD	Hose - Oil Cooler Outlet		21380
Belt - A.C.	C9PZ 8620 BH	◆9370HD	Hose - Heater		28441
Belt - A.P.	C9PZ 8620 FY	7455			
B600; B700; B750			Caterpillar V-8 573 Diesel		
Belt - Fan & Alt.; W/42A., 55A., 61A., 65A. Alt.	C9PZ 8620 BV	②◆◆9440HD	B7000		
Belt - Fan & Alt.; W/105A. Alt.	C9PZ 8620 CB	②◆◆9463HD	Belt - Fan & Alt.; W/42A., 55A., 61A., 70A. Alt.	DOHA 8620 AA	②◆◆9610HD
Belt - P.S.	C9PZ 8620 BM	◆9400HD	Belt - Fan & Alt.; W/65A. Alt.		②◆◆9620HD
Belt - Air Brake Compr.	C9PZ 8620 CM	◆9520HD	Belt - Fan & Alt.; W/105A. Alt.		②◆◆9630HD
Belt - A.C.	C9PZ 8620 BH	◆9370HD	Belt - P.S.		◆9370HD
Belt - A.P.	C9PZ 8620 FY	7455	Belt - Air Brake Compr.	DOHA 8620 U	◆9550HD
Hose - Upper; Single I.D. Hose		≈<20957	Belt - V.P.	DOHA 8620 AG	◆9525HD
Hose - Upper; Dual I.D. Hose; W/1 3/4" Offset		21118	Hose - Lower		≈<21379
Hose - Upper; Dual I.D. Hose; W/3 5/8" Offset		21078	Hose - Oil Cooler Inlet		21381
Hose - Lower - Eng. To Pipe; Strt. Hose		24232	Hose - Oil Cooler Outlet		21380
Hose - Lower - Eng. To Pipe; Molded Hose		≈<20685			
Hose - Lower - Pipe To Rad.		≈<20685	Ford 6-Cyl. 240		
Hose - By Pass - Left Side; Ser. No. T40001 & After; Molded Hose		21257	B500; B600		
Hose - By Pass - Left Side; Ser. No. T40001 & After; Strt. Hose		28441	Belt - Fan & Alt.; W/38A., 42A., Y45A., 55A. Alt.	C9PZ 8620 V	②7417
Hose - By Pass - Right Side; Ser. No. T40001 & After		21258	Belt - Fan & Alt.; W/65A., 70A. Alt.	C9PZ 8620 GJ	②7430
			Belt - P.S.	C9PZ 8620 BH	◆9370HD
			Belt - Air Brake Compr.	C9PZ 8620 BH	◆9412HD
			Hose - Upper		≈<20450
				or	25476
			Hose - Lower		20475
				or	26502
Ford V-8 391			Ford 6-Cyl. 300		
B500			B500; B600		
Belt - Fan & Alt.; W/42A., 55A., 61A., 65A. Alt.	C9PZ 8620 BV	②◆◆9440HD	Belt - Fan & Alt.; W/38A., 42A., Y45A., 55A. Alt.; W/L.D. Eng.	C9PZ 8620 V	②7417
Belt - Fan & Alt.; W/105A. Alt.	C9PZ 8620 CB	②◆◆9463HD	Belt - Fan & Alt.; W/38A., 42A., 45A., 55A. Alt.; W/H.D. Eng.	C9PZ 8620 BS	②◆◆9425HD
Belt - P.S.	C9PZ 8620 BM	◆9400HD	Belt - Fan & Alt.; W/65A., 70A. Alt.; W/H.D. Eng.	C9PZ 8620 GJ	②7430
Belt - Air Brake Compr.	C9PZ 8620 CM	◆9520HD	Belt - Fan & Alt.; W/60A., 65A. Alt.; W/H.D. Eng.	C9PZ 8620 BY	②◆◆9447HD
Belt - A.C.	C9PZ 8620 BH	◆9370HD	Belt - P.S.	C9PZ 8620 BH	◆9370HD
Belt - A.P.	C9PZ 8620 FY	7455	Belt - Air Brake Compr.	C9PZ 8620 BH	◆9412HD
B600; B700; B750			Hose - Upper		≈<20450
Belt - Fan & Alt.; W/42A., 55A., 61A., 65A. Alt.	C9PZ 8620 BV	②◆◆9440HD		or	25476
Belt - Fan & Alt.; W/105A. Alt.	C9PZ 8620 CB	②◆◆9463HD	Hose - Lower		20475
Belt - P.S.	C9PZ 8620 BM	◆9400HD		or	26502
Belt - Air Brake Compr.	C9PZ 8620 CM	◆9520HD			
Belt - A.C.	C9PZ 8620 BH	◆9370HD			
Belt - A.P.	C9PZ 8620 FY	7455			
Hose - Upper; Single I.D. Hose		≈<20957			
Hose - Upper; Dual I.D. Hose; W/1 3/4" Offset		21118			
Hose - Upper; Dual I.D. Hose; W/3 5/8" Offset		21078			
Hose - Lower - Eng. To Pipe; Strt. Hose		24232			

◆Standard Belt Available.
②Two Required.

≈<Cut to Fit.
◆PowerBand Belt May Work, Use Template to Check.

Belts and Coolant Hose for School Buses

Application	Mfr. Part No.	Our No.	Application	Mfr. Part No.	Our No.
Ford - Continued			Ford - Continued		
1970 - Continued			1970 - Continued		
Ford 6-Cyl. 300 - Continued			Ford V-8 361 - Continued		
B500; B600 - Continued			B600; B700; B750 - Continued		
Belt - Fan & Alt.; W/65A., 70A. Alt.; W/H.D.			Hose - By Pass - Right Side; Ser. No. T40001 & After		21258
Eng.	C9PZ 8620 GJ	②7430	Ford V-8 391		
Belt - Fan & Alt.; W/60A., 65A. Alt.; W/H.D.			B500		
Eng.	C9PZ 8620 BY	②◆◆9447HD	Belt - Fan & Alt.; W/42A., 55A., 61A., 65A.		
Belt - P.S.	C9PZ 8620 BH	◆9370HD	Alt.	C9PZ 8620 BV	②◆◆9440HD
Belt - Air Brake Compr.	C9PZ 8620 BH	◆9412HD	Belt - Fan & Alt.; W/105A. Alt.	C9PZ 8620 CB	②◆◆9463HD
Hose - Upper		≈<20450	Belt - P.S.	C9PZ 8620 BM	◆9400HD
	or	25476	Belt - Air Brake Compr.	C9PZ 8620 CM	◆9520HD
Hose - Lower		20475	Belt - A.C.	C9PZ 8620 BH	◆9370HD
	or	26502	Belt - A.P.	C9PZ 8620 FY	7455
Ford V-8 330			B600; B700; B750		
B500			Belt - Fan & Alt.; W/42A., 55A., 61A., 65A.		
Belt - Fan & Alt.; W/42A., 55A., 61A., 65A.			Alt.	C9PZ 8620 BV	②◆◆9440HD
Alt.	C9PZ 8620 BV	②◆◆9440HD	Belt - Fan & Alt.; W/105A. Alt.	C9PZ 8620 CB	②◆◆9463HD
Belt - Fan & Alt.; W/105A. Alt.	C9PZ 8620 CB	②◆◆9463HD	Belt - P.S.	C9PZ 8620 BM	◆9400HD
Belt - P.S.	C9PZ 8620 BM	◆9400HD	Belt - Air Brake Compr.	C9PZ 8620 CM	◆9520HD
Belt - Air Brake Compr.	C9PZ 8620 CM	◆9520HD	Belt - A.C.	C9PZ 8620 BH	◆9370HD
Belt - A.C.	C9PZ 8620 BH	◆9370HD	Belt - A.P.	C9PZ 8620 FY	7455
Belt - A.P.	C9PZ 8620 FY	7455	Hose - Upper; Single I.D. Hose		≈<20957
B600; B700; B750			Hose - Upper; Dual I.D. Hose; W/1 3/4" Offset		21118
Belt - Fan & Alt.; W/42A., 55A., 61A., 65A.			Hose - Upper; Dual I.D. Hose; W/3 5/8" Offset		21078
Alt.	C9PZ 8620 BV	②◆◆9440HD	Hose - Lower - Eng. To Pipe; Strt. Hose		24232
Belt - Fan & Alt.; W/105A. Alt.	C9PZ 8620 CB	②◆◆9463HD	Hose - Lower - Eng. To Pipe; Molded Hose		≈<20685
Belt - P.S.	C9PZ 8620 BM	◆9400HD	Hose - Lower - Pipe To Rad.		≈<20685
Belt - Air Brake Compr.	C9PZ 8620 CM	◆9520HD	Hose - By Pass - Left Side; Ser. No. T40001 & After;		
Belt - A.C.	C9PZ 8620 BH	◆9370HD	Molded Hose		21257
Belt - A.P.	C9PZ 8620 FY	7455	Hose - By Pass - Left Side; Ser. No. T40001 & After;		
Hose - Upper; Single I.D. Hose		≈<20957	Strt. Hose		28441
Hose - Upper; Dual I.D. Hose; W/1 3/4" Offset		21118	Hose - By Pass - Right Side; Ser. No. T40001 & After		21258
Hose - Upper; Dual I.D. Hose; W/3 5/8" Offset		21078	1969 - 1968		
Hose - Lower - Eng. To Pipe; Strt. Hose		24232	Caterpillar V-8 522 Diesel		
Hose - Lower - Eng. To Pipe; Molded Hose		≈<20685	B6000; B7000		
Hose - Lower - Pipe To Rad.		≈<20685	Belt - Fan & Alt.; W/40A., 42A., 55A., 60A.,		
Hose - By Pass - Left Side; Ser. No. T40001 & After;			70A. Alt.	C9PZ 8620 DE	②◆◆9610HD
Molded Hose		21257	Belt - Fan & Alt.; W/65A. Alt.	C9PZ 8620 DG	②◆◆9625HD
Hose - By Pass - Left Side; Ser. No. T40001 & After;			Belt - Fan & Alt.; W/105A. Alt.	C9PZ 8620 DP	②◆◆9670HD
Strt. Hose		28441	Belt - P.S.	C9PZ 8620 BH	◆9370HD
Hose - By Pass - Right Side; Ser. No. T40001 & After		21258	Belt - Air Brake Compr.	DOHA 8620 U	◆9550HD
Ford V-8 361			Belt - A.P.	C7TA 8620 S	◆9530HD
B500			Belt - Hyd. Brake Boost Pump	DOAZ 8620 E	◆9525HD
Belt - Fan & Alt.; W/42A., 55A., 61A., 65A.			Hose - Lower		≈<21379
Alt.	C9PZ 8620 BV	②◆◆9440HD	Hose - Oil Cooler Inlet		21381
Belt - Fan & Alt.; W/105A. Alt.	C9PZ 8620 CB	②◆◆9463HD	Hose - Oil Cooler Outlet		21380
Belt - P.S.	C9PZ 8620 BM	◆9400HD	Hose - Heater		28441
Belt - Air Brake Compr.	C9PZ 8620 CM	◆9520HD	Caterpillar V-8 573 Diesel		
Belt - A.C.	C9PZ 8620 BH	◆9370HD	B7000		
Belt - A.P.	C9PZ 8620 FY	7455	Belt - Fan & Alt.; W/42A., 55A., 61A., 70A.		
B600; B700; B750			Alt.	DOHA 8620 AA	②◆◆9610HD
Belt - Fan & Alt.; W/42A., 55A., 61A., 65A.			Belt - Fan & Alt.; W/65A. Alt.		②◆◆9620HD
Alt.	C9PZ 8620 BV	②◆◆9440HD	Belt - Fan & Alt.; W/105A. Alt.		②◆◆9630HD
Belt - Fan & Alt.; W/105A. Alt.	C9PZ 8620 CB	②◆◆9463HD	Belt - P.S.		◆9370HD
Belt - P.S.	C9PZ 8620 BM	◆9400HD	Belt - Air Brake Compr.	DOHA 8620 U	◆9550HD
Belt - Air Brake Compr.	C9PZ 8620 CM	◆9520HD	Belt - V.P.	DOHA 8620 AG	◆9525HD
Belt - A.C.	C9PZ 8620 BH	◆9370HD	Hose - Lower		≈<21379
Belt - A.P.	C9PZ 8620 FY	7455	Hose - Oil Cooler Inlet		21381
Hose - Upper; Single I.D. Hose		≈<20957	Hose - Oil Cooler Outlet		21380
Hose - Upper; Dual I.D. Hose; W/1 3/4" Offset		21118	Dorset 6-Cyl. 363 Diesel		
Hose - Upper; Dual I.D. Hose; W/3 5/8" Offset		21078	B6000; B7000		
Hose - Lower - Eng. To Pipe; Strt. Hose		24232	Belt - Alt.; W/45A., 55A. Alt.		
Hose - Lower - Eng. To Pipe; Molded Hose		≈<20685	Belt - Alt.; W/65A. Alt.	C7TA 8620 B	◆9500HD
Hose - Lower - Pipe To Rad.		≈<20685	Belt - P.S.	C7TA 8620 S	◆9540HD
Hose - By Pass - Left Side; Ser. No. T40001 & After;			Hose - Upper		≈<20475
Molded Hose		21257			
Hose - By Pass - Left Side; Ser. No. T40001 & After;					
Strt. Hose		28441			

◆Standard Belt Available.
②Two Required.

◆PowerBand Belt May Work, Use Template to Check.
≈<Cut to Fit.

Belts and Coolant Hose for School Buses

Application	Mfr. Part No.	Our No.	Application	Mfr. Part No.	Our No.
Ford - Continued			Ford - Continued		
1969 - 1968 - Continued			1969 - 1968 - Continued		
Dorset 6-Cyl. 363 Diesel - Continued			Ford V-8 361 - Continued		
B6000; B7000 - Continued			B600; B700; B750 - Continued		
Hose - Lower		24228	Belt - P.S.	C9PZ 8620 BM	▲9400HD
Ford 6-Cyl. 240			Belt - Air Brake Compr.	C9PZ 8620 CM	▲9520HD
B500; B600			Hose - Upper; Single I.D. Hose		≈20957
Belt - Fan & Alt.; W/38A., 42A., Y45A.,			Hose - Upper; Dual I.D. Hose; W/1 3/4" Offset		21118
55A. Alt.	C9PZ 8620 V	②7417	Hose - Upper; Dual I.D. Hose; W/3 5/8" Offset		21078
Belt - Fan & Alt.; W/65A., 70A. Alt.	C9PZ 8620 GJ	②7430	Hose - Lower - Eng. To Pipe; Strt. Hose		24232
Belt - P.S.	C9PZ 8620 BH	▲9370HD	Hose - Lower - Eng. To Pipe; Molded Hose		≈20685
Belt - Air Brake Compr.	C9PZ 8620 BH	▲9412HD	Hose - Lower - Pipe To Rad.		≈20685
Hose - Upper		≈20450	Hose - By Pass - Left Side; Ser. No. T40001 & After;		
	or	25476	Molded Hose		21257
Hose - Lower		20475	Hose - By Pass - Left Side; Ser. No. T40001 & After;		
	or	26502	Strt. Hose		28441
Ford 6-Cyl. 300			Hose - By Pass - Right Side; Ser. No. T40001 & After		21258
B500; B600			Ford V-8 391		
Belt - Fan & Alt.; W/38A., 42A., Y45A.,			B500		
55A. Alt.; W/L.D. Eng.	C9PZ 8620 V	②7417	Belt - Fan; W/High Mount Fan	C9PZ 8620 FK	TR28480
Belt - Fan & Alt.; W/38A., 42A., 45A., 55A.			Belt - Fan & Alt.; W/O 60A., 100A. Alt.	C9PZ 8620 CB	②▲◆9463HD
Alt.; W/H.D. Eng.	C9PZ 8620 BS	②▲9425HD	Belt - Fan & Alt.; W/60A., 100A. Alt.	C9PZ 8620 CF	②▲◆9476HD
Belt - Fan & Alt.; W/65A., 70A. Alt.; W/H.D.			Belt - P.S.	C9PZ 8620 BM	▲9400HD
Eng.	C9PZ 8620 GJ	②7430	Belt - Air Brake Compr.	C9PZ 8620 CM	▲9520HD
Belt - Fan & Alt.; W/60A., 65A. Alt.; W/H.D.			B600; B700; B750		
Eng.	C9PZ 8620 BY	②▲◆9447HD	Belt - Fan; W/High Mount Fan	C9PZ 8620 FK	TR28480
Belt - P.S.	C9PZ 8620 BH	▲9370HD	Belt - Fan & Alt.; W/O 60A., 100A. Alt.	C9PZ 8620 CB	②▲◆9463HD
Belt - Air Brake Compr.	C9PZ 8620 BH	▲9412HD	Belt - Fan & Alt.; W/60A., 100A. Alt.	C9PZ 8620 CF	②▲◆9476HD
Hose - Upper		≈20450	Belt - P.S.	C9PZ 8620 BM	▲9400HD
	or	25476	Belt - Air Brake Compr.	C9PZ 8620 CM	▲9520HD
Hose - Lower		20475	B600; B700; B750		
	or	26502	Belt - Fan; W/High Mount Fan	C9PZ 8620 FK	TR28480
Ford V-8 330			Belt - Fan & Alt.; W/O 60A., 100A. Alt.	C9PZ 8620 CB	②▲◆9463HD
B500			Belt - Fan & Alt.; W/60A., 100A. Alt.	C9PZ 8620 CF	②▲◆9476HD
Belt - Fan; W/High Mount Fan	C9PZ 8620 FK	TR28480	Belt - P.S.	C9PZ 8620 BM	▲9400HD
Belt - Fan & Alt.; W/O 60A., 100A. Alt.	C9PZ 8620 CB	②▲◆9463HD	Belt - Air Brake Compr.	C9PZ 8620 CM	▲9520HD
Belt - Fan & Alt.; W/60A., 100A. Alt.	C9PZ 8620 CF	②▲◆9476HD	B600; B700; B750		
Belt - P.S.	C9PZ 8620 BM	▲9400HD	Belt - Fan; W/High Mount Fan	C9PZ 8620 FK	TR28480
Belt - Air Brake Compr.	C9PZ 8620 CM	▲9520HD	Belt - Fan & Alt.; W/O 60A., 100A. Alt.	C9PZ 8620 CB	②▲◆9463HD
Hose - Upper; Single I.D. Hose		≈20957	Belt - Fan & Alt.; W/60A., 100A. Alt.	C9PZ 8620 CF	②▲◆9476HD
Hose - Upper; Dual I.D. Hose; W/1 3/4" Offset		21118	Belt - P.S.	C9PZ 8620 BM	▲9400HD
Hose - Upper; Dual I.D. Hose; W/3 5/8" Offset		21078	Belt - Air Brake Compr.	C9PZ 8620 CM	▲9520HD
Hose - Lower - Eng. To Pipe; Strt. Hose		24232	Hose - Upper; Single I.D. Hose		≈20957
Hose - Lower - Eng. To Pipe; Molded Hose		≈20685	Hose - Upper; Dual I.D. Hose; W/1 3/4" Offset		21118
Hose - Lower - Pipe To Rad.		≈20685	Hose - Upper; Dual I.D. Hose; W/3 5/8" Offset		21078
Hose - By Pass - Left Side; Ser. No. T40001 & After;			Hose - Lower - Eng. To Pipe; Strt. Hose		24232
Molded Hose		21257	Hose - Lower - Eng. To Pipe; Molded Hose		≈20685
Hose - By Pass - Left Side; Ser. No. T40001 & After;			Hose - Lower - Pipe To Rad.		≈20685
Strt. Hose		28441	Hose - By Pass - Left Side; Ser. No. T40001 & After;		
Hose - By Pass - Right Side; Ser. No. T40001 & After		21258	Molded Hose		21257
Ford V-8 361			Hose - By Pass - Left Side; Ser. No. T40001 & After;		
B500			Strt. Hose		28441
Belt - Fan; W/High Mount Fan	C9PZ 8620 FK	TR28480	Hose - By Pass - Right Side; Ser. No. T40001 & After		21258
Belt - Fan & Alt.; W/O 60A., 100A. Alt.	C9PZ 8620 CB	②▲◆9463HD	1967		
Belt - Fan & Alt.; W/60A., 100A. Alt.	C9PZ 8620 CF	②▲◆9476HD	Caterpillar V-8 522 Diesel		
Belt - P.S.	C9PZ 8620 BM	▲9400HD	B6000		
Belt - Air Brake Compr.	C9PZ 8620 CM	▲9520HD	Belt - Fan & Alt.; W/40A., 42A., 55A., 60A.,		
Hose - Upper; Single I.D. Hose		≈20957	70A. Alt.		
Hose - Upper; Dual I.D. Hose; W/1 3/4" Offset		21118		C9PZ 8620 DE	②▲◆9610HD
Hose - Upper; Dual I.D. Hose; W/3 5/8" Offset		21078	Belt - Fan & Alt.; W/65A. Alt.	C9PZ 8620 DG	②▲◆9625HD
Hose - Lower - Eng. To Pipe; Strt. Hose		24232	Belt - Fan & Alt.; W/105A. Alt.	C9PZ 8620 DP	②▲◆9670HD
Hose - Lower - Eng. To Pipe; Molded Hose		≈20685	Belt - P.S.	C9PZ 8620 BH	▲9370HD
Hose - Lower - Pipe To Rad.		≈20685	Belt - Air Brake Compr.	D0HA 8620 U	▲9550HD
Hose - By Pass - Left Side; Ser. No. T40001 & After;			Belt - A.P.	C7TA 8620 S	▲9530HD
Molded Hose		21257	Belt - Hyd. Brake Boost Pump	D0AZ 8620 E	▲9525HD
Hose - By Pass - Left Side; Ser. No. T40001 & After;			Hose - Lower		≈21379
Strt. Hose		28441	Hose - Oil Cooler Inlet		21381
Hose - By Pass - Right Side; Ser. No. T40001 & After		21258	Hose - Oil Cooler Outlet		21380
Ford V-8 361			Hose - Heater		28441
B500			Dorset 6-Cyl. 363 Diesel		
Belt - Fan; W/High Mount Fan	C9PZ 8620 FK	TR28480	B6000; B7000		
Belt - Fan & Alt.; W/O 60A., 100A. Alt.	C9PZ 8620 CB	②▲◆9463HD	Belt - Alt.; W/45A., 55A. Alt.		
Belt - Fan & Alt.; W/60A., 100A. Alt.	C9PZ 8620 CF	②▲◆9476HD	C7TA 8620 A		
Belt - P.S.	C9PZ 8620 BM	▲9400HD	Belt - Alt.; W/65A. Alt.		
Belt - Air Brake Compr.	C9PZ 8620 CM	▲9520HD	C7TA 8620 B		
B600; B700; B750			Belt - P.S.		
Belt - Fan; W/High Mount Fan	C9PZ 8620 FK	TR28480	C7TA 8620 S		
Belt - Fan & Alt.; W/O 60A., 100A. Alt.	C9PZ 8620 CB	②▲◆9463HD	Hose - Upper		
Belt - Fan & Alt.; W/60A., 100A. Alt.	C9PZ 8620 CF	②▲◆9476HD	≈20475		
Belt - P.S.	C9PZ 8620 BM	▲9400HD	Hose - Lower		
Belt - Air Brake Compr.	C9PZ 8620 CM	▲9520HD	24228		

②Two Required.
≈Cut to Fit.

▲Standard Belt Available.
◆PowerBand Belt May Work, Use Template to Check.

School Buses

Belts and Coolant Hose for School Buses

School Buses

Application	Mfr. Part No.	Our No.
Ford - Continued		
1967 - Continued		
Ford 6-Cyl. 240		
B500; B600		
Belt - Fan & Alt.; W/38A., 42A., Y45A., 55A. Alt.	C9PZ 8620 V	②7417
Belt - Fan & Alt.; W/65A., 70A. Alt.	C9PZ 8620 GJ	②7430
Belt - P.S.	C9PZ 8620 BH	♣9370HD
Belt - Air Brake Compr.	C9PZ 8620 BH	♣9412HD
Hose - Upper		≈<20450
	or	25476
Hose - Lower		20475
	or	26502
Ford 6-Cyl. 300		
B500; B600		
Belt - Fan & Alt.; W/38A., 42A., Y45A., 55A. Alt.; W/L.D. Eng.	C9PZ 8620 V	②7417
Belt - Fan & Alt.; W/38A., 42A., 45A., 55A. Alt.; W/H.D. Eng.	C9PZ 8620 BS	②♣9425HD
Belt - Fan & Alt.; W/65A., 70A. Alt.; W/H.D. Eng.	C9PZ 8620 GJ	②7430
Belt - Fan & Alt.; W/60A., 65A. Alt.; W/H.D. Eng.	C9PZ 8620 BY	②♣♣9447HD
Belt - P.S.	C9PZ 8620 BH	♣9370HD
Belt - Air Brake Compr.	C9PZ 8620 BH	♣9412HD
Hose - Upper		≈<20450
	or	25476
Hose - Lower		20475
	or	26502
Ford V-8 330		
B500		
Belt - Fan; W/High Mount Fan	C9PZ 8620 FK	TR28480
Belt - Fan & Alt.; W/O 60A., 100A. Alt.	C9PZ 8620 CB	②♣♣9463HD
Belt - Fan & Alt.; W/60A., 100A. Alt.	C9PZ 8620 CF	②♣♣9476HD
Belt - P.S.	C9PZ 8620 BM	♣9400HD
Belt - Air Brake Compr.	C9PZ 8620 CM	♣9520HD
B600; B700; B750		
Belt - Fan; W/High Mount Fan	C9PZ 8620 FK	TR28480
Belt - Fan & Alt.; W/O 60A., 100A. Alt.	C9PZ 8620 CB	②♣♣9463HD
Belt - Fan & Alt.; W/60A., 100A. Alt.	C9PZ 8620 CF	②♣♣9476HD
Belt - P.S.	C9PZ 8620 BM	♣9400HD
Belt - Air Brake Compr.	C9PZ 8620 CM	♣9520HD
Hose - Upper; Single I.D. Hose		≈<20957
Hose - Upper; Dual I.D. Hose; W/1 3/4" Offset		21118
Hose - Upper; Dual I.D. Hose; W/3 5/8" Offset		21078
Hose - Lower - Eng. To Pipe; Strt. Hose		24232
Hose - Lower - Eng. To Pipe; Molded Hose		≈<20685
Hose - Lower - Pipe To Rad.		≈<20685
Hose - By Pass - Left Side; Ser. No. T40001 & After; Molded Hose		21257
Hose - By Pass - Left Side; Ser. No. T40001 & After; Strt. Hose		28441
Hose - By Pass - Right Side; Ser. No. T40001 & After		21258
Ford V-8 361		
B500		
Belt - Fan; W/High Mount Fan	C9PZ 8620 FK	TR28480
Belt - Fan & Alt.; W/O 60A., 100A. Alt.	C9PZ 8620 CB	②♣♣9463HD
Belt - Fan & Alt.; W/60A., 100A. Alt.	C9PZ 8620 CF	②♣♣9476HD
Belt - P.S.	C9PZ 8620 BM	♣9400HD
Belt - Air Brake Compr.	C9PZ 8620 CM	♣9520HD
B600; B700; B750		
Belt - Fan; W/High Mount Fan	C9PZ 8620 FK	TR28480
Belt - Fan & Alt.; W/O 60A., 100A. Alt.	C9PZ 8620 CB	②♣♣9463HD
Belt - Fan & Alt.; W/60A., 100A. Alt.	C9PZ 8620 CF	②♣♣9476HD
Belt - P.S.	C9PZ 8620 BM	♣9400HD
Belt - Air Brake Compr.	C9PZ 8620 CM	♣9520HD
Hose - Upper; Single I.D. Hose		≈<20957
Hose - Upper; Dual I.D. Hose; W/1 3/4" Offset		21118

②Two Required.
≈<Cut to Fit.

Application	Mfr. Part No.	Our No.
Ford - Continued		
1967 - Continued		
Ford V-8 361 - Continued		
B600; B700; B750 - Continued		
Hose - Upper; Dual I.D. Hose; W/3 5/8" Offset		21078
Hose - Lower - Eng. To Pipe; Strt. Hose		24232
Hose - Lower - Eng. To Pipe; Molded Hose		≈<20685
Hose - Lower - Pipe To Rad.		≈<20685
Hose - By Pass - Left Side; Ser. No. T40001 & After; Molded Hose		21257
Hose - By Pass - Left Side; Ser. No. T40001 & After; Strt. Hose		28441
Hose - By Pass - Right Side; Ser. No. T40001 & After		21258
Ford V-8 391		
B500		
Belt - Fan; W/High Mount Fan	C9PZ 8620 FK	TR28480
Belt - Fan & Alt.; W/O 60A., 100A. Alt.	C9PZ 8620 CB	②♣♣9463HD
Belt - Fan & Alt.; W/60A., 100A. Alt.	C9PZ 8620 CF	②♣♣9476HD
Belt - P.S.	C9PZ 8620 BM	♣9400HD
Belt - Air Brake Compr.	C9PZ 8620 CM	♣9520HD
B600; B700; B750		
Belt - Fan; W/High Mount Fan	C9PZ 8620 FK	TR28480
Belt - Fan & Alt.; W/O 60A., 100A. Alt.	C9PZ 8620 CB	②♣♣9463HD
Belt - Fan & Alt.; W/60A., 100A. Alt.	C9PZ 8620 CF	②♣♣9476HD
Belt - P.S.	C9PZ 8620 BM	♣9400HD
Belt - Air Brake Compr.	C9PZ 8620 CM	♣9520HD
Hose - Upper; Single I.D. Hose		≈<20957
Hose - Upper; Dual I.D. Hose; W/1 3/4" Offset		21118
Hose - Upper; Dual I.D. Hose; W/3 5/8" Offset		21078
Hose - Lower - Eng. To Pipe; Strt. Hose		24232
Hose - Lower - Eng. To Pipe; Molded Hose		≈<20685
Hose - Lower - Pipe To Rad.		≈<20685
Hose - By Pass - Left Side; Ser. No. T40001 & After; Molded Hose		21257
Hose - By Pass - Left Side; Ser. No. T40001 & After; Strt. Hose		28441
Hose - By Pass - Right Side; Ser. No. T40001 & After		21258
1966 - 1965		
Ford 6-Cyl. 240		
B500; B600		
Belt - Fan & Alt.; W/38A., 42A., Y45A., 55A. Alt.	C9PZ 8620 V	②7417
Belt - Fan & Alt.; W/65A., 70A. Alt.	C9PZ 8620 GJ	②7430
Belt - P.S.	C9PZ 8620 BH	♣9370HD
Belt - Air Brake Compr.	C9PZ 8620 BH	♣9412HD
Hose - Upper		≈<20450
	or	25476
Hose - Lower		20475
	or	26502
Ford 6-Cyl. 300		
B500; B600		
Belt - Fan & Alt.; W/38A., 42A., Y45A., 55A. Alt.; W/L.D. Eng.	C9PZ 8620 V	②7417
Belt - Fan & Alt.; W/38A., 42A., 45A., 55A. Alt.; W/H.D. Eng.	C9PZ 8620 BS	②♣9425HD
Belt - Fan & Alt.; W/65A., 70A. Alt.; W/H.D. Eng.	C9PZ 8620 GJ	②7430
Belt - Fan & Alt.; W/60A., 65A. Alt.; W/H.D. Eng.	C9PZ 8620 BY	②♣♣9447HD
Belt - P.S.	C9PZ 8620 BH	♣9370HD
Belt - Air Brake Compr.	C9PZ 8620 BH	♣9412HD
Hose - Upper		≈<20450
	or	25476
Hose - Lower		20475
	or	26502

♣Standard Belt Available.
◆PowerBand Belt May Work, Use Template to Check.

Belts and Coolant Hose for School Buses

Application	Mfr. Part No.	Our No.	Application	Mfr. Part No.	Our No.
Ford - Continued			Ford - Continued		
1966 - 1965 - Continued			1964		
Ford V-8 330			Ford 6-Cyl. 223		
B500			B500; B600		
Belt - Fan; W/High Mount Fan	C9PZ 8620 FK	TR28480	Belt - Fan & Alt.	C4TE 8620 S	②7405
Belt - Fan & Alt.; W/O 60A., 100A. Alt.	C9PZ 8620 CB	②◆◆9463HD	Belt - Fan & Gen.	C4TE 8620 S	7405
Belt - Fan & Alt.; W/60A., 100A. Alt.	C9PZ 8620 CF	②◆◆9476HD	Hose - Upper		20450
Belt - P.S.	C9PZ 8620 BM	◆9400HD		or	25474
Belt - Air Brake Compr.	C9PZ 8620 CM	◆9520HD	Hose - Lower		≈20584
B600; B700; B750				or	26611
Belt - Fan; W/High Mount Fan	C9PZ 8620 FK	TR28480	Ford 6-Cyl. 262		
Belt - Fan & Alt.; W/O 60A., 100A. Alt.	C9PZ 8620 CB	②◆◆9463HD	B500; B600		
Belt - Fan & Alt.; W/60A., 100A. Alt.	C9PZ 8620 CF	②◆◆9476HD	Belt - Fan & Alt.	C6TE 8620 D	②7450
Belt - P.S.	C9PZ 8620 BM	◆9400HD	Belt - Fan & Gen.	C8DE 8620 B	②7450
Belt - Air Brake Compr.	C9PZ 8620 CM	◆9520HD	Belt - P.S.	EAM 2890 A	◆9341HD
Hose - Upper; Single I.D. Hose		≈20957	Belt - Air Brake Compr.	C2AE 8620 S	◆9365HD
Hose - Upper; Dual I.D. Hose; W/1 3/4" Offset		21118	Hose - Upper		20450
Hose - Upper; Dual I.D. Hose; W/3 5/8" Offset		21078		or	25474
Hose - Lower - Eng. To Pipe; Strt. Hose		24232	Ford V-8 292		
Hose - Lower - Eng. To Pipe; Molded Hose		≈20685	B500; B600; B700		
Hose - Lower - Pipe To Rad.		≈20685	Belt - Fan & Alt.; W/Single Belt	C4TE 8620 AD	7450
Hose - By Pass - Left Side; Ser. No. T40001 & After		21257	Belt - Fan & Alt.; W/Dual Belts	C4TE 8620 AD	②7450
	or	28441	Belt - P.S.	C2AE 8620 L	◆9415HD
Hose - By Pass - Right Side; Ser. No. T40001 & After		21258	Belt - Air Brake Compr.	C2TE 8620 U	◆9500HD
Ford V-8 361			Hose - Upper		≈20380
B500				or	25478
Belt - Fan; W/High Mount Fan	C9PZ 8620 FK	TR28480	Hose - Lower		≈20276
Belt - Fan & Alt.; W/O 60A., 100A. Alt.	C9PZ 8620 CB	②◆◆9463HD		or	26504
Belt - Fan & Alt.; W/60A., 100A. Alt.	C9PZ 8620 CF	②◆◆9476HD	Hose - By Pass		28441
Belt - P.S.	C9PZ 8620 BM	◆9400HD	Ford V-8 330		
Belt - Air Brake Compr.	C9PZ 8620 CM	◆9520HD	B500		
B600; B700; B750			Belt - Fan; W/High Mount Fan	C9PZ 8620 FK	TR28480
Belt - Fan; W/High Mount Fan	C9PZ 8620 FK	TR28480	Belt - Fan & Alt.; W/O 60A., 100A. Alt.	C9PZ 8620 CB	②◆◆9463HD
Belt - Fan & Alt.; W/O 60A., 100A. Alt.	C9PZ 8620 CB	②◆◆9463HD	Belt - Fan & Alt.; W/60A., 100A. Alt.	C9PZ 8620 CF	②◆◆9476HD
Belt - Fan & Alt.; W/60A., 100A. Alt.	C9PZ 8620 CF	②◆◆9476HD	Belt - P.S.	C9PZ 8620 BM	◆9400HD
Belt - P.S.	C9PZ 8620 BM	◆9400HD	Belt - Air Brake Compr.	C9PZ 8620 CM	◆9520HD
Belt - Air Brake Compr.	C9PZ 8620 CM	◆9520HD	B600; B700; B750		
Hose - Upper; Single I.D. Hose		≈20957	Belt - Fan; W/High Mount Fan	C9PZ 8620 FK	TR28480
Hose - Upper; Dual I.D. Hose; W/1 3/4" Offset		21118	Belt - Fan & Alt.; W/O 60A., 100A. Alt.	C9PZ 8620 CB	②◆◆9463HD
Hose - Upper; Dual I.D. Hose; W/3 5/8" Offset		21078	Belt - Fan & Alt.; W/60A., 100A. Alt.	C9PZ 8620 CF	②◆◆9476HD
Hose - Lower - Eng. To Pipe; Strt. Hose		24232	Belt - P.S.	C9PZ 8620 BM	◆9400HD
Hose - Lower - Eng. To Pipe; Molded Hose		≈20685	Belt - Air Brake Compr.	C9PZ 8620 CM	◆9520HD
Hose - Lower - Pipe To Rad.		≈20685	Hose - Upper; Single I.D. Hose		≈20957
Hose - By Pass - Left Side; Ser. No. T40001 & After		21257	Hose - Upper; Dual I.D. Hose; W/1 3/4" Offset		21118
	or	28441	Hose - Upper; Dual I.D. Hose; W/3 5/8" Offset		21078
Hose - By Pass - Right Side; Ser. No. T40001 & After		21258	Hose - Lower - Eng. To Pipe; Strt. Hose		24232
Ford V-8 391			Hose - Lower - Eng. To Pipe; Molded Hose		≈20685
B500			Hose - Lower - Pipe To Rad.		≈20685
Belt - Fan; W/High Mount Fan	C9PZ 8620 FK	TR28480	Hose - By Pass - Left Side; Ser. No. T40001 & After		21257
Belt - Fan & Alt.; W/O 60A., 100A. Alt.	C9PZ 8620 CB	②◆◆9463HD		or	28441
Belt - Fan & Alt.; W/60A., 100A. Alt.	C9PZ 8620 CF	②◆◆9476HD	Hose - By Pass - Right Side; Ser. No. T40001 & After		21258
Belt - P.S.	C9PZ 8620 BM	◆9400HD	Ford V-8 359		
Belt - Air Brake Compr.	C9PZ 8620 CM	◆9520HD	B500		
B600; B700; B750			Belt - Fan; W/High Mount Fan	C9PZ 8620 FK	TR28480
Belt - Fan; W/High Mount Fan	C9PZ 8620 FK	TR28480	Belt - Fan & Alt.; W/O 60A., 100A. Alt.	C9PZ 8620 CB	②◆◆9463HD
Belt - Fan & Alt.; W/O 60A., 100A. Alt.	C9PZ 8620 CB	②◆◆9463HD	Belt - Fan & Alt.; W/60A., 100A. Alt.	C9PZ 8620 CF	②◆◆9476HD
Belt - Fan & Alt.; W/60A., 100A. Alt.	C9PZ 8620 CF	②◆◆9476HD	Belt - P.S.	C9PZ 8620 BM	◆9400HD
Belt - P.S.	C9PZ 8620 BM	◆9400HD	Belt - Air Brake Compr.	C9PZ 8620 CM	◆9520HD
Belt - Air Brake Compr.	C9PZ 8620 CM	◆9520HD	B600; B700; B750		
Hose - Upper; Single I.D. Hose		≈20957	Belt - Fan; W/High Mount Fan	C9PZ 8620 FK	TR28480
Hose - Upper; Dual I.D. Hose; W/1 3/4" Offset		21118	Belt - Fan & Alt.; W/O 60A., 100A. Alt.	C9PZ 8620 CB	②◆◆9463HD
Hose - Upper; Dual I.D. Hose; W/3 5/8" Offset		21078	Belt - Fan & Alt.; W/60A., 100A. Alt.	C9PZ 8620 CF	②◆◆9476HD
Hose - Lower - Eng. To Pipe; Strt. Hose		24232	Belt - P.S.	C9PZ 8620 BM	◆9400HD
Hose - Lower - Eng. To Pipe; Molded Hose		≈20685	Belt - Air Brake Compr.	C9PZ 8620 CM	◆9520HD
Hose - Lower - Pipe To Rad.		≈20685	Hose - Upper; Single I.D. Hose		≈20957
Hose - By Pass - Left Side; Ser. No. T40001 & After		21257	Hose - Upper; Dual I.D. Hose; W/1 3/4" Offset		21118
	or	28441			
Hose - By Pass - Right Side; Ser. No. T40001 & After		21258			

◆Standard Belt Available.
②Two Required.

◆PowerBand Belt May Work. Use Template to Check.
≈Cut to Fit.

Belts and Coolant Hose for School Buses

School Buses

Application	Mfr. Part No.	Our No.
Ford - Continued		
1964 - Continued		
Ford V-8 359 - Continued		
B600; B700; B750 - Continued		
Hose - Upper; Dual I.D. Hose; W/3 5/8" Offset		21078
Hose - Lower - Eng. To Pipe; Strt. Hose		24232
Hose - Lower - Eng. To Pipe; Molded Hose		≈<20685
Hose - Lower - Pipe To Rad.		≈<20685
Hose - By Pass - Left Side; Ser. No. T40001 & After		21257
	or	28441
Hose - By Pass - Right Side; Ser. No. T40001 & After		21258
Ford V-8 361		
B500		
Belt - Fan; W/High Mount Fan	C9PZ 8620 FK	TR28480
Belt - Fan & Alt.; W/O 60A., 100A. Alt.	C9PZ 8620 CB	②◆◆9463HD
Belt - Fan & Alt.; W/60A., 100A. Alt.	C9PZ 8620 CF	②◆◆9476HD
Belt - P.S.	C9PZ 8620 BM	◆9400HD
Belt - Air Brake Compr.	C9PZ 8620 CM	◆9520HD
B600; B700; B750		
Belt - Fan; W/High Mount Fan	C9PZ 8620 FK	TR28480
Belt - Fan & Alt.; W/O 60A., 100A. Alt.	C9PZ 8620 CB	②◆◆9463HD
Belt - Fan & Alt.; W/60A., 100A. Alt.	C9PZ 8620 CF	②◆◆9476HD
Belt - P.S.	C9PZ 8620 BM	◆9400HD
Belt - Air Brake Compr.	C9PZ 8620 CM	◆9520HD
Hose - Upper; Single I.D. Hose		≈<20957
Hose - Upper; Dual I.D. Hose; W/1 3/4" Offset		21118
Hose - Upper; Dual I.D. Hose; W/3 5/8" Offset		21078
Hose - Lower - Eng. To Pipe; Strt. Hose		24232
Hose - Lower - Eng. To Pipe; Molded Hose		≈<20685
Hose - Lower - Pipe To Rad.		≈<20685
Hose - By Pass - Left Side; Ser. No. T40001 & After		21257
	or	28441
Hose - By Pass - Right Side; Ser. No. T40001 & After		21258
Ford V-8 389		
B500		
Belt - Fan; W/High Mount Fan	C9PZ 8620 FK	TR28480
Belt - Fan & Alt.; W/O 60A., 100A. Alt.	C9PZ 8620 CB	②◆◆9463HD
Belt - Fan & Alt.; W/60A., 100A. Alt.	C9PZ 8620 CF	②◆◆9476HD
Belt - P.S.	C9PZ 8620 BM	◆9400HD
Belt - Air Brake Compr.	C9PZ 8620 CM	◆9520HD
B600; B700; B750		
Belt - Fan; W/High Mount Fan	C9PZ 8620 FK	TR28480
Belt - Fan & Alt.; W/O 60A., 100A. Alt.	C9PZ 8620 CB	②◆◆9463HD
Belt - Fan & Alt.; W/60A., 100A. Alt.	C9PZ 8620 CF	②◆◆9476HD
Belt - P.S.	C9PZ 8620 BM	◆9400HD
Belt - Air Brake Compr.	C9PZ 8620 CM	◆9520HD
Hose - Upper; Single I.D. Hose		≈<20957
Hose - Upper; Dual I.D. Hose; W/1 3/4" Offset		21118
Hose - Upper; Dual I.D. Hose; W/3 5/8" Offset		21078
Hose - Lower - Eng. To Pipe; Strt. Hose		24232
Hose - Lower - Eng. To Pipe; Molded Hose		≈<20685
Hose - Lower - Pipe To Rad.		≈<20685
Hose - By Pass - Left Side; Ser. No. T40001 & After		21257
	or	28441
Hose - By Pass - Right Side; Ser. No. T40001 & After		21258
Ford V-8 391		
B500		
Belt - Fan; W/High Mount Fan	C9PZ 8620 FK	TR28480
Belt - Fan & Alt.; W/O 60A., 100A. Alt.	C9PZ 8620 CB	②◆◆9463HD
Belt - Fan & Alt.; W/60A., 100A. Alt.	C9PZ 8620 CF	②◆◆9476HD
Belt - P.S.	C9PZ 8620 BM	◆9400HD
Belt - Air Brake Compr.	C9PZ 8620 CM	◆9520HD
B600; B700; B750		
Belt - Fan; W/High Mount Fan	C9PZ 8620 FK	TR28480
Belt - Fan & Alt.; W/O 60A., 100A. Alt.	C9PZ 8620 CB	②◆◆9463HD
Belt - Fan & Alt.; W/60A., 100A. Alt.	C9PZ 8620 CF	②◆◆9476HD
Belt - P.S.	C9PZ 8620 BM	◆9400HD

≈<Cut to Fit.
◆PowerBand Belt May Work, Use Template to Check.

Application	Mfr. Part No.	Our No.
Ford - Continued		
1964 - Continued		
Ford V-8 391 - Continued		
B600; B700; B750 - Continued		
Belt - Air Brake Compr.	C9PZ 8620 CM	◆9520HD
Hose - Upper; Single I.D. Hose		≈<20957
Hose - Upper; Dual I.D. Hose; W/1 3/4" Offset		21118
Hose - Upper; Dual I.D. Hose; W/3 5/8" Offset		21078
Hose - Lower - Eng. To Pipe; Strt. Hose		24232
Hose - Lower - Eng. To Pipe; Molded Hose		≈<20685
Hose - Lower - Pipe To Rad.		≈<20685
Hose - By Pass - Left Side; Ser. No. T40001 & After		21257
	or	28441
Hose - By Pass - Right Side; Ser. No. T40001 & After		21258
1963		
Ford 6-Cyl. 223		
B500; B600		
Belt - Fan & Alt.	C2TE 8620 AD	②7390
Belt - Fan & Gen.; W/40A. Autolite Gen.	C2TE 8620 T	②7380
Belt - Fan & Gen.; W/O 40A. Autolite Gen. .	C6ZE 8620 E	7370
Belt - P.S.		◆9385HD
Hose - Upper		20450
	or	25474
Hose - Lower		≈<20584
	or	26611
Ford 6-Cyl. 262		
B500; B600		
Belt - Fan & Gen.; W/P.S.	C2TE 8620 H	②7460
Belt - Fan & Gen.; W/O P.S.	C4TE 8620 N	②7405
Belt - P.S.	EAM 2890 A	◆9341HD
Hose - Upper		20450
	or	25474
Ford V-8 292		
B500; B600; B700		
Belt - Fan & Alt.; W/Single Belt	C4TE 8620 AD	7450
Belt - Fan & Alt.; W/Dual Belts	C4TE 8620 AD	②7450
Belt - P.S.	C2AE 8620 L	◆9415HD
Belt - Air Brake Compr.	C2TE 8620 U	◆9500HD
Hose - Upper		≈<20380
	or	25478
Hose - Lower		≈<20276
	or	26504
Hose - By Pass		28441
Ford V-8 302		
B750		
Belt - Fan & Gen.; W/44 3/4" Belt O.C.	C2TE 8620 V	②◆◆9447HD
Belt - Fan & Gen.; W/46 1/4" Belt O.C.	ECY 8620 A	②◆◆9463HD
Belt - Fan & Gen.; W/47 1/4" Belt O.C.	C5TE 8620 H	②◆◆9470HD
Belt - P.S.	C3TA 8620 F	◆9380HD
Belt - Air Brake Compr.; W/45 1/4" Belt O.C.	C5TE 8620 A	②◆◆9451HD
Belt - Air Brake Compr.; W/46 1/4" Belt O.C.	C2TE 8620 AG	②◆◆9463HD
Hose - Upper - Eng. To Pipe		≈<20357
Hose - Upper - Pipe To Rad.		②24228
Hose - Lower - Eng. To Pipe		≈<20685
Hose - Lower - Pipe To Rad.		24232
Hose - By Pass		28443
Ford V-8 332		
B750		
Belt - Fan & Gen.; W/44 3/4" Belt O.C.	C2TE 8620 V	②◆◆9447HD
Belt - Fan & Gen.; W/46 1/4" Belt O.C.	ECY 8620 A	②◆◆9463HD
Belt - Fan & Gen.; W/47 1/4" Belt O.C.	C5TE 8620 H	②◆◆9470HD
Belt - P.S.	C3TA 8620 F	◆9380HD

◆Standard Belt Available.
②Two Required.

Belts and Coolant Hose for School Buses

Application	Mfr. Part No.	Our No.	Application	Mfr. Part No.	Our No.
Ford - Continued			Ford - Continued		
1963 - Continued			1962 - 1961 - Continued		
Ford V-8 332 - Continued			Ford V-8 332 - Continued		
B750 - Continued			B750 - Continued		
Belt - Air Brake Compr.; W/45 1/4" Belt			Belt - Air Brake Compr.; W/46 1/4" Belt		
O.C.	C5TE 8620 A	②◆◆9451HD	O.C.	C2TE 8620 AG	②◆◆9463HD
Belt - Air Brake Compr.; W/46 1/4" Belt			Hose - Upper - Eng. To Pipe		≈20357
O.C.	C2TE 8620 AG	②◆◆9463HD	Hose - Upper - Pipe To Rad.		②24228
Hose - Upper - Eng. To Pipe		≈20357	Hose - Lower - Eng. To Pipe		≈20685
Hose - Upper - Pipe To Rad.		②24228	Hose - Lower - Pipe To Rad.		24232
Hose - Lower - Eng. To Pipe		≈20685	Hose - By Pass		28443
Hose - Lower - Pipe To Rad.		24232			
Hose - By Pass		28443			
1962 - 1961			1960		
Ford 6-Cyl. 223			Ford 6-Cyl. 223		
B500; B600			B500; B600		
Belt - Fan & Alt.	C2TE 8620 AD	②7390	Belt - Fan & Alt.	C2TE 8620 AD	②7390
Belt - Fan & Gen.; W/40A. Autolite Gen.	C2TE 8620 T	②7380	Belt - Fan & Gen.; W/40A. Autolite Gen.	C2TE 8620 T	②7380
Belt - Fan & Gen.; W/O 40A. Autolite Gen.	C6ZE 8620 E	7370	Belt - Fan & Gen.; W/O 40A. Autolite Gen.	C6ZE 8620 E	7370
Belt - P.S.		◆9385HD	Belt - P.S.		◆9385HD
Hose - Upper		20450	Hose - Upper		20065
		or			25473
Hose - Lower; W/Man. Trans.		20145	Hose - Lower		≈20145
		or			26611
		26611			
Ford 6-Cyl. 262			Ford V-8 292		
B500; B600			B500; B600		
Belt - Fan & Gen.; W/P.S.	C2TE 8620 H	②7460	Belt - Fan & Alt./Gen.; W/Single Belt	C4TE 8620 AD	7450
Belt - Fan & Gen.; W/O P.S.	C4TE 8620 N	②7405	Belt - Fan & Alt./Gen.; W/Dual Belts	C4TE 8620 AD	②7450
Belt - P.S.	EAM 2890 A	◆9341HD	Belt - P.S.	C7AE 8620 D	◆9430HD
Hose - Upper		20450	Belt - Air Brake Compr.	ECY 8620 A	◆9463HD
		or	Hose - Upper		≈20088
		25474			25476
		25474	Hose - Lower; W/Auto. Trans.		≈21256
		20145	Hose - Lower; W/Man. Trans.		≈20276
		26611			26504
					28443
					28441
Ford V-8 292			B700		
B500; B600; B700			Belt - Fan & Alt./Gen.; W/Single Belt		
Belt - Fan & Alt.; W/Single Belt	C4TE 8620 AD	7450	Belt - Fan & Alt./Gen.; W/Dual Belts	C4TE 8620 AD	②7450
Belt - Fan & Alt.; W/Dual Belts	C4TE 8620 AD	②7450	Belt - P.S.		◆9405HD
Belt - P.S.		◆9415HD	Belt - Air Brake Compr.	ECY 8620 A	◆9463HD
Belt - Air Brake Compr.	C2TE 8620 U	◆9500HD	Hose - Upper		20088
Hose - Upper		≈20380			25478
		or			26504
Hose - Lower		≈20276			28443
		or			28441
		26504			
Hose - By Pass		28441			
Ford V-8 302			Ford V-8 302		
B750			B750		
Belt - Fan & Gen.; W/44 3/4" Belt O.C.	C2TE 8620 V	②◆◆9447HD	Belt - Fan	C2TE 8620 AN	TR28454
Belt - Fan & Gen.; W/46 1/4" Belt O.C.	ECY 8620 A	②◆◆9463HD	Belt - W.P. & Alt.	C4TE 8620 AD	7450
Belt - Fan & Gen.; W/47 1/4" Belt O.C.	C5TE 8620 H	②◆◆9470HD	Belt - W.P. & Gen.; W/43 1/8" Belt O.C.	C3ME 8620 A	7430
Belt - P.S.	C3TA 8620 F	◆9380HD	Belt - W.P. & Gen.; W/45 1/8" Belt O.C.	C6AE 8620 E	7448
Belt - Air Brake Compr.; W/45 1/4" Belt			Belt - P.S.	B8TZ 8620 D	◆9405HD
O.C.	C5TE 8620 A	②◆◆9451HD	Belt - Air Brake Compr.	C1TT 8620 F	◆9330HD
Belt - Air Brake Compr.; W/46 1/4" Belt			Hose - Upper		24228
O.C.	C2TE 8620 AG	②◆◆9463HD	Hose - Lower; W/Auto. Trans.		≈20685
Hose - Upper - Eng. To Pipe		≈20357	Hose - Lower - Pipe To Rad.; W/Man. Trans.		24232
Hose - Upper - Pipe To Rad.		②24228	Hose - By Pass		28443
Hose - Lower - Eng. To Pipe		≈20685			
Hose - Lower - Pipe To Rad.		24232			
Hose - By Pass		28443			
Ford V-8 332			Ford V-8 332		
B750			B750		
Belt - Fan & Gen.; W/44 3/4" Belt O.C.	C2TE 8620 V	②◆◆9447HD	Belt - Fan	C2TE 8620 AN	TR28454
Belt - Fan & Gen.; W/46 1/4" Belt O.C.	ECY 8620 A	②◆◆9463HD	Belt - W.P. & Alt.	C4TE 8620 AD	7450
Belt - Fan & Gen.; W/47 1/4" Belt O.C.	C5TE 8620 H	②◆◆9470HD	Belt - W.P. & Gen.; W/43 1/8" Belt O.C.	C3ME 8620 A	7430
Belt - P.S.	C3TA 8620 F	◆9380HD	Belt - W.P. & Gen.; W/45 1/8" Belt O.C.	C6AE 8620 E	7448
Belt - Air Brake Compr.; W/45 1/4" Belt			Belt - P.S.	B8TZ 8620 D	◆9405HD
O.C.	C5TE 8620 A	②◆◆9451HD	Belt - Air Brake Compr.	C1TT 8620 F	◆9330HD
			Hose - Upper		24228
			Hose - Lower; W/Auto. Trans.		≈20685
			Hose - Lower - Pipe To Rad.; W/Man. Trans.		24232
			Hose - By Pass		28443

◆Standard Belt Available.
②Two Required.

◆PowerBand Belt May Work, Use Template to Check.
≈Cut to Fit.

School Buses

Belts and Coolant Hose for School Buses

School Buses

Application	Mfr. Part No.	Our No.	Application	Mfr. Part No.	Our No.
Ford - Continued			Ford - Continued		
1960 - Continued			1959 - Continued		
Ford V-8 332 - Continued			Ford V-8 302 - Continued		
B750 - Continued			B750 - Continued		
Hose - Upper		24228	Hose - Lower; W/Auto. Trans.		≈20685
Hose - Lower; W/Auto. Trans.		≈20685	Hose - Lower - Pipe To Rad.; W/Man. Trans.		24232
Hose - Lower - Pipe To Rad.; W/Man. Trans.		24232	Hose - By Pass		28443
Hose - By Pass		28443			
1959			Ford V-8 332		
Ford 6-Cyl. 223			B750		
B500; B600			Belt - Fan		
Belt - Fan & Alt.	C2TE 8620 AD	②7390	Belt - W.P. & Alt.	C4TE 8620 AD	7450
Belt - Fan & Gen.; W/40A. Autolite Gen.	C2TE 8620 T	②7380	Belt - W.P. & Gen.; W/43 1/8" Belt O.C.	C3ME 8620 A	7430
Belt - Fan & Gen.; W/O 40A. Autolite Gen.	C6ZE 8620 E	7370	Belt - W.P. & Gen.; W/45 1/8" Belt O.C.	C6AE 8620 E	7448
Belt - P.S.		♣9385HD	Belt - P.S.	B8TZ 8620 D	♣9405HD
Hose - Upper		20065	Belt - Air Brake Compr.	C1TT 8620 F	♣9330HD
		or	Hose - Upper		24228
		25473	Hose - Lower; W/Auto. Trans.		≈20685
Hose - Lower		≈20145	Hose - Lower - Pipe To Rad.; W/Man. Trans.		24232
		or	Hose - By Pass		28443
		26611			
Ford V-8 292			1958		
B500			Ford 6-Cyl. 223		
Belt - Fan & Alt./Gen.; W/Single Belt	C4TE 8620 AD	7450	B500; B600		
Belt - Fan & Alt./Gen.; W/Dual Belts	C4TE 8620 AD	②7450	Belt - Fan & Alt.	C4AE 8620 B	7390
Belt - P.S.	C7AE 8620 D	♣9430HD	Belt - Fan & Gen.		7370
Belt - Air Brake Compr.	ECY 8620 A	♣9463HD	Belt - P.S.	C6AE 8620 J	♣9385HD
Hose - Upper		≈20088	Hose - Upper		20065
		or			25473
		25476	Hose - Lower		≈20145
Hose - Lower; W/Auto. Trans.		≈21256			26611
Hose - Lower; W/Man. Trans.		≈20276			
		or			
		26504	Ford V-8 272		
Hose - By Pass; W/Auto. Trans.		28443	B500; B600		
Hose - By Pass; W/Man. Trans.		28441	Belt - Fan & Alt./Gen.; W/Single Belt	C4TE 8620 AD	7450
			Belt - Fan & Alt./Gen.; W/Dual Belts	C4TE 8620 AD	②7450
B600			Belt - P.S.	C7AE 8620 D	♣9430HD
Belt - Fan & Alt./Gen.; W/Single Belt	C4TE 8620 AD	7450	Belt - Air Brake Compr.; W/Alt.	C4TE 8620 AD	7450
Belt - Fan & Alt./Gen.; W/Dual Belts	C4TE 8620 AD	②7450	Belt - Air Brake Compr.; W/Gen.	C2TE 8620 AG	♣9463HD
Belt - P.S.	C7AE 8620 D	♣9430HD	Hose - Upper		≈21794
Belt - Air Brake Compr.; Jan. 1 & Older	C5TE 8620 A	♣9451HD			25478
Belt - Air Brake Compr.; Jan. 1 & Newer	ECY 8620 A	♣9463HD	Hose - Lower		≈20276
Hose - Upper		≈20088			26504
		or	Hose - By Pass; W/Auto. Trans.		28443
		25476	Hose - By Pass; W/Man. Trans.		28441
Hose - Lower; W/Auto. Trans.		≈21256			
Hose - Lower; W/Man. Trans.		≈20276	B700		
		or	Belt - Fan & Alt./Gen.; W/Single Belt	C4TE 8620 AD	7450
		26504	Belt - Fan & Alt./Gen.; W/Dual Belts	C4TE 8620 AD	②7450
Hose - By Pass; W/Auto. Trans.		28443	Belt - P.S.	B8TZ 8620 D	♣9405HD
Hose - By Pass; W/Man. Trans.		28441	Belt - Air Brake Compr.; W/Alt.	C4TE 8620 AD	7450
			Belt - Air Brake Compr.; W/Gen.	C2TE 8620 AG	♣9463HD
B700			Hose - Upper		≈21794
Belt - Fan & Alt./Gen.; W/Single Belt	C4TE 8620 AD	7450			25478
Belt - Fan & Alt./Gen.; W/Dual Belts	C4TE 8620 AD	②7450	Hose - Lower		≈20276
Belt - P.S.	B8TZ 8620 D	♣9405HD			26504
Belt - Air Brake Compr.; W/Alt.	C4TE 8620 AD	7450	Hose - By Pass; W/Auto. Trans.		28443
Belt - Air Brake Compr.; W/Gen.	C2TE 8620 AG	♣9463HD	Hose - By Pass; W/Man. Trans.		28441
Hose - Upper		≈21794			
		or	Ford V-8 302		
		25478	B750		
Hose - Lower		≈20276	Belt - Fan	EAM 8577 A	TR28423
		26504	Belt - W.P. & Alt.	C4ZE 8620 C	7460
Hose - By Pass; W/Auto. Trans.		28443	Belt - W.P. & Gen.; W/40A. Alt.	EDC 8620 A	7440
Hose - By Pass; W/Man. Trans.		28441	Belt - W.P. & Gen.; W/30A., 50A. Alt.	C6TE 8620 D	7450
			Belt - P.S.	B8TZ 8620 D	♣9405HD
Ford V-8 302			Belt - Air Brake Compr.	EAM 2890 A	♣9341HD
B750			Hose - Upper		24228
Belt - Fan	C2TE 8620 AN	TR28454	Hose - Lower; W/Auto. Trans.; Feb. 1 & Newer		≈20685
Belt - W.P. & Alt.	C4TE 8620 AD	7450	Hose - Lower; W/Man. Trans.; Jan. 31 & Older		≈20523
Belt - W.P. & Gen.; W/43 1/8" Belt O.C.	C3ME 8620 A	7430			
Belt - W.P. & Gen.; W/45 1/8" Belt O.C.	C6AE 8620 E	7448			
Belt - P.S.	B8TZ 8620 D	♣9405HD			
Belt - Air Brake Compr.	C1TT 8620 F	♣9330HD			
Hose - Upper		24228			

≈Cut to Fit.
♣Standard Belt Available.

②Two Required.

Belts and Coolant Hose for School Buses

Application	Mfr. Part No.	Our No.	Application	Mfr. Part No.	Our No.
Ford - Continued			Ford - Continued		
1958 - Continued			1957 - Continued		
Ford V-8 302 - Continued			Ford V-8 332		
B750 - Continued			B750		
Hose - Lower - Pipe To Rad.; W/Man. Trans.; Feb. 1 & Newer		24232	Belt - Fan	EAM 8577 A	TR28423
Hose - By Pass		28443	Belt - W.P. & Alt.	C4ZE 8620 C	7460
Ford V-8 332			Belt - W.P. & Gen.; W/40A. Alt.	EDC 8620 A	7440
B750			Belt - W.P. & Gen.; W/30A., 50A. Alt.	C6TE 8620 D	7450
Belt - Fan	EAM 8577 A	TR28423	Belt - P.S.	B8TZ 8620 D	▲9405HD
Belt - W.P. & Alt.	C4ZE 8620 C	7460	Belt - Air Brake Compr.	C6TE 8620 D	7450
Belt - W.P. & Gen.; W/40A. Alt.	EDC 8620 A	7440	Hose - Upper		24228
Belt - W.P. & Gen.; W/30A., 50A. Alt.	C6TE 8620 D	7450	Hose - Lower; W/Auto. Trans.; Feb. 1 & Newer		≧20685
Belt - P.S.	B8TZ 8620 D	▲9405HD	Hose - Lower; W/Man. Trans.; Jan. 31 & Older		≧20523
Belt - Air Brake Compr.	EAM 2890 A	▲9341HD	Hose - Lower - Pipe To Rad.; W/Man. Trans.; Feb. 1 & Newer		24232
Hose - Upper		24228	Hose - By Pass		28443
Hose - Lower; W/Auto. Trans.; Feb. 1 & Newer		≧20685	1957		
Hose - Lower; W/Man. Trans.; Jan. 31 & Older		≧20523	Ford 6-Cyl. 223		
Hose - Lower - Pipe To Rad.; W/Man. Trans.; Feb. 1 & Newer		24232	B500; B600		
Hose - By Pass		28443	Belt - Fan & Alt.	C4AE 8620 B	7390
1957			Belt - Fan & Gen.		7370
Ford 6-Cyl. 223			Belt - P.S.	C6AE 8620 J	▲9385HD
B500; B600			Hose - Upper		20065
Belt - Fan & Alt.	C4AE 8620 B	7390		or	25473
Belt - Fan & Gen.		7370	Hose - Lower		≧20145
Belt - P.S.	C6AE 8620 J	▲9385HD		or	26611
Hose - Upper		20065	Ford V-8 272		
	or	25473	B500; B600		
Hose - Lower		≧20145	Belt - Fan & Alt./Gen.; W/Single Belt	C4TE 8620 AD	7450
	or	26611	Belt - Fan & Alt./Gen.; W/Dual Belts	C4TE 8620 AD	②7450
Ford V-8 272			Belt - P.S.	C7AE 8620 D	▲9430HD
B500; B600			Belt - Air Brake Compr.; W/Alt.	C4TE 8620 AD	7450
Belt - Fan & Alt./Gen.; W/Single Belt	C4TE 8620 AD	7450	Belt - Air Brake Compr.; W/Gen.	C2TE 8620 AG	▲9463HD
Belt - Fan & Alt./Gen.; W/Dual Belts	C4TE 8620 AD	②7450	Hose - Upper		②24224
Belt - P.S.	B8TZ 8620 D	▲9405HD	Hose - Lower		≧20276
Belt - Air Brake Compr.; W/Alt.	C4TE 8620 AD	7450		or	26504
Belt - Air Brake Compr.; W/Gen.	C2TE 8620 AG	▲9463HD	Hose - By Pass; W/Auto. Trans.		28443
Hose - Upper		②24224	Hose - By Pass; W/Man. Trans.		28441
Hose - Lower		≧20276	B700		
	or	26504	Belt - Fan & Alt./Gen.; W/Single Belt	C4TE 8620 AD	7450
Hose - By Pass; W/Auto. Trans.		28443	Belt - Fan & Alt./Gen.; W/Dual Belts	C4TE 8620 AD	②7450
Hose - By Pass; W/Man. Trans.		28441	Belt - P.S.	B8TZ 8620 D	▲9405HD
Ford V-8 302			Belt - Air Brake Compr.; W/Alt.	C4TE 8620 AD	7450
B750			Belt - Air Brake Compr.; W/Gen.	C2TE 8620 AG	▲9463HD
Belt - Fan	EAM 8577 A	TR28423	Hose - Upper		②24224
Belt - W.P. & Gen.; W/40A. Alt.	EDC 8620 A	7440	Hose - Lower		≧20276
Belt - W.P. & Gen.; W/30A., 50A. Alt.	C6TE 8620 D	7450		or	26504
Hose - Upper		24228	Hose - By Pass; W/Auto. Trans.		28443
Hose - Lower; W/Man. Trans.		≧20523	Hose - By Pass; W/Man. Trans.		28441
Hose - By Pass		28443	Ford V-8 332		
Ford V-8 302			B750		
B750			B750		
Belt - Fan	EAM 8577 A	TR28423	Belt - Fan	EAM 8577 A	TR28423
Belt - W.P. & Gen.; W/40A. Alt.	EDC 8620 A	7440	Belt - W.P. & Gen.; W/40A. Alt.	EDC 8620 A	7440
Belt - W.P. & Gen.; W/30A., 50A. Alt.	C6TE 8620 D	7450	Belt - W.P. & Gen.; W/30A., 50A. Alt.	C6TE 8620 D	7450
Hose - Upper		24228	Hose - Upper		24228
Hose - Lower; W/Man. Trans.		≧20523	Hose - Lower; W/Man. Trans.		≧20523
Hose - By Pass		28443	Hose - By Pass		28443
Ford V-8 332			Ford V-8 332		
B750			B750		
Belt - Fan	EAM 8577 A	TR28423	Belt - Fan	EAM 8577 A	TR28423
Belt - W.P. & Gen.; W/40A. Alt.	EDC 8620 A	7440	Belt - W.P. & Gen.; W/40A. Alt.	EDC 8620 A	7440
Belt - W.P. & Gen.; W/30A., 50A. Alt.	C6TE 8620 D	7450	Belt - W.P. & Gen.; W/30A., 50A. Alt.	C6TE 8620 D	7450
Hose - Upper		24228	Hose - Upper		24228
Hose - Lower; W/Man. Trans.		≧20523	Hose - Lower; W/Man. Trans.		≧20523
Hose - By Pass		28443	Hose - By Pass		28443
1955			1955		
Ford 6-Cyl. 223			Ford 6-Cyl. 223		
B500			B500		
Belt - Fan	C2TE 8620 T	7380	Belt - Fan	C2TE 8620 T	7380
Belt - W.P. & Gen.	EAG 8620 B	7360	Belt - W.P. & Gen.	EAG 8620 B	7360
Hose - Upper		≧21794	Hose - Upper		≧21794
	or	25476		or	25476

▲Standard Belt Available.
②Two Required.

≧Cut to Fit.

Belts and Coolant Hose for School Buses

School Buses

Application	Mfr. Part No.	Our No.	Application	Mfr. Part No.	Our No.
Ford - Continued			Freightliner - Continued		
1955 - Continued			2012		
Ford 6-Cyl. 223 - Continued			Cummins ISB6.7 Diesel		
B500 - Continued			B2		
Hose - Lower		≈20145	Belt - Accessory Belt Drive Kit		ACK080605HD
	or	26502	Belt - Serpentine	3288922	▲K080605HD
B600			Tensioner Assy.	4929688	38517
Belt - Fan	C2TE 8620 T	7380	Tensioner Pulley		38076
Belt - W.P. & Gen.	EAG 8620 B	7360	2011		
Hose - Upper		②24224	Cummins ISB6.7 Diesel		
Hose - Lower		≈20145	B2		
	or	26502	Belt - Fan & Alt.	0132241065	K080813HD
Ford V-8 239			Idler Pulley	4991240	36093
B500; B600; B700			Hose - Upper		24033
Belt - Fan	EAT 8577 A	TR28400	Hose - Lower		≈24632
Belt - W.P. & Gen.	OHA 8620 A	7430	2010		
Hose - Upper		②24224	Cummins ISB6.7 Diesel		
Hose - Lower		26501	B2		
Ford V-8 256			Belt - Fan & Alt.	0132241065	K080813HD
B500; B600; B700			Hose - Upper		24033
Belt - Fan	EAT 8577 A	TR28400	Hose - Lower		≈24232
Belt - W.P. & Gen.	OHA 8620 A	7430	Mercedes-Benz MBE 926 Diesel		
Hose - Upper		②24224	B2		
Hose - Lower		26501	Belt - W.P.	A9069935896	K080834HD
Ford V-8 272			Belt - A.C.	A9069938596	▲K080790HD
B500			Tensioner Assy. - W.P.	A9062003170	38567
Belt - Fan & Gen.	C2TE 8620 M	▲9447HD	Tensioner Assy. - Fan	A9062004170	38598
Belt - Air Brake Compr.	C2AE 8620 C	▲9370HD	Hose - Upper		21379
Hose - Upper		②24224	Hose - Lower		24039
Hose - Lower; W/L.D. Eng.		20276	2009		
	or	26504	Caterpillar C7 Diesel		
Hose - Lower; W/H.D. Eng.		26501	B2		
Hose - By Pass		28441	Belt - Accessory Belt Drive Kit - Fan		ACK080760HD1
Ford V-8 279			Belt - Fan	0123415060	▲K080760HD
B750			Tensioner Assy.	2201209	38550
Belt - Fan	EAM 8577 A	TR28423	Idler Pulley - Grooved	1979642	36341
Belt - W.P. & Gen.; Apr. & Older	C2TE 8620 AA	7450	Idler Pulley - Smooth	1979641	36091
Belt - W.P. & Gen.; May & Newer	EDC 8620 A	7440	Cummins ISB-07 Diesel		
Belt - P.S.	B8TZ 8620 D	▲9405HD	B2		
Belt - Air Brake Compr.		TR28346	Belt - Accessory Belt Drive Kit - Fan		ACK080813HD
Hose - Upper		②24228	Belt - Fan	0123415077	K080813HD
Hose - Lower		≈20523	Tensioner Assy.	5264111	38631
Ford V-8 317			Idler Pulley	4991240	36093
B750			Hose - Upper		24033
Belt - Fan	EAM 8577 A	TR28423	Hose - Lower		≈24232
Belt - W.P. & Gen.; Apr. & Older	C2TE 8620 AA	7450	Mercedes-Benz MBE 926 Diesel		
Belt - W.P. & Gen.; May & Newer	EDC 8620 A	7440	B2		
Belt - P.S.	B8TZ 8620 D	▲9405HD	Belt - W.P.	A9069935896	K080834HD
Belt - Air Brake Compr.		TR28346	Belt - A.C.	A9069938596	▲K080790HD
Hose - Upper		②24228	Tensioner Assy. - Fan	A9062004170	38598
Hose - Lower		≈20523	Tensioner Assy. - W.P.	A9062003170	38567
Freightliner			Hose - Upper		21379
2016 - 2013			Hose - Lower		24039
Cummins ISB6.7 Diesel			2008		
B2			Caterpillar C7 Diesel		
Belt - Accessory Belt Drive Kit		ACK080806HD	B2		
Belt - Serpentine	0132241051	▲K080806HD	Belt - Accessory Belt Drive Kit - Fan		ACK080760HD1
Tensioner Assy.	4929688	38517	Belt - Fan	0123415060	▲K080760HD
Tensioner Pulley		38076	Tensioner Assy.	2201209	38550
			Idler Pulley - Grooved	1979642	36341
			Idler Pulley - Smooth	1979641	36091

②Two Required.
▲Standard Belt Available.

≈Cut to Fit.

Belts and Coolant Hose for School Buses

Application	Mfr. Part No.	Our No.	Application	Mfr. Part No.	Our No.
Freightliner - Continued			Freightliner - Continued		
2008 - Continued			2007 - Continued		
Cummins ISB-07 Diesel			Mercedes-Benz MBE 924 Diesel		
B2			B2		
Belt - Accessory Belt Drive Kit - Fan, Alt. & A.C.		ACK080813HD	Belt - W.P.	A9069935896	K080834HD
Belt - Fan, Alt. & A.C.	0123415077	K080813HD	Belt - A.C.	A9069938596	♣K080790HD
Tensioner Assy. - Fan, Alt. & A.C.	4937433	38631	Tensioner Assy. - W.P.	A9062003170	38567
Idler Pulley - Fan, Alt. & A.C.	4991240	36093	Tensioner Assy. - Fan	A9062004170	38598
Hose - Upper - Eng. To Rad.		≧22743	Hose - Upper		21379
Hose - Lower - Eng. To Pipe		≧24232	Hose - Lower		24039
Hose - Lower - Rad. To Pipe		≧24232	Mercedes-Benz MBE 926 Diesel		
Mercedes-Benz MBE 900 Diesel			B2		
FS65			Belt - W.P.		
Belt - Accessory Belt Drive Kit - Fan & Alt.		ACK080680HD1	Belt - A.C.	A9069935896	K080834HD
Belt - Fan & Alt.	0129859724	♣K080680HD	Tensioner Assy. - W.P.	A9062003170	♣K080790HD
Tensioner Assy. - Fan & Alt.	A9062003170	38567	Tensioner Assy. - Fan	A9062004170	38598
Hose - Lower - Eng. To Pipe		21124	Hose - Upper		21379
Hose - Lower - Pipe To Cooler		20206	Hose - Lower		24039
Hose - Lower - Cooler To Rad.		≧21378	2006		
Mercedes-Benz MBE 924 Diesel			Caterpillar C7 Diesel		
B2			B2		
Belt - W.P.	A9069935896	K080834HD	Belt - Accessory Belt Drive Kit - Fan		ACK080760HD1
Belt - A.C.	A9069938596	♣K080790HD	Belt - Fan	0123415060	♣K080760HD
Tensioner Assy. - W.P.	A9062003170	38567	Tensioner Assy.	2201209	38550
Tensioner Assy. - Fan	A9062004170	38598	Idler Pulley - Grooved	1979642	36341
Hose - Upper		21379	Idler Pulley - Smooth	1979641	36091
Hose - Lower		24039	FS65		
Mercedes-Benz MBE 926 Diesel			Belt - Accessory Belt Drive Kit - Fan & Alt.		
B2			Belt - Fan & Alt.		
Belt - W.P.	A9069935896	K080834HD	Belt - W.P.	0366775	♣9341HD
Belt - A.C.	A9069938596	♣K080790HD	Tensioner Assy. - Fan & Alt.	1352151	38511
Tensioner Assy. - W.P.	A9062003170	38567	Tensioner Pulley - Fan & Alt.		36091
Tensioner Assy. - Fan	A9062004170	38598	Hose - Lower - Eng. To Rad.; W/O Cooler		24029
Hose - Upper		21379	Mercedes-Benz MBE 900 Diesel		
Hose - Lower		24039	FS65		
2007			Belt - Accessory Belt Drive Kit - Fan & Alt.		
Caterpillar C7 Diesel			Belt - Fan & Alt.		
B2			Tensioner Assy. - Alt.		
Belt - Accessory Belt Drive Kit - Fan		ACK080760HD1	Hose - Lower - Eng. To Pipe		22702
Belt - Fan	0123415060	♣K080760HD	2005		
Tensioner Assy.	2201209	38550	Caterpillar C7 Diesel		
Idler Pulley - Grooved	1979642	36341	FS65		
Idler Pulley - Smooth	1979641	36091	Belt - Accessory Belt Drive Kit - Fan & Alt.		
FS65			Belt - Fan & Alt.		
Belt - Accessory Belt Drive Kit		ACK080708HD	Belt - W.P.	0366775	♣9341HD
Belt - Fan & Alt.	0127110003	♣K080708HD	Tensioner Assy. - Fan & Alt.	1352151	38511
Belt - W.P.	0366775	♣9341HD	Tensioner Pulley - Fan & Alt.		36091
Tensioner Assy. - Fan & Alt.	1352151	38511	Hose - Lower - Eng. To Rad.; W/O Cooler		24029
Tensioner Pulley - Fan & Alt.		36091	Mercedes-Benz MBE 900 Diesel		
Hose - Lower - Eng. To Rad.; W/O Cooler		24029	FS65		
Mercedes-Benz MBE 900 Diesel			Belt - Fan & Alt.; W/O A.C.		
FS65			Belt - Fan & Alt.; W/A.C.		
Belt - Accessory Belt Drive Kit - Fan & Alt.		ACK080675HD	Belt - A.C.; W/Carrier, TransAir A.C. Compr.		K081044HD
Belt - Fan & Alt.	0129859718	♣K080675HD	Hose - Upper - Eng. To Rad.		22992
Tensioner Assy. - Alt.	9062003170	38567	Hose - Lower - Pipe To W.P.		22991
Mercedes-Benz MBE 904 Diesel			Hose - Lower - Pipe To Rad.		
B2			22702		
Belt - W.P.	A9069935896	K080834HD	2004		
Belt - A.C.	A9069938596	♣K080790HD	Caterpillar 3126 Diesel		
Tensioner Assy. - W.P.	A9062003170	38567	FS65		
Tensioner Assy. - Fan	A9062004170	38598	Belt - Accessory Belt Drive Kit		
Hose - Upper		21379	Belt - Fan, Alt. & A.C.		
Hose - Lower		24039	Belt - W.P.		
2007			Tensioner Assy. - Fan, Alt. & A.C.		
Caterpillar C7 Diesel			1352151		
B2			38511		
Belt - Accessory Belt Drive Kit			36091		
Belt - Fan			24029		
Tensioner Assy.					
Idler Pulley - Grooved					
Idler Pulley - Smooth					
FS65					
Belt - Accessory Belt Drive Kit					
Belt - Fan & Alt.					
Belt - W.P.					
Tensioner Assy. - Fan & Alt.					
Tensioner Pulley - Fan & Alt.					
Hose - Lower - Eng. To Rad.; W/O Cooler					
Mercedes-Benz MBE 900 Diesel					
FS65					
Belt - Fan & Alt.; W/O A.C.					
Belt - Fan & Alt.; W/A.C.					
Belt - A.C.; W/Carrier, TransAir A.C. Compr.					
Hose - Upper - Eng. To Rad.					
Hose - Lower - Pipe To W.P.					
Hose - Lower - Pipe To Rad.					
2004					
Caterpillar 3126 Diesel					
FS65					
Belt - Accessory Belt Drive Kit					
Belt - Fan, Alt. & A.C.					
Belt - W.P.					
Tensioner Assy. - Fan, Alt. & A.C.					

School Buses

≧Cut to Fit.

♣Standard Belt Available.

Belts and Coolant Hose for School Buses

School Buses

Application	Mfr. Part No.	Our No.	Application	Mfr. Part No.	Our No.
Freightliner - Continued			Freightliner - Continued		
2004 - Continued			2001 - Continued		
Caterpillar 3126 Diesel - Continued			Cummins ISB Diesel - Continued		
FS65 - Continued			FS65 - Continued		
Tensioner Pulley - Fan, Alt. & A.C.	1352151	36091	Tensioner Assy.	3936213	38516
Hose - Upper - Eng. To Rad.		20735	Tensioner Pulley	3936213	36093
Hose - Lower - Pipe To Rad.		21473			
Caterpillar C7 Diesel			2000		
FS65			Caterpillar 3126 Diesel		
Belt - Accessory Belt Drive Kit - Fan & Alt.		ACK080702HD1	FS65		
Belt - Accessory Belt Drive Kit - Fan, Alt. & A.C.		ACK080872HD	Belt - Accessory Belt Drive Kit		
Belt - Fan, Alt. & A.C.	0127110030	♣K080872HD	Belt - Fan, Alt. & A.C.		
Belt - Fan & Alt.	0127110002	♣K080702HD	Belt - W.P.		
Belt - W.P.	0366775	♣9341HD	Tensioner Assy. - Fan, Alt. & A.C.		
Tensioner Assy. - Fan & Alt.	1352151	38511	Tensioner Pulley - Fan, Alt. & A.C.		
Tensioner Pulley - Fan & Alt.		36091	Hose - Upper - Eng. To Rad.		
Idler Pulley - Fan & Alt.	2534525	36096	Hose - Lower - Pipe To Rad.		
Hose - Lower - Eng. To Rad.; W/O Cooler		24029	Cummins ISB Diesel		
Mercedes-Benz MBE 900 Diesel			FS65		
FS65			Belt - Accessory Belt Drive Kit		
Belt - Serpentine	0127110043	♣K080680HD	Belt - Serpentine		
Belt - A.C.; W/Carrier, TransAir A.C. Compr.		K081044HD	Tensioner Assy.		
Hose - Upper - Eng. To Rad.		22701	Tensioner Pulley		
Hose - Lower - Eng. To Pipe		20611			
Hose - Lower - Pipe To Rad.		22702			
2003 - 2002			1999 - 1998		
Caterpillar 3126 Diesel			Caterpillar 3126 Diesel		
FS65			FS65		
Belt - Accessory Belt Drive Kit		ACK080708HD	Belt - Accessory Belt Drive Kit		
Belt - Fan, Alt. & A.C.	0127110003	♣K080708HD	Belt - W.P.		
Belt - W.P.	0366775	♣9341HD	Belt - Fan, Alt. & A.C.		
Tensioner Assy. - Fan, Alt. & A.C.	1352151	38511	Tensioner Pulley - Fan, Alt. & A.C.		
Tensioner Pulley - Fan, Alt. & A.C.	1352151	36091	Hose - Upper - Eng. To Rad.		
Hose - Upper - Eng. To Rad.		20735	Hose - Lower - Pipe To Rad.		
Hose - Lower - Pipe To Rad.		21473			
Cummins ISB Diesel			Cummins ISB Diesel		
FS65			FS65		
Belt - Accessory Belt Drive Kit		ACK080694HD	Belt - Accessory Belt Drive Kit		
Belt - Serpentine	3926856	♣K080694HD	Belt - Serpentine		
Tensioner Assy.	3936213	38516	Tensioner Assy.		
Tensioner Pulley	3936213	36093	Tensioner Pulley		
Hose - Upper - Eng. To Rad.		22700			
Hose - Lower		21473			
Mercedes-Benz MBE 900 Diesel			1997		
FS65			Cummins B Series 5.9 L Diesel		
Belt - Serpentine	0127110043	♣K080680HD	FS65		
Belt - A.C.; W/Carrier, TransAir A.C. Compr.		K081044HD	Belt - Accessory Belt Drive Kit		
Hose - Upper - Eng. To Rad.		22701	Belt - Fan, Alt. & A.C.		
Hose - Lower - Pipe To Rad.		22702	Tensioner Assy. - Fan, Alt. & A.C.		
2001			Hose - Upper - Eng. To Rad.		
Caterpillar 3126 Diesel			Hose - Lower - Rad. To Pipe		
FS65					
Belt - Accessory Belt Drive Kit		ACK080708HD	GMC		
Belt - Fan, Alt. & A.C.	0127110003	♣K080708HD	2002		
Belt - W.P.	0366775	♣9341HD	Caterpillar 3116 Diesel		
Tensioner Assy. - Fan, Alt. & A.C.	1352151	38511	B7 Series		
Tensioner Pulley - Fan, Alt. & A.C.	1352151	36091	Belt - Fan & Alt.; W/70" Belt O.C.		
Hose - Upper - Eng. To Rad.		20735			
Hose - Lower - Pipe To Rad.		21473	Caterpillar 3126 Diesel		
Cummins ISB Diesel			B7 Series		
FS65			Belt - Fan & Alt.		
Belt - Accessory Belt Drive Kit		ACK080694HD	Belt - W.P.		
Belt - Serpentine	3926856	♣K080694HD	GM V-8 8.1 L		
			B7 Series		
			Belt - Fan, W.P., Gen. & P.S.		
			Belt - Air Compr.		
			Hose - Upper - Eng. To Rad.		

♣Standard Belt Available.

Belts and Coolant Hose for School Buses

Application	Mfr. Part No.	Our No.	Application	Mfr. Part No.	Our No.
GMC - Continued			GMC - Continued		
2002 - Continued			1998 - Continued		
GM V-8 8.1 L - Continued			Caterpillar 3126 Diesel - Continued		
B7 Series - Continued			B6000 B6P Series		
Hose - Lower - Eng. To Rad.		22679	Belt - Fan & Alt.	15670937	▲K070705HD
2001			Hose - Upper		22134
Caterpillar 3116 Diesel			Hose - Lower		21985
B7 Series			GM V-8 6.0 L		
Belt - Fan & Alt.; W/70" Belt O.C.	15670937	▲K070705HD	B7 Series		
Caterpillar 3126 Diesel			Belt - Fan & Alt.	15608928	▲K060672HD
B7 Series			Belt - Fan & P.S.; W/Air Brakes	9433884	▲9395HD
Belt - Fan & Alt.	15670937	▲K070705HD	Belt - Fan & P.S.; W/Hyd. Brakes	11502406	▲9650HD
Belt - W.P.	0366775	▲9341HD	Belt - Fan, A.C. & P.S.	14033869	7603
GM V-8 5.7 L			Belt - Air Brake Compr.	11502412	▲9680HD
B7 Series			Hose - Upper - Eng. To Rad.		22136
Belt - Serpentine; W/O A.C.; W/130A. Alt. ...	12564760	▲K060875HD	Hose - Lower		22135
Belt - Accessory Belt Drive Kit; W/O A.C.; W/130A. Alt. ...		ACK060875HD	GM V-8 6.5 L Diesel		
Tensioner Assy.		38103	B7 Series		
Tensioner Pulley		38008	Belt - Accessory Belt Drive Kit - Alt., W.P. & P.S.		
Hose - Upper		22357	Belt - Fan	15994965	▲K060547HD
Hose - Lower		22425	Belt - Alt., W.P. & P.S.	12555011	▲K061015HD
GM V-8 8.1 L			Tensioner Assy. - Alt., W.P. & P.S.	12561092	38118
B7 Series			GM V-8 7.0 L		
Belt - Fan, W.P., Gen. & P.S.	15021740	▲K071056HD	B7 Series		
Belt - Air Compr.	15060753	▲K040762HD	Belt - Fan & Alt.		
Tensioner Pulley	15021742		Belt - Fan & P.S.; W/Air Brakes	15608928	▲K060672HD
Hose - Upper - Eng. To Rad.		22678	Belt - Fan & P.S.; W/Hyd. Brakes	11502406	▲9650HD
Hose - Lower - Eng. To Rad.		22679	Belt - Air Brake Compr.	11502412	▲9680HD
2000 - 1999			Hose - Upper - Eng. To Rad.		22136
Caterpillar 3116 Diesel			Hose - Lower		22135
B7 Series			GM V-8 7.4 L		
Belt - Fan & Alt.; W/70" Belt O.C.			B7 Series		
15670937		▲K070705HD	Belt - Air Compr.		
Caterpillar 3126 Diesel			11502412		▲9680HD
B7 Series			1997		
Belt - Fan & Alt.			Caterpillar 3116 Diesel		
15670937		▲K070705HD	B7 Series		
Belt - W.P.			Belt - Fan & Alt.; W/70" Belt O.C.		
0366775		▲9341HD	15670937		▲K070705HD
GM V-8 7.4 L			Hose - Upper - Eng. To Rad.		22134
B7 Series			Hose - Lower - Eng. To Rad.		21985
Belt - Fan & Gen.	15722647	▲K060660HD	GM V-8 6.0 L		
Belt - Air Compr.	11502412	▲9680HD	B7 Series		
Belt - P.S. & Air Brake Compr.	9433884	▲9395HD	Belt - Fan & Alt.		
Belt - P.S. & Hyd. Brake	11502405	▲9640HD	Belt - Fan & P.S.; W/Air Brakes	9433884	▲9395HD
Hose - Upper - Eng. To Rad.		22663	Belt - Fan & P.S.; W/Hyd. Brakes	11502406	▲9650HD
Hose - Lower - Eng. To Rad.		22135	Belt - Fan, A.C. & P.S.	14033869	7603
1998			Belt - Air Brake Compr.	11502412	▲9680HD
Caterpillar 3116 Diesel			Hose - Upper - Eng. To Rad.		22136
B7 Series			Hose - Lower		22135
Belt - Fan & Alt.; W/70" Belt O.C.			B6000 B6P Series		
15670937		▲K070705HD	Belt - Fan & Alt.; W/124A., 145A. Alt.		
Hose - Upper - Eng. To Rad.			Belt - Fan & P.S.; W/Air Brakes	9433884	▲9395HD
		22134	Belt - Fan & P.S.; W/Hyd. Brakes	11502406	▲9650HD
Hose - Lower - Eng. To Rad.			Belt - Fan & A.C.	10230259	▲K060670HD
		21985	Belt - Air Brake Compr.	11502413	▲9690HD
B6000 B6P Series			Hose - Upper		22136
Belt - Fan & Alt.			Hose - Lower		22135
15670937		▲K070705HD	GM V-8 6.5 L Diesel		
Hose - Upper			B7 Series		
		22134	Belt - Fan		
Hose - Lower			Belt - Alt., W.P. & P.S.	12555011	▲K061015HD
		21985	GM V-8 7.0 L		
Caterpillar 3126 Diesel			B7 Series		
B7 Series			Belt - Fan & Alt.		
Belt - Fan & Alt.			15608928		▲K060672HD
15670937		▲K070705HD			
Belt - W.P.					
0366775		▲9341HD			
Hose - Upper - Eng. To Rad.					
		22664			
Hose - Lower - Eng. To Rad.					
		21985			

▲Standard Belt Available.

School Buses

Belts and Coolant Hose for School Buses

School Buses

Application	Mfr. Part No.	Our No.	Application	Mfr. Part No.	Our No.
GMC - Continued			GMC - Continued		
1997 - Continued			1995 - 1993		
GM V-8 7.0 L - Continued			Caterpillar 3116 Diesel		
B7 Series - Continued			B7 Series		
Belt - Fan & P.S.; W/Air Brakes	9433884	♣9395HD	Belt - Fan & Alt.; W/70" Belt O.C.	15670937	♣K070705HD
Belt - Fan & P.S.; W/Hyd. Brakes	11502406	♣9650HD	Hose - Upper - Eng. To Rad.		22134
Belt - Air Brake Compr.	11502412	♣9680HD	Hose - Lower - Eng. To Rad.		21985
Hose - Upper - Eng. To Rad.		22136	B6000 B6P Series		
Hose - Lower		22135	Belt - Fan & Alt.	15670937	♣K070705HD
1996			Hose - Upper		22134
Caterpillar 3116 Diesel			Hose - Lower		21985
B7 Series			GM V-8 6.0 L		
Belt - Fan & Alt.; W/70" Belt O.C.	15670937	♣K070705HD	B7 Series		
Belt - A.C.		♣9345HD	Belt - Fan & Alt.	15608928	♣K060672HD
Tensioner Assy.	1253725	38507	Belt - Fan & P.S.; W/Air Brakes	9433884	♣9395HD
Hose - Upper - Eng. To Rad.		22134	Belt - Fan & P.S.; W/Hyd. Brakes	11502406	♣9650HD
Hose - Lower - Eng. To Rad.		21985	Belt - Fan, A.C. & P.S.	14033869	7603
B6000 B6P Series			Belt - Air Brake Compr.	11502412	♣9680HD
Belt - Fan & Alt.	15670937	♣K070705HD	Hose - Upper - Eng. To Rad.		22136
Belt - A.C.		♣9345HD	Hose - Lower		22135
Hose - Upper		22134	B6000 B6P Series		
Hose - Lower		21985	Belt - Fan & Alt.; W/124A., 145A. Alt.	15608928	♣K060672HD
GM V-8 6.0 L			Belt - Fan & P.S.; W/Air Brakes	9433884	♣9395HD
B7 Series			Belt - Fan & P.S.; W/Hyd. Brakes	11502406	♣9650HD
Belt - Fan & Alt.	15608928	♣K060672HD	Belt - Fan & A.C.	10230259	♣K060670HD
Belt - Fan & P.S.; W/Air Brakes	9433884	♣9395HD	Belt - Air Brake Compr.	11502413	♣9690HD
Belt - Fan & P.S.; W/Hyd. Brakes	11502406	♣9650HD	Hose - Upper		22136
Belt - Fan, A.C. & P.S.	14033869	7603	Hose - Lower		22135
Belt - Air Brake Compr.	11502412	♣9680HD	GM V-8 7.0 L		
Hose - Upper - Eng. To Rad.		22136	B7 Series		
Hose - Lower		22135	Belt - Fan & Alt.	15608928	♣K060672HD
B6000 B6P Series			Belt - Fan & P.S.; W/Air Brakes	9433884	♣9395HD
Belt - Fan & Alt.; W/124A., 145A. Alt.	15608928	♣K060672HD	Belt - Fan & P.S.; W/Hyd. Brakes	11502406	♣9650HD
Belt - Fan & P.S.; W/Air Brakes	9433884	♣9395HD	Belt - Air Brake Compr.	11502412	♣9680HD
Belt - Fan & P.S.; W/Hyd. Brakes	11502406	♣9650HD	Hose - Upper - Eng. To Rad.		22136
Belt - Fan & A.C.	10230259	♣K060670HD	Hose - Lower		22135
Belt - Air Brake Compr.	11502413	♣9690HD	B6000 B6P Series		
Hose - Upper		22136	Belt - Fan & Alt.; W/124A., 145A. Alt.	15608928	♣K060672HD
Hose - Lower		22135	Belt - Fan & P.S.; W/Air Brakes	9433884	♣9395HD
GM V-8 7.0 L			Belt - Fan & P.S.; W/Hyd. Brakes	11502406	♣9650HD
B7 Series			Belt - Fan & A.C.	10230259	♣K060670HD
Belt - Fan & Alt.	15608928	♣K060672HD	Belt - Air Brake Compr.	11502413	♣9690HD
Belt - Fan & P.S.; W/Air Brakes	9433884	♣9395HD	Hose - Upper		22136
Belt - Fan & P.S.; W/Hyd. Brakes	11502406	♣9650HD	Hose - Lower		22135
Belt - Air Brake Compr.	11502412	♣9680HD	GM V-8 7.4 L		
Hose - Upper - Eng. To Rad.		22136	B6000 B6P Series		
Hose - Lower		22135	Belt - Fan & Alt.; W/124A., 145A. Alt.	15608928	♣K060672HD
B6000 B6P Series			Belt - Fan & P.S.; W/Air Brakes	9433884	♣9395HD
Belt - Fan & Alt.; W/124A., 145A. Alt.	15608928	♣K060672HD	Belt - Fan & P.S.; W/Hyd. Brakes	11502406	♣9650HD
Belt - Fan & P.S.; W/Air Brakes	9433884	♣9395HD	Belt - Fan & A.C.	10230259	♣K060670HD
Belt - Fan & P.S.; W/Hyd. Brakes	11502406	♣9650HD	Belt - Air Brake Compr.	11502413	♣9690HD
Belt - Fan & A.C.	10230259	♣K060670HD	Hose - Upper		22136
Belt - Air Brake Compr.	11502413	♣9690HD	Hose - Lower		22135
Hose - Upper		22136	1992		
Hose - Lower		22135	Caterpillar 3116 Diesel		
GM V-8 7.4 L			B6000 B6P Series		
B6000 B6P Series			Belt - Fan & Alt.	15670937	♣K070705HD
Belt - Fan & Alt.; W/124A., 145A. Alt.	15608928	♣K060672HD	Hose - Upper		22134
Belt - Fan & P.S.; W/Air Brakes	9433884	♣9395HD	Hose - Lower		21985
Belt - Fan & P.S.; W/Hyd. Brakes	11502406	♣9650HD	Detroit Diesel V-8 8.2 L Diesel		
Belt - Fan & A.C.	10230259	♣K060670HD	S7000 S7T Series		
Belt - Air Brake Compr.	11502413	♣9690HD	Belt - Fan & Alt.; W/71 1/2" Belt O.C.	2099791	♣9710HD
Hose - Upper		22136	Belt - Fan & Alt.; W/97 1/2" Belt O.C.	2056956	Ⓜ♣9700HD
Hose - Lower		22135	Belt - Fan & Air Brake Compr.		♣9720HD
GM V-8 7.4 L			Belt - P.S.	11502340	♣9385HD
B6000 B6P Series					
Belt - Fan & Alt.; W/124A., 145A. Alt.	15608928	♣K060672HD			
Belt - Fan & P.S.; W/Air Brakes	9433884	♣9395HD			
Belt - Fan & P.S.; W/Hyd. Brakes	11502406	♣9650HD			
Belt - Fan & A.C.	10230259	♣K060670HD			
Belt - Air Brake Compr.	11502413	♣9690HD			
Hose - Upper		22136			
Hose - Lower		22135			

♣Standard Belt Available.

ⓂTwo Required.

Belts and Coolant Hose for School Buses

Application	Mfr. Part No.	Our No.	Application	Mfr. Part No.	Our No.
GMC - Continued			GMC - Continued		
1992 - Continued			1991 - Continued		
Detroit Diesel V-8 8.2 L Diesel - Continued			Detroit Diesel V-8 8.2 L Diesel - Continued		
S7000 S7T Series - Continued			S7000 S7T Series - Continued		
Belt - Air Brake Compr.; W/71 1/2" Belt O.C.	11502416	▲9710HD	Belt - Air Brake Compr.; W/71 1/2" Belt O.C.	11502416	▲9710HD
Belt - Air Brake Compr.; W/75" Belt O.C.	11502340	▲9745HD	Belt - Air Brake Compr.; W/75" Belt O.C.	11502340	▲9745HD
Hose - Upper - Eng. To Pipe		24232	Hose - Upper - Eng. To Pipe		24232
Hose - Upper - Pipe To Rad.		21473	Hose - Upper - Pipe To Rad.		21473
Hose - Lower - Eng. To Pipe		24236	Hose - Lower - Eng. To Pipe		24236
Hose - Lower - Pipe To Rad.		24238	Hose - Lower - Pipe To Rad.		24238
Hose - By Pass - Left Side		24222	Hose - By Pass - Left Side		24222
Hose - By Pass - Right Side		21457	Hose - By Pass - Right Side		21457
GM V-8 6.0 L			GM V-8 6.0 L		
B6000 B6P Series			B6000 B6P Series		
Belt - Fan & Alt.; W/124A., 145A. Alt.	15608928	▲K060672HD	Belt - Fan & Alt.; W/63A., 108A. Alt.; Preferred Belt		2/9640PB
Belt - Fan & P.S.; W/Air Brakes	9433884	▲9395HD	Belt - Fan & Alt.; W/63A., 108A. Alt.; Optional Belt	②▲9640HD	
Belt - Fan & P.S.; W/Hyd. Brakes	11502406	▲9650HD	Belt - Fan & Alt.; W/80A., 100A. Alt.; Preferred Belt		2/9660PB
Belt - Fan & A.C.	10230259	▲K060670HD	Belt - Fan & Alt.; W/80A., 100A. Alt.; Optional Belt	②▲9660HD	
Belt - Air Brake Compr.	11502413	▲9690HD	Belt - Fan & Alt.; W/105A., 130A., 160A. Alt.; Preferred Belt		2/9670PB
Hose - Upper		22136	Belt - Fan & Alt.; W/105A., 130A., 160A. Alt.; Optional Belt	②▲9670HD	
Hose - Lower		22135	Belt - Fan & P.S.		▲9630HD
S7000 S7T Series			S7000 S7T Series		
Belt - Fan & Alt.	11502410	▲9670HD	Belt - Fan & Hyd. Pump		▲9630HD
Hose - Upper - Eng. To Pipe		≧21307	Belt - Fan & Air Brake Compr.	2027569	5700
Hose - Upper - Pipe To Rad.; W/Auto. Trans.		21523	Belt - Fan To A.P.	9433881	▲9380HD
Hose - Upper - Pipe To Rad.; W/Man. Trans.		21521	Belt - Alt. & A.P.; W/108A. Alt.		▲9630HD
Hose - Lower - Pipe To Rad.		21556	Belt - Alt. & A.P.; W/80A., 100A. Alt.		▲9640HD
Hose - By Pass		24222	Belt - Alt. & A.P.; W/105A., 130A., 160A. Alt.		▲9650HD
GM V-8 7.0 L			GM V-8 7.0 L		
B6000 B6P Series			B6000 B6P Series		
Belt - Fan & Alt.; W/124A., 145A. Alt.	15608928	▲K060672HD	Belt - P.S.; W/40" Belt O.C.	9433884	▲9395HD
Belt - Fan & P.S.; W/Air Brakes	9433884	▲9395HD	Belt - P.S.; W/Air Brakes; W/59 1/2" Belt O.C.		▲9590HD
Belt - Fan & P.S.; W/Hyd. Brakes	11502406	▲9650HD	Belt - P.S.; W/Hyd. Brakes; W/64 3/4" Belt O.C.		▲9640HD
Belt - Fan & A.C.	10230259	▲K060670HD	Belt - A.P. - From C.S.; W/39" Belt O.C.		▲9385HD
Belt - Air Brake Compr.	11502413	▲9690HD	Belt - A.P. - From C.S.; W/54 1/2" Belt O.C.	9433913	▲9540HD
Hose - Upper		22136	Belt - Air Brake Compr.		▲9720HD
Hose - Lower		22135	Hose - Upper		22136
GM V-8 7.4 L			GM V-8 7.4 L		
B6000 B6P Series			B6000 B6P Series		
Belt - Fan & Alt.; W/124A., 145A. Alt.	15608928	▲K060672HD	Hose - Lower		22135
Belt - Fan & P.S.; W/Air Brakes	9433884	▲9395HD	S7000 S7T Series		
Belt - Fan & P.S.; W/Hyd. Brakes	11502406	▲9650HD	Belt - Fan & Alt.	11502410	▲9670HD
Belt - Fan & A.C.	10230259	▲K060670HD	Hose - Upper - Eng. To Pipe		≧21307
Belt - Air Brake Compr.	11502413	▲9690HD	Hose - Upper - Pipe To Rad.; W/Auto. Trans.		21523
Hose - Upper		22136	Hose - Upper - Pipe To Rad.; W/Man. Trans.		21521
Hose - Lower		22135	Hose - Lower - Pipe To Rad.		21556
1991			GM V-8 7.0 L		
Detroit Diesel V-8 8.2 L Diesel			B6000 B6P Series		
B6000 B6P Series			Belt - Fan & Alt.; W/63A., 108A. Alt.; Preferred Belt		
Belt - Fan & Alt.; W/71 1/2" Belt O.C.	2099791	▲9710HD	Belt - Fan & Alt.; W/63A., 108A. Alt.; Optional Belt	②▲9640HD	
Belt - Fan & Alt.; W/97 1/2" Belt O.C.	2056956	②▲9700HD	Belt - Fan & Alt.; W/80A., 100A. Alt.; Preferred Belt		2/9660PB
Belt - Fan & Air Brake Compr.		▲9720HD	Belt - Fan & Alt.; W/80A., 100A. Alt.; Optional Belt	②▲9660HD	
Belt - P.S.	11502340	▲9385HD	Belt - Fan & Alt.; W/105A., 130A., 160A. Alt.; Preferred Belt		2/9670PB
Belt - Air Brake Compr.	11502419	▲9740HD	Belt - Fan & Alt.; W/105A., 130A., 160A. Alt.; Optional Belt	②▲9670HD	
Hose - Upper - Eng. To Pipe		24232	Belt - Fan & P.S.		▲9630HD
Hose - Upper - Pipe To Rad.		21473	Belt - Fan & Hyd. Pump		▲9630HD
Hose - Lower - Eng. To Pipe		24236	Belt - Fan & Air Brake Compr.	2027569	5700
Hose - Lower - Pipe To Rad.		24238	Belt - Fan To A.P.	9433881	▲9380HD
Hose - By Pass - Left Side		24222	Belt - Alt. & A.P.; W/108A. Alt.		▲9630HD
Hose - By Pass - Right Side		21457	Belt - Alt. & A.P.; W/80A., 100A. Alt.		▲9640HD
S7000 S7T Series			Belt - Alt. & A.P.; W/105A., 130A., 160A. Alt.		
Belt - Fan & Alt.; W/71 1/2" Belt O.C.	2099791	▲9710HD	Belt - P.S.; W/40" Belt O.C.	9433884	▲9395HD
Belt - Fan & Alt.; W/97 1/2" Belt O.C.	2056956	②▲9700HD	Belt - P.S.; W/Air Brakes; W/59 1/2" Belt O.C.		▲9590HD
Belt - Fan & Air Brake Compr.		▲9720HD	Belt - P.S.; W/Hyd. Brakes; W/64 3/4" Belt O.C.		▲9640HD
Belt - P.S.	11502340	▲9385HD	Belt - A.P. - From C.S.; W/39" Belt O.C.		▲9385HD
1991			Belt - A.P. - From C.S.; W/54 1/2" Belt O.C.		
Detroit Diesel V-8 8.2 L Diesel			O.C.		
B6000 B6P Series			9433913		
Belt - Fan & Alt.; W/71 1/2" Belt O.C.	2099791	▲9710HD			▲9540HD
Belt - Fan & Alt.; W/97 1/2" Belt O.C.	2056956	②▲9700HD			
Belt - Fan & Air Brake Compr.		▲9720HD			
Belt - P.S.	11502340	▲9385HD			

▲Standard Belt Available.
②Two Required.

≧Cut to Fit.

Belts and Coolant Hose for School Buses

Application	Mfr. Part No.	Our No.	Application	Mfr. Part No.	Our No.
GMC - Continued			GMC - Continued		
1991 - Continued			1990 - Continued		
GM V-8 7.0 L - Continued			Detroit Diesel V-8 8.2 L Diesel - Continued		
B6000 B6P Series - Continued			S7000 S7T Series - Continued		
Belt - Air Brake Compr.		♣9720HD	Belt - Air Brake Compr.; W/75" Belt O.C.	11502340	♣9745HD
Hose - Upper		22136	Hose - Upper - Eng. To Pipe		24232
Hose - Lower		22135	Hose - Upper - Pipe To Rad.		21473
S7000 S7T Series			Hose - Lower - Eng. To Pipe		24236
Belt - Fan & Alt.	11502410	♣9670HD	Hose - Lower - Pipe To Rad.		24238
Hose - Upper - Eng. To Pipe		♣21307	Hose - By Pass - Left Side		24222
Hose - Upper - Pipe To Rad.; W/Auto. Trans.		21523	Hose - By Pass - Right Side		21457
Hose - Upper - Pipe To Rad.; W/Man. Trans.		21521	GM V-8 5.0 L		
Hose - Lower - Pipe To Rad.		21556	B6000 B6P Series		
Hose - By Pass		24222	Belt - Fan & Alt.; W/70A., 108A. Alt.	11502375	♣9525HD
GM V-8 7.4 L			Belt - Fan & Alt.; W/80A., 100A. Alt.	2005476	②♣♣9550HD
B6000 B6P Series			Belt - Fan & Alt.; W/105A., 130A., 160A.		
Belt - Fan & Alt.; W/63A., 108A. Alt.; Preferred Belt		2/9640PB	Alt.; Preferred Belt	11502386	2/9570PB
Belt - Fan & Alt.; W/63A., 108A. Alt.; Optional Belt		②♣9640HD	Belt - Fan & Alt.; W/105A., 130A., 160A.		
Belt - Fan & Alt.; W/80A., 100A. Alt.; Preferred Belt		2/9660PB	Alt.; Optional Belt	11502386	②♣9570HD
Belt - Fan & Alt.; W/80A., 100A. Alt.; Optional Belt		②♣9660HD	Belt - Fan, Alt. & A.P.; W/80A. Alt.	11502410	♣9670HD
Belt - Fan & Alt.; W/105A., 130A., 160A. Alt.; Preferred Belt			Belt - Fan, Alt. & A.P.; W/105A., 130A., 160A. Alt.	11502411	♣9680HD
Belt		2/9670PB	Belt - Fan & P.S.; W/Hyd. Brakes	9433923	♣9590HD
Belt - Fan & Alt.; W/105A., 130A., 160A. Alt.; Optional Belt			Belt - P.S. & A.P.		♣9640HD
Belt		②♣9670HD	Belt - P.S.; W/Air Brakes	9433881	♣9380HD
Belt - Fan & P.S.		♣9630HD	Belt - Air Brake Compr. & A.P.		♣9670HD
Belt - Fan & Hyd. Pump		♣9630HD	Belt - A.P.		♣9540HD
Belt - Fan & Air Brake Compr.	2027569	5700	Hose - Upper		21095
Belt - Fan To A.P.	9433881	♣9380HD	Hose - Lower		21409
Belt - Alt. & A.P.; W/108A. Alt.		♣9630HD	Hose - By Pass		♣20777
Belt - Alt. & A.P.; W/80A., 100A. Alt.		♣9640HD	GM V-8 5.7 L		
Belt - Alt. & A.P.; W/105A., 130A., 160A. Alt.		♣9650HD	B6000 B6P Series		
Belt - P.S.; W/40" Belt O.C.		♣9395HD	Belt - Fan & Alt.; W/70A., 108A. Alt.	11502375	♣9525HD
Belt - P.S.; W/Air Brakes; W/59 1/2" Belt O.C.		♣9590HD	Belt - Fan & Alt.; W/80A., 100A. Alt.	2005476	②♣♣9550HD
Belt - P.S.; W/Hyd. Brakes; W/64 3/4" Belt O.C.		♣9640HD	Belt - Fan & Alt.; W/105A., 130A., 160A.		
Belt - A.P. - From C.S.; W/39" Belt O.C.		♣9385HD	Alt.; Preferred Belt	11502386	2/9570PB
Belt - A.P. - From C.S.; W/54 1/2" Belt O.C.	9433913	♣9540HD	Belt - Fan & Alt.; W/105A., 130A., 160A.		
Belt - Air Brake Compr.		♣9720HD	Alt.; Optional Belt	11502386	②♣9570HD
Hose - Upper		22136	Belt - Fan, Alt. & A.P.; W/80A. Alt.	11502410	♣9670HD
Hose - Lower		22135	Belt - Fan, Alt. & A.P.; W/105A., 130A., 160A. Alt.	11502411	♣9680HD
S7000 S7T Series			Belt - Fan & P.S.; W/Hyd. Brakes	9433923	♣9590HD
Belt - Fan & Alt.	11502410	♣9670HD	Belt - P.S. & A.P.		♣9640HD
Hose - Upper - Eng. To Pipe		♣21307	Belt - P.S.; W/Air Brakes	9433881	♣9380HD
Hose - Upper - Pipe To Rad.; W/Auto. Trans.		21523	Belt - Air Brake Compr. & A.P.		♣9670HD
Hose - Upper - Pipe To Rad.; W/Man. Trans.		21521	Belt - A.P.		♣9540HD
Hose - Lower - Pipe To Rad.		21556	Hose - Upper		21095
Hose - By Pass		24222	Hose - Lower		21409
1990			Hose - By Pass		♣20777
Detroit Diesel V-8 8.2 L Diesel			GM V-8 6.0 L		
B6000 B6P Series			B6000 B6P Series		
Belt - Fan & Alt.; W/71 1/2" Belt O.C.	2099791	♣9710HD	Belt - Fan & Alt.; W/63A., 108A. Alt.; Preferred Belt		2/9640PB
Belt - Fan & Alt.; W/97 1/2" Belt O.C.	2056956	②♣9700HD	Belt - Fan & Alt.; W/63A., 108A. Alt.; Optional Belt		②♣9640HD
Belt - Fan & Air Brake Compr.		♣9720HD	Belt - Fan & Alt.; W/80A., 100A. Alt.; Preferred Belt		2/9660PB
Belt - P.S.	11502340	♣9385HD	Belt - Fan & Alt.; W/80A., 100A. Alt.; Optional Belt		②♣9660HD
Belt - Air Brake Compr.	11502419	♣9740HD	Belt - Fan & Alt.; W/105A., 130A., 160A. Alt.; Preferred Belt		
Hose - Upper - Eng. To Pipe		24232	Belt		2/9670PB
Hose - Upper - Pipe To Rad.		21473	Belt - Fan & Alt.; W/105A., 130A., 160A. Alt.; Optional Belt		②♣9670HD
Hose - Lower - Eng. To Pipe		24236	Belt - Fan & P.S.		♣9630HD
Hose - Lower - Pipe To Rad.		24238	Belt - Fan & Hyd. Pump		♣9630HD
Hose - By Pass - Left Side		24222	Belt - Fan & Air Brake Compr.	2027569	5700
Hose - By Pass - Right Side		21457	Belt - Fan To A.P.	9433881	♣9380HD
S7000 S7T Series			Belt - Alt. & A.P.; W/108A. Alt.		♣9630HD
Belt - Fan & Alt.; W/71 1/2" Belt O.C.	2099791	♣9710HD	Belt - Alt. & A.P.; W/80A., 100A. Alt.		♣9640HD
Belt - Fan & Alt.; W/97 1/2" Belt O.C.	2056956	②♣9700HD	Belt - Alt. & A.P.; W/105A., 130A., 160A. Alt.		♣9650HD
Belt - Fan & Air Brake Compr.		♣9720HD	Belt - P.S.; W/40" Belt O.C.	9433884	♣9395HD
Belt - P.S.	11502340	♣9385HD	Belt - P.S.; W/Air Brakes; W/59 1/2" Belt O.C.		♣9590HD
Belt - Air Brake Compr.; W/71 1/2" Belt O.C.	11502416	♣9710HD			

♣Standard Belt Available.
②Two Required.

♣Cut to Fit.
◆PowerBand Belt May Work, Use Template to Check.

Belts and Coolant Hose for School Buses

School Buses

Application	Mfr. Part No.	Our No.	Application	Mfr. Part No.	Our No.
GMC - Continued			GMC - Continued		
1990 - Continued			1990 - Continued		
GM V-8 6.0 L - Continued			GM V-8 7.4 L		
B6000 B6P Series - Continued			B6000 B6P Series		
Belt - P.S.; W/Hyd. Brakes; W/64 3/4" Belt O.C.		▲9640HD	Belt - Fan & Alt.; W/63A., 108A. Alt.; Preferred Belt		2/9640PB
Belt - A.P. - From C.S.; W/39" Belt O.C.		▲9385HD	Belt - Fan & Alt.; W/63A., 108A. Alt.; Optional Belt	②▲9640HD	
Belt - A.P. - From C.S.; W/54 1/2" Belt O.C.	9433913	▲9540HD	Belt - Fan & Alt.; W/80A., 100A. Alt.; Preferred Belt		2/9660PB
Belt - Air Brake Compr.		▲9720HD	Belt - Fan & Alt.; W/80A., 100A. Alt.; Optional Belt	②▲9660HD	
Hose - Upper - Eng. To Pipe		≅21307	Belt - Fan & Alt.; W/105A., 130A., 160A. Alt.; Preferred Belt		2/9670PB
Hose - Upper - Pipe To Rad.; W/Auto. Trans.		21523	Belt - Fan & Alt.; W/105A., 130A., 160A. Alt.; Optional Belt	②▲9670HD	
Hose - Upper - Pipe To Rad.; W/Man. Trans.		21521	Belt - Fan & P.S.		▲9630HD
Hose - Lower - Eng. To Pipe		24236	Belt - Fan & Hyd. Pump		▲9630HD
Hose - Lower - Pipe To Rad.		21556	Belt - Fan & Air Brake Compr.	2027569	5700
Hose - By Pass		24222	Belt - Fan To A.P.	9433881	▲9380HD
S7000 S7T Series			S7000 S7T Series		
Belt - Fan & Alt.		▲9640HD	Belt - Alt. & A.P.; W/108A. Alt.		▲9630HD
Belt - P.S.	9433923	▲9590HD	Belt - Alt. & A.P.; W/80A., 100A. Alt.		▲9640HD
Belt - Air Brake Compr.	11502417	▲9720HD	Belt - Alt. & A.P.; W/105A., 130A., 160A. Alt.		▲9650HD
Belt - A.P.	11502340	▲9385HD	Belt - P.S.; W/40" Belt O.C.	9433884	▲9395HD
Belt - A.P. & Alt.	11502402	▲9630HD	Belt - P.S.; W/Air Brakes; W/59 1/2" Belt O.C.		▲9590HD
Hose - Upper - Eng. To Pipe		≅21307	Belt - P.S.; W/Hyd. Brakes; W/64 3/4" Belt O.C.		▲9640HD
Hose - Upper - Pipe To Rad.; W/Auto. Trans.		21523	Belt - A.P. - From C.S.; W/39" Belt O.C.		▲9385HD
Hose - Upper - Pipe To Rad.; W/Man. Trans.		21521	Belt - A.P. - From C.S.; W/54 1/2" Belt O.C.	9433913	▲9540HD
Hose - Lower - Pipe To Rad.		21556	Belt - Air Brake Compr.		▲9720HD
Hose - By Pass		24222	Hose - Upper - Eng. To Pipe		≅21307
GM V-8 7.0 L			1989		
B6000 B6P Series			Detroit Diesel V-8 8.2 L Diesel		
Belt - Fan & Alt.; W/63A., 108A. Alt.; Preferred Belt		2/9640PB	B6000 B6P Series		
Belt - Fan & Alt.; W/63A., 108A. Alt.; Optional Belt	②▲9640HD		Belt - Fan & Alt.; W/71 1/2" Belt O.C.	2099791	▲9710HD
Belt - Fan & Alt.; W/80A., 100A. Alt.; Preferred Belt		2/9660PB	Belt - Fan & Alt.; W/97 1/2" Belt O.C.	2056956	②▲9700HD
Belt - Fan & Alt.; W/80A., 100A. Alt.; Optional Belt	②▲9660HD		Belt - Fan & Air Brake Compr.		▲9720HD
Belt - Fan & Alt.; W/105A., 130A., 160A. Alt.; Preferred Belt		2/9670PB	Belt - P.S.	11502340	▲9385HD
Belt - Fan & Alt.; W/105A., 130A., 160A. Alt.; Optional Belt	②▲9670HD		Belt - Air Brake Compr.	11502419	▲9740HD
Belt - Fan & P.S.	▲9630HD		Hose - Upper - Eng. To Pipe		24232
Belt - Fan & Hyd. Pump	▲9630HD		Hose - Upper - Pipe To Rad.		21473
Belt - Fan & Air Brake Compr.	2027569	5700	Hose - Lower - Eng. To Pipe		24236
Belt - Fan To A.P.	9433881	▲9380HD	Hose - Lower - Pipe To Rad.		24238
Belt - Alt. & A.P.; W/108A. Alt.		▲9630HD	Hose - By Pass - Left Side		24222
Belt - Alt. & A.P.; W/80A., 100A. Alt.		▲9640HD	Hose - By Pass - Right Side		21457
Belt - Alt. & A.P.; W/105A., 130A., 160A. Alt.		▲9650HD	S7000 S7T Series		
Belt - P.S.; W/40" Belt O.C.	9433884	▲9395HD	Belt - Fan & Alt.; W/71 1/2" Belt O.C.	2099791	▲9710HD
Belt - P.S.; W/Air Brakes; W/59 1/2" Belt O.C.		▲9590HD	Belt - Fan & Alt.; W/97 1/2" Belt O.C.	2056956	②▲9700HD
Belt - P.S.; W/Hyd. Brakes; W/64 3/4" Belt O.C.		▲9640HD	Belt - Fan & Air Brake Compr.		▲9720HD
Belt - A.P. - From C.S.; W/39" Belt O.C.		▲9385HD	Belt - P.S.	11502340	▲9385HD
Belt - A.P. - From C.S.; W/54 1/2" Belt O.C.	9433913	▲9540HD	Belt - Air Brake Compr.	11502419	▲9740HD
Belt - Air Brake Compr.		▲9720HD	Hose - Upper - Eng. To Pipe		24232
Hose - Upper - Eng. To Pipe		≅21307	Hose - Upper - Pipe To Rad.		21473
Hose - Upper - Pipe To Rad.; W/Auto. Trans.		21523	Hose - Lower - Eng. To Pipe		24236
Hose - Upper - Pipe To Rad.; W/Man. Trans.		21521	Hose - Lower - Pipe To Rad.		24238
Hose - Lower - Eng. To Pipe		24236	Hose - By Pass		24222
Hose - Lower - Pipe To Rad.		21556	Hose - By Pass - Left Side		24222
Hose - By Pass		24222	Hose - By Pass - Right Side		21457
S7000 S7T Series			S7000 S7T Series		
Belt - Fan & Alt.		▲9640HD	Belt - Fan & Alt.; W/71 1/2" Belt O.C.	2099791	▲9710HD
Belt - P.S.	9433923	▲9590HD	Belt - Fan & Alt.; W/97 1/2" Belt O.C.	2056956	②▲9700HD
Belt - Air Brake Compr.	11502417	▲9720HD	Belt - Fan & Air Brake Compr.		▲9720HD
Belt - A.P.	11502340	▲9385HD	Belt - P.S.	11502340	▲9385HD
Belt - A.P. & Alt.	11502402	▲9630HD	Belt - Air Brake Compr.	11502419	▲9740HD
Hose - Upper - Eng. To Pipe		≅21307	Hose - Upper - Eng. To Pipe		24232
Hose - Upper - Pipe To Rad.; W/Auto. Trans.		21523	Hose - Upper - Pipe To Rad.		21473
Hose - Upper - Pipe To Rad.; W/Man. Trans.		21521	Hose - Lower - Eng. To Pipe		24236
Hose - Lower - Pipe To Rad.		21556	Hose - Lower - Pipe To Rad.		24238
Hose - By Pass		24222	Hose - By Pass		24222
			S7000 S7T Series		
			Belt - Fan & Alt.; W/71 1/2" Belt O.C.	2099791	▲9710HD
			Belt - Fan & Alt.; W/97 1/2" Belt O.C.	2056956	②▲9700HD
			Belt - Fan & Air Brake Compr.		▲9720HD
			Belt - P.S.	11502340	▲9385HD
			Belt - Air Brake Compr.	11502419	▲9740HD
			Hose - Upper - Eng. To Pipe		24232
			Hose - Upper - Pipe To Rad.		21473
			Hose - Lower - Eng. To Pipe		24236
			Hose - Lower - Pipe To Rad.		24238
			Hose - By Pass - Left Side		24222
			Hose - By Pass - Right Side		21457

▲Standard Belt Available.
②Two Required.

≅Cut to Fit.

Belts and Coolant Hose for School Buses

School Buses

Application	Mfr. Part No.	Our No.	Application	Mfr. Part No.	Our No.
GMC - Continued			GMC - Continued		
1989 - Continued			1988		
Detroit Diesel V-8 8.2 L Diesel - Continued			Detroit Diesel V-8 8.2 L Diesel		
S7000 S7T Series - Continued			B6000 B6P Series		
Hose - Lower - Pipe To Rad.		24238	Belt - Fan & Alt.; W/71 1/2" Belt O.C.	2099791	♣9710HD
Hose - By Pass - Left Side		24222	Belt - Fan & Alt.; W/97 1/2" Belt O.C.	2056956	②♣9700HD
Hose - By Pass - Right Side		21457	Belt - Fan & Air Brake Compr.		♣9720HD
GM V-8 5.7 L			Belt - P.S.	11502340	♣9385HD
B6000 B6P Series			Belt - Air Brake Compr.	11502419	♣9740HD
Belt - Fan & Alt.; W/70A., 108A. Alt.	11502375	♣9525HD	Hose - Upper - Eng. To Pipe		24232
Belt - Fan & Alt.; W/80A., 100A. Alt.	2005476	②♣9550HD	Hose - Upper - Pipe To Rad.		21473
Belt - Fan & Alt.; W/105A., 130A., 160A. Alt.	11502386	②♣9570HD	Hose - Lower - Eng. To Pipe		24236
Belt - Fan, Alt. & A.P.; W/80A. Alt.	11502410	♣9670HD	Hose - Lower - Pipe To Rad.		24238
Belt - Fan, Alt. & A.P.; W/105A., 130A., 160A. Alt.	11502411	♣9680HD	Hose - By Pass - Left Side		24222
Belt - Fan & P.S.; W/Hyd. Brakes	9433923	♣9590HD	Hose - By Pass - Right Side		21457
Belt - P.S. & A.P.		♣9640HD	S7000 S7T Series		
Belt - P.S.; W/Air Brakes	9433881	♣9380HD	Belt - Fan & Alt.; W/71 1/2" Belt O.C.	2099791	♣9710HD
Belt - Air Brake Compr. & A.P.		♣9670HD	Belt - Fan & Alt.; W/97 1/2" Belt O.C.	2056956	②♣9700HD
Belt - A.P.		♣9540HD	Belt - Fan & Air Brake Compr.		♣9720HD
Hose - Upper		21095	Belt - P.S.	11502340	♣9385HD
Hose - Lower		21409	Belt - Air Brake Compr.; W/71 1/2" Belt O.C.	11502416	♣9710HD
Hose - By Pass		≈20777	Belt - Air Brake Compr.; W/75" Belt O.C.	11502340	♣9745HD
GM V-8 6.0 L			Hose - Upper - Eng. To Pipe		24232
B6000 B6P Series			Hose - Upper - Pipe To Rad.		21473
Belt - Fan & Alt.; W/63A., 108A. Alt.; Preferred Belt		2/9640PB	Hose - Lower - Eng. To Pipe		24236
Belt - Fan & Alt.; W/63A., 108A. Alt.; Optional Belt		②♣9640HD	Hose - Lower - Pipe To Rad.		24238
Belt - Fan & Alt.; W/80A., 100A. Alt.; Preferred Belt		2/9660PB	Hose - By Pass - Left Side		24222
Belt - Fan & Alt.; W/80A., 100A. Alt.; Optional Belt		②♣9660HD	Hose - By Pass - Right Side		21457
Belt - Fan & Alt.; W/105A., 130A., 160A. Alt.; Preferred Belt		2/9670PB	GM V-8 5.7 L		
Belt - Fan & Alt.; W/105A., 130A., 160A. Alt.; Optional Belt		②♣9670HD	B6000 B6P Series		
Belt - Fan & P.S.		♣9630HD	Belt - Fan & Alt.; W/70A., 108A. Alt.	11502375	♣9525HD
Belt - Fan & Hyd. Pump		♣9630HD	Belt - Fan & Alt.; W/80A., 100A. Alt.	2005476	②♣9550HD
Belt - Fan & Air Brake Compr.	2027569	5700	Belt - Fan & Alt.; W/105A., 130A., 160A. Alt.	11502386	②♣9570HD
Belt - Fan To A.P.	9433881	♣9380HD	Belt - Fan, Alt. & A.P.; W/80A. Alt.	11502410	♣9670HD
Belt - Alt. & A.P.; W/108A. Alt.		♣9630HD	Belt - Fan, Alt. & A.P.; W/105A., 130A., 160A. Alt.	11502411	♣9680HD
Belt - Alt. & A.P.; W/80A., 100A. Alt.		♣9640HD	Belt - Fan & P.S.; W/Hyd. Brakes	9433923	♣9590HD
Belt - Alt. & A.P.; W/105A., 130A., 160A. Alt.		♣9650HD	Belt - P.S. & A.P.		♣9640HD
Belt - P.S.; W/40" Belt O.C.	9433884	♣9395HD	Belt - P.S.; W/Air Brakes	9433881	♣9380HD
Belt - P.S.; W/Air Brakes; W/59 1/2" Belt O.C.		♣9590HD	Belt - Air Brake Compr. & A.P.		♣9670HD
Belt - P.S.; W/Hyd. Brakes; W/64 3/4" Belt O.C.		♣9640HD	Belt - A.P.		♣9540HD
Belt - A.P. - From C.S.; W/39" Belt O.C.		♣9385HD	Hose - Upper		21095
Belt - A.P. - From C.S.; W/54 1/2" Belt O.C.	9433913	♣9540HD	Hose - Lower		21409
Belt - Air Brake Compr.		♣9720HD	Hose - By Pass		≈20777
Hose - Upper - Eng. To Pipe		≈21307	GM V-8 6.0 L		
Hose - Upper - Pipe To Rad.; W/Auto. Trans.		21523	B6000 B6P Series		
Hose - Upper - Pipe To Rad.; W/Man. Trans.		21521	Belt - Fan & Alt.; W/63A., 108A. Alt.		②♣9640HD
Hose - Lower - Eng. To Pipe		24236	Belt - Fan & Alt.; W/80A., 100A. Alt.		②♣9660HD
Hose - Lower - Pipe To Rad.		21556	Belt - Fan & Alt.; W/105A., 130A., 160A. Alt.		②♣9670HD
Hose - By Pass		24222	Belt - Fan & P.S.		♣9630HD
S7000 S7T Series			Belt - Fan & Hyd. Pump		♣9630HD
Belt - Fan & Alt.		♣9640HD	Belt - Fan & Air Brake Compr.	2027569	5700
Belt - P.S.	9433923	♣9590HD	Belt - Fan To A.P.	9433881	♣9380HD
Belt - Air Brake Compr.	11502417	♣9720HD	Belt - Alt. & A.P.; W/108A. Alt.		♣9630HD
Belt - A.P.	11502340	♣9385HD	Belt - Alt. & A.P.; W/80A., 100A. Alt.		♣9640HD
Belt - A.P. & Alt.	11502402	♣9630HD	Belt - Alt. & A.P.; W/105A., 130A., 160A. Alt.		♣9650HD
Hose - Upper - Eng. To Pipe		≈21307	Belt - P.S.; W/40" Belt O.C.	9433884	♣9395HD
Hose - Upper - Pipe To Rad.; W/Auto. Trans.		21523	Belt - P.S.; W/Air Brakes; W/59 1/2" Belt O.C.		♣9590HD
Hose - Upper - Pipe To Rad.; W/Man. Trans.		21521	Belt - P.S.; W/Hyd. Brakes; W/64 3/4" Belt O.C.		♣9640HD
Hose - Lower - Pipe To Rad.		21556	Belt - A.P. - From C.S.; W/39" Belt O.C.		♣9385HD
Hose - By Pass		24222	Belt - A.P. - From C.S.; W/54 1/2" Belt O.C.	9433913	♣9540HD
			Belt - Air Brake Compr.		♣9720HD
			Hose - Upper - Eng. To Pipe		≈21307
			Hose - Upper - Pipe To Rad.; W/Auto. Trans.		21523
			Hose - Upper - Pipe To Rad.; W/Man. Trans.		21521

♣Standard Belt Available.
②Two Required.

◆PowerBand Belt May Work, Use Template to Check.
≈Cut to Fit.

Belts and Coolant Hose for School Buses

Application	Mfr. Part No.	Our No.	Application	Mfr. Part No.	Our No.
GMC - Continued			GMC - Continued		
1988 - Continued			1987 - 1986 - Continued		
GM V-8 6.0 L - Continued			GM V-8 6.0 L - Continued		
B6000 B6P Series - Continued			B6000 B6P Series - Continued		
Hose - Lower - Eng. To Pipe		24236	Belt - Air Brake Compr.		▲9720HD
Hose - Lower - Pipe To Rad.		21556	Hose - Upper - Eng. To Pipe		≈21307
Hose - By Pass		24222	Hose - Upper - Pipe To Rad.; W/Auto. Trans.		21523
S7000 S7T Series			Hose - Upper - Pipe To Rad.; W/Man. Trans.		21521
Belt - Fan & Alt.		▲9640HD	Hose - Lower - Eng. To Pipe		24236
Belt - P.S.	9433923	▲9590HD	Hose - Lower - Pipe To Rad.		21556
Belt - Air Brake Compr.	11502417	▲9720HD	Hose - By Pass		24222
Belt - A.P.	11502340	▲9385HD	1985 - 1983		
Belt - A.P. & Alt.	11502402	▲9630HD	Detroit Diesel V-8 8.2 L Diesel		
Hose - Upper - Eng. To Pipe		≈21307	B6000 B6P Series		
Hose - Upper - Pipe To Rad.; W/Auto. Trans.		21523	Belt - Fan & Alt.; W/71 1/2" Belt O.C.	2099791	▲9710HD
Hose - Upper - Pipe To Rad.; W/Man. Trans.		21521	Belt - Fan & Alt.; W/97 1/2" Belt O.C.	2056956	②▲9700HD
Hose - Lower - Pipe To Rad.		21556	Belt - Fan & Air Brake Compr.		▲9720HD
Hose - By Pass		24222	Belt - P.S.	11502340	▲9385HD
1987 - 1986			Belt - Air Brake Compr.	11502419	▲9740HD
Detroit Diesel V-8 8.2 L Diesel			Hose - Upper - Eng. To Pipe		24232
B6000 B6P Series			Hose - Upper - Pipe To Rad.		21473
Belt - Fan & Alt.; W/71 1/2" Belt O.C.	2099791	▲9710HD	Hose - Lower - Eng. To Pipe		24236
Belt - Fan & Alt.; W/97 1/2" Belt O.C.	2056956	②▲9700HD	Hose - Lower - Pipe To Rad.		24238
Belt - Fan & Air Brake Compr.		▲9720HD	Hose - By Pass - Left Side		24222
Belt - P.S.	11502340	▲9385HD	Hose - By Pass - Right Side		21457
Belt - Air Brake Compr.	11502419	▲9740HD	GM V-8 5.7 L		
Hose - Upper - Eng. To Pipe		24232	B6000 B6P Series		
Hose - Upper - Pipe To Rad.		21473	Belt - Fan & Alt.; W/70A., 108A. Alt.	11502375	▲9525HD
Hose - Lower - Eng. To Pipe		24236	Belt - Fan & Alt.; W/80A., 100A. Alt.	2005476	②▲◆9550HD
Hose - Lower - Pipe To Rad.		24238	Belt - Fan & Alt.; W/105A., 130A., 160A. Alt.	11502386	②▲◆9570HD
Hose - By Pass - Left Side		24222	Belt - Fan, Alt. & A.P.; W/80A. Alt.	11502410	▲9670HD
Hose - By Pass - Right Side		21457	Belt - Fan, Alt. & A.P.; W/105A., 130A., 160A. Alt.	11502411	▲9680HD
GM V-8 5.7 L			Belt - Fan & P.S.; W/Hyd. Brakes	9433923	▲9590HD
B6000 B6P Series			Belt - P.S. & A.P.		▲9640HD
Belt - Fan & Alt.; W/70A., 108A. Alt.	11502375	▲9525HD	Belt - P.S.; W/Air Brakes	9433881	▲9380HD
Belt - Fan & Alt.; W/80A., 100A. Alt.	2005476	②▲◆9550HD	Belt - Air Brake Compr. & A.P.		▲9670HD
Belt - Fan & Alt.; W/105A., 130A., 160A. Alt.	11502386	②▲◆9570HD	Belt - A.P.		▲9540HD
Belt - Fan, Alt. & A.P.; W/80A. Alt.	11502410	▲9670HD	Hose - Upper		21095
Belt - Fan, Alt. & A.P.; W/105A., 130A., 160A. Alt.	11502411	▲9680HD	Hose - Lower		21409
Belt - Fan & P.S.; W/Hyd. Brakes	9433923	▲9590HD	Hose - By Pass		≈20777
Belt - P.S. & A.P.		▲9640HD	GM V-8 6.0 L		
Belt - P.S.; W/Air Brakes	9433881	▲9380HD	B6000 B6P Series		
Belt - Air Brake Compr. & A.P.		▲9670HD	Belt - Fan & Alt.; W/63A., 108A. Alt.		②▲◆9640HD
Belt - A.P.		▲9540HD	Belt - Fan & Alt.; W/80A., 100A. Alt.		②▲◆9660HD
Hose - Upper		21095	Belt - Fan & Alt.; W/105A., 130A., 160A. Alt.		②▲◆9670HD
Hose - Lower		21409	Belt - Fan & P.S.		▲9630HD
Hose - By Pass		≈20777	Belt - Fan & Hyd. Pump		▲9630HD
GM V-8 6.0 L			Belt - Fan & Air Brake Compr.	2027569	5700
B6000 B6P Series			Belt - Fan To A.P.	9433881	▲9380HD
Belt - Fan & Alt.; W/63A., 108A. Alt.		②▲◆9640HD	Belt - Alt. & A.P.; W/108A. Alt.		▲9630HD
Belt - Fan & Alt.; W/80A., 100A. Alt.		②▲◆9660HD	Belt - Alt. & A.P.; W/80A., 100A. Alt.		▲9640HD
Belt - Fan & Alt.; W/105A., 130A., 160A. Alt.		②▲◆9670HD	Belt - Alt. & A.P.; W/105A., 130A., 160A. Alt.		▲9650HD
Belt - Fan & P.S.		▲9630HD	Belt - P.S.; W/40" Belt O.C.	9433884	▲9395HD
Belt - Fan & Hyd. Pump		▲9630HD	Belt - P.S.; W/Air Brakes; W/59 1/2" Belt O.C.		▲9590HD
Belt - Fan & Air Brake Compr.	2027569	5700	Belt - P.S.; W/Hyd. Brakes; W/64 3/4" Belt O.C.		▲9640HD
Belt - Fan To A.P.	9433881	▲9380HD	Belt - A.P. - From C.S.; W/39" Belt O.C.		▲9385HD
Belt - Alt. & A.P.; W/108A. Alt.		▲9630HD	Belt - A.P. - From C.S.; W/54 1/2" Belt O.C.	9433913	▲9540HD
Belt - Alt. & A.P.; W/80A., 100A. Alt.		▲9640HD	Belt - Air Brake Compr.		▲9720HD
Belt - Alt. & A.P.; W/105A., 130A., 160A. Alt.		▲9650HD	Hose - Upper		21107
Belt - P.S.; W/40" Belt O.C.	9433884	▲9395HD	Hose - Lower - Eng. To Pipe		24236
Belt - P.S.; W/Air Brakes; W/59 1/2" Belt O.C.		▲9590HD	Hose - Lower - Pipe To Rad.		21556
Belt - P.S.; W/Hyd. Brakes; W/64 3/4" Belt O.C.		▲9640HD	Hose - By Pass		24222
Belt - A.P. - From C.S.; W/39" Belt O.C.		▲9385HD			
Belt - A.P. - From C.S.; W/54 1/2" Belt O.C.	9433913	▲9540HD			

▲Standard Belt Available.
②Two Required.

≈Cut to Fit.
◆PowerBand Belt May Work, Use Template to Check.

School Buses

Belts and Coolant Hose for School Buses

School Buses

Application	Mfr. Part No.	Our No.	Application	Mfr. Part No.	Our No.
GMC - Continued			GMC - Continued		
1985 - 1983 - Continued			1982 - Continued		
GM V-8 7.0 L			GM V-8 6.0 L - Continued		
B6000 B6P Series			B6000 B6P Series - Continued		
Belt - Fan & Alt.; W/63A., 108A. Alt.		②◆◆9640HD	Belt - Alt. & A.P.; W/108A. Alt.		◆9630HD
Belt - Fan & Alt.; W/80A., 100A. Alt.		②◆◆9660HD	Belt - Alt. & A.P.; W/80A., 100A. Alt.		◆9640HD
Belt - Fan & Alt.; W/105A., 130A., 160A. Alt.		②◆◆9670HD	Belt - Alt. & A.P.; W/105A., 130A., 160A. Alt.		◆9650HD
Belt - Fan & P.S.		◆9630HD	Belt - P.S.; W/40" Belt O.C.	9433884	◆9395HD
Belt - Fan & Hyd. Pump		◆9630HD	Belt - P.S.; W/Air Brakes; W/59 1/2" Belt O.C.		◆9590HD
Belt - Fan & Air Brake Compr.	2027569	5700	Belt - P.S.; W/Hyd. Brakes; W/64 3/4" Belt O.C.		◆9640HD
Belt - Fan To A.P.	9433881	◆9380HD	Belt - A.P. - From C.S.; W/39" Belt O.C.		◆9385HD
Belt - Alt. & A.P.; W/108A. Alt.		◆9630HD	Belt - A.P. - From C.S.; W/54 1/2" Belt O.C.	9433913	◆9540HD
Belt - Alt. & A.P.; W/80A., 100A. Alt.		◆9640HD	Belt - Air Brake Compr.		◆9720HD
Belt - Alt. & A.P.; W/105A., 130A., 160A. Alt.		◆9650HD	Hose - Upper		21107
Belt - P.S.; W/40" Belt O.C.	9433884	◆9395HD	Hose - Lower - Eng. To Pipe		24236
Belt - P.S.; W/Air Brakes; W/59 1/2" Belt O.C.		◆9590HD	Hose - Lower - Pipe To Rad.		21556
Belt - P.S.; W/Hyd. Brakes; W/64 3/4" Belt O.C.		◆9640HD	Hose - By Pass		24222
Belt - A.P. - From C.S.; W/39" Belt O.C.		◆9385HD			
Belt - A.P. - From C.S.; W/54 1/2" Belt O.C.	9433913	◆9540HD			
Belt - Air Brake Compr.		◆9720HD			
Hose - Upper		21107			
Hose - Lower - Eng. To Pipe		24236			
Hose - Lower - Pipe To Rad.		21556			
Hose - By Pass		24222			
1982			GM V-8 7.0 L		
Detroit Diesel V-8 8.2 L Diesel			B6000 B6P Series		
Belt - Fan & Alt.; W/71 1/2" Belt O.C.	2099791	◆9710HD	Belt - Fan & Alt.; W/63A., 108A. Alt.		②◆◆9640HD
Belt - Fan & Alt.; W/97 1/2" Belt O.C.	2056956	②◆◆9700HD	Belt - Fan & Alt.; W/80A., 100A. Alt.		②◆◆9660HD
Belt - Fan & Air Brake Compr.; Jan. 10, 1982 & Older	11502414	◆9700HD	Belt - Fan & Alt.; W/105A., 130A., 160A. Alt.		②◆◆9670HD
Belt - Fan & Air Brake Compr.; Jan. 11, 1982 & Newer		◆9720HD	Belt - Fan & P.S.		◆9630HD
Belt - P.S.	11502340	◆9385HD	Belt - Fan & Hyd. Pump		◆9630HD
Belt - Air Brake Compr.	11502419	◆9740HD	Belt - Fan & Air Brake Compr.	2027569	5700
Hose - Upper - Eng. To Pipe		24232	Belt - Fan To A.P.	9433881	◆9380HD
Hose - Upper - Pipe To Rad.		21473	Belt - Alt. & A.P.; W/108A. Alt.		◆9630HD
Hose - Lower - Eng. To Pipe		24236	Belt - Alt. & A.P.; W/80A., 100A. Alt.		◆9640HD
Hose - Lower - Pipe To Rad.		24238	Belt - Alt. & A.P.; W/105A., 130A., 160A. Alt.		◆9650HD
Hose - By Pass - Left Side		24222	Belt - P.S.; W/40" Belt O.C.	9433884	◆9395HD
Hose - By Pass - Right Side		21457	Belt - P.S.; W/Air Brakes; W/59 1/2" Belt O.C.		◆9590HD
			Belt - P.S.; W/Hyd. Brakes; W/64 3/4" Belt O.C.		◆9640HD
			Belt - A.P. - From C.S.; W/39" Belt O.C.		◆9385HD
			Belt - A.P. - From C.S.; W/54 1/2" Belt O.C.	9433913	◆9540HD
			Belt - Air Brake Compr.		◆9720HD
			Hose - Upper		21107
			Hose - Lower - Eng. To Pipe		24236
			Hose - Lower - Pipe To Rad.		21556
			Hose - By Pass		24222
			1981 - 1980		
			Detroit Diesel V-8 8.2 L Diesel		
			B6000 B6P Series		
			Belt - Fan & Alt.; W/71 1/2" Belt O.C.	2099791	◆9710HD
			Belt - Fan & Alt.; W/97 1/2" Belt O.C.	2056956	②◆◆9700HD
			Belt - Fan & Air Brake Compr.	11502414	◆9700HD
			Belt - P.S.	11502340	◆9385HD
			Belt - Air Brake Compr.	11502419	◆9740HD
			Hose - Upper - Eng. To Pipe		24232
			Hose - Upper - Pipe To Rad.		21473
			Hose - Lower - Eng. To Pipe		24236
			Hose - Lower - Pipe To Rad.		24238
			Hose - By Pass - Left Side		24222
			Hose - By Pass - Right Side		21457
			GM V-8 5.7 L		
			B6000 B6P Series		
			Belt - Fan & Alt.; W/70A., 108A. Alt.	11502375	◆9525HD
			Belt - Fan & Alt.; W/80A., 100A. Alt.	2005476	②◆◆9550HD
			Belt - Fan & Alt.; W/105A., 130A., 160A. Alt.		②◆◆9570HD
			Belt - Fan, Alt. & A.P.; W/80A. Alt.	11502386	◆9670HD
			Belt - Fan, Alt. & A.P.; W/105A., 130A., 160A. Alt.	11502411	◆9680HD
			Belt - Fan & P.S.; W/Hyd. Brakes	9433923	◆9590HD
			Belt - P.S. & A.P.		◆9640HD
			Belt - P.S.; W/Air Brakes	9433881	◆9380HD
			Belt - Air Brake Compr. & A.P.		◆9670HD
			Belt - A.P.		◆9540HD
			Hose - Upper		21095
			Hose - Lower		21409
			Hose - By Pass		≈20777
			GM V-8 6.0 L		
			B6000 B6P Series		
			Belt - Fan & Alt.; W/63A., 108A. Alt.		②◆◆9640HD
			Belt - Fan & Alt.; W/80A., 100A. Alt.		②◆◆9660HD
			Belt - Fan & Alt.; W/105A., 130A., 160A. Alt.		②◆◆9670HD
			Belt - Fan & P.S.		◆9630HD
			Belt - Fan & Hyd. Pump		◆9630HD
			Belt - Fan & Air Brake Compr.	2027569	5700
			Belt - Fan To A.P.	9433881	◆9380HD

◆Standard Belt Available.
②Two Required.

◆PowerBand Belt May Work, Use Template to Check.
≈Cut to Fit.

Belts and Coolant Hose for School Buses

Application	Mfr. Part No.	Our No.	Application	Mfr. Part No.	Our No.
GMC - Continued			GMC - Continued		
1981 - 1980 - Continued			1979 - Continued		
GM V-8 5.7 L - Continued			GM 6-Cyl. 292 - Continued		
B6000 B6P Series - Continued			SS6000 - Continued		
Belt - Air Brake Compr. & A.P.		▲9670HD	Hose - Upper		≡20686
Belt - A.P.		▲9540HD	Hose - Lower		20489
Hose - Upper		21095		or	26611
Hose - Lower		21409	Hose - By Pass		20563
Hose - By Pass		≡20777	Hose - Heater Inlet		28442
			Hose - Heater Outlet		28441
GM V-8 6.0 L			GM V-8 350		
B6000 B6P Series			B6000 B6P Series		
Belt - Fan & Alt.; W/63A., 108A. Alt.		②▲◆9640HD	Belt - Fan & Alt.; W/70A., 108A. Alt.	11502375	▲9525HD
Belt - Fan & Alt.; W/80A., 100A. Alt.		②▲◆9660HD	Belt - Fan & Alt.; W/80A., 100A. Alt.	2005476	②▲◆9550HD
Belt - Fan & Alt.; W/105A., 130A., 160A. Alt.		②▲◆9670HD	Belt - Fan & Alt.; W/105A., 130A., 160A. Alt.		②▲◆9570HD
Belt - Fan & P.S.		▲9630HD	Alt.	11502386	②▲◆9570HD
Belt - Fan & Hyd. Pump		▲9630HD	Belt - Fan, Alt. & A.P.; W/80A. Alt.	11502410	▲9670HD
Belt - Fan & Air Brake Compr.	2027569	5700	Belt - Fan, Alt. & A.P.; W/105A., 130A., 160A. Alt.	11502411	▲9680HD
Belt - Fan To A.P.	9433881	▲9380HD	Belt - Fan & P.S.; W/Hyd. Brakes	9433923	▲9590HD
Belt - Alt. & A.P.; W/108A. Alt.		▲9630HD	Belt - P.S. & A.P.		▲9640HD
Belt - Alt. & A.P.; W/80A., 100A. Alt.		▲9640HD	Belt - P.S.; W/Air Brakes	9433881	▲9380HD
Belt - Alt. & A.P.; W/105A., 130A., 160A. Alt.		▲9650HD	Belt - Air Brake Compr. & A.P.		▲9670HD
Belt - P.S.; W/40" Belt O.C.	9433884	▲9395HD	Belt - A.P.		▲9540HD
Belt - P.S.; W/Air Brakes; W/59 1/2" Belt O.C.		▲9590HD	Hose - Upper		21095
Belt - P.S.; W/Hyd. Brakes; W/64 3/4" Belt O.C.		▲9640HD	Hose - Lower		21409
Belt - A.P. - From C.S.; W/39" Belt O.C.		▲9385HD	Hose - By Pass		≡20777
Belt - A.P. - From C.S.; W/54 1/2" Belt O.C.	9433913	▲9540HD			
Belt - Air Brake Compr.		▲9720HD			
Hose - Upper		21107			
Hose - Lower - Eng. To Pipe		24236			
Hose - Lower - Pipe To Rad.		21556			
Hose - By Pass		24222			
GM V-8 7.0 L			GM V-8 366		
B6000 B6P Series			B6000 B6P Series		
Belt - Fan & Alt.; W/63A., 108A. Alt.		②▲◆9640HD	Belt - Fan & Alt.; W/63A., 108A. Alt.		②▲◆9640HD
Belt - Fan & Alt.; W/80A., 100A. Alt.		②▲◆9660HD	Belt - Fan & Alt.; W/80A., 100A. Alt.		②▲◆9660HD
Belt - Fan & Alt.; W/105A., 130A., 160A. Alt.		②▲◆9670HD	Belt - Fan & Alt.; W/105A., 130A., 160A. Alt.		②▲◆9670HD
Belt - Fan & P.S.		▲9630HD	Belt - Fan & P.S.		▲9630HD
Belt - Fan & Hyd. Pump		▲9630HD	Belt - Fan & Hyd. Pump		▲9630HD
Belt - Fan & Air Brake Compr.	2027569	5700	Belt - Fan & Air Brake Compr.	2027569	5700
Belt - Fan To A.P.	9433881	▲9380HD	Belt - Fan To A.P.	9433881	▲9380HD
Belt - Alt. & A.P.; W/108A. Alt.		▲9630HD	Belt - Alt. & A.P.; W/108A. Alt.		▲9630HD
Belt - Alt. & A.P.; W/80A., 100A. Alt.		▲9640HD	Belt - Alt. & A.P.; W/80A., 100A. Alt.		▲9640HD
Belt - Alt. & A.P.; W/105A., 130A., 160A. Alt.		▲9650HD	Belt - Alt. & A.P.; W/105A., 130A., 160A. Alt.		▲9650HD
Belt - P.S.; W/40" Belt O.C.	9433884	▲9395HD	Belt - P.S.; W/40" Belt O.C.	9433884	▲9395HD
Belt - P.S.; W/Air Brakes; W/59 1/2" Belt O.C.		▲9590HD	Belt - P.S.; W/Air Brakes; W/59 1/2" Belt O.C.		▲9590HD
Belt - P.S.; W/Hyd. Brakes; W/64 3/4" Belt O.C.		▲9640HD	Belt - P.S.; W/Hyd. Brakes; W/64 3/4" Belt O.C.		▲9640HD
Belt - A.P. - From C.S.; W/39" Belt O.C.		▲9385HD	Belt - A.P. - From C.S.; W/39" Belt O.C.		▲9385HD
Belt - A.P. - From C.S.; W/54 1/2" Belt O.C.	9433913	▲9540HD	Belt - A.P. - From C.S.; W/54 1/2" Belt O.C.	9433913	▲9540HD
Belt - Air Brake Compr.		▲9720HD	Belt - Air Brake Compr.		▲9720HD
Hose - Upper		21107	Hose - Upper		21107
Hose - Lower - Eng. To Pipe		24236	Hose - Lower - Eng. To Pipe		24236
Hose - Lower - Pipe To Rad.		21556	Hose - Lower - Pipe To Rad.		21556
Hose - By Pass		24222	Hose - By Pass		24222
1979			GM V-8 427		
GM 6-Cyl. 292			B6000 B6P Series		
SS6000			Belt - Fan & Alt.; W/63A., 108A. Alt.		
Belt - Fan & Alt.; W/Std. Alt.	3887682	②▲9395HD	Belt - Fan & Alt.; W/80A., 100A. Alt.		②▲◆9660HD
Belt - Fan & Alt.; W/80A. Alt.	3911543	②▲9412HD	Belt - Fan & Alt.; W/105A., 130A., 160A. Alt.		②▲◆9670HD
Belt - Fan & Alt.; W/100A. Alt.	690407	②▲9435HD	Belt - Fan & P.S.		▲9630HD
Belt - Fan, Alt. & P.S.; W/Std. Alt.	3947152	▲9500HD	Belt - Fan & Hyd. Pump		▲9630HD
Belt - Fan, Alt. & P.S.; W/80A. Alt.	3885457	▲9510HD	Belt - Fan & Air Brake Compr.	2027569	5700
Belt - Fan & A.P.	3947150	▲9530HD	Belt - Fan To A.P.	9433881	▲9380HD
Belt - P.S.	9433884	▲9395HD	Belt - Alt. & A.P.; W/108A. Alt.		▲9630HD
Belt - Hyd. Brake Boost Pump	9433896	▲9455HD	Belt - Alt. & A.P.; W/80A., 100A. Alt.		▲9640HD
Belt - A.C.	3888403	7560	Belt - Alt. & A.P.; W/105A., 130A., 160A. Alt.		▲9650HD
			Belt - P.S.; W/40" Belt O.C.	9433884	▲9395HD
			Belt - P.S.; W/Air Brakes; W/59 1/2" Belt O.C.		▲9590HD
			Belt - P.S.; W/Hyd. Brakes; W/64 3/4" Belt O.C.		▲9640HD
			Belt - A.P. - From C.S.; W/39" Belt O.C.		▲9385HD
			Belt - A.P. - From C.S.; W/54 1/2" Belt O.C.	9433913	▲9540HD

▲Standard Belt Available.
◆PowerBand Belt May Work, Use Template to Check.

≡Cut to Fit.
②Two Required.

Belts and Coolant Hose for School Buses

School Buses

Application	Mfr. Part No.	Our No.	Application	Mfr. Part No.	Our No.
GMC - Continued			GMC - Continued		
1979 - Continued			1978 - Continued		
GM V-8 427 - Continued			GM V-8 350 - Continued		
B6000 B6P Series - Continued			SE6000 - Continued		
Belt - Air Brake Compr.		♣9720HD	Belt - P.S.		♣9385HD
Hose - Upper		21107	Belt - Hyd. Brake Boost Pump; W/56 1/4" Belt O.C.	9433917	♣9560HD
Hose - Lower - Eng. To Pipe		24236	Belt - Hyd. Brake Boost Pump; W/59 1/4" Belt O.C.	9433923	♣9590HD
Hose - Lower - Pipe To Rad.		21556	Belt - Hyd. Brake Boost Pump & A.P.; W/65 1/4" Belt O.C.	9433935	♣9650HD
Hose - By Pass		24222	Belt - Hyd. Brake Boost Pump & A.P.; W/68 1/4" Belt O.C.	2027569	♣9680HD
1978			Belt - Air Brake Compr.	3888480	♣9560HD
GM 6-Cyl. 292			Belt - A.P.		♣9530HD
SS6000			Hose - Upper		21095
Belt - Fan & Alt.; W/Std. Alt.	3887682	②♣9395HD	or		25487
Belt - Fan & Alt.; W/80A. Alt.	3911543	②♣9412HD	Hose - Lower		21409
Belt - Fan & Alt.; W/100A. Alt.	690407	②♣9435HD	Hose - By Pass - Left Side		20565
Belt - Fan, Alt. & P.S.; W/Std. Alt.	3947152	♣9500HD	Hose - By Pass - Right Side		≈<20777
Belt - Fan, Alt. & P.S.; W/80A. Alt.	3885457	♣9510HD			
Belt - Fan & A.P.	3947150	♣9530HD	GM V-8 366		
Belt - P.S.	9433884	♣9395HD	SE6000		
Belt - Hyd. Brake Boost Pump	9433896	♣9455HD	Belt - Fan & Alt.; W/61A. Alt.		②♣9560HD
Belt - A.C.	3888403	7560	Belt - Fan & Alt.; W/A.P.; W/61A. Alt.	9433936	♣9660HD
Hose - Upper		≈<20686	Belt - Fan & Alt.; W/A.P.; W/100A., 105A., 130A. Alt.	9433937	♣9670HD
Hose - Lower		20489	Belt - Fan & Alt.; W/O A.P.; W/80A. Alt.	9433936	②♣9660HD
or		26611	Belt - Fan & Alt.; W/O A.P.; W/100A., 105A., 130A. Alt.	9433937	②♣♣9670HD
Hose - By Pass		20563	Belt - Fan & A.P.	9433932	♣9630HD
Hose - Heater Inlet		28442	Belt - Fan & V.P.	3883005	♣9690HD
Hose - Heater Outlet		28441	Belt - P.S.	9433884	♣9395HD
			Belt - Air Brake Compr.	2027569	5700
GM V-8 307			Belt - Air Brake Compr. & A.P.		♣9720HD
SE6000			Belt - Hyd. Brake Boost Pump	9433929	♣9620HD
Belt - Fan & Alt.; W/65A., 70A. Alt.	9433915	②♣♣9550HD	Belt - A.P.	9433881	♣9380HD
Belt - Fan & Alt.; W/105A., 130A. Alt.	3887691	②♣♣9570HD	Hose - Upper		≈<20933
Belt - P.S.		♣9385HD	Hose - Lower		21011
Belt - Hyd. Brake Boost Pump; W/56 1/4" Belt O.C.	9433917	♣9560HD	Hose - By Pass		24228
Belt - Hyd. Brake Boost Pump; W/59 1/4" Belt O.C.	9433923	♣9590HD			
Belt - Hyd. Brake Boost Pump & A.P.; W/65 1/4" Belt O.C.	9433935	♣9650HD	GM V-8 427		
Belt - Hyd. Brake Boost Pump & A.P.; W/68 1/4" Belt O.C.	2027569	♣9680HD	SE6000		
Belt - Air Brake Compr.	3888480	♣9560HD	Belt - Fan & Alt.; W/61A. Alt.		②♣9560HD
Belt - A.P.		♣9530HD	Belt - Fan & Alt.; W/A.P.; W/61A. Alt.	9433936	♣9660HD
Hose - Upper		21095	Belt - Fan & Alt.; W/A.P.; W/100A., 105A., 130A. Alt.	9433937	♣9670HD
or		25487	Belt - Fan & Alt.; W/O A.P.; W/80A. Alt.	9433936	②♣♣9660HD
Hose - Lower		21409	Belt - Fan & Alt.; W/O A.P.; W/100A., 105A., 130A. Alt.	9433937	②♣♣9670HD
Hose - By Pass - Left Side		20565	Belt - Fan & A.P.	9433932	♣9630HD
Hose - By Pass - Right Side		≈<20777	Belt - Fan & V.P.	3883005	♣9690HD
			Belt - P.S.	9433884	♣9395HD
GM V-8 350			Belt - Air Brake Compr.	2027569	5700
B6000 B6P Series			Belt - Air Brake Compr. & A.P.		♣9720HD
Belt - Fan & Alt.; W/70A., 108A. Alt.	11502375	♣9525HD	Belt - Hyd. Brake Boost Pump	9433929	♣9620HD
Belt - Fan & Alt.; W/80A., 100A. Alt.	2005476	②♣♣9550HD	Belt - A.P.	9433881	♣9380HD
Belt - Fan & Alt.; W/105A., 130A., 160A. Alt.	11502386	②♣♣9570HD	Hose - Upper		≈<20933
Belt - Fan, Alt. & A.P.; W/80A. Alt.	11502410	♣9670HD	Hose - Lower		21011
Belt - Fan, Alt. & A.P.; W/105A., 130A., 160A. Alt.	11502411	♣9680HD	Hose - By Pass		24228
Belt - Fan & P.S.; W/Hyd. Brakes	9433923	♣9590HD	GM V-8 454		
Belt - P.S. & A.P.		♣9640HD	SE6000		
Belt - P.S.; W/Air Brakes	9433881	♣9380HD	Belt - Fan & Alt.; W/61A. Alt.		②♣9560HD
Belt - Air Brake Compr. & A.P.		♣9670HD	Belt - Fan & Alt.; W/A.P.; W/61A. Alt.	9433936	♣9660HD
Belt - A.P.		♣9540HD	Belt - Fan & Alt.; W/A.P.; W/100A., 105A., 130A. Alt.	9433937	♣9670HD
Hose - Upper		21095	Belt - Fan & Alt.; W/O A.P.; W/80A. Alt.	9433936	②♣♣9660HD
Hose - Lower		21409	Belt - Fan & Alt.; W/O A.P.; W/100A., 105A., 130A. Alt.	9433937	②♣♣9670HD
Hose - By Pass		≈<20777	Belt - Fan & A.P.	9433932	♣9630HD
SE6000					
Belt - Fan & Alt.; W/65A., 70A. Alt.	9433915	②♣♣9550HD	Application		
Belt - Fan & Alt.; W/105A., 130A. Alt.	3887691	②♣♣9570HD	Mfr. Part No.		

♣Standard Belt Available.

≈<Cut to Fit.

②Two Required.

◆PowerBand Belt May Work, Use Template to Check.

Belts and Coolant Hose for School Buses

Application	Mfr. Part No.	Our No.	Application	Mfr. Part No.	Our No.
GMC - Continued			GMC - Continued		
1978 - Continued			1977 - Continued		
GM V-8 454 - Continued			GM V-8 350 - Continued		
SE6000 - Continued			SE6000 - Continued		
Belt - Fan & V.P.	3883005	♠9690HD	Hose - Lower		21409
Belt - P.S.	9433884	♠9395HD	Hose - By Pass - Left Side		20565
Belt - Air Brake Compr.	2027569	5700	Hose - By Pass - Right Side		≈20777
Belt - Air Brake Compr. & A.P.		♠9720HD	GM V-8 366		
Belt - Hyd. Brake Boost Pump	9433929	♠9620HD	SE6000		
Belt - A.P.	9433881	♠9380HD	Belt - Fan & Alt.; W/61A. Alt.		②♠9560HD
Hose - Upper		≈20933	Belt - Fan & Alt.; W/A.P.; W/61A. Alt.	9433936	♠9660HD
Hose - Lower		21011	Belt - Fan & Alt.; W/A.P.; W/100A., 105A., 130A. Alt.	9433937	♠9670HD
Hose - By Pass		24228	Belt - Fan & Alt.; W/O A.P.; W/80A. Alt.	9433936	②♠9660HD
1977			Belt - Fan & Alt.; W/O A.P.; W/100A., 105A., 130A. Alt.	9433937	②♠9670HD
GM 6-Cyl. 292			Belt - Fan & A.P.	9433932	♠9630HD
SS6000			Belt - Fan & V.P.	3883005	♠9690HD
Belt - Fan & Alt.; W/Std. Alt.	3887682	②♠9395HD	Belt - P.S.	9433884	♠9395HD
Belt - Fan & Alt.; W/80A. Alt.	3911543	②♠9412HD	Belt - Air Brake Compr.	2027569	5700
Belt - Fan & Alt.; W/100A. Alt.	690407	②♠9435HD	Belt - Air Brake Compr. & A.P.		♠9720HD
Belt - Fan, Alt. & P.S.; W/Std. Alt.	3947152	♠9500HD	Belt - Hyd. Brake Boost Pump	9433929	♠9620HD
Belt - Fan, Alt. & P.S.; W/80A. Alt.	3885457	♠9510HD	Belt - A.P.	9433881	♠9380HD
Belt - Fan & A.P.	3947150	♠9530HD	Hose - Upper		≈20933
Belt - P.S.	9433884	♠9395HD	Hose - Lower		21011
Belt - Hyd. Brake Boost Pump	9433896	♠9455HD	Hose - By Pass		24228
Belt - A.C.	3888403	7560	GM V-8 427		
Hose - Upper		≈20686	SE6000		
Hose - Lower		20489	Belt - Fan & Alt.; W/61A. Alt.		②♠9560HD
	or	26611	Belt - Fan & Alt.; W/A.P.; W/61A. Alt.	9433936	♠9660HD
Hose - By Pass		20563	Belt - Fan & Alt.; W/A.P.; W/100A., 105A., 130A. Alt.	9433937	♠9670HD
Hose - Heater Inlet		28442	Belt - Fan & Alt.; W/O A.P.; W/80A. Alt.	9433936	②♠9660HD
Hose - Heater Outlet		28441	Belt - Fan & Alt.; W/O A.P.; W/100A., 105A., 130A. Alt.	9433937	②♠9670HD
GM V-8 307			Belt - Fan & A.P.	9433932	♠9630HD
SE6000			Belt - Fan & V.P.	3883005	♠9690HD
Belt - Fan & Alt.; W/65A., 70A. Alt.	9433915	②♠9550HD	Belt - P.S.	9433884	♠9395HD
Belt - Fan & Alt.; W/105A., 130A. Alt.	3887691	②♠9570HD	Belt - Air Brake Compr.	2027569	5700
Belt - P.S.		♠9385HD	Belt - Air Brake Compr. & A.P.		♠9720HD
Belt - Hyd. Brake Boost Pump; W/56 1/4" Belt O.C.	9433917	♠9560HD	Belt - Hyd. Brake Boost Pump	9433929	♠9620HD
Belt - Hyd. Brake Boost Pump; W/59 1/4" Belt O.C.	9433923	♠9590HD	Belt - A.P.	9433881	♠9380HD
Belt - Hyd. Brake Boost Pump & A.P.; W/65 1/4" Belt O.C.	9433935	♠9650HD	Hose - Upper		≈20933
Belt - Hyd. Brake Boost Pump & A.P.; W/68 1/4" Belt O.C.	2027569	♠9680HD	Hose - Lower		21011
Belt - Air Brake Compr.	3888480	♠9560HD	Hose - By Pass		24228
Belt - A.P.		♠9530HD	GM V-8 454		
Hose - Upper		21095	SE6000		
	or	25487	Belt - Fan & Alt.; W/61A. Alt.		②♠9560HD
Hose - Lower		21409	Belt - Fan & Alt.; W/A.P.; W/61A. Alt.	9433936	♠9660HD
Hose - By Pass - Left Side		20565	Belt - Fan & Alt.; W/A.P.; W/100A., 105A., 130A. Alt.	9433937	♠9670HD
Hose - By Pass - Right Side		≈20777	Belt - Fan & Alt.; W/O A.P.; W/80A. Alt.	9433936	②♠9660HD
GM V-8 350			Belt - Fan & Alt.; W/O A.P.; W/100A., 105A., 130A. Alt.	9433937	②♠9670HD
SE6000			Belt - Fan & A.P.	9433932	♠9630HD
Belt - Fan & Alt.; W/65A., 70A. Alt.	9433915	②♠9550HD	Belt - Fan & V.P.	3883005	♠9690HD
Belt - Fan & Alt.; W/105A., 130A. Alt.	3887691	②♠9570HD	Belt - P.S.	9433884	♠9395HD
Belt - P.S.		♠9385HD	Belt - Air Brake Compr.	2027569	5700
Belt - Hyd. Brake Boost Pump; W/56 1/4" Belt O.C.	9433917	♠9560HD	Belt - Air Brake Compr. & A.P.		♠9720HD
Belt - Hyd. Brake Boost Pump; W/59 1/4" Belt O.C.	9433923	♠9590HD	Belt - Hyd. Brake Boost Pump	9433929	♠9620HD
Belt - Hyd. Brake Boost Pump & A.P.; W/65 1/4" Belt O.C.	9433935	♠9650HD	Belt - A.P.	9433881	♠9380HD
Belt - Hyd. Brake Boost Pump & A.P.; W/68 1/4" Belt O.C.	2027569	♠9680HD	Hose - Upper		≈20933
Belt - Air Brake Compr.	3888480	♠9560HD	Hose - Lower		21011
Belt - A.P.		♠9530HD	Hose - By Pass		24228
Hose - Upper		21095	GM V-8 350		
	or	25487	SE6000		

♠Standard Belt Available.
②Two Required.

≈Cut to Fit.
◆PowerBand Belt May Work, Use Template to Check.

Belts and Coolant Hose for School Buses

School Buses

Application	Mfr. Part No.	Our No.	Application	Mfr. Part No.	Our No.
GMC - Continued			GMC - Continued		
1976			1976 - Continued		
GM 6-Cyl. 292			GM V-8 366 - Continued		
SS6000			SE6000 - Continued		
Belt - Fan & Alt.; W/Std. Alt.	3887682	②♣9395HD	Hose - By Pass		24228
Belt - Fan & Alt.; W/80A. Alt.	3911543	②♣9412HD	GM V-8 427		
Belt - Fan & Alt.; W/100A. Alt.	690407	②♣9435HD	SE6000		
Belt - Fan, Alt. & P.S.; W/Std. Alt.	3947152	♣9500HD	Belt - Fan & Alt.; W/61A. Alt.; W/Single Belt .	690409	♣9510HD
Belt - Fan, Alt. & P.S.; W/80A. Alt.	3885457	♣9510HD	Belt - Fan & Alt.; W/61A. Alt.; W/Dual Belts .	3891365	②♣♠9610HD
Belt - Fan & A.P.	3947150	♣9530HD	Belt - Fan & Alt.; W/80A. Alt.		♣9560HD
Belt - P.S.	9433884	♣9395HD	Belt - Fan & Alt.; W/A.P.; W/100A., 105A.,		
Belt - Hyd. Brake Boost Pump	9433896	♣9455HD	130A. Alt.	9433921	♣9580HD
Belt - A.C.	3888403	7560	Belt - Fan & Alt.; W/O A.P.; W/100A.,		
Hose - Upper		≈20686	105A., 130A. Alt.	9433921	②♣9580HD
Hose - Lower		20489	Belt - Fan & P.S.	9433884	♣9560HD
		26611	Belt - Fan & A.P.	9433921	♣9580HD
	or	20563	Belt - P.S.	9433884	♣9395HD
Hose - By Pass		28442	Belt - Air Brake Compr.	3883005	♣9690HD
Hose - Heater Inlet		28441	Belt - Air Brake Compr. & A.P.		♣9720HD
Hose - Heater Outlet			Belt - Hyd. Brake Boost Pump		♣9630HD
GM V-8 307			Belt - A.P.	2459498	♣9370HD
SE6000			Hose - Upper		≈20933
Belt - Fan & Alt.; W/56 3/8" Belt O.C.		♣9560HD	Hose - Lower		21011
Belt - Fan & Alt.; W/58 3/8" Belt O.C.	3891359	♣9580HD	Hose - By Pass		24228
Belt - P.S.		♣9385HD	GM V-8 454		
Belt - Hyd. Brake Boost Pump	9433923	♣9590HD	SE6000		
Belt - Hyd. Brake Boost Pump & A.P.	2027569	♣9680HD	Belt - Fan & Alt.; W/61A. Alt.; W/Single Belt .	690409	♣9510HD
Belt - Air Brake Compr.		♣9640HD	Belt - Fan & Alt.; W/61A. Alt.; W/Dual Belts .	3891365	②♣♠9610HD
Belt - A.P.		♣9530HD	Belt - Fan & Alt.; W/80A. Alt.		♣9560HD
Hose - Upper		20607	Belt - Fan & Alt.; W/A.P.; W/100A., 105A.,		
	or	25484	130A. Alt.	9433921	♣9580HD
Hose - Lower; W/Hyd. Brakes		20558	Belt - Fan & Alt.; W/O A.P.; W/100A.,		
	or	26611	105A., 130A. Alt.	9433921	②♣9580HD
Hose - By Pass - Left Side		20565	Belt - Fan & P.S.	9433884	♣9560HD
Hose - By Pass - Right Side		20566	Belt - Fan & A.P.	9433921	♣9580HD
GM V-8 350			Belt - P.S.	9433884	♣9395HD
SE6000			Belt - Air Brake Compr.	3883005	♣9690HD
Belt - Fan & Alt.; W/56 3/8" Belt O.C.		♣9560HD	Belt - Air Brake Compr. & A.P.		♣9720HD
Belt - Fan & Alt.; W/58 3/8" Belt O.C.	3891359	♣9580HD	Belt - Hyd. Brake Boost Pump		♣9630HD
Belt - P.S.		♣9385HD	Belt - A.P.	2459498	♣9370HD
Belt - Hyd. Brake Boost Pump	9433923	♣9590HD	Hose - Upper		≈20933
Belt - Hyd. Brake Boost Pump & A.P.	2027569	♣9680HD	Hose - Lower		21011
Belt - Air Brake Compr.		♣9640HD	Hose - By Pass		24228
Belt - A.P.		♣9530HD	1975		
Hose - Upper		20607	GM 6-Cyl. 292		
	or	25484	SS6000		
Hose - Lower; W/Hyd. Brakes		20558	Belt - Fan & Alt.; W/Std. Alt.	3887682	②♣9395HD
	or	26611	Belt - Fan & Alt.; W/80A. Alt.	3911543	②♣9412HD
Hose - By Pass - Left Side		20565	Belt - Fan & Alt.; W/100A. Alt.	690407	②♣9435HD
Hose - By Pass - Right Side		20566	Belt - Fan, Alt. & P.S.; W/Std. Alt.	3947152	♣9500HD
GM V-8 366			Belt - Fan, Alt. & P.S.; W/80A. Alt.	3885457	♣9510HD
SE6000			Belt - Fan & A.P.	3947150	♣9530HD
Belt - Fan & Alt.; W/61A. Alt.; W/Single Belt .	690409	♣9510HD	Belt - P.S.	9433884	♣9395HD
Belt - Fan & Alt.; W/61A. Alt.; W/Dual Belts .	3891365	②♣♠9610HD	Belt - Hyd. Brake Boost Pump	9433896	♣9455HD
Belt - Fan & Alt.; W/80A. Alt.		♣9560HD	Belt - A.C.	3888403	7560
Belt - Fan & Alt.; W/A.P.; W/100A., 105A.,			Hose - Upper		≈20686
130A. Alt.	9433921	♣9580HD	Hose - Lower		20489
Belt - Fan & Alt.; W/O A.P.; W/100A.,				or	26611
105A., 130A. Alt.	9433921	②♣9580HD	Hose - By Pass		20563
Belt - Fan & P.S.	9433884	♣9560HD	Hose - Heater Inlet		28442
Belt - Fan & A.P.	9433921	♣9580HD	Hose - Heater Outlet		28441
Belt - P.S.	9433884	♣9395HD	GM V-8 307		
Belt - Air Brake Compr.	3883005	♣9690HD	SE6000		
Belt - Air Brake Compr. & A.P.		♣9720HD	Belt - Fan & Alt.; W/56 3/8" Belt O.C.		♣9560HD
Belt - Hyd. Brake Boost Pump		♣9630HD	Belt - Fan & Alt.; W/58 3/8" Belt O.C.	3891359	♣9580HD
Belt - A.P.	2459498	♣9370HD	Belt - P.S.		♣9385HD
Hose - Upper		≈20933			
Hose - Lower		21011			

♣Standard Belt Available.
≈Cut to Fit.

②Two Required.
◆PowerBand Belt May Work, Use Template to Check.

Belts and Coolant Hose for School Buses

Application	Mfr. Part No.	Our No.	Application	Mfr. Part No.	Our No.
GMC - Continued			GMC - Continued		
1975 - Continued			1975 - Continued		
GM V-8 307 - Continued			GM V-8 454		
SE6000 - Continued			SE6000		
Belt - Hyd. Brake Boost Pump	9433923	♠9590HD	Belt - Fan & Alt.; W/61A. Alt.; W/Single Belt .	690409	♠9510HD
Belt - Hyd. Brake Boost Pump & A.P.	2027569	♠9680HD	Belt - Fan & Alt.; W/61A. Alt.; W/Dual Belts .	3891365	②♠♠9610HD
Belt - Air Brake Compr.		♠9640HD	Belt - Fan & Alt.; W/80A. Alt.		♠9560HD
Belt - A.P.		♠9530HD	Belt - Fan & Alt.; W/A.P.; W/100A., 105A.,		
Hose - Upper		20607	130A. Alt.	9433921	♠9580HD
	or	25484	Belt - Fan & Alt.; W/O A.P.; W/100A.,		
Hose - Lower; W/Hyd. Brakes		20558	105A., 130A. Alt.	9433921	②♠9580HD
	or	26611	Belt - Fan & P.S.	9433884	♠9560HD
Hose - By Pass - Left Side		20565	Belt - Fan & A.P.	9433921	♠9580HD
Hose - By Pass - Right Side		20566	Belt - P.S.	9433884	♠9395HD
			Belt - Air Brake Compr.	3883005	♠9690HD
GM V-8 350			Belt - Air Brake Compr. & A.P.		♠9720HD
SE6000			Belt - Hyd. Brake Boost Pump		♠9630HD
Belt - Fan & Alt.; W/56 3/8" Belt O.C.		♠9560HD	Belt - A.P.	2459498	♠9370HD
Belt - Fan & Alt.; W/58 3/8" Belt O.C.	3891359	♠9580HD	Hose - Upper		≈<20933
Belt - P.S.		♠9385HD	Hose - Lower		21011
Belt - Hyd. Brake Boost Pump	9433923	♠9590HD	Hose - By Pass		24228
Belt - Hyd. Brake Boost Pump & A.P.	2027569	♠9680HD			
Belt - Air Brake Compr.		♠9640HD	GMC V-6 478 Diesel		
Belt - A.P.		♠9530HD	SG6000		
Hose - Upper		20607	Belt - Fan & Alt.	2483870	②♠♠9590HD
	or	25484	Belt - P.S.	3887676	♠9451HD
Hose - Lower; W/Hyd. Brakes		20558	Belt - Air Brake Compr.	3883002	♠9600HD
	or	26611	Belt - V.P.	3905091	♠9580HD
Hose - By Pass - Left Side		20565			
Hose - By Pass - Right Side		20566	1974		
			GM 6-Cyl. 292		
GM V-8 366			SS6000		
SE6000			Belt - Fan & Alt.; W/Std. Alt.	3887682	②♠9395HD
Belt - Fan & Alt.; W/61A. Alt.; W/Single Belt .	690409	♠9510HD	Belt - Fan & Alt.; W/80A. Alt.	3911543	②♠9412HD
Belt - Fan & Alt.; W/61A. Alt.; W/Dual Belts .	3891365	②♠♠9610HD	Belt - Fan & Alt.; W/100A. Alt.	690407	②♠9435HD
Belt - Fan & Alt.; W/80A. Alt.		♠9560HD	Belt - Fan, Alt. & P.S.; W/Std. Alt.	3947152	♠9500HD
Belt - Fan & Alt.; W/A.P.; W/100A., 105A.,			Belt - Fan, Alt. & P.S.; W/80A. Alt.	3885457	♠9510HD
130A. Alt.	9433921	♠9580HD	Belt - Fan & A.P.	3947150	♠9530HD
Belt - Fan & Alt.; W/O A.P.; W/100A.,			Belt - P.S.	9433884	♠9395HD
105A., 130A. Alt.	9433921	②♠9580HD	Belt - Hyd. Brake Boost Pump	9433896	♠9455HD
Belt - Fan & P.S.	9433884	♠9560HD	Belt - A.C.	3888403	7560
Belt - Fan & A.P.	9433921	♠9580HD	Hose - Upper		≈<20686
Belt - P.S.	9433884	♠9395HD	Hose - Lower		20489
Belt - Air Brake Compr.	3883005	♠9690HD		or	26611
Belt - Air Brake Compr. & A.P.		♠9720HD	Hose - By Pass		20563
Belt - Hyd. Brake Boost Pump		♠9630HD	Hose - Heater Inlet		28442
Belt - A.P.	2459498	♠9370HD	Hose - Heater Outlet		28441
Hose - Upper		≈<20933			
Hose - Lower		21011	GM V-6 401		
Hose - By Pass		24228	RM7500		
			Belt - W.P. & Alt.; W/60 1/4" Belt O.C.	2485210	②♠9600HD
GM V-8 427			Belt - W.P. & Alt.; W/61 1/4" Belt O.C.	3891365	②♠♠9610HD
SE6000			Belt - W.P. & Alt.; W/62 1/4" Belt O.C.	3888486	②♠9620HD
Belt - Fan & Alt.; W/61A. Alt.; W/Single Belt .	690409	♠9510HD	Belt - W.P. & Alt.; W/66 1/4" Belt O.C.	2479287	②♠♠9660HD
Belt - Fan & Alt.; W/61A. Alt.; W/Dual Belts .	3891365	②♠♠9610HD	Belt - W.P. & Alt.; W/67 1/4" Belt O.C.	2483914	②♠♠9670HD
Belt - Fan & Alt.; W/80A. Alt.		♠9560HD	Belt - P.S.; W/39 3/4" Belt O.C.	2477462	♠9395HD
Belt - Fan & Alt.; W/A.P.; W/100A., 105A.,			Belt - P.S.; W/40 3/4" Belt O.C.	3887674	♠9405HD
130A. Alt.	9433921	♠9580HD	Belt - Air Brake Compr.		♠9600HD
Belt - Fan & Alt.; W/O A.P.; W/100A.,			GM V-6 432		
105A., 130A. Alt.	9433921	②♠9580HD	RM7500		
Belt - Fan & P.S.	9433884	♠9560HD	Belt - W.P. & Alt.; W/60 1/4" Belt O.C.	2485210	②♠9600HD
Belt - Fan & A.P.	9433921	♠9580HD	Belt - W.P. & Alt.; W/61 1/4" Belt O.C.	3891365	②♠♠9610HD
Belt - P.S.	9433884	♠9395HD	Belt - W.P. & Alt.; W/62 1/4" Belt O.C.	3888486	②♠9620HD
Belt - Air Brake Compr.	3883005	♠9690HD	Belt - W.P. & Alt.; W/66 1/4" Belt O.C.	2479287	②♠♠9660HD
Belt - Air Brake Compr. & A.P.		♠9720HD	Belt - W.P. & Alt.; W/67 1/4" Belt O.C.	2483914	②♠♠9670HD
Belt - Hyd. Brake Boost Pump		♠9630HD	Belt - P.S.; W/39 3/4" Belt O.C.	2477462	♠9395HD
Belt - A.P.	2459498	♠9370HD	Belt - P.S.; W/40 3/4" Belt O.C.	3887674	♠9405HD
Hose - Upper		≈<20933	Belt - Air Brake Compr.		♠9600HD
Hose - Lower		21011			
Hose - By Pass		24228			

♠Standard Belt Available.
②Two Required.

♠PowerBand Belt May Work, Use Template to Check.
≈<Cut to Fit.

Belts and Coolant Hose for School Buses

Application	Mfr. Part No.	Our No.	Application	Mfr. Part No.	Our No.
GMC - Continued			GMC - Continued		
1974 - Continued			1974 - Continued		
GM V-6 478			GM V-8 427 - Continued		
RM7500			SE6000 - Continued		
Belt - W.P. & Alt.; W/60 1/4" Belt O.C.	2485210	②♣9600HD	Belt - Fan & P.S.	9433884	♣9560HD
Belt - W.P. & Alt.; W/61 1/4" Belt O.C.	3891365	②♣♠9610HD	Belt - Fan & A.P.	9433921	♣9580HD
Belt - W.P. & Alt.; W/62 1/4" Belt O.C.	3888486	②♣9620HD	Belt - P.S.	9433884	♣9395HD
Belt - W.P. & Alt.; W/66 1/4" Belt O.C.	2479287	②♣♠9660HD	Belt - Air Brake Compr.	3883005	♣9690HD
Belt - W.P. & Alt.; W/67 1/4" Belt O.C.	2483914	②♣♠9670HD	Belt - Air Brake Compr. & A.P.		♣9720HD
Belt - P.S.; W/39 3/4" Belt O.C.	2477462	♣9395HD	Belt - Hyd. Brake Boost Pump		♣9630HD
Belt - P.S.; W/40 3/4" Belt O.C.	3887674	♣9405HD	Belt - A.P.	2459498	♣9370HD
Belt - Air Brake Compr.		♣9600HD			
GM V-8 307			GM V-8 454		
SE6000			SE6000		
Belt - Fan & Alt.; W/56 3/8" Belt O.C.		♣9560HD	Belt - Fan & Alt.; W/61A. Alt.; W/Single Belt .690409		♣9510HD
Belt - Fan & Alt.; W/58 3/8" Belt O.C.	3891359	♣9580HD	Belt - Fan & Alt.; W/61A. Alt.; W/Dual Belts .3891365		②♣♠9610HD
Belt - P.S.		♣9385HD	Belt - Fan & Alt.; W/80A. Alt.		♣9560HD
Belt - Hyd. Brake Boost Pump	9433923	♣9590HD	Belt - Fan & Alt.; W/A.P.; W/100A., 105A., 130A. Alt.	9433921	♣9580HD
Belt - Hyd. Brake Boost Pump & A.P.	2027569	♣9680HD	Belt - Fan & Alt.; W/O A.P.; W/100A., 105A., 130A. Alt.	9433921	②♣9580HD
Belt - Air Brake Compr.		♣9640HD	Belt - Fan & P.S.	9433884	♣9560HD
Belt - A.P.		♣9530HD	Belt - Fan & A.P.	9433921	♣9580HD
Hose - Upper		20607	Belt - P.S.	9433884	♣9395HD
	or	25484	Belt - Air Brake Compr.	3883005	♣9690HD
Hose - Lower; W/Hyd. Brakes		20558	Belt - Air Brake Compr. & A.P.		♣9720HD
	or	26611	Belt - Hyd. Brake Boost Pump		♣9630HD
Hose - By Pass - Left Side		20565	Belt - A.P.	2459498	♣9370HD
Hose - By Pass - Right Side		20566			
GM V-8 350			GMC V-6 478 Diesel		
SE6000			SG6000		
Belt - Fan & Alt.; W/56 3/8" Belt O.C.		♣9560HD	Belt - Fan & Alt.	2483870	②♣♠9590HD
Belt - Fan & Alt.; W/58 3/8" Belt O.C.	3891359	♣9580HD	Belt - P.S.	3887676	♣9451HD
Belt - P.S.		♣9385HD	Belt - Air Brake Compr.	3883002	♣9600HD
Belt - Hyd. Brake Boost Pump	9433923	♣9590HD	Belt - V.P.	3905091	♣9580HD
Belt - Hyd. Brake Boost Pump & A.P.	2027569	♣9680HD	Hose - Upper		26611
Belt - Air Brake Compr.		♣9640HD			
Belt - A.P.		♣9530HD			
Hose - Upper		20607			
	or	25484			
Hose - Lower; W/Hyd. Brakes		20558			
	or	26611			
Hose - By Pass - Left Side		20565			
Hose - By Pass - Right Side		20566			
GM V-8 366			1973		
SE6000			GM 6-Cyl. 292		
Belt - Fan & Alt.; W/61A. Alt.; W/Single Belt .690409		♣9510HD	SS6000		
Belt - Fan & Alt.; W/61A. Alt.; W/Dual Belts .3891365		②♣♠9610HD	Belt - Fan & Alt.; W/Std. Alt.	3887682	②♣9395HD
Belt - Fan & Alt.; W/80A. Alt.		♣9560HD	Belt - Fan & Alt.; W/80A. Alt.	3911543	②♣9412HD
Belt - Fan & Alt.; W/A.P.; W/100A., 105A., 130A. Alt.	9433921	♣9580HD	Belt - Fan & Alt.; W/100A. Alt.	690407	②♣9435HD
Belt - Fan & Alt.; W/O A.P.; W/100A., 105A., 130A. Alt.	9433921	②♣9580HD	Belt - Fan, Alt. & P.S.; W/Std. Alt.	3947152	♣9500HD
Belt - Fan & P.S.	9433884	♣9560HD	Belt - Fan, Alt. & P.S.; W/80A. Alt.	3885457	♣9510HD
Belt - Fan & A.P.	9433921	♣9580HD	Belt - Fan & A.P.	3947150	♣9530HD
Belt - P.S.	9433884	♣9395HD	Belt - P.S.	9433884	♣9395HD
Belt - Air Brake Compr.	3883005	♣9690HD	Belt - Hyd. Brake Boost Pump	9433896	♣9455HD
Belt - Air Brake Compr. & A.P.		♣9720HD	Belt - A.C.	3888403	7560
Belt - Hyd. Brake Boost Pump		♣9630HD	Hose - Upper		≅20686
Belt - A.P.	2459498	♣9370HD	Hose - Lower		20489
				or	26611
			Hose - By Pass		20563
			Hose - Heater Inlet		28442
			Hose - Heater Outlet		28441
GM V-8 427			GM V-6 401		
SE6000			RM7500		
Belt - Fan & Alt.; W/61A. Alt.; W/Single Belt .690409		♣9510HD	Belt - W.P. & Alt.; W/60 1/4" Belt O.C.	2485210	②♣9600HD
Belt - Fan & Alt.; W/61A. Alt.; W/Dual Belts .3891365		②♣♠9610HD	Belt - W.P. & Alt.; W/61 1/4" Belt O.C.	3891365	②♣♠9610HD
Belt - Fan & Alt.; W/80A. Alt.		♣9560HD	Belt - W.P. & Alt.; W/62 1/4" Belt O.C.	3888486	②♣9620HD
Belt - Fan & Alt.; W/A.P.; W/100A., 105A., 130A. Alt.	9433921	♣9580HD	Belt - W.P. & Alt.; W/66 1/4" Belt O.C.	2479287	②♣♠9660HD
Belt - Fan & Alt.; W/O A.P.; W/100A., 105A., 130A. Alt.	9433921	②♣9580HD	Belt - W.P. & Alt.; W/67 1/4" Belt O.C.	2483914	②♣♠9670HD
Belt - Fan & P.S.	9433884	♣9560HD	Belt - P.S.; W/39 3/4" Belt O.C.	2477462	♣9395HD
Belt - Fan & A.P.	9433921	♣9580HD	Belt - P.S.; W/40 3/4" Belt O.C.	3887674	♣9405HD
Belt - P.S.	9433884	♣9395HD	Belt - Air Brake Compr.		♣9600HD
Belt - Air Brake Compr.	3883005	♣9690HD	Hose - Upper - Eng. To Pipe		23531
Belt - Air Brake Compr. & A.P.		♣9720HD	Hose - Upper - Pipe To Rad.		24232
Belt - Hyd. Brake Boost Pump		♣9630HD	Hose - Lower - Eng. To Pipe		24240
Belt - A.P.	2459498	♣9370HD	Hose - Lower - Pipe To Rad.		24236

♣Standard Belt Available.
②Two Required.

♠PowerBand Belt May Work, Use Template to Check.
≅Cut to Fit.

Belts and Coolant Hose for School Buses

Application	Mfr. Part No.	Our No.	Application	Mfr. Part No.	Our No.
GMC - Continued			GMC - Continued		
1973 - Continued			1973 - Continued		
GM V-6 432			GM V-8 366 - Continued		
RM7500			SE6000 - Continued		
Belt - W.P. & Alt.; W/60 1/4" Belt O.C.	2485210	②♣9600HD	Belt - Fan & Alt.; W/O A.P.; W/100A., 105A., 130A. Alt.	9433921	②♣9580HD
Belt - W.P. & Alt.; W/61 1/4" Belt O.C.	3891365	②♣9610HD	Belt - Fan & P.S.	9433884	♣9560HD
Belt - W.P. & Alt.; W/62 1/4" Belt O.C.	3888486	②♣9620HD	Belt - Fan & A.P.	9433921	♣9580HD
Belt - W.P. & Alt.; W/66 1/4" Belt O.C.	2479287	②♣9660HD	Belt - P.S.	9433884	♣9395HD
Belt - W.P. & Alt.; W/67 1/4" Belt O.C.	2483914	②♣9670HD	Belt - Air Brake Compr.	3883005	♣9690HD
Belt - P.S.; W/39 3/4" Belt O.C.	2477462	♣9395HD	Belt - Air Brake Compr. & A.P.		♣9720HD
Belt - P.S.; W/40 3/4" Belt O.C.	3887674	♣9405HD	Belt - Hyd. Brake Boost Pump		♣9630HD
Belt - Air Brake Compr.		♣9600HD	Belt - A.P.	2459498	♣9370HD
Hose - Upper - Eng. To Pipe		23531			
Hose - Upper - Pipe To Rad.		24232			
Hose - Lower - Eng. To Pipe		24240			
Hose - Lower - Pipe To Rad.		24236			
GM V-6 478			GM V-8 427		
RM7500			SE6000		
Belt - W.P. & Alt.; W/60 1/4" Belt O.C.	2485210	②♣9600HD	Belt - Fan & Alt.; W/61A. Alt.; W/Single Belt .690409		♣9510HD
Belt - W.P. & Alt.; W/61 1/4" Belt O.C.	3891365	②♣9610HD	Belt - Fan & Alt.; W/61A. Alt.; W/Dual Belts .3891365		②♣9610HD
Belt - W.P. & Alt.; W/62 1/4" Belt O.C.	3888486	②♣9620HD	Belt - Fan & Alt.; W/80A. Alt.		♣9560HD
Belt - W.P. & Alt.; W/66 1/4" Belt O.C.	2479287	②♣9660HD	Belt - Fan & Alt.; W/A.P.; W/100A., 105A., 130A. Alt.	9433921	♣9580HD
Belt - W.P. & Alt.; W/67 1/4" Belt O.C.	2483914	②♣9670HD	Belt - Fan & Alt.; W/O A.P.; W/100A., 105A., 130A. Alt.	9433921	②♣9580HD
Belt - P.S.; W/39 3/4" Belt O.C.	2477462	♣9395HD	Belt - Fan & P.S.	9433884	♣9560HD
Belt - P.S.; W/40 3/4" Belt O.C.	3887674	♣9405HD	Belt - Fan & A.P.	9433921	♣9580HD
Belt - Air Brake Compr.		♣9600HD	Belt - P.S.	9433884	♣9395HD
Hose - Upper - Eng. To Pipe		23531	Belt - Air Brake Compr.	3883005	♣9690HD
Hose - Upper - Pipe To Rad.		24232	Belt - Air Brake Compr. & A.P.		♣9720HD
Hose - Lower - Eng. To Pipe		24240	Belt - Hyd. Brake Boost Pump		♣9630HD
Hose - Lower - Pipe To Rad.		24236	Belt - A.P.	2459498	♣9370HD
GM V-8 307			GM V-8 454		
SE6000			SE6000		
Belt - Fan & Alt.; W/56 3/8" Belt O.C.		♣9560HD	Belt - Fan & Alt.; W/61A. Alt.; W/Single Belt .690409		♣9510HD
Belt - Fan & Alt.; W/58 3/8" Belt O.C.	3891359	♣9580HD	Belt - Fan & Alt.; W/61A. Alt.; W/Dual Belts .3891365		②♣9610HD
Belt - P.S.		♣9385HD	Belt - Fan & Alt.; W/80A. Alt.		♣9560HD
Belt - Hyd. Brake Boost Pump	9433923	♣9590HD	Belt - Fan & Alt.; W/A.P.; W/100A., 105A., 130A. Alt.	9433921	♣9580HD
Belt - Hyd. Brake Boost Pump & A.P.	2027569	♣9680HD	Belt - Fan & Alt.; W/O A.P.; W/100A., 105A., 130A. Alt.	9433921	②♣9580HD
Belt - Air Brake Compr.		♣9640HD	Belt - Fan & P.S.	9433884	♣9560HD
Belt - A.P.		♣9530HD	Belt - Fan & A.P.	9433921	♣9580HD
Hose - Upper		20607	Belt - P.S.	9433884	♣9395HD
	or	25484	Belt - Air Brake Compr.	3883005	♣9690HD
Hose - Lower; W/Hyd. Brakes		20558	Belt - Air Brake Compr. & A.P.		♣9720HD
	or	26611	Belt - Hyd. Brake Boost Pump		♣9630HD
Hose - By Pass - Left Side		20565	Belt - A.P.	2459498	♣9370HD
Hose - By Pass - Right Side		20566			
GM V-8 350			GMC V-6 478 Diesel		
SE6000			SG6000		
Belt - Fan & Alt.; W/56 3/8" Belt O.C.		♣9560HD	Belt - Fan & Alt.	2483870	②♣9590HD
Belt - Fan & Alt.; W/58 3/8" Belt O.C.	3891359	♣9580HD	Belt - P.S.	3887676	♣9451HD
Belt - P.S.		♣9385HD	Belt - Air Brake Compr.	3883002	♣9600HD
Belt - Hyd. Brake Boost Pump	9433923	♣9590HD	Belt - V.P.	3905091	♣9580HD
Belt - Hyd. Brake Boost Pump & A.P.	2027569	♣9680HD	Hose - Upper		26611
Belt - Air Brake Compr.		♣9640HD			
Belt - A.P.		♣9530HD			
Hose - Upper		20607			
	or	25484			
Hose - Lower; W/Hyd. Brakes		20558			
	or	26611			
Hose - By Pass - Left Side		20565			
Hose - By Pass - Right Side		20566			
GM V-8 366			1972 - 1971		
SE6000			GM 6-Cyl. 292		
Belt - Fan & Alt.; W/61A. Alt.; W/Single Belt .690409		♣9510HD	SS5500		
Belt - Fan & Alt.; W/61A. Alt.; W/Dual Belts .3891365		②♣9610HD	Belt - Fan & Alt.	3887682	♣9395HD
Belt - Fan & Alt.; W/80A. Alt.		♣9560HD	Belt - Fan, Alt. & P.S.	3947152	♣9500HD
Belt - Fan & Alt.; W/A.P.; W/100A., 105A., 130A. Alt.	9433921	♣9580HD	Belt - Fan & Air Brake Compr.	3943162	♣9660HD
			Hose - Upper		≈20686
			Hose - Lower		20489
				or	26611
			Hose - By Pass		20563
			Hose - Heater Inlet		28442
			Hose - Heater Outlet		28441

♣Standard Belt Available.
②Two Required.

◆PowerBand Belt May Work, Use Template to Check.
≈Cut to Fit.

Belts and Coolant Hose for School Buses

Application	Mfr. Part No.	Our No.	Application	Mfr. Part No.	Our No.
GMC - Continued			GMC - Continued		
1972 - 1971 - Continued			1972 - 1971 - Continued		
GM V-6 305			GM V-6 379 - Continued		
RM7500			SM5500 - Continued		
Belt - W.P. & Alt.; W/61A. Alt.; W/Single Belt	2485210	♣9600HD	Belt - Air Brake Compr.	3883002	♣9605HD
Belt - W.P. & Alt.; W/61A. Alt.; W/Dual Belts	3891365	♣9610HD	Hose - Upper; W/A.P.		20761
Belt - W.P. & Alt.; W/130A. Alt.	2483914	♣9670HD	GM V-6 401		
Belt - P.S.	2477462	♣9395HD	RM7500		
Belt - Air Brake Compr.		♣9650HD	Belt - W.P. & Alt.; W/60 1/4" Belt O.C.	2485210	②♣9600HD
Hose - Upper - Eng. To Pipe		23531	Belt - W.P. & Alt.; W/61 1/4" Belt O.C.	3891365	②♣♣9610HD
Hose - Upper - Pipe To Rad.		24232	Belt - W.P. & Alt.; W/62 1/4" Belt O.C.	3888486	②♣9620HD
Hose - Lower - Eng. To Pipe		24240	Belt - W.P. & Alt.; W/66 1/4" Belt O.C.	2479287	②♣♣9660HD
Hose - Lower - Pipe To Rad.		24236	Belt - W.P. & Alt.; W/67 1/4" Belt O.C.	2483914	②♣♣9670HD
SM5500			Belt - P.S.; W/39 3/4" Belt O.C.	2477462	♣9395HD
Belt - Fan & Alt.; W/61A. Alt.		②♣♣9590HD	Belt - P.S.; W/40 3/4" Belt O.C.	3887674	♣9405HD
Belt - Fan & Alt.; W/Air Brakes; W/105A. Alt.	2483932	②♣♣9660HD	Belt - Air Brake Compr.		♣9600HD
Belt - Fan & Alt.; W/Hyd. Brakes; W/105A. Alt.	8876092	②♣♣9650HD	Hose - Upper - Eng. To Pipe		23531
Belt - P.S.; W/Air Brakes	8867788	♣9420HD	Hose - Upper - Pipe To Rad.		24232
Belt - P.S.; W/Hyd. Brakes	2459789	♣9476HD	Hose - Lower - Eng. To Pipe		24240
Belt - Air Brake Compr.	3883002	♣9605HD	Hose - Lower - Pipe To Rad.		24236
Hose - Upper; W/A.P.		20761	GM V-6 432		
GM V-6 351			RM7500		
RM7500			Belt - W.P. & Alt.; W/60 1/4" Belt O.C.	2485210	②♣9600HD
Belt - W.P. & Alt.; W/61A. Alt.; W/Single Belt	2485210	♣9600HD	Belt - W.P. & Alt.; W/61 1/4" Belt O.C.	3891365	②♣♣9610HD
Belt - W.P. & Alt.; W/61A. Alt.; W/Dual Belts	3891365	♣9610HD	Belt - W.P. & Alt.; W/62 1/4" Belt O.C.	3888486	②♣9620HD
Belt - W.P. & Alt.; W/130A. Alt.	2483914	♣9670HD	Belt - W.P. & Alt.; W/66 1/4" Belt O.C.	2479287	②♣♣9660HD
Belt - P.S.	2477462	♣9395HD	Belt - W.P. & Alt.; W/67 1/4" Belt O.C.	2483914	②♣♣9670HD
Belt - Air Brake Compr.		♣9650HD	Belt - P.S.; W/39 3/4" Belt O.C.	2477462	♣9395HD
Hose - Upper - Eng. To Pipe		23531	Belt - P.S.; W/40 3/4" Belt O.C.	3887674	♣9405HD
Hose - Upper - Pipe To Rad.		24232	Belt - Air Brake Compr.		♣9600HD
Hose - Lower - Eng. To Pipe		24240	Hose - Upper - Eng. To Pipe		23531
Hose - Lower - Pipe To Rad.		24236	Hose - Upper - Pipe To Rad.		24232
SM5500			Hose - Lower - Eng. To Pipe		24240
Belt - Fan & Alt.; W/61A. Alt.		②♣♣9590HD	Hose - Lower - Pipe To Rad.		24236
Belt - Fan & Alt.; W/Air Brakes; W/105A. Alt.	2483932	②♣♣9660HD	GM V-6 478		
Belt - Fan & Alt.; W/Hyd. Brakes; W/105A. Alt.	8876092	②♣♣9650HD	RM7500		
Belt - P.S.; W/Air Brakes	8867788	♣9420HD	Belt - W.P. & Alt.; W/60 1/4" Belt O.C.	2485210	②♣9600HD
Belt - P.S.; W/Hyd. Brakes	2459789	♣9476HD	Belt - W.P. & Alt.; W/61 1/4" Belt O.C.	3891365	②♣♣9610HD
Belt - Air Brake Compr.	3883002	♣9605HD	Belt - W.P. & Alt.; W/62 1/4" Belt O.C.	3888486	②♣9620HD
Hose - Upper; W/A.P.		20761	Belt - W.P. & Alt.; W/66 1/4" Belt O.C.	2479287	②♣♣9660HD
GM V-6 379			Belt - W.P. & Alt.; W/67 1/4" Belt O.C.	2483914	②♣♣9670HD
RM7500			Belt - P.S.; W/39 3/4" Belt O.C.	2477462	♣9395HD
Belt - W.P. & Alt.; W/61A. Alt.; W/Single Belt	2485210	♣9600HD	Belt - P.S.; W/40 3/4" Belt O.C.	3887674	♣9405HD
Belt - W.P. & Alt.; W/61A. Alt.; W/Dual Belts	3891365	♣9610HD	Belt - Air Brake Compr.		♣9600HD
Belt - W.P. & Alt.; W/130A. Alt.	2483914	♣9670HD	Hose - Upper - Eng. To Pipe		23531
Belt - P.S.	2477462	♣9395HD	Hose - Upper - Pipe To Rad.		24232
Belt - Air Brake Compr.		♣9650HD	Hose - Lower - Eng. To Pipe		24240
Hose - Upper - Eng. To Pipe		23531	Hose - Lower - Pipe To Rad.		24236
Hose - Upper - Pipe To Rad.		24232	GM V-8 307		
Hose - Lower - Eng. To Pipe		24240	SE5500		
Hose - Lower - Pipe To Rad.		24236	Belt - Fan & Alt.	3888480	②♣9560HD
SM5500			Belt - Fan & A.P.	3906417	♣9520HD
Belt - Fan & Alt.; W/61A. Alt.		②♣♣9590HD	Belt - P.S.	3888401	♣9412HD
Belt - Fan & Alt.; W/Air Brakes; W/105A. Alt.	2483932	②♣♣9660HD	Hose - Upper		20607
Belt - Fan & Alt.; W/Hyd. Brakes; W/105A. Alt.	8876092	②♣♣9650HD			or
Belt - P.S.; W/Air Brakes	8867788	♣9420HD	Hose - Lower; W/Hyd. Brakes		25484
Belt - P.S.; W/Hyd. Brakes	2459789	♣9476HD			20558
GM V-6 379					or
RM7500			Hose - By Pass - Left Side		26611
Belt - W.P. & Alt.; W/61A. Alt.; W/Single Belt	2485210	♣9600HD	Hose - By Pass - Right Side		20565
Belt - W.P. & Alt.; W/61A. Alt.; W/Dual Belts	3891365	♣9610HD			20566
Belt - W.P. & Alt.; W/130A. Alt.	2483914	♣9670HD	GM V-8 350		
Belt - P.S.	2477462	♣9395HD	SE5500		
Belt - Air Brake Compr.		♣9650HD	Belt - Fan & Alt.	3888480	②♣9560HD
Hose - Upper - Eng. To Pipe		23531	Belt - Fan & A.P.	3906417	♣9520HD
Hose - Upper - Pipe To Rad.		24232	Belt - P.S.	3888401	♣9412HD
Hose - Lower - Eng. To Pipe		24240	Hose - Upper		20607
Hose - Lower - Pipe To Rad.		24236			or
SM5500			Hose - Lower; W/Hyd. Brakes		25484
Belt - Fan & Alt.; W/61A. Alt.		②♣♣9590HD			20558
Belt - Fan & Alt.; W/Air Brakes; W/105A. Alt.	2483932	②♣♣9660HD			or
Belt - Fan & Alt.; W/Hyd. Brakes; W/105A. Alt.	8876092	②♣♣9650HD	Hose - By Pass - Left Side		26611
Belt - P.S.; W/Air Brakes	8867788	♣9420HD	Hose - By Pass - Right Side		20565
Belt - P.S.; W/Hyd. Brakes	2459789	♣9476HD			20566

♣Standard Belt Available.
②Two Required.

◆PowerBand Belt May Work, Use Template to Check.

Belts and Coolant Hose for School Buses

Application	Mfr. Part No.	Our No.	Application	Mfr. Part No.	Our No.
GMC - Continued			GMC - Continued		
1972 - 1971 - Continued			1970 - Continued		
GM V-8 350 - Continued			GM V-6 351 - Continued		
SE5500 - Continued			SM5500 - Continued		
Hose - Lower; W/Hyd. Brakes		20558	Belt - Fan & Alt.; W/Air Brakes; W/105A.		
	or	26611	Alt.	2483932	②♠◆9660HD
Hose - By Pass - Left Side		20565	Belt - Fan & Alt.; W/Hyd. Brakes; W/105A.		
Hose - By Pass - Right Side		20566	Alt.	8876092	②♠◆9650HD
GMC V-6 478 Diesel			Belt - P.S.; W/Air Brakes	8867788	♠9420HD
SG5500			Belt - P.S.; W/Hyd. Brakes	2459789	♠9476HD
Belt - Fan & Alt.; W/62A. Alt.	2439805	②♠◆9580HD	Belt - Air Brake Compr.	3883002	♠9605HD
Belt - Fan & Alt.; W/105A., 130A. Alt.	8867641	②♠◆9670HD	Hose - Upper; W/A.P.		20761
Belt - P.S.	3887676	♠9451HD	GM V-6 379		
Belt - Air Brake Compr.	3883002	♠9600HD	RM7500		
Belt - V.P.	8867790	♠9580HD	Belt - W.P. & Alt.; W/61A. Alt.; W/Single		
Hose - Upper		26611	Belt	2485210	♠9600HD
1970			Belt - W.P. & Alt.; W/61A. Alt.; W/Dual		
GM 6-Cyl. 292			Belts	3891365	♠9610HD
SS5500			Belt - W.P. & Alt.; W/130A. Alt.	2483914	♠9670HD
Belt - Fan & Alt.	3887682	♠9395HD	Belt - P.S.	2477462	♠9395HD
Belt - Fan, Alt. & P.S.	3947152	♠9500HD	Belt - Air Brake Compr.		♠9650HD
Belt - Fan & Air Brake Compr.	3943162	♠9660HD	Hose - Upper - Eng. To Pipe		23531
Hose - Upper		≡20686	Hose - Upper - Pipe To Rad.		24232
Hose - Lower		20489	Hose - Lower - Eng. To Pipe		24240
	or	26611	Hose - Lower - Pipe To Rad.		24236
Hose - By Pass		20563	SM5500		
Hose - Heater Inlet		28442	Belt - Fan & Alt.; W/61A. Alt.		②♠◆9590HD
Hose - Heater Outlet		28441	Belt - Fan & Alt.; W/Air Brakes; W/105A.		
GM V-6 305			Alt.	2483932	②♠◆9660HD
RM7500			Belt - Fan & Alt.; W/Hyd. Brakes; W/105A.		
Belt - W.P. & Alt.; W/61A. Alt.; W/Single			Alt.	8876092	②♠◆9650HD
Belt	2485210	♠9600HD	Belt - P.S.; W/Air Brakes	8867788	♠9420HD
Belt - W.P. & Alt.; W/61A. Alt.; W/Dual			Belt - P.S.; W/Hyd. Brakes	2459789	♠9476HD
Belts	3891365	♠9610HD	Belt - Air Brake Compr.	3883002	♠9605HD
Belt - W.P. & Alt.; W/130A. Alt.	2483914	♠9670HD	Hose - Upper; W/A.P.		20761
Belt - P.S.	2477462	♠9395HD	GM V-6 401		
Belt - Air Brake Compr.		♠9650HD	RM7500		
Hose - Upper - Eng. To Pipe		23531	Belt - W.P. & Alt.; W/60 1/4" Belt O.C.	2485210	②♠9600HD
Hose - Upper - Pipe To Rad.		24232	Belt - W.P. & Alt.; W/61 1/4" Belt O.C.	3891365	②♠◆9610HD
Hose - Lower - Eng. To Pipe		24240	Belt - W.P. & Alt.; W/62 1/4" Belt O.C.	3888486	②♠9620HD
Hose - Lower - Pipe To Rad.		24236	Belt - W.P. & Alt.; W/66 1/4" Belt O.C.	2479287	②♠◆9660HD
SM5500			Belt - W.P. & Alt.; W/67 1/4" Belt O.C.	2483914	②♠◆9670HD
Belt - Fan & Alt.; W/61A. Alt.		②♠◆9590HD	Belt - P.S.; W/39 3/4" Belt O.C.	2477462	♠9395HD
Belt - Fan & Alt.; W/Air Brakes; W/105A.			Belt - P.S.; W/40 3/4" Belt O.C.	3887674	♠9405HD
Alt.	2483932	②♠◆9660HD	Belt - Air Brake Compr.		♠9600HD
Belt - Fan & Alt.; W/Hyd. Brakes; W/105A.			Hose - Upper - Eng. To Pipe		23531
Alt.	8876092	②♠◆9650HD	Hose - Upper - Pipe To Rad.		24232
Belt - P.S.; W/Air Brakes	8867788	♠9420HD	Hose - Lower - Eng. To Pipe		24240
Belt - P.S.; W/Hyd. Brakes	2459789	♠9476HD	Hose - Lower - Pipe To Rad.		24236
Belt - Air Brake Compr.	3883002	♠9605HD	GM V-6 432		
Hose - Upper; W/A.P.		20761	RM7500		
GM V-6 351			Belt - W.P. & Alt.; W/60 1/4" Belt O.C.	2485210	②♠9600HD
RM7500			Belt - W.P. & Alt.; W/61 1/4" Belt O.C.	3891365	②♠◆9610HD
Belt - W.P. & Alt.; W/61A. Alt.; W/Single			Belt - W.P. & Alt.; W/62 1/4" Belt O.C.	3888486	②♠9620HD
Belt	2485210	♠9600HD	Belt - W.P. & Alt.; W/66 1/4" Belt O.C.	2479287	②♠◆9660HD
Belt - W.P. & Alt.; W/61A. Alt.; W/Dual			Belt - W.P. & Alt.; W/67 1/4" Belt O.C.	2483914	②♠◆9670HD
Belts	3891365	♠9610HD	Belt - P.S.; W/39 3/4" Belt O.C.	2477462	♠9395HD
Belt - W.P. & Alt.; W/130A. Alt.	2483914	♠9670HD	Belt - P.S.; W/40 3/4" Belt O.C.	3887674	♠9405HD
Belt - P.S.	2477462	♠9395HD	Belt - Air Brake Compr.		♠9600HD
Belt - Air Brake Compr.		♠9650HD	Hose - Upper - Eng. To Pipe		23531
Hose - Upper - Eng. To Pipe		23531	Hose - Upper - Pipe To Rad.		24232
Hose - Upper - Pipe To Rad.		24232	Hose - Lower - Eng. To Pipe		24240
Hose - Lower - Eng. To Pipe		24240	Hose - Lower - Pipe To Rad.		24236
Hose - Lower - Pipe To Rad.		24236	GM V-6 478		
SM5500			RM7500		
Belt - Fan & Alt.; W/61A. Alt.		②♠◆9590HD	Belt - W.P. & Alt.; W/60 1/4" Belt O.C.	2485210	②♠9600HD
GM V-6 351			Belt - W.P. & Alt.; W/61 1/4" Belt O.C.	3891365	②♠◆9610HD
RM7500			Belt - W.P. & Alt.; W/62 1/4" Belt O.C.	3888486	②♠9620HD
Belt - W.P. & Alt.; W/61A. Alt.; W/Single			Belt - W.P. & Alt.; W/66 1/4" Belt O.C.	2479287	②♠◆9660HD
Belt	2485210	♠9600HD	Belt - W.P. & Alt.; W/67 1/4" Belt O.C.	2483914	②♠◆9670HD
Belt - W.P. & Alt.; W/61A. Alt.; W/Dual			Belt - P.S.; W/39 3/4" Belt O.C.	2477462	♠9395HD
Belts	3891365	♠9610HD	Belt - P.S.; W/40 3/4" Belt O.C.	3887674	♠9405HD
Belt - W.P. & Alt.; W/130A. Alt.	2483914	♠9670HD	Belt - Air Brake Compr.		♠9600HD
Belt - P.S.	2477462	♠9395HD	Hose - Upper - Eng. To Pipe		23531
Belt - Air Brake Compr.		♠9650HD	Hose - Upper - Pipe To Rad.		24232
Hose - Upper - Eng. To Pipe		23531	Hose - Lower - Eng. To Pipe		24240
Hose - Upper - Pipe To Rad.		24232	Hose - Lower - Pipe To Rad.		24236
Hose - Lower - Eng. To Pipe		24240	GM V-6 478		
Hose - Lower - Pipe To Rad.		24236	RM7500		
SM5500			Belt - W.P. & Alt.; W/60 1/4" Belt O.C.	2485210	②♠9600HD
Belt - Fan & Alt.; W/61A. Alt.		②♠◆9590HD	Belt - W.P. & Alt.; W/61 1/4" Belt O.C.	3891365	②♠◆9610HD

♠Standard Belt Available.
◆PowerBand Belt May Work, Use Template to Check.

②Two Required.
≡Cut to Fit.

School Buses

Belts and Coolant Hose for School Buses

School Buses

Application	Mfr. Part No.	Our No.	Application	Mfr. Part No.	Our No.
GMC - Continued			GMC - Continued		
1970 - Continued			1969 - 1968 - Continued		
GM V-6 478 - Continued			GM V-6 305 - Continued		
RM7500 - Continued			RM7500 - Continued		
Belt - W.P. & Alt.; W/62 1/4" Belt O.C.	3888486	②♣9620HD	Hose - Upper - Pipe To Rad.		24232
Belt - W.P. & Alt.; W/66 1/4" Belt O.C.	2479287	②♣♠9660HD	Hose - Lower - Eng. To Pipe		24240
Belt - W.P. & Alt.; W/67 1/4" Belt O.C.	2483914	②♣♠9670HD	Hose - Lower - Pipe To Rad.		24236
Belt - P.S.; W/39 3/4" Belt O.C.	2477462	♠9395HD	SM5500		
Belt - P.S.; W/40 3/4" Belt O.C.	3887674	♠9405HD	Belt - Fan & Alt.; W/61A. Alt.	②♣♠9590HD	
Belt - Air Brake Compr.		♠9600HD	Belt - Fan & Alt.; W/Air Brakes; W/105A. Alt.	2483932	②♣♠9660HD
Hose - Upper - Eng. To Pipe		23531	Belt - Fan & Alt.; W/Hyd. Brakes; W/105A. Alt.	8876092	②♣♠9650HD
Hose - Upper - Pipe To Rad.		24232	Belt - P.S.; W/Air Brakes	8867788	♠9420HD
Hose - Lower - Eng. To Pipe		24240	Belt - P.S.; W/Hyd. Brakes	2459789	♠9476HD
Hose - Lower - Pipe To Rad.		24236	Belt - Air Brake Compr.	3883002	♠9605HD
GM V-8 283			SM6500		
SE5500			Belt - Fan & Alt.; W/61A. Alt.; W/Single Belt .	2485210	♠9600HD
Belt - Fan & Alt.	3888480	②♣♠9560HD	Belt - Fan & Alt.; W/61A. Alt.; W/Dual Belts .	3891365	♠9610HD
Belt - Fan & A.P.	3906417	♠9520HD	Belt - Fan & Alt.; W/130A. Alt.	2483914	②♣♠9670HD
Belt - P.S.	3888401	♠9412HD	Belt - P.S.; W/Air Brakes	8867788	♠9420HD
GM V-8 307			Belt - P.S.; W/Hyd. Brakes	2459789	♠9476HD
SE5500			Belt - Air Brake Compr.	3883002	♠9650HD
Belt - Fan & Alt.	3888480	②♣♠9560HD	GM V-6 351		
Belt - Fan & A.P.	3906417	♠9520HD	RM7500		
Belt - P.S.	3888401	♠9412HD	Belt - W.P. & Alt.; W/61A. Alt.; W/Single Belt	2485210	♠9600HD
GM V-8 327			Belt - W.P. & Alt.; W/61A. Alt.; W/Dual Belts	3891365	♠9610HD
SE5500			Belt - W.P. & Alt.; W/130A. Alt.	2483914	♠9670HD
Belt - Fan & Alt.	3888480	②♣♠9560HD	Belt - P.S.	2477462	♠9395HD
Belt - Fan & A.P.	3906417	♠9520HD	Belt - Air Brake Compr.		♠9650HD
Belt - P.S.	3888401	♠9412HD	Hose - Upper - Eng. To Pipe		23531
GM V-8 350			Hose - Upper - Pipe To Rad.		24232
SE5500			Hose - Lower - Eng. To Pipe		24240
Belt - Fan & Alt.	3888480	②♣♠9560HD	Hose - Lower - Pipe To Rad.		24236
Belt - Fan & A.P.	3906417	♠9520HD	SM5500		
Belt - P.S.	3888401	♠9412HD	Belt - Fan & Alt.; W/61A. Alt.	②♣♠9590HD	
GMC V-6 478 Diesel			Belt - Fan & Alt.; W/Air Brakes; W/105A. Alt.	2483932	②♣♠9660HD
SG5500			Belt - Fan & Alt.; W/Hyd. Brakes; W/105A. Alt.	8876092	②♣♠9650HD
Belt - Fan & Alt.; W/62A. Alt.	2439805	②♣♠9580HD	Belt - P.S.; W/Air Brakes	8867788	♠9420HD
Belt - Fan & Alt.; W/105A., 130A. Alt.	8867641	②♣♠9670HD	Belt - P.S.; W/Hyd. Brakes	2459789	♠9476HD
Belt - P.S.	3887676	♠9451HD	Belt - Air Brake Compr.	3883002	♠9605HD
Belt - Air Brake Compr.	3883002	♠9600HD	SM6500		
Belt - V.P.	8867790	♠9580HD	Belt - Fan & Alt.; W/61A. Alt.; W/Single Belt .	2485210	♠9600HD
Hose - Upper		26611	Belt - Fan & Alt.; W/61A. Alt.; W/Dual Belts .	3891365	♠9610HD
1969 - 1968			Belt - Fan & Alt.; W/130A. Alt.	2483914	②♣♠9670HD
GM 6-Cyl. 292			Belt - P.S.; W/Air Brakes	8867788	♠9420HD
SS5500			Belt - P.S.; W/Hyd. Brakes	2459789	♠9476HD
Belt - Fan & Alt.	3887682	♠9395HD	Belt - Air Brake Compr.	3883002	♠9650HD
Belt - Fan, Alt. & P.S.		♠9530HD	GM V-6 379		
Belt - Fan & Air Brake Compr.; W/O P.S.	3887683	♠9670HD	RM7500		
Hose - Upper		♠20686	Belt - W.P. & Alt.; W/61A. Alt.; W/Single Belt	2485210	♠9600HD
Hose - Lower		20489	Belt - W.P. & Alt.; W/61A. Alt.; W/Dual Belts	3891365	♠9610HD
		26611	Belt - W.P. & Alt.; W/130A. Alt.	2483914	♠9670HD
Hose - By Pass		20563	Belt - P.S.	2477462	♠9395HD
Hose - Heater Inlet		28442	Belt - Air Brake Compr.		♠9650HD
Hose - Heater Outlet		28441	Hose - Upper - Eng. To Pipe		23531
GM V-6 305			Hose - Upper - Pipe To Rad.		24232
RM7500			Hose - Lower - Eng. To Pipe		24240
Belt - W.P. & Alt.; W/61A. Alt.; W/Single Belt	2485210	♠9600HD	Hose - Lower - Pipe To Rad.		24236
Belt - W.P. & Alt.; W/61A. Alt.; W/Dual Belts	3891365	♠9610HD	SM5500		
Belt - W.P. & Alt.; W/130A. Alt.	2483914	♠9670HD	Belt - Fan & Alt.; W/61A. Alt.	②♣♠9590HD	
Belt - P.S.	2477462	♠9395HD			
Belt - Air Brake Compr.		♠9650HD			
Hose - Upper - Eng. To Pipe		23531			

♠Standard Belt Available.
②Two Required.

♣PowerBand Belt May Work, Use Template to Check.
♠Cut to Fit.

Belts and Coolant Hose for School Buses

Application	Mfr. Part No.	Our No.	Application	Mfr. Part No.	Our No.
GMC - Continued			GMC - Continued		
1969 - 1968 - Continued			1967		
GM V-6 379 - Continued			GM 6-Cyl. 292		
SM5500 - Continued			SS5500		
Belt - Fan & Alt.; W/Air Brakes; W/105A.			Belt - Fan & Alt.	3887682	▲9395HD
Alt.	2483932	②▲◆9660HD	Belt - Fan, Alt. & P.S.		▲9530HD
Belt - Fan & Alt.; W/Hyd. Brakes; W/105A.			Belt - Fan & Air Brake Compr.; W/O P.S.	3887683	▲9670HD
Alt.	8876092	②▲◆9650HD	Hose - Upper		≅20686
Belt - P.S.; W/Air Brakes	8867788	▲9420HD	Hose - Lower		20489
Belt - P.S.; W/Hyd. Brakes	2459789	▲9476HD		or	26611
Belt - Air Brake Compr.	3883002	▲9605HD	Hose - By Pass		20563
SM6500			Hose - Heater Inlet		28442
Belt - Fan & Alt.; W/61A. Alt.; W/Single Belt .	2485210	▲9600HD	Hose - Heater Outlet		28441
Belt - Fan & Alt.; W/61A. Alt.; W/Dual Belts .	3891365	▲9610HD			
Belt - Fan & Alt.; W/130A. Alt.	2483914	②▲◆9670HD	GM V-6 305		
Belt - P.S.; W/Air Brakes	8867788	▲9420HD	RM7500		
Belt - P.S.; W/Hyd. Brakes	2459789	▲9476HD	Belt - W.P. & Alt.; W/61A. Alt.; W/Single		
Belt - Air Brake Compr.	3883002	▲9650HD	Belt	2485210	▲9600HD
GM V-6 401			Belt - W.P. & Alt.; W/61A. Alt.; W/Dual		
RM7500			Belts	3891365	▲9610HD
Belt - W.P. & Alt.; W/60 1/4" Belt O.C.	2485210	②▲9600HD	Belt - W.P. & Alt.; W/130A. Alt.	2483914	▲9670HD
Belt - W.P. & Alt.; W/61 1/4" Belt O.C.	3891365	②▲◆9610HD	Belt - P.S.	2477462	▲9395HD
Belt - W.P. & Alt.; W/62 1/4" Belt O.C.	3888486	②▲9620HD	Belt - Air Brake Compr.		▲9650HD
Belt - W.P. & Alt.; W/66 1/4" Belt O.C.	2479287	②▲◆9660HD	Hose - Upper - Eng. To Pipe		23531
Belt - W.P. & Alt.; W/67 1/4" Belt O.C.	2483914	②▲◆9670HD	Hose - Upper - Pipe To Rad.		24232
Belt - P.S.; W/39 3/4" Belt O.C.	2477462	▲9395HD	Hose - Lower - Eng. To Pipe		24240
Belt - P.S.; W/40 3/4" Belt O.C.	3887674	▲9405HD	Hose - Lower - Pipe To Rad.		24236
Belt - Air Brake Compr.		▲9660HD			
Hose - Upper - Eng. To Pipe		23531	SM5500		
Hose - Upper - Pipe To Rad.		24232	Belt - Fan & Alt.; W/61A. Alt.		②▲◆9590HD
Hose - Lower - Eng. To Pipe		24240	Belt - Fan & Alt.; W/Air Brakes; W/105A.		
Hose - Lower - Pipe To Rad.		24236	Alt.	2483932	②▲◆9660HD
			Belt - Fan & Alt.; W/Hyd. Brakes; W/105A.		
			Alt.	8876092	②▲◆9650HD
			Belt - P.S.; W/Air Brakes	8867788	▲9420HD
			Belt - P.S.; W/Hyd. Brakes	2459789	▲9476HD
			Belt - Air Brake Compr.	3883002	▲9605HD
			SM6500		
			Belt - Fan & Alt.; W/61A. Alt.; W/Single Belt .	2485210	▲9600HD
			Belt - Fan & Alt.; W/61A. Alt.; W/Dual Belts .	3891365	▲9610HD
			Belt - Fan & Alt.; W/130A. Alt.	2483914	②▲◆9670HD
			Belt - P.S.; W/Air Brakes	8867788	▲9420HD
			Belt - P.S.; W/Hyd. Brakes	2459789	▲9476HD
			Belt - Air Brake Compr.		▲9650HD
			GM V-6 351		
			RM7500		
			Belt - W.P. & Alt.; W/61A. Alt.; W/Single		
			Belt	2485210	▲9600HD
			Belt - W.P. & Alt.; W/61A. Alt.; W/Dual		
			Belts	3891365	▲9610HD
			Belt - W.P. & Alt.; W/130A. Alt.	2483914	▲9670HD
			Belt - P.S.	2477462	▲9395HD
			Belt - Air Brake Compr.		▲9650HD
			Hose - Upper - Eng. To Pipe		23531
			Hose - Upper - Pipe To Rad.		24232
			Hose - Lower - Eng. To Pipe		24240
			Hose - Lower - Pipe To Rad.		24236
			SM5500		
			Belt - Fan & Alt.; W/61A. Alt.		②▲◆9590HD
			Belt - Fan & Alt.; W/Air Brakes; W/105A.		
			Alt.	2483932	②▲◆9660HD
			Belt - Fan & Alt.; W/Hyd. Brakes; W/105A.		
			Alt.	8876092	②▲◆9650HD
			Belt - P.S.; W/Air Brakes	8867788	▲9420HD
			Belt - P.S.; W/Hyd. Brakes	2459789	▲9476HD
			Belt - Air Brake Compr.	3883002	▲9605HD
			SM6500		
			Belt - Fan & Alt.; W/61A. Alt.; W/Single Belt .	2485210	▲9600HD
			Belt - Fan & Alt.; W/61A. Alt.; W/Dual Belts .	3891365	▲9610HD
			Belt - Fan & Alt.; W/130A. Alt.	2483914	②▲◆9670HD

School Buses

▲Standard Belt Available.
②Two Required.

◆PowerBand Belt May Work. Use Template to Check.
≅Cut to Fit.

Belts and Coolant Hose for School Buses

School Buses

Application	Mfr. Part No.	Our No.	Application	Mfr. Part No.	Our No.
GMC - Continued			GMC - Continued		
1967 - Continued			1967 - Continued		
GM V-6 351 - Continued			GM V-6 478 - Continued		
SM6500 - Continued			RM7500 - Continued		
Belt - P.S.; W/Air Brakes	8867788	♣9420HD	Belt - W.P. & Alt.; W/61 1/4" Belt O.C.	3891365	②♣♠9610HD
Belt - P.S.; W/Hyd. Brakes	2459789	♣9476HD	Belt - W.P. & Alt.; W/62 1/4" Belt O.C.	3888486	②♣9620HD
Belt - Air Brake Compr.		♣9650HD	Belt - W.P. & Alt.; W/66 1/4" Belt O.C.	2479287	②♣♠9660HD
GM V-6 379			Belt - W.P. & Alt.; W/67 1/4" Belt O.C.	2483914	②♣♠9670HD
RM7500			Belt - P.S.; W/39 3/4" Belt O.C.	2477462	♣9395HD
Belt - W.P. & Alt.; W/61A. Alt.; W/Single Belt	2485210	♣9600HD	Belt - P.S.; W/40 3/4" Belt O.C.	3887674	♣9405HD
Belt - W.P. & Alt.; W/61A. Alt.; W/Dual Belts	3891365	♣9610HD	Belt - Air Brake Compr.		♣9660HD
Belt - W.P. & Alt.; W/130A. Alt.	2483914	♣9670HD	Hose - Upper - Eng. To Pipe		23531
Belt - P.S.	2477462	♣9395HD	Hose - Upper - Pipe To Rad.		24232
Belt - Air Brake Compr.		♣9650HD	Hose - Lower - Eng. To Pipe		24240
Hose - Upper - Eng. To Pipe		23531	Hose - Lower - Pipe To Rad.		24236
Hose - Upper - Pipe To Rad.		24232	GMC V-6 478 Diesel		
Hose - Lower - Eng. To Pipe		24240	RG7500		
Hose - Lower - Pipe To Rad.		24236	Belt - W.P. & Alt.; W/85A., 105A., 130A. Alt.	2453896	②♣♠9670HD
SM5500			Belt - P.S.	3887682	♣9395HD
Belt - Fan & Alt.; W/61A. Alt.		②♣♠9590HD	Belt - Air Brake Compr.	2471922	♣9600HD
Belt - Fan & Alt.; W/Air Brakes; W/105A. Alt.	2483932	②♣♠9660HD	Belt - V.P.	3764340	♣9550HD
Belt - Fan & Alt.; W/Hyd. Brakes; W/105A. Alt.	8876092	②♣♠9650HD	Hose - Upper		24232
Belt - P.S.; W/Air Brakes	8867788	♣9420HD	Hose - Lower		24236
Belt - P.S.; W/Hyd. Brakes	2459789	♣9476HD	Hose - By Pass		②♣=20904
Belt - Air Brake Compr.	3883002	♣9605HD	1966		
SM6500			GM V-6 305		
Belt - Fan & Alt.; W/61A. Alt.; W/Single Belt	2485210	♣9600HD	RM7500		
Belt - Fan & Alt.; W/61A. Alt.; W/Dual Belts	3891365	♣9610HD	Belt - W.P. & Alt.; W/61A. Alt.; W/Single Belt	2485210	♣9600HD
Belt - Fan & Alt.; W/130A. Alt.	2483914	②♣♠9670HD	Belt - W.P. & Alt.; W/61A. Alt.; W/Dual Belts	3891365	♣9610HD
Belt - P.S.; W/Air Brakes	8867788	♣9420HD	Belt - W.P. & Alt.; W/130A. Alt.	2483914	♣9670HD
Belt - P.S.; W/Hyd. Brakes	2459789	♣9476HD	Belt - P.S.	2477462	♣9395HD
Belt - Air Brake Compr.		♣9650HD	Belt - Air Brake Compr.		♣9650HD
GM V-6 401			Hose - Upper - Eng. To Pipe		23531
RM7500			Hose - Upper - Pipe To Rad.		24232
Belt - W.P. & Alt.; W/60 1/4" Belt O.C.	2485210	②♣9600HD	Hose - Lower - Eng. To Pipe		24240
Belt - W.P. & Alt.; W/61 1/4" Belt O.C.	3891365	②♣♠9610HD	Hose - Lower - Pipe To Rad.		24236
Belt - W.P. & Alt.; W/62 1/4" Belt O.C.	3888486	②♣9620HD	GM V-6 351		
Belt - W.P. & Alt.; W/66 1/4" Belt O.C.	2479287	②♣♠9660HD	RM7500		
Belt - W.P. & Alt.; W/67 1/4" Belt O.C.	2483914	②♣♠9670HD	Belt - W.P. & Alt.; W/61A. Alt.; W/Single Belt	2485210	♣9600HD
Belt - P.S.; W/39 3/4" Belt O.C.	2477462	♣9395HD	Belt - W.P. & Alt.; W/61A. Alt.; W/Dual Belts	3891365	♣9610HD
Belt - P.S.; W/40 3/4" Belt O.C.	3887674	♣9405HD	Belt - W.P. & Alt.; W/130A. Alt.	2483914	♣9670HD
Belt - Air Brake Compr.		♣9660HD	Belt - P.S.	2477462	♣9395HD
Hose - Upper - Eng. To Pipe		23531	Belt - Air Brake Compr.		♣9650HD
Hose - Upper - Pipe To Rad.		24232	Hose - Upper - Eng. To Pipe		23531
Hose - Lower - Eng. To Pipe		24240	Hose - Upper - Pipe To Rad.		24232
Hose - Lower - Pipe To Rad.		24236	Hose - Lower - Eng. To Pipe		24240
GM V-6 432			Hose - Lower - Pipe To Rad.		24236
RM7500			GM V-6 379		
Belt - W.P. & Alt.; W/60 1/4" Belt O.C.	2485210	②♣9600HD	RM7500		
Belt - W.P. & Alt.; W/61 1/4" Belt O.C.	3891365	②♣♠9610HD	Belt - W.P. & Alt.; W/61A. Alt.; W/Single Belt	2485210	♣9600HD
Belt - W.P. & Alt.; W/62 1/4" Belt O.C.	3888486	②♣9620HD	Belt - W.P. & Alt.; W/61A. Alt.; W/Dual Belts	3891365	♣9610HD
Belt - W.P. & Alt.; W/66 1/4" Belt O.C.	2479287	②♣♠9660HD	Belt - W.P. & Alt.; W/130A. Alt.	2483914	♣9670HD
Belt - W.P. & Alt.; W/67 1/4" Belt O.C.	2483914	②♣♠9670HD	Belt - P.S.	2477462	♣9395HD
Belt - P.S.; W/39 3/4" Belt O.C.	2477462	♣9395HD	Belt - Air Brake Compr.		♣9650HD
Belt - P.S.; W/40 3/4" Belt O.C.	3887674	♣9405HD	Hose - Upper - Eng. To Pipe		23531
Belt - Air Brake Compr.		♣9660HD	Hose - Upper - Pipe To Rad.		24232
Hose - Upper - Eng. To Pipe		23531	Hose - Lower - Eng. To Pipe		24240
Hose - Upper - Pipe To Rad.		24232	Hose - Lower - Pipe To Rad.		24236
Hose - Lower - Eng. To Pipe		24240	GM V-6 478		
Hose - Lower - Pipe To Rad.		24236	RM7500		
GM V-6 478			Belt - W.P. & Alt.; W/60 1/4" Belt O.C.	2485210	②♣9600HD
RM7500					

♣Standard Belt Available.
②Two Required.

♣PowerBand Belt May Work, Use Template to Check.
=Cut to Fit.

Belts and Coolant Hose for School Buses

Application	Mfr. Part No.	Our No.	Application	Mfr. Part No.	Our No.
GMC - Continued			International/Navistar - Continued		
1966 - Continued			2013		
GM V-6 401			International/Navistar MaxxForce DT Diesel		
RM7500			CE		
Belt - W.P. & Alt.; W/60 1/4" Belt O.C.	2485210	②♠9600HD	Belt - Accessory Belt Drive Kit		ACK100714HD
Belt - W.P. & Alt.; W/61 1/4" Belt O.C.	3891365	②♠9610HD	Belt - Fan	1847706C1	K100714HD
Belt - W.P. & Alt.; W/62 1/4" Belt O.C.	3888486	②♠9620HD	Tensioner Assy.	1873217C2	38634
Belt - W.P. & Alt.; W/66 1/4" Belt O.C.	2479287	②♠9660HD	Hose - Upper		23794
Belt - W.P. & Alt.; W/67 1/4" Belt O.C.	2483914	②♠9670HD	2012		
Belt - P.S.; W/39 3/4" Belt O.C.	2477462	♠9395HD	International/Navistar MaxxForce 7 Diesel		
Belt - P.S.; W/40 3/4" Belt O.C.	3887674	♠9405HD	BE		
Belt - Air Brake Compr.		♠9660HD	Belt - Serpentine	1889037C1	K081047HD
Hose - Upper - Eng. To Pipe		23531	Tensioner Assy. - Fan	1833688C2	38556
Hose - Upper - Pipe To Rad.		24232	Idler Pulley - Fan	1832710C1	36351
Hose - Lower - Eng. To Pipe		24240	Hose - Upper		23795
Hose - Lower - Pipe To Rad.		24236	Hose - Lower		23793
GM V-6 432			International/Navistar MaxxForce DT Diesel		
RM7500			CE		
Belt - W.P. & Alt.; W/60 1/4" Belt O.C.	2485210	②♠9600HD	Belt - Accessory Belt Drive Kit		ACK100714HD
Belt - W.P. & Alt.; W/61 1/4" Belt O.C.	3891365	②♠9610HD	Belt - Fan	1847706C1	K100714HD
Belt - W.P. & Alt.; W/62 1/4" Belt O.C.	3888486	②♠9620HD	Tensioner Assy.	1873217C2	38634
Belt - W.P. & Alt.; W/66 1/4" Belt O.C.	2479287	②♠9660HD	Hose - Upper		23794
Belt - W.P. & Alt.; W/67 1/4" Belt O.C.	2483914	②♠9670HD	RE		
Belt - P.S.; W/39 3/4" Belt O.C.	2477462	♠9395HD	Belt - Serpentine	1888657C1	♠K100694HD
Belt - P.S.; W/40 3/4" Belt O.C.	3887674	♠9405HD	Belt - P.S.	2565415C1	♠K081092HD
Belt - Air Brake Compr.		♠9660HD	Tensioner Assy.	1873217C2	38634
Hose - Upper - Eng. To Pipe		23531	Hose - Upper - Eng. To Pipe; 4 1/2" ...		24236
Hose - Upper - Pipe To Rad.		24232	Hose - Lower - Eng. To Pipe		21891
Hose - Lower - Eng. To Pipe		24240	2011		
Hose - Lower - Pipe To Rad.		24236	International/Navistar MaxxForce 7 Diesel		
GM V-6 478			BE		
RM7500			Belt - Accessory Belt Drive Kit		ACK080991HD
Belt - W.P. & Alt.; W/60 1/4" Belt O.C.	2485210	②♠9600HD	Belt - Fan	3565413C3	♠K080991HD
Belt - W.P. & Alt.; W/61 1/4" Belt O.C.	3891365	②♠9610HD	Tensioner Assy.	1833688C2	38556
Belt - W.P. & Alt.; W/62 1/4" Belt O.C.	3888486	②♠9620HD	Idler Pulley	1832710C1	36351
Belt - W.P. & Alt.; W/66 1/4" Belt O.C.	2479287	②♠9660HD	Hose - Upper		23795
Belt - W.P. & Alt.; W/67 1/4" Belt O.C.	2483914	②♠9670HD	Hose - Lower		23793
Belt - P.S.; W/39 3/4" Belt O.C.	2477462	♠9395HD	CE		
Belt - P.S.; W/40 3/4" Belt O.C.	3887674	♠9405HD	Belt - Accessory Belt Drive Kit - Fan, Alt. & W.P.		ACK080962HD
Belt - Air Brake Compr.		♠9660HD	Belt - Accessory Belt Drive Kit - A.C.		ACK060696HD1
Hose - Upper - Eng. To Pipe		23531	Belt - Fan, W.P. & Alt.	1832194C2	K080962HD
Hose - Upper - Pipe To Rad.		24232	Belt - A.C.	1847509C1	♠K060696HD
Hose - Lower - Eng. To Pipe		24240	Tensioner Assy. - Fan, W.P. & Alt.	1833688C2	38556
Hose - Lower - Pipe To Rad.		24236	Tensioner Assy. - A.C.	1832711C2	38629
GMC V-6 478 Diesel			Idler Pulley - Fan & Alt.	1832710C1	36351
RG7500			Idler Pulley - A.C. (Left)	1832712C1	38006
Belt - W.P. & Alt.; W/85A., 105A., 130A. Alt.	2453896	②♠9670HD	Idler Pulley - A.C. (Right)	1832712C1	38006
Belt - P.S.	3887682	♠9395HD	Hose - Upper		23795
Belt - Air Brake Compr.	2471922	♠9600HD	Hose - Lower		23793
Belt - V.P.	3764340	♠9550HD	International/Navistar MaxxForce DT Diesel		
Hose - Upper		24232	CE		
Hose - Lower		24236	Belt - Accessory Belt Drive Kit - Fan		ACK100702HD
Hose - By Pass		②♠20904	Belt - Fan	1888631C1	K100702HD
International/Navistar			Tensioner Assy.	1873217C2	38634
2015 - 2014			Hose - Upper		23794
International/Navistar MaxxForce DT Diesel			Hose - Lower		24060
CE			FE		
Belt - Serpentine	1888631C1	K100702HD	Belt - Accessory Belt Drive Kit		ACK100745HD
Belt - Accessory Belt Drive Kit		ACK100702HD	Belt - Fan & Alt.	1847732C1	K100745HD
Tensioner Assy.	1873217C2	38634	Tensioner Assy. - Fan & Alt.	1873217C1	38634
Hose - Upper		23794	RE		
Hose - Lower		24075	Belt - Accessory Belt Drive Kit		ACK101091HD
Hose - Turbo To Pipe (Hot Side)		26200	Belt - Fan, A.C., Alt. & W.P.	1881079C1	K101091HD
Hose - Pipe To Intercooler (Hot Side)		26201	Tensioner Assy. - Fan, A.C., Alt. & W.P.	1873217C1	38634

School Buses

 ♠Standard Belt Available.
 ②Two Required.

 ◆PowerBand Belt May Work, Use Template to Check.
 ♠Cut to Fit.

Belts and Coolant Hose for School Buses

School Buses

Application	Mfr. Part No.	Our No.	Application	Mfr. Part No.	Our No.
International/Navistar - Continued			International/Navistar - Continued		
2010			2009 - Continued		
International/Navistar MaxxForce 7 Diesel			International/Navistar MaxxForce DT Diesel - Continued		
BE			3200 - Continued		
Belt - Accessory Belt Drive Kit		ACK080962HD	Belt - Alt.	1847708C1	K100870HD
Belt - Fan	1832194C2	K080962HD	Tensioner Assy. - Fan	1873217C2	38634
Tensioner Assy.	1833688C2	38556	Idler Pulley - Fan	1841930C1	36164
Idler Pulley	1832710C1	36351	CE		
Hose - Upper		23795	Belt - Accessory Belt Drive Kit - Fan, Alt. & W.P.;		
Hose - Lower		23793	W/Prestolite Alt.		
CE			ACK100731HD		
Belt - Accessory Belt Drive Kit - Fan, Alt. & W.P.		ACK080962HD	Belt - Accessory Belt Drive Kit - Alt. & W.P.; W/Bosch Alt. .		
Belt - Accessory Belt Drive Kit - A.C.		ACK060696HD1	ACK100702HD		
Belt - Fan, W.P. & Alt.	1832194C2	K080962HD	K100702HD		
Belt - A.C.	1847509C1	▲K060696HD	▲K100731HD		
Tensioner Assy. - Fan, W.P. & Alt.	1833688C2	38556	38634		
Tensioner Assy. - A.C.	1832711C2	38629	38634		
Idler Pulley - Fan & Alt.	1832710C1	36351	23794		
Idler Pulley - A.C. (Left)	1832712C1	38006	24060		
Idler Pulley - A.C. (Right)	1832712C1	38006	24075		
Hose - Upper		23795	Hose - Lower - Cooler To Pipe		
Hose - Lower		23793	≈21302		
International/Navistar MaxxForce DT Diesel			FE		
3200			Belt - Accessory Belt Drive Kit		
Tensioner Assy.	1873217C1	38634	ACK080774HD		
Idler Pulley	1841930C1	36164	▲K080774HD		
CE			38620		
Belt - Accessory Belt Drive Kit; W/Prestolite Alt.		ACK100726HD	RE		
Belt - Accessory Belt Drive Kit; W/Bosch Alt.		ACK100720HD	Belt - Accessory Belt Drive Kit		
Belt - Fan, Alt. & W.P.; W/Prestolite Alt.	1847736C1	K100726HD	ACK101091HD		
Belt - Fan, Alt. & W.P.; W/Bosch Alt.	1847678C1	K100720HD	K101091HD		
Tensioner Assy. - Fan, W.P. & Alt.	1873217C2	38634	38634		
Hose - Upper		23794	2008		
Hose - Lower		24060	International/Navistar MaxxForce 7 Diesel		
FE			BE		
Belt - Accessory Belt Drive Kit		ACK100745HD	Belt - Accessory Belt Drive Kit		
Belt - Fan & Alt.	1847732C1	K100745HD	ACK080702HD		
Tensioner Assy. - Fan & Alt.	1873217C1	38634	▲K080702HD		
RE			38556		
Belt - Accessory Belt Drive Kit		ACK101091HD	36351		
Belt - Fan, A.C., Alt. & W.P.	1881079C1	K101091HD	22775		
Tensioner Assy. - Fan, A.C., Alt. & W.P.	1873217C1	38634	CE		
2009			Belt - Accessory Belt Drive Kit - Fan, Alt. & W.P.		
International/Navistar MaxxForce 7 Diesel			ACK080962HD		
BE			ACK060696HD1		
Belt - Accessory Belt Drive Kit		ACK080962HD	K080962HD		
Belt - Fan	1832194C2	K080962HD	▲K060696HD		
Tensioner Assy.	1833688C2	38556	38556		
Idler Pulley	1832710C1	36351	38629		
Hose - Upper		23795	36351		
Hose - Lower		23793	38006		
CE			38006		
Belt - Accessory Belt Drive Kit - Fan, Alt. & W.P.		ACK080962HD	23795		
Belt - Accessory Belt Drive Kit - A.C.		ACK060696HD1	23793		
Belt - Fan, W.P. & Alt.	1832194C2	K080962HD	International/Navistar MaxxForce DT Diesel		
Belt - A.C.	1847509C1	▲K060696HD	CE		
Tensioner Assy. - Fan, W.P. & Alt.	1833688C2	38556	Belt - Accessory Belt Drive Kit - Fan, Alt. & W.P.; W/73"		
Tensioner Assy. - A.C.	1832711C2	38629	Belt O.C.		
Idler Pulley - Fan & Alt.	1832710C1	36351	ACK080723HD		
Idler Pulley - A.C. (Left)	1832712C1	38006	Belt - Accessory Belt Drive Kit - Fan, Alt. & W.P.; W/73		
Idler Pulley - A.C. (Right)	1832712C1	38006	1/2" Belt O.C.		
Hose - Upper		23795	ACK100731HD		
Hose - Lower		23793	K080723HD		
International/Navistar MaxxForce DT Diesel			▲K100731HD		
3200			38620		
Belt - Accessory Belt Drive Kit		ACK100870HD	38634		
International/Navistar MaxxForce 7 Diesel			20731		
BE			FE		
Belt - Accessory Belt Drive Kit		ACK080774HD	Belt - Accessory Belt Drive Kit		
Belt - Fan & Alt.	1839964C1	▲K080702HD	ACK080774HD		
International/Navistar VT365 Diesel			▲K080774HD		
BE			38620		
Belt - Accessory Belt Drive Kit		ACK080702HD	International/Navistar VT365 Diesel		
Belt - Fan & Alt.	1839964C1	▲K080702HD	BE		
International/Navistar VT365 Diesel			Belt - Accessory Belt Drive Kit		
BE			ACK080702HD		
Belt - Accessory Belt Drive Kit		ACK080702HD	▲K080702HD		
Belt - Fan & Alt.	1839964C1	▲K080702HD			

▲Standard Belt Available.

≈Cut to Fit.

Belts and Coolant Hose for School Buses

Application	Mfr. Part No.	Our No.	Application	Mfr. Part No.	Our No.
International/Navistar - Continued			International/Navistar - Continued		
2008 - Continued			2006		
International/Navistar VT365 Diesel - Continued			International/Navistar DT466 Diesel		
BE - Continued			3200		
Tensioner Assy. - Fan & Alt.	1833688C2	38556	Belt - Accessory Belt Drive Kit		ACK080723HD
Hose - Upper - Rad. To Eng.		22774	Belt - Serpentine	1842455C1	K080723HD
Hose - Lower - Eng. To W.P.		22775	Tensioner Assy.	1841760C1	38620
CE			3300		
Belt - Accessory Belt Drive Kit		ACK080702HD	Belt - Accessory Belt Drive Kit		ACK080723HD
Belt - Fan & Alt.	1839964C1	♣K080702HD	Belt - Serpentine	1842455C1	K080723HD
Tensioner Assy. - Fan & Alt.	1833688C2	38556	Tensioner Assy.	1841760C1	38620
Idler Pulley	1822653C92	36288	Hose - Upper		20731
Hose - Upper - Rad. To Eng.		22774	Hose - Lower		24074
Hose - Lower		22775	CE		
2007			Belt - Accessory Belt Drive Kit		
International/Navistar DT466 Diesel			Belt - Fan, W.P. & Alt.		
3200			Tensioner Assy. - Fan, W.P. & Alt.		
Belt - Accessory Belt Drive Kit		ACK080723HD	Hose - Lower - Cooler To Rad.		
Belt - Serpentine	1842455C1	K080723HD	Hose - Lower - Eng. To Cooler		
Tensioner Assy.	1841760C1	38620	FE		
3300			Belt - Accessory Belt Drive Kit		
Belt - Accessory Belt Drive Kit		ACK080723HD	Belt - Fan, W.P. & Alt.		
Belt - Serpentine	1842455C1	K080723HD	Tensioner Assy.		
Tensioner Assy.	1841760C1	38620	RE		
Hose - Upper		20731	Belt - Accessory Belt Drive Kit - Fan, Alt. & W.P.;		
Hose - Lower		24074	W/200A. Alt.		
CE			Belt - Fan, W.P. & Alt.; W/200A. Alt.		
Belt - Accessory Belt Drive Kit		ACK080723HD	Tensioner Assy. - Fan, W.P. & Alt.		
Belt - W.P., Fan & Alt.	1842455C1	K080723HD	W/200A. Alt.		
Tensioner Assy. - Fan, W.P. & Alt.	1841760C1	38620	International/Navistar VT365 Diesel		
Hose - Upper - Eng. To Rad.		20731	CE		
FE			Belt - Accessory Belt Drive Kit - Fan & Alt.; W/O A.C.		
Belt - Accessory Belt Drive Kit		ACK080774HD	Belt - Accessory Belt Drive Kit - Fan & Compr.		
Belt - Fan, W.P. & Alt.	1842463C1	♣K080774HD	Belt - Accessory Belt Drive Kit - Fan, Alt. & A.C.		
Tensioner Assy.	1841760C1	38620	Belt - Fan & Compr.		
RE			Belt - Fan, Alt. & A.C.		
Belt - Accessory Belt Drive Kit - Fan, Alt. & W.P.;		ACK080830HD1	Belt - Fan & Alt.; W/O A.C.		
W/200A. Alt.		ACK080830HD	Tensioner Assy.		
Belt - Fan, Alt. & W.P.; W/200A. Alt.	1842930C1	♣K080830HD	Hose - Upper - Rad. To Eng.		
Tensioner Assy. - Fan, W.P. & Alt.;			Hose - Lower		
W/200A. Alt.	1841760C1	38620	2005		
International/Navistar VT365 Diesel			International/Navistar DT466 Diesel		
BE			3200		
Belt - Accessory Belt Drive Kit		ACK080702HD	Belt - Accessory Belt Drive Kit		
Belt - Fan & Alt.	1839964C1	♣K080702HD	Belt - Serpentine		
Tensioner Assy. - Fan & Alt.	1833688C2	38556	Tensioner Assy.		
Hose - Upper - Rad. To Eng.		22774	3300		
Hose - Lower - Eng. To W.P.		22775	Belt - Accessory Belt Drive Kit		
CE			Belt - Serpentine		
Belt - Accessory Belt Drive Kit - Fan & Alt.		ACK080702HD	Tensioner Assy.		
Belt - Accessory Belt Drive Kit - Fan & Compr.		ACK060509HD	Hose - Upper		
Belt - Fan & Alt.	1839964C1	♣K080702HD	Hose - Lower		
Belt - Fan & Compr.	1843218C1	♣K060509HD	CE		
Tensioner Assy. - Fan & Alt.	1833688C2	38556	Belt - Accessory Belt Drive Kit - Fan, Alt. & W.P.;		
Tensioner Assy. - Fan & Air Brake Compr. .	1833688C2	38556	W/145A. Alt.		
Hose - Upper - Rad. To Eng.		22774	Belt - Accessory Belt Drive Kit - Fan, Alt. & W.P.;		
Hose - Lower		22775	W/200A. Alt.		
RE			Belt - Fan, Alt. & W.P.; W/145A. Alt.		
Belt - Accessory Belt Drive Kit		ACK080897HD	Belt - Fan, Alt. & W.P.; W/200A. Alt.		
Belt - Accessory Belt Drive Kit - A.C.		ACK060509HD	Tensioner Assy. - Fan, W.P. & Alt.		
Belt - A.C.	1843218C1	♣K060509HD	FE		
Belt - Fan	1842720C1	♣K080897HD	Belt - Accessory Belt Drive Kit		
Tensioner Assy.	1833688C2	38556	Belt - Fan, W.P. & Alt.		
			Tensioner Assy.		
			RE		
			Belt - Accessory Belt Drive Kit		
			Belt - Fan, W.P. & Alt.		
			Tensioner Assy.		
			ACK080842HD		
			♣K080842HD		
			38620		

♣Standard Belt Available.

Belts and Coolant Hose for School Buses

Application	Mfr. Part No.	Our No.	Application	Mfr. Part No.	Our No.
International/Navistar - Continued			International/Navistar - Continued		
2005 - Continued			2003		
International/Navistar VT365 Diesel			International/Navistar 530 Diesel		
CE			RE		
Belt - Accessory Belt Drive Kit - Fan & Alt.; W/O A.C.		ACK080702HD	Belt - Accessory Belt Drive Kit		ACK080765HD
Belt - Accessory Belt Drive Kit - Fan & Compr.		ACK060509HD	Belt - Fan & Alt.	1841577C1	♣K080765HD
Belt - Accessory Belt Drive Kit - Fan, Alt. & A.C.		ACK080855HD	Tensioner Assy. - Fan & Alt.	1830033C1	38514
Belt - Fan & Compr.	1843218C1	♣K060509HD	Tensioner Pulley - Fan & Alt.	1830033C1	36091
Belt - Fan, Alt. & A.C.		♣K080855HD			
Belt - Fan & Alt.; W/O A.C.	1839964C1	♣K080702HD			
Tensioner Assy.	1833688C2	38556			
Hose - Upper - Rad. To Eng.		22774			
Hose - Lower		22775			
2004					
International/Navistar 530 Diesel					
RE			International/Navistar DT466 Diesel		
Belt - Accessory Belt Drive Kit		ACK080765HD	3300		
Belt - Fan & Alt.	1841577C1	♣K080765HD	Belt - Serpentine	1842455C1	K080723HD
Tensioner Assy. - Fan & Alt.	1830033C1	38514	Belt - Accessory Belt Drive Kit		ACK080723HD1
Tensioner Pulley - Fan & Alt.	1830033C1	36091	Tensioner Assy.	1830033C1	38514
			Tensioner Pulley	1830033C1	36091
			Hose - Upper		20731
			Hose - Lower		24074
			3800		
			Belt - Accessory Belt Drive Kit		ACK080726HD
			Belt - Alt.	1819391C2	♣K080726HD
			Tensioner Assy.	1830033C2	38514
			CE		
			Belt - Accessory Belt Drive Kit - Fan & Alt.		ACK080690HD
			Belt - Accessory Belt Drive Kit - A.C.; W/Dual A.C.		ACK060675HD
			Belt - Fan & Alt.	1830727C2	♣K080690HD
			Belt - A.C.; W/Dual A.C.		♣K060675HD
			Tensioner Assy. - Fan & Alt.	1830033C1	38514
			Tensioner Pulley - Fan & Alt.	1830033C1	36091
			Hose - Upper - Eng. To Rad.		22776
			Hose - Lower - Eng. To Rad.		20987
			FE		
			Belt - Accessory Belt Drive Kit		ACK080726HD
			Belt - Fan, W.P. & Alt.	1819391C2	♣K080726HD
			Tensioner Assy.	1830033C2	38514
			Tensioner Pulley	1830033C2	36091
			Hose - Lower		22783
			RE		
			Belt - Accessory Belt Drive Kit		ACK080842HD
			Belt - Fan, W.P. & Alt.	1842464C1	♣K080842HD
			Tensioner Assy. - Fan, W.P. & Alt.	1841760C1	38620
			International/Navistar T444 Diesel		
			3800		
			Idler Pulley; W/Flat Idler Pulley	1822652C91	36287
			Idler Pulley; W/Multi-Grooved Idler Pulley ...	1822653C91	36288
			CE		
			Belt - Accessory Belt Drive Kit		ACK081124HD
			Belt - Fan & Alt.	1822832C1	♣K081124HD
			Tensioner Assy. - Fan & Alt.	1822679C1	38510
			Idler Pulley; W/Flat Idler Pulley	1822652C91	36287
			Idler Pulley; W/V-Groove Idler Pulley	1822653C91	36288
			Hose - Upper - Eng. To Rad.		22785
			Hose - Lower		22782
			Conventional IC		
			Belt - Serpentine		♣K081377HD
			Belt - Accessory Belt Drive Kit		ACK081377HD1
			Tensioner Assy.	1822679C4	38510
			Idler Pulley; W/Flat Idler Pulley	1822652C91	36287
			Idler Pulley; W/V-Groove Idler Pulley	1822653C91	36288
			Tensioner Pulley	1822679C4	36092
			Hose - Lower - Eng. To Rad.		22782

♣Standard Belt Available.

Belts and Coolant Hose for School Buses

Application	Mfr. Part No.	Our No.	Application	Mfr. Part No.	Our No.
International/Navistar - Continued			International/Navistar - Continued		
2002			2001 - Continued		
International/Navistar 530 Diesel			International/Navistar DT466 Diesel - Continued		
RE			CE - Continued		
Tensioner Assy. - Fan & Alt.	1830033C1	38514	Tensioner Assy. - Fan, Alt. & Hub	1830033C1	38514
Tensioner Pulley - Fan & Alt.	1830033C1	36091	Tensioner Pulley - Fan, Alt. & Hub	1830033C1	36091
International/Navistar DT466 Diesel			Hose - Upper - Eng. To Rad.		
3800			Hose - Lower - Eng. To Rad.		
Belt - Fan	1830727C1	♣K080690HD	RE		
CE; Conventional IC			Belt - Accessory Belt Drive Kit		
Belt - Accessory Belt Drive Kit - Fan, Alt. & Hub		ACK080690HD	Belt - Fan, W.P. & Alt.		
Belt - Fan, Alt. & Hub	1830727C1	♣K080690HD	Tensioner Assy. - Fan, W.P. & Alt.		
Tensioner Assy. - Fan, Alt. & Hub	1830033C1	38514	International/Navistar T444 Diesel		
Tensioner Pulley - Fan, Alt. & Hub	1830033C1	36091	3400		
Hose - Upper - Eng. To Rad.		22776	Idler Pulley; W/Flat Idler Pulley		
Hose - Lower - Eng. To Rad.		20987	Idler Pulley; W/V-Groove Idler Pulley		
FE			3800		
Belt - Accessory Belt Drive Kit		ACK080726HD	Belt - Accessory Belt Drive Kit; W/Air Brake Compr.		
Belt - Fan, W.P. & Alt.	1819391C2	♣K080726HD	Belt - Accessory Belt Drive Kit; W/O Air Brake Compr.		
Tensioner Assy.	1830033C2	38514	Belt - W.P., Fan & Alt.; W/Air Brake Compr.		
Tensioner Pulley	1830033C2	36091	Belt - W.P., Fan & Alt.; W/O Air Brake		
Hose - Lower		22783	Compr.		
RE			Tensioner Assy.		
Belt - Accessory Belt Drive Kit		ACK080842HD	Idler Pulley; W/Flat Idler Pulley		
Belt - Fan, W.P. & Alt.	1842464C1	♣K080842HD	Idler Pulley; W/Multi-Grooved Idler Pulley ...		
Tensioner Assy. - Fan, W.P. & Alt.	1841760C1	38620	Hose - Upper - Eng. To Pipe		
International/Navistar T444 Diesel			Hose - Lower - Eng. To Pipe		
3400			Hose - Lower - Pipe To Pipe		
Idler Pulley; W/Flat Idler Pulley	1822652C91	36287	Hose - Lower - Pipe To Rad.		
Idler Pulley; W/V-Groove Idler Pulley	1822653C91	36288	RE		
3800			Belt - Accessory Belt Drive Kit; W/Air Brake Compr.		
Belt - Accessory Belt Drive Kit; W/Air Brake Compr.		ACK081124HD	Belt - Accessory Belt Drive Kit; W/O Air Brake Compr.		
Belt - Accessory Belt Drive Kit; W/O Air Brake Compr.		ACK080893HD	Belt - W.P., Fan & Alt.; W/Air Brake Compr.		
Belt - W.P., Fan & Alt.; W/Air Brake Compr.	1822832C1	♣K081124HD	Belt - W.P., Fan & Alt.; W/O Air Brake		
Belt - W.P., Fan & Alt.; W/O Air Brake			Compr.		
Compr.	1822830C1	♣K080893HD	Tensioner Assy.		
Tensioner Assy.	1822679C3	38510	Idler Pulley; W/Flat Idler Pulley		
Idler Pulley; W/Flat Idler Pulley	1822652C91	36287	Idler Pulley; W/V-Groove Idler Pulley		
Idler Pulley; W/Multi-Grooved Idler Pulley ...	1822653C91	36288	2000		
Conventional IC			International/Navistar 530 Diesel		
Belt - Accessory Belt Drive Kit		ACK080893HD	RE		
Belt - Fan, Alt. & Hub	1822830C1	♣K080893HD	Belt - Accessory Belt Drive Kit		
Tensioner Assy. - Fan, Alt. & Hub	1822679C3	38510	Belt - Fan & Alt.		
Idler Pulley; W/Flat Idler Pulley	1822652C91	36287	Tensioner Assy. - Fan & Alt.		
Idler Pulley; W/V-Groove Idler Pulley	1822653C91	36288	Tensioner Pulley - Fan & Alt.		
Hose - Upper - Eng. To Rad.		21042	International/Navistar DT466 Diesel		
Hose - Lower - Eng. To Rad.		22782	3800		
2001			Belt - Accessory Belt Drive Kit		
International/Navistar 530 Diesel			Belt - Fan, Alt. & Hub		
RE			Tensioner Assy. - Fan, Alt. & Hub		
Belt - Accessory Belt Drive Kit		ACK080760HD	Tensioner Pulley - Fan, Alt. & Hub		
Belt - Fan & Alt.	1682697C1	♣K080760HD	Hose - Upper - Eng. To Rad.		
Tensioner Assy. - Fan & Alt.	1830033C1	38514	Hose - Lower - Eng. To Rad.		
Tensioner Pulley - Fan & Alt.	1830033C1	36091	RE		
International/Navistar DT466 Diesel			Belt - Accessory Belt Drive Kit		
3800			Belt - Fan, W.P. & Alt.		
Belt - Accessory Belt Drive Kit		ACK080726HD	Tensioner Assy. - Fan, W.P. & Alt.		
Belt - Fan, Alt. & Hub	1822503C1	♣K080726HD	International/Navistar T444 Diesel		
Tensioner Assy. - Fan, Alt. & Hub	1830033C1	38514	3400		
Tensioner Pulley - Fan, Alt. & Hub	1830033C1	36091	Idler Pulley; W/Flat Idler Pulley		
Hose - Upper - Eng. To Rad.		22140	Idler Pulley; W/V-Groove Idler Pulley		
Hose - Lower - Eng. To Rad.		20987	3800		
CE			Belt - Accessory Belt Drive Kit; W/Air Brake Compr.		
Belt - Accessory Belt Drive Kit - Fan, Alt. & Hub		ACK080690HD	Belt - Accessory Belt Drive Kit; W/O Air Brake Compr.		
Belt - Fan, Alt. & Hub	1830727C1	♣K080690HD	Belt - W.P., Fan & Alt.; W/Air Brake Compr.		

♣Standard Belt Available.

≡Cut to Fit.

School Buses

Belts and Coolant Hose for School Buses

School Buses

Application	Mfr. Part No.	Our No.	Application	Mfr. Part No.	Our No.
International/Navistar - Continued			International/Navistar - Continued		
2000 - Continued			1998 - Continued		
International/Navistar T444 Diesel - Continued			International/Navistar DT466 Diesel - Continued		
3800 - Continued			3800 - Continued		
Belt - W.P., Fan & Alt.; W/O Air Brake Compr.	1822830C1	♣K080893HD	Hose - Upper - Eng. To Rad.		22140
Tensioner Assy.	1822679C3	38510	Hose - Lower		22762
Idler Pulley; W/Flat Idler Pulley	1822652C91	36287	Hose - By Pass		21457
Idler Pulley; W/Multi-Grooved Idler Pulley ...	1822653C91	36288	RE		
Hose - Upper - Rad. To Eng.		22159	Belt - Accessory Belt Drive Kit		ACK080842HD
Hose - Lower - Eng. To Pipe		22782	Belt - Fan, W.P. & Alt.	1842464C1	♣K080842HD
1999			Tensioner Assy. - Fan, W.P. & Alt.	1841760C1	38620
International/Navistar 530 Diesel			International/Navistar T444 Diesel		
RE			3400		
Belt - Accessory Belt Drive Kit		ACK080760HD	Belt - Serpentine	1822832C1	♣K081124HD
Belt - Fan & Alt.	1682697C1	♣K080760HD	Idler Pulley; W/Flat Idler Pulley	1822652C91	36287
Tensioner Assy. - Fan & Alt.	1830033C1	38514	Idler Pulley; W/V-Groove Idler Pulley	1822653C91	36288
Tensioner Pulley - Fan & Alt.	1830033C1	36091	Hose - Upper		22159
International/Navistar DT466 Diesel			3600		
3800			Idler Pulley; W/Flat Idler Pulley		
Belt - Serpentine	1819391C1	♣K080730HD	Idler Pulley; W/V-Groove Idler Pulley	1822652C91	36287
Belt - Accessory Belt Drive Kit		ACK080730HD	Idler Pulley; W/V-Groove Idler Pulley	1822653C91	36288
Tensioner Assy.	1830033C1	38514	3800		
Tensioner Pulley	1830033C1	36091	Belt - Accessory Belt Drive Kit; W/Air Brake Compr.		ACK081124HD
Hose - Upper - Eng. To Rad.		22140	Belt - Accessory Belt Drive Kit; W/O Air Brake Compr.		ACK080893HD
Hose - Lower - Eng. To Rad.		22762	Belt - W.P., Fan & Alt.; W/Air Brake Compr.	1822832C1	♣K081124HD
RE			Belt - W.P., Fan & Alt.; W/O Air Brake Compr.		
Belt - Accessory Belt Drive Kit		ACK080842HD	Compr.	1822830C1	♣K080893HD
Belt - Fan, W.P. & Alt.	1842464C1	♣K080842HD	Tensioner Assy.	1822679C3	38510
Tensioner Assy. - Fan, W.P. & Alt.	1841760C1	38620	Idler Pulley; W/Flat Idler Pulley	1822652C91	36287
International/Navistar T444 Diesel			Idler Pulley; W/Multi-Grooved Idler Pulley ...	1822653C91	36288
3400			Hose - Lower - Eng. To Rad.		22671
Belt - Serpentine	1822832C1	♣K081124HD	1997		
Idler Pulley; W/Flat Idler Pulley	1822652C91	36287	International/Navistar 530 Diesel		
Idler Pulley; W/V-Groove Idler Pulley	1822653C91	36288	RE		
Hose - Upper		22159	Belt - Accessory Belt Drive Kit		
Hose - Lower - Eng. To Rad.		22843	Belt - Fan & Alt.		
3600			Tensioner Assy. - Fan & Alt.		
Idler Pulley; W/Flat Idler Pulley	1822652C91	36287	Tensioner Pulley - Fan & Alt.		
Idler Pulley; W/V-Groove Idler Pulley	1822653C91	36288	International/Navistar DT466 Diesel		
3800			3600		
Belt - Accessory Belt Drive Kit; W/Air Brake Compr.		ACK081124HD	Belt - Serpentine		
Belt - Accessory Belt Drive Kit; W/O Air Brake Compr.		ACK080893HD	Belt - Serpentine		
Belt - W.P., Fan & Alt.; W/Air Brake Compr.	1822832C1	♣K081124HD	Hose - Upper - Eng. To Rad.		
Belt - W.P., Fan & Alt.; W/O Air Brake Compr.	1822830C1	♣K080893HD	Hose - Lower - Eng. To Rad.		
Belt - A.C.; W/Aux. A.C.		♣K081265HD	International/Navistar T444 Diesel		
Tensioner Assy.	1822679C3	38510	3000FE		
Idler Pulley; W/Flat Idler Pulley	1822652C91	36287	Idler Pulley; W/Flat Idler Pulley		
Idler Pulley; W/Multi-Grooved Idler Pulley ...	1822653C91	36288	Idler Pulley; W/V-Groove Idler Pulley		
Hose - Lower - Eng. To Rad.		22843	3400		
1998			Belt - Serpentine		
International/Navistar 530 Diesel			Idler Pulley; W/Flat Idler Pulley		
RE			Idler Pulley; W/V-Groove Idler Pulley		
Belt - Accessory Belt Drive Kit			Hose - Upper		
Belt - Fan & Alt.			3600		
Tensioner Assy. - Fan & Alt.			Idler Pulley; W/Flat Idler Pulley		
Tensioner Pulley - Fan & Alt.			Idler Pulley; W/V-Groove Idler Pulley		
International/Navistar DT466 Diesel			3800		
3800			Belt - Accessory Belt Drive Kit; W/Air Brake Compr.		
Belt - Serpentine	1819391C1	♣K080730HD	Belt - Accessory Belt Drive Kit; W/O Air Brake Compr.		
Belt - Accessory Belt Drive Kit		ACK080730HD	Belt - W.P., Fan & Alt.; W/Air Brake Compr.		
Tensioner Assy.	1830033C1	38514	Belt - W.P., Fan & Alt.; W/O Air Brake Compr.		
Tensioner Pulley	1830033C1	36091	Compr.		
International/Navistar DT466 Diesel			Tensioner Assy.		
3800			Idler Pulley; W/Flat Idler Pulley		
Belt - Serpentine	1819391C1	♣K080730HD	Idler Pulley; W/Multi-Grooved Idler Pulley ...		
Belt - Accessory Belt Drive Kit		ACK080730HD	International/Navistar T444 Diesel		
Tensioner Assy.	1830033C1	38514	3000FE		
Tensioner Pulley	1830033C1	36091	Idler Pulley; W/Flat Idler Pulley		

♣Standard Belt Available.

Belts and Coolant Hose for School Buses

Application	Mfr. Part No.	Our No.	Application	Mfr. Part No.	Our No.
International/Navistar - Continued			International/Navistar - Continued		
1997 - Continued			1995 - Continued		
International/Navistar T444 Diesel - Continued			International/Navistar T444 Diesel - Continued		
3800 - Continued			3700 - Continued		
Hose - Lower - Eng. To Rad. 22671			Belt - Fan & P.S.; W/Eaton, Ross P.S. Pump; Preferred Belt 2/9570PB		
1996			Belt - Fan & P.S.; W/Eaton, Ross P.S. Pump; Optional Belt ②▲9570HD		
International/Navistar DT466 Diesel			Belt - Fan & P.S.; W/Vickers P.S. Pump 446950C1 ②▲9585HD		
3600			Belt - Fan & P.S.; W/60 1/2" Belt O.C. ②▲9600HD		
Belt - Serpentine 1682696C1 ▲K080738HD			Belt - Fan & P.S.; W/62" Belt O.C. ②▲9620HD		
3800			Belt - P.S., A.C. & Idler ▲9720HD		
Belt - Serpentine 1841575C1 ▲K080730HD			Belt - Air Brake Compr. 339700C2 ▲9565HD		
Belt - Accessory Belt Drive Kit ACK080730HD			Hose - Upper 21454		
Tensioner Assy. 1830033C2 38514			Hose - Lower 21455		
Hose - Upper 22140			3800		
Hose - Lower ≍21115			Belt - W.P., Fan & Alt.; W/Air Brake Compr. .1822832C1 ▲K081124HD		
International/Navistar T444 Diesel			Belt - W.P., Fan & Alt.; W/O Air Brake Compr. 1822830C1 ▲K080893HD		
3000FE			Tensioner Assy. 1822679C3 38510		
Idler Pulley; W/Flat Idler Pulley 1822652C91 36287			Hose - Upper 22159		
Idler Pulley; W/V-Groove Idler Pulley 1822653C91 36288			1994		
3400			International/Navistar DT360 Diesel		
Belt - Serpentine 1822831C2 ▲K081000HD			3600		
Idler Pulley; W/Flat Idler Pulley 1822652C91 36287			Belt - Fan & Alt.; W/71 1/4" Belt O.C.; Preferred Belt 1812743C1 2/9700PB		
Idler Pulley; W/V-Groove Idler Pulley 1822653C91 36288			Belt - Fan & Alt.; W/71 1/4" Belt O.C.; Optional Belt 1812743C1 ②▲9700HD		
Hose - Upper 22159			Belt - Fan & Air Brake Compr.; W/50" Belt O.C. 168128R1 TR22495		
3600			Hose - Upper ≍21765		
Idler Pulley; W/Flat Idler Pulley 1822652C91 36287			Hose - Lower ≍21842		
Idler Pulley; W/V-Groove Idler Pulley 1822653C91 36288			Hose - By Pass 21461		
3800			3800		
Belt - Accessory Belt Drive Kit; W/Air Brake Compr. ACK081124HD			Belt - Fan & Alt.; W/71 1/4" Belt O.C.; Preferred Belt 1812743C1 2/9700PB		
Belt - Accessory Belt Drive Kit; W/O Air Brake Compr. ACK080893HD			Belt - Fan & Alt.; W/71 1/4" Belt O.C.; Optional Belt 1812743C1 ②▲9700HD		
Belt - W.P., Fan & Alt.; W/Air Brake Compr. .1822832C1 ▲K081124HD			Belt - Fan & Air Brake Compr.; W/50" Belt O.C. 168128R1 TR22495		
Belt - W.P., Fan & Alt.; W/O Air Brake Compr. 1822830C1 ▲K080893HD			Belt - Fan & Air Brake Compr.; W/77 5/8" Belt O.C. 1803172C1 TR22770		
Tensioner Assy. 1822679C3 38510			Belt - A.C. 201825R2 ▲9435HD		
Idler Pulley; W/Flat Idler Pulley 1822652C91 36287			Hose - Upper ≍21765		
Idler Pulley; W/Multi-Grooved Idler Pulley ... 1822653C91 36288			Hose - Lower ≍21842		
Hose - Upper 22159			Hose - By Pass 21461		
Hose - Lower - Eng. To Rad. 22671			International/Navistar DT408 Diesel		
1995			3800		
International/Navistar DT466 Diesel			Belt - Fan & Alt. 1819988C2 ▲K080745HD		
3600			Tensioner Assy. - Fan & Alt. 1830033C2 38514		
Belt - Fan & Alt. 1682696C1 ▲K080738HD			Tensioner Pulley - Fan & Alt. 1830033C2 36091		
Tensioner Assy. - Fan & Alt. 1814719C1 38514			International/Navistar DT466 Diesel		
Tensioner Assy. - Fan To A.C. 1687819C91 38511			3600		
Tensioner Pulley - Fan & Alt. 1814719C1 36091			Belt - Fan & Alt. ②▲◆9690HD		
Tensioner Pulley - Fan To A.C. 1687819C91 36091			Belt - Fan & Air Brake Compr. 1812519C1 TR22770		
Hose - Upper - Eng. To Rad. 22059			Hose - Upper - Eng. To Rad. 22059		
Hose - Lower - Eng. To Rad. 21115			3700; 3800; 3900FC		
3700			Belt - Fan & Alt. ②▲◆9690HD		
Belt - Serpentine 1682696C1 ▲K080738HD			Belt - Fan & Air Brake Compr. 1812519C1 TR22770		
3800			International/Navistar V-8 7.3 L Diesel		
Belt - Serpentine 1841575C1 ▲K080730HD			3700		
Tensioner Assy. 1830033C2 38514			Belt - Fan & Alt.; W/A.C. 1803209C1 ②7575		
Hose - Upper 22140			Belt - Fan & Alt.; W/O A.C. 1803207C1 7520		
Hose - Lower ≍21115			Belt - Fan & P.S.; W/Eaton, Ross P.S. Pump; Preferred Belt 2/9570PB		
Hose - Pipe To Intercooler (Cold Side) 26201			Belt - Fan & P.S.; W/Eaton, Ross P.S. Pump; Optional Belt ②▲9570HD		
Hose - Pipe To Intercooler (Hot Side) 26201					
Hose - Turbo To Pipe (Hot Side) 26201					
3900FC					
Belt - Serpentine 1682696C1 ▲K080738HD					
International/Navistar T444 Diesel					
3700					
Belt - Fan & Alt.; W/A.C. 1803209C1 ②7575					
Belt - Fan & Alt.; W/O A.C. 1803207C1 7520					

▲Standard Belt Available.
②Two Required.

≍Cut to Fit.
◆PowerBand Belt May Work, Use Template to Check.

School Buses

Belts and Coolant Hose for School Buses

School Buses

Application	Mfr. Part No.	Our No.	Application	Mfr. Part No.	Our No.
International/Navistar - Continued			International/Navistar - Continued		
1994 - Continued			1993 - Continued		
International/Navistar V-8 7.3 L Diesel - Continued			International/Navistar DT466 Diesel - Continued		
3700 - Continued			3800 - Continued		
Belt - Fan & P.S.; W/Vickers P.S. Pump	446950C1	②◆◆9585HD	Belt - Fan & Air Brake Compr.; W/50" Belt O.C.		TR22495
Belt - Fan & P.S.; W/60 1/2" Belt O.C.		②◆◆9600HD	Belt - Fan & Air Brake Compr.; W/77" Belt O.C.	1812519C1	TR22770
Belt - Fan & P.S.; W/62" Belt O.C.		②◆◆9620HD	Hose - Upper		21372
Belt - P.S., A.C. & Idler		◆9720HD	Hose - Lower		21842
Belt - Air Brake Compr.	339700C2	◆9565HD	Hose - By Pass		≈<21457
Hose - Upper		21454	3900FC		
Hose - Lower		21455	Belt - Fan & Alt.; W/69 1/2" Belt O.C.	1810680C1	②◆◆◆9690HD
3800			Belt - Fan & Alt.; W/70 1/4" Belt O.C.	1812743C1	②◆◆◆9700HD
Belt - Serpentine	1822832C1	◆K081124HD	Belt - Fan & Air Brake Compr.; W/50" Belt O.C.		TR22495
			Belt - Fan & Air Brake Compr.; W/77" Belt O.C.	1812519C1	TR22770
1993			Hose - Upper		≈<21765
International/Navistar DT360 Diesel			Hose - Lower		≈<21842
3600; 3700			Hose - By Pass		≈<21457
Belt - Fan & Alt.; W/71 1/4" Belt O.C.; Preferred Belt	1812743C1	2/9700PB	International/Navistar V-8 7.3 L Diesel		
Belt - Fan & Alt.; W/71 1/4" Belt O.C.; Optional Belt	1812743C1	②◆◆9700HD	3600		
Belt - Fan & Air Brake Compr.; W/50" Belt O.C.	168128R1	TR22495	Hose - Lower		
Hose - Upper		≈<21765	3700		
Hose - Lower		≈<21842	Belt - Fan & Alt.; W/A.C.		
Hose - By Pass		21461	Belt - Fan & Alt.; W/O A.C.		
3800			Belt - Fan & P.S.; W/Eaton, Ross P.S. Pump; Preferred Belt		
Belt - Fan & Alt.; W/71 1/4" Belt O.C.; Preferred Belt	1812743C1	2/9700PB	Belt - Fan & P.S.; W/Eaton, Ross P.S. Pump; Optional Belt		
Belt - Fan & Alt.; W/71 1/4" Belt O.C.; Optional Belt	1812743C1	②◆◆9700HD	Belt - Fan & P.S.; W/Vickers P.S. Pump		
Belt - Fan & Air Brake Compr.; W/50" Belt O.C.	168128R1	TR22495	Belt - Fan & P.S.; W/60 1/2" Belt O.C.		
Belt - Fan & Air Brake Compr.; W/77 5/8" Belt O.C.	1803172C1	TR22770	Belt - Fan & P.S.; W/62" Belt O.C.		
Belt - A.C.	201825R2	◆9435HD	Belt - P.S., A.C. & Idler		
Hose - Upper		≈<21765	Belt - Air Brake Compr.		
Hose - Lower		≈<21842	Hose - Upper		
Hose - By Pass		21461	Hose - Lower		
3900FC			1992 - 1991		
Belt - Fan & Alt.; W/71 1/4" Belt O.C.; Preferred Belt	1812743C1	2/9700PB	International/Navistar DT360 Diesel		
Belt - Fan & Alt.; W/71 1/4" Belt O.C.; Optional Belt	1812743C1	②◆◆9700HD	3600; 3700		
Belt - Fan & Air Brake Compr.; W/50" Belt O.C.	168128R1	TR22495	Belt - Fan & Alt.; W/71 1/4" Belt O.C.; Preferred Belt		
Hose - Upper		≈<21765	Belt - Fan & Alt.; W/71 1/4" Belt O.C.; Optional Belt		
Hose - Lower		≈<21842	Belt - Fan & Air Brake Compr.; W/50" Belt O.C.		
Hose - By Pass		21461	Belt - Fan & Air Brake Compr.; W/77 5/8" Belt O.C.		
3900FC			Belt - A.C.		
Belt - Fan & Alt.; W/69 1/2" Belt O.C.	1810680C1	②◆◆◆9690HD	Hose - Upper		
Belt - Fan & Alt.; W/70 1/4" Belt O.C.	1812743C1	②◆◆◆9700HD	Hose - Lower		
Belt - Fan & Air Brake Compr.; W/50" Belt O.C.		TR22495	Hose - By Pass		
Belt - Fan & Air Brake Compr.; W/77" Belt O.C.	1812519C1	TR22770	3900FC		
Hose - Upper - Eng. To Rad.		22059	Belt - Fan & Alt.; W/71 1/4" Belt O.C.; Preferred Belt		
Hose - Lower		21842	Belt - Fan & Alt.; W/71 1/4" Belt O.C.; Optional Belt		
Hose - By Pass		≈<21457	Belt - Fan & Air Brake Compr.; W/50" Belt O.C.		
3700			Belt - Fan & Air Brake Compr.; W/77 5/8" Belt O.C.		
Belt - Fan & Alt.; W/69 1/2" Belt O.C.	1810680C1	②◆◆◆9690HD	Belt - A.C.		
Belt - Fan & Alt.; W/70 1/4" Belt O.C.	1812743C1	②◆◆◆9700HD	Hose - Upper		
Belt - Fan & Air Brake Compr.; W/50" Belt O.C.		TR22495	Hose - Lower		
Belt - Fan & Air Brake Compr.; W/77" Belt O.C.	1812519C1	TR22770	Hose - By Pass		
Hose - By Pass		≈<21457	3900FC		
3800			Belt - Fan & Alt.; W/71 1/4" Belt O.C.; Preferred Belt		
Belt - Fan & Alt.; W/69 1/2" Belt O.C.	1810680C1	②◆◆◆9690HD	Belt - Fan & Alt.; W/71 1/4" Belt O.C.; Optional Belt		
Belt - Fan & Alt.; W/70 1/4" Belt O.C.	1812743C1	②◆◆◆9700HD	Belt - Fan & Air Brake Compr.; W/50" Belt O.C.		
Belt - Fan & Air Brake Compr.; W/50" Belt O.C.		TR22495	Belt - Fan & Air Brake Compr.; W/77 5/8" Belt O.C.		
Belt - Fan & Air Brake Compr.; W/77" Belt O.C.	1812519C1	TR22770	Belt - A.C.		
Hose - By Pass		≈<21457	Hose - Upper		
3800			Hose - Lower		
Belt - Fan & Alt.; W/69 1/2" Belt O.C.	1810680C1	②◆◆◆9690HD	Hose - By Pass		
Belt - Fan & Alt.; W/70 1/4" Belt O.C.	1812743C1	②◆◆◆9700HD	3900FC		
			Belt - Fan & Alt.; W/71 1/4" Belt O.C.; Preferred Belt		
			Belt - Fan & Alt.; W/71 1/4" Belt O.C.; Optional Belt		
			Belt - Fan & Air Brake Compr.; W/50" Belt O.C.		
			Belt - Fan & Air Brake Compr.; W/77 5/8" Belt O.C.		
			Belt - A.C.		
			Hose - Upper		
			Hose - Lower		
			Hose - By Pass		

◆Standard Belt Available.
≈<Cut to Fit.

②Two Required.
◆PowerBand Belt May Work, Use Template to Check.

Belts and Coolant Hose for School Buses

Application	Mfr. Part No.	Our No.	Application	Mfr. Part No.	Our No.
International/Navistar - Continued			International/Navistar - Continued		
1992 - 1991 - Continued			1990 - Continued		
International/Navistar DT360 Diesel - Continued			International/Navistar V-8 7.3 L Diesel		
3900FC - Continued			3700		
Hose - Lower		≠21842	Belt - Fan & Alt.; W/A.C.	1803209C1	②7575
Hose - By Pass		21461	Belt - Fan & Alt.; W/O A.C.	1803207C1	7520
International/Navistar DT466 Diesel			Belt - Fan & P.S.; W/Eaton, Ross P.S. Pump; Preferred Belt		
3600; 3700; 3800; 3900FC			2/9570PB		
Belt - Fan & Alt.; W/69 1/2" Belt O.C.	1810680C1	②◆◆9690HD	Belt - Fan & P.S.; W/Eaton, Ross P.S. Pump; Optional Belt		②◆9570HD
Belt - Fan & Alt.; W/70 1/4" Belt O.C.	1812743C1	②◆◆9700HD	Belt - Fan & P.S.; W/Vickers P.S. Pump	446950C1	②◆9585HD
Belt - Fan & Air Brake Compr.; W/50" Belt O.C.		TR22495	Belt - Fan & P.S.; W/60 1/2" Belt O.C.		②◆9600HD
Belt - Fan & Air Brake Compr.; W/77" Belt O.C.	1812519C1	TR22770	Belt - Fan & P.S.; W/62" Belt O.C.		②◆9620HD
Hose - Upper; W/Aftercooler		21372	Belt - P.S., A.C. & Idler		◆9720HD
Hose - Upper; W/O Aftercooler		21765	Belt - Air Brake Compr.	339700C2	◆9565HD
Hose - Lower		≠21842	Hose - Upper		21454
Hose - By Pass; Ser. No. 567491 & Before		21461	Hose - Lower		21455
Hose - By Pass; Ser. No. 567492 & After		≠21457	1989		
Hose - Reservoir To Eng.		24220	International/Navistar DT360 Diesel		
Hose - Heater Inlet		28442	1853		
Hose - Heater Outlet		28441	Belt - Fan & Alt.; W/71 5/8" Belt O.C.		
International/Navistar V-8 7.3 L Diesel			1812743C1		
3600			②◆◆9710HD		
Hose - Lower		21455	Belt - Fan & Alt.; W/69 5/8" Belt O.C.		
3700			1810886C1		
Belt - Fan & Alt.; W/A.C.	1803209C1	②7575	Belt - Fan & Air Brake Compr.		
Belt - Fan & Alt.; W/O A.C.	1803207C1	7520	1803172C1		
Belt - Fan & P.S.; W/Eaton, Ross P.S. Pump; Preferred Belt		2/9570PB	Belt - A.C.		
Belt - Fan & P.S.; W/Eaton, Ross P.S. Pump; Optional Belt		②◆9570HD	133758R2		
Belt - Fan & P.S.; W/Vickers P.S. Pump	446950C1	②◆9585HD	Belt - V.P.		
Belt - Fan & P.S.; W/60 1/2" Belt O.C.		②◆9600HD	Hose - Upper		
Belt - Fan & P.S.; W/62" Belt O.C.		②◆9620HD	≠21765		
Belt - P.S., A.C. & Idler		◆9720HD	Hose - Lower		
Belt - Air Brake Compr.	339700C2	◆9565HD	≠21766		
Hose - Upper		21454	International/Navistar V-8 7.3 L Diesel		
Hose - Lower		21455	1753		
1990			Belt - Fan & Alt.; W/52 1/8" Belt O.C.		
International/Navistar DT360 Diesel			1803207C1		
3800			②7520		
Belt - Fan & Alt.; W/69 1/2" Belt O.C.	1810886C1	②◆◆9690HD	Belt - Fan & Alt.; W/57 5/8" Belt O.C.		
Belt - Fan & Alt.; W/71 1/4" Belt O.C.	1812743C1	②◆◆9700HD	1803209C1		
Belt - Fan & Air Brake Compr.; W/50" Belt O.C.	168128R1	TR22495	Belt - Fan & P.S.; W/A.C.		
Belt - Fan & Air Brake Compr.; W/77 5/8" Belt O.C.	1803172C1	TR22770	Belt - Fan & P.S.; W/O A.C.		
Belt - A.C.	201825R2	◆9435HD	479217C1		
Hose - Upper		≠21765	Belt - P.S. & A.C.		
Hose - Lower		≠21842	Belt - Air Brake Compr.		
Hose - By Pass		21461	Hose - Upper		
International/Navistar DT466 Diesel			21454		
3800			21455		
Belt - Fan & Alt.; W/69 1/2" Belt O.C.	1810680C1	②◆◆9690HD	1988		
Belt - Fan & Alt.; W/70 1/4" Belt O.C.		②◆◆9700HD	International/Navistar DT360 Diesel		
Belt - Fan & Air Brake Compr.; W/1 To 1 Fan Ratio	1812519C1	TR22770	1853		
Belt - Fan & Air Brake Compr.; W/1.2 To 1 Fan Ratio	1814927C1	TR22792	Belt - Fan & Alt.; W/71 5/8" Belt O.C.		
Hose - Upper; W/Aftercooler		21372	1812743C1		
Hose - Upper; W/O Aftercooler		21765	②◆◆9710HD		
Hose - Lower		≠21842	Belt - Fan & Alt.; W/69 5/8" Belt O.C.		
Hose - By Pass; Ser. No. 567491 & Before		21461	1810886C1		
Hose - By Pass; Ser. No. 567492 & After		≠21457	Belt - Fan & Air Brake Compr.		
Hose - Reservoir To Eng.		24220	1803172C1		
Hose - Heater Inlet		28442	Belt - A.C.		
Hose - Heater Outlet		28441	133758R2		
International/Navistar DT466 Diesel			Belt - V.P.		
3800			Hose - Upper		
Belt - Fan & Alt.; W/69 1/2" Belt O.C.	1810680C1	②◆◆9690HD	≠21765		
Belt - Fan & Alt.; W/70 1/4" Belt O.C.		②◆◆9700HD	Hose - Lower		
Belt - Fan & Air Brake Compr.; W/1 To 1 Fan Ratio	1812519C1	TR22770	≠21766		
Belt - Fan & Air Brake Compr.; W/1.2 To 1 Fan Ratio	1814927C1	TR22792	International/Navistar DT466 Diesel		
Hose - Upper; W/Aftercooler		21372	1853		
Hose - Upper; W/O Aftercooler		21765	Belt - Fan & Alt.; W/65 1/4" Belt O.C.		
Hose - Lower		≠21842	②◆◆9650HD		
Hose - By Pass; Ser. No. 567491 & Before		21461	Belt - Fan & Alt.; W/69 1/2" Belt O.C.		
Hose - By Pass; Ser. No. 567492 & After		≠21457	1810680C1		
Hose - Reservoir To Eng.		24220	Belt - Fan & Alt.; W/70 1/4" Belt O.C.		
Hose - Heater Inlet		28442	②◆◆9700HD		
Hose - Heater Outlet		28441	Belt - Fan & P.S.		
1990			689444C1		
International/Navistar DT360 Diesel			②◆9745HD		
3800			Belt - Fan & Air Brake Compr.		
Belt - Fan & Alt.; W/69 1/2" Belt O.C.	1810680C1	②◆◆9690HD	1812519C1		
Belt - Fan & Alt.; W/70 1/4" Belt O.C.		②◆◆9700HD	Belt - Fan To Air Brake Compr.		
Belt - Fan & Air Brake Compr.; W/1 To 1 Fan Ratio	1812519C1	TR22770	◆9485HD		
Belt - Fan & Air Brake Compr.; W/1.2 To 1 Fan Ratio	1814927C1	TR22792	Belt - P.S.		
Hose - Upper; W/Aftercooler		21372	429274C91		
Hose - Upper; W/O Aftercooler		21765	Belt - V.P.		
Hose - Lower		≠21842	190502R2		
Hose - By Pass; Ser. No. 567491 & Before		21461	Belt - A.C.		
Hose - By Pass; Ser. No. 567492 & After		≠21457	133758R2		
Hose - Reservoir To Eng.		24220	Hose - Upper; W/Aftercooler		
Hose - Heater Inlet		28442	21372		
Hose - Heater Outlet		28441	Hose - Upper; W/O Aftercooler		
1990			21765		
International/Navistar DT360 Diesel			Hose - Lower		
3800			≠21842		
Belt - Fan & Alt.; W/69 1/2" Belt O.C.	1810680C1	②◆◆9690HD	Hose - By Pass		
Belt - Fan & Alt.; W/70 1/4" Belt O.C.		②◆◆9700HD	21258		
Belt - Fan & Air Brake Compr.; W/1 To 1 Fan Ratio	1812519C1	TR22770	Hose - Reservoir To Eng.		
Belt - Fan & Air Brake Compr.; W/1.2 To 1 Fan Ratio	1814927C1	TR22792	24220		
Hose - Upper; W/Aftercooler		21372	Hose - Heater Inlet		
Hose - Upper; W/O Aftercooler		21765	28442		
Hose - Lower		≠21842	Hose - Heater Outlet		
Hose - By Pass; Ser. No. 567491 & Before		21461	28441		
Hose - By Pass; Ser. No. 567492 & After		≠21457			
Hose - Reservoir To Eng.		24220			
Hose - Heater Inlet		28442			
Hose - Heater Outlet		28441			

School Buses

◆Standard Belt Available.
②Two Required.

◆PowerBand Belt May Work, Use Template to Check.
≠Cut to Fit.

Belts and Coolant Hose for School Buses

School Buses

Application	Mfr. Part No.	Our No.	Application	Mfr. Part No.	Our No.
International/Navistar - Continued			International/Navistar - Continued		
1988 - Continued			1987 - Continued		
International/Navistar V-8 6.9 L Diesel			International/Navistar V-8 6.9 L Diesel		
1753			1753		
Belt - Fan & Alt.; W/52 1/8" Belt O.C.	1803207C1	②7520	Belt - Fan & Alt.; W/52 1/8" Belt O.C.	1803207C1	②7520
Belt - Fan & Alt.; W/57 5/8" Belt O.C.	1803209C1	②7575	Belt - Fan & Alt.; W/57 5/8" Belt O.C.	1803209C1	②7575
Belt - Fan & P.S.; W/A.C.		▲9590HD	Belt - Fan & P.S.; W/A.C.		▲9590HD
Belt - Fan & P.S.; W/O A.C.	479217C1	②▲9635HD	Belt - Fan & P.S.; W/O A.C.	479217C1	②▲9635HD
Belt - P.S. & A.C.		▲9740HD	Belt - P.S. & A.C.		▲9740HD
Belt - Air Brake Compr.		▲9560HD	Belt - Air Brake Compr.		▲9560HD
Hose - Upper		21454	Hose - Upper		21454
Hose - Lower		21455	Hose - Lower		21455
International/Navistar V-8 7.3 L Diesel			International/Navistar V-8 9.0 L Diesel		
1753			1853		
Belt - Fan & Alt.; W/52 1/8" Belt O.C.	1803207C1	②7520	Belt - Fan & W.P.		②▲▲9570HD
Belt - Fan & Alt.; W/57 5/8" Belt O.C.	1803209C1	②7575	Belt - Fan, Alt. & Air Brake Compr.	489324C1	②7485
Belt - Fan & P.S.; W/A.C.		▲9640HD	Belt - Fan, Alt. & V.P.; W/O A.C.		②7603
Belt - Fan & P.S.; W/O A.C.	479217C1	②▲9635HD	Belt - Fan To Alt. & Air Brake Compr.	1806180C91	②7585
Belt - P.S. & A.C.		▲9740HD	Belt - Fan To Alt. & A.C.; W/O Air Brakes		7480
Belt - Air Brake Compr.		▲9560HD	Belt - Alt.	132058R3	②7350
Hose - Upper		21454	Belt - P.S.; W/Eaton P.S. Pump		②7535
Hose - Lower		21455	Belt - P.S.; W/Rexroth P.S. Pump		②7650
International/Navistar V-8 9.0 L Diesel			International/Navistar V-8 9.0 L Diesel		
1853			1853		
Belt - Fan & W.P.		②▲▲9570HD	Belt - Fan & Alt.; W/65 1/4" Belt O.C.		②▲▲9650HD
Belt - Fan, Alt. & Air Brake Compr.	489324C1	②7485	Belt - Fan & Alt.; W/69 1/2" Belt O.C.	1810680C1	②▲▲9690HD
Belt - Fan, Alt. & V.P.; W/O A.C.		②7603	Belt - Fan & Alt.; W/70 1/4" Belt O.C.		②▲▲9700HD
Belt - Fan To Alt. & Air Brake Compr.	1806180C91	②7585	Belt - Fan & P.S.	689444C1	②▲9745HD
Belt - Fan To Alt. & A.C.; W/O Air Brakes		7480	Belt - Fan & Air Brake Compr.	1812519C1	TR22770
Belt - Alt.	132058R3	②7350	Belt - Fan To Air Brake Compr.		▲9485HD
Belt - P.S.; W/Eaton P.S. Pump		②7535	Belt - P.S.	429274C91	②7390
Belt - P.S.; W/Rexroth P.S. Pump		②7650	Belt - V.P.	190502R2	▲9490HD
Belt - P.S.; W/Saginaw P.S. Pump		②7500	Belt - A.C.	133758R2	▲9440HD
Belt - V.P.	864931R2	▲9319HD	Hose - Upper		21372
Hose - Upper		21452			26528
Hose - Lower		21290			or
1987			1986		
International/Navistar DT360 Diesel			International/Navistar DT466 Diesel		
1853			1853		
Belt - Fan & Alt.; W/71 5/8" Belt O.C.	1812743C1	②▲▲9710HD	Belt - Fan & Alt.; W/65 1/4" Belt O.C.		②▲▲9650HD
Belt - Fan & Alt.; W/69 5/8" Belt O.C.	1810886C1	②▲▲9690HD	Belt - Fan & Alt.; W/69 1/2" Belt O.C.	1810680C1	②▲▲9690HD
Belt - Fan & Air Brake Compr.	1803172C1	TR22770	Belt - Fan & Alt.; W/70 1/4" Belt O.C.		②▲▲9700HD
Belt - A.C.	133758R2	▲9440HD	Belt - Fan & P.S.	689444C1	②▲9745HD
Belt - V.P.		▲9490HD	Belt - Fan & Air Brake Compr.	1812519C1	TR22770
Hose - Upper		≈21765	Belt - Fan To Air Brake Compr.		▲9485HD
Hose - Lower		≈21766	Belt - P.S.	429274C91	②7390
International/Navistar DT466 Diesel			International/Navistar V-8 6.9 L Diesel		
1853			1753		
Belt - Fan & Alt.; W/65 1/4" Belt O.C.		②▲▲9650HD	Belt - Fan & Alt.; W/52 1/8" Belt O.C.	1803207C1	②7520
Belt - Fan & Alt.; W/69 1/2" Belt O.C.	1810680C1	②▲▲9690HD	Belt - Fan & Alt.; W/57 5/8" Belt O.C.	1803209C1	②7575
Belt - Fan & Alt.; W/70 1/4" Belt O.C.		②▲▲9700HD	Belt - Fan & P.S.; W/A.C.		▲9590HD
Belt - Fan & P.S.	689444C1	②▲9745HD	Belt - Fan & P.S.; W/O A.C.	479217C1	②▲9635HD
Belt - Fan & Air Brake Compr.	1812519C1	TR22770	Belt - P.S. & A.C.		▲9740HD
Belt - Fan To Air Brake Compr.		▲9485HD	Belt - Air Brake Compr.		▲9560HD
Belt - P.S.	429274C91	②7390	Hose - Upper		21454
Belt - V.P.	190502R2	▲9490HD	Hose - Lower		21455
Belt - A.C.	133758R2	▲9440HD	International/Navistar V-8 9.0 L Diesel		
Hose - Upper; W/Aftercooler		21372	1853		
Hose - Upper; W/O Aftercooler		21765	Belt - Fan & W.P.		②▲▲9570HD
Hose - Lower		≈21842	Belt - Fan, Alt. & Air Brake Compr.	489324C1	②7485
Hose - By Pass		21258	Belt - Fan, Alt. & V.P.; W/O A.C.		②7603
Hose - Reservoir To Eng.		24220	Belt - Fan To Alt. & Air Brake Compr.	1806180C91	②7585
Hose - Heater Inlet		28442	Belt - Fan To Alt. & A.C.; W/O Air Brakes		7480
Hose - Heater Outlet		28441	Belt - Alt.	132058R3	②7350
			Belt - P.S.; W/Eaton P.S. Pump		②7535
			Belt - P.S.; W/Rexroth P.S. Pump		②7650
			Belt - P.S.; W/Saginaw P.S. Pump		②7500
			Belt - V.P.	864931R2	▲9319HD

②Two Required.
◆PowerBand Belt May Work, Use Template to Check.

▲Standard Belt Available.
≈Cut to Fit.

Belts and Coolant Hose for School Buses

Application	Mfr. Part No.	Our No.	Application	Mfr. Part No.	Our No.
International/Navistar - Continued			International/Navistar - Continued		
1986 - Continued			1985 - 1984 - Continued		
International/Navistar V-8 9.0 L Diesel - Continued			International/Navistar V345 - Continued		
1853 - Continued			1723 - Continued		
Hose - Upper		21452	Belt - A.P.; W/O Calif. Emission System; W/O Air Brakes; W/O Gov.	282989C2	7410
Hose - Lower		21290	Hose - Upper		21293
1985 - 1984			Hose - Lower		21292
International/Navistar DT466 Diesel			International/Navistar V392		
1853			1723		
Belt - Fan & Alt.; W/65 1/4" Belt O.C.		②◆◆9650HD	Belt - Fan & Alt.; W/42A., 61A., 65A., 80A., 85A. Alt.	255266C3	②7640
Belt - Fan & Alt.; W/69 1/2" Belt O.C.	1810680C1	②◆◆9690HD	Belt - Fan & Alt.; W/105A., 145A. Alt.	369722C1	②7630
Belt - Fan & Alt.; W/70 1/4" Belt O.C.		②◆◆9700HD	Belt - P.S.	967907R2	②7565
Belt - Fan & P.S.	689444C1	②◆9745HD	Belt - Air Brake Compr.	227703R2	7475
Belt - Fan & Air Brake Compr.	1812519C1	TR22770	Belt - A.C.	284453C2	◆9495HD
Belt - Fan To Air Brake Compr.		◆9485HD	Belt - A.P. - Left Side; W/Calif. Emission System	255810R2	7390
Belt - P.S.	429274C91	②7390	Belt - A.P. - Right Side; W/Calif. Emission System	149636R2	◆9480HD
Belt - V.P.	190502R2	◆9490HD	Belt - A.P.; W/O Calif. Emission System; W/Air Brakes; W/Gov.	182048R1	7360
Belt - A.C.	133758R2	◆9440HD	Belt - A.P.; W/O Calif. Emission System; W/Air Brakes; W/O Gov.	333382C2	7385
Hose - Upper		21372	Belt - A.P.; W/O Calif. Emission System; W/O Air Brakes; W/Gov.	323612C2	7380
or		26528	Belt - A.P.; W/O Calif. Emission System; W/O Air Brakes; W/O Gov.	282989C2	7410
Hose - Lower; Double Dia. Hose; W/3/4" Offset		21766	Hose - Upper		21293
Hose - Lower; Double Dia. Hose; W/2 3/4" Offset		21291	Hose - Lower		21292
Hose - Lower; Single Dia. Hose		21042	1983		
Hose - By Pass		21461	International/Navistar DT466 Diesel		
International/Navistar V-8 6.9 L Diesel			1853		
1753			Belt - Fan & Alt.; W/65 1/4" Belt O.C.		②◆◆9650HD
Belt - Fan & Alt.; W/52 1/8" Belt O.C.	1803207C1	②7520	Belt - Fan & Alt.; W/69 1/2" Belt O.C.	1810680C1	②◆◆9690HD
Belt - Fan & Alt.; W/57 5/8" Belt O.C.	1803209C1	②7575	Belt - Fan & Alt.; W/70 1/4" Belt O.C.		②◆◆9700HD
Belt - Fan & P.S.; W/A.C.		◆9590HD	Belt - Fan & P.S.	689444C1	②◆9745HD
Belt - Fan & P.S.; W/O A.C.	479217C1	②◆9635HD	Belt - Fan & Air Brake Compr.	1812519C1	TR22770
Belt - P.S. & A.C.		◆9740HD	Belt - Fan To Air Brake Compr.		◆9485HD
Belt - Air Brake Compr.		◆9560HD	Belt - P.S.	429274C91	②7390
Hose - Upper		21454	Belt - V.P.	190502R2	◆9490HD
Hose - Lower		21455	Belt - A.C.	133758R2	◆9440HD
International/Navistar V-8 9.0 L Diesel			Hose - Upper		21372
1853			or		26528
Belt - Fan & W.P.		②◆◆9570HD	Hose - Lower; Double Dia. Hose; W/3/4" Offset		21766
Belt - Fan, Alt. & Air Brake Compr.	489324C1	②7485	Hose - Lower; Double Dia. Hose; W/2 3/4" Offset		21291
Belt - Fan, Alt. & V.P.; W/O A.C.		②7603	Hose - Lower; Single Dia. Hose		21042
Belt - Fan To Alt. & Air Brake Compr.	1806180C91	②7585	Hose - By Pass		21461
Belt - Fan To Alt. & A.C.; W/O Air Brakes		7480	1853FC		
Belt - Alt.	132058R3	②7350	Belt - Alt.		③◆9650HD
Belt - P.S.; W/Eaton P.S. Pump		②7535	Belt - P.S.	358328C91	②◆◆9463HD
Belt - P.S.; W/Rexroth P.S. Pump		②7650	Belt - Air Brake Compr.		◆9490HD
Belt - P.S.; W/Saginaw P.S. Pump		②7500	Belt - V.P.	190502R2	◆9490HD
Belt - V.P.	864931R2	◆9319HD	Hose - Lower		≈21291
Hose - Upper		21452	International/Navistar V-8 6.9 L Diesel		
Hose - Lower		21290	1753		
International/Navistar V345			Belt - Fan & Alt.; W/52 1/8" Belt O.C.	1803207C1	②7520
1723			Belt - Fan & Alt.; W/57 5/8" Belt O.C.	1803209C1	②7575
Belt - Fan & Alt.; W/42A., 61A., 65A., 80A., 85A. Alt.	255266C3	②7640	Belt - Fan & P.S.; W/A.C.		◆9590HD
Belt - Fan & Alt.; W/105A., 145A. Alt.	369722C1	②7630	Belt - Fan & P.S.; W/O A.C.	479217C1	②◆9635HD
Belt - P.S.	967907R2	②7565	Belt - P.S. & A.C.		◆9740HD
Belt - Air Brake Compr.	227703R2	7475	Belt - Air Brake Compr.		◆9560HD
Belt - A.C.	284453C2	◆9495HD	Hose - Upper		21454
Belt - A.P. - Left Side; W/Calif. Emission System	255810R2	7390	Hose - Lower		21455
Belt - A.P. - Right Side; W/Calif. Emission System	149636R2	◆9480HD	International/Navistar V-8 9.0 L Diesel		
Belt - A.P.; W/O Calif. Emission System; W/Air Brakes; W/Gov.	182048R1	7360	1853		
Belt - A.P.; W/O Calif. Emission System; W/Air Brakes; W/O Gov.	333382C2	7385	Belt - Fan & W.P.		
Belt - A.P.; W/O Calif. Emission System; W/O Air Brakes; W/Gov.	323612C2	7380			②◆◆9570HD

◆Standard Belt Available.
②Two Required.
≈Cut to Fit.

◆PowerBand Belt May Work, Use Template to Check.
③Three Required.

Belts and Coolant Hose for School Buses

School Buses

Application	Mfr. Part No.	Our No.
International/Navistar - Continued		
1983 - Continued		
International/Navistar V-8 9.0 L Diesel - Continued		
1853 - Continued		
Belt - Fan, Alt. & Air Brake Compr.	489324C1	②7485
Belt - Fan, Alt. & V.P.; W/O A.C.		②7603
Belt - Fan To Alt. & Air Brake Compr.	1806180C91	②7585
Belt - Fan To Alt. & A.C.; W/O Air Brakes		7480
Belt - Alt.	132058R3	②7350
Belt - P.S.; W/Eaton P.S. Pump		②7535
Belt - P.S.; W/Rexroth P.S. Pump		②7650
Belt - P.S.; W/Saginaw P.S. Pump		②7500
Belt - V.P.	864931R2	♣9319HD
Hose - Upper		21452
Hose - Lower		21290
International/Navistar V345		
1723; 1823		
Belt - Fan & Alt.; W/42A., 61A., 65A., 80A., 85A. Alt.	255266C3	②7640
Belt - Fan & Alt.; W/105A., 145A. Alt.	369722C1	②7630
Belt - P.S.	967907R2	②7565
Belt - Air Brake Compr.	227703R2	7475
Belt - A.C.	284453C2	♣9495HD
Belt - A.P. - Left Side; W/Calif. Emission System	255810R2	7390
Belt - A.P. - Right Side; W/Calif. Emission System	149636R2	♣9480HD
Belt - A.P.; W/O Calif. Emission System; W/Air Brakes; W/Gov.	182048R1	7360
Belt - A.P.; W/O Calif. Emission System; W/Air Brakes; W/O Gov.	333382C2	7385
Belt - A.P.; W/O Calif. Emission System; W/O Air Brakes; W/Gov.	323612C2	7380
Belt - A.P.; W/O Calif. Emission System; W/O Air Brakes; W/O Gov.	282989C2	7410
Hose - Upper		21293
Hose - Lower		21292
International/Navistar V392		
1723; 1823		
Belt - Fan & Alt.; W/42A., 61A., 65A., 80A., 85A. Alt.	255266C3	②7640
Belt - Fan & Alt.; W/105A., 145A. Alt.	369722C1	②7630
Belt - P.S.	967907R2	②7565
Belt - Air Brake Compr.	227703R2	7475
Belt - A.C.	284453C2	♣9495HD
Belt - A.P. - Left Side; W/Calif. Emission System	255810R2	7390
Belt - A.P. - Right Side; W/Calif. Emission System	149636R2	♣9480HD
Belt - A.P.; W/O Calif. Emission System; W/Air Brakes; W/Gov.	182048R1	7360
Belt - A.P.; W/O Calif. Emission System; W/Air Brakes; W/O Gov.	333382C2	7385
Belt - A.P.; W/O Calif. Emission System; W/O Air Brakes; W/Gov.	323612C2	7380
Belt - A.P.; W/O Calif. Emission System; W/O Air Brakes; W/O Gov.	282989C2	7410
Hose - Upper		21293
Hose - Lower		21292
1982		
Caterpillar 3208 Diesel		
1853		
Belt - Fan	355707C91	②♣9520HD
Belt - W.P.	150560R2	♣9451HD
Belt - P.S. & W.P.	446707C1	②♣9600HD
Belt - P.S.		7390
Belt - Alt.	306219C2	②7370
Belt - Alt. & Air Brake Compr.	468455C1	②7508

Application	Mfr. Part No.	Our No.
International/Navistar - Continued		
1982 - Continued		
Caterpillar 3208 Diesel - Continued		
1853 - Continued		
Belt - Alt. & V.P.	468460C91	②7480
Belt - A.C.	190502R2	♣9490HD
Hose - Upper		21453
International/Navistar DT466 Diesel		
1853		
Belt - Fan & Alt.; W/65 1/4" Belt O.C.		②♣♣9650HD
Belt - Fan & Alt.; W/69 1/2" Belt O.C.	1810680C1	②♣♣9690HD
Belt - Fan & Alt.; W/70 1/4" Belt O.C.		②♣♣9700HD
Belt - Fan & P.S.	689444C1	②♣9745HD
Belt - Fan & Air Brake Compr.	1812519C1	TR22770
Belt - Fan To Air Brake Compr.		♣9485HD
Belt - P.S.	429274C91	②7390
Belt - V.P.	190502R2	♣9490HD
Belt - A.C.	133758R2	♣9440HD
Hose - Upper		21372
		26528
Hose - Lower; Double Dia. Hose; W/3/4" Offset		21766
Hose - Lower; Double Dia. Hose; W/2 3/4" Offset		21291
Hose - Lower; Single Dia. Hose		21042
Hose - By Pass		21461
1853FC		
Belt - Alt.		③♣9650HD
Belt - P.S.	358328C91	②♣♣9463HD
Belt - Air Brake Compr.		♣9490HD
Belt - V.P.	190502R2	♣9490HD
Hose - Lower		♣21291
International/Navistar MV404		
1823		
Belt - Fan & Alt.; W/Front P.T.O.; W/42A., 61A. Alt.	863751R2	②7580
Belt - Fan & Alt.; W/O Front P.T.O.; W/42A., 61A. Alt.	355478C91	②7512
Belt - Fan & Alt.; W/65A., 80A., 85A., 105A., 145A. Alt.	510238C91	②7585
Belt - Fan & P.S.; W/64" Belt O.C.	479217C1	②♣9635HD
Belt - Fan & P.S.; W/66 1/2" Belt O.C.	488882C1	②♣♣9660HD
Belt - Fan & P.S.; W/A.P.; W/60 1/4" Belt O.C.	446707C1	♣9600HD
Belt - Fan & P.S.; W/A.P.; W/63 1/4" Belt O.C.	395539R1	♣9630HD
Belt - Fan & P.S.; W/O A.P.		♣9510HD
Belt - Fan & A.P.; W/O Calif. Emission System		♣9540HD
Belt - P.S. & A.P.; W/Saginaw P.S. Pump		♣9720HD
Belt - P.S. & A.P.; W/Ross, Sheppard P.S. Pump	465244C1	♣9740HD
Belt - Air Brake Compr.		♣9610HD
Belt - A.P.; W/Air Brakes; W/Calif. Emission System	132058R3	7350
Belt - A.P.; W/Hyd. Brakes; W/Calif. Emission System	468505C91	7490
Belt - A.P.; W/O P.T.O.; W/O Calif. Emission System	270094C2	♣9580HD
Hose - Upper		21289
Hose - Lower		21288
International/Navistar MV446		
1823		
Belt - Fan & Alt.; W/Front P.T.O.; W/42A., 61A. Alt.	863751R2	②7580
Belt - Fan & Alt.; W/O Front P.T.O.; W/42A., 61A. Alt.	355478C91	②7512
Belt - Fan & Alt.; W/65A., 80A., 85A., 105A., 145A. Alt.	510238C91	②7585
Belt - Fan & P.S.; W/64" Belt O.C.	479217C1	②♣9635HD
Belt - Fan & P.S.; W/66 1/2" Belt O.C.	488882C1	②♣♣9660HD

②Two Required.
♣PowerBand Belt May Work, Use Template to Check.
♣Cut to Fit.

♣Standard Belt Available.
③Three Required.

Belts and Coolant Hose for School Buses

Application	Mfr. Part No.	Our No.	Application	Mfr. Part No.	Our No.
International/Navistar - Continued			International/Navistar - Continued		
1982 - Continued			1982 - Continued		
International/Navistar MV446 - Continued			International/Navistar V392		
1823 - Continued			1723		
Belt - Fan & P.S.; W/A.P.; W/60 1/4" Belt O.C.	446707C1	◆9600HD	Belt - Fan & Alt.; W/42A., 61A., 65A., 80A., 85A. Alt.	255266C3	②7640
Belt - Fan & P.S.; W/A.P.; W/63 1/4" Belt O.C.	395539R1	◆9630HD	Belt - Fan & Alt.; W/105A., 145A. Alt.	369722C1	②7630
Belt - Fan & P.S.; W/O A.P.		◆9510HD	Belt - P.S.; W/41 1/8" Belt O.C.	408144C1	7405
Belt - Fan & A.P.; W/O Calif. Emission System		◆9540HD	Belt - P.S.; W/41 5/8" Belt O.C.	282989C2	7410
Belt - P.S. & A.P.; W/Saginaw P.S. Pump		◆9720HD	Belt - Air Brake Compr.	227703R2	7475
Belt - P.S. & A.P.; W/Ross, Sheppard P.S. Pump	465244C1	◆9740HD	Belt - A.C.	284453C2	◆9495HD
Belt - Air Brake Compr.		◆9610HD	Belt - A.P. - Left Side; W/Calif. Emission System	255810R2	7390
Belt - A.P.; W/Air Brakes; W/Calif. Emission System	132058R3	7350	Belt - A.P. - Right Side; W/Calif. Emission System	149636R2	◆9480HD
Belt - A.P.; W/Hyd. Brakes; W/Calif. Emission System	468505C91	7490	Belt - A.P.; W/O Calif. Emission System; W/Air Brakes; W/Gov.	182048R1	7360
Belt - A.P.; W/O P.T.O.; W/O Calif. Emission System	270094C2	◆9580HD	Belt - A.P.; W/O Calif. Emission System; W/O Air Brakes; W/O Gov.	333382C2	7385
Hose - Upper		21289	Belt - A.P.; W/O Calif. Emission System; W/O Air Brakes; W/O Gov.	323612C2	7380
Hose - Lower		21288	Belt - A.P.; W/O Calif. Emission System; W/O Air Brakes; W/O Gov.	282989C2	7410
International/Navistar V-8 9.0 L Diesel			1981		
1853			Caterpillar 3208 Diesel		
Belt - Fan	355707C91	②◆◆9520HD	1853		
Belt - Alt.; W/42A., 61A. Alt.		②7535	Belt - Fan	355707C91	②◆◆9520HD
Belt - Alt.; W/65A., 80A. Alt.		②7555	Belt - W.P.	150560R2	◆9451HD
Belt - Alt. & Air Brake Compr.; W/42A., 61A. Alt.		②7560	Belt - P.S. & W.P.	446707C1	②◆9600HD
Belt - Alt. & Air Brake Compr.; W/65A., 80A. Alt.		②7580	Belt - P.S.		7390
Belt - Alt. & Hyd. Brake Boost Pump; W/42A., 61A. Alt.; W/P.S.		②7560	Belt - Alt.	306219C2	②7370
Belt - Alt. & Hyd. Brake Boost Pump; W/65A., 80A. Alt.; W/P.S.		②7575	Belt - Alt. & Air Brake Compr.	468455C1	②7508
Belt - Alt. & Hyd. Brake Boost Pump; W/42A., 61A. Alt.; W/O P.S.		②7545	Belt - Alt. & V.P.	468460C91	②7480
Belt - Alt. & Hyd. Brake Boost Pump; W/65A., 80A. Alt.; W/O P.S.		②7570	Belt - A.C.	190502R2	◆9490HD
Belt - P.S.; W/Hyd. Brake Boost Pump	491384C91	②7355	Hose - Upper - Eng. To Pipe		24232
Belt - P.S.; W/O Hyd. Brake Boost Pump	429274C91	②7390	Hose - Upper - Pipe To Rad.		24240
Hose - Upper; W/Single Hose		≈21123	International/Navistar DT466 Diesel		
Hose - Upper - Eng. To Pipe		24240	1853		
Hose - Upper - Pipe To Rad.		24240	Belt - Fan & Alt.; W/65 1/4" Belt O.C.		②◆◆9650HD
Hose - Lower		21290	Belt - Fan & Alt.; W/69 1/2" Belt O.C.	1810680C1	②◆◆9690HD
International/Navistar V345			Belt - Fan & Alt.; W/70 1/4" Belt O.C.		②◆◆9700HD
1723			Belt - Fan & P.S.	689444C1	②◆9745HD
Belt - Fan & Alt.; W/42A., 61A., 65A., 80A., 85A. Alt.	255266C3	②7640	Belt - Fan & Air Brake Compr.	1812519C1	TR22770
Belt - Fan & Alt.; W/105A., 145A. Alt.	369722C1	②7630	Belt - Fan To Air Brake Compr.		◆9485HD
Belt - P.S.; W/41 1/8" Belt O.C.	408144C1	7405	Belt - P.S.	429274C91	②7390
Belt - P.S.; W/41 5/8" Belt O.C.	282989C2	7410	Belt - V.P.	190502R2	◆9490HD
Belt - Air Brake Compr.	227703R2	7475	Belt - A.C.	133758R2	◆9440HD
Belt - A.C.	284453C2	◆9495HD	Hose - Upper - Eng. To Pipe; W/A.C.; Mar. 7, 1981 & Older		≈21135
Belt - A.P. - Left Side; W/Calif. Emission System	255810R2	7390	Hose - Upper - Eng. To Pipe; W/O A.C.; Mar. 7, 1981 & Older		24236
Belt - A.P. - Right Side; W/Calif. Emission System	149636R2	◆9480HD	Hose - Upper - Pipe To Rad.; Mar. 7, 1981 & Older		24236
Belt - A.P.; W/O Calif. Emission System; W/Air Brakes; W/Gov.	182048R1	7360	Hose - Upper; Mar. 8, 1981 & Newer		21372
Belt - A.P.; W/O Calif. Emission System; W/Air Brakes; W/O Gov.	333382C2	7385			26528
Belt - A.P.; W/O Calif. Emission System; W/O Air Brakes; W/Gov.	323612C2	7380	Hose - Lower; Double Dia. Hose; W/3/4" Offset		21766
Belt - A.P.; W/O Calif. Emission System; W/O Air Brakes; W/O Gov.	282989C2	7410	Hose - Lower; Double Dia. Hose; W/2 3/4" Offset		21291
Hose - Upper		21293	Hose - Lower; Single Dia. Hose		21042
Hose - Lower		21292	Hose - By Pass		21461
International/Navistar V404			International/Navistar MV404		
1723; 1823			1723; 1823		
Belt - Fan & Alt.; W/Front P.T.O.; W/42A., 61A. Alt.		863751R2	Belt - Fan & Alt.; W/Front P.T.O.; W/42A., 61A. Alt.		②7580
Belt - Fan & Alt.; W/O Front P.T.O.; W/42A., 61A. Alt.		355478C91	Belt - Fan & Alt.; W/65A., 80A., 85A., 105A., 145A. Alt.		②7512
Belt - Fan & Alt.; W/65A., 80A., 85A., 105A., 145A. Alt.		510238C91			②7585

◆Standard Belt Available.
②Two Required.

◆PowerBand Belt May Work, Use Template to Check.
≈Cut to Fit.

Belts and Coolant Hose for School Buses

School Buses

Application	Mfr. Part No.	Our No.	Application	Mfr. Part No.	Our No.
International/Navistar - Continued			International/Navistar - Continued		
1981 - Continued			1981 - Continued		
International/Navistar MV404 - Continued			International/Navistar V-8 9.0 L Diesel - Continued		
1723; 1823 - Continued			1853 - Continued		
Belt - Fan & P.S.; W/64" Belt O.C.	479217C1	②◆9635HD	Belt - P.S.; W/O Hyd. Brake Boost Pump	429274C91	②7390
Belt - Fan & P.S.; W/66 1/2" Belt O.C.	488882C1	②◆9660HD	Hose - Upper; W/Single Hose		≈21123
Belt - Fan & P.S.; W/A.P.; W/60 1/4" Belt O.C.	446707C1	◆9600HD	Hose - Upper - Eng. To Pipe		24240
Belt - Fan & P.S.; W/A.P.; W/63 1/4" Belt O.C.	395539R1	◆9630HD	Hose - Upper - Pipe To Rad.		24240
Belt - Fan & P.S.; W/O A.P.		◆9510HD	Hose - Lower		21290
Belt - Fan & A.P.; W/O Calif. Emission System		◆9540HD	International/Navistar V345		
Belt - P.S. & A.P.; W/Saginaw P.S. Pump		◆9720HD	1723		
Belt - P.S. & A.P.; W/Ross, Sheppard P.S. Pump	465244C1	◆9740HD	Belt - Fan & Alt.; W/42A., 61A., 80A., 85A., 105A., 130A. Alt.	369722C1	7630
Belt - Air Brake Compr.; Jun. 19, 1980 & Older		◆9570HD	Belt - P.S.	967907R2	②7565
Belt - Air Brake Compr.; Jun. 20, 1980 & Newer		◆9610HD	Belt - Air Brake Compr.	227703R2	7475
Belt - A.P.; W/Air Brakes; W/Calif. Emission System	132058R3	7350	Belt - A.C.	284453C2	◆9495HD
Belt - A.P.; W/Hyd. Brakes; W/Calif. Emission System	468505C91	7490	Belt - A.P.; W/Air Brakes; W/Gov.	182048R1	7360
Belt - A.P.; W/O P.T.O.; W/O Calif. Emission System	270094C2	◆9580HD	Belt - A.P.; W/O Air Brakes; W/Gov.; W/38 5/8" Belt O.C.	323612C2	7380
Hose - Upper		21289	Belt - A.P.; W/O Air Brakes; W/Gov.; W/39 1/8" Belt O.C.	333382C2	7385
Hose - Lower		21288	Belt - A.P.; W/O Air Brakes; W/O Gov.	282989C2	7410
International/Navistar MV446			Belt - A.P. - Left Side; W/Calif. Emission System	225810R2	7390
1823			Belt - A.P. - Right Side; W/Calif. Emission System	149636R2	◆9480HD
Belt - Fan & Alt.; W/Front P.T.O.; W/42A., 61A. Alt.	863751R2	②7580	Hose - Upper		21293
Belt - Fan & Alt.; W/O Front P.T.O.; W/42A., 61A. Alt.	355478C91	②7512	Hose - Lower		21292
Belt - Fan & Alt.; W/65A., 80A., 85A., 105A., 145A. Alt.	510238C91	②7585	International/Navistar V392		
Belt - Fan & P.S.; W/64" Belt O.C.	479217C1	②◆9635HD	1723		
Belt - Fan & P.S.; W/66 1/2" Belt O.C.	488882C1	②◆9660HD	Belt - Fan & Alt.; W/42A., 61A., 80A., 85A., 105A., 130A. Alt.	369722C1	7630
Belt - Fan & P.S.; W/A.P.; W/60 1/4" Belt O.C.	446707C1	◆9600HD	Belt - P.S.	967907R2	②7565
Belt - Fan & P.S.; W/A.P.; W/63 1/4" Belt O.C.	395539R1	◆9630HD	Belt - Air Brake Compr.	227703R2	7475
Belt - Fan & P.S.; W/O A.P.		◆9510HD	Belt - A.C.	284453C2	◆9495HD
Belt - Fan & A.P.; W/O Calif. Emission System		◆9540HD	Belt - A.P.; W/Air Brakes; W/Gov.	182048R1	7360
Belt - P.S. & A.P.; W/Saginaw P.S. Pump		◆9720HD	Belt - A.P.; W/O Air Brakes; W/Gov.; W/38 5/8" Belt O.C.	323612C2	7380
Belt - P.S. & A.P.; W/Ross, Sheppard P.S. Pump	465244C1	◆9740HD	Belt - A.P.; W/O Air Brakes; W/Gov.; W/39 1/8" Belt O.C.	333382C2	7385
Belt - Air Brake Compr.; Jun. 19, 1980 & Older		◆9570HD	Belt - A.P.; W/O Air Brakes; W/O Gov.	282989C2	7410
Belt - Air Brake Compr.; Jun. 20, 1980 & Newer		◆9610HD	Belt - A.P. - Left Side; W/Calif. Emission System	225810R2	7390
Belt - A.P.; W/Air Brakes; W/Calif. Emission System	132058R3	7350	Belt - A.P. - Right Side; W/Calif. Emission System	149636R2	◆9480HD
Belt - A.P.; W/Hyd. Brakes; W/Calif. Emission System	468505C91	7490	Hose - Upper		21293
Belt - A.P.; W/O P.T.O.; W/O Calif. Emission System	270094C2	◆9580HD	Hose - Lower		21292
Hose - Upper		21289	1980		
Hose - Lower		21288	Caterpillar 3208 Diesel		
International/Navistar V-8 9.0 L Diesel			1853		
1853			Belt - Fan	355707C91	②◆9520HD
Belt - Fan	355707C91	②◆9520HD	Belt - W.P.	150560R2	◆9451HD
Belt - Alt.; W/42A., 61A. Alt.		②7535	Belt - P.S. & W.P.	446707C1	②◆9600HD
Belt - Alt.; W/65A., 80A. Alt.		②7555	Belt - P.S.		7390
Belt - Alt. & Air Brake Compr.; W/42A., 61A. Alt.		②7560	Belt - Alt.	306219C2	②7370
Belt - Alt. & Air Brake Compr.; W/65A., 80A. Alt.		②7580	Belt - Alt. & Air Brake Compr.	468455C1	②7508
Belt - Alt. & Hyd. Brake Boost Pump; W/42A., 61A. Alt.; W/P.S.		②7560	Belt - Alt. & V.P.	468460C91	②7480
Belt - Alt. & Hyd. Brake Boost Pump; W/65A., 80A. Alt.; W/P.S.		②7575	Belt - A.C.	190502R2	◆9490HD
Belt - Alt. & Hyd. Brake Boost Pump; W/42A., 61A. Alt.; W/O P.S.		②7545	Hose - Upper - Eng. To Pipe		24232
Belt - Alt. & Hyd. Brake Boost Pump; W/65A., 80A. Alt.; W/O P.S.		②7570	Hose - Upper - Pipe To Rad.		24240
Belt - P.S.; W/Hyd. Brake Boost Pump	491384C91	②7355	International/Navistar DT466 Diesel		
			1853		
			Belt - Fan & Alt.; W/65 1/4" Belt O.C.		②◆9650HD
			Belt - Fan & Alt.; W/69 1/2" Belt O.C.	1810680C1	②◆9690HD
			Belt - Fan & Alt.; W/70 1/4" Belt O.C.		②◆9700HD
			Belt - Fan & P.S.	689444C1	②◆9745HD
			Belt - Fan & Air Brake Compr.	1812519C1	TR22770

◆Standard Belt Available.
②Two Required.

◆PowerBand Belt May Work, Use Template to Check.
≈Cut to Fit.

Belts and Coolant Hose for School Buses

Application	Mfr. Part No.	Our No.	Application	Mfr. Part No.	Our No.
International/Navistar - Continued			International/Navistar - Continued		
1980 - Continued			1980 - Continued		
International/Navistar DT466 Diesel - Continued			International/Navistar MV446 - Continued		
1853 - Continued			1823 - Continued		
Belt - Fan To Air Brake Compr.		♣9485HD	Belt - A.P.; W/O P.T.O.; W/O Calif. Emission System	270094C2	♣9580HD
Belt - P.S.	429274C91	②7390	Hose - Upper		21289
Belt - V.P.	190502R2	♣9490HD	Hose - Lower		21288
Belt - A.C.	133758R2	♣9440HD	International/Navistar V-8 9.0 L Diesel		
Hose - Upper - Eng. To Pipe; W/A.C.		≡<21135	1853		
Hose - Upper - Eng. To Pipe; W/O A.C.		24236	Belt - Fan	355707C91	②♣◆9520HD
Hose - Upper - Pipe To Rad.		24236	Belt - Alt.; W/42A., 61A. Alt.		②7535
Hose - Lower; Double Dia. Hose; W/3/4" Offset		21766	Belt - Alt.; W/65A., 80A. Alt.		②7555
Hose - Lower; Double Dia. Hose; W/2 3/4" Offset		21291	Belt - Alt. & Air Brake Compr.; W/42A., 61A. Alt.		②7560
Hose - Lower; Single Dia. Hose		21042	Belt - Alt. & Air Brake Compr.; W/65A., 80A. Alt.		②7580
Hose - By Pass		21461	Belt - Alt. & Hyd. Brake Boost Pump; W/42A., 61A. Alt.; W/P.S.		②7560
International/Navistar MV404			Belt - Alt. & Hyd. Brake Boost Pump; W/65A., 80A. Alt.; W/P.S.		②7575
1723; 1823			Belt - Alt. & Hyd. Brake Boost Pump; W/42A., 61A. Alt.; W/O P.S.		②7545
Belt - Fan & Alt.; W/Front P.T.O.; W/42A., 61A. Alt.	863751R2	②7580	Belt - Alt. & Hyd. Brake Boost Pump; W/65A., 80A. Alt.; W/O P.S.		②7570
Belt - Fan & Alt.; W/O Front P.T.O.; W/42A., 61A. Alt.	355478C91	②7512	Belt - P.S.; W/Hyd. Brake Boost Pump	491384C91	②7355
Belt - Fan & Alt.; W/65A., 80A., 85A., 105A., 145A. Alt.	510238C91	②7585	Belt - P.S.; W/O Hyd. Brake Boost Pump	429274C91	②7390
Belt - Fan & P.S.; W/64" Belt O.C.	479217C1	②♣9635HD	Hose - Upper; W/Single Hose		≡<21123
Belt - Fan & P.S.; W/66 1/2" Belt O.C.	488882C1	②♣◆9660HD	Hose - Upper - Eng. To Pipe		24240
Belt - Fan & P.S.; W/A.P.; W/60 1/4" Belt O.C.	446707C1	♣9600HD	Hose - Upper - Pipe To Rad.		24240
Belt - Fan & P.S.; W/A.P.; W/63 1/4" Belt O.C.	395539R1	♣9630HD	Hose - Lower		21290
Belt - Fan & P.S.; W/O A.P.		♣9510HD	International/Navistar V345		
Belt - Fan & A.P.; W/O Calif. Emission System		♣9540HD	1723		
Belt - P.S. & A.P.; W/Saginaw P.S. Pump		♣9720HD	Belt - Fan & Alt.; W/42A., 61A., 65A., 80A., 85A. Alt.	255266C2	7640
Belt - P.S. & A.P.; W/Ross, Sheppard P.S. Pump	465244C1	♣9740HD	Belt - Fan & Alt.; W/105A., 145A. Alt.	369722C1	7630
Belt - Air Brake Compr.; Jun. 19, 1980 & Older		♣9570HD	Belt - P.S.	967907R2	7565
Belt - Air Brake Compr.; Jun. 20, 1980 & Newer		♣9610HD	Belt - Air Brake Compr.	227703R2	7475
Belt - A.P.; W/Air Brakes; W/Calif. Emission System	132058R3	7350	Belt - A.C.	284453C2	♣9495HD
Belt - A.P.; W/Hyd. Brakes; W/Calif. Emission System	468505C91	7490	Belt - A.P.; W/Air Brakes; W/Gov.	182048R1	7360
Belt - A.P.; W/O P.T.O.; W/O Calif. Emission System	270094C2	♣9580HD	Belt - A.P.; W/Air Brakes; W/O Gov.	333382C2	7385
Hose - Upper		21289	Belt - A.P.; W/O Air Brakes; W/Gov.	323612C2	7380
Hose - Lower		21288	Belt - A.P.; W/O Air Brakes; W/O Gov.	282989C2	7410
International/Navistar MV446			Hose - Upper		21293
1823			Hose - Lower		21292
Belt - Fan & Alt.; W/Front P.T.O.; W/42A., 61A. Alt.	863751R2	②7580	International/Navistar V392		
Belt - Fan & Alt.; W/O Front P.T.O.; W/42A., 61A. Alt.	355478C91	②7512	1723		
Belt - Fan & Alt.; W/65A., 80A., 85A., 105A., 145A. Alt.	510238C91	②7585	Belt - Fan & Alt.; W/42A., 61A., 65A., 80A., 85A. Alt.	255266C2	7640
Belt - Fan & P.S.; W/64" Belt O.C.	479217C1	②♣9635HD	Belt - Fan & Alt.; W/105A., 145A. Alt.	369722C1	7630
Belt - Fan & P.S.; W/66 1/2" Belt O.C.	488882C1	②♣◆9660HD	Belt - P.S.	967907R2	7565
Belt - Fan & P.S.; W/A.P.; W/60 1/4" Belt O.C.	446707C1	♣9600HD	Belt - Air Brake Compr.	227703R2	7475
Belt - Fan & P.S.; W/A.P.; W/63 1/4" Belt O.C.	395539R1	♣9630HD	Belt - A.C.	284453C2	♣9495HD
Belt - Fan & P.S.; W/O A.P.		♣9510HD	Belt - A.P.; W/Air Brakes; W/Gov.	182048R1	7360
Belt - Fan & A.P.; W/O Calif. Emission System		♣9540HD	Belt - A.P.; W/Air Brakes; W/O Gov.	333382C2	7385
Belt - P.S. & A.P.; W/Saginaw P.S. Pump		♣9720HD	Belt - A.P.; W/O Air Brakes; W/Gov.	323612C2	7380
Belt - P.S. & A.P.; W/Ross, Sheppard P.S. Pump	465244C1	♣9740HD	Belt - A.P.; W/O Air Brakes; W/O Gov.	282989C2	7410
Belt - Air Brake Compr.; Jun. 19, 1980 & Older		♣9570HD	Hose - Upper		21293
Belt - Air Brake Compr.; Jun. 20, 1980 & Newer		♣9610HD	Hose - Lower		21292
Belt - A.P.; W/Air Brakes; W/Calif. Emission System	132058R3	7350	1979		
Belt - A.P.; W/Hyd. Brakes; W/Calif. Emission System	468505C91	7490	Caterpillar 3208 Diesel		
International/Navistar MV446			1853		
1823			Belt - Fan	355707C91	②♣◆9520HD
Belt - Fan & Alt.; W/Front P.T.O.; W/42A., 61A. Alt.	863751R2	②7580	Belt - W.P.	150560R2	♣9451HD
Belt - Fan & Alt.; W/O Front P.T.O.; W/42A., 61A. Alt.	355478C91	②7512	Belt - P.S. & W.P.	446707C1	②♣9600HD
Belt - Fan & Alt.; W/65A., 80A., 85A., 105A., 145A. Alt.	510238C91	②7585	Belt - P.S.		7390
Belt - Fan & P.S.; W/64" Belt O.C.	479217C1	②♣9635HD	Belt - Alt.	306219C2	②7370
Belt - Fan & P.S.; W/66 1/2" Belt O.C.	488882C1	②♣◆9660HD	Belt - Alt. & Air Brake Compr.	468455C1	②7508
Belt - Fan & P.S.; W/A.P.; W/60 1/4" Belt O.C.	446707C1	♣9600HD	Belt - Alt. & V.P.	468460C91	②7480
Belt - Fan & P.S.; W/A.P.; W/63 1/4" Belt O.C.	395539R1	♣9630HD			
Belt - Fan & P.S.; W/O A.P.		♣9510HD			
Belt - Fan & A.P.; W/O Calif. Emission System		♣9540HD			
Belt - P.S. & A.P.; W/Saginaw P.S. Pump		♣9720HD			
Belt - P.S. & A.P.; W/Ross, Sheppard P.S. Pump	465244C1	♣9740HD			
Belt - Air Brake Compr.; Jun. 19, 1980 & Older		♣9570HD			
Belt - Air Brake Compr.; Jun. 20, 1980 & Newer		♣9610HD			
Belt - A.P.; W/Air Brakes; W/Calif. Emission System	132058R3	7350			
Belt - A.P.; W/Hyd. Brakes; W/Calif. Emission System	468505C91	7490			

②Two Required.
≡<Cut to Fit.

♣Standard Belt Available.
◆PowerBand Belt May Work, Use Template to Check.

School Buses

Belts and Coolant Hose for School Buses

School Buses

Application	Mfr. Part No.	Our No.	Application	Mfr. Part No.	Our No.
International/Navistar - Continued			International/Navistar - Continued		
1979 - Continued			1979 - Continued		
Caterpillar 3208 Diesel - Continued			International/Navistar MV404 - Continued		
1853 - Continued			1723; 1823 - Continued		
Belt - A.C.	190502R2	♣9490HD	Belt - A.P.; W/Hyd. Brakes; W/Calif. Emission System	468505C91	7490
Hose - Upper - Eng. To Pipe		24232	Belt - A.P.; W/O P.T.O.; W/O Calif. Emission System	270094C2	♣9580HD
Hose - Upper - Pipe To Rad.		24240	Hose - Upper		21289
International/Navistar DT466 Diesel			Hose - Lower		
1753			21288		
Belt - Fan & Alt.; W/65 1/4" Belt O.C.		②♣♠9650HD	International/Navistar MV446		
Belt - Fan & Alt.; W/69 1/2" Belt O.C.	1810680C1	②♣♠9690HD	1723; 1823		
Belt - Fan & Alt.; W/70 1/4" Belt O.C.		②♣♠9700HD	Belt - Fan & Alt.; W/Front P.T.O.; W/42A., 61A. Alt.		
Belt - Fan & P.S.	689444C1	②♣♠9745HD	61A. Alt.		
Belt - Fan & Air Brake Compr.	1812519C1	TR22770	Belt - Fan & Alt.; W/O Front P.T.O.; W/42A., 61A. Alt.		
Belt - Fan To Air Brake Compr.		♣9485HD	355478C91		
Belt - P.S.	429274C91	②7390	Belt - Fan & Alt.; W/65A., 80A., 85A., 105A., 145A. Alt.		
Belt - V.P.	190502R2	♣9490HD	510238C91		
Belt - A.C.	133758R2	♣9440HD	Belt - Fan & P.S.; W/64" Belt O.C.		
1853			479217C1		
Belt - Fan & Alt.; W/65 1/4" Belt O.C.		②♣♠9650HD	Belt - Fan & P.S.; W/66 1/2" Belt O.C.		
Belt - Fan & Alt.; W/69 1/2" Belt O.C.	1810680C1	②♣♠9690HD	488882C1		
Belt - Fan & Alt.; W/70 1/4" Belt O.C.		②♣♠9700HD	Belt - Fan & P.S.; W/A.P.; W/60 1/4" Belt O.C.		
Belt - Fan & P.S.	689444C1	②♣9745HD	446707C1		
Belt - Fan & Air Brake Compr.		TR22770	Belt - Fan & P.S.; W/A.P.; W/63 1/4" Belt O.C.		
Belt - Fan To Air Brake Compr.		♣9485HD	395539R1		
Belt - P.S.	429274C91	②7390	Belt - Fan & P.S.; W/O A.P.		
Belt - V.P.	190502R2	♣9490HD	Belt - Fan & A.P.; W/O Calif. Emission System		
Belt - A.C.	133758R2	♣9440HD	Belt - P.S. & A.P.; W/Saginaw P.S. Pump		
Hose - Upper - Eng. To Pipe; W/A.C.; Mar. 7, 1981 & Older		≈<21135	Belt - P.S. & A.P.; W/Ross, Sheppard P.S. Pump		
Hose - Upper - Eng. To Pipe; W/O A.C.; Mar. 7, 1981 & Older		24236	465244C1		
Hose - Upper - Pipe To Rad.; Mar. 7, 1981 & Older		24236	Belt - Air Brake Compr.; Jun. 19, 1980 & Older		
Hose - Upper; Mar. 8, 1981 & Newer		21372	Belt - Air Brake Compr.; Jun. 20, 1980 & Newer		
or		26528	Belt - A.P.; W/Air Brakes; W/Calif. Emission System		
Hose - Lower; Double Dia. Hose; W/3/4" Offset		21766	132058R3		
Hose - Lower; Double Dia. Hose; W/2 3/4" Offset		21291	Belt - A.P.; W/Hyd. Brakes; W/Calif. Emission System		
Hose - Lower; Single Dia. Hose		21042	468505C91		
Hose - By Pass		21461	Belt - A.P.; W/O P.T.O.; W/O Calif. Emission System		
1853FC			270094C2		
Belt - Alt.		③♣9650HD	Hose - Upper		
Belt - P.S.	358328C91	②♣♠9463HD	21289		
Belt - Air Brake Compr.		♣9490HD	Hose - Lower		
Belt - V.P.	190502R2	♣9490HD	21288		
Hose - Lower		≈<21291	International/Navistar V-8 9.0 L Diesel		
International/Navistar MV404			1853		
1723; 1823			Belt - Fan		
Belt - Fan & Alt.; W/Front P.T.O.; W/42A., 61A. Alt.		②7580	355707C91		
Belt - Fan & Alt.; W/O Front P.T.O.; W/42A., 61A. Alt.		②7512	②♣♠9520HD		
Belt - Fan & Alt.; W/65A., 80A., 85A., 105A., 145A. Alt.		②7585	Belt - Alt.; W/42A., 61A. Alt.		
Belt - Fan & P.S.; W/64" Belt O.C.	479217C1	②♣9635HD	Belt - Alt.; W/65A., 80A. Alt.		
Belt - Fan & P.S.; W/66 1/2" Belt O.C.	488882C1	②♣♠9660HD	Belt - Alt. & Air Brake Compr.; W/42A., 61A. Alt.		
Belt - Fan & P.S.; W/A.P.; W/60 1/4" Belt O.C.	446707C1	♣9600HD	Belt - Alt. & Air Brake Compr.; W/65A., 80A. Alt.		
Belt - Fan & P.S.; W/A.P.; W/63 1/4" Belt O.C.	395539R1	♣9630HD	Belt - Alt. & Hyd. Brake Boost Pump; W/42A., 61A. Alt.; W/P.S.		
Belt - Fan & P.S.; W/O A.P.		♣9510HD	Belt - Alt. & Hyd. Brake Boost Pump; W/65A., 80A. Alt.; W/P.S.		
Belt - Fan & A.P.; W/O Calif. Emission System		♣9540HD	Belt - Alt. & Hyd. Brake Boost Pump; W/42A., 61A. Alt.; W/O P.S.		
Belt - P.S. & A.P.; W/Saginaw P.S. Pump		♣9720HD	Belt - Alt. & Hyd. Brake Boost Pump; W/65A., 80A. Alt.; W/O P.S.		
Belt - P.S. & A.P.; W/Ross, Sheppard P.S. Pump	465244C1	♣9740HD	Belt - P.S.; W/Hyd. Brake Boost Pump		
Belt - Air Brake Compr.; Jun. 19, 1980 & Older		♣9570HD	491384C91		
Belt - Air Brake Compr.; Jun. 20, 1980 & Newer		♣9610HD	Belt - P.S.; W/O Hyd. Brake Boost Pump		
Belt - A.P.; W/Air Brakes; W/Calif. Emission System	132058R3	7350	429274C91		
International/Navistar V345			Hose - Upper; W/Single Hose		
1723; 1823			≈<21123		
Belt - Fan & Alt.; W/42A., 61A., 65A., 80A., 85A. Alt.		255266C2	Hose - Upper - Eng. To Pipe		
Belt - Fan & Alt.; W/105A., 145A. Alt.		369722C1	24240		
Belt - P.S.		967907R2	Hose - Upper - Pipe To Rad.		
Belt - Air Brake Compr.		227703R2	24240		
Belt - A.C.		284453C2	Hose - Lower		
Belt - A.P.; W/Air Brakes; W/Gov.		182048R1	21290		

♣Standard Belt Available.
 ②Two Required.
 ③Three Required.

♣PowerBand Belt May Work, Use Template to Check.
 ≈<Cut to Fit.

Belts and Coolant Hose for School Buses

Application	Mfr. Part No.	Our No.	Application	Mfr. Part No.	Our No.
International/Navistar - Continued			International/Navistar - Continued		
1979 - Continued			1978 - Continued		
International/Navistar V345 - Continued			International/Navistar MV446		
1723; 1823 - Continued			1723; 1823		
Belt - A.P.; W/Air Brakes; W/O Gov.	333382C2	7385	Belt - Fan & Alt.; W/Front P.T.O.; W/42A., 61A. Alt.	863751R2	②7580
Belt - A.P.; W/O Air Brakes; W/Gov.	323612C2	7380	Belt - Fan & Alt.; W/O Front P.T.O.; W/42A., 61A. Alt.	355478C91	②7512
Belt - A.P.; W/O Air Brakes; W/O Gov.	282989C2	7410	Belt - Fan & Alt.; W/65A., 80A., 85A., 105A., 145A. Alt.	510238C91	②7585
Hose - Upper		21293	Belt - Fan & P.S.; W/64" Belt O.C.	479217C1	②♣9635HD
Hose - Lower		21292	Belt - Fan & P.S.; W/66 1/2" Belt O.C.	488882C1	②♣9660HD
International/Navistar V392			Belt - Fan & P.S.; W/A.P.; W/60 1/4" Belt O.C.		
1723; 1823			446707C1		
Belt - Fan & Alt.; W/42A., 61A., 65A., 80A., 85A. Alt.	255266C2	7640	Belt - Fan & P.S.; W/A.P.; W/63 1/4" Belt O.C.		
Belt - Fan & Alt.; W/105A., 145A. Alt.	369722C1	7630	395539R1		
Belt - P.S.	967907R2	7565	Belt - Fan & P.S.; W/O A.P.		
Belt - Air Brake Compr.	227703R2	7475	Belt - Fan & A.P.; W/O Calif. Emission System		
Belt - A.C.	284453C2	♣9495HD	Belt - P.S. & A.P.; W/Saginaw P.S. Pump		
Belt - A.P.; W/Air Brakes; W/Gov.	182048R1	7360	Belt - P.S. & A.P.; W/Ross, Sheppard P.S. Pump		
Belt - A.P.; W/Air Brakes; W/O Gov.	333382C2	7385	465244C1		
Belt - A.P.; W/O Air Brakes; W/Gov.	323612C2	7380	Belt - Air Brake Compr.; Jun. 19, 1980 & Older		
Belt - A.P.; W/O Air Brakes; W/O Gov.	282989C2	7410	Belt - Air Brake Compr.; Jun. 20, 1980 & Newer		
Hose - Upper		21293	Belt - A.P.; W/Air Brakes; W/Calif. Emission System		
Hose - Lower		21292	132058R3		
1978			Belt - A.P.; W/Hyd. Brakes; W/Calif. Emission System		
Caterpillar 3208 Diesel			468505C91		
1853			Belt - A.P.; W/O P.T.O.; W/O Calif. Emission System		
Hose - Upper - Eng. To Pipe		24232	270094C2		
Hose - Upper - Pipe To Rad.		24240	Hose - Upper - To Center of Rad.		
International/Navistar DT466 Diesel			or		
1853FC			21133		
Hose - Lower		♣21291	or		
International/Navistar MV404			26528		
1723; 1823			21133		
Belt - Fan & Alt.; W/Front P.T.O.; W/42A., 61A. Alt.	863751R2	②7580	or		
Belt - Fan & Alt.; W/O Front P.T.O.; W/42A., 61A. Alt.	355478C91	②7512	26528		
Belt - Fan & Alt.; W/65A., 80A., 85A., 105A., 145A. Alt.	510238C91	②7585	26532		
Belt - Fan & P.S.; W/64" Belt O.C.	479217C1	②♣9635HD	21129		
Belt - Fan & P.S.; W/66 1/2" Belt O.C.	488882C1	②♣9660HD	International/Navistar V345		
Belt - Fan & P.S.; W/A.P.; W/60 1/4" Belt O.C.	446707C1	♣9600HD	1603; 1703 (School Bus)		
Belt - Fan & P.S.; W/A.P.; W/63 1/4" Belt O.C.	395539R1	♣9630HD	Belt - Fan & Alt.; W/37A., 52A., 61A. Alt.; C, G, H Chassis; W/P.T.O.		
Belt - Fan & P.S.; W/O A.P.		♣9510HD	968815R11		
Belt - Fan & A.P.; W/O Calif. Emission System		♣9540HD	②7650		
Belt - P.S. & A.P.; W/Saginaw P.S. Pump		♣9720HD	Belt - Fan & Alt.; W/37A., 52A., 61A. Alt.; C, G, H Chassis; W/O P.T.O.		
Belt - P.S. & A.P.; W/Ross, Sheppard P.S. Pump	465244C1	♣9740HD	373457C91		
Belt - Air Brake Compr.; Jun. 19, 1980 & Older		♣9570HD	②7612		
Belt - Air Brake Compr.; Jun. 20, 1980 & Newer		♣9610HD	Belt - Fan & Alt.; W/37A., 52A., 61A. Alt.; FD, SB Chassis		
Belt - A.P.; W/Air Brakes; W/Calif. Emission System	132058R3	7350	968815R1		
Belt - A.P.; W/Hyd. Brakes; W/Calif. Emission System	468505C91	7490	②7650		
Belt - A.P.; W/O P.T.O.; W/O Calif. Emission System	270094C2	♣9580HD	Belt - Fan & Alt.; W/37A., 61A. Alt.; W/O Air Brakes; W/O P.T.O.; W/O X.C.		
Hose - Upper - To Center of Rad.		21132	373456C1		
or		26528	Belt - Fan & Alt.; W/55A., 62A. Alt.; C, G, H Chassis		
Hose - Upper - To Right Hand Side of Rad.		21133	369723C91		
or		26528	②7630		
Hose - Lower; W/Auto. Trans.		26532	Belt - Fan & Alt.; W/55A., 62A. Alt.; FD, SB Chassis		
Hose - Lower; W/Man. Trans.		21129	361975C91		
			②7673		
			Belt - Fan & Alt.; W/60A. Alt.		
			359009C91		
			②7680		
			Belt - Fan & Alt.; W/65A., 80A., 105A., 145A. Alt.; W/P.T.O.		
			361975C91		
			②7673		
			Belt - Fan & Alt.; W/65A., 80A., 105A., 145A. Alt.; W/O P.T.O.		
			②7630		
			Belt - P.S.; W/2WD		
			7460		
			Belt - P.S.; W/4WD		
			285522C2		
			7435		
			Belt - Air Brake Compr.		
			359007C91		
			7475		
			Belt - A.P.; W/Air Brakes; W/Gov.		
			388139C1		
			7330		
			Belt - A.P.; W/Air Brakes; W/O Gov.		
			256062C2		
			7340		
			Belt - A.P.; W/Hyd. Brakes; W/Gov.		
			355653C91		
			7380		
			Belt - A.P.; W/Hyd. Brakes; W/O Gov.		
			362887C91		
			7410		
			Hose - Upper; W/Rad. Shutters; W/Metal Hood		
			26515		
			Hose - Upper; W/O Rad. Shutters; W/Metal Hood		
			20493		
			Hose - Lower - Eng. To Pipe; W/Auto. Trans.		
			20532		
			Hose - Lower; W/Man. Trans.		
			21308		
			Hose - By Pass		
			♣20357		
			1723		
			Belt - Fan & Alt.; W/37A., 52A., 61A. Alt.; C, G, H Chassis; W/P.T.O.		
			968815R11		
			②7650		
			Belt - Fan & Alt.; W/37A., 52A., 61A. Alt.; C, G, H Chassis; W/O P.T.O.		
			373457C91		
			②7612		

School Buses

♣Standard Belt Available.
②Two Required.

♣Cut to Fit.
◆PowerBand Belt May Work, Use Template to Check.

Belts and Coolant Hose for School Buses

School Buses

Application	Mfr. Part No.	Our No.	Application	Mfr. Part No.	Our No.
International/Navistar - Continued			International/Navistar - Continued		
1978 - Continued			1978 - Continued		
International/Navistar V345 - Continued			International/Navistar V345 - Continued		
1723 - Continued			1823 - Continued		
Belt - Fan & Alt.; W/37A., 52A., 61A. Alt.; FD, SB Chassis	968815R1	@7650	Belt - Fan & Alt.; W/65A., 80A., 105A., 145A. Alt.; W/O P.T.O.		@7630
Belt - Fan & Alt.; W/37A., 61A. Alt.; W/O Air Brakes; W/O P.T.O.; W/O X.C.	373456C1	7612	Belt - P.S.; W/2WD		7460
Belt - Fan & Alt.; W/55A., 62A. Alt.; C, G, H Chassis	369723C91	@7630	Belt - P.S.; W/4WD	285522C2	7435
Belt - Fan & Alt.; W/55A., 62A. Alt.; FD, SB Chassis	361975C91	@7673	Belt - Air Brake Compr.	359007C91	7475
Belt - Fan & Alt.; W/60A. Alt.	359009C91	@7680	Belt - A.P.; W/Air Brakes; W/Gov.	388139C1	7330
Belt - Fan & Alt.; W/65A., 80A., 105A., 145A. Alt.; W/P.T.O.	361975C91	@7673	Belt - A.P.; W/Air Brakes; W/O Gov.	256062C2	7340
Belt - Fan & Alt.; W/65A., 80A., 105A., 145A. Alt.; W/O P.T.O.		@7630	Belt - A.P.; W/Hyd. Brakes; W/Gov.	355653C91	7380
Belt - P.S.; W/2WD		7460	Belt - A.P.; W/Hyd. Brakes; W/O Gov.	362887C91	7410
Belt - P.S.; W/4WD	285522C2	7435	Hose - Upper		21293
Belt - Air Brake Compr.	359007C91	7475	Hose - Lower		21292
Belt - A.P.; W/Air Brakes; W/Gov.	388139C1	7330	International/Navistar V392		
Belt - A.P.; W/Air Brakes; W/O Gov.	256062C2	7340	1603; 1703 (School Bus)		
Belt - A.P.; W/Hyd. Brakes; W/Gov.	355653C91	7380	Belt - Fan & Alt.; W/37A., 52A., 61A. Alt.; C, G, H Chassis; W/P.T.O.	968815R11	@7650
Belt - A.P.; W/Hyd. Brakes; W/O Gov.	362887C91	7410	Belt - Fan & Alt.; W/37A., 52A., 61A. Alt.; C, G, H Chassis; W/O P.T.O.	373457C91	@7612
Hose - Upper		21293	Belt - Fan & Alt.; W/37A., 52A., 61A. Alt.; FD, SB Chassis	968815R1	@7650
Hose - Lower		21292	Belt - Fan & Alt.; W/37A., 61A. Alt.; W/O Air Brakes; W/O P.T.O.; W/O X.C.	373456C1	7612
1803			Belt - Fan & Alt.; W/55A., 62A. Alt.; C, G, H Chassis	369723C91	@7630
Belt - Fan & Alt.; W/37A., 52A., 61A. Alt.; C, G, H Chassis; W/P.T.O.	968815R11	@7650	Belt - Fan & Alt.; W/55A., 62A. Alt.; FD, SB Chassis	361975C91	@7673
Belt - Fan & Alt.; W/37A., 52A., 61A. Alt.; C, G, H Chassis; W/O P.T.O.	373457C91	@7612	Belt - Fan & Alt.; W/60A. Alt.	359009C91	@7680
Belt - Fan & Alt.; W/37A., 52A., 61A. Alt.; FD, SB Chassis	968815R1	@7650	Belt - Fan & Alt.; W/65A., 80A., 105A., 145A. Alt.; W/P.T.O.	361975C91	@7673
Belt - Fan & Alt.; W/37A., 61A. Alt.; W/O Air Brakes; W/O P.T.O.; W/O X.C.	373456C1	7612	Belt - Fan & Alt.; W/65A., 80A., 105A., 145A. Alt.; W/O P.T.O.		@7630
Belt - Fan & Alt.; W/55A., 62A. Alt.; C, G, H Chassis	369723C91	@7630	Belt - P.S.; W/2WD		7460
Belt - Fan & Alt.; W/55A., 62A. Alt.; FD, SB Chassis	361975C91	@7673	Belt - P.S.; W/4WD	285522C2	7435
Belt - Fan & Alt.; W/60A. Alt.	359009C91	@7680	Belt - Air Brake Compr.	359007C91	7475
Belt - Fan & Alt.; W/65A., 80A., 105A., 145A. Alt.; W/P.T.O.	361975C91	@7673	Belt - A.P.; W/Air Brakes; W/Gov.	388139C1	7330
Belt - Fan & Alt.; W/65A., 80A., 105A., 145A. Alt.; W/O P.T.O.		@7630	Belt - A.P.; W/Air Brakes; W/O Gov.	256062C2	7340
Belt - P.S.; W/2WD		7460	Belt - A.P.; W/Hyd. Brakes; W/Gov.	355653C91	7380
Belt - P.S.; W/4WD	285522C2	7435	Belt - A.P.; W/Hyd. Brakes; W/O Gov.	362887C91	7410
Belt - Air Brake Compr.	359007C91	7475	Hose - Upper; W/Rad. Shutters; W/Metal Hood		26515
Belt - A.P.; W/Air Brakes; W/Gov.	388139C1	7330	Hose - Upper; W/O Rad. Shutters; W/Metal Hood		20493
Belt - A.P.; W/Air Brakes; W/O Gov.	256062C2	7340	Hose - Lower - Eng. To Pipe; W/Auto. Trans.		20532
Belt - A.P.; W/Hyd. Brakes; W/Gov.	355653C91	7380	Hose - Lower; W/Man. Trans.		21308
Belt - A.P.; W/Hyd. Brakes; W/O Gov.	362887C91	7410	Hose - By Pass		@20357
Hose - Upper; W/Rad. Shutters; W/Metal Hood		26515	1723		
Hose - Upper; W/O Rad. Shutters; W/Metal Hood		20493	Belt - Fan & Alt.; W/37A., 52A., 61A. Alt.; C, G, H Chassis; W/P.T.O.	968815R11	@7650
Hose - Lower - Eng. To Pipe; W/Auto. Trans.		20532	Belt - Fan & Alt.; W/37A., 52A., 61A. Alt.; C, G, H Chassis; W/O P.T.O.	373457C91	@7612
Hose - Lower; W/Man. Trans.		21308	Belt - Fan & Alt.; W/37A., 52A., 61A. Alt.; FD, SB Chassis	968815R1	@7650
Hose - By Pass		@20357	Belt - Fan & Alt.; W/37A., 61A. Alt.; W/O Air Brakes; W/O P.T.O.; W/O X.C.	373456C1	7612
1823			Belt - Fan & Alt.; W/55A., 62A. Alt.; C, G, H Chassis	369723C91	@7630
Belt - Fan & Alt.; W/37A., 52A., 61A. Alt.; C, G, H Chassis; W/P.T.O.	968815R11	@7650	Belt - Fan & Alt.; W/55A., 62A. Alt.; FD, SB Chassis	361975C91	@7673
Belt - Fan & Alt.; W/37A., 52A., 61A. Alt.; C, G, H Chassis; W/O P.T.O.	373457C91	@7612	Belt - Fan & Alt.; W/60A. Alt.	359009C91	@7680
Belt - Fan & Alt.; W/37A., 52A., 61A. Alt.; FD, SB Chassis	968815R1	@7650	Belt - Fan & Alt.; W/65A., 80A., 105A., 145A. Alt.; W/P.T.O.	361975C91	@7673
Belt - Fan & Alt.; W/37A., 61A. Alt.; W/O Air Brakes; W/O P.T.O.; W/O X.C.	373456C1	7612	Belt - Fan & Alt.; W/65A., 80A., 105A., 145A. Alt.; W/O P.T.O.		@7630
Belt - Fan & Alt.; W/55A., 62A. Alt.; C, G, H Chassis	369723C91	@7630	Belt - P.S.; W/2WD		7460
Belt - Fan & Alt.; W/55A., 62A. Alt.; FD, SB Chassis	361975C91	@7673	Belt - P.S.; W/4WD	285522C2	7435
Belt - Fan & Alt.; W/60A. Alt.	359009C91	@7680	Belt - Air Brake Compr.	359007C91	7475
Belt - Fan & Alt.; W/65A., 80A., 105A., 145A. Alt.; W/P.T.O.	361975C91	@7673	Belt - A.P.; W/Air Brakes; W/Gov.	388139C1	7330
			Belt - A.P.; W/Air Brakes; W/O Gov.	256062C2	7340
			Belt - A.P.; W/Hyd. Brakes; W/Gov.	355653C91	7380
			Belt - A.P.; W/Hyd. Brakes; W/O Gov.	362887C91	7410

@Two Required.

@Cut to Fit.

Belts and Coolant Hose for School Buses

Application	Mfr. Part No.	Our No.	Application	Mfr. Part No.	Our No.
International/Navistar - Continued			International/Navistar - Continued		
1978 - Continued			1977 - Continued		
International/Navistar V392 - Continued			International/Navistar FTV549		
1723 - Continued			1603; 1703 (School Bus); 1803		
Hose - Upper		21293	Belt - Fan		②◆9476HD
Hose - Lower		21292	Belt - Alt.; W/37A., 61A. Alt.	359006C91	②7417
1803			Belt - Alt.; W/65A., 80A. Alt.	151531R2	②7450
Belt - Fan & Alt.; W/37A., 52A., 61A. Alt.; C, G, H Chassis; W/P.T.O.	968815R11	②7650	Belt - Alt. & Air Brake Compr.; W/37A., 61A. Alt.		②7541
Belt - Fan & Alt.; W/37A., 52A., 61A. Alt.; C, G, H Chassis; W/O P.T.O.	373457C91	②7612	Belt - Alt. & Air Brake Compr.; W/65A., 80A. Alt.	358344C91	②7560
Belt - Fan & Alt.; W/37A., 52A., 61A. Alt.; FD, SB Chassis	968815R1	②7650	Belt - P.S.	358335C91	②◆9490HD
Belt - Fan & Alt.; W/37A., 61A. Alt.; W/O Air Brakes; W/O P.T.O.; W/O X.C.	373456C1	7612	International/Navistar FTVS549		
Belt - Fan & Alt.; W/55A., 62A. Alt.; C, G, H Chassis	369723C91	②7630	1603; 1703 (School Bus); 1803		
Belt - Fan & Alt.; W/55A., 62A. Alt.; FD, SB Chassis	361975C91	②7673	Belt - Fan		②◆9476HD
Belt - Fan & Alt.; W/60A. Alt.	359009C91	②7680	Belt - Alt.; W/37A., 61A. Alt.	359006C91	②7417
Belt - Fan & Alt.; W/65A., 80A., 105A., 145A. Alt.; W/P.T.O.	361975C91	②7673	Belt - Alt.; W/65A., 80A. Alt.	151531R2	②7450
Belt - Fan & Alt.; W/65A., 80A., 105A., 145A. Alt.; W/O P.T.O.		②7630	Belt - Alt. & Air Brake Compr.; W/37A., 61A. Alt.		②7541
Belt - P.S.; W/2WD		7460	Belt - Alt. & Air Brake Compr.; W/65A., 80A. Alt.	358344C91	②7560
Belt - P.S.; W/4WD	285522C2	7435	Belt - P.S.	358335C91	②◆9490HD
Belt - Air Brake Compr.	359007C91	7475	International/Navistar MV404		
Belt - A.P.; W/Air Brakes; W/Gov.	388139C1	7330	1723; 1823		
Belt - A.P.; W/Air Brakes; W/O Gov.	256062C2	7340	Belt - Fan & Alt.; W/Front P.T.O.; W/42A., 61A. Alt.	863751R2	②7580
Belt - A.P.; W/Hyd. Brakes; W/Gov.	355653C91	7380	Belt - Fan & Alt.; W/O Front P.T.O.; W/42A., 61A. Alt.	355478C91	②7512
Belt - A.P.; W/Hyd. Brakes; W/O Gov.	362887C91	7410	Belt - Fan & Alt.; W/65A., 80A., 85A., 105A., 145A. Alt.	510238C91	②7585
Hose - Upper; W/Rad. Shutters; W/Metal Hood		26515	Belt - Fan & P.S.; W/64" Belt O.C.	479217C1	②◆9635HD
Hose - Upper; W/O Rad. Shutters; W/Metal Hood		20493	Belt - Fan & P.S.; W/66 1/2" Belt O.C.	488882C1	②◆9660HD
Hose - Lower - Eng. To Pipe; W/Auto. Trans.		20532	Belt - Fan & P.S.; W/A.P.; W/60 1/4" Belt O.C.	446707C1	◆9600HD
Hose - Lower; W/Man. Trans.		21308	Belt - Fan & P.S.; W/A.P.; W/63 1/4" Belt O.C.	395539R1	◆9630HD
Hose - By Pass		≈20357	Belt - Fan & P.S.; W/O A.P.		◆9510HD
1823			Belt - Fan & A.P.; W/O Calif. Emission System		◆9540HD
Belt - Fan & Alt.; W/37A., 52A., 61A. Alt.; C, G, H Chassis; W/P.T.O.	968815R11	②7650	Belt - P.S. & A.P.; W/Saginaw P.S. Pump		◆9720HD
Belt - Fan & Alt.; W/37A., 52A., 61A. Alt.; C, G, H Chassis; W/O P.T.O.	373457C91	②7612	Belt - P.S. & A.P.; W/Ross, Sheppard P.S. Pump	465244C1	◆9740HD
Belt - Fan & Alt.; W/37A., 52A., 61A. Alt.; FD, SB Chassis	968815R1	②7650	Belt - Air Brake Compr.; Jun. 19, 1980 & Older		◆9570HD
Belt - Fan & Alt.; W/37A., 61A. Alt.; W/O Air Brakes; W/O P.T.O.; W/O X.C.	373456C1	7612	Belt - Air Brake Compr.; Jun. 20, 1980 & Newer		◆9610HD
Belt - Fan & Alt.; W/55A., 62A. Alt.; C, G, H Chassis	369723C91	②7630	Belt - A.P.; W/Air Brakes; W/Calif. Emission System	132058R3	7350
Belt - Fan & Alt.; W/55A., 62A. Alt.; FD, SB Chassis	361975C91	②7673	Belt - A.P.; W/Hyd. Brakes; W/Calif. Emission System	468505C91	7490
Belt - Fan & Alt.; W/60A. Alt.	359009C91	②7680	Belt - A.P.; W/O P.T.O.; W/O Calif. Emission System	270094C2	◆9580HD
Belt - Fan & Alt.; W/65A., 80A., 105A., 145A. Alt.; W/P.T.O.	361975C91	②7673	Hose - Upper - To Center of Rad.		21132 or 26528
Belt - Fan & Alt.; W/65A., 80A., 105A., 145A. Alt.; W/O P.T.O.		②7630	Hose - Upper - To Right Hand Side of Rad.		21133 or 26528
Belt - P.S.; W/2WD		7460	Hose - Lower; W/Auto. Trans.		26532
Belt - P.S.; W/4WD	285522C2	7435	Hose - Lower; W/Man. Trans.		21129
Belt - Air Brake Compr.	359007C91	7475	International/Navistar MV446		
Belt - A.P.; W/Air Brakes; W/Gov.	388139C1	7330	1723; 1823		
Belt - A.P.; W/Air Brakes; W/O Gov.	256062C2	7340	Belt - Fan & Alt.; W/Front P.T.O.; W/42A., 61A. Alt.	863751R2	②7580
Belt - A.P.; W/Hyd. Brakes; W/Gov.	355653C91	7380	Belt - Fan & Alt.; W/O Front P.T.O.; W/42A., 61A. Alt.	355478C91	②7512
Belt - A.P.; W/Hyd. Brakes; W/O Gov.	362887C91	7410	Belt - Fan & Alt.; W/65A., 80A., 85A., 105A., 145A. Alt.	510238C91	②7585
Hose - Upper		21293	Belt - Fan & P.S.; W/64" Belt O.C.	479217C1	②◆9635HD
Hose - Lower		21292	Belt - Fan & P.S.; W/66 1/2" Belt O.C.	488882C1	②◆9660HD
1977			Belt - Fan & P.S.; W/A.P.; W/60 1/4" Belt O.C.	446707C1	◆9600HD
International/Navistar DT466 Diesel			Belt - Fan & P.S.; W/A.P.; W/63 1/4" Belt O.C.	395539R1	◆9630HD
1853FC			Belt - Fan & P.S.; W/O A.P.		◆9510HD
Hose - Lower		≈21291	Belt - Fan & A.P.; W/O Calif. Emission System		◆9540HD

School Buses

②Two Required.
◆Standard Belt Available.

≈Cut to Fit.
◆PowerBand Belt May Work, Use Template to Check.

Belts and Coolant Hose for School Buses

School Buses

Application	Mfr. Part No.	Our No.	Application	Mfr. Part No.	Our No.
International/Navistar - Continued			International/Navistar - Continued		
1977 - Continued			1977 - Continued		
International/Navistar MV446 - Continued			International/Navistar RD501 - Continued		
1723; 1823 - Continued			1823 - Continued		
Belt - P.S. & A.P.; W/Saginaw P.S. Pump		♣9720HD	Belt - Air Brake Compr.; W/Westinghouse		
Belt - P.S. & A.P.; W/Ross, Sheppard P.S.			Compr.	83816HA	TR34467
Pump	465244C1	♣9740HD	International/Navistar V266		
Belt - Air Brake Compr.; Jun. 19, 1980 & Older		♣9570HD	1603; 1703 (School Bus); 1803		
Belt - Air Brake Compr.; Jun. 20, 1980 & Newer		♣9610HD	Belt - Fan & Alt.; W/37A., 52A., 61A. Alt.; C, G, H		
Belt - A.P.; W/Air Brakes; W/Calif.			Chassis		②7603
Emission System	132058R3	7350	Belt - Fan & Alt.; W/37A., 52A., 61A. Alt.;		
Belt - A.P.; W/Hyd. Brakes; W/Calif.			FD, SB Chassis	255266C3	②7640
Emission System	468505C91	7490	Belt - Fan & Alt.; W/55A., 62A. Alt.; C, G, H		
Belt - A.P.; W/O P.T.O.; W/O Calif.			Chassis	369725C91	②7619
Emission System	270094C2	♣9580HD	Belt - Fan & Alt.; W/55A., 62A. Alt.; FD, SB		
Hose - Upper - To Center of Rad.		21132	Chassis	358998C91	②7650
		26528	Belt - P.S.; W/2WD	151529R2	7440
Hose - Upper - To Right Hand Side of Rad.		21133	Belt - P.S.; W/4WD	151531R2	7450
		26528	Belt - Air Brake Compr.	236572R2	7460
Hose - Lower; W/Auto. Trans.		26532	Hose - Upper; W/Rad. Shutters; W/Metal Hood		26515
Hose - Lower; W/Man. Trans.		21129	Hose - Upper; W/O Rad. Shutters; W/Metal Hood		20493
			Hose - Lower - Eng. To Pipe; W/Auto. Trans.		20532
			Hose - Lower; W/Man. Trans.		21308
			Hose - By Pass		♣<20357
International/Navistar RD372			International/Navistar V304		
1823			1603; 1703 (School Bus); 1803		
Belt - Fan & Alt.	359014C91	②TR22514	Belt - Fan & Alt.; W/37A., 52A., 61A. Alt.; C, G, H		
Belt - W.P. & Alt.; W/37A. Alt.; Chassis No.			Chassis		②7603
FD61626 & Before	193826R11	②TR22508	Belt - Fan & Alt.; W/37A., 52A., 61A. Alt.;		
Belt - W.P. & Alt.; W/37A. Alt.; Chassis No.			FD, SB Chassis	255266C3	②7640
FD61626 & Up & G Chassis No.	223794R11	②TR22514	Belt - Fan & Alt.; W/55A., 62A. Alt.; C, G, H		
Belt - W.P. & Alt.; W/60A. Alt.	243604R11	②TR22517	Chassis	369725C91	②7619
Belt - P.S.	240354R2	TR22336	Belt - Fan & Alt.; W/55A., 62A. Alt.; FD, SB		
Belt - Air Brake Compr.; W/Wagner Compr.	92836HA	TR32491	Chassis	358998C91	②7650
Belt - Air Brake Compr.; W/Westinghouse			Belt - P.S.; W/2WD	151529R2	7440
Compr.	83816HA	TR34467	Belt - P.S.; W/4WD	151531R2	7450
			Belt - Air Brake Compr.	236572R2	7460
			Hose - Upper; W/Rad. Shutters; W/Metal Hood		26515
			Hose - Upper; W/O Rad. Shutters; W/Metal Hood		20493
			Hose - Lower - Eng. To Pipe; W/Auto. Trans.		20532
			Hose - Lower; W/Man. Trans.		21308
			Hose - By Pass		♣<20357
International/Navistar RD406			International/Navistar V345		
1823			1603; 1703 (School Bus)		
Belt - Fan & Alt.	359014C91	②TR22514	Belt - Fan & Alt.; W/37A., 52A., 61A. Alt.;		
Belt - W.P. & Alt.; W/37A. Alt.; Chassis No.			C, G, H Chassis; W/P.T.O.	968815R11	②7650
FD61626 & Before	193826R11	②TR22508	Belt - Fan & Alt.; W/37A., 52A., 61A. Alt.;		
Belt - W.P. & Alt.; W/37A. Alt.; Chassis No.			C, G, H Chassis; W/O P.T.O.	373457C91	②7612
FD61626 & Up & G Chassis No.	223794R11	②TR22514	Belt - Fan & Alt.; W/37A., 52A., 61A. Alt.;		
Belt - W.P. & Alt.; W/60A. Alt.	243604R11	②TR22517	FD, SB Chassis	968815R1	②7650
Belt - P.S.	240354R2	TR22336	Belt - Fan & Alt.; W/37A., 61A. Alt.; W/O		
Belt - Air Brake Compr.; W/Wagner Compr.	92836HA	TR32491	Air Brakes; W/O P.T.O.; W/O X.C.	373456C1	7612
Belt - Air Brake Compr.; W/Westinghouse			Belt - Fan & Alt.; W/55A., 62A. Alt.; C, G, H		
Compr.	83816HA	TR34467	Chassis	369723C91	②7630
			Belt - Fan & Alt.; W/55A., 62A. Alt.; FD, SB		
			Chassis	361975C91	②7673
			Belt - Fan & Alt.; W/60A. Alt.	359009C91	②7680
			Belt - Fan & Alt.; W/65A., 80A., 105A.,		
			145A. Alt.; W/P.T.O.	361975C91	②7673
			Belt - Fan & Alt.; W/65A., 80A., 105A., 145A. Alt.; W/O		
			P.T.O.		②7630
			Belt - P.S.; W/2WD		7460
			Belt - P.S.; W/4WD	285522C2	7435
			Belt - Air Brake Compr.	359007C91	7475
			Belt - A.P.; W/Air Brakes; W/Gov.	388139C1	7330
			Belt - A.P.; W/Air Brakes; W/O Gov.	256062C2	7340
			Belt - A.P.; W/Hyd. Brakes; W/Gov.	355653C91	7380
			Belt - A.P.; W/Hyd. Brakes; W/O Gov.	362887C91	7410
			Hose - Upper; W/Rad. Shutters; W/Metal Hood		26515

♣Standard Belt Available.
 ♣<Cut to Fit.

②Two Required.

Belts and Coolant Hose for School Buses

Application	Mfr. Part No.	Our No.	Application	Mfr. Part No.	Our No.
International/Navistar - Continued			International/Navistar - Continued		
1977 - Continued			1977 - Continued		
International/Navistar V345 - Continued			International/Navistar V345 - Continued		
1603; 1703 (School Bus) - Continued			1823 - Continued		
Hose - Upper; W/O Rad. Shutters; W/Metal Hood		20493	Belt - Fan & Alt.; W/37A., 61A. Alt.; W/O Air Brakes; W/O P.T.O.; W/O X.C.	373456C1	7612
Hose - Lower - Eng. To Pipe; W/Auto. Trans.		20532	Belt - Fan & Alt.; W/55A., 62A. Alt.; C, G, H Chassis	369723C91	②7630
Hose - Lower; W/Man. Trans.		21308	Belt - Fan & Alt.; W/55A., 62A. Alt.; FD, SB Chassis	361975C91	②7673
Hose - By Pass		≈<20357	Belt - Fan & Alt.; W/60A. Alt.	359009C91	②7680
1723			Belt - Fan & Alt.; W/65A., 80A., 105A., 145A. Alt.; W/P.T.O.	361975C91	②7673
Belt - Fan & Alt.; W/37A., 52A., 61A. Alt.; C, G, H Chassis; W/P.T.O.	968815R11	②7650	Belt - Fan & Alt.; W/65A., 80A., 105A., 145A. Alt.; W/O P.T.O.		②7630
Belt - Fan & Alt.; W/37A., 52A., 61A. Alt.; C, G, H Chassis; W/O P.T.O.	373457C91	②7612	Belt - P.S.; W/2WD		7460
Belt - Fan & Alt.; W/37A., 52A., 61A. Alt.; FD, SB Chassis	968815R1	②7650	Belt - P.S.; W/4WD	285522C2	7435
Belt - Fan & Alt.; W/37A., 61A. Alt.; W/O Air Brakes; W/O P.T.O.; W/O X.C.	373456C1	7612	Belt - Air Brake Compr.	359007C91	7475
Belt - Fan & Alt.; W/55A., 62A. Alt.; C, G, H Chassis	369723C91	②7630	Belt - A.P.; W/Air Brakes; W/Gov.	388139C1	7330
Belt - Fan & Alt.; W/55A., 62A. Alt.; FD, SB Chassis	361975C91	②7673	Belt - A.P.; W/Air Brakes; W/O Gov.	256062C2	7340
Belt - Fan & Alt.; W/60A. Alt.	359009C91	②7680	Belt - A.P.; W/Hyd. Brakes; W/Gov.	355653C91	7380
Belt - Fan & Alt.; W/65A., 80A., 105A., 145A. Alt.; W/P.T.O.	361975C91	②7673	Belt - A.P.; W/Hyd. Brakes; W/O Gov.	362887C91	7410
Belt - Fan & Alt.; W/65A., 80A., 105A., 145A. Alt.; W/O P.T.O.		②7630	1803		
Belt - P.S.; W/2WD		7460	Belt - Fan & Alt.; W/37A., 52A., 61A. Alt.; C, G, H Chassis; W/P.T.O.	968815R11	②7650
Belt - P.S.; W/4WD	285522C2	7435	Belt - Fan & Alt.; W/37A., 52A., 61A. Alt.; C, G, H Chassis; W/O P.T.O.	373457C91	②7612
Belt - Air Brake Compr.	359007C91	7475	Belt - Fan & Alt.; W/37A., 52A., 61A. Alt.; FD, SB Chassis	968815R1	②7650
Belt - A.P.; W/Air Brakes; W/Gov.	388139C1	7330	Belt - Fan & Alt.; W/37A., 61A. Alt.; W/O Air Brakes; W/O P.T.O.; W/O X.C.	373456C1	7612
Belt - A.P.; W/Air Brakes; W/O Gov.	256062C2	7340	Belt - Fan & Alt.; W/55A., 62A. Alt.; C, G, H Chassis	369723C91	②7630
Belt - A.P.; W/Hyd. Brakes; W/Gov.	355653C91	7380	Belt - Fan & Alt.; W/55A., 62A. Alt.; FD, SB Chassis	361975C91	②7673
Belt - A.P.; W/Hyd. Brakes; W/O Gov.	362887C91	7410	Belt - Fan & Alt.; W/60A. Alt.	359009C91	②7680
Belt - Fan & Alt.; W/37A., 52A., 61A. Alt.; C, G, H Chassis; W/P.T.O.	968815R11	②7650	Belt - Fan & Alt.; W/65A., 80A., 105A., 145A. Alt.; W/P.T.O.	361975C91	②7673
Belt - Fan & Alt.; W/37A., 52A., 61A. Alt.; C, G, H Chassis; W/O P.T.O.	373457C91	②7612	Belt - Fan & Alt.; W/65A., 80A., 105A., 145A. Alt.; W/O P.T.O.		②7630
Belt - Fan & Alt.; W/37A., 52A., 61A. Alt.; FD, SB Chassis	968815R1	②7650	Belt - P.S.; W/2WD		7460
Belt - Fan & Alt.; W/37A., 61A. Alt.; W/O Air Brakes; W/O P.T.O.; W/O X.C.	373456C1	7612	Belt - P.S.; W/4WD	285522C2	7435
Belt - Fan & Alt.; W/55A., 62A. Alt.; C, G, H Chassis	369723C91	②7630	Belt - Air Brake Compr.	359007C91	7475
Belt - Fan & Alt.; W/55A., 62A. Alt.; FD, SB Chassis	361975C91	②7673	Belt - A.P.; W/Air Brakes; W/Gov.	388139C1	7330
Belt - Fan & Alt.; W/60A. Alt.	359009C91	②7680	Belt - A.P.; W/Air Brakes; W/O Gov.	256062C2	7340
Belt - Fan & Alt.; W/65A., 80A., 105A., 145A. Alt.; W/P.T.O.	361975C91	②7673	Belt - A.P.; W/Hyd. Brakes; W/Gov.	355653C91	7380
Belt - Fan & Alt.; W/65A., 80A., 105A., 145A. Alt.; W/O P.T.O.		②7630	Belt - A.P.; W/Hyd. Brakes; W/O Gov.	362887C91	7410
Belt - P.S.; W/2WD		7460	Hose - Upper; W/Rad. Shutters; W/Metal Hood		26515
Belt - P.S.; W/4WD	285522C2	7435	Hose - Upper; W/O Rad. Shutters; W/Metal Hood		20493
Belt - Air Brake Compr.	359007C91	7475	Hose - Lower - Eng. To Pipe; W/Auto. Trans.		20532
Belt - A.P.; W/Air Brakes; W/Gov.	388139C1	7330	Hose - Lower; W/Man. Trans.		21308
Belt - A.P.; W/Air Brakes; W/O Gov.	256062C2	7340	Hose - By Pass		≈<20357
Belt - A.P.; W/Hyd. Brakes; W/Gov.	355653C91	7380	1723		
Belt - A.P.; W/Hyd. Brakes; W/O Gov.	362887C91	7410	Belt - Fan & Alt.; W/37A., 52A., 61A. Alt.; C, G, H Chassis; W/P.T.O.	968815R11	②7650
Hose - Upper; W/Rad. Shutters; W/Metal Hood		26515	Belt - Fan & Alt.; W/37A., 52A., 61A. Alt.; C, G, H Chassis; W/O P.T.O.	373457C91	②7612
Hose - Upper; W/O Rad. Shutters; W/Metal Hood		20493	Belt - Fan & Alt.; W/37A., 52A., 61A. Alt.; FD, SB Chassis	968815R1	②7650
Hose - Lower - Eng. To Pipe; W/Auto. Trans.		20532	Belt - Fan & Alt.; W/37A., 61A. Alt.; W/O Air Brakes; W/O P.T.O.; W/O X.C.	373456C1	7612
Hose - Lower; W/Man. Trans.		21308	Belt - Fan & Alt.; W/55A., 62A. Alt.; C, G, H Chassis	369723C91	②7630
Hose - By Pass		≈<20357	Belt - Fan & Alt.; W/55A., 62A. Alt.; FD, SB Chassis	361975C91	②7673
1823			Belt - Fan & Alt.; W/60A. Alt.	359009C91	②7680
Belt - Fan & Alt.; W/37A., 52A., 61A. Alt.; C, G, H Chassis; W/P.T.O.	968815R11	②7650	Belt - Fan & Alt.; W/65A., 80A., 105A., 145A. Alt.; W/P.T.O.	361975C91	②7673
Belt - Fan & Alt.; W/37A., 52A., 61A. Alt.; C, G, H Chassis; W/O P.T.O.	373457C91	②7612	Belt - Fan & Alt.; W/65A., 80A., 105A., 145A. Alt.; W/O P.T.O.		②7630
Belt - Fan & Alt.; W/37A., 52A., 61A. Alt.; FD, SB Chassis	968815R1	②7650			

≈<Cut to Fit.

②Two Required.

School Buses

Belts and Coolant Hose for School Buses

School Buses

Application	Mfr. Part No.	Our No.	Application	Mfr. Part No.	Our No.
International/Navistar - Continued			International/Navistar - Continued		
1977 - Continued			1977 - Continued		
International/Navistar V392 - Continued			International/Navistar V401 - Continued		
1723 - Continued			1603; 1703 (School Bus); 1803 - Continued		
Belt - P.S.; W/2WD		7460	Belt - Alt.; W/65A., 80A. Alt.	151531R2	②7450
Belt - P.S.; W/4WD	285522C2	7435	Belt - Alt. & Air Brake Compr.; W/37A., 61A. Alt.		②7541
Belt - Air Brake Compr.	359007C91	7475	Belt - Alt. & Air Brake Compr.; W/65A., 80A. Alt.	358344C91	②7560
Belt - A.P.; W/Air Brakes; W/Gov.	388139C1	7330	Belt - P.S.	358335C91	②◆◆9490HD
Belt - A.P.; W/Air Brakes; W/O Gov.	256062C2	7340	International/Navistar V461		
Belt - A.P.; W/Hyd. Brakes; W/Gov.	355653C91	7380	1603; 1703 (School Bus); 1803		
Belt - A.P.; W/Hyd. Brakes; W/O Gov.	362887C91	7410	Belt - Fan		②◆◆9476HD
1803			Belt - Alt.; W/37A., 61A. Alt.	359006C91	②7417
Belt - Fan & Alt.; W/37A., 52A., 61A. Alt.; C, G, H Chassis; W/P.T.O.	968815R11	②7650	Belt - Alt.; W/65A., 80A. Alt.	151531R2	②7450
Belt - Fan & Alt.; W/37A., 52A., 61A. Alt.; C, G, H Chassis; W/O P.T.O.	373457C91	②7612	Belt - Alt. & Air Brake Compr.; W/37A., 61A. Alt.		②7541
Belt - Fan & Alt.; W/37A., 52A., 61A. Alt.; FD, SB Chassis	968815R1	②7650	Belt - Alt. & Air Brake Compr.; W/65A., 80A. Alt.	358344C91	②7560
Belt - Fan & Alt.; W/37A., 61A. Alt.; W/O Air Brakes; W/O P.T.O.; W/O X.C.	373456C1	7612	Belt - P.S.	358335C91	②◆◆9490HD
Belt - Fan & Alt.; W/55A., 62A. Alt.; C, G, H Chassis	369723C91	②7630	International/Navistar V478		
Belt - Fan & Alt.; W/55A., 62A. Alt.; FD, SB Chassis	361975C91	②7673	1603; 1703 (School Bus); 1803		
Belt - Fan & Alt.; W/60A. Alt.	359009C91	②7680	Belt - Fan		②◆◆9476HD
Belt - Fan & Alt.; W/65A., 80A., 105A., 145A. Alt.; W/P.T.O.	361975C91	②7673	Belt - Alt.; W/37A., 61A. Alt.	359006C91	②7417
Belt - Fan & Alt.; W/65A., 80A., 105A., 145A. Alt.; W/O P.T.O.		②7630	Belt - Alt.; W/65A., 80A. Alt.	151531R2	②7450
Belt - P.S.; W/2WD		7460	Belt - Alt. & Air Brake Compr.; W/37A., 61A. Alt.		②7541
Belt - P.S.; W/4WD	285522C2	7435	Belt - Alt. & Air Brake Compr.; W/65A., 80A. Alt.	358344C91	②7560
Belt - Air Brake Compr.	359007C91	7475	Belt - P.S.	358335C91	②◆◆9490HD
Belt - A.P.; W/Air Brakes; W/Gov.	388139C1	7330	International/Navistar V549		
Belt - A.P.; W/Air Brakes; W/O Gov.	256062C2	7340	1603; 1703 (School Bus); 1803		
Belt - A.P.; W/Hyd. Brakes; W/Gov.	355653C91	7380	Belt - Fan		②◆◆9476HD
Belt - A.P.; W/Hyd. Brakes; W/O Gov.	362887C91	7410	Belt - Alt.; W/37A., 61A. Alt.	359006C91	②7417
Hose - Upper; W/Rad. Shutters; W/Metal Hood		26515	Belt - Alt.; W/65A., 80A. Alt.	151531R2	②7450
Hose - Upper; W/O Rad. Shutters; W/Metal Hood		20493	Belt - Alt. & Air Brake Compr.; W/37A., 61A. Alt.		②7541
Hose - Lower - Eng. To Pipe; W/Auto. Trans.		20532	Belt - Alt. & Air Brake Compr.; W/65A., 80A. Alt.	358344C91	②7560
Hose - Lower; W/Man. Trans.		21308	Belt - P.S.	358335C91	②◆◆9490HD
Hose - By Pass		≈20357	International/Navistar VS401		
1823			1603; 1703 (School Bus); 1803		
Belt - Fan & Alt.; W/37A., 52A., 61A. Alt.; C, G, H Chassis; W/P.T.O.	968815R11	②7650	Belt - Fan		②◆◆9476HD
Belt - Fan & Alt.; W/37A., 52A., 61A. Alt.; C, G, H Chassis; W/O P.T.O.	373457C91	②7612	Belt - Alt.; W/37A., 61A. Alt.	359006C91	②7417
Belt - Fan & Alt.; W/37A., 52A., 61A. Alt.; FD, SB Chassis	968815R1	②7650	Belt - Alt.; W/65A., 80A. Alt.	151531R2	②7450
Belt - Fan & Alt.; W/37A., 61A. Alt.; W/O Air Brakes; W/O P.T.O.; W/O X.C.	373456C1	7612	Belt - Alt. & Air Brake Compr.; W/37A., 61A. Alt.		②7541
Belt - Fan & Alt.; W/55A., 62A. Alt.; C, G, H Chassis	369723C91	②7630	Belt - Alt. & Air Brake Compr.; W/65A., 80A. Alt.	358344C91	②7560
Belt - Fan & Alt.; W/55A., 62A. Alt.; FD, SB Chassis	361975C91	②7673	Belt - P.S.	358335C91	②◆◆9490HD
Belt - Fan & Alt.; W/60A. Alt.	359009C91	②7680	International/Navistar VS478		
Belt - Fan & Alt.; W/65A., 80A., 105A., 145A. Alt.; W/P.T.O.	361975C91	②7673	1603; 1703 (School Bus); 1803		
Belt - Fan & Alt.; W/65A., 80A., 105A., 145A. Alt.; W/O P.T.O.		②7630	Belt - Fan		②◆◆9476HD
Belt - P.S.; W/2WD		7460	Belt - Alt.; W/37A., 61A. Alt.	359006C91	②7417
Belt - P.S.; W/4WD	285522C2	7435	Belt - Alt.; W/65A., 80A. Alt.	151531R2	②7450
Belt - Air Brake Compr.	359007C91	7475	Belt - Alt. & Air Brake Compr.; W/37A., 61A. Alt.		②7541
Belt - A.P.; W/Air Brakes; W/Gov.	388139C1	7330	Belt - Alt. & Air Brake Compr.; W/65A., 80A. Alt.	358344C91	②7560
Belt - A.P.; W/Air Brakes; W/O Gov.	256062C2	7340	Belt - P.S.	358335C91	②◆◆9490HD
Belt - A.P.; W/Hyd. Brakes; W/Gov.	355653C91	7380	International/Navistar VS549		
Belt - A.P.; W/Hyd. Brakes; W/O Gov.	362887C91	7410	1603; 1703 (School Bus); 1803		
International/Navistar V401			Belt - Fan		②◆◆9476HD
1603; 1703 (School Bus); 1803			Belt - Alt.; W/37A., 61A. Alt.	359006C91	②7417
Belt - Fan		②◆◆9476HD	Belt - Alt.; W/65A., 80A. Alt.	151531R2	②7450
Belt - Alt.; W/37A., 61A. Alt.	359006C91	②7417	Belt - Alt. & Air Brake Compr.; W/37A., 61A. Alt.		②7541

②Two Required.
◆Standard Belt Available.

≈Cut to Fit.
◆PowerBand Belt May Work, Use Template to Check.

Belts and Coolant Hose for School Buses

Application	Mfr. Part No.	Our No.	Application	Mfr. Part No.	Our No.
International/Navistar - Continued			International/Navistar - Continued		
1976			1976 - Continued		
International/Navistar DT466 Diesel			International/Navistar RD406 - Continued		
1853FC			1823 - Continued		
Hose - Lower		≈21291	Belt - W.P. & Alt.; W/37A. Alt.; Chassis No. FD61626 & Up & G Chassis No.	223794R11	②TR22514
International/Navistar FTV549			Belt - W.P. & Alt.; W/60A. Alt.	243604R11	②TR22517
1603; 1703 (School Bus); 1803			Belt - P.S.	240354R2	TR22336
Belt - Fan	②◆◆9476HD		Belt - Air Brake Compr.; W/Wagner Compr.	92836HA	TR32491
Belt - Alt.; W/37A., 61A. Alt.	359006C91	②7417	Belt - Air Brake Compr.; W/Westinghouse Compr.	83816HA	TR34467
Belt - Alt.; W/65A., 80A. Alt.	151531R2	②7450	International/Navistar RD450		
Belt - Alt. & Air Brake Compr.; W/37A., 61A. Alt.		②7541	1823		
Belt - Alt. & Air Brake Compr.; W/65A., 80A. Alt.	358344C91	②7560	Belt - Fan & Alt.	359014C91	②TR22514
Belt - P.S.	358335C91	②◆◆9490HD	Belt - W.P. & Alt.; W/37A. Alt.; Chassis No. FD61626 & Before	193826R11	②TR22508
International/Navistar FTVS549			Belt - W.P. & Alt.; W/37A. Alt.; Chassis No. FD61626 & Up & G Chassis No.	223794R11	②TR22514
1603; 1703 (School Bus); 1803			Belt - W.P. & Alt.; W/60A. Alt.	243604R11	②TR22517
Belt - Fan	②◆◆9476HD		Belt - P.S.	240354R2	TR22336
Belt - Alt.; W/37A., 61A. Alt.	359006C91	②7417	Belt - Air Brake Compr.; W/Wagner Compr.	92836HA	TR32491
Belt - Alt.; W/65A., 80A. Alt.	151531R2	②7450	Belt - Air Brake Compr.; W/Westinghouse Compr.	83816HA	TR34467
Belt - Alt. & Air Brake Compr.; W/37A., 61A. Alt.		②7541	International/Navistar RD501		
Belt - Alt. & Air Brake Compr.; W/65A., 80A. Alt.	358344C91	②7560	1823		
Belt - P.S.	358335C91	②◆◆9490HD	Belt - Fan & Alt.	359014C91	②TR22514
International/Navistar MV404			Belt - W.P. & Alt.; W/37A. Alt.; Chassis No. FD61626 & Before	193826R11	②TR22508
1723; 1823			Belt - W.P. & Alt.; W/37A. Alt.; Chassis No. FD61626 & Up & G Chassis No.	223794R11	②TR22514
Belt - Fan & Alt.; W/A.P.	863751R2	②7580	Belt - W.P. & Alt.; W/60A. Alt.	243604R11	②TR22517
Belt - Fan & Alt.; W/O A.P.	151532R2	②7512	Belt - P.S.	240354R2	TR22336
Belt - P.S.	270094C2	◆9580HD	Belt - Air Brake Compr.; W/Wagner Compr.	92836HA	TR32491
Belt - Air Brake Compr.; W/Front P.T.O.	379422C1	◆9540HD	Belt - Air Brake Compr.; W/Westinghouse Compr.	83816HA	TR34467
Belt - Air Brake Compr.; W/O Front P.T.O.	261710C2	◆9570HD	International/Navistar V266		
Hose - Upper - To Center of Rad.		21132	1603; 1703 (School Bus); 1803		
	or	26528	Belt - Fan & Alt.; W/37A., 52A., 61A. Alt.; C, G, H Chassis		
Hose - Upper - To Right Hand Side of Rad.		21133			②7603
	or	26528	Belt - Fan & Alt.; W/37A., 52A., 61A. Alt.; FD, SB Chassis	255266C3	②7640
Hose - Lower; W/Auto. Trans.		26532	Belt - Fan & Alt.; W/55A., 62A. Alt.; C, G, H Chassis	369725C91	②7619
Hose - Lower; W/Man. Trans.		21129	Belt - Fan & Alt.; W/55A., 62A. Alt.; FD, SB Chassis	358998C91	②7650
International/Navistar MV446			Belt - P.S.; W/2WD	151529R2	7440
1723; 1823			Belt - P.S.; W/4WD	151531R2	7450
Belt - Fan & Alt.; W/A.P.	863751R2	②7580	Belt - Air Brake Compr.	236572R2	7460
Belt - Fan & Alt.; W/O A.P.	151532R2	②7512	Hose - Upper; W/Rad. Shutters; W/Metal Hood		26515
Belt - P.S.	270094C2	◆9580HD	Hose - Upper; W/O Rad. Shutters; W/Metal Hood		20493
Belt - Air Brake Compr.; W/Front P.T.O.	379422C1	◆9540HD	Hose - Lower - Eng. To Pipe; W/Auto. Trans.		20532
Belt - Air Brake Compr.; W/O Front P.T.O.	261710C2	◆9570HD	Hose - Lower; W/Man. Trans.		21308
Hose - Upper - To Center of Rad.		21132	Hose - By Pass		≈20357
	or	26528	International/Navistar V304		
Hose - Upper - To Right Hand Side of Rad.		21133	1603; 1703 (School Bus); 1803		
	or	26528	Belt - Fan & Alt.; W/37A., 52A., 61A. Alt.; C, G, H Chassis		
Hose - Lower; W/Auto. Trans.		26532			②7603
Hose - Lower; W/Man. Trans.		21129	Belt - Fan & Alt.; W/37A., 52A., 61A. Alt.; FD, SB Chassis	255266C3	②7640
International/Navistar RD372			Belt - Fan & Alt.; W/55A., 62A. Alt.; C, G, H Chassis	369725C91	②7619
1823			Belt - Fan & Alt.; W/55A., 62A. Alt.; FD, SB Chassis	358998C91	②7650
Belt - Fan & Alt.	359014C91	②TR22514	Belt - P.S.; W/2WD	151529R2	7440
Belt - W.P. & Alt.; W/37A. Alt.; Chassis No. FD61626 & Before	193826R11	②TR22508	Belt - P.S.; W/4WD	151531R2	7450
Belt - W.P. & Alt.; W/37A. Alt.; Chassis No. FD61626 & Up & G Chassis No.	223794R11	②TR22514	Belt - Air Brake Compr.	236572R2	7460
Belt - W.P. & Alt.; W/60A. Alt.	243604R11	②TR22517	Hose - Upper; W/Rad. Shutters; W/Metal Hood		26515
Belt - P.S.	240354R2	TR22336	Hose - Upper; W/O Rad. Shutters; W/Metal Hood		20493
Belt - Air Brake Compr.; W/Wagner Compr.	92836HA	TR32491	International/Navistar RD406		
Belt - Air Brake Compr.; W/Westinghouse Compr.	83816HA	TR34467	1823		
International/Navistar RD406			Belt - Fan & Alt.		
1823			Belt - W.P. & Alt.; W/37A. Alt.; Chassis No. FD61626 & Before		
Belt - Fan & Alt.	359014C91	②TR22514	193826R11		
Belt - W.P. & Alt.; W/37A. Alt.; Chassis No. FD61626 & Before	193826R11	②TR22508			

◆Standard Belt Available.
②Two Required.

◆PowerBand Belt May Work, Use Template to Check.
≈Cut to Fit.

School Buses

Belts and Coolant Hose for School Buses

School Buses

Application	Mfr. Part No.	Our No.	Application	Mfr. Part No.	Our No.
International/Navistar - Continued			International/Navistar - Continued		
1976 - Continued			1976 - Continued		
International/Navistar V304 - Continued			International/Navistar V345 - Continued		
1603; 1703 (School Bus); 1803 - Continued			1803 - Continued		
Hose - Lower - Eng. To Pipe; W/Auto. Trans.		20532	Belt - Fan & Alt.; W/37A., 61A. Alt.; W/O Air Brakes; W/O P.T.O.; W/O X.C.	373456C1	7612
Hose - Lower; W/Man. Trans.		21308	Belt - Fan & Alt.; W/55A., 62A. Alt.; C, G, H Chassis	369723C91	②7630
Hose - By Pass		≈<20357	Belt - Fan & Alt.; W/55A., 62A. Alt.; FD, SB Chassis	361975C91	②7673
International/Navistar V345			Belt - Fan & Alt.; W/60A. Alt.		
1603; 1703 (School Bus)			Belt - Fan & Alt.; W/65A., 80A., 105A., 145A. Alt.; W/P.T.O.		
Belt - Fan & Alt.; W/37A., 52A., 61A. Alt.; C, G, H Chassis; W/P.T.O.	968815R11	②7650	Belt - Fan & Alt.; W/65A., 80A., 105A., 145A. Alt.; W/O P.T.O.		
Belt - Fan & Alt.; W/37A., 52A., 61A. Alt.; C, G, H Chassis; W/O P.T.O.	373457C91	②7612	Belt - P.S.; W/2WD		
Belt - Fan & Alt.; W/37A., 52A., 61A. Alt.; FD, SB Chassis	968815R1	②7650	Belt - P.S.; W/4WD		
Belt - Fan & Alt.; W/37A., 61A. Alt.; W/O Air Brakes; W/O P.T.O.; W/O X.C.	373456C1	7612	Belt - Air Brake Compr.		
Belt - Fan & Alt.; W/55A., 62A. Alt.; C, G, H Chassis	369723C91	②7630	Belt - A.P.; W/Air Brakes; W/Gov.		
Belt - Fan & Alt.; W/55A., 62A. Alt.; FD, SB Chassis	361975C91	②7673	Belt - A.P.; W/Air Brakes; W/O Gov.		
Belt - Fan & Alt.; W/60A. Alt.	359009C91	②7680	Belt - A.P.; W/Hyd. Brakes; W/Gov.		
Belt - Fan & Alt.; W/65A., 80A., 105A., 145A. Alt.; W/P.T.O.	361975C91	②7673	Belt - A.P.; W/Hyd. Brakes; W/O Gov.		
Belt - Fan & Alt.; W/65A., 80A., 105A., 145A. Alt.; W/O P.T.O.		②7630	Hose - Upper; W/Rad. Shutters; W/Metal Hood		
Belt - P.S.; W/2WD		7460	Hose - Upper; W/O Rad. Shutters; W/Metal Hood		
Belt - P.S.; W/4WD	285522C2	7435	Hose - Lower - Eng. To Pipe; W/Auto. Trans.		
Belt - Air Brake Compr.	359007C91	7475	Hose - Lower; W/Man. Trans.		
Belt - A.P.; W/Air Brakes; W/Gov.	388139C1	7330	Hose - By Pass		
Belt - A.P.; W/Air Brakes; W/O Gov.	256062C2	7340	1723		
Belt - A.P.; W/Hyd. Brakes; W/Gov.	355653C91	7380	Belt - Fan & Alt.; W/37A., 52A., 61A. Alt.; C, G, H Chassis; W/P.T.O.		
Belt - A.P.; W/Hyd. Brakes; W/O Gov.	362887C91	7410	Belt - Fan & Alt.; W/37A., 52A., 61A. Alt.; C, G, H Chassis; W/O P.T.O.		
Hose - Upper; W/Rad. Shutters; W/Metal Hood		26515	Belt - Fan & Alt.; W/37A., 52A., 61A. Alt.; FD, SB Chassis		
Hose - Upper; W/O Rad. Shutters; W/Metal Hood		20493	Belt - Fan & Alt.; W/37A., 61A. Alt.; W/O Air Brakes; W/O P.T.O.; W/O X.C.		
Hose - Lower - Eng. To Pipe; W/Auto. Trans.		20532	Belt - Fan & Alt.; W/55A., 62A. Alt.; C, G, H Chassis		
Hose - Lower; W/Man. Trans.		21308	Belt - Fan & Alt.; W/55A., 62A. Alt.; FD, SB Chassis		
Hose - By Pass		≈<20357	Belt - Fan & Alt.; W/55A., 62A. Alt.; FD, SB Chassis		
1723			Belt - Fan & Alt.; W/60A. Alt.		
Belt - Fan & Alt.; W/37A., 52A., 61A. Alt.; C, G, H Chassis; W/P.T.O.	968815R11	②7650	Belt - Fan & Alt.; W/65A., 80A., 105A., 145A. Alt.; W/P.T.O.		
Belt - Fan & Alt.; W/37A., 52A., 61A. Alt.; C, G, H Chassis; W/O P.T.O.	373457C91	②7612	Belt - Fan & Alt.; W/65A., 80A., 105A., 145A. Alt.; W/O P.T.O.		
Belt - Fan & Alt.; W/37A., 52A., 61A. Alt.; FD, SB Chassis	968815R1	②7650	Belt - P.S.; W/2WD		
Belt - Fan & Alt.; W/37A., 61A. Alt.; W/O Air Brakes; W/O P.T.O.; W/O X.C.	373456C1	7612	Belt - P.S.; W/4WD		
Belt - Fan & Alt.; W/55A., 62A. Alt.; C, G, H Chassis	369723C91	②7630	Belt - Air Brake Compr.		
Belt - Fan & Alt.; W/55A., 62A. Alt.; FD, SB Chassis	361975C91	②7673	Belt - A.P.; W/Air Brakes; W/Gov.		
Belt - Fan & Alt.; W/60A. Alt.	359009C91	②7680	Belt - A.P.; W/Air Brakes; W/O Gov.		
Belt - Fan & Alt.; W/65A., 80A., 105A., 145A. Alt.; W/P.T.O.	361975C91	②7673	Belt - A.P.; W/Hyd. Brakes; W/Gov.		
Belt - Fan & Alt.; W/65A., 80A., 105A., 145A. Alt.; W/O P.T.O.		②7630	Belt - A.P.; W/Hyd. Brakes; W/O Gov.		
Belt - P.S.; W/2WD		7460	1803		
Belt - P.S.; W/4WD	285522C2	7435	Belt - Fan & Alt.; W/37A., 52A., 61A. Alt.; C, G, H Chassis; W/P.T.O.		
Belt - Air Brake Compr.	359007C91	7475	Belt - Fan & Alt.; W/37A., 52A., 61A. Alt.; C, G, H Chassis; W/O P.T.O.		
Belt - A.P.; W/Air Brakes; W/Gov.	388139C1	7330	Belt - Fan & Alt.; W/37A., 52A., 61A. Alt.; FD, SB Chassis		
Belt - A.P.; W/Air Brakes; W/O Gov.	256062C2	7340	Belt - Fan & Alt.; W/37A., 61A. Alt.; W/O Air Brakes; W/O P.T.O.; W/O X.C.		
Belt - A.P.; W/Hyd. Brakes; W/Gov.	355653C91	7380	Belt - Fan & Alt.; W/55A., 62A. Alt.; C, G, H Chassis		
Belt - A.P.; W/Hyd. Brakes; W/O Gov.	362887C91	7410	Belt - Fan & Alt.; W/55A., 62A. Alt.; FD, SB Chassis		
International/Navistar V392			International/Navistar V392		
1603; 1703 (School Bus)			1603; 1703 (School Bus)		
Belt - Fan & Alt.; W/37A., 52A., 61A. Alt.; C, G, H Chassis; W/P.T.O.	968815R11	②7650	Belt - Fan & Alt.; W/37A., 52A., 61A. Alt.; C, G, H Chassis; W/O P.T.O.		
Belt - Fan & Alt.; W/37A., 52A., 61A. Alt.; C, G, H Chassis; W/O P.T.O.	373457C91	②7612	Belt - Fan & Alt.; W/37A., 52A., 61A. Alt.; FD, SB Chassis		
Belt - Fan & Alt.; W/37A., 52A., 61A. Alt.; FD, SB Chassis	968815R1	②7650	Belt - Fan & Alt.; W/37A., 61A. Alt.; W/O Air Brakes; W/O P.T.O.; W/O X.C.		
Belt - Fan & Alt.; W/37A., 61A. Alt.; W/O Air Brakes; W/O P.T.O.; W/O X.C.	373456C1	7612	Belt - Fan & Alt.; W/55A., 62A. Alt.; C, G, H Chassis		
Belt - Fan & Alt.; W/55A., 62A. Alt.; C, G, H Chassis	369723C91	②7630	Belt - Fan & Alt.; W/55A., 62A. Alt.; FD, SB Chassis		
Belt - Fan & Alt.; W/55A., 62A. Alt.; FD, SB Chassis	361975C91	②7673	Belt - Fan & Alt.; W/60A. Alt.		
Belt - Fan & Alt.; W/60A. Alt.	359009C91	②7680	Belt - Fan & Alt.; W/65A., 80A., 105A., 145A. Alt.; W/P.T.O.		
Belt - Fan & Alt.; W/65A., 80A., 105A., 145A. Alt.; W/P.T.O.	361975C91	②7673	Belt - Fan & Alt.; W/65A., 80A., 105A., 145A. Alt.; W/O P.T.O.		
Belt - Fan & Alt.; W/65A., 80A., 105A., 145A. Alt.; W/O P.T.O.		②7630			

≈<Cut to Fit.

②Two Required.

Belts and Coolant Hose for School Buses

Application	Mfr. Part No.	Our No.	Application	Mfr. Part No.	Our No.
International/Navistar - Continued			International/Navistar - Continued		
1976 - Continued			1976 - Continued		
International/Navistar V392 - Continued			International/Navistar V392 - Continued		
1603; 1703 (School Bus) - Continued			1823		
Belt - P.S.; W/2WD		7460	Belt - Fan & Alt.; W/37A., 52A., 61A. Alt.; C, G, H Chassis; W/P.T.O.	968815R11	②7650
Belt - P.S.; W/4WD	285522C2	7435	Belt - Fan & Alt.; W/37A., 52A., 61A. Alt.; C, G, H Chassis; W/O P.T.O.	373457C91	②7612
Belt - Air Brake Compr.	359007C91	7475	Belt - Fan & Alt.; W/37A., 52A., 61A. Alt.; FD, SB Chassis	968815R1	②7650
Belt - A.P.; W/Air Brakes; W/Gov.	388139C1	7330	Belt - Fan & Alt.; W/37A., 61A. Alt.; W/O Air Brakes; W/O P.T.O.; W/O X.C.	373456C1	7612
Belt - A.P.; W/Air Brakes; W/O Gov.	256062C2	7340	Belt - Fan & Alt.; W/55A., 62A. Alt.; C, G, H Chassis	369723C91	②7630
Belt - A.P.; W/Hyd. Brakes; W/Gov.	355653C91	7380	Belt - Fan & Alt.; W/55A., 62A. Alt.; FD, SB Chassis	361975C91	②7673
Belt - A.P.; W/Hyd. Brakes; W/O Gov.	362887C91	7410	Belt - Fan & Alt.; W/60A. Alt.	359009C91	②7680
Hose - Upper; W/Rad. Shutters; W/Metal Hood	26515		Belt - Fan & Alt.; W/65A., 80A., 105A., 145A. Alt.; W/P.T.O.	361975C91	②7673
Hose - Upper; W/O Rad. Shutters; W/Metal Hood	20493		Belt - Fan & Alt.; W/65A., 80A., 105A., 145A. Alt.; W/O P.T.O.		②7630
Hose - Lower - Eng. To Pipe; W/Auto. Trans.	20532		Belt - P.S.; W/2WD		7460
Hose - Lower; W/Man. Trans.	21308		Belt - P.S.; W/4WD	285522C2	7435
Hose - By Pass	≈<20357		Belt - Air Brake Compr.	359007C91	7475
1723			Belt - A.P.; W/Air Brakes; W/Gov.	388139C1	7330
Belt - Fan & Alt.; W/37A., 52A., 61A. Alt.; C, G, H Chassis; W/P.T.O.	968815R11	②7650	Belt - A.P.; W/Air Brakes; W/O Gov.	256062C2	7340
Belt - Fan & Alt.; W/37A., 52A., 61A. Alt.; C, G, H Chassis; W/O P.T.O.	373457C91	②7612	Belt - A.P.; W/Hyd. Brakes; W/Gov.	355653C91	7380
Belt - Fan & Alt.; W/37A., 52A., 61A. Alt.; FD, SB Chassis	968815R1	②7650	Belt - A.P.; W/Hyd. Brakes; W/O Gov.	362887C91	7410
Belt - Fan & Alt.; W/37A., 61A. Alt.; W/O Air Brakes; W/O P.T.O.; W/O X.C.	373456C1	7612	International/Navistar V401		
Belt - Fan & Alt.; W/55A., 62A. Alt.; C, G, H Chassis	369723C91	②7630	1603; 1703 (School Bus); 1803		
Belt - Fan & Alt.; W/55A., 62A. Alt.; FD, SB Chassis	361975C91	②7673	Belt - Fan	②♠◆9476HD	
Belt - Fan & Alt.; W/60A. Alt.	359009C91	②7680	Belt - Alt.; W/37A., 61A. Alt.	359006C91	②7417
Belt - Fan & Alt.; W/65A., 80A., 105A., 145A. Alt.; W/P.T.O.	361975C91	②7673	Belt - Alt.; W/65A., 80A. Alt.	151531R2	②7450
Belt - Fan & Alt.; W/65A., 80A., 105A., 145A. Alt.; W/O P.T.O.		②7630	Belt - Alt. & Air Brake Compr.; W/37A., 61A. Alt.		②7541
Belt - P.S.; W/2WD		7460	Belt - Alt. & Air Brake Compr.; W/65A., 80A. Alt.	358344C91	②7560
Belt - P.S.; W/4WD	285522C2	7435	Belt - P.S.	358335C91	②♠◆9490HD
Belt - Air Brake Compr.	359007C91	7475	International/Navistar V461		
Belt - A.P.; W/Air Brakes; W/Gov.	388139C1	7330	1603; 1703 (School Bus); 1803		
Belt - A.P.; W/Air Brakes; W/O Gov.	256062C2	7340	Belt - Fan	②♠◆9476HD	
Belt - A.P.; W/Hyd. Brakes; W/Gov.	355653C91	7380	Belt - Alt.; W/37A., 61A. Alt.	359006C91	②7417
Belt - A.P.; W/Hyd. Brakes; W/O Gov.	362887C91	7410	Belt - Alt.; W/65A., 80A. Alt.	151531R2	②7450
1803			Belt - Alt. & Air Brake Compr.; W/37A., 61A. Alt.		②7541
Belt - Fan & Alt.; W/37A., 52A., 61A. Alt.; C, G, H Chassis; W/P.T.O.	968815R11	②7650	Belt - Alt. & Air Brake Compr.; W/65A., 80A. Alt.	358344C91	②7560
Belt - Fan & Alt.; W/37A., 52A., 61A. Alt.; C, G, H Chassis; W/O P.T.O.	373457C91	②7612	Belt - P.S.	358335C91	②♠◆9490HD
Belt - Fan & Alt.; W/37A., 52A., 61A. Alt.; FD, SB Chassis	968815R1	②7650	International/Navistar V478		
Belt - Fan & Alt.; W/37A., 61A. Alt.; W/O Air Brakes; W/O P.T.O.; W/O X.C.	373456C1	7612	1603; 1703 (School Bus); 1803		
Belt - Fan & Alt.; W/55A., 62A. Alt.; C, G, H Chassis	369723C91	②7630	Belt - Fan	②♠◆9476HD	
Belt - Fan & Alt.; W/55A., 62A. Alt.; FD, SB Chassis	361975C91	②7673	Belt - Alt.; W/37A., 61A. Alt.	359006C91	②7417
Belt - Fan & Alt.; W/60A. Alt.	359009C91	②7680	Belt - Alt.; W/65A., 80A. Alt.	151531R2	②7450
Belt - Fan & Alt.; W/65A., 80A., 105A., 145A. Alt.; W/P.T.O.	361975C91	②7673	Belt - Alt. & Air Brake Compr.; W/37A., 61A. Alt.		②7541
Belt - Fan & Alt.; W/65A., 80A., 105A., 145A. Alt.; W/O P.T.O.		②7630	Belt - Alt. & Air Brake Compr.; W/65A., 80A. Alt.	358344C91	②7560
Belt - P.S.; W/2WD		7460	Belt - P.S.	358335C91	②♠◆9490HD
Belt - P.S.; W/4WD	285522C2	7435	International/Navistar V549		
Belt - Air Brake Compr.	359007C91	7475	1603; 1703 (School Bus); 1803		
Belt - A.P.; W/Air Brakes; W/Gov.	388139C1	7330	Belt - Fan	②♠◆9476HD	
Belt - A.P.; W/Air Brakes; W/O Gov.	256062C2	7340	Belt - Alt.; W/37A., 61A. Alt.	359006C91	②7417
Belt - A.P.; W/Hyd. Brakes; W/Gov.	355653C91	7380	Belt - Alt.; W/65A., 80A. Alt.	151531R2	②7450
Belt - A.P.; W/Hyd. Brakes; W/O Gov.	362887C91	7410	Belt - Alt. & Air Brake Compr.; W/37A., 61A. Alt.		②7541
Hose - Upper; W/Rad. Shutters; W/Metal Hood	26515		Belt - Alt. & Air Brake Compr.; W/65A., 80A. Alt.	358344C91	②7560
Hose - Upper; W/O Rad. Shutters; W/Metal Hood	20493		Belt - P.S.	358335C91	②♠◆9490HD
Hose - Lower - Eng. To Pipe; W/Auto. Trans.	20532		International/Navistar VS401		
Hose - Lower; W/Man. Trans.	21308		1603; 1703 (School Bus); 1803		
Hose - By Pass	≈<20357		Belt - Fan	②♠◆9476HD	

♠=Cut to Fit.
♠Standard Belt Available.

②Two Required.
◆PowerBand Belt May Work, Use Template to Check.

School Buses

Belts and Coolant Hose for School Buses

School Buses

Application	Mfr. Part No.	Our No.	Application	Mfr. Part No.	Our No.
International/Navistar - Continued			International/Navistar - Continued		
1976 - Continued			1975 - Continued		
International/Navistar VS401 - Continued			International/Navistar FTV549		
1603; 1703 (School Bus); 1803 - Continued			1603; 1703 (School Bus); 1803		
Belt - Alt.; W/37A., 61A. Alt.	359006C91	②7417	Belt - Fan		②♣◆9476HD
Belt - Alt.; W/65A., 80A. Alt.	151531R2	②7450	Belt - Alt.; W/37A., 61A. Alt.	359006C91	②7417
Belt - Alt. & Air Brake Compr.; W/37A., 61A. Alt.		②7541	Belt - Alt.; W/65A., 80A. Alt.	151531R2	②7450
Belt - Alt. & Air Brake Compr.; W/65A., 80A. Alt.	358344C91	②7560	Belt - Alt. & Air Brake Compr.; W/37A., 61A. Alt.		②7541
Belt - P.S.	358335C91	②♣◆9490HD	Belt - Alt. & Air Brake Compr.; W/65A., 80A. Alt.	358344C91	②7560
			Belt - P.S.	358335C91	②♣◆9490HD
International/Navistar VS478			International/Navistar FTVS549		
1603; 1703 (School Bus); 1803			1603; 1703 (School Bus); 1803		
Belt - Fan		②♣◆9476HD	Belt - Fan		②♣◆9476HD
Belt - Alt.; W/37A., 61A. Alt.	359006C91	②7417	Belt - Alt.; W/37A., 61A. Alt.	359006C91	②7417
Belt - Alt.; W/65A., 80A. Alt.	151531R2	②7450	Belt - Alt.; W/65A., 80A. Alt.	151531R2	②7450
Belt - Alt. & Air Brake Compr.; W/37A., 61A. Alt.		②7541	Belt - Alt. & Air Brake Compr.; W/37A., 61A. Alt.		②7541
Belt - Alt. & Air Brake Compr.; W/65A., 80A. Alt.	358344C91	②7560	Belt - Alt. & Air Brake Compr.; W/65A., 80A. Alt.	358344C91	②7560
Belt - P.S.	358335C91	②♣◆9490HD	Belt - P.S.	358335C91	②♣◆9490HD
International/Navistar VS549			International/Navistar MV404		
1603; 1703 (School Bus); 1803			1723; 1823		
Belt - Fan		②♣◆9476HD	Hose - Upper - To Center of Rad.		21132
Belt - Alt.; W/37A., 61A. Alt.	359006C91	②7417	or		26528
Belt - Alt.; W/65A., 80A. Alt.	151531R2	②7450	Hose - Upper - To Right Hand Side of Rad.		21133
Belt - Alt. & Air Brake Compr.; W/37A., 61A. Alt.		②7541	or		26528
Belt - Alt. & Air Brake Compr.; W/65A., 80A. Alt.	358344C91	②7560	Hose - Lower; W/Auto. Trans.		26532
Belt - P.S.	358335C91	②♣◆9490HD	Hose - Lower; W/Man. Trans.		21129
1975			International/Navistar MV446		
Caterpillar 1145 Diesel			1723; 1823		
1853			Hose - Upper - To Center of Rad.		
Belt - Fan	426222C91	②♣◆9530HD	or		26528
Belt - Alt.; W/37A., 61A. Alt.	398601C91	②♣9440HD	Hose - Upper - To Right Hand Side of Rad.		21133
Belt - Alt.; W/65A., 80A. Alt.	354029C91	②♣◆9476HD	or		26528
Belt - Alt. & Air Brake Compr.; W/37A., 61A. Alt.		②♣9465HD	Hose - Lower; W/Auto. Trans.		26532
Belt - Alt. & Air Brake Compr.; W/65A., 80A. Alt.	427205C91	②♣◆9500HD	Hose - Lower; W/Man. Trans.		21129
Belt - P.S.		♣9465HD	International/Navistar RD372		
Hose - Upper		26532	1823		
Caterpillar 1150 Diesel			Belt - Fan & Alt.		
1853			Belt - W.P. & Alt.; W/37A. Alt.; Chassis No.		
Belt - Fan	426222C91	②♣◆9530HD	FD61626 & Before		
Belt - Alt.; W/37A., 61A. Alt.	398601C91	②♣9440HD	193826R11		
Belt - Alt.; W/65A., 80A. Alt.	354029C91	②♣◆9476HD	②TR22508		
Belt - Alt. & Air Brake Compr.; W/37A., 61A. Alt.		②♣9465HD	Belt - W.P. & Alt.; W/37A. Alt.; Chassis No.		
Belt - Alt. & Air Brake Compr.; W/65A., 80A. Alt.	427205C91	②♣◆9500HD	FD61626 & Up & G Chassis No.		
Belt - P.S.		♣9465HD	223794R11		
Hose - Upper		26532	②TR22514		
Caterpillar 1160 Diesel			Belt - W.P. & Alt.; W/60A. Alt.		
1853			240354R2		
Belt - Fan	426222C91	②♣◆9530HD	TR22336		
Belt - Alt.; W/37A., 61A. Alt.	398601C91	②♣9440HD	TR32491		
Belt - Alt.; W/65A., 80A. Alt.	354029C91	②♣◆9476HD	Belt - Air Brake Compr.; W/Wagner Compr.		
Belt - Alt. & Air Brake Compr.; W/37A., 61A. Alt.		②♣9465HD	92836HA		
Belt - Alt. & Air Brake Compr.; W/65A., 80A. Alt.	427205C91	②♣◆9500HD	TR34467		
Belt - P.S.		♣9465HD	Hose - Upper		
Hose - Upper		26532	26515		
International/Navistar DT466 Diesel			Hose - Lower		
1853FC			24232		
Hose - Lower		≈<21291	International/Navistar RD406		
			1823		
			Belt - Fan & Alt.		
			359014C91		
			②TR22514		
			Belt - W.P. & Alt.; W/37A. Alt.; Chassis No.		
			FD61626 & Before		
			193826R11		
			②TR22508		
			Belt - W.P. & Alt.; W/37A. Alt.; Chassis No.		
			FD61626 & Up & G Chassis No.		
			223794R11		
			②TR22514		
			Belt - W.P. & Alt.; W/60A. Alt.		
			243604R11		
			②TR22517		
			Belt - P.S.		
			240354R2		
			TR22336		
			Belt - Air Brake Compr.; W/Wagner Compr.		
			92836HA		
			TR32491		
			Belt - Air Brake Compr.; W/Westinghouse		
			Compr.		
			83816HA		
			TR34467		
			Hose - Upper		
			26515		
			Hose - Lower		
			24232		

②Two Required.
◆PowerBand Belt May Work, Use Template to Check.

♣Standard Belt Available.
≈<Cut to Fit.

Belts and Coolant Hose for School Buses

Application	Mfr. Part No.	Our No.	Application	Mfr. Part No.	Our No.
International/Navistar - Continued			International/Navistar - Continued		
1975 - Continued			1975 - Continued		
International/Navistar RD450			International/Navistar V345		
1823			1603; 1703 (School Bus)		
Belt - Fan & Alt.	359014C91	②TR22514	Belt - Fan & Alt.; W/37A., 52A., 61A. Alt.; C, G, H Chassis; W/P.T.O.	968815R11	②7650
Belt - W.P. & Alt.; W/37A. Alt.; Chassis No. FD61626 & Before	193826R11	②TR22508	Belt - Fan & Alt.; W/37A., 52A., 61A. Alt.; C, G, H Chassis; W/O P.T.O.	373457C91	②7612
Belt - W.P. & Alt.; W/37A. Alt.; Chassis No. FD61626 & Up & G Chassis No.	223794R11	②TR22514	Belt - Fan & Alt.; W/37A., 52A., 61A. Alt.; FD, SB Chassis	968815R1	②7650
Belt - W.P. & Alt.; W/60A. Alt.	243604R11	②TR22517	Belt - Fan & Alt.; W/37A., 61A. Alt.; W/O Air Brakes; W/O P.T.O.; W/O X.C.	373456C1	7612
Belt - P.S.	240354R2	TR22336	Belt - Fan & Alt.; W/55A., 62A. Alt.; C, G, H Chassis	369723C91	②7630
Belt - Air Brake Compr.; W/Wagner Compr.	92836HA	TR32491	Belt - Fan & Alt.; W/55A., 62A. Alt.; FD, SB Chassis	361975C91	②7673
Belt - Air Brake Compr.; W/Westinghouse Compr.	83816HA	TR34467	Belt - Fan & Alt.; W/60A. Alt.	359009C91	②7680
Hose - Upper		26515	Belt - Fan & Alt.; W/65A., 80A., 105A., 145A. Alt.; W/P.T.O.	361975C91	②7673
Hose - Lower		24232	Belt - Fan & Alt.; W/65A., 80A., 105A., 145A. Alt.; W/O P.T.O.		②7630
International/Navistar RD501			Belt - P.S.; W/2WD		7460
1823			Belt - P.S.; W/4WD	285522C2	7435
Belt - Fan & Alt.	359014C91	②TR22514	Belt - Air Brake Compr.	359007C91	7475
Belt - W.P. & Alt.; W/37A. Alt.; Chassis No. FD61626 & Before	193826R11	②TR22508	Belt - A.P.; W/Air Brakes; W/Gov.	388139C1	7330
Belt - W.P. & Alt.; W/37A. Alt.; Chassis No. FD61626 & Up & G Chassis No.	223794R11	②TR22514	Belt - A.P.; W/Air Brakes; W/O Gov.	256062C2	7340
Belt - W.P. & Alt.; W/60A. Alt.	243604R11	②TR22517	Belt - A.P.; W/Hyd. Brakes; W/Gov.	355653C91	7380
Belt - P.S.	240354R2	TR22336	Belt - A.P.; W/Hyd. Brakes; W/O Gov.	362887C91	7410
Belt - Air Brake Compr.; W/Wagner Compr.	92836HA	TR32491	Hose - Upper; W/Rad. Shutters; W/Metal Hood		26515
Belt - Air Brake Compr.; W/Westinghouse Compr.	83816HA	TR34467	Hose - Upper; W/O Rad. Shutters; W/Metal Hood		20493
Hose - Upper		26515	Hose - Lower - Eng. To Pipe; W/Auto. Trans.		20532
Hose - Lower		24232	Hose - Lower; W/Man. Trans.		21308
International/Navistar V266			Hose - By Pass		≧20357
1603; 1703 (School Bus); 1803			1723		
Belt - Fan & Alt.; W/37A., 52A., 61A. Alt.; C, G, H Chassis		②7603	Belt - Fan & Alt.; W/37A., 52A., 61A. Alt.; C, G, H Chassis; W/P.T.O.	968815R11	②7650
Belt - Fan & Alt.; W/37A., 52A., 61A. Alt.; FD, SB Chassis	255266C3	②7640	Belt - Fan & Alt.; W/37A., 52A., 61A. Alt.; C, G, H Chassis; W/O P.T.O.	373457C91	②7612
Belt - Fan & Alt.; W/55A., 62A. Alt.; C, G, H Chassis	369725C91	②7619	Belt - Fan & Alt.; W/37A., 52A., 61A. Alt.; FD, SB Chassis	968815R1	②7650
Belt - Fan & Alt.; W/55A., 62A. Alt.; FD, SB Chassis	358998C91	②7650	Belt - Fan & Alt.; W/37A., 61A. Alt.; W/O Air Brakes; W/O P.T.O.; W/O X.C.	373456C1	7612
Belt - P.S.; W/2WD	151529R2	7440	Belt - Fan & Alt.; W/55A., 62A. Alt.; C, G, H Chassis	369723C91	②7630
Belt - P.S.; W/4WD	151531R2	7450	Belt - Fan & Alt.; W/55A., 62A. Alt.; FD, SB Chassis	361975C91	②7673
Belt - Air Brake Compr.	236572R2	7460	Belt - Fan & Alt.; W/60A. Alt.	359009C91	②7680
Hose - Upper; W/Rad. Shutters; W/Metal Hood		26515	Belt - Fan & Alt.; W/65A., 80A., 105A., 145A. Alt.; W/P.T.O.	361975C91	②7673
Hose - Upper; W/O Rad. Shutters; W/Metal Hood		20493	Belt - Fan & Alt.; W/65A., 80A., 105A., 145A. Alt.; W/O P.T.O.		②7630
Hose - Lower - Eng. To Pipe; W/Auto. Trans.		20532	Belt - P.S.; W/2WD		7460
Hose - Lower; W/Man. Trans.		21308	Belt - P.S.; W/4WD	285522C2	7435
Hose - By Pass		≧20357	Belt - Air Brake Compr.	359007C91	7475
International/Navistar V304			Belt - A.P.; W/Air Brakes; W/Gov.	388139C1	7330
1603; 1703 (School Bus); 1803			Belt - A.P.; W/Air Brakes; W/O Gov.	256062C2	7340
Belt - Fan & Alt.; W/37A., 52A., 61A. Alt.; C, G, H Chassis		②7603	Belt - A.P.; W/Hyd. Brakes; W/Gov.	355653C91	7380
Belt - Fan & Alt.; W/37A., 52A., 61A. Alt.; FD, SB Chassis	255266C3	②7640	Belt - A.P.; W/Hyd. Brakes; W/O Gov.	362887C91	7410
Belt - Fan & Alt.; W/55A., 62A. Alt.; C, G, H Chassis	369725C91	②7619	1803		
Belt - Fan & Alt.; W/55A., 62A. Alt.; FD, SB Chassis	358998C91	②7650	Belt - Fan & Alt.; W/37A., 52A., 61A. Alt.; C, G, H Chassis; W/P.T.O.	968815R11	②7650
Belt - P.S.; W/2WD	151529R2	7440	Belt - Fan & Alt.; W/37A., 52A., 61A. Alt.; C, G, H Chassis; W/O P.T.O.	373457C91	②7612
Belt - P.S.; W/4WD	151531R2	7450	Belt - Fan & Alt.; W/37A., 52A., 61A. Alt.; FD, SB Chassis	968815R1	②7650
Belt - Air Brake Compr.	236572R2	7460	Belt - Fan & Alt.; W/37A., 61A. Alt.; W/O Air Brakes; W/O P.T.O.; W/O X.C.	373456C1	7612
Hose - Upper; W/Rad. Shutters; W/Metal Hood		26515	Belt - Fan & Alt.; W/55A., 62A. Alt.; C, G, H Chassis	369723C91	②7630
Hose - Upper; W/O Rad. Shutters; W/Metal Hood		20493	Belt - Fan & Alt.; W/55A., 62A. Alt.; FD, SB Chassis	361975C91	②7673
Hose - Lower - Eng. To Pipe; W/Auto. Trans.		20532	Belt - Fan & Alt.; W/60A. Alt.	359009C91	②7680
Hose - Lower; W/Man. Trans.		21308	1803		
Hose - By Pass		≧20357	Belt - Fan & Alt.; W/37A., 52A., 61A. Alt.; C, G, H Chassis; W/P.T.O.	968815R11	②7650

②Two Required.

≧Cut to Fit.

School Buses

Belts and Coolant Hose for School Buses

School Buses

Application	Mfr. Part No.	Our No.	Application	Mfr. Part No.	Our No.
International/Navistar - Continued			International/Navistar - Continued		
1975 - Continued			1975 - Continued		
International/Navistar V345 - Continued			International/Navistar V392 - Continued		
1803 - Continued			1603; 1703 (School Bus) - Continued		
Belt - Fan & Alt.; W/65A., 80A., 105A., 145A. Alt.; W/P.T.O.	361975C91	@7673	Hose - Upper; W/Rad. Shutters; W/Metal Hood		26515
Belt - Fan & Alt.; W/65A., 80A., 105A., 145A. Alt.; W/O P.T.O.		@7630	Hose - Upper; W/O Rad. Shutters; W/Metal Hood		20493
Belt - P.S.; W/2WD		7460	Hose - Lower - Eng. To Pipe; W/Auto. Trans.		20532
Belt - P.S.; W/4WD	285522C2	7435	Hose - Lower; W/Man. Trans.		21308
Belt - Air Brake Compr.	359007C91	7475	Hose - By Pass	≈	20357
Belt - A.P.; W/Air Brakes; W/Gov.	388139C1	7330	1723		
Belt - A.P.; W/Air Brakes; W/O Gov.	256062C2	7340	Belt - Fan & Alt.; W/37A., 52A., 61A. Alt.; C, G, H Chassis; W/P.T.O.	968815R11	@7650
Belt - A.P.; W/Hyd. Brakes; W/Gov.	355653C91	7380	Belt - Fan & Alt.; W/37A., 52A., 61A. Alt.; C, G, H Chassis; W/O P.T.O.	373457C91	@7612
Belt - A.P.; W/Hyd. Brakes; W/O Gov.	362887C91	7410	Belt - Fan & Alt.; W/37A., 52A., 61A. Alt.; FD, SB Chassis	968815R1	@7650
Hose - Upper; W/Rad. Shutters; W/Metal Hood		26515	Belt - Fan & Alt.; W/37A., 61A. Alt.; W/O Air Brakes; W/O P.T.O.; W/O X.C.	373456C1	7612
Hose - Upper; W/O Rad. Shutters; W/Metal Hood		20493	Belt - Fan & Alt.; W/55A., 62A. Alt.; C, G, H Chassis	369723C91	@7630
Hose - Lower - Eng. To Pipe; W/Auto. Trans.		20532	Belt - Fan & Alt.; W/55A., 62A. Alt.; FD, SB Chassis	361975C91	@7673
Hose - Lower; W/Man. Trans.		21308	Belt - Fan & Alt.; W/60A. Alt.	359009C91	@7680
Hose - By Pass	≈	20357	Belt - Fan & Alt.; W/65A., 80A., 105A., 145A. Alt.; W/P.T.O.	361975C91	@7673
1823			Belt - Fan & Alt.; W/65A., 80A., 105A., 145A. Alt.; W/O P.T.O.		@7630
Belt - Fan & Alt.; W/37A., 52A., 61A. Alt.; C, G, H Chassis; W/P.T.O.	968815R11	@7650	Belt - P.S.; W/2WD		7460
Belt - Fan & Alt.; W/37A., 52A., 61A. Alt.; C, G, H Chassis; W/O P.T.O.	373457C91	@7612	Belt - P.S.; W/4WD	285522C2	7435
Belt - Fan & Alt.; W/37A., 52A., 61A. Alt.; FD, SB Chassis	968815R1	@7650	Belt - Air Brake Compr.	359007C91	7475
Belt - Fan & Alt.; W/37A., 61A. Alt.; W/O Air Brakes; W/O P.T.O.; W/O X.C.	373456C1	7612	Belt - A.P.; W/Air Brakes; W/Gov.	388139C1	7330
Belt - Fan & Alt.; W/55A., 62A. Alt.; C, G, H Chassis	369723C91	@7630	Belt - A.P.; W/Air Brakes; W/O Gov.	256062C2	7340
Belt - Fan & Alt.; W/55A., 62A. Alt.; FD, SB Chassis	361975C91	@7673	Belt - A.P.; W/Hyd. Brakes; W/Gov.	355653C91	7380
Belt - Fan & Alt.; W/60A. Alt.	359009C91	@7680	Belt - A.P.; W/Hyd. Brakes; W/O Gov.	362887C91	7410
Belt - Fan & Alt.; W/65A., 80A., 105A., 145A. Alt.; W/P.T.O.	361975C91	@7673	1803		
Belt - Fan & Alt.; W/65A., 80A., 105A., 145A. Alt.; W/O P.T.O.		@7630	Belt - Fan & Alt.; W/37A., 52A., 61A. Alt.; C, G, H Chassis; W/P.T.O.	968815R11	@7650
Belt - P.S.; W/2WD		7460	Belt - Fan & Alt.; W/37A., 52A., 61A. Alt.; C, G, H Chassis; W/O P.T.O.	373457C91	@7612
Belt - P.S.; W/4WD	285522C2	7435	Belt - Fan & Alt.; W/37A., 52A., 61A. Alt.; FD, SB Chassis	968815R1	@7650
Belt - Air Brake Compr.	359007C91	7475	Belt - Fan & Alt.; W/37A., 61A. Alt.; W/O Air Brakes; W/O P.T.O.; W/O X.C.	373456C1	7612
Belt - A.P.; W/Air Brakes; W/Gov.	388139C1	7330	Belt - Fan & Alt.; W/55A., 62A. Alt.; C, G, H Chassis	369723C91	@7630
Belt - A.P.; W/Air Brakes; W/O Gov.	256062C2	7340	Belt - Fan & Alt.; W/55A., 62A. Alt.; FD, SB Chassis	361975C91	@7673
Belt - A.P.; W/Hyd. Brakes; W/Gov.	355653C91	7380	Belt - Fan & Alt.; W/60A. Alt.	359009C91	@7680
Belt - A.P.; W/Hyd. Brakes; W/O Gov.	362887C91	7410	Belt - Fan & Alt.; W/65A., 80A., 105A., 145A. Alt.; W/P.T.O.	361975C91	@7673
International/Navistar V392			Belt - Fan & Alt.; W/65A., 80A., 105A., 145A. Alt.; W/O P.T.O.		@7630
1603; 1703 (School Bus)			Belt - P.S.; W/2WD		7460
Belt - Fan & Alt.; W/37A., 52A., 61A. Alt.; C, G, H Chassis; W/P.T.O.	968815R11	@7650	Belt - P.S.; W/4WD	285522C2	7435
Belt - Fan & Alt.; W/37A., 52A., 61A. Alt.; C, G, H Chassis; W/O P.T.O.	373457C91	@7612	Belt - Air Brake Compr.	359007C91	7475
Belt - Fan & Alt.; W/37A., 52A., 61A. Alt.; FD, SB Chassis	968815R1	@7650	Belt - A.P.; W/Air Brakes; W/Gov.	388139C1	7330
Belt - Fan & Alt.; W/37A., 61A. Alt.; W/O Air Brakes; W/O P.T.O.; W/O X.C.	373456C1	7612	Belt - A.P.; W/Air Brakes; W/O Gov.	256062C2	7340
Belt - Fan & Alt.; W/55A., 62A. Alt.; C, G, H Chassis	369723C91	@7630	Belt - A.P.; W/Hyd. Brakes; W/Gov.	355653C91	7380
Belt - Fan & Alt.; W/55A., 62A. Alt.; FD, SB Chassis	361975C91	@7673	Belt - A.P.; W/Hyd. Brakes; W/O Gov.	362887C91	7410
Belt - Fan & Alt.; W/60A. Alt.	359009C91	@7680	Hose - Upper; W/Rad. Shutters; W/Metal Hood		26515
Belt - Fan & Alt.; W/65A., 80A., 105A., 145A. Alt.; W/P.T.O.	361975C91	@7673	Hose - Upper; W/O Rad. Shutters; W/Metal Hood		20493
Belt - Fan & Alt.; W/65A., 80A., 105A., 145A. Alt.; W/O P.T.O.		@7630	Hose - Lower - Eng. To Pipe; W/Auto. Trans.		20532
Belt - P.S.; W/2WD		7460	Hose - Lower; W/Man. Trans.		21308
Belt - P.S.; W/4WD	285522C2	7435	Hose - By Pass	≈	20357
Belt - Air Brake Compr.	359007C91	7475	1823		
Belt - A.P.; W/Air Brakes; W/Gov.	388139C1	7330	Belt - Fan & Alt.; W/37A., 52A., 61A. Alt.; C, G, H Chassis; W/P.T.O.	968815R11	@7650
Belt - A.P.; W/Air Brakes; W/O Gov.	256062C2	7340	Belt - Fan & Alt.; W/37A., 52A., 61A. Alt.; C, G, H Chassis; W/O P.T.O.	373457C91	@7612
Belt - A.P.; W/Hyd. Brakes; W/Gov.	355653C91	7380	Belt - Fan & Alt.; W/37A., 52A., 61A. Alt.; FD, SB Chassis	968815R1	@7650
Belt - A.P.; W/Hyd. Brakes; W/O Gov.	362887C91	7410			

@Two Required.

≈Cut to Fit.

Belts and Coolant Hose for School Buses

Application	Mfr. Part No.	Our No.	Application	Mfr. Part No.	Our No.
International/Navistar - Continued			International/Navistar - Continued		
1975 - Continued			1975 - Continued		
International/Navistar V392 - Continued			International/Navistar VS478		
1823 - Continued			1603; 1703 (School Bus); 1803		
Belt - Fan & Alt.; W/37A., 61A. Alt.; W/O Air Brakes; W/O P.T.O.; W/O X.C.	373456C1	7612	Belt - Fan	359006C91	②◆◆9476HD
Belt - Fan & Alt.; W/55A., 62A. Alt.; C, G, H Chassis	369723C91	②7630	Belt - Alt.; W/37A., 61A. Alt.	151531R2	②7417
Belt - Fan & Alt.; W/55A., 62A. Alt.; FD, SB Chassis	361975C91	②7673	Belt - Alt.; W/65A., 80A. Alt.	358344C91	②7450
Belt - Fan & Alt.; W/60A. Alt.	359009C91	②7680	Belt - Alt. & Air Brake Compr.; W/37A., 61A. Alt.	358335C91	②7541
Belt - Fan & Alt.; W/65A., 80A., 105A., 145A. Alt.; W/P.T.O.	361975C91	②7673	Belt - Alt. & Air Brake Compr.; W/65A., 80A. Alt.	358344C91	②7560
Belt - Fan & Alt.; W/65A., 80A., 105A., 145A. Alt.; W/O P.T.O.		②7630	Belt - P.S.	358335C91	②◆◆9490HD
Belt - P.S.; W/2WD		7460	International/Navistar VS549		
Belt - P.S.; W/4WD	285522C2	7435	1603; 1703 (School Bus); 1803		
Belt - Air Brake Compr.	359007C91	7475	Belt - Fan	359006C91	②◆◆9476HD
Belt - A.P.; W/Air Brakes; W/Gov.	388139C1	7330	Belt - Alt.; W/37A., 61A. Alt.	151531R2	②7417
Belt - A.P.; W/Air Brakes; W/O Gov.	256062C2	7340	Belt - Alt.; W/65A., 80A. Alt.	358344C91	②7450
Belt - A.P.; W/Hyd. Brakes; W/Gov.	355653C91	7380	Belt - Alt. & Air Brake Compr.; W/37A., 61A. Alt.	358335C91	②7541
Belt - A.P.; W/Hyd. Brakes; W/O Gov.	362887C91	7410	Belt - Alt. & Air Brake Compr.; W/65A., 80A. Alt.	358344C91	②7560
International/Navistar V401			1974		
1603; 1703 (School Bus); 1803			Caterpillar 1145 Diesel		
Belt - Fan		②◆◆9476HD	1853		
Belt - Alt.; W/37A., 61A. Alt.	359006C91	②7417	Belt - Fan	426222C91	②◆◆9530HD
Belt - Alt.; W/65A., 80A. Alt.	151531R2	②7450	Belt - Alt.; W/37A., 61A. Alt.	398601C91	②◆9440HD
Belt - Alt. & Air Brake Compr.; W/37A., 61A. Alt.		②7541	Belt - Alt.; W/65A., 80A. Alt.	354029C91	②◆◆9476HD
Belt - Alt. & Air Brake Compr.; W/65A., 80A. Alt.	358344C91	②7560	Belt - Alt. & Air Brake Compr.; W/37A., 61A. Alt.	427205C91	②◆9465HD
Belt - P.S.	358335C91	②◆◆9490HD	Belt - Alt. & Air Brake Compr.; W/65A., 80A. Alt.	427205C91	②◆◆9500HD
International/Navistar V461			Belt - P.S.		
1603; 1703 (School Bus); 1803			Hose - Upper		
Belt - Fan		②◆◆9476HD	26532		
Belt - Alt.; W/37A., 61A. Alt.	359006C91	②7417	Caterpillar 1150 Diesel		
Belt - Alt.; W/65A., 80A. Alt.	151531R2	②7450	1853		
Belt - Alt. & Air Brake Compr.; W/37A., 61A. Alt.		②7541	Belt - Fan	426222C91	②◆◆9530HD
Belt - Alt. & Air Brake Compr.; W/65A., 80A. Alt.	358344C91	②7560	Belt - Alt.; W/37A., 61A. Alt.	398601C91	②◆9440HD
Belt - P.S.	358335C91	②◆◆9490HD	Belt - Alt.; W/65A., 80A. Alt.	354029C91	②◆◆9476HD
International/Navistar V478			Belt - Alt. & Air Brake Compr.; W/37A., 61A. Alt.		
1603; 1703 (School Bus); 1803			Belt - Alt. & Air Brake Compr.; W/65A., 80A. Alt.		
Belt - Fan		②◆◆9476HD	427205C91		
Belt - Alt.; W/37A., 61A. Alt.	359006C91	②7417	②◆◆9500HD		
Belt - Alt.; W/65A., 80A. Alt.	151531R2	②7450	◆9465HD		
Belt - Alt. & Air Brake Compr.; W/37A., 61A. Alt.		②7541	26532		
Belt - Alt. & Air Brake Compr.; W/65A., 80A. Alt.	358344C91	②7560	Caterpillar 1160 Diesel		
Belt - P.S.	358335C91	②◆◆9490HD	1853		
International/Navistar V549			Belt - Fan		
1603; 1703 (School Bus); 1803			426222C91		
Belt - Fan		②◆◆9476HD	②◆◆9530HD		
Belt - Alt.; W/37A., 61A. Alt.	359006C91	②7417	②◆9440HD		
Belt - Alt.; W/65A., 80A. Alt.	151531R2	②7450	②◆◆9476HD		
Belt - Alt. & Air Brake Compr.; W/37A., 61A. Alt.		②7541	②◆9465HD		
Belt - Alt. & Air Brake Compr.; W/65A., 80A. Alt.	358344C91	②7560	②◆◆9500HD		
Belt - P.S.	358335C91	②◆◆9490HD	◆9465HD		
International/Navistar VS401			26532		
1603; 1703 (School Bus); 1803			International/Navistar FTV549		
Belt - Fan		②◆◆9476HD	1603; 1703 (School Bus); 1803		
Belt - Alt.; W/37A., 61A. Alt.	359006C91	②7417	Belt - Fan		
Belt - Alt.; W/65A., 80A. Alt.	151531R2	②7450	②◆◆9476HD		
Belt - Alt. & Air Brake Compr.; W/37A., 61A. Alt.		②7541	②7417		
Belt - Alt. & Air Brake Compr.; W/65A., 80A. Alt.	358344C91	②7560	②7450		
Belt - P.S.	358335C91	②◆◆9490HD	②7541		
International/Navistar VS478			Belt - Alt. & Air Brake Compr.; W/37A., 61A. Alt.		
1603; 1703 (School Bus); 1803			Belt - Alt. & Air Brake Compr.; W/65A., 80A. Alt.		
Belt - Fan		②◆◆9476HD	358344C91		
Belt - Alt.; W/37A., 61A. Alt.	359006C91	②7417	②7560		
Belt - Alt.; W/65A., 80A. Alt.	151531R2	②7450	②◆◆9490HD		
Belt - Alt. & Air Brake Compr.; W/37A., 61A. Alt.		②7541	Hose - Upper		
Belt - Alt. & Air Brake Compr.; W/65A., 80A. Alt.	358344C91	②7560	26531		
Belt - P.S.	358335C91	②◆◆9490HD	Hose - Lower		

School Buses

②Two Required.
◆PowerBand Belt May Work, Use Template to Check.

◆Standard Belt Available.
≅Cut to Fit.

Belts and Coolant Hose for School Buses

School Buses

Application	Mfr. Part No.	Our No.	Application	Mfr. Part No.	Our No.
International/Navistar - Continued			International/Navistar - Continued		
1974 - Continued			1974 - Continued		
International/Navistar FTVS549 - Continued			International/Navistar V266		
1603; 1703 (School Bus); 1803 - Continued			1603; 1703 (School Bus); 1803		
Belt - Alt.; W/37A., 61A. Alt.	359006C91	②7417	Belt - Fan & Alt.; W/37A., 52A., 61A. Alt.; C, G, H Chassis		②7603
Belt - Alt.; W/65A., 80A. Alt.	151531R2	②7450	Belt - Fan & Alt.; W/37A., 52A., 61A. Alt.; FD, SB Chassis	255266C3	②7640
Belt - Alt. & Air Brake Compr.; W/37A., 61A. Alt.		②7541	Belt - Fan & Alt.; W/55A., 62A. Alt.; C, G, H Chassis	369725C91	②7619
Belt - Alt. & Air Brake Compr.; W/65A., 80A. Alt.	358344C91	②7560	Belt - Fan & Alt.; W/55A., 62A. Alt.; FD, SB Chassis	358998C91	②7650
Belt - P.S.	358335C91	②◆◆9490HD	Belt - P.S.; W/2WD	151529R2	7440
Hose - Upper		26531	Belt - P.S.; W/4WD	151531R2	7450
Hose - Lower		≈<20530	Belt - Air Brake Compr.	236572R2	7460
International/Navistar RD372			Hose - Upper; W/Rad. Shutters; W/Metal Hood		
1823			Hose - Upper; W/O Rad. Shutters; W/Metal Hood		
Belt - Fan & Alt.	359014C91	②TR22514	Hose - Lower - Eng. To Pipe; W/Auto. Trans.		
Belt - W.P. & Alt.; W/37A. Alt.; Chassis No. FD61626 & Before	193826R11	②TR22508	Hose - Lower; W/Man. Trans.		
Belt - W.P. & Alt.; W/37A. Alt.; Chassis No. FD61626 & Up & G Chassis No.	223794R11	②TR22514	Hose - By Pass		
Belt - W.P. & Alt.; W/60A. Alt.	243604R11	②TR22517	International/Navistar V304		
Belt - P.S.	240354R2	TR22336	1603; 1703 (School Bus); 1803		
Belt - Air Brake Compr.; W/Wagner Compr.	92836HA	TR32491	Belt - Fan & Alt.; W/37A., 52A., 61A. Alt.; C, G, H Chassis		
Belt - Air Brake Compr.; W/Westinghouse Compr.	83816HA	TR34467	Belt - Fan & Alt.; W/37A., 52A., 61A. Alt.; FD, SB Chassis		
Hose - Upper		26515	Belt - Fan & Alt.; W/55A., 62A. Alt.; C, G, H Chassis		
Hose - Lower		24232	Belt - Fan & Alt.; W/55A., 62A. Alt.; FD, SB Chassis		
International/Navistar RD406			Belt - P.S.; W/2WD		
1823			Belt - P.S.; W/4WD		
Belt - Fan & Alt.	359014C91	②TR22514	Belt - Air Brake Compr.		
Belt - W.P. & Alt.; W/37A. Alt.; Chassis No. FD61626 & Before	193826R11	②TR22508	Hose - Upper; W/Rad. Shutters; W/Metal Hood		
Belt - W.P. & Alt.; W/37A. Alt.; Chassis No. FD61626 & Up & G Chassis No.	223794R11	②TR22514	Hose - Upper; W/O Rad. Shutters; W/Metal Hood		
Belt - W.P. & Alt.; W/60A. Alt.	243604R11	②TR22517	Hose - Lower - Eng. To Pipe; W/Auto. Trans.		
Belt - P.S.	240354R2	TR22336	Hose - Lower; W/Man. Trans.		
Belt - Air Brake Compr.; W/Wagner Compr.	92836HA	TR32491	Hose - By Pass		
Belt - Air Brake Compr.; W/Westinghouse Compr.	83816HA	TR34467	International/Navistar V345		
Hose - Upper		26515	1603; 1703 (School Bus)		
Hose - Lower		24232	Belt - Fan & Alt.; W/37A., 52A., 61A. Alt.; C, G, H Chassis; W/P.T.O.		
International/Navistar RD450			Belt - Fan & Alt.; W/37A., 52A., 61A. Alt.; C, G, H Chassis; W/O P.T.O.		
1823			Belt - Fan & Alt.; W/37A., 52A., 61A. Alt.; FD, SB Chassis		
Belt - Fan & Alt.	359014C91	②TR22514	Belt - Fan & Alt.; W/37A., 61A. Alt.; W/O Air Brakes; W/O P.T.O.; W/O X.C.		
Belt - W.P. & Alt.; W/37A. Alt.; Chassis No. FD61626 & Before	193826R11	②TR22508	Belt - Fan & Alt.; W/55A., 62A. Alt.; C, G, H Chassis		
Belt - W.P. & Alt.; W/37A. Alt.; Chassis No. FD61626 & Up & G Chassis No.	223794R11	②TR22514	Belt - Fan & Alt.; W/55A., 62A. Alt.; FD, SB Chassis		
Belt - W.P. & Alt.; W/60A. Alt.	243604R11	②TR22517	Belt - Fan & Alt.; W/60A. Alt.		
Belt - P.S.	240354R2	TR22336	Belt - Fan & Alt.; W/65A., 80A., 105A., 145A. Alt.; W/P.T.O.		
Belt - Air Brake Compr.; W/Wagner Compr.	92836HA	TR32491	Belt - Fan & Alt.; W/65A., 80A., 105A., 145A. Alt.; W/O P.T.O.		
Belt - Air Brake Compr.; W/Westinghouse Compr.	83816HA	TR34467	Belt - P.S.; W/2WD		
Hose - Upper		26515	Belt - P.S.; W/4WD		
Hose - Lower		24232	Belt - Air Brake Compr.		
International/Navistar RD501			Belt - A.P.; W/Air Brakes; W/Gov.		
1823			Belt - A.P.; W/Air Brakes; W/O Gov.		
Belt - Fan & Alt.	359014C91	②TR22514	Belt - A.P.; W/Hyd. Brakes; W/Gov.		
Belt - W.P. & Alt.; W/37A. Alt.; Chassis No. FD61626 & Before	193826R11	②TR22508	Belt - A.P.; W/Hyd. Brakes; W/O Gov.		
Belt - W.P. & Alt.; W/37A. Alt.; Chassis No. FD61626 & Up & G Chassis No.	223794R11	②TR22514	Hose - Upper; W/Rad. Shutters; W/Metal Hood		
Belt - W.P. & Alt.; W/60A. Alt.	243604R11	②TR22517	Hose - Upper; W/O Rad. Shutters; W/Metal Hood		
Belt - P.S.	240354R2	TR22336	Hose - Lower - Eng. To Pipe; W/Auto. Trans.		
Belt - Air Brake Compr.; W/Wagner Compr.	92836HA	TR32491	Hose - Lower; W/Man. Trans.		
Belt - Air Brake Compr.; W/Westinghouse Compr.	83816HA	TR34467	Hose - By Pass		
Hose - Upper		26515			
Hose - Lower		24232			

②Two Required.

◆PowerBand Belt May Work, Use Template to Check.

◆Standard Belt Available.

≈<Cut to Fit.

Belts and Coolant Hose for School Buses

Application	Mfr. Part No.	Our No.	Application	Mfr. Part No.	Our No.
International/Navistar - Continued			International/Navistar - Continued		
1974 - Continued			1974 - Continued		
International/Navistar V345 - Continued			International/Navistar V345 - Continued		
1723			1823 - Continued		
Belt - Fan & Alt.; W/37A., 52A., 61A. Alt.; C, G, H Chassis; W/P.T.O.	968815R11	②7650	Belt - Fan & Alt.; W/65A., 80A., 105A., 145A. Alt.; W/P.T.O.	361975C91	②7673
Belt - Fan & Alt.; W/37A., 52A., 61A. Alt.; C, G, H Chassis; W/O P.T.O.	373457C91	②7612	Belt - Fan & Alt.; W/65A., 80A., 105A., 145A. Alt.; W/O P.T.O.		②7630
Belt - Fan & Alt.; W/37A., 52A., 61A. Alt.; FD, SB Chassis	968815R1	②7650	Belt - P.S.; W/2WD		7460
Belt - Fan & Alt.; W/37A., 61A. Alt.; W/O Air Brakes; W/O P.T.O.; W/O X.C.	373456C1	7612	Belt - P.S.; W/4WD	285522C2	7435
Belt - Fan & Alt.; W/55A., 62A. Alt.; C, G, H Chassis	369723C91	②7630	Belt - Air Brake Compr.	359007C91	7475
Belt - Fan & Alt.; W/55A., 62A. Alt.; FD, SB Chassis	361975C91	②7673	Belt - A.P.; W/Air Brakes; W/Gov.	388139C1	7330
Belt - Fan & Alt.; W/60A. Alt.	359009C91	②7680	Belt - A.P.; W/Air Brakes; W/O Gov.	256062C2	7340
Belt - Fan & Alt.; W/65A., 80A., 105A., 145A. Alt.; W/P.T.O.	361975C91	②7673	Belt - A.P.; W/Hyd. Brakes; W/Gov.	355653C91	7380
Belt - Fan & Alt.; W/65A., 80A., 105A., 145A. Alt.; W/O P.T.O.		②7630	Belt - A.P.; W/Hyd. Brakes; W/O Gov.	362887C91	7410
Belt - P.S.; W/2WD		7460	International/Navistar V392		
Belt - P.S.; W/4WD	285522C2	7435	1603; 1703 (School Bus)		
Belt - Air Brake Compr.	359007C91	7475	Belt - Fan & Alt.; W/37A., 52A., 61A. Alt.; C, G, H Chassis; W/P.T.O.	968815R11	②7650
Belt - A.P.; W/Air Brakes; W/Gov.	388139C1	7330	Belt - Fan & Alt.; W/37A., 52A., 61A. Alt.; C, G, H Chassis; W/O P.T.O.	373457C91	②7612
Belt - A.P.; W/Air Brakes; W/O Gov.	256062C2	7340	Belt - Fan & Alt.; W/37A., 52A., 61A. Alt.; FD, SB Chassis	968815R1	②7650
Belt - A.P.; W/Hyd. Brakes; W/Gov.	355653C91	7380	Belt - Fan & Alt.; W/37A., 61A. Alt.; W/O Air Brakes; W/O P.T.O.; W/O X.C.	373456C1	7612
Belt - A.P.; W/Hyd. Brakes; W/O Gov.	362887C91	7410	Belt - Fan & Alt.; W/55A., 62A. Alt.; C, G, H Chassis	369723C91	②7630
1803			Belt - Fan & Alt.; W/55A., 62A. Alt.; FD, SB Chassis	361975C91	②7673
Belt - Fan & Alt.; W/37A., 52A., 61A. Alt.; C, G, H Chassis; W/P.T.O.	968815R11	②7650	Belt - Fan & Alt.; W/60A. Alt.	359009C91	②7680
Belt - Fan & Alt.; W/37A., 52A., 61A. Alt.; C, G, H Chassis; W/O P.T.O.	373457C91	②7612	Belt - Fan & Alt.; W/65A., 80A., 105A., 145A. Alt.; W/P.T.O.	361975C91	②7673
Belt - Fan & Alt.; W/37A., 52A., 61A. Alt.; FD, SB Chassis	968815R1	②7650	Belt - Fan & Alt.; W/65A., 80A., 105A., 145A. Alt.; W/O P.T.O.		②7630
Belt - Fan & Alt.; W/37A., 61A. Alt.; W/O Air Brakes; W/O P.T.O.; W/O X.C.	373456C1	7612	Belt - P.S.; W/2WD		7460
Belt - Fan & Alt.; W/55A., 62A. Alt.; C, G, H Chassis	369723C91	②7630	Belt - P.S.; W/4WD	285522C2	7435
Belt - Fan & Alt.; W/55A., 62A. Alt.; FD, SB Chassis	361975C91	②7673	Belt - Air Brake Compr.	359007C91	7475
Belt - Fan & Alt.; W/60A. Alt.	359009C91	②7680	Belt - A.P.; W/Air Brakes; W/Gov.	388139C1	7330
Belt - Fan & Alt.; W/65A., 80A., 105A., 145A. Alt.; W/P.T.O.	361975C91	②7673	Belt - A.P.; W/Air Brakes; W/O Gov.	256062C2	7340
Belt - Fan & Alt.; W/65A., 80A., 105A., 145A. Alt.; W/O P.T.O.		②7630	Belt - A.P.; W/Hyd. Brakes; W/Gov.	355653C91	7380
Belt - P.S.; W/2WD		7460	Belt - A.P.; W/Hyd. Brakes; W/O Gov.	362887C91	7410
Belt - P.S.; W/4WD	285522C2	7435	Hose - Upper; W/Rad. Shutters; W/Metal Hood		26515
Belt - Air Brake Compr.	359007C91	7475	Hose - Upper; W/O Rad. Shutters; W/Metal Hood		20493
Belt - A.P.; W/Air Brakes; W/Gov.	388139C1	7330	Hose - Lower - Eng. To Pipe; W/Auto. Trans.		20532
Belt - A.P.; W/Air Brakes; W/O Gov.	256062C2	7340	Hose - Lower; W/Man. Trans.		21308
Belt - A.P.; W/Hyd. Brakes; W/Gov.	355653C91	7380	Hose - By Pass		≈<20357
Belt - A.P.; W/Hyd. Brakes; W/O Gov.	362887C91	7410	1723		
Hose - Upper; W/Rad. Shutters; W/Metal Hood		26515	Belt - Fan & Alt.; W/37A., 52A., 61A. Alt.; C, G, H Chassis; W/P.T.O.	968815R11	②7650
Hose - Upper; W/O Rad. Shutters; W/Metal Hood		20493	Belt - Fan & Alt.; W/37A., 52A., 61A. Alt.; C, G, H Chassis; W/O P.T.O.	373457C91	②7612
Hose - Lower - Eng. To Pipe; W/Auto. Trans.		20532	Belt - Fan & Alt.; W/37A., 52A., 61A. Alt.; FD, SB Chassis	968815R1	②7650
Hose - Lower; W/Man. Trans.		21308	Belt - Fan & Alt.; W/37A., 61A. Alt.; W/O Air Brakes; W/O P.T.O.; W/O X.C.	373456C1	7612
Hose - By Pass		≈<20357	Belt - Fan & Alt.; W/55A., 62A. Alt.; C, G, H Chassis	369723C91	②7630
1823			Belt - Fan & Alt.; W/55A., 62A. Alt.; FD, SB Chassis	361975C91	②7673
Belt - Fan & Alt.; W/37A., 52A., 61A. Alt.; C, G, H Chassis; W/P.T.O.	968815R11	②7650	Belt - Fan & Alt.; W/60A. Alt.	359009C91	②7680
Belt - Fan & Alt.; W/37A., 52A., 61A. Alt.; C, G, H Chassis; W/O P.T.O.	373457C91	②7612	Belt - Fan & Alt.; W/65A., 80A., 105A., 145A. Alt.; W/P.T.O.	361975C91	②7673
Belt - Fan & Alt.; W/37A., 52A., 61A. Alt.; FD, SB Chassis	968815R1	②7650	Belt - Fan & Alt.; W/65A., 80A., 105A., 145A. Alt.; W/O P.T.O.		②7630
Belt - Fan & Alt.; W/37A., 61A. Alt.; W/O Air Brakes; W/O P.T.O.; W/O X.C.	373456C1	7612	Belt - P.S.; W/2WD		7460
Belt - Fan & Alt.; W/55A., 62A. Alt.; C, G, H Chassis	369723C91	②7630	Belt - P.S.; W/4WD	285522C2	7435
Belt - Fan & Alt.; W/55A., 62A. Alt.; FD, SB Chassis	361975C91	②7673	Belt - Air Brake Compr.	359007C91	7475
Belt - Fan & Alt.; W/60A. Alt.	359009C91	②7680	Belt - A.P.; W/Air Brakes; W/Gov.	388139C1	7330
			Belt - A.P.; W/Air Brakes; W/O Gov.	256062C2	7340
			Belt - A.P.; W/Hyd. Brakes; W/Gov.	355653C91	7380
			Belt - A.P.; W/Hyd. Brakes; W/O Gov.	362887C91	7410

②Two Required.

≈<Cut to Fit.

School Buses

Belts and Coolant Hose for School Buses

School Buses

Application	Mfr. Part No.	Our No.	Application	Mfr. Part No.	Our No.
International/Navistar - Continued			International/Navistar - Continued		
1974 - Continued			1974 - Continued		
International/Navistar V392 - Continued			International/Navistar V461		
1803			1603; 1703 (School Bus); 1803		
Belt - Fan & Alt.; W/37A., 52A., 61A. Alt.; C, G, H Chassis; W/P.T.O.	968815R11	②7650	Belt - Fan	②◆◆9476HD	
Belt - Fan & Alt.; W/37A., 52A., 61A. Alt.; C, G, H Chassis; W/O P.T.O.	373457C91	②7612	Belt - Alt.; W/37A., 61A. Alt.	359006C91	②7417
Belt - Fan & Alt.; W/37A., 52A., 61A. Alt.; FD, SB Chassis	968815R1	②7650	Belt - Alt.; W/65A., 80A. Alt.	151531R2	②7450
Belt - Fan & Alt.; W/37A., 61A. Alt.; W/O Air Brakes; W/O P.T.O.; W/O X.C.	373456C1	7612	Belt - Alt. & Air Brake Compr.; W/37A., 61A. Alt.		②7541
Belt - Fan & Alt.; W/55A., 62A. Alt.; C, G, H Chassis	369723C91	②7630	Belt - Alt. & Air Brake Compr.; W/65A., 80A. Alt.	358344C91	②7560
Belt - Fan & Alt.; W/55A., 62A. Alt.; FD, SB Chassis	361975C91	②7673	Belt - P.S.	358335C91	②◆◆9490HD
Belt - Fan & Alt.; W/60A. Alt.	359009C91	②7680	Hose - Upper		26531
Belt - Fan & Alt.; W/65A., 80A., 105A., 145A. Alt.; W/P.T.O.	361975C91	②7673	Hose - Lower		≈<20530
Belt - Fan & Alt.; W/65A., 80A., 105A., 145A. Alt.; W/O P.T.O.		②7630	International/Navistar V478		
Belt - P.S.; W/2WD		7460	1603; 1703 (School Bus); 1803		
Belt - P.S.; W/4WD	285522C2	7435	Belt - Fan	②◆◆9476HD	
Belt - Air Brake Compr.	359007C91	7475	Belt - Alt.; W/37A., 61A. Alt.	359006C91	②7417
Belt - A.P.; W/Air Brakes; W/Gov.	388139C1	7330	Belt - Alt.; W/65A., 80A. Alt.	151531R2	②7450
Belt - A.P.; W/Air Brakes; W/O Gov.	256062C2	7340	Belt - Alt. & Air Brake Compr.; W/37A., 61A. Alt.		②7541
Belt - A.P.; W/Hyd. Brakes; W/Gov.	355653C91	7380	Belt - Alt. & Air Brake Compr.; W/65A., 80A. Alt.	358344C91	②7560
Belt - A.P.; W/Hyd. Brakes; W/O Gov.	362887C91	7410	Belt - P.S.	358335C91	②◆◆9490HD
Hose - Upper; W/Rad. Shutters; W/Metal Hood		26515	Hose - Upper		26531
Hose - Upper; W/O Rad. Shutters; W/Metal Hood		20493	Hose - Lower		≈<20530
Hose - Lower - Eng. To Pipe; W/Auto. Trans.		20532	International/Navistar V549		
Hose - Lower; W/Man. Trans.		21308	1603; 1703 (School Bus); 1803		
Hose - By Pass		≈<20357	Belt - Fan	②◆◆9476HD	
1823			Belt - Alt.; W/37A., 61A. Alt.	359006C91	②7417
Belt - Fan & Alt.; W/37A., 52A., 61A. Alt.; C, G, H Chassis; W/P.T.O.	968815R11	②7650	Belt - Alt.; W/65A., 80A. Alt.	151531R2	②7450
Belt - Fan & Alt.; W/37A., 52A., 61A. Alt.; C, G, H Chassis; W/O P.T.O.	373457C91	②7612	Belt - Alt. & Air Brake Compr.; W/37A., 61A. Alt.		②7541
Belt - Fan & Alt.; W/37A., 52A., 61A. Alt.; FD, SB Chassis	968815R1	②7650	Belt - Alt. & Air Brake Compr.; W/65A., 80A. Alt.	358344C91	②7560
Belt - Fan & Alt.; W/37A., 61A. Alt.; W/O Air Brakes; W/O P.T.O.; W/O X.C.	373456C1	7612	Belt - P.S.	358335C91	②◆◆9490HD
Belt - Fan & Alt.; W/55A., 62A. Alt.; C, G, H Chassis	369723C91	②7630	Hose - Upper		26531
Belt - Fan & Alt.; W/55A., 62A. Alt.; FD, SB Chassis	361975C91	②7673	Hose - Lower		≈<20530
Belt - Fan & Alt.; W/60A. Alt.	359009C91	②7680	International/Navistar VS401		
Belt - Fan & Alt.; W/65A., 80A., 105A., 145A. Alt.; W/P.T.O.	361975C91	②7673	1603; 1703 (School Bus); 1803		
Belt - Fan & Alt.; W/65A., 80A., 105A., 145A. Alt.; W/O P.T.O.		②7630	Belt - Fan	②◆◆9476HD	
Belt - P.S.; W/2WD		7460	Belt - Alt.; W/37A., 61A. Alt.	359006C91	②7417
Belt - P.S.; W/4WD	285522C2	7435	Belt - Alt.; W/65A., 80A. Alt.	151531R2	②7450
Belt - Air Brake Compr.	359007C91	7475	Belt - Alt. & Air Brake Compr.; W/37A., 61A. Alt.		②7541
Belt - A.P.; W/Air Brakes; W/Gov.	388139C1	7330	Belt - Alt. & Air Brake Compr.; W/65A., 80A. Alt.	358344C91	②7560
Belt - A.P.; W/Air Brakes; W/O Gov.	256062C2	7340	Belt - P.S.	358335C91	②◆◆9490HD
Belt - A.P.; W/Hyd. Brakes; W/Gov.	355653C91	7380	Hose - Upper		26531
Belt - A.P.; W/Hyd. Brakes; W/O Gov.	362887C91	7410	Hose - Lower		≈<20530
International/Navistar V401			International/Navistar VS478		
1603; 1703 (School Bus); 1803			1603; 1703 (School Bus); 1803		
Belt - Fan		②◆◆9476HD	Belt - Fan	②◆◆9476HD	
Belt - Alt.; W/37A., 61A. Alt.	359006C91	②7417	Belt - Alt.; W/37A., 61A. Alt.	359006C91	②7417
Belt - Alt.; W/65A., 80A. Alt.	151531R2	②7450	Belt - Alt.; W/65A., 80A. Alt.	151531R2	②7450
Belt - Alt. & Air Brake Compr.; W/37A., 61A. Alt.		②7541	Belt - Alt. & Air Brake Compr.; W/37A., 61A. Alt.		②7541
Belt - Alt. & Air Brake Compr.; W/65A., 80A. Alt.	358344C91	②7560	Belt - Alt. & Air Brake Compr.; W/65A., 80A. Alt.	358344C91	②7560
Belt - P.S.	358335C91	②◆◆9490HD	Belt - P.S.	358335C91	②◆◆9490HD
Hose - Upper		26531	Hose - Upper		26531
Hose - Lower		≈<20530	Hose - Lower		≈<20530
International/Navistar V461			International/Navistar VS549		
1603; 1703 (School Bus); 1803			1603; 1703 (School Bus); 1803		
Belt - Fan		②◆◆9476HD	Belt - Fan	②◆◆9476HD	
Belt - Alt.; W/37A., 61A. Alt.	359006C91	②7417	Belt - Alt.; W/37A., 61A. Alt.	359006C91	②7417
Belt - Alt.; W/65A., 80A. Alt.	151531R2	②7450	Belt - Alt.; W/65A., 80A. Alt.	151531R2	②7450
Belt - Alt. & Air Brake Compr.; W/37A., 61A. Alt.		②7541	Belt - Alt. & Air Brake Compr.; W/37A., 61A. Alt.		②7541
Belt - Alt. & Air Brake Compr.; W/65A., 80A. Alt.	358344C91	②7560	Belt - Alt. & Air Brake Compr.; W/65A., 80A. Alt.	358344C91	②7560
Belt - P.S.	358335C91	②◆◆9490HD	Belt - P.S.	358335C91	②◆◆9490HD
Hose - Upper		26531	Hose - Upper		26531
Hose - Lower		≈<20530	Hose - Lower		≈<20530

②Two Required.
◆Standard Belt Available.

≈<Cut to Fit.
◆PowerBand Belt May Work, Use Template to Check.

Belts and Coolant Hose for School Buses

Application	Mfr. Part No.	Our No.	Application	Mfr. Part No.	Our No.
International/Navistar - Continued			International/Navistar - Continued		
1974 - Continued			1973 - Continued		
International/Navistar VS549 - Continued			International/Navistar FTVS549 - Continued		
1603; 1703 (School Bus); 1803 - Continued			193RE - Continued		
Hose - Upper		26531	Belt - W.P.	359021C91	②TR22434
Hose - Lower		≈<20530	Belt - Alt.; W/37A. Alt.	256346C11	②♠9350HD
1973			Belt - Alt.; W/55A., 60A., 62A., 105A., 130A. Alt.		②♠9365HD
Caterpillar 1145 Diesel			Belt - Alt. & Air Brake Compr.	243605R11	②♠♠9451HD
1853			Belt - P.S.	164550R2	♠9425HD
Belt - Fan	426222C91	②♠♠9530HD	Hose - Upper - Eng. To Pipe		24228
Belt - Alt.; W/37A., 61A. Alt.	398601C91	②♠9440HD	or		26501
Belt - Alt.; W/65A., 80A. Alt.	354029C91	②♠♠9476HD	Hose - Upper - Pipe To Rad.		24236
Belt - Alt. & Air Brake Compr.; W/37A., 61A. Alt.		②♠9465HD	Hose - Lower		24942
Belt - Alt. & Air Brake Compr.; W/65A., 80A. Alt.	427205C91	②♠♠9500HD	Hose - By Pass		≈<20618
Belt - P.S.		♠9465HD	or		28442
Hose - Upper		26532	Hose - Heater		24216
Caterpillar 1150 Diesel			1603; 1703 (School Bus); 1803		
1853			Belt - Fan		
Belt - Fan	426222C91	②♠♠9530HD	Belt - Alt.; W/37A., 61A. Alt.	359006C91	②♠♠9476HD
Belt - Alt.; W/37A., 61A. Alt.	398601C91	②♠9440HD	Belt - Alt.; W/65A., 80A. Alt.	151531R2	②7417
Belt - Alt.; W/65A., 80A. Alt.	354029C91	②♠♠9476HD	Belt - Alt. & Air Brake Compr.; W/37A., 61A. Alt.		②7450
Belt - Alt. & Air Brake Compr.; W/37A., 61A. Alt.		②♠9465HD	Belt - Alt. & Air Brake Compr.; W/65A., 80A. Alt.	358344C91	②7560
Belt - Alt. & Air Brake Compr.; W/65A., 80A. Alt.	427205C91	②♠♠9500HD	Belt - P.S.	358335C91	②♠♠9490HD
Belt - P.S.		♠9465HD	Hose - Upper		26531
Hose - Upper		26532	Hose - Lower		≈<20530
Caterpillar 1160 Diesel			International/Navistar RD372		
1853			1823		
Belt - Fan	426222C91	②♠♠9530HD	Belt - Fan & Alt.	359014C91	②TR22514
Belt - Alt.; W/37A., 61A. Alt.	398601C91	②♠9440HD	Belt - W.P. & Alt.; W/37A. Alt.; Chassis No. FD61626 & Before	193826R11	②TR22508
Belt - Alt.; W/65A., 80A. Alt.	354029C91	②♠♠9476HD	Belt - W.P. & Alt.; W/37A. Alt.; Chassis No. FD61626 & Up & G Chassis No.	223794R11	②TR22514
Belt - Alt. & Air Brake Compr.; W/37A., 61A. Alt.		②♠9465HD	Belt - W.P. & Alt.; W/60A. Alt.	243604R11	②TR22517
Belt - Alt. & Air Brake Compr.; W/65A., 80A. Alt.	427205C91	②♠♠9500HD	Belt - P.S.	240354R2	TR22336
Belt - P.S.		♠9465HD	Belt - Air Brake Compr.; W/Wagner Compr.	92836HA	TR32491
Hose - Upper		26532	Belt - Air Brake Compr.; W/Westinghouse Compr.	83816HA	TR34467
International/Navistar FTV549			Hose - Upper		26515
193RE			Hose - Lower		24232
Belt - Fan	358319C91	②♠♠9570HD	1853		
Belt - W.P.	359021C91	②TR22434	Belt - Alt.; W/55A., 62A., 145A. Alt.	223794K21	②TR22514
Belt - Alt.; W/37A. Alt.	256346C11	②♠9350HD	Belt - Gen.; W/37A. Gen.	193826R11	TR22508
Belt - Alt.; W/55A., 60A., 62A., 105A., 130A. Alt.		②♠9365HD	Belt - P.S.	240354R1	TR22344
Belt - Alt. & Air Brake Compr.	243605R11	②♠♠9451HD	1853FC		
Belt - P.S.	164550R2	♠9425HD	Belt - Alt.; W/55A., 62A., 145A. Alt.	223794K21	②TR22514
Hose - Upper - Eng. To Pipe		24228	Belt - Gen.; W/37A. Gen.	193826R11	TR22508
or		26501	Belt - P.S.	240354R1	TR22344
Hose - Upper - Pipe To Rad.		24236	Hose - Upper; Late FD Chassis; Chassis No. FA66376 ...		26509
Hose - Lower		24942	Hose - Lower; Early FD Chassis; Chassis No. FA66376 ...		26508
Hose - By Pass		≈<20618	Hose - Lower; Late FD Chassis; Chassis No. FA66376 ...		24234
or		28442	or		26508
Hose - Heater		24216	International/Navistar RD406		
1603; 1703 (School Bus); 1803			1823		
Belt - Fan		②♠♠9476HD	Belt - Fan & Alt.	359014C91	②TR22514
Belt - Alt.; W/37A., 61A. Alt.	359006C91	②7417	Belt - W.P. & Alt.; W/37A. Alt.; Chassis No. FD61626 & Before	193826R11	②TR22508
Belt - Alt.; W/65A., 80A. Alt.	151531R2	②7450	Belt - W.P. & Alt.; W/37A. Alt.; Chassis No. FD61626 & Up & G Chassis No.	223794R11	②TR22514
Belt - Alt. & Air Brake Compr.; W/37A., 61A. Alt.		②7541	Belt - W.P. & Alt.; W/60A. Alt.	243604R11	②TR22517
Belt - Alt. & Air Brake Compr.; W/65A., 80A. Alt.	358344C91	②7560	Belt - P.S.	240354R2	TR22336
Belt - P.S.	358335C91	②♠♠9490HD	Belt - Air Brake Compr.; W/Wagner Compr.	92836HA	TR32491
Hose - Upper		26531	Belt - Air Brake Compr.; W/Westinghouse Compr.	83816HA	TR34467
Hose - Lower		≈<20530	Hose - Upper		26515
International/Navistar FTVS549			Hose - Lower		24232
193RE			1853		
Belt - Fan	358319C91	②♠♠9570HD	Belt - Alt.; W/55A., 62A., 145A. Alt.	223794K21	②TR22514

≈<Cut to Fit.

♠PowerBand Belt May Work, Use Template to Check.

♠Standard Belt Available.

②Two Required.

School Buses

Belts and Coolant Hose for School Buses

School Buses

Application	Mfr. Part No.	Our No.	Application	Mfr. Part No.	Our No.
International/Navistar - Continued			International/Navistar - Continued		
1973 - Continued			1973 - Continued		
International/Navistar RD406 - Continued			International/Navistar V266		
1853 - Continued			1603; 1703 (School Bus); 1803		
Belt - Gen.; W/37A. Gen.	193826R11	TR22508	Belt - Fan & Alt.; W/37A., 52A., 61A. Alt.; C, G, H		
Belt - P.S.	240354R1	TR22344	Chassis	255266C3	②7603
1853FC			Belt - Fan & Alt.; W/37A., 52A., 61A. Alt.;		
Belt - Alt.; W/55A., 62A., 145A. Alt.	223794K21	②TR22514	FD, SB Chassis	255266C3	②7640
Belt - Gen.; W/37A. Gen.	193826R11	TR22508	Belt - Fan & Alt.; W/55A., 62A. Alt.; C, G, H		
Belt - P.S.	240354R1	TR22344	Chassis	369725C91	②7619
Hose - Upper; Late FD Chassis; Chassis No. FA66376	26509	26509	Belt - Fan & Alt.; W/55A., 62A. Alt.; FD, SB		
Hose - Lower; Early FD Chassis; Chassis No. FA66376 ..	26508	26508	Chassis	358998C91	②7650
Hose - Lower; Late FD Chassis; Chassis No. FA66376	24234	24234	Belt - P.S.; W/2WD	151529R2	7440
or	26508	26508	Belt - P.S.; W/4WD	151531R2	7450
International/Navistar RD450			Belt - Air Brake Compr.	236572R2	7460
1823			Hose - Upper; W/Rad. Shutters; W/Metal Hood		26515
Belt - Fan & Alt.	359014C91	②TR22514	Hose - Upper; W/O Rad. Shutters; W/Metal Hood		20493
Belt - W.P. & Alt.; W/37A. Alt.; Chassis No.			Hose - Lower - Eng. To Pipe; W/Auto. Trans.		20532
FD61626 & Before	193826R11	②TR22508	Hose - Lower; W/Man. Trans.		21308
Belt - W.P. & Alt.; W/37A. Alt.; Chassis No.			Hose - By Pass		②<20357
FD61626 & Up & G Chassis No.	223794R11	②TR22514	International/Navistar V304		
Belt - W.P. & Alt.; W/60A. Alt.	243604R11	②TR22517	1603; 1703 (School Bus); 1803		
Belt - P.S.	240354R2	TR22336	Belt - Fan & Alt.; W/37A., 52A., 61A. Alt.; C, G, H		
Belt - Air Brake Compr.; W/Wagner Compr.	92836HA	TR32491	Chassis		
Belt - Air Brake Compr.; W/Westinghouse			Chassis		
Compr.	83816HA	TR34467	FD, SB Chassis		
Hose - Upper		26515	Belt - Fan & Alt.; W/55A., 62A. Alt.; C, G, H		
Hose - Lower		24232	Chassis		
1853			Belt - Fan & Alt.; W/55A., 62A. Alt.; FD, SB		
Belt - Alt.; W/55A., 62A., 145A. Alt.	223794K21	②TR22514	Chassis		
Belt - Gen.; W/37A. Gen.	193826R11	TR22508	Belt - P.S.; W/2WD		
Belt - P.S.	240354R1	TR22344	Belt - P.S.; W/4WD		
1853FC			Belt - Air Brake Compr.		
Belt - Alt.; W/55A., 62A., 145A. Alt.	223794K21	②TR22514	Hose - Upper; W/Rad. Shutters; W/Metal Hood		
Belt - Gen.; W/37A. Gen.	193826R11	TR22508	Hose - Upper; W/O Rad. Shutters; W/Metal Hood		
Belt - P.S.	240354R1	TR22344	Hose - Lower - Eng. To Pipe; W/Auto. Trans.		
Hose - Upper; Late FD Chassis; Chassis No. FA66376	26509	26509	Hose - Lower; W/Man. Trans.		
Hose - Lower; Early FD Chassis; Chassis No. FA66376 ..	26508	26508	Hose - By Pass		
Hose - Lower; Late FD Chassis; Chassis No. FA66376	24234	24234	②<20357		
or	26508	26508	International/Navistar V345		
International/Navistar RD501			1603; 1703 (School Bus)		
1823			Belt - Fan & Alt.; W/37A., 52A., 61A. Alt.;		
Belt - Fan & Alt.	359014C91	②TR22514	C, G, H Chassis; W/P.T.O.		
Belt - W.P. & Alt.; W/37A. Alt.; Chassis No.			968815R11		
FD61626 & Before	193826R11	②TR22508	②7650		
Belt - W.P. & Alt.; W/37A. Alt.; Chassis No.			Belt - Fan & Alt.; W/37A., 52A., 61A. Alt.;		
FD61626 & Up & G Chassis No.	223794R11	②TR22514	C, G, H Chassis; W/O P.T.O.		
Belt - W.P. & Alt.; W/60A. Alt.	243604R11	②TR22517	373457C91		
Belt - P.S.	240354R2	TR22336	②7612		
Belt - Air Brake Compr.; W/Wagner Compr.	92836HA	TR32491	Belt - Fan & Alt.; W/37A., 52A., 61A. Alt.;		
Belt - Air Brake Compr.; W/Westinghouse			FD, SB Chassis		
Compr.	83816HA	TR34467	968815R1		
Hose - Upper		26515	②7650		
Hose - Lower		24232	Belt - Fan & Alt.; W/37A., 61A. Alt.; W/O		
1853			Air Brakes; W/O P.T.O.; W/O X.C.		
Belt - Alt.; W/55A., 62A., 145A. Alt.	223794K21	②TR22514	373456C1		
Belt - Gen.; W/37A. Gen.	193826R11	TR22508	7612		
Belt - P.S.	240354R1	TR22344	Belt - Fan & Alt.; W/55A., 62A. Alt.; C, G, H		
1853FC			Chassis		
Belt - Alt.; W/55A., 62A., 145A. Alt.	223794K21	②TR22514	369723C91		
Belt - Gen.; W/37A. Gen.	193826R11	TR22508	②7630		
Belt - P.S.	240354R1	TR22344	Belt - Fan & Alt.; W/55A., 62A. Alt.; FD, SB		
Hose - Upper; Late FD Chassis; Chassis No. FA66376	26509	26509	Chassis		
Hose - Lower; Early FD Chassis; Chassis No. FA66376 ..	26508	26508	361975C91		
Hose - Lower; Late FD Chassis; Chassis No. FA66376	24234	24234	②7673		
or	26508	26508	Belt - Fan & Alt.; W/60A. Alt.		
			359009C91		
			②7680		
			Belt - Fan & Alt.; W/65A., 80A., 105A.,		
			145A. Alt.; W/P.T.O.		
			361975C91		
			②7673		
			Belt - Fan & Alt.; W/65A., 80A., 105A., 145A. Alt.; W/O		
			P.T.O.		
			②7630		
			Belt - P.S.; W/2WD		
			7460		
			Belt - P.S.; W/4WD		
			285522C2		
			7435		
			Belt - Air Brake Compr.		
			359007C91		
			7475		
			Belt - A.P.; W/Air Brakes; W/Gov.		
			388139C1		
			7330		
			Belt - A.P.; W/Air Brakes; W/O Gov.		
			256062C2		
			7340		
			Belt - A.P.; W/Hyd. Brakes; W/Gov.		
			355653C91		
			7380		
			Belt - A.P.; W/Hyd. Brakes; W/O Gov.		
			362887C91		
			7410		
			Hose - Upper; W/Rad. Shutters; W/Metal Hood		
			26515		
			Hose - Upper; W/O Rad. Shutters; W/Metal Hood		
			20493		
			Hose - Lower - Eng. To Pipe; W/Auto. Trans.		
			20532		
			Hose - Lower; W/Man. Trans.		
			21308		
			Hose - By Pass		
			②<20357		

②Two Required.

②<Cut to Fit.

Belts and Coolant Hose for School Buses

Application	Mfr. Part No.	Our No.	Application	Mfr. Part No.	Our No.
International/Navistar - Continued			International/Navistar - Continued		
1973 - Continued			1973 - Continued		
International/Navistar V345 - Continued			International/Navistar V345 - Continued		
1723			1823 - Continued		
Belt - Fan & Alt.; W/37A., 52A., 61A. Alt.; C, G, H Chassis; W/P.T.O.	968815R11	②7650	Belt - Fan & Alt.; W/65A., 80A., 105A., 145A. Alt.; W/P.T.O.	361975C91	②7673
Belt - Fan & Alt.; W/37A., 52A., 61A. Alt.; C, G, H Chassis; W/O P.T.O.	373457C91	②7612	Belt - Fan & Alt.; W/65A., 80A., 105A., 145A. Alt.; W/O P.T.O.		②7630
Belt - Fan & Alt.; W/37A., 52A., 61A. Alt.; FD, SB Chassis	968815R1	②7650	Belt - P.S.; W/2WD		7460
Belt - Fan & Alt.; W/37A., 61A. Alt.; W/O Air Brakes; W/O P.T.O.; W/O X.C.	373456C1	7612	Belt - P.S.; W/4WD	285522C2	7435
Belt - Fan & Alt.; W/55A., 62A. Alt.; C, G, H Chassis	369723C91	②7630	Belt - Air Brake Compr.	359007C91	7475
Belt - Fan & Alt.; W/55A., 62A. Alt.; FD, SB Chassis	361975C91	②7673	Belt - A.P.; W/Air Brakes; W/Gov.	388139C1	7330
Belt - Fan & Alt.; W/60A. Alt.	359009C91	②7680	Belt - A.P.; W/Air Brakes; W/O Gov.	256062C2	7340
Belt - Fan & Alt.; W/65A., 80A., 105A., 145A. Alt.; W/P.T.O.	361975C91	②7673	Belt - A.P.; W/Hyd. Brakes; W/Gov.	355653C91	7380
Belt - Fan & Alt.; W/65A., 80A., 105A., 145A. Alt.; W/O P.T.O.		②7630	Belt - A.P.; W/Hyd. Brakes; W/O Gov.	362887C91	7410
Belt - P.S.; W/2WD		7460	International/Navistar V392		
Belt - P.S.; W/4WD	285522C2	7435	1603; 1703 (School Bus)		
Belt - Air Brake Compr.	359007C91	7475	Belt - Fan & Alt.; W/37A., 52A., 61A. Alt.; C, G, H Chassis; W/P.T.O.	968815R11	②7650
Belt - A.P.; W/Air Brakes; W/Gov.	388139C1	7330	Belt - Fan & Alt.; W/37A., 52A., 61A. Alt.; C, G, H Chassis; W/O P.T.O.	373457C91	②7612
Belt - A.P.; W/Air Brakes; W/O Gov.	256062C2	7340	Belt - Fan & Alt.; W/37A., 52A., 61A. Alt.; FD, SB Chassis	968815R1	②7650
Belt - A.P.; W/Hyd. Brakes; W/Gov.	355653C91	7380	Belt - Fan & Alt.; W/37A., 61A. Alt.; W/O Air Brakes; W/O P.T.O.; W/O X.C.	373456C1	7612
Belt - A.P.; W/Hyd. Brakes; W/O Gov.	362887C91	7410	Belt - Fan & Alt.; W/55A., 62A. Alt.; C, G, H Chassis	369723C91	②7630
1803			Belt - Fan & Alt.; W/55A., 62A. Alt.; FD, SB Chassis	361975C91	②7673
Belt - Fan & Alt.; W/37A., 52A., 61A. Alt.; C, G, H Chassis; W/P.T.O.	968815R11	②7650	Belt - Fan & Alt.; W/60A. Alt.	359009C91	②7680
Belt - Fan & Alt.; W/37A., 52A., 61A. Alt.; C, G, H Chassis; W/O P.T.O.	373457C91	②7612	Belt - Fan & Alt.; W/65A., 80A., 105A., 145A. Alt.; W/P.T.O.	361975C91	②7673
Belt - Fan & Alt.; W/37A., 52A., 61A. Alt.; FD, SB Chassis	968815R1	②7650	Belt - Fan & Alt.; W/65A., 80A., 105A., 145A. Alt.; W/O P.T.O.		②7630
Belt - Fan & Alt.; W/37A., 61A. Alt.; W/O Air Brakes; W/O P.T.O.; W/O X.C.	373456C1	7612	Belt - P.S.; W/2WD		7460
Belt - Fan & Alt.; W/55A., 62A. Alt.; C, G, H Chassis	369723C91	②7630	Belt - P.S.; W/4WD	285522C2	7435
Belt - Fan & Alt.; W/55A., 62A. Alt.; FD, SB Chassis	361975C91	②7673	Belt - Air Brake Compr.	359007C91	7475
Belt - Fan & Alt.; W/60A. Alt.	359009C91	②7680	Belt - A.P.; W/Air Brakes; W/Gov.	388139C1	7330
Belt - Fan & Alt.; W/65A., 80A., 105A., 145A. Alt.; W/P.T.O.	361975C91	②7673	Belt - A.P.; W/Air Brakes; W/O Gov.	256062C2	7340
Belt - Fan & Alt.; W/65A., 80A., 105A., 145A. Alt.; W/O P.T.O.		②7630	Belt - A.P.; W/Hyd. Brakes; W/Gov.	355653C91	7380
Belt - P.S.; W/2WD		7460	Belt - A.P.; W/Hyd. Brakes; W/O Gov.	362887C91	7410
Belt - P.S.; W/4WD	285522C2	7435	Hose - Upper; W/Rad. Shutters; W/Metal Hood		26515
Belt - Air Brake Compr.	359007C91	7475	Hose - Upper; W/O Rad. Shutters; W/Metal Hood		20493
Belt - A.P.; W/Air Brakes; W/Gov.	388139C1	7330	Hose - Lower - Eng. To Pipe; W/Auto. Trans.		20532
Belt - A.P.; W/Air Brakes; W/O Gov.	256062C2	7340	Hose - Lower; W/Man. Trans.		21308
Belt - A.P.; W/Hyd. Brakes; W/Gov.	355653C91	7380	Hose - By Pass		≈<20357
Belt - A.P.; W/Hyd. Brakes; W/O Gov.	362887C91	7410	1723		
Hose - Upper; W/Rad. Shutters; W/Metal Hood		26515	Belt - Fan & Alt.; W/37A., 52A., 61A. Alt.; C, G, H Chassis; W/P.T.O.	968815R11	②7650
Hose - Upper; W/O Rad. Shutters; W/Metal Hood		20493	Belt - Fan & Alt.; W/37A., 52A., 61A. Alt.; C, G, H Chassis; W/O P.T.O.	373457C91	②7612
Hose - Lower - Eng. To Pipe; W/Auto. Trans.		20532	Belt - Fan & Alt.; W/37A., 52A., 61A. Alt.; FD, SB Chassis	968815R1	②7650
Hose - Lower; W/Man. Trans.		21308	Belt - Fan & Alt.; W/37A., 61A. Alt.; W/O Air Brakes; W/O P.T.O.; W/O X.C.	373456C1	7612
Hose - By Pass		≈<20357	Belt - Fan & Alt.; W/55A., 62A. Alt.; C, G, H Chassis	369723C91	②7630
1823			Belt - Fan & Alt.; W/55A., 62A. Alt.; FD, SB Chassis	361975C91	②7673
Belt - Fan & Alt.; W/37A., 52A., 61A. Alt.; C, G, H Chassis; W/P.T.O.	968815R11	②7650	Belt - Fan & Alt.; W/60A. Alt.	359009C91	②7680
Belt - Fan & Alt.; W/37A., 52A., 61A. Alt.; C, G, H Chassis; W/O P.T.O.	373457C91	②7612	Belt - Fan & Alt.; W/65A., 80A., 105A., 145A. Alt.; W/P.T.O.	361975C91	②7673
Belt - Fan & Alt.; W/37A., 52A., 61A. Alt.; FD, SB Chassis	968815R1	②7650	Belt - Fan & Alt.; W/65A., 80A., 105A., 145A. Alt.; W/O P.T.O.		②7630
Belt - Fan & Alt.; W/37A., 61A. Alt.; W/O Air Brakes; W/O P.T.O.; W/O X.C.	373456C1	7612	Belt - P.S.; W/2WD		7460
Belt - Fan & Alt.; W/55A., 62A. Alt.; C, G, H Chassis	369723C91	②7630	Belt - P.S.; W/4WD	285522C2	7435
Belt - Fan & Alt.; W/55A., 62A. Alt.; FD, SB Chassis	361975C91	②7673	Belt - Air Brake Compr.	359007C91	7475
Belt - Fan & Alt.; W/60A. Alt.	359009C91	②7680	Belt - A.P.; W/Air Brakes; W/Gov.	388139C1	7330
			Belt - A.P.; W/Air Brakes; W/O Gov.	256062C2	7340
			Belt - A.P.; W/Hyd. Brakes; W/Gov.	355653C91	7380
			Belt - A.P.; W/Hyd. Brakes; W/O Gov.	362887C91	7410

②Two Required.

≈<Cut to Fit.

School Buses

Belts and Coolant Hose for School Buses

School Buses

Application	Mfr. Part No.	Our No.	Application	Mfr. Part No.	Our No.
International/Navistar - Continued			International/Navistar - Continued		
1973 - Continued			1973 - Continued		
International/Navistar V392 - Continued			International/Navistar V401 - Continued		
1803			193RE - Continued		
Belt - Fan & Alt.; W/37A., 52A., 61A. Alt.; C, G, H Chassis; W/P.T.O.	968815R11	@7650	Hose - By Pass		≈20618 or 28442
Belt - Fan & Alt.; W/37A., 52A., 61A. Alt.; C, G, H Chassis; W/O P.T.O.	373457C91	@7612	Hose - Heater		24216
Belt - Fan & Alt.; W/37A., 52A., 61A. Alt.; FD, SB Chassis	968815R1	@7650	1603; 1703 (School Bus); 1803		
Belt - Fan & Alt.; W/37A., 61A. Alt.; W/O Air Brakes; W/O P.T.O.; W/O X.C.	373456C1	7612	Belt - Fan	@◆◆◆9476HD	
Belt - Fan & Alt.; W/55A., 62A. Alt.; C, G, H Chassis	369723C91	@7630	Belt - Alt.; W/37A., 61A. Alt.	359006C91	@7417
Belt - Fan & Alt.; W/55A., 62A. Alt.; FD, SB Chassis	361975C91	@7673	Belt - Alt.; W/65A., 80A. Alt.	151531R2	@7450
Belt - Fan & Alt.; W/60A. Alt.	359009C91	@7680	Belt - Alt. & Air Brake Compr.; W/37A., 61A. Alt.		@7541
Belt - Fan & Alt.; W/65A., 80A., 105A., 145A. Alt.; W/P.T.O.	361975C91	@7673	Belt - Alt. & Air Brake Compr.; W/65A., 80A. Alt.	358344C91	@7560
Belt - Fan & Alt.; W/65A., 80A., 105A., 145A. Alt.; W/O P.T.O.		@7630	Belt - P.S.	358335C91	@◆◆◆9490HD
Belt - P.S.; W/2WD		7460	Hose - Upper		26531
Belt - P.S.; W/4WD	285522C2	7435	Hose - Lower		≈20530
Belt - Air Brake Compr.	359007C91	7475	International/Navistar V461		
Belt - A.P.; W/Air Brakes; W/Gov.	388139C1	7330	193RE		
Belt - A.P.; W/Air Brakes; W/O Gov.	256062C2	7340	Belt - Fan	358319C91	@◆◆◆9570HD
Belt - A.P.; W/Hyd. Brakes; W/Gov.	355653C91	7380	Belt - W.P.	359021C91	@TR22434
Belt - A.P.; W/Hyd. Brakes; W/O Gov.	362887C91	7410	Belt - Alt.; W/37A. Alt.	256346C11	@◆◆9350HD
Hose - Upper; W/Rad. Shutters; W/Metal Hood		26515	Belt - Alt.; W/55A., 60A., 62A., 105A., 130A. Alt.		@◆◆9365HD
Hose - Upper; W/O Rad. Shutters; W/Metal Hood		20493	Belt - Alt. & Air Brake Compr.	243605R11	@◆◆◆9451HD
Hose - Lower - Eng. To Pipe; W/Auto. Trans.		20532	Belt - P.S.	164550R2	◆9425HD
Hose - Lower; W/Man. Trans.		21308	Hose - Upper - Eng. To Pipe		24228 or 26501
Hose - By Pass		≈20357	Hose - Upper - Pipe To Rad.		24236
1823			Hose - Lower		24942
Belt - Fan & Alt.; W/37A., 52A., 61A. Alt.; C, G, H Chassis; W/P.T.O.	968815R11	@7650	Hose - By Pass		≈20618 or 28442
Belt - Fan & Alt.; W/37A., 52A., 61A. Alt.; C, G, H Chassis; W/O P.T.O.	373457C91	@7612	Hose - Heater		24216
Belt - Fan & Alt.; W/37A., 52A., 61A. Alt.; FD, SB Chassis	968815R1	@7650	1603; 1703 (School Bus); 1803		
Belt - Fan & Alt.; W/37A., 61A. Alt.; W/O Air Brakes; W/O P.T.O.; W/O X.C.	373456C1	7612	Belt - Fan	@◆◆◆9476HD	
Belt - Fan & Alt.; W/55A., 62A. Alt.; C, G, H Chassis	369723C91	@7630	Belt - Alt.; W/37A., 61A. Alt.	359006C91	@7417
Belt - Fan & Alt.; W/55A., 62A. Alt.; FD, SB Chassis	361975C91	@7673	Belt - Alt.; W/65A., 80A. Alt.	151531R2	@7450
Belt - Fan & Alt.; W/60A. Alt.	359009C91	@7680	Belt - Alt. & Air Brake Compr.; W/37A., 61A. Alt.		@7541
Belt - Fan & Alt.; W/65A., 80A., 105A., 145A. Alt.; W/P.T.O.	361975C91	@7673	Belt - Alt. & Air Brake Compr.; W/65A., 80A. Alt.	358344C91	@7560
Belt - Fan & Alt.; W/65A., 80A., 105A., 145A. Alt.; W/O P.T.O.		@7630	Belt - P.S.	358335C91	@◆◆◆9490HD
Belt - P.S.; W/2WD		7460	Hose - Upper		26531
Belt - P.S.; W/4WD	285522C2	7435	Hose - Lower		≈20530
Belt - Air Brake Compr.	359007C91	7475	International/Navistar V478		
Belt - A.P.; W/Air Brakes; W/Gov.	388139C1	7330	193RE		
Belt - A.P.; W/Air Brakes; W/O Gov.	256062C2	7340	Belt - Fan	358319C91	@◆◆◆9570HD
Belt - A.P.; W/Hyd. Brakes; W/Gov.	355653C91	7380	Belt - W.P.	359021C91	@TR22434
Belt - A.P.; W/Hyd. Brakes; W/O Gov.	362887C91	7410	Belt - Alt.; W/37A. Alt.	256346C11	@◆◆9350HD
International/Navistar V401			Belt - Alt.; W/55A., 60A., 62A., 105A., 130A. Alt.		@◆◆9365HD
193RE			Belt - Alt. & Air Brake Compr.	243605R11	@◆◆◆9451HD
Belt - Fan	358319C91	@◆◆◆9570HD	Belt - P.S.	164550R2	◆9425HD
Belt - W.P.	359021C91	@TR22434	Hose - Upper - Eng. To Pipe		24228 or 26501
Belt - Alt.; W/37A. Alt.	256346C11	@◆◆9350HD	Hose - Upper - Pipe To Rad.		24236
Belt - Alt.; W/55A., 60A., 62A., 105A., 130A. Alt.		@◆◆9365HD	Hose - Lower		24942
Belt - Alt. & Air Brake Compr.	243605R11	@◆◆◆9451HD	Hose - By Pass		≈20618 or 28442
Belt - P.S.	164550R2	◆9425HD	Hose - Heater		24216
Hose - Upper - Eng. To Pipe		24228	1603; 1703 (School Bus); 1803		
or		26501	Belt - Fan	@◆◆◆9476HD	
Hose - Upper - Pipe To Rad.		24236	Belt - Alt.; W/37A., 61A. Alt.	359006C91	@7417
Hose - Lower		24942	Belt - Alt.; W/65A., 80A. Alt.	151531R2	@7450
			Belt - Alt. & Air Brake Compr.; W/37A., 61A. Alt.		@7541
			Belt - Alt. & Air Brake Compr.; W/65A., 80A. Alt.	358344C91	@7560
			Belt - P.S.	358335C91	@◆◆◆9490HD
			Hose - Upper		26531
			Hose - Lower		≈20530

②Two Required.
◆Standard Belt Available.

≈Cut to Fit.
◆PowerBand Belt May Work, Use Template to Check.

Belts and Coolant Hose for School Buses

Application	Mfr. Part No.	Our No.	Application	Mfr. Part No.	Our No.
International/Navistar - Continued			International/Navistar - Continued		
1973 - Continued			1973 - Continued		
International/Navistar V549			International/Navistar VS478 - Continued		
193RE			1603; 1703 (School Bus); 1803		
Belt - Fan	358319C91	②◆◆9570HD	Belt - Fan	359006C91	②◆◆9476HD
Belt - W.P.	359021C91	②TR22434	Belt - Alt.; W/37A., 61A. Alt.	359006C91	②7417
Belt - Alt.; W/37A. Alt.	256346C11	②◆◆9350HD	Belt - Alt.; W/65A., 80A. Alt.	151531R2	②7450
Belt - Alt.; W/55A., 60A., 62A., 105A., 130A. Alt.		②◆◆9365HD	Belt - Alt. & Air Brake Compr.; W/37A., 61A. Alt.		②7541
Belt - Alt. & Air Brake Compr.	243605R11	②◆◆9451HD	Belt - Alt. & Air Brake Compr.; W/65A.,		
Belt - P.S.	164550R2	◆9425HD	80A. Alt.	358344C91	②7560
Hose - Upper - Eng. To Pipe	24228		Belt - P.S.	358335C91	②◆◆9490HD
	or	26501	Hose - Upper		26531
Hose - Upper - Pipe To Rad.		24236	Hose - Lower		≈<20530
Hose - Lower		24942			
Hose - By Pass		≈<20618	International/Navistar VS549		
	or	28442	193RE		
Hose - Heater		24216	Belt - Fan	358319C91	②◆◆9570HD
			Belt - W.P.	359021C91	②TR22434
1603; 1703 (School Bus); 1803			Belt - Alt.; W/37A. Alt.	256346C11	②◆◆9350HD
Belt - Fan		②◆◆9476HD	Belt - Alt.; W/55A., 60A., 62A., 105A., 130A. Alt.		②◆◆9365HD
Belt - Alt.; W/37A., 61A. Alt.	359006C91	②7417	Belt - Alt. & Air Brake Compr.	243605R11	②◆◆9451HD
Belt - Alt.; W/65A., 80A. Alt.	151531R2	②7450	Belt - P.S.	164550R2	◆9425HD
Belt - Alt. & Air Brake Compr.; W/37A., 61A. Alt.		②7541	Hose - Upper - Eng. To Pipe		24228
Belt - Alt. & Air Brake Compr.; W/65A.,				or	26501
80A. Alt.	358344C91	②7560	Hose - Upper - Pipe To Rad.		24236
Belt - P.S.	358335C91	②◆◆9490HD	Hose - Lower		24942
Hose - Upper		26531	Hose - By Pass		≈<20618
Hose - Lower		≈<20530		or	28442
			Hose - Heater		24216
International/Navistar VS401			1603; 1703 (School Bus); 1803		
193RE			Belt - Fan		
Belt - Fan	358319C91	②◆◆9570HD	Belt - Alt.; W/37A., 61A. Alt.	359006C91	②◆◆9476HD
Belt - W.P.	359021C91	②TR22434	Belt - Alt.; W/65A., 80A. Alt.	151531R2	②7417
Belt - Alt.; W/37A. Alt.	256346C11	②◆◆9350HD	Belt - Alt. & Air Brake Compr.; W/37A., 61A. Alt.		②7450
Belt - Alt.; W/55A., 60A., 62A., 105A., 130A. Alt.		②◆◆9365HD	Belt - Alt. & Air Brake Compr.; W/65A.,		②7541
Belt - Alt. & Air Brake Compr.	243605R11	②◆◆9451HD	80A. Alt.	358344C91	②7560
Belt - P.S.	164550R2	◆9425HD	Belt - P.S.	358335C91	②◆◆9490HD
Hose - Upper - Eng. To Pipe	24228		Hose - Upper		26531
	or	26501	Hose - Lower		≈<20530
Hose - Upper - Pipe To Rad.		24236			
Hose - Lower		24942	1972		
Hose - By Pass		≈<20618	Caterpillar 1145 Diesel		
	or	28442	1853		
Hose - Heater		24216	Belt - Fan	426222C91	②◆◆9530HD
			Belt - Alt.; W/37A., 61A. Alt.	398601C91	②◆◆9440HD
1603; 1703 (School Bus); 1803			Belt - Alt.; W/65A., 80A. Alt.	354029C91	②◆◆9476HD
Belt - Fan		②◆◆9476HD	Belt - Alt. & Air Brake Compr.; W/37A., 61A. Alt.		②◆◆9465HD
Belt - Alt.; W/37A., 61A. Alt.	359006C91	②7417	Belt - Alt. & Air Brake Compr.; W/65A.,		
Belt - Alt.; W/65A., 80A. Alt.	151531R2	②7450	80A. Alt.	427205C91	②◆◆9500HD
Belt - Alt. & Air Brake Compr.; W/37A., 61A. Alt.		②7541	Belt - P.S.		◆9465HD
Belt - Alt. & Air Brake Compr.; W/65A.,			Hose - Upper		26532
80A. Alt.	358344C91	②7560			
Belt - P.S.	358335C91	②◆◆9490HD	Caterpillar 1150 Diesel		
Hose - Upper		26531	1853		
Hose - Lower		≈<20530	Belt - Fan	426222C91	②◆◆9530HD
			Belt - Alt.; W/37A., 61A. Alt.	398601C91	②◆◆9440HD
International/Navistar VS478			Belt - Alt.; W/65A., 80A. Alt.	354029C91	②◆◆9476HD
193RE			Belt - Alt. & Air Brake Compr.; W/37A., 61A. Alt.		②◆◆9465HD
Belt - Fan	358319C91	②◆◆9570HD	Belt - Alt. & Air Brake Compr.; W/65A.,		
Belt - W.P.	359021C91	②TR22434	80A. Alt.	427205C91	②◆◆9500HD
Belt - Alt.; W/37A. Alt.	256346C11	②◆◆9350HD	Belt - P.S.		◆9465HD
Belt - Alt.; W/55A., 60A., 62A., 105A., 130A. Alt.		②◆◆9365HD	Hose - Upper		26532
Belt - Alt. & Air Brake Compr.	243605R11	②◆◆9451HD			
Belt - P.S.	164550R2	◆9425HD	Caterpillar 1160 Diesel		
Hose - Upper - Eng. To Pipe	24228		1853		
	or	26501	Belt - Fan	426222C91	②◆◆9530HD
Hose - Upper - Pipe To Rad.		24236	Belt - Alt.; W/37A., 61A. Alt.	398601C91	②◆◆9440HD
Hose - Lower		24942	Belt - Alt.; W/65A., 80A. Alt.	354029C91	②◆◆9476HD
Hose - By Pass		≈<20618	Belt - Alt. & Air Brake Compr.; W/37A., 61A. Alt.		②◆◆9465HD
	or	28442	Belt - Alt. & Air Brake Compr.; W/65A.,		
Hose - Heater		24216	80A. Alt.	427205C91	②◆◆9500HD
			Belt - P.S.		◆9465HD
			Hose - Upper		26532

②Two Required.
◆PowerBand Belt May Work, Use Template to Check.

◆Standard Belt Available.
≈<Cut to Fit.

Belts and Coolant Hose for School Buses

Application	Mfr. Part No.	Our No.	Application	Mfr. Part No.	Our No.
International/Navistar - Continued			International/Navistar - Continued		
1972 - Continued			1972 - Continued		
Caterpillar 1160 Diesel - Continued			International/Navistar RD372 - Continued		
1853 - Continued			1853FC - Continued		
Belt - Alt. & Air Brake Compr.; W/65A., 80A. Alt.	427205C91	②◆◆9500HD	Hose - Lower; Early FD Chassis; Chassis No. FA66376 ..		26508
Belt - P.S.		◆9465HD	Hose - Lower; Late FD Chassis; Chassis No. FA66376		24234
Hose - Upper		26532		or	26508
International/Navistar FTV549			International/Navistar RD406		
193RE			1823		
Belt - Fan	358319C91	②◆◆9570HD	Belt - Fan & Alt.	359014C91	②TR22514
Belt - W.P.	359021C91	②TR22434	Belt - W.P. & Alt.; W/37A. Alt.; Chassis No. FD61626 & Before	193826R11	②TR22508
Belt - Alt.; W/37A. Alt.	256346C11	②◆9350HD	Belt - W.P. & Alt.; W/37A. Alt.; Chassis No. FD61626 & Up & G Chassis No.	223794R11	②TR22514
Belt - Alt.; W/55A., 60A., 62A., 105A., 130A. Alt.		②◆9365HD	Belt - W.P. & Alt.; W/60A. Alt.	243604R11	②TR22517
Belt - Alt. & Air Brake Compr.	243605R11	②◆◆9451HD	Belt - P.S.	240354R2	TR22336
Belt - P.S.	164550R2	◆9425HD	Belt - Air Brake Compr.; W/Wagner Compr. .92836HA		TR32491
Hose - Upper - Eng. To Pipe		24228	Belt - Air Brake Compr.; W/Westinghouse Compr.	83816HA	TR34467
		26501	Hose - Upper		26515
Hose - Upper - Pipe To Rad.		24236	Hose - Lower		24232
Hose - Lower		24942	1853		
Hose - By Pass		②<20618	Belt - Alt.; W/55A., 62A., 145A. Alt.	223794K21	②TR22514
		28442	Belt - Gen.; W/37A. Gen.	193826R11	TR22508
Hose - Heater		24216	Belt - P.S.	240354R1	TR22344
1603; 1703 (School Bus); 1803			1853FC		
Hose - Upper		26531	Belt - Alt.; W/55A., 62A., 145A. Alt.	223794K21	②TR22514
Hose - Lower		②<20530	Belt - Gen.; W/37A. Gen.	193826R11	TR22508
International/Navistar FTVS549			International/Navistar RD450		
193RE			1823		
Belt - Fan	358319C91	②◆◆9570HD	Belt - Fan & Alt.	359014C91	②TR22514
Belt - W.P.	359021C91	②TR22434	Belt - W.P. & Alt.; W/37A. Alt.; Chassis No. FD61626 & Before	193826R11	②TR22508
Belt - Alt.; W/37A. Alt.	256346C11	②◆9350HD	Belt - W.P. & Alt.; W/37A. Alt.; Chassis No. FD61626 & Up & G Chassis No.	223794R11	②TR22514
Belt - Alt.; W/55A., 60A., 62A., 105A., 130A. Alt.		②◆9365HD	Belt - W.P. & Alt.; W/60A. Alt.	243604R11	②TR22517
Belt - Alt. & Air Brake Compr.	243605R11	②◆◆9451HD	Belt - P.S.	240354R2	TR22336
Belt - P.S.	164550R2	◆9425HD	Belt - Air Brake Compr.; W/Wagner Compr. .92836HA		TR32491
Hose - Upper - Eng. To Pipe		24228	Belt - Air Brake Compr.; W/Westinghouse Compr.	83816HA	TR34467
		26501	Hose - Upper		26515
Hose - Upper - Pipe To Rad.		24236	Hose - Lower		24232
Hose - Lower		24942	1853		
Hose - By Pass		②<20618	Belt - Alt.; W/55A., 62A., 145A. Alt.	223794K21	②TR22514
		28442	Belt - Gen.; W/37A. Gen.	193826R11	TR22508
Hose - Heater		24216	Belt - P.S.	240354R1	TR22344
1603; 1703 (School Bus); 1803			1853FC		
Hose - Upper		26531	Belt - Alt.; W/55A., 62A., 145A. Alt.	223794K21	②TR22514
Hose - Lower		②<20530	Belt - Gen.; W/37A. Gen.	193826R11	TR22508
International/Navistar RD372			International/Navistar RD501		
1823			1823		
Belt - Fan & Alt.	359014C91	②TR22514	Belt - Fan & Alt.	359014C91	②TR22514
Belt - W.P. & Alt.; W/37A. Alt.; Chassis No. FD61626 & Before	193826R11	②TR22508	Belt - W.P. & Alt.; W/37A. Alt.; Chassis No. FD61626 & Before	193826R11	②TR22508
Belt - W.P. & Alt.; W/37A. Alt.; Chassis No. FD61626 & Up & G Chassis No.	223794R11	②TR22514	Belt - W.P. & Alt.; W/37A. Alt.; Chassis No. FD61626 & Up & G Chassis No.	223794R11	②TR22514
Belt - W.P. & Alt.; W/60A. Alt.	243604R11	②TR22517	Belt - W.P. & Alt.; W/60A. Alt.	243604R11	②TR22517
Belt - P.S.	240354R2	TR22336	Belt - P.S.	240354R1	TR22344
Belt - Air Brake Compr.; W/Wagner Compr. .92836HA		TR32491	Hose - Upper; Late FD Chassis; Chassis No. FA66376		26509
Belt - Air Brake Compr.; W/Westinghouse Compr.	83816HA	TR34467	Hose - Lower; Early FD Chassis; Chassis No. FA66376 ..		26508
Hose - Upper		26515	Hose - Lower; Late FD Chassis; Chassis No. FA66376		24234
Hose - Lower		24232		or	26508
1853			International/Navistar RD501		
Belt - Alt.; W/55A., 62A., 145A. Alt.	223794K21	②TR22514	1823		
Belt - Gen.; W/37A. Gen.	193826R11	TR22508	Belt - Fan & Alt.		
Belt - P.S.	240354R1	TR22344	Belt - W.P. & Alt.; W/37A. Alt.; Chassis No. FD61626 & Before		
1853FC			Belt - W.P. & Alt.; W/37A. Alt.; Chassis No. FD61626 & Up & G Chassis No.		
Belt - Alt.; W/55A., 62A., 145A. Alt.	223794K21	②TR22514	Belt - W.P. & Alt.; W/60A. Alt.		
Belt - Gen.; W/37A. Gen.	193826R11	TR22508	Belt - P.S.		
Belt - P.S.	240354R1	TR22344	Belt - Air Brake Compr.; W/Wagner Compr. .92836HA		
Hose - Upper; Late FD Chassis; Chassis No. FA66376		26509	Belt - Air Brake Compr.; W/Westinghouse Compr.		
			83816HA		
			Hose - Upper		
			Hose - Lower		

◆Standard Belt Available.
②Two Required.

◆PowerBand Belt May Work, Use Template to Check.
②<Cut to Fit.

Belts and Coolant Hose for School Buses

Application	Mfr. Part No.	Our No.	Application	Mfr. Part No.	Our No.
International/Navistar - Continued			International/Navistar - Continued		
1972 - Continued			1972 - Continued		
International/Navistar RD501 - Continued			International/Navistar V345 - Continued		
1823 - Continued			1603; 1703 (School Bus) - Continued		
Belt - Air Brake Compr.; W/Wagner Compr. .92836HA		TR32491	Belt - Fan & Alt.; W/55A., 62A. Alt.; FD, SB		
Belt - Air Brake Compr.; W/Westinghouse			Chassis	361975C91	②7673
Compr. 83816HA		TR34467	Belt - Fan & Alt.; W/60A. Alt.	359009C91	②7680
Hose - Upper		26515	Belt - Fan & Alt.; W/65A., 80A., 105A.,		
Hose - Lower		24232	145A. Alt.; W/P.T.O.	361975C91	②7673
1853			Belt - Fan & Alt.; W/65A., 80A., 105A., 145A. Alt.; W/O		
Belt - Alt.; W/55A., 62A., 145A. Alt.	223794K21	②TR22514	P.T.O.		②7630
Belt - Gen.; W/37A. Gen.	193826R11	TR22508	Belt - P.S.; W/2WD		7460
Belt - P.S.	240354R1	TR22344	Belt - P.S.; W/4WD	285522C2	7435
1853FC			Belt - Air Brake Compr.	359007C91	7475
Belt - Alt.; W/55A., 62A., 145A. Alt.	223794K21	②TR22514	Belt - A.P.; W/Air Brakes; W/Gov.	388139C1	7330
Belt - Gen.; W/37A. Gen.	193826R11	TR22508	Belt - A.P.; W/Air Brakes; W/O Gov.	256062C2	7340
Belt - P.S.	240354R1	TR22344	Belt - A.P.; W/Hyd. Brakes; W/Gov.	355653C91	7380
Hose - Upper; Late FD Chassis; Chassis No. FA66376 ...		26509	Belt - A.P.; W/Hyd. Brakes; W/O Gov.	362887C91	7410
Hose - Lower; Early FD Chassis; Chassis No. FA66376 ...		26508	Hose - Upper; W/Rad. Shutters; W/Metal Hood		26515
Hose - Lower; Late FD Chassis; Chassis No. FA66376 ...		24234	Hose - Upper; W/O Rad. Shutters; W/Metal Hood		20493
or		26508	Hose - Lower - Eng. To Pipe; W/Auto. Trans.		20532
			Hose - Lower; W/Man. Trans.		21308
			Hose - By Pass		②20357
International/Navistar V266			1723		
1603; 1703 (School Bus); 1803			Belt - Fan & Alt.; W/37A., 52A., 61A. Alt.;		
Belt - Fan & Alt.; W/37A., 52A., 61A. Alt.; C, G, H			C, G, H Chassis; W/P.T.O.	968815R11	②7650
Chassis		②7603	Belt - Fan & Alt.; W/37A., 52A., 61A. Alt.;		
Belt - Fan & Alt.; W/37A., 52A., 61A. Alt.;			C, G, H Chassis; W/O P.T.O.	373457C91	②7612
FD, SB Chassis	255266C3	②7640	Belt - Fan & Alt.; W/37A., 52A., 61A. Alt.;		
Belt - Fan & Alt.; W/55A., 62A. Alt.; C, G, H			FD, SB Chassis	968815R1	②7650
Chassis	369725C91	②7619	Belt - Fan & Alt.; W/37A., 61A. Alt.; W/O		
Belt - Fan & Alt.; W/55A., 62A. Alt.; FD, SB			Air Brakes; W/O P.T.O.; W/O X.C.	373456C1	7612
Chassis	358998C91	②7650	Belt - Fan & Alt.; W/55A., 62A. Alt.; C, G, H		
Belt - P.S.; W/2WD	151529R2	7440	Chassis	369723C91	②7630
Belt - P.S.; W/4WD	151531R2	7450	Belt - Fan & Alt.; W/55A., 62A. Alt.; FD, SB		
Belt - Air Brake Compr.	236572R2	7460	Chassis	361975C91	②7673
Hose - Upper; W/Rad. Shutters; W/Metal Hood		26515	Belt - Fan & Alt.; W/60A. Alt.	359009C91	②7680
Hose - Upper; W/O Rad. Shutters; W/Metal Hood		20493	Belt - Fan & Alt.; W/65A., 80A., 105A.,		
Hose - Lower - Eng. To Pipe; W/Auto. Trans.		20532	145A. Alt.; W/P.T.O.	361975C91	②7673
Hose - Lower; W/Man. Trans.		21308	Belt - Fan & Alt.; W/65A., 80A., 105A., 145A. Alt.; W/O		
Hose - By Pass		②20357	P.T.O.		②7630
International/Navistar V304			Belt - P.S.; W/2WD		7460
1603; 1703 (School Bus); 1803			Belt - P.S.; W/4WD	285522C2	7435
Belt - Fan & Alt.; W/37A., 52A., 61A. Alt.; C, G, H			Belt - Air Brake Compr.	359007C91	7475
Chassis		②7603	Belt - A.P.; W/Air Brakes; W/Gov.	388139C1	7330
Belt - Fan & Alt.; W/37A., 52A., 61A. Alt.;			Belt - A.P.; W/Air Brakes; W/O Gov.	256062C2	7340
FD, SB Chassis	255266C3	②7640	Belt - A.P.; W/Hyd. Brakes; W/Gov.	355653C91	7380
Belt - Fan & Alt.; W/55A., 62A. Alt.; C, G, H			Belt - A.P.; W/Hyd. Brakes; W/O Gov.	362887C91	7410
Chassis	369725C91	②7619	1803		
Belt - Fan & Alt.; W/55A., 62A. Alt.; FD, SB			Belt - Fan & Alt.; W/37A., 52A., 61A. Alt.;		
Chassis	358998C91	②7650	C, G, H Chassis; W/P.T.O.	968815R11	②7650
Belt - P.S.; W/2WD	151529R2	7440	Belt - Fan & Alt.; W/37A., 52A., 61A. Alt.;		
Belt - P.S.; W/4WD	151531R2	7450	C, G, H Chassis; W/O P.T.O.	373457C91	②7612
Belt - Air Brake Compr.	236572R2	7460	Belt - Fan & Alt.; W/37A., 52A., 61A. Alt.;		
Hose - Upper; W/Rad. Shutters; W/Metal Hood		26515	FD, SB Chassis	968815R1	②7650
Hose - Upper; W/O Rad. Shutters; W/Metal Hood		20493	Belt - Fan & Alt.; W/37A., 61A. Alt.; W/O		
Hose - Lower - Eng. To Pipe; W/Auto. Trans.		20532	Air Brakes; W/O P.T.O.; W/O X.C.	373456C1	7612
Hose - Lower; W/Man. Trans.		21308	Belt - Fan & Alt.; W/55A., 62A. Alt.; C, G, H		
Hose - By Pass		②20357	Chassis	369723C91	②7630
International/Navistar V345			Belt - Fan & Alt.; W/55A., 62A. Alt.; FD, SB		
1603; 1703 (School Bus)			Chassis	361975C91	②7673
Belt - Fan & Alt.; W/37A., 52A., 61A. Alt.;			Belt - Fan & Alt.; W/60A. Alt.	359009C91	②7680
C, G, H Chassis; W/P.T.O.	968815R11	②7650	Belt - Fan & Alt.; W/65A., 80A., 105A.,		
Belt - Fan & Alt.; W/37A., 52A., 61A. Alt.;			145A. Alt.; W/P.T.O.	361975C91	②7673
C, G, H Chassis; W/O P.T.O.	373457C91	②7612	Belt - Fan & Alt.; W/65A., 80A., 105A., 145A. Alt.; W/O		
Belt - Fan & Alt.; W/37A., 52A., 61A. Alt.;			P.T.O.		②7630
FD, SB Chassis	968815R1	②7650	Belt - P.S.; W/2WD		7460
Belt - Fan & Alt.; W/37A., 61A. Alt.; W/O			Belt - P.S.; W/4WD	285522C2	7435
Air Brakes; W/O P.T.O.; W/O X.C.	373456C1	7612	Belt - Air Brake Compr.	359007C91	7475
Belt - Fan & Alt.; W/55A., 62A. Alt.; C, G, H			Belt - A.P.; W/Air Brakes; W/Gov.	388139C1	7330
Chassis	369723C91	②7630	Belt - A.P.; W/Air Brakes; W/O Gov.	256062C2	7340

②Two Required.

②Cut to Fit.

School Buses

Belts and Coolant Hose for School Buses

School Buses

Application	Mfr. Part No.	Our No.	Application	Mfr. Part No.	Our No.
International/Navistar - Continued			International/Navistar - Continued		
1972 - Continued			1972 - Continued		
International/Navistar V345 - Continued			International/Navistar V392 - Continued		
1803 - Continued			1723 - Continued		
Belt - A.P.; W/Hyd. Brakes; W/Gov.	355653C91	7380	Belt - Fan & Alt.; W/37A., 52A., 61A. Alt.; C, G, H Chassis; W/O P.T.O.	373457C91	②7612
Belt - A.P.; W/Hyd. Brakes; W/O Gov.	362887C91	7410	Belt - Fan & Alt.; W/37A., 52A., 61A. Alt.; FD, SB Chassis	968815R1	②7650
Hose - Upper; W/Rad. Shutters; W/Metal Hood		26515	Belt - Fan & Alt.; W/37A., 61A. Alt.; W/O Air Brakes; W/O P.T.O.; W/O X.C.	373456C1	7612
Hose - Upper; W/O Rad. Shutters; W/Metal Hood		20493	Belt - Fan & Alt.; W/55A., 62A. Alt.; C, G, H Chassis	369723C91	②7630
Hose - Lower - Eng. To Pipe; W/Auto. Trans.		20532	Belt - Fan & Alt.; W/55A., 62A. Alt.; FD, SB Chassis	361975C91	②7673
Hose - Lower; W/Man. Trans.		21308	Belt - Fan & Alt.; W/60A. Alt.	359009C91	②7680
Hose - By Pass		≈20357	Belt - Fan & Alt.; W/65A., 80A., 105A., 145A. Alt.; W/P.T.O.	361975C91	②7673
1823			Belt - Fan & Alt.; W/65A., 80A., 105A., 145A. Alt.; W/O P.T.O.		②7630
Belt - Fan & Alt.; W/37A., 52A., 61A. Alt.; C, G, H Chassis; W/P.T.O.	968815R11	②7650	Belt - P.S.; W/2WD		7460
Belt - Fan & Alt.; W/37A., 52A., 61A. Alt.; C, G, H Chassis; W/O P.T.O.	373457C91	②7612	Belt - P.S.; W/4WD	285522C2	7435
Belt - Fan & Alt.; W/37A., 52A., 61A. Alt.; FD, SB Chassis	968815R1	②7650	Belt - Air Brake Compr.	359007C91	7475
Belt - Fan & Alt.; W/37A., 61A. Alt.; W/O Air Brakes; W/O P.T.O.; W/O X.C.	373456C1	7612	Belt - A.P.; W/Air Brakes; W/Gov.	388139C1	7330
Belt - Fan & Alt.; W/55A., 62A. Alt.; C, G, H Chassis	369723C91	②7630	Belt - A.P.; W/Air Brakes; W/O Gov.	256062C2	7340
Belt - Fan & Alt.; W/55A., 62A. Alt.; FD, SB Chassis	361975C91	②7673	Belt - A.P.; W/Hyd. Brakes; W/Gov.	355653C91	7380
Belt - Fan & Alt.; W/60A. Alt.	359009C91	②7680	Belt - A.P.; W/Hyd. Brakes; W/O Gov.	362887C91	7410
Belt - Fan & Alt.; W/65A., 80A., 105A., 145A. Alt.; W/P.T.O.	361975C91	②7673	1803		
Belt - Fan & Alt.; W/65A., 80A., 105A., 145A. Alt.; W/O P.T.O.		②7630	Belt - Fan & Alt.; W/37A., 52A., 61A. Alt.; C, G, H Chassis; W/P.T.O.	968815R11	②7650
Belt - P.S.; W/2WD		7460	Belt - Fan & Alt.; W/37A., 52A., 61A. Alt.; C, G, H Chassis; W/O P.T.O.	373457C91	②7612
Belt - P.S.; W/4WD	285522C2	7435	Belt - Fan & Alt.; W/37A., 52A., 61A. Alt.; FD, SB Chassis	968815R1	②7650
Belt - Air Brake Compr.	359007C91	7475	Belt - Fan & Alt.; W/37A., 61A. Alt.; W/O Air Brakes; W/O P.T.O.; W/O X.C.	373456C1	7612
Belt - A.P.; W/Air Brakes; W/Gov.	388139C1	7330	Belt - Fan & Alt.; W/55A., 62A. Alt.; C, G, H Chassis	369723C91	②7630
Belt - A.P.; W/Air Brakes; W/O Gov.	256062C2	7340	Belt - Fan & Alt.; W/55A., 62A. Alt.; FD, SB Chassis	361975C91	②7673
Belt - A.P.; W/Hyd. Brakes; W/Gov.	355653C91	7380	Belt - Fan & Alt.; W/60A. Alt.	359009C91	②7680
Belt - A.P.; W/Hyd. Brakes; W/O Gov.	362887C91	7410	Belt - Fan & Alt.; W/65A., 80A., 105A., 145A. Alt.; W/P.T.O.	361975C91	②7673
International/Navistar V392			Belt - Fan & Alt.; W/65A., 80A., 105A., 145A. Alt.; W/O P.T.O.		②7630
1603; 1703 (School Bus)			Belt - P.S.; W/2WD		7460
Belt - Fan & Alt.; W/37A., 52A., 61A. Alt.; C, G, H Chassis; W/P.T.O.	968815R11	②7650	Belt - P.S.; W/4WD	285522C2	7435
Belt - Fan & Alt.; W/37A., 52A., 61A. Alt.; C, G, H Chassis; W/O P.T.O.	373457C91	②7612	Belt - Air Brake Compr.	359007C91	7475
Belt - Fan & Alt.; W/37A., 52A., 61A. Alt.; FD, SB Chassis	968815R1	②7650	Belt - A.P.; W/Air Brakes; W/Gov.	388139C1	7330
Belt - Fan & Alt.; W/37A., 61A. Alt.; W/O Air Brakes; W/O P.T.O.; W/O X.C.	373456C1	7612	Belt - A.P.; W/Air Brakes; W/O Gov.	256062C2	7340
Belt - Fan & Alt.; W/55A., 62A. Alt.; C, G, H Chassis	369723C91	②7630	Belt - A.P.; W/Hyd. Brakes; W/Gov.	355653C91	7380
Belt - Fan & Alt.; W/55A., 62A. Alt.; FD, SB Chassis	361975C91	②7673	Belt - A.P.; W/Hyd. Brakes; W/O Gov.	362887C91	7410
Belt - Fan & Alt.; W/60A. Alt.	359009C91	②7680	Hose - Upper; W/Rad. Shutters; W/Metal Hood		26515
Belt - Fan & Alt.; W/65A., 80A., 105A., 145A. Alt.; W/P.T.O.	361975C91	②7673	Hose - Upper; W/O Rad. Shutters; W/Metal Hood		20493
Belt - Fan & Alt.; W/65A., 80A., 105A., 145A. Alt.; W/O P.T.O.		②7630	Hose - Lower - Eng. To Pipe; W/Auto. Trans.		20532
Belt - P.S.; W/2WD		7460	Hose - Lower; W/Man. Trans.		21308
Belt - P.S.; W/4WD	285522C2	7435	Hose - By Pass		≈20357
Belt - Air Brake Compr.	359007C91	7475	1723		
Belt - A.P.; W/Air Brakes; W/Gov.	388139C1	7330	Belt - Fan & Alt.; W/37A., 52A., 61A. Alt.; C, G, H Chassis; W/P.T.O.	968815R11	②7650
Belt - A.P.; W/Air Brakes; W/O Gov.	256062C2	7340	Belt - Fan & Alt.; W/37A., 52A., 61A. Alt.; C, G, H Chassis; W/O P.T.O.	373457C91	②7612
Belt - A.P.; W/Hyd. Brakes; W/Gov.	355653C91	7380	Belt - Fan & Alt.; W/37A., 52A., 61A. Alt.; FD, SB Chassis	968815R1	②7650
Belt - A.P.; W/Hyd. Brakes; W/O Gov.	362887C91	7410	Belt - Fan & Alt.; W/37A., 61A. Alt.; W/O Air Brakes; W/O P.T.O.; W/O X.C.	373456C1	7612
Hose - Upper; W/Rad. Shutters; W/Metal Hood		26515	Belt - Fan & Alt.; W/55A., 62A. Alt.; C, G, H Chassis	369723C91	②7630
Hose - Upper; W/O Rad. Shutters; W/Metal Hood		20493	Belt - Fan & Alt.; W/55A., 62A. Alt.; FD, SB Chassis	361975C91	②7673
Hose - Lower - Eng. To Pipe; W/Auto. Trans.		20532	Belt - Fan & Alt.; W/60A. Alt.	359009C91	②7680
Hose - Lower; W/Man. Trans.		21308	Belt - Fan & Alt.; W/65A., 80A., 105A., 145A. Alt.; W/P.T.O.	361975C91	②7673
Hose - By Pass		≈20357			

≈Cut to Fit.

②Two Required.

Belts and Coolant Hose for School Buses

Application	Mfr. Part No.	Our No.	Application	Mfr. Part No.	Our No.
International/Navistar - Continued			International/Navistar - Continued		
1972 - Continued			1972 - Continued		
International/Navistar V392 - Continued			International/Navistar V549		
1823 - Continued			193RE		
Belt - Fan & Alt.; W/65A., 80A., 105A., 145A. Alt.; W/O P.T.O.		②7630	Belt - Fan	358319C91	②◆◆9570HD
Belt - P.S.; W/2WD		7460	Belt - W.P.	359021C91	②TR22434
Belt - P.S.; W/4WD	285522C2	7435	Belt - Alt.; W/37A. Alt.	256346C11	②◆9350HD
Belt - Air Brake Compr.	359007C91	7475	Belt - Alt.; W/55A., 60A., 62A., 105A., 130A. Alt.		②◆9365HD
Belt - A.P.; W/Air Brakes; W/Gov.	388139C1	7330	Belt - Alt. & Air Brake Compr.	243605R11	②◆◆9451HD
Belt - A.P.; W/Air Brakes; W/O Gov.	256062C2	7340	Belt - P.S.	164550R2	◆9425HD
Belt - A.P.; W/Hyd. Brakes; W/Gov.	355653C91	7380	Hose - Upper - Eng. To Pipe		24228
Belt - A.P.; W/Hyd. Brakes; W/O Gov.	362887C91	7410		or	26501
International/Navistar V401			Hose - Upper - Pipe To Rad.		24236
193RE			Hose - Lower		24942
Belt - Fan	358319C91	②◆◆9570HD	Hose - By Pass		≠20618
Belt - W.P.	359021C91	②TR22434		or	28442
Belt - Alt.; W/37A. Alt.	256346C11	②◆9350HD	Hose - Heater		24216
Belt - Alt.; W/55A., 60A., 62A., 105A., 130A. Alt.		②◆9365HD	1603; 1703 (School Bus); 1803		
Belt - Alt. & Air Brake Compr.	243605R11	②◆◆9451HD	Hose - Upper		26531
Belt - P.S.	164550R2	◆9425HD	Hose - Lower		≠20530
Hose - Upper - Eng. To Pipe		24228	International/Navistar VS401		
	or	26501	193RE		
Hose - Upper - Pipe To Rad.		24236	Belt - Fan	358319C91	②◆◆9570HD
Hose - Lower		24942	Belt - W.P.	359021C91	②TR22434
Hose - By Pass		≠20618	Belt - Alt.; W/37A. Alt.	256346C11	②◆9350HD
	or	28442	Belt - Alt.; W/55A., 60A., 62A., 105A., 130A. Alt.		②◆9365HD
Hose - Heater		24216	Belt - Alt. & Air Brake Compr.	243605R11	②◆◆9451HD
1603; 1703 (School Bus); 1803			Belt - P.S.	164550R2	◆9425HD
Hose - Upper		26531	Hose - Upper - Eng. To Pipe		24228
Hose - Lower		≠20530		or	26501
International/Navistar V461			Hose - Upper - Pipe To Rad.		24236
193RE			Hose - Lower		24942
Belt - Fan	358319C91	②◆◆9570HD	Hose - By Pass		≠20618
Belt - W.P.	359021C91	②TR22434		or	28442
Belt - Alt.; W/37A. Alt.	256346C11	②◆9350HD	Hose - Heater		24216
Belt - Alt.; W/55A., 60A., 62A., 105A., 130A. Alt.		②◆9365HD	1603; 1703 (School Bus); 1803		
Belt - Alt. & Air Brake Compr.	243605R11	②◆◆9451HD	Hose - Upper		26531
Belt - P.S.	164550R2	◆9425HD	Hose - Lower		≠20530
Hose - Upper - Eng. To Pipe		24228	International/Navistar VS478		
	or	26501	193RE		
Hose - Upper - Pipe To Rad.		24236	Belt - Fan	358319C91	②◆◆9570HD
Hose - Lower		24942	Belt - W.P.	359021C91	②TR22434
Hose - By Pass		≠20618	Belt - Alt.; W/37A. Alt.	256346C11	②◆9350HD
	or	28442	Belt - Alt.; W/55A., 60A., 62A., 105A., 130A. Alt.		②◆9365HD
Hose - Heater		24216	Belt - Alt. & Air Brake Compr.	243605R11	②◆◆9451HD
1603; 1703 (School Bus); 1803			Belt - P.S.	164550R2	◆9425HD
Hose - Upper		26531	Hose - Upper - Eng. To Pipe		24228
Hose - Lower		≠20530		or	26501
International/Navistar V478			Hose - Upper - Pipe To Rad.		24236
193RE			Hose - Lower		24942
Belt - Fan	358319C91	②◆◆9570HD	Hose - By Pass		≠20618
Belt - W.P.	359021C91	②TR22434		or	28442
Belt - Alt.; W/37A. Alt.	256346C11	②◆9350HD	Hose - Heater		24216
Belt - Alt.; W/55A., 60A., 62A., 105A., 130A. Alt.		②◆9365HD	1603; 1703 (School Bus); 1803		
Belt - Alt. & Air Brake Compr.	243605R11	②◆◆9451HD	Hose - Upper		26531
Belt - P.S.	164550R2	◆9425HD	Hose - Lower		≠20530
Hose - Upper - Eng. To Pipe		24228	International/Navistar VS549		
	or	26501	193RE		
Hose - Upper - Pipe To Rad.		24236	Belt - Fan	358319C91	②◆◆9570HD
Hose - Lower		24942	Belt - W.P.	359021C91	②TR22434
Hose - By Pass		≠20618	Belt - Alt.; W/37A. Alt.	256346C11	②◆9350HD
	or	28442	Belt - Alt.; W/55A., 60A., 62A., 105A., 130A. Alt.		②◆9365HD
Hose - Heater		24216	Belt - Alt. & Air Brake Compr.	243605R11	②◆◆9451HD
1603; 1703 (School Bus); 1803			Belt - P.S.	164550R2	◆9425HD
Hose - Upper		26531	Hose - Upper - Eng. To Pipe		24228
Hose - Lower		≠20530		or	26501

◆Standard Belt Available.
②Two Required.

◆PowerBand Belt May Work, Use Template to Check.
≠Cut to Fit.

School Buses

Belts and Coolant Hose for School Buses

School Buses

Application	Mfr. Part No.	Our No.	Application	Mfr. Part No.	Our No.
International/Navistar - Continued			International/Navistar - Continued		
1972 - Continued			1971 - Continued		
International/Navistar VS549 - Continued			International/Navistar RD372 - Continued		
193RE - Continued			1853FC - Continued		
Hose - Lower		24942	Hose - Lower; Late FD Chassis; Chassis No. FA66376		24234
Hose - By Pass		≈20618		or	26508
		28442	International/Navistar RD406		
Hose - Heater		24216	1823		
1603; 1703 (School Bus); 1803			Belt - Fan & Alt. 359014C91		
Hose - Upper		26531	Belt - W.P. & Alt.; W/37A. Alt.; Chassis No.		②TR22514
Hose - Lower		≈20530	FD61626 & Before	193826R11	②TR22508
1971			Belt - W.P. & Alt.; W/37A. Alt.; Chassis No.		
International/Navistar FTV549			FD61626 & Up & G Chassis No.	223794R11	②TR22514
193RE			Belt - W.P. & Alt.; W/60A. Alt.	243604R11	②TR22517
Belt - Fan	358319C91	②◆◆9570HD	Belt - P.S.	240354R2	TR22336
Belt - W.P.	359021C91	②TR22434	Belt - Air Brake Compr.; W/Wagner Compr. .	92836HA	TR32491
Belt - Alt.; W/37A. Alt.	256346C11	②◆9350HD	Belt - Air Brake Compr.; W/Westinghouse		
Belt - Alt.; W/55A., 60A., 62A., 105A., 130A. Alt.		②◆9365HD	Compr.	83816HA	TR34467
Belt - Alt. & Air Brake Compr.	243605R11	②◆◆9451HD	Hose - Upper		26515
Belt - P.S.	164550R2	◆9425HD	Hose - Lower		24232
Hose - Upper - Eng. To Pipe		24228	1853		
		26501	Belt - Alt.; W/55A., 62A., 145A. Alt.	223794K21	②TR22514
		24236	Belt - Gen.; W/37A. Gen.	193826R11	TR22508
Hose - Upper - Pipe To Rad.		24236	Belt - P.S.	240354R1	TR22344
Hose - Lower		24942	1853FC		
Hose - By Pass		≈20618	Belt - Alt.; W/55A., 62A., 145A. Alt.	223794K21	②TR22514
		28442	Belt - Gen.; W/37A. Gen.	193826R11	TR22508
		24216	Belt - P.S.	240354R1	TR22344
International/Navistar FTVS549			Hose - Upper; Late FD Chassis; Chassis No. FA66376		26509
193RE			Hose - Lower; Early FD Chassis; Chassis No. FA66376 ..		26508
Belt - Fan	358319C91	②◆◆9570HD	Hose - Lower; Late FD Chassis; Chassis No. FA66376		24234
Belt - W.P.	359021C91	②TR22434		or	26508
Belt - Alt.; W/37A. Alt.	256346C11	②◆9350HD	International/Navistar RD450		
Belt - Alt.; W/55A., 60A., 62A., 105A., 130A. Alt.		②◆9365HD	1823		
Belt - Alt. & Air Brake Compr.	243605R11	②◆◆9451HD	Belt - Fan & Alt. 359014C91		
Belt - P.S.	164550R2	◆9425HD	Belt - W.P. & Alt.; W/37A. Alt.; Chassis No.		
Hose - Upper - Eng. To Pipe		24228	FD61626 & Before		
		26501	193826R11		
		24236	②TR22508		
Hose - Upper - Pipe To Rad.		24236	Belt - W.P. & Alt.; W/37A. Alt.; Chassis No.		
Hose - Lower		24942	FD61626 & Up & G Chassis No.		
Hose - By Pass		≈20618	223794R11		
		28442	②TR22514		
		24216	Belt - W.P. & Alt.; W/60A. Alt.		
International/Navistar RD372			243604R11		
1823			②TR22517		
Belt - Fan & Alt.	359014C91	②TR22514	Belt - P.S.		
Belt - W.P. & Alt.; W/37A. Alt.; Chassis No.			240354R2		
FD61626 & Before	193826R11	②TR22508	TR22336		
Belt - W.P. & Alt.; W/37A. Alt.; Chassis No.			TR32491		
FD61626 & Up & G Chassis No.	223794R11	②TR22514	Belt - Air Brake Compr.; W/Wagner Compr. .		
Belt - W.P. & Alt.; W/60A. Alt.	243604R11	②TR22517	92836HA		
Belt - P.S.	240354R2	TR22336	Belt - Air Brake Compr.; W/Westinghouse		
Belt - Air Brake Compr.; W/Wagner Compr. .	92836HA	TR32491	Compr.		
Belt - Air Brake Compr.; W/Westinghouse			83816HA		
Compr.	83816HA	TR34467	Hose - Upper		
Hose - Upper		26515	Hose - Lower		
Hose - Lower		24232	24232		
1853			1853		
Belt - Alt.; W/55A., 62A., 145A. Alt.	223794K21	②TR22514	Belt - Alt.; W/55A., 62A., 145A. Alt.	223794K21	②TR22514
Belt - Gen.; W/37A. Gen.	193826R11	TR22508	Belt - Gen.; W/37A. Gen.	193826R11	TR22508
Belt - P.S.	240354R1	TR22344	Belt - P.S.	240354R1	TR22344
1853FC			1853FC		
Belt - Alt.; W/55A., 62A., 145A. Alt.	223794K21	②TR22514	Belt - Alt.; W/55A., 62A., 145A. Alt.	223794K21	②TR22514
Belt - Gen.; W/37A. Gen.	193826R11	TR22508	Belt - Gen.; W/37A. Gen.	193826R11	TR22508
Belt - P.S.	240354R1	TR22344	Belt - P.S.	240354R1	TR22344
Hose - Upper; Late FD Chassis; Chassis No. FA66376		26509	Hose - Upper; Late FD Chassis; Chassis No. FA66376		26509
Hose - Lower; Early FD Chassis; Chassis No. FA66376 ..		26508	Hose - Lower; Early FD Chassis; Chassis No. FA66376 ..		26508
Hose - Lower; Late FD Chassis; Chassis No. FA66376		24234	Hose - Lower; Late FD Chassis; Chassis No. FA66376		24234
		26508		or	26508
International/Navistar RD501			International/Navistar RD501		
1823			1823		
Belt - Fan & Alt. 359014C91			Belt - Fan & Alt. 359014C91		
②TR22514			②TR22514		
Belt - W.P. & Alt.; W/37A. Alt.; Chassis No.			Belt - W.P. & Alt.; W/37A. Alt.; Chassis No.		
FD61626 & Before			FD61626 & Before		
193826R11			193826R11		
②TR22508			②TR22508		
Belt - W.P. & Alt.; W/37A. Alt.; Chassis No.			Belt - W.P. & Alt.; W/37A. Alt.; Chassis No.		
FD61626 & Up & G Chassis No.			FD61626 & Up & G Chassis No.		
223794R11			223794R11		
②TR22514			②TR22514		
Belt - W.P. & Alt.; W/60A. Alt.			Belt - W.P. & Alt.; W/60A. Alt.		
243604R11			243604R11		
②TR22517			②TR22517		
Belt - P.S.			Belt - P.S.		
240354R2			240354R2		
TR22336			TR22336		
TR32491			TR32491		
Belt - Air Brake Compr.; W/Wagner Compr. .			Belt - Air Brake Compr.; W/Wagner Compr. .		
92836HA			92836HA		
Belt - Air Brake Compr.; W/Westinghouse			Belt - Air Brake Compr.; W/Westinghouse		
Compr.			Compr.		
83816HA			83816HA		
Hose - Upper			Hose - Upper		
26515			26515		
Hose - Lower			Hose - Lower		
24232			24232		

≈Cut to Fit.

◆PowerBand Belt May Work, Use Template to Check.

◆Standard Belt Available.

②Two Required.

Belts and Coolant Hose for School Buses

Application	Mfr. Part No.	Our No.	Application	Mfr. Part No.	Our No.
International/Navistar - Continued			International/Navistar - Continued		
1971 - Continued			1971 - Continued		
International/Navistar RD501 - Continued			International/Navistar V345 - Continued		
1823 - Continued			1603; 1703 (School Bus) - Continued		
Belt - Air Brake Compr.; W/Westinghouse Compr.	83816HA	TR34467	Belt - Fan & Alt.; W/55A., 62A. Alt.; FD, SB Chassis	361975C91	②7673
Hose - Upper		26515	Belt - Fan & Alt.; W/60A. Alt.	359009C91	②7680
Hose - Lower		24232	Belt - Fan & Alt.; W/65A., 80A., 105A., 145A. Alt.; W/P.T.O.	361975C91	②7673
1853			Belt - Fan & Alt.; W/65A., 80A., 105A., 145A. Alt.; W/O P.T.O.		②7630
Belt - Alt.; W/55A., 62A., 145A. Alt.	223794K21	②TR22514	Belt - P.S.; W/2WD		7460
Belt - Gen.; W/37A. Gen.	193826R11	TR22508	Belt - P.S.; W/4WD	285522C2	7435
Belt - P.S.	240354R1	TR22344	Belt - Air Brake Compr.	359007C91	7475
1853FC			Belt - A.P.; W/Air Brakes; W/Gov.	388139C1	7330
Belt - Alt.; W/55A., 62A., 145A. Alt.	223794K21	②TR22514	Belt - A.P.; W/Air Brakes; W/O Gov.	256062C2	7340
Belt - Gen.; W/37A. Gen.	193826R11	TR22508	Belt - A.P.; W/Hyd. Brakes; W/Gov.	355653C91	7380
Belt - P.S.	240354R1	TR22344	Belt - A.P.; W/Hyd. Brakes; W/O Gov.	362887C91	7410
Hose - Upper; Late FD Chassis; Chassis No. FA66376 ...		26509	Hose - Upper; W/Rad. Shutters; W/Metal Hood		26515
Hose - Lower; Early FD Chassis; Chassis No. FA66376 ..		26508	Hose - Upper; W/O Rad. Shutters; W/Metal Hood		20493
Hose - Lower; Late FD Chassis; Chassis No. FA66376 ...		24234	Hose - Lower - Eng. To Pipe; W/Auto. Trans.		20532
or		26508	Hose - Lower; W/Man. Trans.		21308
			Hose - By Pass		②20357
International/Navistar V266			1723		
1603; 1703 (School Bus); 1803			Belt - Fan & Alt.; W/37A., 52A., 61A. Alt.; C, G, H Chassis; W/P.T.O.		
Belt - Fan & Alt.; W/37A., 52A., 61A. Alt.; C, G, H Chassis		②7603	Belt - Fan & Alt.; W/37A., 52A., 61A. Alt.; C, G, H Chassis; W/O P.T.O.	373457C91	②7612
Belt - Fan & Alt.; W/37A., 52A., 61A. Alt.; FD, SB Chassis	255266C3	②7640	Belt - Fan & Alt.; W/37A., 52A., 61A. Alt.; FD, SB Chassis	968815R1	②7650
Belt - Fan & Alt.; W/55A., 62A. Alt.; C, G, H Chassis	369725C91	②7619	Belt - Fan & Alt.; W/37A., 61A. Alt.; W/O Air Brakes; W/O P.T.O.; W/O X.C.	373456C1	7612
Belt - Fan & Alt.; W/55A., 62A. Alt.; FD, SB Chassis	358998C91	②7650	Belt - Fan & Alt.; W/55A., 62A. Alt.; C, G, H Chassis	369723C91	②7630
Belt - P.S.; W/2WD	151529R2	7440	Belt - Fan & Alt.; W/55A., 62A. Alt.; FD, SB Chassis	361975C91	②7673
Belt - P.S.; W/4WD	151531R2	7450	Belt - Fan & Alt.; W/60A. Alt.	359009C91	②7680
Belt - Air Brake Compr.	236572R2	7460	Belt - Fan & Alt.; W/65A., 80A., 105A., 145A. Alt.; W/P.T.O.	361975C91	②7673
Hose - Upper; W/Rad. Shutters; W/Metal Hood		26515	Belt - Fan & Alt.; W/65A., 80A., 105A., 145A. Alt.; W/O P.T.O.		②7630
Hose - Upper; W/O Rad. Shutters; W/Metal Hood		20493	Belt - P.S.; W/2WD		7460
Hose - Lower - Eng. To Pipe; W/Auto. Trans.		20532	Belt - P.S.; W/4WD	285522C2	7435
Hose - Lower; W/Man. Trans.		21308	Belt - Air Brake Compr.	359007C91	7475
Hose - By Pass		②20357	Belt - A.P.; W/Air Brakes; W/Gov.	388139C1	7330
International/Navistar V304			Belt - A.P.; W/Air Brakes; W/O Gov.	256062C2	7340
1603; 1703 (School Bus); 1803			Belt - A.P.; W/Hyd. Brakes; W/Gov.	355653C91	7380
Belt - Fan & Alt.; W/37A., 52A., 61A. Alt.; C, G, H Chassis		②7603	Belt - A.P.; W/Hyd. Brakes; W/O Gov.	362887C91	7410
Belt - Fan & Alt.; W/37A., 52A., 61A. Alt.; FD, SB Chassis	255266C3	②7640	1803		
Belt - Fan & Alt.; W/55A., 62A. Alt.; C, G, H Chassis	369725C91	②7619	Belt - Fan & Alt.; W/37A., 52A., 61A. Alt.; C, G, H Chassis; W/P.T.O.	968815R11	②7650
Belt - Fan & Alt.; W/55A., 62A. Alt.; FD, SB Chassis	358998C91	②7650	Belt - Fan & Alt.; W/37A., 52A., 61A. Alt.; C, G, H Chassis; W/O P.T.O.	373457C91	②7612
Belt - P.S.; W/2WD	151529R2	7440	Belt - Fan & Alt.; W/37A., 52A., 61A. Alt.; FD, SB Chassis	968815R1	②7650
Belt - P.S.; W/4WD	151531R2	7450	Belt - Fan & Alt.; W/37A., 61A. Alt.; W/O Air Brakes; W/O P.T.O.; W/O X.C.	373456C1	7612
Belt - Air Brake Compr.	236572R2	7460	Belt - Fan & Alt.; W/55A., 62A. Alt.; C, G, H Chassis	369723C91	②7630
Hose - Upper; W/Rad. Shutters; W/Metal Hood		26515	Belt - Fan & Alt.; W/55A., 62A. Alt.; FD, SB Chassis	361975C91	②7673
Hose - Upper; W/O Rad. Shutters; W/Metal Hood		20493	Belt - Fan & Alt.; W/60A. Alt.	359009C91	②7680
Hose - Lower - Eng. To Pipe; W/Auto. Trans.		20532	Belt - Fan & Alt.; W/65A., 80A., 105A., 145A. Alt.; W/P.T.O.	361975C91	②7673
Hose - Lower; W/Man. Trans.		21308	Belt - Fan & Alt.; W/65A., 80A., 105A., 145A. Alt.; W/O P.T.O.		②7630
Hose - By Pass		②20357	Belt - P.S.; W/2WD		7460
International/Navistar V345			Belt - P.S.; W/4WD	285522C2	7435
1603; 1703 (School Bus)			Belt - Air Brake Compr.	359007C91	7475
Belt - Fan & Alt.; W/37A., 52A., 61A. Alt.; C, G, H Chassis; W/P.T.O.	968815R11	②7650	Belt - A.P.; W/Air Brakes; W/Gov.	388139C1	7330
Belt - Fan & Alt.; W/37A., 52A., 61A. Alt.; C, G, H Chassis; W/O P.T.O.	373457C91	②7612	Belt - A.P.; W/Air Brakes; W/O Gov.	256062C2	7340
Belt - Fan & Alt.; W/37A., 52A., 61A. Alt.; FD, SB Chassis	968815R1	②7650	Belt - A.P.; W/Hyd. Brakes; W/Gov.	355653C91	7380
Belt - Fan & Alt.; W/37A., 61A. Alt.; W/O Air Brakes; W/O P.T.O.; W/O X.C.	373456C1	7612	Belt - A.P.; W/Hyd. Brakes; W/O Gov.	362887C91	7410
Belt - Fan & Alt.; W/55A., 62A. Alt.; C, G, H Chassis	369723C91	②7630	1803		
			Belt - Fan & Alt.; W/37A., 52A., 61A. Alt.; C, G, H Chassis; W/P.T.O.	968815R11	②7650
International/Navistar V345			Belt - Fan & Alt.; W/37A., 52A., 61A. Alt.; C, G, H Chassis; W/O P.T.O.	373457C91	②7612
1603; 1703 (School Bus)			Belt - Fan & Alt.; W/37A., 52A., 61A. Alt.; FD, SB Chassis	968815R1	②7650
Belt - Fan & Alt.; W/37A., 52A., 61A. Alt.; C, G, H Chassis; W/P.T.O.	968815R11	②7650	Belt - Fan & Alt.; W/37A., 61A. Alt.; W/O Air Brakes; W/O P.T.O.; W/O X.C.	373456C1	7612
Belt - Fan & Alt.; W/37A., 52A., 61A. Alt.; C, G, H Chassis; W/O P.T.O.	373457C91	②7612	Belt - Fan & Alt.; W/55A., 62A. Alt.; C, G, H Chassis	369723C91	②7630
Belt - Fan & Alt.; W/37A., 52A., 61A. Alt.; FD, SB Chassis	968815R1	②7650	Belt - Fan & Alt.; W/55A., 62A. Alt.; FD, SB Chassis	361975C91	②7673
Belt - Fan & Alt.; W/37A., 61A. Alt.; W/O Air Brakes; W/O P.T.O.; W/O X.C.	373456C1	7612	Belt - Fan & Alt.; W/60A. Alt.	359009C91	②7680
Belt - Fan & Alt.; W/55A., 62A. Alt.; C, G, H Chassis	369723C91	②7630	Belt - Fan & Alt.; W/65A., 80A., 105A., 145A. Alt.; W/P.T.O.	361975C91	②7673
			Belt - Fan & Alt.; W/65A., 80A., 105A., 145A. Alt.; W/O P.T.O.		②7630
International/Navistar V345			Belt - P.S.; W/2WD		7460
1603; 1703 (School Bus)			Belt - P.S.; W/4WD	285522C2	7435
Belt - Fan & Alt.; W/37A., 52A., 61A. Alt.; C, G, H Chassis; W/P.T.O.	968815R11	②7650	Belt - Air Brake Compr.	359007C91	7475
Belt - Fan & Alt.; W/37A., 52A., 61A. Alt.; C, G, H Chassis; W/O P.T.O.	373457C91	②7612	Belt - A.P.; W/Air Brakes; W/Gov.	388139C1	7330
Belt - Fan & Alt.; W/37A., 52A., 61A. Alt.; FD, SB Chassis	968815R1	②7650	Belt - A.P.; W/Air Brakes; W/O Gov.	256062C2	7340
Belt - Fan & Alt.; W/37A., 61A. Alt.; W/O Air Brakes; W/O P.T.O.; W/O X.C.	373456C1	7612	Belt - A.P.; W/Hyd. Brakes; W/Gov.	355653C91	7380
Belt - Fan & Alt.; W/55A., 62A. Alt.; C, G, H Chassis	369723C91	②7630	Belt - A.P.; W/Hyd. Brakes; W/O Gov.	362887C91	7410
			1803		
International/Navistar V345			Belt - Fan & Alt.; W/37A., 52A., 61A. Alt.; C, G, H Chassis; W/P.T.O.	968815R11	②7650
1603; 1703 (School Bus)			Belt - Fan & Alt.; W/37A., 52A., 61A. Alt.; C, G, H Chassis; W/O P.T.O.	373457C91	②7612
Belt - Fan & Alt.; W/37A., 52A., 61A. Alt.; C, G, H Chassis; W/P.T.O.	968815R11	②7650	Belt - Fan & Alt.; W/37A., 52A., 61A. Alt.; FD, SB Chassis	968815R1	②7650
Belt - Fan & Alt.; W/37A., 52A., 61A. Alt.; C, G, H Chassis; W/O P.T.O.	373457C91	②7612	Belt - Fan & Alt.; W/37A., 61A. Alt.; W/O Air Brakes; W/O P.T.O.; W/O X.C.	373456C1	7612
Belt - Fan & Alt.; W/37A., 52A., 61A. Alt.; FD, SB Chassis	968815R1	②7650	Belt - Fan & Alt.; W/55A., 62A. Alt.; C, G, H Chassis	369723C91	②7630
Belt - Fan & Alt.; W/37A., 61A. Alt.; W/O Air Brakes; W/O P.T.O.; W/O X.C.	373456C1	7612	Belt - Fan & Alt.; W/55A., 62A. Alt.; FD, SB Chassis	361975C91	②7673
Belt - Fan & Alt.; W/55A., 62A. Alt.; C, G, H Chassis	369723C91	②7630	Belt - Fan & Alt.; W/60A. Alt.	359009C91	②7680
			Belt - Fan & Alt.; W/65A., 80A., 105A., 145A. Alt.; W/P.T.O.	361975C91	②7673
International/Navistar V345			Belt - Fan & Alt.; W/65A., 80A., 105A., 145A. Alt.; W/O P.T.O.		②7630
1603; 1703 (School Bus)			Belt - P.S.; W/2WD		7460
Belt - Fan & Alt.; W/37A., 52A., 61A. Alt.; C, G, H Chassis; W/P.T.O.	968815R11	②7650	Belt - P.S.; W/4WD	285522C2	7435
Belt - Fan & Alt.; W/37A., 52A., 61A. Alt.; C, G, H Chassis; W/O P.T.O.	373457C91	②7612	Belt - Air Brake Compr.	359007C91	7475
Belt - Fan & Alt.; W/37A., 52A., 61A. Alt.; FD, SB Chassis	968815R1	②7650	Belt - A.P.; W/Air Brakes; W/Gov.	388139C1	7330
Belt - Fan & Alt.; W/37A., 61A. Alt.; W/O Air Brakes; W/O P.T.O.; W/O X.C.	373456C1	7612	Belt - A.P.; W/Air Brakes; W/O Gov.	256062C2	7340
Belt - Fan & Alt.; W/55A., 62A. Alt.; C, G, H Chassis	369723C91	②7630	1803		
			Belt - Fan & Alt.; W/37A., 52A., 61A. Alt.; C, G, H Chassis; W/P.T.O.	968815R11	②7650

School Buses

②Two Required.

③Cut to Fit.

Belts and Coolant Hose for School Buses

Application	Mfr. Part No.	Our No.	Application	Mfr. Part No.	Our No.
International/Navistar - Continued			International/Navistar - Continued		
1971 - Continued			1971 - Continued		
International/Navistar V345 - Continued			International/Navistar V392 - Continued		
1803 - Continued			1723 - Continued		
Belt - A.P.; W/Hyd. Brakes; W/Gov.	355653C91	7380	Belt - Fan & Alt.; W/37A., 52A., 61A. Alt.; C, G, H Chassis; W/O P.T.O.	373457C91	②7612
Belt - A.P.; W/Hyd. Brakes; W/O Gov.	362887C91	7410	Belt - Fan & Alt.; W/37A., 52A., 61A. Alt.; FD, SB Chassis	968815R1	②7650
Hose - Upper; W/Rad. Shutters; W/Metal Hood		26515	Belt - Fan & Alt.; W/37A., 61A. Alt.; W/O Air Brakes; W/O P.T.O.; W/O X.C.	373456C1	7612
Hose - Upper; W/O Rad. Shutters; W/Metal Hood		20493	Belt - Fan & Alt.; W/55A., 62A. Alt.; C, G, H Chassis	369723C91	②7630
Hose - Lower - Eng. To Pipe; W/Auto. Trans.		20532	Belt - Fan & Alt.; W/55A., 62A. Alt.; FD, SB Chassis	361975C91	②7673
Hose - Lower; W/Man. Trans.		21308	Belt - Fan & Alt.; W/60A. Alt.	359009C91	②7680
Hose - By Pass		≈20357	Belt - Fan & Alt.; W/65A., 80A., 105A., 145A. Alt.; W/P.T.O.	361975C91	②7673
1823			Belt - Fan & Alt.; W/65A., 80A., 105A., 145A. Alt.; W/O P.T.O.		②7630
Belt - Fan & Alt.; W/37A., 52A., 61A. Alt.; C, G, H Chassis; W/P.T.O.	968815R11	②7650	Belt - P.S.; W/2WD		7460
Belt - Fan & Alt.; W/37A., 52A., 61A. Alt.; C, G, H Chassis; W/O P.T.O.	373457C91	②7612	Belt - P.S.; W/4WD	285522C2	7435
Belt - Fan & Alt.; W/37A., 52A., 61A. Alt.; FD, SB Chassis	968815R1	②7650	Belt - Air Brake Compr.	359007C91	7475
Belt - Fan & Alt.; W/37A., 61A. Alt.; W/O Air Brakes; W/O P.T.O.; W/O X.C.	373456C1	7612	Belt - A.P.; W/Air Brakes; W/Gov.	388139C1	7330
Belt - Fan & Alt.; W/55A., 62A. Alt.; C, G, H Chassis	369723C91	②7630	Belt - A.P.; W/Air Brakes; W/O Gov.	256062C2	7340
Belt - Fan & Alt.; W/55A., 62A. Alt.; FD, SB Chassis	361975C91	②7673	Belt - A.P.; W/Hyd. Brakes; W/Gov.	355653C91	7380
Belt - Fan & Alt.; W/60A. Alt.	359009C91	②7680	Belt - A.P.; W/Hyd. Brakes; W/O Gov.	362887C91	7410
Belt - Fan & Alt.; W/65A., 80A., 105A., 145A. Alt.; W/P.T.O.	361975C91	②7673	1803		
Belt - Fan & Alt.; W/65A., 80A., 105A., 145A. Alt.; W/O P.T.O.		②7630	Belt - Fan & Alt.; W/37A., 52A., 61A. Alt.; C, G, H Chassis; W/P.T.O.	968815R11	②7650
Belt - P.S.; W/2WD		7460	Belt - Fan & Alt.; W/37A., 52A., 61A. Alt.; C, G, H Chassis; W/O P.T.O.	373457C91	②7612
Belt - P.S.; W/4WD	285522C2	7435	Belt - Fan & Alt.; W/37A., 52A., 61A. Alt.; FD, SB Chassis	968815R1	②7650
Belt - Air Brake Compr.	359007C91	7475	Belt - Fan & Alt.; W/37A., 61A. Alt.; W/O Air Brakes; W/O P.T.O.; W/O X.C.	373456C1	7612
Belt - A.P.; W/Air Brakes; W/Gov.	388139C1	7330	Belt - Fan & Alt.; W/55A., 62A. Alt.; C, G, H Chassis	369723C91	②7630
Belt - A.P.; W/Air Brakes; W/O Gov.	256062C2	7340	Belt - Fan & Alt.; W/55A., 62A. Alt.; FD, SB Chassis	361975C91	②7673
Belt - A.P.; W/Hyd. Brakes; W/Gov.	355653C91	7380	Belt - Fan & Alt.; W/60A. Alt.	359009C91	②7680
Belt - A.P.; W/Hyd. Brakes; W/O Gov.	362887C91	7410	Belt - Fan & Alt.; W/65A., 80A., 105A., 145A. Alt.; W/P.T.O.	361975C91	②7673
International/Navistar V392			Belt - Fan & Alt.; W/65A., 80A., 105A., 145A. Alt.; W/O P.T.O.		②7630
1603; 1703 (School Bus)			Belt - P.S.; W/2WD		7460
Belt - Fan & Alt.; W/37A., 52A., 61A. Alt.; C, G, H Chassis; W/P.T.O.	968815R11	②7650	Belt - P.S.; W/4WD	285522C2	7435
Belt - Fan & Alt.; W/37A., 52A., 61A. Alt.; C, G, H Chassis; W/O P.T.O.	373457C91	②7612	Belt - Air Brake Compr.	359007C91	7475
Belt - Fan & Alt.; W/37A., 52A., 61A. Alt.; FD, SB Chassis	968815R1	②7650	Belt - A.P.; W/Air Brakes; W/Gov.	388139C1	7330
Belt - Fan & Alt.; W/37A., 61A. Alt.; W/O Air Brakes; W/O P.T.O.; W/O X.C.	373456C1	7612	Belt - A.P.; W/Air Brakes; W/O Gov.	256062C2	7340
Belt - Fan & Alt.; W/55A., 62A. Alt.; C, G, H Chassis	369723C91	②7630	Belt - A.P.; W/Hyd. Brakes; W/Gov.	355653C91	7380
Belt - Fan & Alt.; W/55A., 62A. Alt.; FD, SB Chassis	361975C91	②7673	Belt - A.P.; W/Hyd. Brakes; W/O Gov.	362887C91	7410
Belt - Fan & Alt.; W/60A. Alt.	359009C91	②7680	Hose - Upper; W/Rad. Shutters; W/Metal Hood		26515
Belt - Fan & Alt.; W/65A., 80A., 105A., 145A. Alt.; W/P.T.O.	361975C91	②7673	Hose - Upper; W/O Rad. Shutters; W/Metal Hood		20493
Belt - Fan & Alt.; W/65A., 80A., 105A., 145A. Alt.; W/O P.T.O.		②7630	Hose - Lower - Eng. To Pipe; W/Auto. Trans.		20532
Belt - P.S.; W/2WD		7460	Hose - Lower; W/Man. Trans.		21308
Belt - P.S.; W/4WD	285522C2	7435	Hose - By Pass		≈20357
Belt - Air Brake Compr.	359007C91	7475	1723		
Belt - A.P.; W/Air Brakes; W/Gov.	388139C1	7330	Belt - Fan & Alt.; W/37A., 52A., 61A. Alt.; C, G, H Chassis; W/P.T.O.	968815R11	②7650
Belt - A.P.; W/Air Brakes; W/O Gov.	256062C2	7340	Belt - Fan & Alt.; W/37A., 52A., 61A. Alt.; C, G, H Chassis; W/O P.T.O.	373457C91	②7612
Belt - A.P.; W/Hyd. Brakes; W/Gov.	355653C91	7380	Belt - Fan & Alt.; W/37A., 52A., 61A. Alt.; FD, SB Chassis	968815R1	②7650
Belt - A.P.; W/Hyd. Brakes; W/O Gov.	362887C91	7410	Belt - Fan & Alt.; W/37A., 61A. Alt.; W/O Air Brakes; W/O P.T.O.; W/O X.C.	373456C1	7612
Hose - Upper; W/Rad. Shutters; W/Metal Hood		26515	Belt - Fan & Alt.; W/55A., 62A. Alt.; C, G, H Chassis	369723C91	②7630
Hose - Upper; W/O Rad. Shutters; W/Metal Hood		20493	Belt - Fan & Alt.; W/55A., 62A. Alt.; FD, SB Chassis	361975C91	②7673
Hose - Lower - Eng. To Pipe; W/Auto. Trans.		20532	Belt - Fan & Alt.; W/60A. Alt.	359009C91	②7680
Hose - Lower; W/Man. Trans.		21308	Belt - Fan & Alt.; W/65A., 80A., 105A., 145A. Alt.; W/P.T.O.	361975C91	②7673
Hose - By Pass		≈20357			

≈Cut to Fit.

②Two Required.

Belts and Coolant Hose for School Buses

Application	Mfr. Part No.	Our No.	Application	Mfr. Part No.	Our No.
International/Navistar - Continued			International/Navistar - Continued		
1971 - Continued			1971 - Continued		
International/Navistar V392 - Continued			International/Navistar V549 - Continued		
1823 - Continued			193RE - Continued		
Belt - Fan & Alt.; W/65A., 80A., 105A., 145A. Alt.; W/O P.T.O.		②7630	Hose - Upper - Eng. To Pipe		24228
Belt - P.S.; W/2WD		7460	or		26501
Belt - P.S.; W/4WD	285522C2	7435	Hose - Upper - Pipe To Rad.		24236
Belt - Air Brake Compr.	359007C91	7475	Hose - Lower		24942
Belt - A.P.; W/Air Brakes; W/Gov.	388139C1	7330	Hose - By Pass	≈<	20618
Belt - A.P.; W/Air Brakes; W/O Gov.	256062C2	7340	or		28442
Belt - A.P.; W/Hyd. Brakes; W/Gov.	355653C91	7380	Hose - Heater		24216
Belt - A.P.; W/Hyd. Brakes; W/O Gov.	362887C91	7410	International/Navistar VS401		
International/Navistar V401			193RE		
193RE			Belt - Fan	358319C91	②♠◆9570HD
Belt - Fan	358319C91	②♠◆9570HD	Belt - W.P.	359021C91	②TR22434
Belt - W.P.	359021C91	②TR22434	Belt - Alt.; W/37A. Alt.	256346C11	②♠9350HD
Belt - Alt.; W/37A. Alt.	256346C11	②♠9350HD	Belt - Alt.; W/55A., 60A., 62A., 105A., 130A. Alt.		②♠9365HD
Belt - Alt.; W/55A., 60A., 62A., 105A., 130A. Alt.		②♠9365HD	Belt - Alt. & Air Brake Compr.	243605R11	②♠◆9451HD
Belt - Alt. & Air Brake Compr.	243605R11	②♠◆9451HD	Belt - P.S.	164550R2	♠9425HD
Belt - P.S.	164550R2	♠9425HD	Hose - Upper - Eng. To Pipe		24228
Hose - Upper - Eng. To Pipe		24228	or		26501
or		26501	Hose - Upper - Pipe To Rad.		24236
Hose - Upper - Pipe To Rad.		24236	Hose - Lower		24942
Hose - Lower		24942	Hose - By Pass	≈<	20618
Hose - By Pass	≈<	20618	or		28442
or		28442	Hose - Heater		24216
Hose - Heater		24216	International/Navistar VS478		
International/Navistar V461			193RE		
193RE			Belt - Fan	358319C91	②♠◆9570HD
Belt - Fan	358319C91	②♠◆9570HD	Belt - W.P.	359021C91	②TR22434
Belt - W.P.	359021C91	②TR22434	Belt - Alt.; W/37A. Alt.	256346C11	②♠9350HD
Belt - Alt.; W/37A. Alt.	256346C11	②♠9350HD	Belt - Alt.; W/55A., 60A., 62A., 105A., 130A. Alt.		②♠9365HD
Belt - Alt.; W/55A., 60A., 62A., 105A., 130A. Alt.		②♠9365HD	Belt - Alt. & Air Brake Compr.	243605R11	②♠◆9451HD
Belt - Alt. & Air Brake Compr.	243605R11	②♠◆9451HD	Belt - P.S.	164550R2	♠9425HD
Belt - P.S.	164550R2	♠9425HD	Hose - Upper - Eng. To Pipe		24228
Hose - Upper - Eng. To Pipe		24228	or		26501
or		26501	Hose - Upper - Pipe To Rad.		24236
Hose - Upper - Pipe To Rad.		24236	Hose - Lower		24942
Hose - Lower		24942	Hose - By Pass	≈<	20618
Hose - By Pass	≈<	20618	or		28442
or		28442	Hose - Heater		24216
Hose - Heater		24216	International/Navistar VS549		
International/Navistar V478			193RE		
193RE			Belt - Fan	358319C91	②♠◆9570HD
Belt - Fan	358319C91	②♠◆9570HD	Belt - W.P.	359021C91	②TR22434
Belt - W.P.	359021C91	②TR22434	Belt - Alt.; W/37A. Alt.	256346C11	②♠9350HD
Belt - Alt.; W/37A. Alt.	256346C11	②♠9350HD	Belt - Alt.; W/55A., 60A., 62A., 105A., 130A. Alt.		②♠9365HD
Belt - Alt.; W/55A., 60A., 62A., 105A., 130A. Alt.		②♠9365HD	Belt - Alt. & Air Brake Compr.	243605R11	②♠◆9451HD
Belt - Alt. & Air Brake Compr.	243605R11	②♠◆9451HD	Belt - P.S.	164550R2	♠9425HD
Belt - P.S.	164550R2	♠9425HD	Hose - Upper - Eng. To Pipe		24228
Hose - Upper - Eng. To Pipe		24228	or		26501
or		26501	Hose - Upper - Pipe To Rad.		24236
Hose - Upper - Pipe To Rad.		24236	Hose - Lower		24942
Hose - Lower		24942	Hose - By Pass	≈<	20618
Hose - By Pass	≈<	20618	or		28442
or		28442	Hose - Heater		24216
Hose - Heater		24216	1970		
International/Navistar V549			International/Navistar BD220		
193RE			1603		
Belt - Fan	358319C91	②♠◆9570HD	Belt - Fan & Alt.; W/37A., 52A., 61A., 62A. Alt.	151532R1	②7512
Belt - W.P.	359021C91	②TR22434	Belt - Fan & Alt.; W/60A. Alt.	861779R11	②♠9440HD
Belt - Alt.; W/37A. Alt.	256346C11	②♠9350HD	Belt - Gen.; W/20A., 50A. Alt.	20594VA	TR24438
Belt - Alt.; W/55A., 60A., 62A., 105A., 130A. Alt.		②♠9365HD	Belt - Gen.; W/30A. Alt.	81572R2	TR28437
Belt - Alt. & Air Brake Compr.	243605R11	②♠◆9451HD	Belt - Gen.; W/35A., 50A. L.C.I. Gen.	164550R1	②♠9425HD
Belt - P.S.	164550R2	♠9425HD	Belt - P.S.; W/Air Brakes	149636R1	♠9480HD

♠Standard Belt Available.
②Two Required.

◆PowerBand Belt May Work, Use Template to Check.
≈<Cut to Fit.

School Buses

Belts and Coolant Hose for School Buses

School Buses

Application	Mfr. Part No.	Our No.	Application	Mfr. Part No.	Our No.
International/Navistar - Continued			International/Navistar - Continued		
1970 - Continued			1970 - Continued		
International/Navistar BD220 - Continued			International/Navistar BD282 - Continued		
1603 - Continued			1603 - Continued		
Belt - P.S.; W/Hyd. Brakes	864931R2	♣9319HD	Hose - Lower		≈20611
Belt - Air Brake Compr.; W/4 Cu. Ft. Air Brake Compr.	201825R1	♣9440HD		or	26509
Belt - Air Brake Compr.; W/20A., 30A., 50A. Gen.	115505HA	TR22363	Hose - By Pass		24232
International/Navistar BD240			1703 (School Bus); 1803		
1603			Belt - Fan & Alt.		
Belt - Fan & Alt.; W/37A., 52A., 61A., 62A. Alt.	151532R1	②7512	Belt - Fan To Air Brake Compr.; W/P.S.	862880R11	②♣9490HD
Belt - Fan & Alt.; W/60A. Alt.	861779R11	②♣9440HD	Belt - Fan To Air Brake Compr.; W/O P.S. ...	280210C1	♣9530HD
Belt - Gen.; W/20A., 50A. Alt.	20594VA	TR24438	Belt - Fan To Air Brake Compr.; W/O P.S. ...	242270R1	♣9380HD
Belt - Gen.; W/30A. Alt.	81572R2	TR28437	Belt - P.S.	242269R1	♣9405HD
Belt - Gen.; W/35A., 50A. L.C.I. Gen.	164550R1	②♣9425HD	Belt - Air Brake Compr.	280210C1	♣9540HD
Belt - P.S.; W/Air Brakes	149636R1	♣9480HD	Hose - Upper		24232
Belt - P.S.; W/Hyd. Brakes	864931R2	♣9319HD	Hose - Lower - Eng. To Pipe		≈20206
Belt - Air Brake Compr.; W/4 Cu. Ft. Air Brake Compr.	201825R1	♣9440HD	Hose - Lower - Pipe To Rad.		24232
Belt - Air Brake Compr.; W/20A., 30A., 50A. Gen.	115505HA	TR22363	Hose - By Pass		24232
International/Navistar BD264			International/Navistar BD308		
1603			1603		
Belt - Fan & Alt.; W/37A., 52A., 61A., 62A. Alt.	151532R1	②7512	Belt - Fan & Alt.	862880R11	②♣9490HD
Belt - Fan & Alt.; W/60A. Alt.	861779R11	②♣9440HD	Belt - Fan To Air Brake Compr.; W/P.S.	280210C1	♣9530HD
Belt - Gen.; W/20A., 50A. Alt.	20594VA	TR24438	Belt - Fan To Air Brake Compr.; W/O P.S. ...	242270R1	♣9380HD
Belt - Gen.; W/30A. Alt.	81572R2	TR28437	Belt - P.S.	242269R1	♣9405HD
Belt - Gen.; W/35A., 50A. L.C.I. Gen.	164550R1	②♣9425HD	Belt - Air Brake Compr.	280210C1	♣9540HD
Belt - P.S.; W/Air Brakes	149636R1	♣9480HD	Hose - Upper		24232
Belt - P.S.; W/Hyd. Brakes	864931R2	♣9319HD	Hose - Lower		≈20611
Belt - Air Brake Compr.; W/4 Cu. Ft. Air Brake Compr.	201825R1	♣9440HD		or	26509
Belt - Air Brake Compr.; W/20A., 30A., 50A. Gen.	115505HA	TR22363	Hose - By Pass		24232
International/Navistar BD269			1703 (School Bus); 1803		
1603			Belt - Fan & Alt.		
Belt - Fan & Alt.	862880R11	②♣9490HD	Belt - Fan To Air Brake Compr.; W/P.S.	862880R11	②♣9490HD
Belt - Fan To Air Brake Compr.; W/P.S.	280210C1	♣9530HD	Belt - Fan To Air Brake Compr.; W/O P.S. ...	280210C1	♣9530HD
Belt - Fan To Air Brake Compr.; W/O P.S. ...	242270R1	♣9380HD	Belt - Fan To Air Brake Compr.; W/O P.S. ...	242270R1	♣9380HD
Belt - P.S.	242269R1	♣9405HD	Belt - P.S.	242269R1	♣9405HD
Belt - Air Brake Compr.	280210C1	♣9540HD	Belt - Air Brake Compr.	280210C1	♣9540HD
Hose - Upper		24232	Hose - Upper		24232
Hose - Lower		≈20611	Hose - Lower - Eng. To Pipe		≈20206
		26509	Hose - Lower - Pipe To Rad.		24232
		or	Hose - By Pass		24232
		24232	International/Navistar BG220		
Hose - By Pass		24232	1603		
1703 (School Bus); 1803			Belt - Fan & Alt.; W/37A., 52A., 61A., 62A. Alt.		
Belt - Fan & Alt.	862880R11	②♣9490HD	Belt - Fan & Alt.; W/60A. Alt.	861779R11	②♣9440HD
Belt - Fan To Air Brake Compr.; W/P.S.	280210C1	♣9530HD	Belt - Gen.; W/20A., 50A. Alt.	20594VA	TR24438
Belt - Fan To Air Brake Compr.; W/O P.S. ...	242270R1	♣9380HD	Belt - Gen.; W/30A. Alt.	81572R2	TR28437
Belt - P.S.	242269R1	♣9405HD	Belt - Gen.; W/35A., 50A. L.C.I. Gen.	164550R1	②♣9425HD
Belt - Air Brake Compr.	280210C1	♣9540HD	Belt - P.S.; W/Air Brakes	149636R1	♣9480HD
Hose - Upper		24232	Belt - P.S.; W/Hyd. Brakes	864931R2	♣9319HD
Hose - Lower		≈20611	Belt - Air Brake Compr.; W/4 Cu. Ft. Air Brake Compr.	201825R1	♣9440HD
		26509	Belt - Air Brake Compr.; W/20A., 30A., 50A. Gen.	115505HA	TR22363
		or	International/Navistar BG241		
		24232	1603		
Hose - By Pass		24232	Belt - Fan & Alt.; W/37A., 52A., 61A., 62A. Alt.		
1703 (School Bus); 1803			Belt - Fan & Alt.; W/60A. Alt.		
Belt - Fan & Alt.	862880R11	②♣9490HD	Belt - Gen.; W/20A., 50A. Alt.	20594VA	TR24438
Belt - Fan To Air Brake Compr.; W/P.S.	280210C1	♣9530HD	Belt - Gen.; W/30A. Alt.	81572R2	TR28437
Belt - Fan To Air Brake Compr.; W/O P.S. ...	242270R1	♣9380HD	Belt - Gen.; W/35A., 50A. L.C.I. Gen.	164550R1	②♣9425HD
Belt - P.S.	242269R1	♣9405HD	Belt - P.S.; W/Air Brakes	149636R1	♣9480HD
Belt - Air Brake Compr.	280210C1	♣9540HD	Belt - P.S.; W/Hyd. Brakes	864931R2	♣9319HD
Hose - Upper		24232	Belt - Air Brake Compr.; W/4 Cu. Ft. Air Brake Compr.	201825R1	♣9440HD
Hose - Lower - Eng. To Pipe		≈20206	Belt - Air Brake Compr.; W/20A., 30A., 50A. Gen.	115505HA	TR22363
Hose - Lower - Pipe To Rad.		24232	International/Navistar BD282		
Hose - By Pass		24232	1603		
International/Navistar BD282			Belt - Fan & Alt.		
1603			Belt - Fan To Air Brake Compr.; W/P.S.		
Belt - Fan & Alt.	862880R11	②♣9490HD	Belt - Fan To Air Brake Compr.; W/O P.S. ...	242270R1	♣9380HD
Belt - Fan To Air Brake Compr.; W/P.S.	280210C1	♣9530HD	Belt - P.S.	242269R1	♣9405HD
Belt - Fan To Air Brake Compr.; W/O P.S. ...	242270R1	♣9380HD	Belt - Air Brake Compr.	280210C1	♣9540HD
Belt - P.S.	242269R1	♣9405HD	Hose - Upper		24232
Belt - Air Brake Compr.	280210C1	♣9540HD	Hose - Lower		≈20611
Hose - Upper		24232		or	26509

♣Standard Belt Available.
≈Cut to Fit.

②Two Required.

Belts and Coolant Hose for School Buses

Application	Mfr. Part No.	Our No.	Application	Mfr. Part No.	Our No.
International/Navistar - Continued			International/Navistar - Continued		
1970 - Continued			1970 - Continued		
International/Navistar BG265			International/Navistar RD372 - Continued		
1603			1853FC - Continued		
Belt - Fan & Alt.; W/37A., 52A., 61A., 62A.			Hose - Upper; Late FD Chassis; Chassis No. FA66376		26509
Alt.	151532R1	②7512	Hose - Lower; Early FD Chassis; Chassis No. FA66376 ..		26508
Belt - Fan & Alt.; W/60A. Alt.	861779R11	②♠9440HD	Hose - Lower; Late FD Chassis; Chassis No. FA66376		24234
Belt - Gen.; W/20A., 50A. Alt.	20594VA	TR24438		or	26508
Belt - Gen.; W/30A. Alt.	81572R2	TR28437	International/Navistar RD406		
Belt - Gen.; W/35A., 50A. L.C.I. Gen.	164550R1	②♠9425HD	1823		
Belt - P.S.; W/Air Brakes	149636R1	♠9480HD	Belt - Fan & Alt.	359014C91	②TR22514
Belt - P.S.; W/Hyd. Brakes	864931R2	♠9319HD	Belt - W.P. & Alt.; W/37A. Alt.; Chassis No.		
Belt - Air Brake Compr.; W/4 Cu. Ft. Air			FD61626 & Before	193826R11	②TR22508
Brake Compr.	201825R1	♠9440HD	Belt - W.P. & Alt.; W/37A. Alt.; Chassis No.		
Belt - Air Brake Compr.; W/20A., 30A.,			FD61626 & Up & G Chassis No.	223794R11	②TR22514
50A. Gen.	115505HA	TR22363	Belt - W.P. & Alt.; W/60A. Alt.	243604R11	②TR22517
			Belt - P.S.	240354R2	TR22336
			Belt - Air Brake Compr.; W/Wagner Compr.	92836HA	TR32491
			Belt - Air Brake Compr.; W/Westinghouse		
			Compr.	83816HA	TR34467
			Hose - Upper		26515
			Hose - Lower		24232
			1853		
			Belt - Alt.; W/55A., 62A., 145A. Alt.	223794K21	②TR22514
			Belt - Gen.; W/37A. Gen.	193826R11	TR22508
			Belt - P.S.	240354R1	TR22344
			1853FC		
			Belt - Alt.; W/55A., 62A., 145A. Alt.	223794K21	②TR22514
			Belt - Gen.; W/37A. Gen.	193826R11	TR22508
			Belt - P.S.	240354R1	TR22344
			Hose - Upper; Late FD Chassis; Chassis No. FA66376		26509
			Hose - Lower; Early FD Chassis; Chassis No. FA66376 ..		26508
			Hose - Lower; Late FD Chassis; Chassis No. FA66376		24234
				or	26508
			International/Navistar RD450		
			1823		
			Belt - Fan & Alt.	359014C91	②TR22514
			Belt - W.P. & Alt.; W/37A. Alt.; Chassis No.		
			FD61626 & Before	193826R11	②TR22508
			Belt - W.P. & Alt.; W/37A. Alt.; Chassis No.		
			FD61626 & Up & G Chassis No.	223794R11	②TR22514
			Belt - W.P. & Alt.; W/60A. Alt.	243604R11	②TR22517
			Belt - P.S.	240354R2	TR22336
			Belt - Air Brake Compr.; W/Wagner Compr.	92836HA	TR32491
			Belt - Air Brake Compr.; W/Westinghouse		
			Compr.	83816HA	TR34467
			Hose - Upper		26515
			Hose - Lower		24232
			1853		
			Belt - Alt.; W/55A., 62A., 145A. Alt.	223794K21	②TR22514
			Belt - Gen.; W/37A. Gen.	193826R11	TR22508
			Belt - P.S.	240354R1	TR22344
			1853FC		
			Belt - Alt.; W/55A., 62A., 145A. Alt.	223794K21	②TR22514
			Belt - Gen.; W/37A. Gen.	193826R11	TR22508
			Belt - P.S.	240354R1	TR22344
			Hose - Upper; Late FD Chassis; Chassis No. FA66376		26509
			Hose - Lower; Early FD Chassis; Chassis No. FA66376 ..		26508
			Hose - Lower; Late FD Chassis; Chassis No. FA66376		24234
				or	26508
			International/Navistar RD501		
			1823		
			Belt - Fan & Alt.	359014C91	②TR22514
			Belt - W.P. & Alt.; W/37A. Alt.; Chassis No.		
			FD61626 & Before	193826R11	②TR22508
			Belt - W.P. & Alt.; W/37A. Alt.; Chassis No.		
			FD61626 & Up & G Chassis No.	223794R11	②TR22514
			Belt - W.P. & Alt.; W/60A. Alt.	243604R11	②TR22517

♠Standard Belt Available.
 ◆PowerBand Belt May Work, Use Template to Check.

②Two Required.
 ≍Cut to Fit.

Belts and Coolant Hose for School Buses

School Buses

Application	Mfr. Part No.	Our No.	Application	Mfr. Part No.	Our No.
International/Navistar - Continued			International/Navistar - Continued		
1970 - Continued			1970 - Continued		
International/Navistar RD501 - Continued			International/Navistar V345 - Continued		
1823 - Continued			1603; 1703 (School Bus) - Continued		
Belt - P.S.	240354R2	TR22336	Belt - Fan & Alt.; W/55A., 62A. Alt.; C, G, H Chassis	369723C91	②7630
Belt - Air Brake Compr.; W/Wagner Compr. .	92836HA	TR32491	Belt - Fan & Alt.; W/55A., 62A. Alt.; FD, SB Chassis	361975C91	②7673
Belt - Air Brake Compr.; W/Westinghouse Compr.	83816HA	TR34467	Belt - Fan & Alt.; W/60A. Alt.	359009C91	②7680
Hose - Upper		26515	Belt - Fan & Alt.; W/65A., 80A., 105A., 145A. Alt.; W/P.T.O.	361975C91	②7673
Hose - Lower		24232	Belt - Fan & Alt.; W/65A., 80A., 105A., 145A. Alt.; W/O P.T.O.		②7630
1853			Belt - P.S.; W/2WD		7460
Belt - Alt.; W/55A., 62A., 145A. Alt.	223794K21	②TR22514	Belt - P.S.; W/4WD	285522C2	7435
Belt - Gen.; W/37A. Gen.	193826R11	TR22508	Belt - Air Brake Compr.	359007C91	7475
Belt - P.S.	240354R1	TR22344	Belt - A.P.; W/Air Brakes; W/Gov.	388139C1	7330
1853FC			Belt - A.P.; W/Air Brakes; W/O Gov.	256062C2	7340
Belt - Alt.; W/55A., 62A., 145A. Alt.	223794K21	②TR22514	Belt - A.P.; W/Hyd. Brakes; W/Gov.	355653C91	7380
Belt - Gen.; W/37A. Gen.	193826R11	TR22508	Belt - A.P.; W/Hyd. Brakes; W/O Gov.	362887C91	7410
Belt - P.S.	240354R1	TR22344	Hose - Upper; W/Rad. Shutters; W/Metal Hood		26515
Hose - Upper; Late FD Chassis; Chassis No. FA66376		26509	Hose - Upper; W/O Rad. Shutters; W/Metal Hood		20493
Hose - Lower; Early FD Chassis; Chassis No. FA66376 ..		26508	Hose - Lower - Eng. To Pipe; W/Auto. Trans.		20532
Hose - Lower; Late FD Chassis; Chassis No. FA66376		24234	Hose - Lower; W/Man. Trans.		21308
		or	Hose - By Pass		②<20357
		26508			
International/Navistar V266			1723		
1603; 1703 (School Bus); 1803			Belt - Fan & Alt.; W/37A., 52A., 61A. Alt.; C, G, H Chassis; W/P.T.O.		
Belt - Fan & Alt.; W/37A., 52A., 61A. Alt.; C, G, H Chassis		②7603	Belt - Fan & Alt.; W/37A., 52A., 61A. Alt.; C, G, H Chassis; W/O P.T.O.	373457C91	②7612
Belt - Fan & Alt.; W/37A., 52A., 61A. Alt.; FD, SB Chassis	255266C3	②7640	Belt - Fan & Alt.; W/37A., 52A., 61A. Alt.; FD, SB Chassis	968815R1	②7650
Belt - Fan & Alt.; W/55A., 62A. Alt.; C, G, H Chassis	369725C91	②7619	Belt - Fan & Alt.; W/37A., 61A. Alt.; W/O Air Brakes; W/O P.T.O.; W/O X.C.	373456C1	7612
Belt - Fan & Alt.; W/55A., 62A. Alt.; FD, SB Chassis	358998C91	②7650	Belt - Fan & Alt.; W/55A., 62A. Alt.; C, G, H Chassis	369723C91	②7630
Belt - P.S.; W/2WD	151529R2	7440	Belt - Fan & Alt.; W/55A., 62A. Alt.; FD, SB Chassis	361975C91	②7673
Belt - P.S.; W/4WD	151531R2	7450	Belt - Fan & Alt.; W/60A. Alt.	359009C91	②7680
Belt - Air Brake Compr.	236572R2	7460	Belt - Fan & Alt.; W/65A., 80A., 105A., 145A. Alt.; W/P.T.O.	361975C91	②7673
Hose - Upper; W/Rad. Shutters; W/Metal Hood		26515	Belt - Fan & Alt.; W/65A., 80A., 105A., 145A. Alt.; W/O P.T.O.		②7630
Hose - Upper; W/O Rad. Shutters; W/Metal Hood		20493	Belt - P.S.; W/2WD		7460
Hose - Lower - Eng. To Pipe; W/Auto. Trans.		20532	Belt - P.S.; W/4WD	285522C2	7435
Hose - Lower; W/Man. Trans.		21308	Belt - Air Brake Compr.	359007C91	7475
Hose - By Pass		②<20357	Belt - A.P.; W/Air Brakes; W/Gov.	388139C1	7330
International/Navistar V304			1803		
1603; 1703 (School Bus); 1803			Belt - Fan & Alt.; W/37A., 52A., 61A. Alt.; C, G, H Chassis; W/P.T.O.		
Belt - Fan & Alt.; W/37A., 52A., 61A. Alt.; C, G, H Chassis		②7603	Belt - Fan & Alt.; W/37A., 52A., 61A. Alt.; C, G, H Chassis; W/O P.T.O.	373457C91	②7612
Belt - Fan & Alt.; W/37A., 52A., 61A. Alt.; FD, SB Chassis	255266C3	②7640	Belt - Fan & Alt.; W/37A., 52A., 61A. Alt.; FD, SB Chassis	968815R1	②7650
Belt - Fan & Alt.; W/55A., 62A. Alt.; C, G, H Chassis	369725C91	②7619	Belt - Fan & Alt.; W/37A., 61A. Alt.; W/O Air Brakes; W/O P.T.O.; W/O X.C.	373456C1	7612
Belt - Fan & Alt.; W/55A., 62A. Alt.; FD, SB Chassis	358998C91	②7650	Belt - Fan & Alt.; W/55A., 62A. Alt.; C, G, H Chassis	369723C91	②7630
Belt - P.S.; W/2WD	151529R2	7440	Belt - Fan & Alt.; W/55A., 62A. Alt.; FD, SB Chassis	361975C91	②7673
Belt - P.S.; W/4WD	151531R2	7450	Belt - Fan & Alt.; W/60A. Alt.	359009C91	②7680
Belt - Air Brake Compr.	236572R2	7460	Belt - Fan & Alt.; W/65A., 80A., 105A., 145A. Alt.; W/P.T.O.	361975C91	②7673
Hose - Upper; W/Rad. Shutters; W/Metal Hood		26515	Belt - Fan & Alt.; W/65A., 80A., 105A., 145A. Alt.; W/O P.T.O.		②7630
Hose - Upper; W/O Rad. Shutters; W/Metal Hood		20493	Belt - P.S.; W/2WD		7460
Hose - Lower - Eng. To Pipe; W/Auto. Trans.		20532	Belt - P.S.; W/4WD	285522C2	7435
Hose - Lower; W/Man. Trans.		21308	Belt - Air Brake Compr.	359007C91	7475
Hose - By Pass		②<20357	Belt - A.P.; W/Air Brakes; W/Gov.	388139C1	7330
International/Navistar V345			1803		
1603; 1703 (School Bus)			Belt - Fan & Alt.; W/37A., 52A., 61A. Alt.; C, G, H Chassis; W/P.T.O.		
Belt - Fan & Alt.; W/37A., 52A., 61A. Alt.; C, G, H Chassis; W/P.T.O.	968815R11	②7650	Belt - Fan & Alt.; W/37A., 52A., 61A. Alt.; C, G, H Chassis; W/O P.T.O.	373457C91	②7612
Belt - Fan & Alt.; W/37A., 52A., 61A. Alt.; C, G, H Chassis; W/O P.T.O.	373457C91	②7612	Belt - Fan & Alt.; W/37A., 52A., 61A. Alt.; FD, SB Chassis	968815R1	②7650
Belt - Fan & Alt.; W/37A., 52A., 61A. Alt.; FD, SB Chassis	968815R1	②7650	Belt - Fan & Alt.; W/37A., 61A. Alt.; W/O Air Brakes; W/O P.T.O.; W/O X.C.	373456C1	7612
Belt - Fan & Alt.; W/37A., 61A. Alt.; W/O Air Brakes; W/O P.T.O.; W/O X.C.	373456C1	7612	Belt - Fan & Alt.; W/55A., 62A. Alt.; C, G, H Chassis	369723C91	②7630

②Two Required.

②Cut to Fit.

Belts and Coolant Hose for School Buses

Application	Mfr. Part No.	Our No.	Application	Mfr. Part No.	Our No.
International/Navistar - Continued			International/Navistar - Continued		
1970 - Continued			1970 - Continued		
International/Navistar V345 - Continued			International/Navistar V392 - Continued		
1803 - Continued			1723		
Belt - A.P.; W/Air Brakes; W/O Gov.	256062C2	7340	Belt - Fan & Alt.; W/37A., 52A., 61A. Alt.; C, G, H Chassis; W/P.T.O.	968815R11	②7650
Belt - A.P.; W/Hyd. Brakes; W/Gov.	355653C91	7380	Belt - Fan & Alt.; W/37A., 52A., 61A. Alt.; C, G, H Chassis; W/O P.T.O.	373457C91	②7612
Belt - A.P.; W/Hyd. Brakes; W/O Gov.	362887C91	7410	Belt - Fan & Alt.; W/37A., 52A., 61A. Alt.; FD, SB Chassis	968815R1	②7650
Hose - Upper; W/Rad. Shutters; W/Metal Hood	26515		Belt - Fan & Alt.; W/37A., 61A. Alt.; W/O Air Brakes; W/O P.T.O.; W/O X.C.	373456C1	7612
Hose - Upper; W/O Rad. Shutters; W/Metal Hood	20493		Belt - Fan & Alt.; W/55A., 62A. Alt.; C, G, H Chassis	369723C91	②7630
Hose - Lower - Eng. To Pipe; W/Auto. Trans.	20532		Belt - Fan & Alt.; W/55A., 62A. Alt.; FD, SB Chassis	361975C91	②7673
Hose - Lower; W/Man. Trans.	21308		Belt - Fan & Alt.; W/60A. Alt.	359009C91	②7680
Hose - By Pass	≠20357		Belt - Fan & Alt.; W/65A., 80A., 105A., 145A. Alt.; W/P.T.O.	361975C91	②7673
1823			Belt - Fan & Alt.; W/65A., 80A., 105A., 145A. Alt.; W/O P.T.O.		②7630
Belt - Fan & Alt.; W/37A., 52A., 61A. Alt.; C, G, H Chassis; W/P.T.O.	968815R11	②7650	Belt - P.S.; W/2WD		7460
Belt - Fan & Alt.; W/37A., 52A., 61A. Alt.; C, G, H Chassis; W/O P.T.O.	373457C91	②7612	Belt - P.S.; W/4WD	285522C2	7435
Belt - Fan & Alt.; W/37A., 52A., 61A. Alt.; FD, SB Chassis	968815R1	②7650	Belt - Air Brake Compr.	359007C91	7475
Belt - Fan & Alt.; W/37A., 61A. Alt.; W/O Air Brakes; W/O P.T.O.; W/O X.C.	373456C1	7612	Belt - A.P.; W/Air Brakes; W/Gov.	388139C1	7330
Belt - Fan & Alt.; W/55A., 62A. Alt.; C, G, H Chassis	369723C91	②7630	Belt - A.P.; W/Air Brakes; W/O Gov.	256062C2	7340
Belt - Fan & Alt.; W/55A., 62A. Alt.; FD, SB Chassis	361975C91	②7673	Belt - A.P.; W/Hyd. Brakes; W/Gov.	355653C91	7380
Belt - Fan & Alt.; W/60A. Alt.	359009C91	②7680	Belt - A.P.; W/Hyd. Brakes; W/O Gov.	362887C91	7410
Belt - Fan & Alt.; W/65A., 80A., 105A., 145A. Alt.; W/P.T.O.	361975C91	②7673	1803		
Belt - Fan & Alt.; W/65A., 80A., 105A., 145A. Alt.; W/O P.T.O.		②7630	Belt - Fan & Alt.; W/37A., 52A., 61A. Alt.; C, G, H Chassis; W/P.T.O.	968815R11	②7650
Belt - P.S.; W/2WD		7460	Belt - Fan & Alt.; W/37A., 52A., 61A. Alt.; C, G, H Chassis; W/O P.T.O.	373457C91	②7612
Belt - P.S.; W/4WD	285522C2	7435	Belt - Fan & Alt.; W/37A., 52A., 61A. Alt.; FD, SB Chassis	968815R1	②7650
Belt - Air Brake Compr.	359007C91	7475	Belt - Fan & Alt.; W/37A., 61A. Alt.; W/O Air Brakes; W/O P.T.O.; W/O X.C.	373456C1	7612
Belt - A.P.; W/Air Brakes; W/Gov.	388139C1	7330	Belt - Fan & Alt.; W/55A., 62A. Alt.; C, G, H Chassis	369723C91	②7630
Belt - A.P.; W/Air Brakes; W/O Gov.	256062C2	7340	Belt - Fan & Alt.; W/55A., 62A. Alt.; FD, SB Chassis	361975C91	②7673
Belt - A.P.; W/Hyd. Brakes; W/Gov.	355653C91	7380	Belt - Fan & Alt.; W/60A. Alt.	359009C91	②7680
Belt - A.P.; W/Hyd. Brakes; W/O Gov.	362887C91	7410	Belt - Fan & Alt.; W/65A., 80A., 105A., 145A. Alt.; W/P.T.O.	361975C91	②7673
International/Navistar V392			Belt - Fan & Alt.; W/65A., 80A., 105A., 145A. Alt.; W/O P.T.O.		②7630
1603; 1703 (School Bus)			Belt - P.S.; W/2WD		7460
Belt - Fan & Alt.; W/37A., 52A., 61A. Alt.; C, G, H Chassis; W/P.T.O.	968815R11	②7650	Belt - P.S.; W/4WD	285522C2	7435
Belt - Fan & Alt.; W/37A., 52A., 61A. Alt.; C, G, H Chassis; W/O P.T.O.	373457C91	②7612	Belt - Air Brake Compr.	359007C91	7475
Belt - Fan & Alt.; W/37A., 52A., 61A. Alt.; FD, SB Chassis	968815R1	②7650	Belt - A.P.; W/Air Brakes; W/Gov.	388139C1	7330
Belt - Fan & Alt.; W/37A., 61A. Alt.; W/O Air Brakes; W/O P.T.O.; W/O X.C.	373456C1	7612	Belt - A.P.; W/Air Brakes; W/O Gov.	256062C2	7340
Belt - Fan & Alt.; W/55A., 62A. Alt.; C, G, H Chassis	369723C91	②7630	Belt - A.P.; W/Hyd. Brakes; W/Gov.	355653C91	7380
Belt - Fan & Alt.; W/55A., 62A. Alt.; FD, SB Chassis	361975C91	②7673	Belt - A.P.; W/Hyd. Brakes; W/O Gov.	362887C91	7410
Belt - Fan & Alt.; W/60A. Alt.	359009C91	②7680	Hose - Upper; W/Rad. Shutters; W/Metal Hood	26515	
Belt - Fan & Alt.; W/65A., 80A., 105A., 145A. Alt.; W/P.T.O.	361975C91	②7673	Hose - Upper; W/O Rad. Shutters; W/Metal Hood	20493	
Belt - Fan & Alt.; W/65A., 80A., 105A., 145A. Alt.; W/O P.T.O.		②7630	Hose - Lower - Eng. To Pipe; W/Auto. Trans.	20532	
Belt - P.S.; W/2WD		7460	Hose - Lower; W/Man. Trans.	21308	
Belt - P.S.; W/4WD	285522C2	7435	Hose - By Pass	≠20357	
Belt - Air Brake Compr.	359007C91	7475	1823		
Belt - A.P.; W/Air Brakes; W/Gov.	388139C1	7330	Belt - Fan & Alt.; W/37A., 52A., 61A. Alt.; C, G, H Chassis; W/P.T.O.	968815R11	②7650
Belt - A.P.; W/Air Brakes; W/O Gov.	256062C2	7340	Belt - Fan & Alt.; W/37A., 52A., 61A. Alt.; C, G, H Chassis; W/O P.T.O.	373457C91	②7612
Belt - A.P.; W/Hyd. Brakes; W/Gov.	355653C91	7380	Belt - Fan & Alt.; W/37A., 52A., 61A. Alt.; FD, SB Chassis	968815R1	②7650
Belt - A.P.; W/Hyd. Brakes; W/O Gov.	362887C91	7410	Belt - Fan & Alt.; W/37A., 61A. Alt.; W/O Air Brakes; W/O P.T.O.; W/O X.C.	373456C1	7612
Hose - Upper; W/Rad. Shutters; W/Metal Hood	26515		Belt - Fan & Alt.; W/55A., 62A. Alt.; C, G, H Chassis	369723C91	②7630
Hose - Upper; W/O Rad. Shutters; W/Metal Hood	20493		Belt - Fan & Alt.; W/55A., 62A. Alt.; FD, SB Chassis	361975C91	②7673
Hose - Lower - Eng. To Pipe; W/Auto. Trans.	20532		Belt - Fan & Alt.; W/60A. Alt.	359009C91	②7680
Hose - Lower; W/Man. Trans.	21308		International/Navistar V392 - Continued		
Hose - By Pass	≠20357		1723		

≠Cut to Fit.

②Two Required.

School Buses

Belts and Coolant Hose for School Buses

School Buses

Application	Mfr. Part No.	Our No.	Application	Mfr. Part No.	Our No.
International/Navistar - Continued			International/Navistar - Continued		
1970 - Continued			1970 - Continued		
International/Navistar V392 - Continued			International/Navistar V549 - Continued		
1823 - Continued			193RE - Continued		
Belt - Fan & Alt.: W/65A., 80A., 105A., 145A. Alt.; W/P.T.O.	361975C91	②7673	Belt - P.S.	164550R2	◆9425HD
Belt - Fan & Alt.: W/65A., 80A., 105A., 145A. Alt.; W/O P.T.O.		②7630	Hose - Upper - Eng. To Pipe		24228
Belt - P.S.; W/2WD		7460		or	26501
Belt - P.S.; W/4WD	285522C2	7435	Hose - Upper - Pipe To Rad.		24236
Belt - Air Brake Compr.	359007C91	7475	Hose - Lower		24942
Belt - A.P.; W/Air Brakes; W/Gov.	388139C1	7330	Hose - By Pass		≈<20618
Belt - A.P.; W/Air Brakes; W/O Gov.	256062C2	7340		or	28442
Belt - A.P.; W/Hyd. Brakes; W/Gov.	355653C91	7380	Hose - Heater		24216
Belt - A.P.; W/Hyd. Brakes; W/O Gov.	362887C91	7410			
International/Navistar V401			International/Navistar VS401		
193RE			193RE		
Belt - Fan	358319C91	②◆◆9570HD	Belt - Fan	358319C91	②◆◆9570HD
Belt - W.P.	359021C91	②TR22434	Belt - W.P.	359021C91	②TR22434
Belt - Alt.; W/37A. Alt.	256346C11	②◆9350HD	Belt - Alt.; W/37A. Alt.	256346C11	②◆9350HD
Belt - Alt.; W/55A., 60A., 62A., 105A., 130A. Alt.		②◆9365HD	Belt - Alt.; W/55A., 60A., 62A., 105A., 130A. Alt.		②◆9365HD
Belt - Alt. & Air Brake Compr.	243605R11	②◆◆9451HD	Belt - Alt. & Air Brake Compr.	243605R11	②◆◆9451HD
Belt - P.S.	164550R2	◆9425HD	Belt - P.S.	164550R2	◆9425HD
Hose - Upper - Eng. To Pipe		24228	Hose - Upper - Eng. To Pipe		24228
	or	26501		or	26501
Hose - Upper - Pipe To Rad.		24236	Hose - Upper - Pipe To Rad.		24236
Hose - Lower		24942	Hose - Lower		24942
Hose - By Pass		≈<20618	Hose - By Pass		≈<20618
	or	28442		or	28442
Hose - Heater		24216	Hose - Heater		24216
International/Navistar V461			International/Navistar VS478		
193RE			193RE		
Belt - Fan	358319C91	②◆◆9570HD	Belt - Fan	358319C91	②◆◆9570HD
Belt - W.P.	359021C91	②TR22434	Belt - W.P.	359021C91	②TR22434
Belt - Alt.; W/37A. Alt.	256346C11	②◆9350HD	Belt - Alt.; W/37A. Alt.	256346C11	②◆9350HD
Belt - Alt.; W/55A., 60A., 62A., 105A., 130A. Alt.		②◆9365HD	Belt - Alt.; W/55A., 60A., 62A., 105A., 130A. Alt.		②◆9365HD
Belt - Alt. & Air Brake Compr.	243605R11	②◆◆9451HD	Belt - Alt. & Air Brake Compr.	243605R11	②◆◆9451HD
Belt - P.S.	164550R2	◆9425HD	Belt - P.S.	164550R2	◆9425HD
Hose - Upper - Eng. To Pipe		24228	Hose - Upper - Eng. To Pipe		24228
	or	26501		or	26501
Hose - Upper - Pipe To Rad.		24236	Hose - Upper - Pipe To Rad.		24236
Hose - Lower		24942	Hose - Lower		24942
Hose - By Pass		≈<20618	Hose - By Pass		≈<20618
	or	28442		or	28442
Hose - Heater		24216	Hose - Heater		24216
International/Navistar V478			International/Navistar VS549		
193RE			193RE		
Belt - Fan	358319C91	②◆◆9570HD	Belt - Fan	358319C91	②◆◆9570HD
Belt - W.P.	359021C91	②TR22434	Belt - W.P.	359021C91	②TR22434
Belt - Alt.; W/37A. Alt.	256346C11	②◆9350HD	Belt - Alt.; W/37A. Alt.	256346C11	②◆9350HD
Belt - Alt.; W/55A., 60A., 62A., 105A., 130A. Alt.		②◆9365HD	Belt - Alt.; W/55A., 60A., 62A., 105A., 130A. Alt.		②◆9365HD
Belt - Alt. & Air Brake Compr.	243605R11	②◆◆9451HD	Belt - Alt. & Air Brake Compr.	243605R11	②◆◆9451HD
Belt - P.S.	164550R2	◆9425HD	Belt - P.S.	164550R2	◆9425HD
Hose - Upper - Eng. To Pipe		24228	Hose - Upper - Eng. To Pipe		24228
	or	26501		or	26501
Hose - Upper - Pipe To Rad.		24236	Hose - Upper - Pipe To Rad.		24236
Hose - Lower		24942	Hose - Lower		24942
Hose - By Pass		≈<20618	Hose - By Pass		≈<20618
	or	28442		or	28442
Hose - Heater		24216	Hose - Heater		24216
International/Navistar V549			1969		
193RE			International/Navistar BD220		
Belt - Fan	358319C91	②◆◆9570HD	1603		
Belt - W.P.	359021C91	②TR22434	Belt - Fan & Alt.; W/37A., 52A., 61A., 62A. Alt.	151532R1	②7512
Belt - Alt.; W/37A. Alt.	256346C11	②◆9350HD	Belt - Fan & Alt.; W/60A. Alt.	861779R11	②◆9440HD
Belt - Alt.; W/55A., 60A., 62A., 105A., 130A. Alt.		②◆9365HD	Belt - Gen.; W/20A., 50A. Alt.	20594VA	TR24438
Belt - Alt. & Air Brake Compr.	243605R11	②◆◆9451HD	Belt - Gen.; W/30A. Alt.	81572R2	TR28437
Belt - P.S.	164550R2	◆9425HD	Belt - Gen.; W/35A., 50A. L.C.I. Gen.	164550R1	②◆9425HD
Hose - Upper - Eng. To Pipe		24228			
	or	26501			
Hose - Upper - Pipe To Rad.		24236			
Hose - Lower		24942			
Hose - By Pass		≈<20618			
	or	28442			
Hose - Heater		24216			

②Two Required.
◆PowerBand Belt May Work, Use Template to Check.

◆Standard Belt Available.
≈<Cut to Fit.

Belts and Coolant Hose for School Buses

Application	Mfr. Part No.	Our No.	Application	Mfr. Part No.	Our No.
International/Navistar - Continued			International/Navistar - Continued		
1969 - Continued			1969 - Continued		
International/Navistar BD220 - Continued			International/Navistar BD269 - Continued		
1603 - Continued			1703 (School Bus); 1803 - Continued		
Belt - P.S.; W/Air Brakes	149636R1	▲9480HD	Belt - P.S.	242269R1	▲9405HD
Belt - P.S.; W/Hyd. Brakes	864931R2	▲9319HD	Belt - Air Brake Compr.	280210C1	▲9540HD
Belt - Air Brake Compr.; W/4 Cu. Ft. Air Brake Compr.	201825R1	▲9440HD	Hose - Upper		24232
Belt - Air Brake Compr.; W/20A., 30A., 50A. Gen.	115505HA	TR22363	Hose - Lower - Eng. To Pipe		≡<20206
Hose - Upper		26510	Hose - Lower - Pipe To Rad.		24232
Hose - Lower - Eng. To Pipe		26508	Hose - By Pass		24232
Hose - Lower - Pipe To Rad.		26514			
Hose - By Pass		20338			
	or	28441			
International/Navistar BD240			International/Navistar BD282		
1603			1603		
Belt - Fan & Alt.; W/37A., 52A., 61A., 62A. Alt.	151532R1	②7512	Belt - Fan & Alt.	862880R11	②▲9490HD
Belt - Fan & Alt.; W/60A. Alt.	861779R11	②▲9440HD	Belt - Fan To Air Brake Compr.; W/P.S.	280210C1	▲9530HD
Belt - Gen.; W/20A., 50A. Alt.	20594VA	TR24438	Belt - Fan To Air Brake Compr.; W/O P.S. ...	242270R1	▲9380HD
Belt - Gen.; W/30A. Alt.	81572R2	TR28437	Belt - P.S.	242269R1	▲9405HD
Belt - Gen.; W/35A., 50A. L.C.I. Gen.	164550R1	②▲9425HD	Belt - Air Brake Compr.	280210C1	▲9540HD
Belt - P.S.; W/Air Brakes	149636R1	▲9480HD	Hose - Upper		24232
Belt - P.S.; W/Hyd. Brakes	864931R2	▲9319HD	Hose - Lower		≡<20611
Belt - Air Brake Compr.; W/4 Cu. Ft. Air Brake Compr.	201825R1	▲9440HD			26509
Belt - Air Brake Compr.; W/20A., 30A., 50A. Gen.	115505HA	TR22363	Hose - By Pass		24232
Hose - Upper		26510			
Hose - Lower - Eng. To Pipe		26508			
Hose - Lower - Pipe To Rad.		26514			
Hose - By Pass		20338			
	or	28441			
International/Navistar BD264			1703 (School Bus); 1803		
1603			1603		
Belt - Fan & Alt.; W/37A., 52A., 61A., 62A. Alt.	151532R1	②7512	Belt - Fan & Alt.	862880R11	②▲9490HD
Belt - Fan & Alt.; W/60A. Alt.	861779R11	②▲9440HD	Belt - Fan To Air Brake Compr.; W/P.S.	280210C1	▲9530HD
Belt - Gen.; W/20A., 50A. Alt.	20594VA	TR24438	Belt - Fan To Air Brake Compr.; W/O P.S. ...	242270R1	▲9380HD
Belt - Gen.; W/30A. Alt.	81572R2	TR28437	Belt - P.S.	242269R1	▲9405HD
Belt - Gen.; W/35A., 50A. L.C.I. Gen.	164550R1	②▲9425HD	Belt - Air Brake Compr.	280210C1	▲9540HD
Belt - P.S.; W/Air Brakes	149636R1	▲9480HD	Hose - Upper		24232
Belt - P.S.; W/Hyd. Brakes	864931R2	▲9319HD	Hose - Lower		≡<20611
Belt - Air Brake Compr.; W/4 Cu. Ft. Air Brake Compr.	201825R1	▲9440HD			26509
Belt - Air Brake Compr.; W/20A., 30A., 50A. Gen.	115505HA	TR22363	Hose - By Pass		24232
Hose - Upper		26510			
Hose - Lower - Eng. To Pipe		26508			
Hose - Lower - Pipe To Rad.		26514			
Hose - By Pass		20338			
	or	28441			
International/Navistar BD269			International/Navistar BD308		
1603			1603		
Belt - Fan & Alt.	862880R11	②▲9490HD	Belt - Fan & Alt.	862880R11	②▲9490HD
Belt - Fan To Air Brake Compr.; W/P.S.	280210C1	▲9530HD	Belt - Fan To Air Brake Compr.; W/P.S.	280210C1	▲9530HD
Belt - Fan To Air Brake Compr.; W/O P.S. ...	242270R1	▲9380HD	Belt - Fan To Air Brake Compr.; W/O P.S. ...	242270R1	▲9380HD
Belt - P.S.	242269R1	▲9405HD	Belt - P.S.	242269R1	▲9405HD
Belt - Air Brake Compr.	280210C1	▲9540HD	Belt - Air Brake Compr.	280210C1	▲9540HD
Hose - Upper		24232	Hose - Upper		24232
Hose - Lower		≡<20611	Hose - Lower		≡<20611
		26509			26509
Hose - By Pass		24232	Hose - By Pass		24232
	or				
Belt - Fan & Alt.	862880R11	②▲9490HD	1703 (School Bus); 1803		
Belt - Fan To Air Brake Compr.; W/P.S.	280210C1	▲9530HD	Belt - Fan & Alt.	862880R11	②▲9490HD
Belt - Fan To Air Brake Compr.; W/O P.S. ...	242270R1	▲9380HD	Belt - Fan To Air Brake Compr.; W/P.S.	280210C1	▲9530HD
Belt - P.S.	242269R1	▲9405HD	Belt - Fan To Air Brake Compr.; W/O P.S. ...	242270R1	▲9380HD
Belt - Air Brake Compr.	280210C1	▲9540HD	Belt - P.S.	242269R1	▲9405HD
Hose - Upper		24232	Belt - Air Brake Compr.	280210C1	▲9540HD
Hose - Lower		≡<20611	Hose - Upper		24232
		26509	Hose - Lower - Eng. To Pipe		≡<20206
Hose - By Pass		24232	Hose - Lower - Pipe To Rad.		24232
	or		Hose - By Pass		24232
1703 (School Bus); 1803					
Belt - Fan & Alt.	862880R11	②▲9490HD			
Belt - Fan To Air Brake Compr.; W/P.S.	280210C1	▲9530HD			
Belt - Fan To Air Brake Compr.; W/O P.S. ...	242270R1	▲9380HD			
Belt - P.S.	242269R1	▲9405HD			
Belt - Air Brake Compr.	280210C1	▲9540HD			
Hose - Upper		24232			
Hose - Lower		≡<20611			
		26509			
Hose - By Pass		24232			
	or				
International/Navistar BG220					
1603					
Belt - Fan & Alt.; W/37A., 52A., 61A., 62A. Alt.	151532R1	②7512			
Belt - Fan & Alt.; W/60A. Alt.	861779R11	②▲9440HD			
Belt - Gen.; W/20A., 50A. Alt.	20594VA	TR24438			
Belt - Gen.; W/30A. Alt.	81572R2	TR28437			
Belt - Gen.; W/35A., 50A. L.C.I. Gen.	164550R1	②▲9425HD			
Belt - P.S.; W/Air Brakes	149636R1	▲9480HD			
Belt - P.S.; W/Hyd. Brakes	864931R2	▲9319HD			
Belt - Air Brake Compr.; W/4 Cu. Ft. Air Brake Compr.	201825R1	▲9440HD			
Belt - Air Brake Compr.; W/20A., 30A., 50A. Gen.	115505HA	TR22363			
Hose - Upper		26510			

▲Standard Belt Available.
≡<Cut to Fit.

②Two Required.

Belts and Coolant Hose for School Buses

Application	Mfr. Part No.	Our No.	Application	Mfr. Part No.	Our No.
International/Navistar - Continued			International/Navistar - Continued		
1969 - Continued			1969 - Continued		
International/Navistar BG220 - Continued			International/Navistar FTVS549 - Continued		
1603 - Continued			193RE - Continued		
Hose - Lower - Eng. To Pipe		26508	Belt - Alt. & Air Brake Compr.	243605R11	②◆◆9451HD
Hose - Lower - Pipe To Rad.		26514	Belt - P.S.	164550R2	◆9425HD
Hose - By Pass		20338	Hose - Upper - Eng. To Pipe		24228
	or	28441		or	26501
International/Navistar BG241			Hose - Upper - Pipe To Rad.		
1603			Hose - Lower		
Belt - Fan & Alt.; W/37A., 52A., 61A., 62A.			Hose - By Pass		
Alt.	151532R1	②7512	or		
Belt - Fan & Alt.; W/60A. Alt.	861779R11	②◆9440HD	Hose - Heater		
Belt - Gen.; W/20A., 50A. Alt.	20594VA	TR24438	24216		
Belt - Gen.; W/30A. Alt.	81572R2	TR28437	International/Navistar RD372		
Belt - Gen.; W/35A., 50A. L.C.I. Gen.	164550R1	②◆9425HD	1823		
Belt - P.S.; W/Air Brakes	149636R1	◆9480HD	Belt - Fan & Alt.		
Belt - P.S.; W/Hyd. Brakes	864931R2	◆9319HD	Belt - W.P. & Alt.; W/37A. Alt.; Chassis No.		
Belt - Air Brake Compr.; W/4 Cu. Ft. Air			FD61626 & Before		
Brake Compr.	201825R1	◆9440HD	193826R11		
Belt - Air Brake Compr.; W/20A., 30A.,			②TR22508		
50A. Gen.	115505HA	TR22363	Belt - W.P. & Alt.; W/37A. Alt.; Chassis No.		
Hose - Upper		26510	FD61626 & Up & G Chassis No.		
Hose - Lower - Eng. To Pipe		26508	223794R11		
Hose - Lower - Pipe To Rad.		26514	②TR22514		
Hose - By Pass		20338	Belt - W.P. & Alt.; W/60A. Alt.		
	or	28441	243604R11		
International/Navistar BG265			Belt - P.S.		
1603			240354R2		
Belt - Fan & Alt.; W/37A., 52A., 61A., 62A.			TR22336		
Alt.	151532R1	②7512	TR32491		
Belt - Fan & Alt.; W/60A. Alt.	861779R11	②◆9440HD	Belt - Air Brake Compr.; W/Wagner Compr. .		
Belt - Gen.; W/20A., 50A. Alt.	20594VA	TR24438	92836HA		
Belt - Gen.; W/30A. Alt.	81572R2	TR28437	TR34467		
Belt - Gen.; W/35A., 50A. L.C.I. Gen.	164550R1	②◆9425HD	26515		
Belt - P.S.; W/Air Brakes	149636R1	◆9480HD	24232		
Belt - P.S.; W/Hyd. Brakes	864931R2	◆9319HD	1853		
Belt - Air Brake Compr.; W/4 Cu. Ft. Air			Belt - Alt.; W/55A., 62A., 145A. Alt.		
Brake Compr.	201825R1	◆9440HD	223794K21		
Belt - Air Brake Compr.; W/20A., 30A.,			②TR22514		
50A. Gen.	115505HA	TR22363	Belt - Gen.; W/37A. Gen.		
Hose - Upper		26510	193826R11		
Hose - Lower - Eng. To Pipe		26508	TR22508		
Hose - Lower - Pipe To Rad.		26514	Belt - P.S.		
Hose - By Pass		20338	240354R1		
	or	28441	TR22344		
International/Navistar FTV549			1853FC		
193RE			Belt - Alt.; W/55A., 62A., 145A. Alt.		
Belt - Fan	358319C91	②◆◆9570HD	223794K21		
Belt - W.P.	359021C91	②TR22434	②TR22514		
Belt - Alt.; W/37A. Alt.	256346C11	②◆9350HD	Belt - Gen.; W/37A. Gen.		
Belt - Alt.; W/55A., 60A., 62A., 105A., 130A. Alt.		②◆9365HD	193826R11		
Belt - Alt. & Air Brake Compr.	243605R11	②◆◆9451HD	TR22508		
Belt - P.S.	164550R2	◆9425HD	Belt - P.S.		
Hose - Upper - Eng. To Pipe		24228	240354R1		
	or	26501	TR22344		
Hose - Upper - Pipe To Rad.		24236	1853FC		
Hose - Lower		24942	Belt - Alt.; W/55A., 62A., 145A. Alt.		
Hose - By Pass		≧20618	223794K21		
	or	28442	②TR22514		
Hose - Heater		24216	Belt - Gen.; W/37A. Gen.		
International/Navistar FTVS549			193826R11		
193RE			TR22508		
Belt - Fan	358319C91	②◆◆9570HD	Belt - P.S.		
Belt - W.P.	359021C91	②TR22434	240354R1		
Belt - Alt.; W/37A. Alt.	256346C11	②◆9350HD	TR22344		
Belt - Alt.; W/55A., 60A., 62A., 105A., 130A. Alt.		②◆9365HD	Hose - Upper; Late FD Chassis; Chassis No. FA66376 ...		
			26509		
			Hose - Lower; Early FD Chassis; Chassis No. FA66376 ..		
			26508		
			Hose - Lower; Late FD Chassis; Chassis No. FA66376 ...		
			24234		
			or		
			26508		

②Two Required.

◆PowerBand Belt May Work, Use Template to Check.

◆Standard Belt Available.

≧Cut to Fit.

Belts and Coolant Hose for School Buses

Application	Mfr. Part No.	Our No.	Application	Mfr. Part No.	Our No.
International/Navistar - Continued			International/Navistar - Continued		
1969 - Continued			1969 - Continued		
International/Navistar RD450			International/Navistar V266 - Continued		
1823			1603; 1703 (School Bus); 1803 - Continued		
Belt - Fan & Alt.	359014C91	②TR22514	Hose - Lower - Eng. To Pipe; W/Auto. Trans.		20532
Belt - W.P. & Alt.; W/37A. Alt.; Chassis No. FD61626 & Before	193826R11	②TR22508	Hose - Lower; W/Man. Trans.		21308
Belt - W.P. & Alt.; W/37A. Alt.; Chassis No. FD61626 & Up & G Chassis No.	223794R11	②TR22514	Hose - By Pass		≧20357
Belt - W.P. & Alt.; W/60A. Alt.	243604R11	②TR22517	International/Navistar V304		
Belt - P.S.	240354R2	TR22336	1603; 1703 (School Bus); 1803		
Belt - Air Brake Compr.; W/Wagner Compr.	92836HA	TR32491	Belt - Fan & Alt.; W/37A., 52A., 61A. Alt.; C, G, H Chassis		②7603
Belt - Air Brake Compr.; W/Westinghouse Compr.	83816HA	TR34467	Belt - Fan & Alt.; W/37A., 52A., 61A. Alt.; FD, SB Chassis	255266C3	②7640
Hose - Upper		26515	Belt - Fan & Alt.; W/55A., 62A. Alt.; C, G, H Chassis	369725C91	②7619
Hose - Lower		24232	Belt - Fan & Alt.; W/55A., 62A. Alt.; FD, SB Chassis	358998C91	②7650
1853			Belt - P.S.; W/2WD	151529R2	7440
Belt - Alt.; W/55A., 62A., 145A. Alt.	223794K21	②TR22514	Belt - P.S.; W/4WD	151531R2	7450
Belt - Gen.; W/37A. Gen.	193826R11	TR22508	Belt - Air Brake Compr.	236572R2	7460
Belt - P.S.	240354R1	TR22344	Hose - Upper; W/Rad. Shutters; W/Metal Hood		26515
1853FC			Hose - Upper; W/O Rad. Shutters; W/Metal Hood		20493
Belt - Alt.; W/55A., 62A., 145A. Alt.	223794K21	②TR22514	Hose - Lower - Eng. To Pipe; W/Auto. Trans.		20532
Belt - Gen.; W/37A. Gen.	193826R11	TR22508	Hose - Lower; W/Man. Trans.		21308
Belt - P.S.	240354R1	TR22344	Hose - By Pass		≧20357
Hose - Upper; Late FD Chassis; Chassis No. FA66376 ...		26509	International/Navistar V345		
Hose - Lower; Early FD Chassis; Chassis No. FA66376 ...		26508	1603; 1703 (School Bus)		
Hose - Lower; Late FD Chassis; Chassis No. FA66376 ...		24234	Belt - Fan & Alt.; W/37A., 52A., 61A. Alt.; C, G, H Chassis; W/P.T.O.	968815R11	②7650
or		26508	Belt - Fan & Alt.; W/37A., 52A., 61A. Alt.; C, G, H Chassis; W/O P.T.O.	373457C91	②7612
International/Navistar RD501			Belt - Fan & Alt.; W/37A., 52A., 61A. Alt.; FD, SB Chassis	968815R1	②7650
1823			Belt - Fan & Alt.; W/37A., 61A. Alt.; W/O Air Brakes; W/O P.T.O.; W/O X.C.	373456C1	7612
Belt - Fan & Alt.	359014C91	②TR22514	Belt - Fan & Alt.; W/55A., 62A. Alt.; C, G, H Chassis	369723C91	②7630
Belt - W.P. & Alt.; W/37A. Alt.; Chassis No. FD61626 & Before	193826R11	②TR22508	Belt - Fan & Alt.; W/55A., 62A. Alt.; FD, SB Chassis	361975C91	②7673
Belt - W.P. & Alt.; W/37A. Alt.; Chassis No. FD61626 & Up & G Chassis No.	223794R11	②TR22514	Belt - Fan & Alt.; W/60A. Alt.	359009C91	②7680
Belt - W.P. & Alt.; W/60A. Alt.	243604R11	②TR22517	Belt - Fan & Alt.; W/65A., 80A., 105A., 145A. Alt.; W/P.T.O.	361975C91	②7673
Belt - P.S.	240354R2	TR22336	Belt - Fan & Alt.; W/65A., 80A., 105A., 145A. Alt.; W/O P.T.O.		②7630
Belt - Air Brake Compr.; W/Wagner Compr.	92836HA	TR32491	Belt - P.S.; W/2WD		7460
Belt - Air Brake Compr.; W/Westinghouse Compr.	83816HA	TR34467	Belt - P.S.; W/4WD	285522C2	7435
Hose - Upper		26515	Belt - Air Brake Compr.	359007C91	7475
Hose - Lower		24232	Belt - A.P.; W/Air Brakes; W/Gov.	388139C1	7330
1853			Belt - A.P.; W/Air Brakes; W/O Gov.	256062C2	7340
Belt - Alt.; W/55A., 62A., 145A. Alt.	223794K21	②TR22514	Belt - A.P.; W/Hyd. Brakes; W/Gov.	355653C91	7380
Belt - Gen.; W/37A. Gen.	193826R11	TR22508	Belt - A.P.; W/Hyd. Brakes; W/O Gov.	362887C91	7410
Belt - P.S.	240354R1	TR22344	Hose - Upper; W/Rad. Shutters; W/Metal Hood		26515
Hose - Upper; Late FD Chassis; Chassis No. FA66376 ...		26509	Hose - Upper; W/O Rad. Shutters; W/Metal Hood		20493
Hose - Lower; Early FD Chassis; Chassis No. FA66376 ...		26508	Hose - Lower - Eng. To Pipe; W/Auto. Trans.		20532
Hose - Lower; Late FD Chassis; Chassis No. FA66376 ...		24234	Hose - Lower; W/Man. Trans.		21308
or		26508	Hose - By Pass		≧20357
International/Navistar V266			1723		
1603; 1703 (School Bus); 1803			Belt - Fan & Alt.; W/37A., 52A., 61A. Alt.; C, G, H Chassis; W/P.T.O.	968815R11	②7650
Belt - Fan & Alt.; W/37A., 52A., 61A. Alt.; C, G, H Chassis		②7603	Belt - Fan & Alt.; W/37A., 52A., 61A. Alt.; C, G, H Chassis; W/O P.T.O.	373457C91	②7612
Belt - Fan & Alt.; W/37A., 52A., 61A. Alt.; FD, SB Chassis	255266C3	②7640	Belt - Fan & Alt.; W/37A., 52A., 61A. Alt.; FD, SB Chassis	968815R1	②7650
Belt - Fan & Alt.; W/55A., 62A. Alt.; C, G, H Chassis	369725C91	②7619	Belt - Fan & Alt.; W/37A., 61A. Alt.; W/O Air Brakes; W/O P.T.O.; W/O X.C.	373456C1	7612
Belt - Fan & Alt.; W/55A., 62A. Alt.; FD, SB Chassis	358998C91	②7650	Belt - Fan & Alt.; W/55A., 62A. Alt.; C, G, H Chassis	369723C91	②7630
Belt - P.S.; W/2WD	151529R2	7440	Belt - Fan & Alt.; W/60A. Alt.	361975C91	②7673
Belt - P.S.; W/4WD	151531R2	7450	Belt - Fan & Alt.; W/65A., 80A., 105A., 145A. Alt.; W/P.T.O.	361975C91	②7673
Belt - Air Brake Compr.	236572R2	7460	Belt - Fan & Alt.; W/65A., 80A., 105A., 145A. Alt.; W/O P.T.O.		②7630
Hose - Upper; W/Rad. Shutters; W/Metal Hood		26515	Belt - P.S.; W/2WD		7440
Hose - Upper; W/O Rad. Shutters; W/Metal Hood		20493	Belt - P.S.; W/4WD	285522C2	7435

②Two Required.

≧Cut to Fit.

School Buses

Belts and Coolant Hose for School Buses

School Buses

Application	Mfr. Part No.	Our No.	Application	Mfr. Part No.	Our No.
International/Navistar - Continued			International/Navistar - Continued		
1969 - Continued			1969 - Continued		
International/Navistar V345 - Continued			International/Navistar V392		
1723 - Continued			1603; 1703 (School Bus)		
Belt - Fan & Alt.; W/65A., 80A., 105A., 145A. Alt.; W/P.T.O.	361975C91	@7673	Belt - Fan & Alt.; W/37A., 52A., 61A. Alt.; C, G, H Chassis; W/P.T.O.	968815R11	@7650
Belt - Fan & Alt.; W/65A., 80A., 105A., 145A. Alt.; W/O P.T.O.		@7630	Belt - Fan & Alt.; W/37A., 52A., 61A. Alt.; C, G, H Chassis; W/O P.T.O.	373457C91	@7612
Belt - P.S.; W/2WD		7460	Belt - Fan & Alt.; W/37A., 52A., 61A. Alt.; FD, SB Chassis	968815R1	@7650
Belt - P.S.; W/4WD	285522C2	7435	Belt - Fan & Alt.; W/37A., 61A. Alt.; W/O Air Brakes; W/O P.T.O.; W/O X.C.	373456C1	7612
Belt - Air Brake Compr.	359007C91	7475	Belt - Fan & Alt.; W/55A., 62A. Alt.; C, G, H Chassis	369723C91	@7630
Belt - A.P.; W/Air Brakes; W/Gov.	388139C1	7330	Belt - Fan & Alt.; W/55A., 62A. Alt.; FD, SB Chassis	361975C91	@7673
Belt - A.P.; W/Air Brakes; W/O Gov.	256062C2	7340	Belt - Fan & Alt.; W/60A. Alt.	359009C91	@7680
Belt - A.P.; W/Hyd. Brakes; W/Gov.	355653C91	7380	Belt - Fan & Alt.; W/65A., 80A., 105A., 145A. Alt.; W/P.T.O.	361975C91	@7673
Belt - A.P.; W/Hyd. Brakes; W/O Gov.	362887C91	7410	Belt - Fan & Alt.; W/65A., 80A., 105A., 145A. Alt.; W/O P.T.O.		@7630
1803			Belt - P.S.; W/2WD		7460
Belt - Fan & Alt.; W/37A., 52A., 61A. Alt.; C, G, H Chassis; W/P.T.O.	968815R11	@7650	Belt - P.S.; W/4WD	285522C2	7435
Belt - Fan & Alt.; W/37A., 52A., 61A. Alt.; C, G, H Chassis; W/O P.T.O.	373457C91	@7612	Belt - Air Brake Compr.	359007C91	7475
Belt - Fan & Alt.; W/37A., 52A., 61A. Alt.; FD, SB Chassis	968815R1	@7650	Belt - A.P.; W/Air Brakes; W/Gov.	388139C1	7330
Belt - Fan & Alt.; W/37A., 61A. Alt.; W/O Air Brakes; W/O P.T.O.; W/O X.C.	373456C1	7612	Belt - A.P.; W/Air Brakes; W/O Gov.	256062C2	7340
Belt - Fan & Alt.; W/55A., 62A. Alt.; C, G, H Chassis	369723C91	@7630	Belt - A.P.; W/Hyd. Brakes; W/Gov.	355653C91	7380
Belt - Fan & Alt.; W/55A., 62A. Alt.; FD, SB Chassis	361975C91	@7673	Belt - A.P.; W/Hyd. Brakes; W/O Gov.	362887C91	7410
Belt - Fan & Alt.; W/60A. Alt.	359009C91	@7680	Hose - Upper; W/Rad. Shutters; W/Metal Hood		26515
Belt - Fan & Alt.; W/65A., 80A., 105A., 145A. Alt.; W/P.T.O.	361975C91	@7673	Hose - Upper; W/O Rad. Shutters; W/Metal Hood		20493
Belt - Fan & Alt.; W/65A., 80A., 105A., 145A. Alt.; W/O P.T.O.		@7630	Hose - Lower - Eng. To Pipe; W/Auto. Trans.		20532
Belt - P.S.; W/2WD		7460	Hose - Lower; W/Man. Trans.		21308
Belt - P.S.; W/4WD	285522C2	7435	Hose - By Pass		≈20357
Belt - Air Brake Compr.	359007C91	7475	1723		
Belt - A.P.; W/Air Brakes; W/Gov.	388139C1	7330	Belt - Fan & Alt.; W/37A., 52A., 61A. Alt.; C, G, H Chassis; W/P.T.O.	968815R11	@7650
Belt - A.P.; W/Air Brakes; W/O Gov.	256062C2	7340	Belt - Fan & Alt.; W/37A., 52A., 61A. Alt.; C, G, H Chassis; W/O P.T.O.	373457C91	@7612
Belt - A.P.; W/Hyd. Brakes; W/Gov.	355653C91	7380	Belt - Fan & Alt.; W/37A., 52A., 61A. Alt.; FD, SB Chassis	968815R1	@7650
Belt - A.P.; W/Hyd. Brakes; W/O Gov.	362887C91	7410	Belt - Fan & Alt.; W/37A., 61A. Alt.; W/O Air Brakes; W/O P.T.O.; W/O X.C.	373456C1	7612
Hose - Upper; W/Rad. Shutters; W/Metal Hood		26515	Belt - Fan & Alt.; W/55A., 62A. Alt.; C, G, H Chassis	369723C91	@7630
Hose - Upper; W/O Rad. Shutters; W/Metal Hood		20493	Belt - Fan & Alt.; W/55A., 62A. Alt.; FD, SB Chassis	361975C91	@7673
Hose - Lower - Eng. To Pipe; W/Auto. Trans.		20532	Belt - Fan & Alt.; W/60A. Alt.	359009C91	@7680
Hose - Lower; W/Man. Trans.		21308	Belt - Fan & Alt.; W/65A., 80A., 105A., 145A. Alt.; W/P.T.O.	361975C91	@7673
Hose - By Pass		≈20357	Belt - Fan & Alt.; W/65A., 80A., 105A., 145A. Alt.; W/O P.T.O.		@7630
1823			Belt - P.S.; W/2WD		7460
Belt - Fan & Alt.; W/37A., 52A., 61A. Alt.; C, G, H Chassis; W/P.T.O.	968815R11	@7650	Belt - P.S.; W/4WD	285522C2	7435
Belt - Fan & Alt.; W/37A., 52A., 61A. Alt.; C, G, H Chassis; W/O P.T.O.	373457C91	@7612	Belt - Air Brake Compr.	359007C91	7475
Belt - Fan & Alt.; W/37A., 52A., 61A. Alt.; FD, SB Chassis	968815R1	@7650	Belt - A.P.; W/Air Brakes; W/Gov.	388139C1	7330
Belt - Fan & Alt.; W/37A., 61A. Alt.; W/O Air Brakes; W/O P.T.O.; W/O X.C.	373456C1	7612	Belt - A.P.; W/Air Brakes; W/O Gov.	256062C2	7340
Belt - Fan & Alt.; W/55A., 62A. Alt.; C, G, H Chassis	369723C91	@7630	Belt - A.P.; W/Hyd. Brakes; W/Gov.	355653C91	7380
Belt - Fan & Alt.; W/55A., 62A. Alt.; FD, SB Chassis	361975C91	@7673	Belt - A.P.; W/Hyd. Brakes; W/O Gov.	362887C91	7410
Belt - Fan & Alt.; W/60A. Alt.	359009C91	@7680	1803		
Belt - Fan & Alt.; W/65A., 80A., 105A., 145A. Alt.; W/P.T.O.	361975C91	@7673	Belt - Fan & Alt.; W/37A., 52A., 61A. Alt.; C, G, H Chassis; W/P.T.O.	968815R11	@7650
Belt - Fan & Alt.; W/65A., 80A., 105A., 145A. Alt.; W/O P.T.O.		@7630	Belt - Fan & Alt.; W/37A., 52A., 61A. Alt.; C, G, H Chassis; W/O P.T.O.	373457C91	@7612
Belt - P.S.; W/2WD		7460	Belt - Fan & Alt.; W/37A., 52A., 61A. Alt.; FD, SB Chassis	968815R1	@7650
Belt - P.S.; W/4WD	285522C2	7435	Belt - Fan & Alt.; W/37A., 61A. Alt.; W/O Air Brakes; W/O P.T.O.; W/O X.C.	373456C1	7612
Belt - Air Brake Compr.	359007C91	7475	Belt - Fan & Alt.; W/55A., 62A. Alt.; C, G, H Chassis	369723C91	@7630
Belt - A.P.; W/Air Brakes; W/Gov.	388139C1	7330	Belt - Fan & Alt.; W/55A., 62A. Alt.; FD, SB Chassis	361975C91	@7673
Belt - A.P.; W/Air Brakes; W/O Gov.	256062C2	7340	Belt - Fan & Alt.; W/60A. Alt.	359009C91	@7680
Belt - A.P.; W/Hyd. Brakes; W/Gov.	355653C91	7380	Belt - Fan & Alt.; W/65A., 80A., 105A., 145A. Alt.; W/P.T.O.	361975C91	@7673
Belt - A.P.; W/Hyd. Brakes; W/O Gov.	362887C91	7410	Belt - Fan & Alt.; W/65A., 80A., 105A., 145A. Alt.; W/O P.T.O.		@7630
			Belt - P.S.; W/2WD		7460
			Belt - P.S.; W/4WD	285522C2	7435
			Belt - Air Brake Compr.	359007C91	7475
			Belt - A.P.; W/Air Brakes; W/Gov.	388139C1	7330
			Belt - A.P.; W/Air Brakes; W/O Gov.	256062C2	7340
			Belt - A.P.; W/Hyd. Brakes; W/Gov.	355653C91	7380
			Belt - A.P.; W/Hyd. Brakes; W/O Gov.	362887C91	7410

@Two Required.

≈Cut to Fit.

Belts and Coolant Hose for School Buses

Application	Mfr. Part No.	Our No.	Application	Mfr. Part No.	Our No.
International/Navistar - Continued			International/Navistar - Continued		
1969 - Continued			1969 - Continued		
International/Navistar V392 - Continued			International/Navistar V461 - Continued		
1803 - Continued			193RE - Continued		
Belt - Fan & Alt.; W/65A., 80A., 105A., 145A. Alt.; W/P.T.O.	361975C91	②7673	Hose - Upper - Eng. To Pipe		24228
Belt - Fan & Alt.; W/65A., 80A., 105A., 145A. Alt.; W/O P.T.O.		②7630	or		26501
Belt - P.S.; W/2WD		7460	Hose - Upper - Pipe To Rad.		24236
Belt - P.S.; W/4WD	285522C2	7435	Hose - Lower		24942
Belt - Air Brake Compr.	359007C91	7475	Hose - By Pass	≅	20618
Belt - A.P.; W/Air Brakes; W/Gov.	388139C1	7330	or		28442
Belt - A.P.; W/Air Brakes; W/O Gov.	256062C2	7340	Hose - Heater		24216
Belt - A.P.; W/Hyd. Brakes; W/Gov.	355653C91	7380	International/Navistar V478		
Belt - A.P.; W/Hyd. Brakes; W/O Gov.	362887C91	7410	193RE		
Hose - Upper; W/Rad. Shutters; W/Metal Hood		26515	Belt - Fan	358319C91	②♠◆9570HD
Hose - Upper; W/O Rad. Shutters; W/Metal Hood		20493	Belt - W.P.	359021C91	②TR22434
Hose - Lower - Eng. To Pipe; W/Auto. Trans.		20532	Belt - Alt.; W/37A. Alt.	256346C11	②♠9350HD
Hose - Lower; W/Man. Trans.		21308	Belt - Alt.; W/55A., 60A., 62A., 105A., 130A. Alt.		②♠9365HD
Hose - By Pass	≅	20357	Belt - Alt. & Air Brake Compr.	243605R11	②♠◆9451HD
1823			Belt - P.S.	164550R2	♠9425HD
Belt - Fan & Alt.; W/37A., 52A., 61A. Alt.; C, G, H Chassis; W/P.T.O.	968815R11	②7650	Hose - Upper - Eng. To Pipe		24228
Belt - Fan & Alt.; W/37A., 52A., 61A. Alt.; C, G, H Chassis; W/O P.T.O.	373457C91	②7612	or		26501
Belt - Fan & Alt.; W/37A., 52A., 61A. Alt.; FD, SB Chassis	968815R1	②7650	Hose - Upper - Pipe To Rad.		24236
Belt - Fan & Alt.; W/37A., 61A. Alt.; W/O Air Brakes; W/O P.T.O.; W/O X.C.	373456C1	7612	Hose - Lower		24942
Belt - Fan & Alt.; W/55A., 62A. Alt.; C, G, H Chassis	369723C91	②7630	Hose - By Pass	≅	20618
Belt - Fan & Alt.; W/55A., 62A. Alt.; FD, SB Chassis	361975C91	②7673	or		28442
Belt - Fan & Alt.; W/60A. Alt.	359009C91	②7680	Hose - Heater		24216
Belt - Fan & Alt.; W/65A., 80A., 105A., 145A. Alt.; W/P.T.O.	361975C91	②7673	International/Navistar V549		
Belt - Fan & Alt.; W/65A., 80A., 105A., 145A. Alt.; W/O P.T.O.		②7630	193RE		
Belt - P.S.; W/2WD		7460	Belt - Fan	358319C91	②♠◆9570HD
Belt - P.S.; W/4WD	285522C2	7435	Belt - W.P.	359021C91	②TR22434
Belt - Air Brake Compr.	359007C91	7475	Belt - Alt.; W/37A. Alt.	256346C11	②♠9350HD
Belt - A.P.; W/Air Brakes; W/Gov.	388139C1	7330	Belt - Alt.; W/55A., 60A., 62A., 105A., 130A. Alt.		②♠9365HD
Belt - A.P.; W/Air Brakes; W/O Gov.	256062C2	7340	Belt - Alt. & Air Brake Compr.	243605R11	②♠◆9451HD
Belt - A.P.; W/Hyd. Brakes; W/Gov.	355653C91	7380	Belt - P.S.	164550R2	♠9425HD
Belt - A.P.; W/Hyd. Brakes; W/O Gov.	362887C91	7410	Hose - Upper - Eng. To Pipe		24228
International/Navistar V401			or		26501
193RE			Hose - Upper - Pipe To Rad.		24236
Belt - Fan	358319C91	②♠◆9570HD	Hose - Lower		24942
Belt - W.P.	359021C91	②TR22434	Hose - By Pass	≅	20618
Belt - Alt.; W/37A. Alt.	256346C11	②♠9350HD	or		28442
Belt - Alt.; W/55A., 60A., 62A., 105A., 130A. Alt.		②♠9365HD	Hose - Heater		24216
Belt - Alt. & Air Brake Compr.	243605R11	②♠◆9451HD	International/Navistar VS401		
Belt - P.S.	164550R2	♠9425HD	193RE		
Hose - Upper - Eng. To Pipe		24228	Belt - Fan	358319C91	②♠◆9570HD
or		26501	Belt - W.P.	359021C91	②TR22434
Hose - Upper - Pipe To Rad.		24236	Belt - Alt.; W/37A. Alt.	256346C11	②♠9350HD
Hose - Lower		24942	Belt - Alt.; W/55A., 60A., 62A., 105A., 130A. Alt.		②♠9365HD
Hose - By Pass	≅	20618	Belt - Alt. & Air Brake Compr.	243605R11	②♠◆9451HD
or		28442	Belt - P.S.	164550R2	♠9425HD
Hose - Heater		24216	Hose - Upper - Eng. To Pipe		24228
International/Navistar V461			or		26501
193RE			Hose - Upper - Pipe To Rad.		24236
Belt - Fan	358319C91	②♠◆9570HD	Hose - Lower		24942
Belt - W.P.	359021C91	②TR22434	Hose - By Pass	≅	20618
Belt - Alt.; W/37A. Alt.	256346C11	②♠9350HD	or		28442
Belt - Alt.; W/55A., 60A., 62A., 105A., 130A. Alt.		②♠9365HD	Hose - Heater		24216
Belt - Alt. & Air Brake Compr.	243605R11	②♠◆9451HD	International/Navistar VS478		
Belt - P.S.	164550R2	♠9425HD	193RE		
International/Navistar V461			Belt - Fan	358319C91	②♠◆9570HD
193RE			Belt - W.P.	359021C91	②TR22434
Belt - Fan	358319C91	②♠◆9570HD	Belt - Alt.; W/37A. Alt.	256346C11	②♠9350HD
Belt - W.P.	359021C91	②TR22434	Belt - Alt.; W/55A., 60A., 62A., 105A., 130A. Alt.		②♠9365HD
Belt - Alt.; W/37A. Alt.	256346C11	②♠9350HD	Belt - Alt. & Air Brake Compr.	243605R11	②♠◆9451HD
Belt - Alt.; W/55A., 60A., 62A., 105A., 130A. Alt.		②♠9365HD	Belt - P.S.	164550R2	♠9425HD
Belt - Alt. & Air Brake Compr.	243605R11	②♠◆9451HD	Hose - Upper - Eng. To Pipe		24228
Belt - P.S.	164550R2	♠9425HD	or		26501

②Two Required.
♠Standard Belt Available.

≅Cut to Fit.
◆PowerBand Belt May Work, Use Template to Check.

Belts and Coolant Hose for School Buses

School Buses

Application	Mfr. Part No.	Our No.	Application	Mfr. Part No.	Our No.
International/Navistar - Continued			International/Navistar - Continued		
1969 - Continued			1968 - Continued		
International/Navistar VS478 - Continued			International/Navistar BD264 - Continued		
193RE - Continued			1603 - Continued		
Hose - Upper - Pipe To Rad.		24236	Belt - Fan & Alt.; W/60A. Alt.	861779R11	②♣9440HD
Hose - Lower		24942	Belt - Gen.; W/20A., 50A. Alt.	20594VA	TR24438
Hose - By Pass		≈<20618	Belt - Gen.; W/30A. Alt.	81572R2	TR28437
	or	28442	Belt - Gen.; W/35A., 50A. L.C.I. Gen.	164550R1	②♣9425HD
Hose - Heater		24216	Belt - P.S.; W/Air Brakes	149636R1	♣9480HD
			Belt - P.S.; W/Hyd. Brakes	864931R2	♣9319HD
International/Navistar VS549			Belt - Air Brake Compr.; W/4 Cu. Ft. Air Brake Compr.		
193RE			201825R1		
Belt - Fan	358319C91	②♣♠9570HD	Belt - Air Brake Compr.; W/20A., 30A., 50A. Gen.	115505HA	TR22363
Belt - W.P.	359021C91	②TR22434	Hose - Upper		26510
Belt - Alt.; W/37A. Alt.	256346C11	②♣9350HD	Hose - Lower - Eng. To Pipe		26508
Belt - Alt.; W/55A., 60A., 62A., 105A., 130A. Alt.		②♣9365HD	Hose - Lower - Pipe To Rad.		26514
Belt - Alt. & Air Brake Compr.	243605R11	②♣♠9451HD	Hose - By Pass		20338
Belt - P.S.	164550R2	♣9425HD		or	28441
Hose - Upper - Eng. To Pipe		24228	International/Navistar BD269		
		26501	1603		
Hose - Upper - Pipe To Rad.		24236	Belt - Fan & Alt.	862880R11	②♣9490HD
Hose - Lower		24942	Belt - P.S.	242269R1	♣9405HD
Hose - By Pass		≈<20618	Belt - Air Brake Compr.	280210C1	♣9540HD
	or	28442	Hose - Upper		24232
Hose - Heater		24216	Hose - Lower		≈<20611
				or	26509
1968					24232
International/Navistar BD220			Hose - By Pass		
1603			1703 (School Bus); 1803		
Belt - Fan & Alt.; W/37A., 52A., 61A., 62A. Alt.	151532R1	②7512	Belt - Fan & Alt.	862880R11	②♣9490HD
Belt - Fan & Alt.; W/60A. Alt.	861779R11	②♣9440HD	Belt - P.S.	242269R1	♣9405HD
Belt - Gen.; W/20A., 50A. Alt.	20594VA	TR24438	Belt - Air Brake Compr.	280210C1	♣9540HD
Belt - Gen.; W/30A. Alt.	81572R2	TR28437	Hose - Upper		24232
Belt - Gen.; W/35A., 50A. L.C.I. Gen.	164550R1	②♣9425HD	Hose - Lower - Eng. To Pipe		≈<20206
Belt - P.S.; W/Air Brakes	149636R1	♣9480HD	Hose - Lower - Pipe To Rad.		24232
Belt - P.S.; W/Hyd. Brakes	864931R2	♣9319HD	Hose - By Pass		24232
Belt - Air Brake Compr.; W/4 Cu. Ft. Air Brake Compr.	201825R1	♣9440HD	International/Navistar BD282		
Belt - Air Brake Compr.; W/20A., 30A., 50A. Gen.	115505HA	TR22363	1603		
Hose - Upper		26510	Belt - Fan & Alt.	862880R11	②♣9490HD
Hose - Lower - Eng. To Pipe		26508	Belt - P.S.	242269R1	♣9405HD
Hose - Lower - Pipe To Rad.		26514	Belt - Air Brake Compr.	280210C1	♣9540HD
Hose - By Pass		20338	Hose - Upper		24232
	or	28441	Hose - Lower		≈<20611
				or	26509
International/Navistar BD240					24232
1603			Hose - By Pass		
Belt - Fan & Alt.; W/37A., 52A., 61A., 62A. Alt.	151532R1	②7512	1703 (School Bus); 1803		
Belt - Fan & Alt.; W/60A. Alt.	861779R11	②♣9440HD	Belt - Fan & Alt.	862880R11	②♣9490HD
Belt - Gen.; W/20A., 50A. Alt.	20594VA	TR24438	Belt - P.S.	242269R1	♣9405HD
Belt - Gen.; W/30A. Alt.	81572R2	TR28437	Belt - Air Brake Compr.	280210C1	♣9540HD
Belt - Gen.; W/35A., 50A. L.C.I. Gen.	164550R1	②♣9425HD	Hose - Upper		24232
Belt - P.S.; W/Air Brakes	149636R1	♣9480HD	Hose - Lower - Eng. To Pipe		≈<20206
Belt - P.S.; W/Hyd. Brakes	864931R2	♣9319HD	Hose - Lower - Pipe To Rad.		24232
Belt - Air Brake Compr.; W/4 Cu. Ft. Air Brake Compr.	201825R1	♣9440HD	Hose - By Pass		24232
Belt - Air Brake Compr.; W/20A., 30A., 50A. Gen.	115505HA	TR22363	International/Navistar BD308		
Hose - Upper		26510	1603		
Hose - Lower - Eng. To Pipe		26508	Belt - Fan & Alt.	862880R11	②♣9490HD
Hose - Lower - Pipe To Rad.		26514	Belt - P.S.	242269R1	♣9405HD
Hose - By Pass		20338	Belt - Air Brake Compr.	280210C1	♣9540HD
	or	28441	Hose - Upper		24232
			Hose - Lower		≈<20611
				or	26509
International/Navistar BD264					24232
1603			Hose - By Pass		
Belt - Fan & Alt.; W/37A., 52A., 61A., 62A. Alt.	151532R1	②7512	1703 (School Bus); 1803		
			Belt - Fan & Alt.	862880R11	②♣9490HD
			Belt - P.S.	242269R1	♣9405HD
			Belt - Air Brake Compr.	280210C1	♣9540HD
			Hose - Upper		24232
			Hose - Lower - Eng. To Pipe		≈<20206
			Hose - Lower - Pipe To Rad.		24232
			Hose - By Pass		24232

≈<Cut to Fit.

♣PowerBand Belt May Work, Use Template to Check.

♣Standard Belt Available.

②Two Required.

Belts and Coolant Hose for School Buses

Application	Mfr. Part No.	Our No.	Application	Mfr. Part No.	Our No.
International/Navistar - Continued			International/Navistar - Continued		
1968 - Continued			1968 - Continued		
International/Navistar BD308 - Continued			International/Navistar FTV549 - Continued		
1703 (School Bus); 1803 - Continued			193RE - Continued		
Hose - Lower - Eng. To Pipe		≈20206	Belt - W.P.	359021C91	②TR22434
Hose - Lower - Pipe To Rad.		24232	Belt - Alt.; W/37A. Alt.	256346C11	②♠9350HD
Hose - By Pass		24232	Belt - Alt.; W/55A., 60A., 62A., 105A., 130A. Alt.		②♠9365HD
International/Navistar BG220			Belt - Alt. & Air Brake Compr.	243605R11	②♠♦9451HD
1603			Belt - P.S.	164550R2	♠9425HD
Belt - Fan & Alt.; W/37A., 52A., 61A., 62A. Alt.	151532R1	②7512	Hose - Upper - Eng. To Pipe		24228
Belt - Fan & Alt.; W/60A. Alt.	861779R11	②♠9440HD		or	26501
Belt - Gen.; W/20A., 50A. Alt.	20594VA	TR24438	Hose - Upper - Pipe To Rad.		24236
Belt - Gen.; W/30A. Alt.	81572R2	TR28437	Hose - Lower		24942
Belt - Gen.; W/35A., 50A. L.C.I. Gen.	164550R1	②♠9425HD	Hose - By Pass		≈20618
Belt - P.S.; W/Air Brakes	149636R1	♠9480HD		or	28442
Belt - P.S.; W/Hyd. Brakes	864931R2	♠9319HD	Hose - Heater		24216
Belt - Air Brake Compr.; W/4 Cu. Ft. Air Brake Compr.	201825R1	♠9440HD	International/Navistar FTVS549		
Belt - Air Brake Compr.; W/20A., 30A., 50A. Gen.	115505HA	TR22363	193RE		
Hose - Upper		26510	Belt - Fan	358319C91	②♠♦9570HD
Hose - Lower - Eng. To Pipe		26508	Belt - W.P.	359021C91	②TR22434
Hose - Lower - Pipe To Rad.		26514	Belt - Alt.; W/37A. Alt.	256346C11	②♠9350HD
Hose - By Pass		20338	Belt - Alt.; W/55A., 60A., 62A., 105A., 130A. Alt.		②♠9365HD
	or	28441	Belt - Alt. & Air Brake Compr.	243605R11	②♠♦9451HD
International/Navistar BG241			Belt - P.S.	164550R2	♠9425HD
1603			Hose - Upper - Eng. To Pipe		24228
Belt - Fan & Alt.; W/37A., 52A., 61A., 62A. Alt.	151532R1	②7512		or	26501
Belt - Fan & Alt.; W/60A. Alt.	861779R11	②♠9440HD	Hose - Upper - Pipe To Rad.		24236
Belt - Gen.; W/20A., 50A. Alt.	20594VA	TR24438	Hose - Lower		24942
Belt - Gen.; W/30A. Alt.	81572R2	TR28437	Hose - By Pass		≈20618
Belt - Gen.; W/35A., 50A. L.C.I. Gen.	164550R1	②♠9425HD		or	28442
Belt - P.S.; W/Air Brakes	149636R1	♠9480HD	Hose - Heater		24216
Belt - P.S.; W/Hyd. Brakes	864931R2	♠9319HD	International/Navistar RD372		
Belt - Air Brake Compr.; W/4 Cu. Ft. Air Brake Compr.	201825R1	♠9440HD	1823		
Belt - Air Brake Compr.; W/20A., 30A., 50A. Gen.	115505HA	TR22363	Belt - Fan & Alt.	359014C91	②TR22514
Hose - Upper		26510	Belt - W.P. & Alt.; W/37A. Alt.; Chassis No. FD61626 & Before	193826R11	②TR22508
Hose - Lower - Eng. To Pipe		26508	Belt - W.P. & Alt.; W/37A. Alt.; Chassis No. FD61626 & Up & G Chassis No.	223794R11	②TR22514
Hose - Lower - Pipe To Rad.		26514	Belt - W.P. & Alt.; W/60A. Alt.	243604R11	②TR22517
Hose - By Pass		20338	Belt - P.S.	240354R2	TR22336
	or	28441	Belt - Air Brake Compr.; W/Wagner Compr.	92836HA	TR32491
International/Navistar BG265			Belt - Air Brake Compr.; W/Westinghouse Compr.	83816HA	TR34467
1603			Hose - Upper		26515
Belt - Fan & Alt.; W/37A., 52A., 61A., 62A. Alt.	151532R1	②7512	Hose - Lower		24232
Belt - Fan & Alt.; W/60A. Alt.	861779R11	②♠9440HD	1853		
Belt - Gen.; W/20A., 50A. Alt.	20594VA	TR24438	Belt - Alt.; W/55A., 62A., 145A. Alt.	223794K21	②TR22514
Belt - Gen.; W/30A. Alt.	81572R2	TR28437	Belt - Gen.; W/37A. Gen.	193826R11	TR22508
Belt - Gen.; W/35A., 50A. L.C.I. Gen.	164550R1	②♠9425HD	Belt - P.S.	240354R1	TR22344
Belt - P.S.; W/Air Brakes	149636R1	♠9480HD	1853FC		
Belt - P.S.; W/Hyd. Brakes	864931R2	♠9319HD	Belt - Alt.; W/55A., 62A., 145A. Alt.	223794K21	②TR22514
Belt - Air Brake Compr.; W/4 Cu. Ft. Air Brake Compr.	201825R1	♠9440HD	Belt - Gen.; W/37A. Gen.	193826R11	TR22508
Belt - Air Brake Compr.; W/20A., 30A., 50A. Gen.	115505HA	TR22363	Belt - P.S.	240354R1	TR22344
Hose - Upper		26510	Hose - Upper; Late FD Chassis; Chassis No. FA66376 ...		26509
Hose - Lower - Eng. To Pipe		26508	Hose - Lower; Early FD Chassis; Chassis No. FA66376 ...		26508
Hose - Lower - Pipe To Rad.		26514	Hose - Lower; Late FD Chassis; Chassis No. FA66376 ...		24234
Hose - By Pass		20338		or	26508
	or	28441	International/Navistar RD406		
International/Navistar FTV549			1823		
193RE			Belt - Fan & Alt.	359014C91	②TR22514
Belt - Fan	358319C91	②♠♦9570HD	Belt - W.P. & Alt.; W/37A. Alt.; Chassis No. FD61626 & Before	193826R11	②TR22508

②Two Required.
 ♦PowerBand Belt May Work, Use Template to Check.

♠Standard Belt Available.
 ≈Cut to Fit.

Belts and Coolant Hose for School Buses

Application	Mfr. Part No.	Our No.	Application	Mfr. Part No.	Our No.
International/Navistar - Continued			International/Navistar - Continued		
1968 - Continued			1968 - Continued		
International/Navistar RD406 - Continued			International/Navistar RD501 - Continued		
1823 - Continued			1853FC - Continued		
Belt - Air Brake Compr.; W/Westinghouse Compr.	83816HA	TR34467	Hose - Upper; Late FD Chassis; Chassis No. FA66376		26509
Hose - Upper		26515	Hose - Lower; Early FD Chassis; Chassis No. FA66376 ..		26508
Hose - Lower		24232	Hose - Lower; Late FD Chassis; Chassis No. FA66376		24234
1853			or		26508
Belt - Alt.; W/55A., 62A., 145A. Alt.	223794K21	②TR22514	International/Navistar V266		
Belt - Gen.; W/37A. Gen.	193826R11	TR22508	1603; 1703 (School Bus); 1803		
Belt - P.S.	240354R1	TR22344	Belt - Fan & Alt.; W/37A., 52A., 61A. Alt.; C, G, H		
1853FC			Chassis		
Belt - Alt.; W/55A., 62A., 145A. Alt.	223794K21	②TR22514	Chassis		
Belt - Gen.; W/37A. Gen.	193826R11	TR22508	FD, SB Chassis		
Belt - P.S.	240354R1	TR22344	Belt - Fan & Alt.; W/55A., 62A. Alt.; C, G, H		
Hose - Upper; Late FD Chassis; Chassis No. FA66376		26509	Chassis		
Hose - Lower; Early FD Chassis; Chassis No. FA66376 ..		26508	Belt - Fan & Alt.; W/55A., 62A. Alt.; FD, SB		
Hose - Lower; Late FD Chassis; Chassis No. FA66376		24234	Chassis		
or		26508	Belt - P.S.; W/2WD		
International/Navistar RD450			Belt - P.S.; W/4WD		
1823			Belt - Air Brake Compr.		
Belt - Fan & Alt.	359014C91	②TR22514	Hose - Upper; W/Rad. Shutters; W/Metal Hood		
Belt - W.P. & Alt.; W/37A. Alt.; Chassis No. FD61626 & Before	193826R11	②TR22508	Hose - Upper; W/O Rad. Shutters; W/Metal Hood		
Belt - W.P. & Alt.; W/37A. Alt.; Chassis No. FD61626 & Up & G Chassis No.	223794R11	②TR22514	Hose - Lower - Eng. To Pipe; W/Auto. Trans.		
Belt - W.P. & Alt.; W/60A. Alt.	243604R11	②TR22517	Hose - Lower; W/Man. Trans.		
Belt - P.S.	240354R2	TR22336	Hose - By Pass		
Belt - Air Brake Compr.; W/Wagner Compr.	92836HA	TR32491	International/Navistar V304		
Belt - Air Brake Compr.; W/Westinghouse Compr.	83816HA	TR34467	1603; 1703 (School Bus); 1803		
Hose - Upper		26515	Belt - Fan & Alt.; W/37A., 52A., 61A. Alt.; C, G, H		
Hose - Lower		24232	Chassis		
1853			Belt - Fan & Alt.; W/37A., 52A., 61A. Alt.;		
Belt - Alt.; W/55A., 62A., 145A. Alt.	223794K21	②TR22514	FD, SB Chassis		
Belt - Gen.; W/37A. Gen.	193826R11	TR22508	Belt - Fan & Alt.; W/55A., 62A. Alt.; C, G, H		
Belt - P.S.	240354R1	TR22344	Chassis		
1853FC			Belt - Fan & Alt.; W/55A., 62A. Alt.; FD, SB		
Belt - Alt.; W/55A., 62A., 145A. Alt.	223794K21	②TR22514	Chassis		
Belt - Gen.; W/37A. Gen.	193826R11	TR22508	Belt - P.S.; W/2WD		
Belt - P.S.	240354R1	TR22344	Belt - P.S.; W/4WD		
Hose - Upper; Late FD Chassis; Chassis No. FA66376		26509	Belt - Air Brake Compr.		
Hose - Lower; Early FD Chassis; Chassis No. FA66376 ..		26508	Hose - Upper; W/Rad. Shutters; W/Metal Hood		
Hose - Lower; Late FD Chassis; Chassis No. FA66376		24234	Hose - Upper; W/O Rad. Shutters; W/Metal Hood		
or		26508	Hose - Lower - Eng. To Pipe; W/Auto. Trans.		
International/Navistar RD501			Hose - Lower; W/Man. Trans.		
1823			Hose - By Pass		
Belt - Fan & Alt.	359014C91	②TR22514	International/Navistar V345		
Belt - W.P. & Alt.; W/37A. Alt.; Chassis No. FD61626 & Before	193826R11	②TR22508	1603; 1703 (School Bus)		
Belt - W.P. & Alt.; W/37A. Alt.; Chassis No. FD61626 & Up & G Chassis No.	223794R11	②TR22514	Belt - Fan & Alt.; W/37A., 52A., 61A. Alt.;		
Belt - W.P. & Alt.; W/60A. Alt.	243604R11	②TR22517	C, G, H Chassis; W/P.T.O.		
Belt - P.S.	240354R2	TR22336	Belt - Fan & Alt.; W/37A., 52A., 61A. Alt.;		
Belt - Air Brake Compr.; W/Wagner Compr.	92836HA	TR32491	C, G, H Chassis; W/O P.T.O.		
Belt - Air Brake Compr.; W/Westinghouse Compr.	83816HA	TR34467	Belt - Fan & Alt.; W/37A., 52A., 61A. Alt.;		
Hose - Upper		26515	FD, SB Chassis		
Hose - Lower		24232	Belt - Fan & Alt.; W/37A., 61A. Alt.; W/O		
1853			Air Brakes; W/O P.T.O.; W/O X.C.		
Belt - Alt.; W/55A., 62A., 145A. Alt.	223794K21	②TR22514	Belt - Fan & Alt.; W/55A., 62A. Alt.; C, G, H		
Belt - Gen.; W/37A. Gen.	193826R11	TR22508	Chassis		
Belt - P.S.	240354R1	TR22344	Belt - Fan & Alt.; W/55A., 62A. Alt.; FD, SB		
1853FC			Chassis		
Belt - Alt.; W/55A., 62A., 145A. Alt.	223794K21	②TR22514	Belt - Fan & Alt.; W/60A. Alt.		
Belt - Gen.; W/37A. Gen.	193826R11	TR22508	Belt - Fan & Alt.; W/65A., 80A., 105A.,		
Belt - P.S.	240354R1	TR22344	145A. Alt.; W/P.T.O.		
			Belt - Fan & Alt.; W/65A., 80A., 105A., 145A. Alt.; W/O		
			P.T.O.		
			Belt - P.S.; W/2WD		
			Belt - P.S.; W/4WD		
			Belt - Air Brake Compr.		
			Belt - A.P.; W/Air Brakes; W/Gov.		
			Belt - A.P.; W/Air Brakes; W/O Gov.		
			Belt - A.P.; W/Hyd. Brakes; W/Gov.		

②Two Required.

≈Cut to Fit.

School Buses

Belts and Coolant Hose for School Buses

Application	Mfr. Part No.	Our No.	Application	Mfr. Part No.	Our No.
International/Navistar - Continued			International/Navistar - Continued		
1968 - Continued			1968 - Continued		
International/Navistar V345 - Continued			International/Navistar V345 - Continued		
1603; 1703 (School Bus) - Continued			1823 - Continued		
Belt - A.P.; W/Hyd. Brakes; W/O Gov.	362887C91	7410	Belt - Fan & Alt.; W/37A., 52A., 61A. Alt.; FD, SB Chassis	968815R1	②7650
Hose - Upper; W/Rad. Shutters; W/Metal Hood		26515	Belt - Fan & Alt.; W/37A., 61A. Alt.; W/O Air Brakes; W/O P.T.O.; W/O X.C.	373456C1	7612
Hose - Upper; W/O Rad. Shutters; W/Metal Hood		20493	Belt - Fan & Alt.; W/55A., 62A. Alt.; C, G, H Chassis	369723C91	②7630
Hose - Lower - Eng. To Pipe; W/Auto. Trans.		20532	Belt - Fan & Alt.; W/55A., 62A. Alt.; FD, SB Chassis	361975C91	②7673
Hose - Lower; W/Man. Trans.		21308	Belt - Fan & Alt.; W/60A. Alt.	359009C91	②7680
Hose - By Pass		≈<20357	Belt - Fan & Alt.; W/65A., 80A., 105A., 145A. Alt.; W/P.T.O.	361975C91	②7673
1723			Belt - Fan & Alt.; W/65A., 80A., 105A., 145A. Alt.; W/O P.T.O.		②7630
Belt - Fan & Alt.; W/37A., 52A., 61A. Alt.; C, G, H Chassis; W/P.T.O.	968815R11	②7650	Belt - P.S.; W/2WD		7460
Belt - Fan & Alt.; W/37A., 52A., 61A. Alt.; C, G, H Chassis; W/O P.T.O.	373457C91	②7612	Belt - P.S.; W/4WD	285522C2	7435
Belt - Fan & Alt.; W/37A., 52A., 61A. Alt.; FD, SB Chassis	968815R1	②7650	Belt - Air Brake Compr.	359007C91	7475
Belt - Fan & Alt.; W/37A., 61A. Alt.; W/O Air Brakes; W/O P.T.O.; W/O X.C.	373456C1	7612	Belt - A.P.; W/Air Brakes; W/Gov.	388139C1	7330
Belt - Fan & Alt.; W/55A., 62A. Alt.; C, G, H Chassis	369723C91	②7630	Belt - A.P.; W/Air Brakes; W/O Gov.	256062C2	7340
Belt - Fan & Alt.; W/55A., 62A. Alt.; FD, SB Chassis	361975C91	②7673	Belt - A.P.; W/Hyd. Brakes; W/Gov.	355653C91	7380
Belt - Fan & Alt.; W/60A. Alt.	359009C91	②7680	Belt - A.P.; W/Hyd. Brakes; W/O Gov.	362887C91	7410
Belt - Fan & Alt.; W/65A., 80A., 105A., 145A. Alt.; W/P.T.O.	361975C91	②7673	1803		
Belt - Fan & Alt.; W/65A., 80A., 105A., 145A. Alt.; W/O P.T.O.		②7630	Belt - Fan & Alt.; W/37A., 52A., 61A. Alt.; C, G, H Chassis; W/P.T.O.	968815R11	②7650
Belt - P.S.; W/2WD		7460	Belt - Fan & Alt.; W/37A., 52A., 61A. Alt.; C, G, H Chassis; W/O P.T.O.	373457C91	②7612
Belt - P.S.; W/4WD	285522C2	7435	Belt - Fan & Alt.; W/37A., 52A., 61A. Alt.; FD, SB Chassis	968815R1	②7650
Belt - Air Brake Compr.	359007C91	7475	Belt - Fan & Alt.; W/37A., 61A. Alt.; W/O Air Brakes; W/O P.T.O.; W/O X.C.	373456C1	7612
Belt - A.P.; W/Air Brakes; W/Gov.	388139C1	7330	Belt - Fan & Alt.; W/55A., 62A. Alt.; C, G, H Chassis	369723C91	②7630
Belt - A.P.; W/Air Brakes; W/O Gov.	256062C2	7340	Belt - Fan & Alt.; W/55A., 62A. Alt.; FD, SB Chassis	361975C91	②7673
Belt - A.P.; W/Hyd. Brakes; W/Gov.	355653C91	7380	Belt - Fan & Alt.; W/60A. Alt.	359009C91	②7680
Belt - A.P.; W/Hyd. Brakes; W/O Gov.	362887C91	7410	Belt - Fan & Alt.; W/65A., 80A., 105A., 145A. Alt.; W/P.T.O.	361975C91	②7673
Belt - Fan & Alt.; W/37A., 52A., 61A. Alt.; C, G, H Chassis; W/P.T.O.	968815R11	②7650	Belt - Fan & Alt.; W/65A., 80A., 105A., 145A. Alt.; W/O P.T.O.		②7630
Belt - Fan & Alt.; W/37A., 52A., 61A. Alt.; C, G, H Chassis; W/O P.T.O.	373457C91	②7612	Belt - P.S.; W/2WD		7460
Belt - Fan & Alt.; W/37A., 52A., 61A. Alt.; FD, SB Chassis	968815R1	②7650	Belt - P.S.; W/4WD	285522C2	7435
Belt - Fan & Alt.; W/37A., 61A. Alt.; W/O Air Brakes; W/O P.T.O.; W/O X.C.	373456C1	7612	Belt - Air Brake Compr.	359007C91	7475
Belt - Fan & Alt.; W/55A., 62A. Alt.; C, G, H Chassis	369723C91	②7630	Belt - A.P.; W/Air Brakes; W/Gov.	388139C1	7330
Belt - Fan & Alt.; W/55A., 62A. Alt.; FD, SB Chassis	361975C91	②7673	Belt - A.P.; W/Air Brakes; W/O Gov.	256062C2	7340
Belt - Fan & Alt.; W/60A. Alt.	359009C91	②7680	Belt - A.P.; W/Hyd. Brakes; W/Gov.	355653C91	7380
Belt - Fan & Alt.; W/65A., 80A., 105A., 145A. Alt.; W/P.T.O.	361975C91	②7673	Belt - A.P.; W/Hyd. Brakes; W/O Gov.	362887C91	7410
Belt - Fan & Alt.; W/65A., 80A., 105A., 145A. Alt.; W/O P.T.O.		②7630	Hose - Upper; W/Rad. Shutters; W/Metal Hood		26515
Belt - P.S.; W/2WD		7460	Hose - Upper; W/O Rad. Shutters; W/Metal Hood		20493
Belt - P.S.; W/4WD	285522C2	7435	Hose - Lower - Eng. To Pipe; W/Auto. Trans.		20532
Belt - Air Brake Compr.	359007C91	7475	Hose - Lower; W/Man. Trans.		21308
Belt - A.P.; W/Air Brakes; W/Gov.	388139C1	7330	Hose - By Pass		≈<20357
Belt - A.P.; W/Air Brakes; W/O Gov.	256062C2	7340	1723		
Belt - A.P.; W/Hyd. Brakes; W/Gov.	355653C91	7380	Belt - Fan & Alt.; W/37A., 52A., 61A. Alt.; C, G, H Chassis; W/P.T.O.	968815R11	②7650
Belt - A.P.; W/Hyd. Brakes; W/O Gov.	362887C91	7410	Belt - Fan & Alt.; W/37A., 52A., 61A. Alt.; C, G, H Chassis; W/O P.T.O.	373457C91	②7612
Hose - Upper; W/Rad. Shutters; W/Metal Hood		26515	Belt - Fan & Alt.; W/37A., 52A., 61A. Alt.; FD, SB Chassis	968815R1	②7650
Hose - Upper; W/O Rad. Shutters; W/Metal Hood		20493	Belt - Fan & Alt.; W/37A., 61A. Alt.; W/O Air Brakes; W/O P.T.O.; W/O X.C.	373456C1	7612
Hose - Lower - Eng. To Pipe; W/Auto. Trans.		20532	Belt - Fan & Alt.; W/55A., 62A. Alt.; C, G, H Chassis	369723C91	②7630
Hose - Lower; W/Man. Trans.		21308	Belt - Fan & Alt.; W/55A., 62A. Alt.; FD, SB Chassis	361975C91	②7673
Hose - By Pass		≈<20357	Belt - Fan & Alt.; W/60A. Alt.	359009C91	②7680
1823			Belt - Fan & Alt.; W/65A., 80A., 105A., 145A. Alt.; W/P.T.O.	361975C91	②7673
Belt - Fan & Alt.; W/37A., 52A., 61A. Alt.; C, G, H Chassis; W/P.T.O.	968815R11	②7650			
Belt - Fan & Alt.; W/37A., 52A., 61A. Alt.; C, G, H Chassis; W/O P.T.O.	373457C91	②7612			

School Buses

≈<Cut to Fit.

②Two Required.

Belts and Coolant Hose for School Buses

School Buses

Application	Mfr. Part No.	Our No.	Application	Mfr. Part No.	Our No.
International/Navistar - Continued			International/Navistar - Continued		
1968 - Continued			1968 - Continued		
International/Navistar V392 - Continued			International/Navistar V401		
1723 - Continued			193RE		
Belt - Fan & Alt.; W/65A., 80A., 105A., 145A. Alt.; W/O P.T.O.		②7630	Belt - Fan	358319C91	②◆◆9570HD
Belt - P.S.; W/2WD		7460	Belt - W.P.	359021C91	②TR22434
Belt - P.S.; W/4WD	285522C2	7435	Belt - Alt.; W/37A. Alt.	256346C11	②◆9350HD
Belt - Air Brake Compr.	359007C91	7475	Belt - Alt.; W/55A., 60A., 62A., 105A., 130A. Alt.		②◆9365HD
Belt - A.P.; W/Air Brakes; W/Gov.	388139C1	7330	Belt - Alt. & Air Brake Compr.	243605R11	②◆◆9451HD
Belt - A.P.; W/Air Brakes; W/O Gov.	256062C2	7340	Belt - P.S.	164550R2	◆9425HD
Belt - A.P.; W/Hyd. Brakes; W/Gov.	355653C91	7380	Hose - Upper - Eng. To Pipe		24228
Belt - A.P.; W/Hyd. Brakes; W/O Gov.	362887C91	7410		or	26501
1803			Hose - Upper - Pipe To Rad.		24236
Belt - Fan & Alt.; W/37A., 52A., 61A. Alt.; C, G, H Chassis; W/P.T.O.	968815R11	②7650	Hose - Lower		24942
Belt - Fan & Alt.; W/37A., 52A., 61A. Alt.; C, G, H Chassis; W/O P.T.O.	373457C91	②7612	Hose - By Pass		②<20618
Belt - Fan & Alt.; W/37A., 52A., 61A. Alt.; FD, SB Chassis	968815R1	②7650		or	28442
Belt - Fan & Alt.; W/37A., 61A. Alt.; W/O Air Brakes; W/O P.T.O.; W/O X.C.	373456C1	7612	Hose - Heater		24216
Belt - Fan & Alt.; W/55A., 62A. Alt.; C, G, H Chassis	369723C91	②7630	International/Navistar V461		
Belt - Fan & Alt.; W/55A., 62A. Alt.; FD, SB Chassis	361975C91	②7673	193RE		
Belt - Fan & Alt.; W/60A. Alt.	359009C91	②7680	Belt - Fan	358319C91	②◆◆9570HD
Belt - Fan & Alt.; W/65A., 80A., 105A., 145A. Alt.; W/P.T.O.	361975C91	②7673	Belt - W.P.	359021C91	②TR22434
Belt - Fan & Alt.; W/65A., 80A., 105A., 145A. Alt.; W/O P.T.O.		②7630	Belt - Alt.; W/37A. Alt.	256346C11	②◆9350HD
Belt - P.S.; W/2WD		7460	Belt - Alt.; W/55A., 60A., 62A., 105A., 130A. Alt.		②◆9365HD
Belt - P.S.; W/4WD	285522C2	7435	Belt - Alt. & Air Brake Compr.	243605R11	②◆◆9451HD
Belt - Air Brake Compr.	359007C91	7475	Belt - P.S.	164550R2	◆9425HD
Belt - A.P.; W/Air Brakes; W/Gov.	388139C1	7330	Hose - Upper - Eng. To Pipe		24228
Belt - A.P.; W/Air Brakes; W/O Gov.	256062C2	7340		or	26501
Belt - A.P.; W/Hyd. Brakes; W/Gov.	355653C91	7380	Hose - Upper - Pipe To Rad.		24236
Belt - A.P.; W/Hyd. Brakes; W/O Gov.	362887C91	7410	Hose - Lower		24942
Hose - Upper; W/Rad. Shutters; W/Metal Hood		26515	Hose - By Pass		②<20618
Hose - Upper; W/O Rad. Shutters; W/Metal Hood		20493		or	28442
Hose - Lower - Eng. To Pipe; W/Auto. Trans.		20532	Hose - Heater		24216
Hose - Lower; W/Man. Trans.		21308	International/Navistar V478		
Hose - By Pass		②<20357	193RE		
1823			Belt - Fan	358319C91	②◆◆9570HD
Belt - Fan & Alt.; W/37A., 52A., 61A. Alt.; C, G, H Chassis; W/P.T.O.	968815R11	②7650	Belt - W.P.	359021C91	②TR22434
Belt - Fan & Alt.; W/37A., 52A., 61A. Alt.; C, G, H Chassis; W/O P.T.O.	373457C91	②7612	Belt - Alt.; W/37A. Alt.	256346C11	②◆9350HD
Belt - Fan & Alt.; W/37A., 52A., 61A. Alt.; FD, SB Chassis	968815R1	②7650	Belt - Alt.; W/55A., 60A., 62A., 105A., 130A. Alt.		②◆9365HD
Belt - Fan & Alt.; W/37A., 61A. Alt.; W/O Air Brakes; W/O P.T.O.; W/O X.C.	373456C1	7612	Belt - Alt. & Air Brake Compr.	243605R11	②◆◆9451HD
Belt - Fan & Alt.; W/55A., 62A. Alt.; C, G, H Chassis	369723C91	②7630	Belt - P.S.	164550R2	◆9425HD
Belt - Fan & Alt.; W/55A., 62A. Alt.; FD, SB Chassis	361975C91	②7673	Hose - Upper - Eng. To Pipe		24228
Belt - Fan & Alt.; W/60A. Alt.	359009C91	②7680		or	26501
Belt - Fan & Alt.; W/65A., 80A., 105A., 145A. Alt.; W/P.T.O.	361975C91	②7673	Hose - Upper - Pipe To Rad.		24236
Belt - Fan & Alt.; W/65A., 80A., 105A., 145A. Alt.; W/O P.T.O.		②7630	Hose - Lower		24942
Belt - P.S.; W/2WD		7460	Hose - By Pass		②<20618
Belt - P.S.; W/4WD	285522C2	7435		or	28442
Belt - Air Brake Compr.	359007C91	7475	Hose - Heater		24216
Belt - A.P.; W/Air Brakes; W/Gov.	388139C1	7330	International/Navistar V549		
Belt - A.P.; W/Air Brakes; W/O Gov.	256062C2	7340	193RE		
Belt - A.P.; W/Hyd. Brakes; W/Gov.	355653C91	7380	Belt - Fan	358319C91	②◆◆9570HD
Belt - A.P.; W/Hyd. Brakes; W/O Gov.	362887C91	7410	Belt - W.P.	359021C91	②TR22434
			Belt - Alt.; W/37A. Alt.	256346C11	②◆9350HD
			Belt - Alt.; W/55A., 60A., 62A., 105A., 130A. Alt.		②◆9365HD
			Belt - Alt. & Air Brake Compr.	243605R11	②◆◆9451HD
			Belt - P.S.	164550R2	◆9425HD
			Hose - Upper - Eng. To Pipe		24228
				or	26501
			Hose - Upper - Pipe To Rad.		24236
			Hose - Lower		24942
			Hose - By Pass		②<20618
				or	28442
			Hose - Heater		24216
			International/Navistar VS401		
			193RE		
			Belt - Fan	358319C91	②◆◆9570HD
			Belt - W.P.	359021C91	②TR22434

②Two Required.
◆Standard Belt Available.

②Cut to Fit.
◆PowerBand Belt May Work, Use Template to Check.

Belts and Coolant Hose for School Buses

Application	Mfr. Part No.	Our No.	Application	Mfr. Part No.	Our No.
International/Navistar - Continued			International/Navistar - Continued		
1968 - Continued			1967 - 1966 - Continued		
International/Navistar VS401 - Continued			International/Navistar BD240		
193RE - Continued			1603		
Belt - Alt.; W/37A. Alt.	256346C11	②♠9350HD	Belt - Fan & Alt.; W/37A., 52A., 61A., 62A. Alt.	151532R1	②7512
Belt - Alt.; W/55A., 60A., 62A., 105A., 130A. Alt.		②♠9365HD	Belt - Fan & Alt.; W/60A. Alt.	861779R11	②♠9440HD
Belt - Alt. & Air Brake Compr.	243605R11	②♠9451HD	Belt - Gen.; W/20A., 50A. Alt.	20594VA	TR24438
Belt - P.S.	164550R2	♠9425HD	Belt - Gen.; W/30A. Alt.	81572R2	TR28437
Hose - Upper - Eng. To Pipe		24228	Belt - Gen.; W/35A., 50A. L.C.I. Gen.	164550R1	②♠9425HD
	or	26501	Belt - P.S.; W/Air Brakes	149636R1	♠9480HD
Hose - Upper - Pipe To Rad.		24236	Belt - P.S.; W/Hyd. Brakes	864931R2	♠9319HD
Hose - Lower		24942	Belt - Air Brake Compr.; W/4 Cu. Ft. Air Brake Compr.	201825R1	♠9440HD
Hose - By Pass		≠20618	Belt - Air Brake Compr.; W/20A., 30A., 50A. Gen.	115505HA	TR22363
	or	28442	Hose - Upper		26510
Hose - Heater		24216	Hose - Lower - Eng. To Pipe		26508
International/Navistar VS478			International/Navistar BD264		
193RE			1603		
Belt - Fan	358319C91	②♠9570HD	Belt - Fan & Alt.; W/37A., 52A., 61A., 62A. Alt.	151532R1	②7512
Belt - W.P.	359021C91	②TR22434	Belt - Fan & Alt.; W/60A. Alt.	861779R11	②♠9440HD
Belt - Alt.; W/37A. Alt.	256346C11	②♠9350HD	Belt - Gen.; W/20A., 50A. Alt.	20594VA	TR24438
Belt - Alt.; W/55A., 60A., 62A., 105A., 130A. Alt.		②♠9365HD	Belt - Gen.; W/30A. Alt.	81572R2	TR28437
Belt - Alt. & Air Brake Compr.	243605R11	②♠9451HD	Belt - Gen.; W/35A., 50A. L.C.I. Gen.	164550R1	②♠9425HD
Belt - P.S.	164550R2	♠9425HD	Belt - P.S.; W/Air Brakes	149636R1	♠9480HD
Hose - Upper - Eng. To Pipe		24228	Belt - P.S.; W/Hyd. Brakes	864931R2	♠9319HD
	or	26501	Belt - Air Brake Compr.; W/4 Cu. Ft. Air Brake Compr.	201825R1	♠9440HD
Hose - Upper - Pipe To Rad.		24236	Belt - Air Brake Compr.; W/20A., 30A., 50A. Gen.	115505HA	TR22363
Hose - Lower		24942	Hose - Upper		26510
Hose - By Pass		≠20618	Hose - Lower - Eng. To Pipe		26508
	or	28442	Hose - Lower - Pipe To Rad.		26514
Hose - Heater		24216	Hose - By Pass		20338
International/Navistar VS549			International/Navistar BD269		
193RE			1603		
Belt - Fan	358319C91	②♠9570HD	Belt - Fan & Alt.	862880R11	②♠9490HD
Belt - W.P.	359021C91	②TR22434	Belt - P.S.	242269R1	♠9405HD
Belt - Alt.; W/37A. Alt.	256346C11	②♠9350HD	Belt - Air Brake Compr.	280210C1	♠9540HD
Belt - Alt.; W/55A., 60A., 62A., 105A., 130A. Alt.		②♠9365HD	Hose - Upper		24232
Belt - Alt. & Air Brake Compr.	243605R11	②♠9451HD	Hose - Lower		≠20611
Belt - P.S.	164550R2	♠9425HD		or	26509
Hose - Upper - Eng. To Pipe		24228	Hose - By Pass		24232
	or	26501	International/Navistar BD282		
Hose - Upper - Pipe To Rad.		24236	1603		
Hose - Lower		24942	Belt - Fan & Alt.		
Hose - By Pass		≠20618	Belt - P.S.		
	or	28442	Belt - Air Brake Compr.		
Hose - Heater		24216	Hose - Upper		
1967 - 1966			1703 (School Bus); 1803		
International/Navistar BD220			Belt - Fan & Alt.		
1603			Belt - P.S.		
Belt - Fan & Alt.; W/37A., 52A., 61A., 62A. Alt.	151532R1	②7512	Belt - Air Brake Compr.		
Belt - Fan & Alt.; W/60A. Alt.	861779R11	②♠9440HD	Hose - Upper		
Belt - Gen.; W/20A., 50A. Alt.	20594VA	TR24438	Hose - Lower - Eng. To Pipe		
Belt - Gen.; W/30A. Alt.	81572R2	TR28437	Hose - Lower - Pipe To Rad.		
Belt - Gen.; W/35A., 50A. L.C.I. Gen.	164550R1	②♠9425HD	Hose - By Pass		
Belt - P.S.; W/Air Brakes	149636R1	♠9480HD	Belt - Fan & Alt.		
Belt - P.S.; W/Hyd. Brakes	864931R2	♠9319HD	Belt - P.S.		
Belt - Air Brake Compr.; W/4 Cu. Ft. Air Brake Compr.	201825R1	♠9440HD	Belt - Air Brake Compr.		
Belt - Air Brake Compr.; W/20A., 30A., 50A. Gen.	115505HA	TR22363	Hose - Upper		
Hose - Upper		26510	Hose - Lower		
Hose - Lower - Eng. To Pipe		26508	Hose - Lower		
Hose - Lower - Pipe To Rad.		26514	Hose - Lower		
Hose - By Pass		20338	Hose - Lower		
	or	28441	Hose - Lower		
International/Navistar BD240			Hose - By Pass		
193RE			1703 (School Bus); 1803		
Belt - Fan	358319C91	②♠9570HD	Belt - Fan & Alt.		
Belt - W.P.	359021C91	②TR22434	Belt - P.S.		
Belt - Alt.; W/37A. Alt.	256346C11	②♠9350HD	Belt - Air Brake Compr.		
Belt - Alt.; W/55A., 60A., 62A., 105A., 130A. Alt.		②♠9365HD	Hose - Upper		
Belt - Alt. & Air Brake Compr.	243605R11	②♠9451HD	Hose - Lower - Eng. To Pipe		
Belt - P.S.	164550R2	♠9425HD	Hose - Lower - Pipe To Rad.		
Hose - Upper - Eng. To Pipe		24228	Hose - By Pass		
	or	26501	Belt - Fan & Alt.		
Hose - Upper - Pipe To Rad.		24236	Belt - P.S.		
Hose - Lower		24942	Belt - Air Brake Compr.		
Hose - By Pass		≠20618	Hose - Upper		
	or	28442	Hose - Lower		
Hose - Heater		24216	Hose - Lower		
International/Navistar BD264			Hose - Lower		
193RE			Hose - Lower		
Belt - Fan	358319C91	②♠9570HD	Hose - Lower		
Belt - W.P.	359021C91	②TR22434	Hose - Lower		
Belt - Alt.; W/37A. Alt.	256346C11	②♠9350HD	Hose - Lower		
Belt - Alt.; W/55A., 60A., 62A., 105A., 130A. Alt.		②♠9365HD	Hose - Lower		
Belt - Alt. & Air Brake Compr.	243605R11	②♠9451HD	Hose - Lower		
Belt - P.S.	164550R2	♠9425HD	Hose - Lower		
Hose - Upper - Eng. To Pipe		24228	Hose - Lower		
	or	26501	Hose - Lower		
Hose - Upper - Pipe To Rad.		24236	Hose - Lower		
Hose - Lower		24942	Hose - Lower		
Hose - By Pass		≠20618	Hose - Lower		
	or	28442	Hose - Lower		
Hose - Heater		24216	Hose - Lower		

♠Standard Belt Available.
 ♦PowerBand Belt May Work, Use Template to Check.

②Two Required.
 ≠Cut to Fit.

Belts and Coolant Hose for School Buses

School Buses

Application	Mfr. Part No.	Our No.	Application	Mfr. Part No.	Our No.
International/Navistar - Continued			International/Navistar - Continued		
1967 - 1966 - Continued			1967 - 1966 - Continued		
International/Navistar BD282 - Continued			International/Navistar BG265		
1703 (School Bus); 1803 - Continued			1603		
Belt - P.S.	242269R1	♣9405HD	Belt - Fan & Alt.; W/37A., 52A., 61A., 62A. Alt.	151532R1	②7512
Belt - Air Brake Compr.	280210C1	♣9540HD	Belt - Fan & Alt.; W/60A. Alt.	861779R11	②♣9440HD
Hose - Upper		24232	Belt - Gen.; W/20A., 50A. Alt.	20594VA	TR24438
Hose - Lower - Eng. To Pipe		♣20206	Belt - Gen.; W/30A. Alt.	81572R2	TR28437
Hose - Lower - Pipe To Rad.		24232	Belt - Gen.; W/35A., 50A. L.C.I. Gen.	164550R1	②♣9425HD
Hose - By Pass		24232	Belt - P.S.; W/Air Brakes	149636R1	♣9480HD
International/Navistar BD308			Belt - P.S.; W/Hyd. Brakes	864931R2	♣9319HD
1603			Belt - Air Brake Compr.; W/4 Cu. Ft. Air Brake Compr.	201825R1	♣9440HD
Belt - Fan & Alt.	862880R11	②♣9490HD	Belt - Air Brake Compr.; W/20A., 30A., 50A. Gen.	115505HA	TR22363
Belt - P.S.	242269R1	♣9405HD	Hose - Upper		26510
Belt - Air Brake Compr.	280210C1	♣9540HD	Hose - Lower - Eng. To Pipe		26508
Hose - Upper		24232	Hose - Lower - Pipe To Rad.		26514
Hose - Lower		♣20611	Hose - By Pass		20338
		26509			28441
		or			
Hose - By Pass		24232	International/Navistar FTV549		
1703 (School Bus); 1803			193RE		
Belt - Fan & Alt.	862880R11	②♣9490HD	Belt - Fan; W/52 5/8" Belt O.C.	680611R11	②♣♣9520HD
Belt - P.S.	242269R1	♣9405HD	Belt - Fan; W/57 5/8" Belt O.C.	261710C11	♣9570HD
Belt - Air Brake Compr.	280210C1	♣9540HD	Belt - Alt. To Compr.; W/37A., 60A. Alt.	243605R11	♣9451HD
Hose - Upper		24232	Belt - Alt. To Compr.; W/55A. Alt.	264975C11	♣9455HD
Hose - Lower - Eng. To Pipe		♣20206	Belt - Gen. To Compr.; W/30A. Gen.	133758R1	♣9440HD
Hose - Lower - Pipe To Rad.		24232	Belt - Gen. To Compr.; W/35A. Gen.	150560R11	♣9451HD
Hose - By Pass		24232	Belt - Gen. To Compr.; W/50A. Gen.	201825R11	♣9435HD
International/Navistar BG220			Belt - Gen.; W/Hyd. Brakes	133732R1	♣9360HD
1603			Belt - P.S.; W/43 1/8" Belt O.C.	164550R11	♣9425HD
Belt - Fan & Alt.; W/37A., 52A., 61A., 62A. Alt.	151532R1	②7512	Belt - P.S.; W/44 5/8" Belt O.C.	133758R1	♣9440HD
Belt - Fan & Alt.; W/60A. Alt.	861779R11	②♣9440HD	Belt - Idler; W/56 1/8" Belt O.C.	968645R11	♣9555HD
Belt - Gen.; W/20A., 50A. Alt.	20594VA	TR24438	Belt - Idler; W/57 5/8" Belt O.C.	261710C11	♣9570HD
Belt - Gen.; W/30A. Alt.	81572R2	TR28437	International/Navistar FTVS549		
Belt - Gen.; W/35A., 50A. L.C.I. Gen.	164550R1	②♣9425HD	193RE		
Belt - P.S.; W/Air Brakes	149636R1	♣9480HD	Belt - Fan; W/52 5/8" Belt O.C.	680611R11	②♣♣9520HD
Belt - P.S.; W/Hyd. Brakes	864931R2	♣9319HD	Belt - Fan; W/57 5/8" Belt O.C.	261710C11	♣9570HD
Belt - Air Brake Compr.; W/4 Cu. Ft. Air Brake Compr.	201825R1	♣9440HD	Belt - Alt. To Compr.; W/37A., 60A. Alt.	243605R11	♣9451HD
Belt - Air Brake Compr.; W/20A., 30A., 50A. Gen.	115505HA	TR22363	Belt - Alt. To Compr.; W/55A. Alt.	264975C11	♣9455HD
Hose - Upper		26510	Belt - Gen. To Compr.; W/30A. Gen.	133758R1	♣9440HD
Hose - Lower - Eng. To Pipe		26508	Belt - Gen. To Compr.; W/35A. Gen.	150560R11	♣9451HD
Hose - Lower - Pipe To Rad.		26514	Belt - Gen. To Compr.; W/50A. Gen.	201825R11	♣9435HD
Hose - By Pass		20338	Belt - Gen.; W/Hyd. Brakes	133732R1	♣9360HD
		or	Belt - P.S.; W/43 1/8" Belt O.C.	164550R11	♣9425HD
		28441	Belt - P.S.; W/44 5/8" Belt O.C.	133758R1	♣9440HD
International/Navistar BG241			Belt - Idler; W/56 1/8" Belt O.C.	968645R11	♣9555HD
1603			Belt - Idler; W/57 5/8" Belt O.C.	261710C11	♣9570HD
Belt - Fan & Alt.; W/37A., 52A., 61A., 62A. Alt.	151532R1	②7512	International/Navistar RD372		
Belt - Fan & Alt.; W/60A. Alt.	861779R11	②♣9440HD	1823		
Belt - Gen.; W/20A., 50A. Alt.	20594VA	TR24438	Belt - Fan & Alt.	359014C91	②TR22514
Belt - Gen.; W/30A. Alt.	81572R2	TR28437	Belt - W.P. & Alt.; W/37A. Alt.; Chassis No. FD61626 & Before	193826R11	②TR22508
Belt - Gen.; W/35A., 50A. L.C.I. Gen.	164550R1	②♣9425HD	Belt - W.P. & Alt.; W/37A. Alt.; Chassis No. FD61626 & Up & G Chassis No.	223794R11	②TR22514
Belt - P.S.; W/Air Brakes	149636R1	♣9480HD	Belt - W.P. & Alt.; W/60A. Alt.	243604R11	②TR22517
Belt - P.S.; W/Hyd. Brakes	864931R2	♣9319HD	Belt - P.S.	240354R2	TR22336
Belt - Air Brake Compr.; W/4 Cu. Ft. Air Brake Compr.	201825R1	♣9440HD	Belt - Air Brake Compr.; W/Wagner Compr.	92836HA	TR32491
Belt - Air Brake Compr.; W/20A., 30A., 50A. Gen.	115505HA	TR22363	Belt - Air Brake Compr.; W/Westinghouse Compr.	83816HA	TR34467
Hose - Upper		26510	Hose - Upper		26515
Hose - Lower - Eng. To Pipe		26508	Hose - Lower		24232
Hose - Lower - Pipe To Rad.		26514	1853		
Hose - By Pass		20338	Belt - Alt.; W/55A., 62A., 145A. Alt.	223794K21	②TR22514
		or	Belt - Gen.; W/37A. Gen.	193826R11	TR22508
		28441	Belt - P.S.	240354R1	TR22344

♣Standard Belt Available.
②Two Required.

♣Cut to Fit.
◆PowerBand Belt May Work, Use Template to Check.

Belts and Coolant Hose for School Buses

Application	Mfr. Part No.	Our No.	Application	Mfr. Part No.	Our No.
International/Navistar - Continued			International/Navistar - Continued		
1967 - 1966 - Continued			1967 - 1966 - Continued		
International/Navistar RD372 - Continued			International/Navistar RD501 - Continued		
1853FC			1823 - Continued		
Belt - Alt.; W/55A., 62A., 145A. Alt.	223794K21	②TR22514	Belt - W.P. & Alt.; W/37A. Alt.; Chassis No. FD61626 & Up & G Chassis No.	223794R11	②TR22514
Belt - Gen.; W/37A. Gen.	193826R11	TR22508	Belt - W.P. & Alt.; W/60A. Alt.	243604R11	②TR22517
Belt - P.S.	240354R1	TR22344	Belt - P.S.	240354R2	TR22336
Hose - Upper; Late FD Chassis; Chassis No. FA66376		26509	Belt - Air Brake Compr.; W/Wagner Compr. .92836HA		TR32491
Hose - Lower; Early FD Chassis; Chassis No. FA66376 ..		26508	Belt - Air Brake Compr.; W/Westinghouse Compr.	83816HA	TR34467
Hose - Lower; Late FD Chassis; Chassis No. FA66376		24234	Hose - Upper		26515
		26508	Hose - Lower		24232
			1853		
International/Navistar RD406			1853FC		
1823			Belt - Alt.; W/55A., 62A., 145A. Alt.		
Belt - Fan & Alt.	359014C91	②TR22514	Belt - Gen.; W/37A. Gen.	193826R11	TR22508
Belt - W.P. & Alt.; W/37A. Alt.; Chassis No. FD61626 & Before	193826R11	②TR22508	Belt - P.S.	240354R1	TR22344
Belt - W.P. & Alt.; W/37A. Alt.; Chassis No. FD61626 & Up & G Chassis No.	223794R11	②TR22514	International/Navistar V266		
Belt - W.P. & Alt.; W/60A. Alt.	243604R11	②TR22517	1603; 1703 (School Bus); 1803		
Belt - P.S.	240354R2	TR22336	Belt - Fan & Alt.; W/37A., 52A., 61A. Alt.; C, G, H Chassis		
Belt - Air Brake Compr.; W/Wagner Compr. .92836HA		TR32491			
Belt - Air Brake Compr.; W/Westinghouse Compr.	83816HA	TR34467	Belt - Fan & Alt.; W/37A., 52A., 61A. Alt.; FD, SB Chassis		
Hose - Upper		26515	Belt - Fan & Alt.; W/55A., 62A. Alt.; C, G, H Chassis		
Hose - Lower		24232	Belt - Fan & Alt.; W/55A., 62A. Alt.; FD, SB Chassis		
1853			Belt - P.S.; W/2WD		
Belt - Alt.; W/55A., 62A., 145A. Alt.	223794K21	②TR22514	Belt - P.S.; W/4WD		
Belt - Gen.; W/37A. Gen.	193826R11	TR22508	Belt - Air Brake Compr.		
Belt - P.S.	240354R1	TR22344	Hose - Upper; W/Rad. Shutters; W/Metal Hood		
Hose - Upper; Late FD Chassis; Chassis No. FA66376		26509	Hose - Upper; W/O Rad. Shutters; W/Metal Hood		
Hose - Lower; Early FD Chassis; Chassis No. FA66376 ..		26508	Hose - Lower - Eng. To Pipe; W/Auto. Trans.		
Hose - Lower; Late FD Chassis; Chassis No. FA66376		24234	Hose - Lower; W/Man. Trans.		
		26508	Hose - By Pass		
			②<20357		
International/Navistar RD450			International/Navistar V304		
1823			1603; 1703 (School Bus); 1803		
Belt - Fan & Alt.	359014C91	②TR22514	Belt - Fan & Alt.; W/37A., 52A., 61A. Alt.; C, G, H Chassis		
Belt - W.P. & Alt.; W/37A. Alt.; Chassis No. FD61626 & Before	193826R11	②TR22508	Belt - Fan & Alt.; W/37A., 52A., 61A. Alt.; FD, SB Chassis		
Belt - W.P. & Alt.; W/37A. Alt.; Chassis No. FD61626 & Up & G Chassis No.	223794R11	②TR22514	Belt - Fan & Alt.; W/55A., 62A. Alt.; C, G, H Chassis		
Belt - W.P. & Alt.; W/60A. Alt.	243604R11	②TR22517	Belt - Fan & Alt.; W/55A., 62A. Alt.; FD, SB Chassis		
Belt - P.S.	240354R2	TR22336	Belt - P.S.; W/2WD		
Belt - Air Brake Compr.; W/Wagner Compr. .92836HA		TR32491	Belt - P.S.; W/4WD		
Belt - Air Brake Compr.; W/Westinghouse Compr.	83816HA	TR34467	Belt - Air Brake Compr.		
Hose - Upper		26515	Hose - Upper; W/Rad. Shutters; W/Metal Hood		
Hose - Lower		24232	Hose - Upper; W/O Rad. Shutters; W/Metal Hood		
1853			Hose - Lower - Eng. To Pipe; W/Auto. Trans.		
Belt - Alt.; W/55A., 62A., 145A. Alt.	223794K21	②TR22514	Hose - Lower; W/Man. Trans.		
Belt - Gen.; W/37A. Gen.	193826R11	TR22508	Hose - By Pass		
Belt - P.S.	240354R1	TR22344	②<20357		
Hose - Upper; Late FD Chassis; Chassis No. FA66376		26509	International/Navistar V345		
Hose - Lower; Early FD Chassis; Chassis No. FA66376 ..		26508	1603; 1703 (School Bus)		
Hose - Lower; Late FD Chassis; Chassis No. FA66376		24234	Belt - Fan & Alt.; W/37A., 52A., 61A. Alt.; C, G, H Chassis; W/P.T.O.		
		26508	Belt - Fan & Alt.; W/37A., 52A., 61A. Alt.; C, G, H Chassis; W/O P.T.O.		
			②7603		
International/Navistar RD501			②7640		
1823			②7619		
Belt - Fan & Alt.	359014C91	②TR22514	②7650		
Belt - W.P. & Alt.; W/37A. Alt.; Chassis No. FD61626 & Before	193826R11	②TR22508	7440		
			7450		
			7460		
			26515		
			20493		
			20532		
			21308		
			②<20357		

②Two Required.

②<Cut to Fit.

School Buses

Belts and Coolant Hose for School Buses

Application	Mfr. Part No.	Our No.	Application	Mfr. Part No.	Our No.
International/Navistar - Continued			International/Navistar - Continued		
1967 - 1966 - Continued			1967 - 1966 - Continued		
International/Navistar V345 - Continued			International/Navistar V345 - Continued		
1603; 1703 (School Bus) - Continued			1803 - Continued		
Belt - Fan & Alt.; W/37A., 52A., 61A. Alt.; FD, SB Chassis	968815R1	@7650	Belt - Fan & Alt.; W/55A., 62A. Alt.; C, G, H Chassis	369723C91	@7630
Belt - Fan & Alt.; W/37A., 61A. Alt.; W/O Air Brakes; W/O P.T.O.; W/O X.C.	373456C1	7612	Belt - Fan & Alt.; W/55A., 62A. Alt.; FD, SB Chassis	361975C91	@7673
Belt - Fan & Alt.; W/55A., 62A. Alt.; C, G, H Chassis	369723C91	@7630	Belt - Fan & Alt.; W/60A. Alt.	359009C91	@7680
Belt - Fan & Alt.; W/55A., 62A. Alt.; FD, SB Chassis	361975C91	@7673	Belt - Fan & Alt.; W/65A., 80A., 105A., 145A. Alt; W/P.T.O.	361975C91	@7673
Belt - Fan & Alt.; W/60A. Alt.	359009C91	@7680	Belt - Fan & Alt.; W/65A., 80A., 105A., 145A. Alt.; W/O P.T.O.		@7630
Belt - Fan & Alt.; W/65A., 80A., 105A., 145A. Alt; W/P.T.O.	361975C91	@7673	Belt - Fan & Gen.; W/20A. Alt.	151534R11	@7680
Belt - Fan & Alt.; W/65A., 80A., 105A., 145A. Alt.; W/O P.T.O.		@7630	Belt - Fan & Gen.; W/30A. Alt.	224638R11	@7695
Belt - Fan & Gen.; W/20A. Alt.	151534R11	@7680	Belt - Fan & Gen.; W/35A. Alt.	151535R11	@7695
Belt - Fan & Gen.; W/30A. Alt.	224638R11	@7695	Belt - Fan & Gen.; W/50A. Alt.	151536R11	@7715
Belt - Fan & Gen.; W/35A. Alt.	151535R11	@7695	Belt - P.S.; W/2WD		7460
Belt - Fan & Gen.; W/50A. Alt.	151536R11	@7715	Belt - P.S.; W/4WD	285522C2	7435
Belt - P.S.; W/2WD		7460	Belt - Air Brake Compr.	359007C91	7475
Belt - P.S.; W/4WD	285522C2	7435	Belt - A.P.; W/Air Brakes; W/Gov.	388139C1	7330
Belt - Air Brake Compr.	359007C91	7475	Belt - A.P.; W/Air Brakes; W/O Gov.	256062C2	7340
Belt - A.P.; W/Air Brakes; W/Gov.	388139C1	7330	Belt - A.P.; W/Hyd. Brakes; W/Gov.	355653C91	7380
Belt - A.P.; W/Air Brakes; W/O Gov.	256062C2	7340	Belt - A.P.; W/Hyd. Brakes; W/O Gov.	362887C91	7410
Belt - A.P.; W/Hyd. Brakes; W/Gov.	355653C91	7380	Hose - Upper; W/Rad. Shutters; W/Metal Hood		26515
Belt - A.P.; W/Hyd. Brakes; W/O Gov.	362887C91	7410	Hose - Upper; W/O Rad. Shutters; W/Metal Hood		20493
Hose - Upper; W/Rad. Shutters; W/Metal Hood		26515	Hose - Lower - Eng. To Pipe; W/Auto. Trans.		20532
Hose - Upper; W/O Rad. Shutters; W/Metal Hood		20493	Hose - Lower; W/Man. Trans.		21308
Hose - Lower - Eng. To Pipe; W/Auto. Trans.		20532	Hose - By Pass		≈20357
Hose - Lower; W/Man. Trans.		21308	1823		
Hose - By Pass		≈20357	Belt - Fan & Alt.; W/37A., 52A., 61A. Alt.; C, G, H Chassis; W/P.T.O.	968815R11	@7650
1723			Belt - Fan & Alt.; W/37A., 52A., 61A. Alt.; C, G, H Chassis; W/O P.T.O.	373457C91	@7612
Belt - Fan & Alt.; W/37A., 52A., 61A. Alt.; C, G, H Chassis; W/P.T.O.	968815R11	@7650	Belt - Fan & Alt.; W/37A., 52A., 61A. Alt.; FD, SB Chassis	968815R1	@7650
Belt - Fan & Alt.; W/37A., 52A., 61A. Alt.; C, G, H Chassis; W/O P.T.O.	373457C91	@7612	Belt - Fan & Alt.; W/37A., 61A. Alt.; W/O Air Brakes; W/O P.T.O.; W/O X.C.	373456C1	7612
Belt - Fan & Alt.; W/37A., 52A., 61A. Alt.; FD, SB Chassis	968815R1	@7650	Belt - Fan & Alt.; W/55A., 62A. Alt.; C, G, H Chassis	369723C91	@7630
Belt - Fan & Alt.; W/37A., 61A. Alt.; W/O Air Brakes; W/O P.T.O.; W/O X.C.	373456C1	7612	Belt - Fan & Alt.; W/55A., 62A. Alt.; FD, SB Chassis	361975C91	@7673
Belt - Fan & Alt.; W/55A., 62A. Alt.; C, G, H Chassis	369723C91	@7630	Belt - Fan & Alt.; W/60A. Alt.	359009C91	@7680
Belt - Fan & Alt.; W/55A., 62A. Alt.; FD, SB Chassis	361975C91	@7673	Belt - Fan & Alt.; W/65A., 80A., 105A., 145A. Alt; W/P.T.O.	361975C91	@7673
Belt - Fan & Alt.; W/60A. Alt.	359009C91	@7680	Belt - Fan & Alt.; W/65A., 80A., 105A., 145A. Alt.; W/O P.T.O.		@7630
Belt - Fan & Alt.; W/65A., 80A., 105A., 145A. Alt; W/P.T.O.	361975C91	@7673	Belt - Fan & Gen.; W/20A. Alt.	151534R11	@7680
Belt - Fan & Alt.; W/65A., 80A., 105A., 145A. Alt.; W/O P.T.O.		@7630	Belt - Fan & Gen.; W/30A. Alt.	224638R11	@7695
Belt - Fan & Gen.; W/20A. Alt.	151534R11	@7680	Belt - Fan & Gen.; W/35A. Alt.	151535R11	@7695
Belt - Fan & Gen.; W/30A. Alt.	224638R11	@7695	Belt - Fan & Gen.; W/50A. Alt.	151536R11	@7715
Belt - Fan & Gen.; W/35A. Alt.	151535R11	@7695	Belt - P.S.; W/2WD		7460
Belt - Fan & Gen.; W/50A. Alt.	151536R11	@7715	Belt - P.S.; W/4WD	285522C2	7435
Belt - P.S.; W/2WD		7460	Belt - Air Brake Compr.	359007C91	7475
Belt - P.S.; W/4WD	285522C2	7435	Belt - A.P.; W/Air Brakes; W/Gov.	388139C1	7330
Belt - Air Brake Compr.	359007C91	7475	Belt - A.P.; W/Air Brakes; W/O Gov.	256062C2	7340
Belt - A.P.; W/Air Brakes; W/Gov.	388139C1	7330	Belt - A.P.; W/Hyd. Brakes; W/Gov.	355653C91	7380
Belt - A.P.; W/Air Brakes; W/O Gov.	256062C2	7340	Belt - A.P.; W/Hyd. Brakes; W/O Gov.	362887C91	7410
Belt - A.P.; W/Hyd. Brakes; W/Gov.	355653C91	7380			
Belt - A.P.; W/Hyd. Brakes; W/O Gov.	362887C91	7410	International/Navistar V392		
1803			1603; 1703 (School Bus)		
Belt - Fan & Alt.; W/37A., 52A., 61A. Alt.; C, G, H Chassis; W/P.T.O.	968815R11	@7650	Belt - Fan & Alt.; W/37A., 52A., 61A. Alt.; C, G, H Chassis; W/P.T.O.	968815R11	@7650
Belt - Fan & Alt.; W/37A., 52A., 61A. Alt.; C, G, H Chassis; W/O P.T.O.	373457C91	@7612	Belt - Fan & Alt.; W/37A., 52A., 61A. Alt.; FD, SB Chassis	968815R1	@7650
Belt - Fan & Alt.; W/37A., 52A., 61A. Alt.; C, G, H Chassis; W/O P.T.O.	373457C91	@7612	Belt - Fan & Alt.; W/37A., 61A. Alt.; W/O Air Brakes; W/O P.T.O.; W/O X.C.	373456C1	7612
Belt - Fan & Alt.; W/37A., 52A., 61A. Alt.; FD, SB Chassis	968815R1	@7650	Belt - Fan & Alt.; W/55A., 62A. Alt.; C, G, H Chassis	369723C91	@7630
Belt - Fan & Alt.; W/37A., 61A. Alt.; W/O Air Brakes; W/O P.T.O.; W/O X.C.	373456C1	7612			
Belt - Fan & Alt.; W/55A., 62A. Alt.; C, G, H Chassis	369723C91	@7630			

@Two Required.

≈Cut to Fit.

Belts and Coolant Hose for School Buses

Application	Mfr. Part No.	Our No.	Application	Mfr. Part No.	Our No.
International/Navistar - Continued			International/Navistar - Continued		
1967 - 1966 - Continued			1967 - 1966 - Continued		
International/Navistar V392 - Continued			International/Navistar V392 - Continued		
1603; 1703 (School Bus) - Continued			1803 - Continued		
Belt - Fan & Alt.; W/55A., 62A. Alt.; FD, SB			Belt - Fan & Alt.; W/65A., 80A., 105A.,		
Chassis	361975C91	②7673	145A. Alt; W/P.T.O.	361975C91	②7673
Belt - Fan & Alt.; W/60A. Alt.	359009C91	②7680	Belt - Fan & Alt.; W/65A., 80A., 105A., 145A. Alt.; W/O		
Belt - Fan & Alt.; W/65A., 80A., 105A.,			P.T.O.		②7630
145A. Alt; W/P.T.O.	361975C91	②7673	Belt - Fan & Gen.; W/20A. Alt.	151534R11	②7680
Belt - Fan & Alt.; W/65A., 80A., 105A., 145A. Alt.; W/O			Belt - Fan & Gen.; W/30A. Alt.	224638R11	②7695
P.T.O.		②7630	Belt - Fan & Gen.; W/35A. Alt.	151535R11	②7695
Belt - Fan & Gen.; W/20A. Alt.	151534R11	②7680	Belt - Fan & Gen.; W/50A. Alt.	151536R11	②7715
Belt - Fan & Gen.; W/30A. Alt.	224638R11	②7695	Belt - P.S.; W/2WD		7460
Belt - Fan & Gen.; W/35A. Alt.	151535R11	②7695	Belt - P.S.; W/4WD	285522C2	7435
Belt - Fan & Gen.; W/50A. Alt.	151536R11	②7715	Belt - Air Brake Compr.	359007C91	7475
Belt - P.S.; W/2WD		7460	Belt - A.P.; W/Air Brakes; W/Gov.	388139C1	7330
Belt - P.S.; W/4WD	285522C2	7435	Belt - A.P.; W/Air Brakes; W/O Gov.	256062C2	7340
Belt - Air Brake Compr.	359007C91	7475	Belt - A.P.; W/Hyd. Brakes; W/Gov.	355653C91	7380
Belt - A.P.; W/Air Brakes; W/Gov.	388139C1	7330	Belt - A.P.; W/Hyd. Brakes; W/O Gov.	362887C91	7410
Belt - A.P.; W/Air Brakes; W/O Gov.	256062C2	7340	Hose - Upper; W/Rad. Shutters; W/Metal Hood		26515
Belt - A.P.; W/Hyd. Brakes; W/Gov.	355653C91	7380	Hose - Upper; W/O Rad. Shutters; W/Metal Hood		20493
Belt - A.P.; W/Hyd. Brakes; W/O Gov.	362887C91	7410	Hose - Lower - Eng. To Pipe; W/Auto. Trans.		20532
Hose - Upper; W/Rad. Shutters; W/Metal Hood		26515	Hose - Lower; W/Man. Trans.		21308
Hose - Upper; W/O Rad. Shutters; W/Metal Hood		20493	Hose - By Pass		③<20357
Hose - Lower - Eng. To Pipe; W/Auto. Trans.		20532			
Hose - Lower; W/Man. Trans.		21308			
Hose - By Pass		③<20357			
1723					
Belt - Fan & Alt.; W/37A., 52A., 61A. Alt.;			Belt - Fan & Alt.; W/37A., 52A., 61A. Alt.;		
C, G, H Chassis; W/P.T.O.	968815R11	②7650	C, G, H Chassis; W/O P.T.O.	373457C91	②7612
Belt - Fan & Alt.; W/37A., 52A., 61A. Alt.;			Belt - Fan & Alt.; W/37A., 52A., 61A. Alt.;		
C, G, H Chassis; W/O P.T.O.	373457C91	②7612	FD, SB Chassis	968815R1	②7650
Belt - Fan & Alt.; W/37A., 52A., 61A. Alt.;			Belt - Fan & Alt.; W/37A., 61A. Alt.; W/O		
FD, SB Chassis	968815R1	②7650	Air Brakes; W/O P.T.O.; W/O X.C.	373456C1	7612
Belt - Fan & Alt.; W/37A., 61A. Alt.; W/O			Belt - Fan & Alt.; W/55A., 62A. Alt.; C, G, H		
Air Brakes; W/O P.T.O.; W/O X.C.	373456C1	7612	Chassis	369723C91	②7630
Belt - Fan & Alt.; W/55A., 62A. Alt.; C, G, H			Belt - Fan & Alt.; W/55A., 62A. Alt.; FD, SB		
Chassis	369723C91	②7630	Chassis	361975C91	②7673
Belt - Fan & Alt.; W/55A., 62A. Alt.; FD, SB			Belt - Fan & Alt.; W/60A. Alt.	359009C91	②7680
Chassis	361975C91	②7673	Belt - Fan & Alt.; W/65A., 80A., 105A.,		
Belt - Fan & Alt.; W/60A. Alt.	359009C91	②7680	145A. Alt; W/P.T.O.	361975C91	②7673
Belt - Fan & Alt.; W/65A., 80A., 105A.,			Belt - Fan & Alt.; W/65A., 80A., 105A., 145A. Alt.; W/O		
145A. Alt; W/P.T.O.	361975C91	②7673	P.T.O.		②7630
Belt - Fan & Alt.; W/65A., 80A., 105A., 145A. Alt.; W/O			Belt - Fan & Gen.; W/20A. Alt.	151534R11	②7680
P.T.O.		②7630	Belt - Fan & Gen.; W/30A. Alt.	224638R11	②7695
Belt - Fan & Gen.; W/20A. Alt.	151534R11	②7680	Belt - Fan & Gen.; W/35A. Alt.	151535R11	②7695
Belt - Fan & Gen.; W/30A. Alt.	224638R11	②7695	Belt - Fan & Gen.; W/50A. Alt.	151536R11	②7715
Belt - Fan & Gen.; W/35A. Alt.	151535R11	②7695	Belt - P.S.; W/2WD		7460
Belt - Fan & Gen.; W/50A. Alt.	151536R11	②7715	Belt - P.S.; W/4WD	285522C2	7435
Belt - P.S.; W/2WD		7460	Belt - Air Brake Compr.	359007C91	7475
Belt - P.S.; W/4WD	285522C2	7435	Belt - A.P.; W/Air Brakes; W/Gov.	388139C1	7330
Belt - Air Brake Compr.	359007C91	7475	Belt - A.P.; W/Air Brakes; W/O Gov.	256062C2	7340
Belt - A.P.; W/Air Brakes; W/Gov.	388139C1	7330	Belt - A.P.; W/Hyd. Brakes; W/Gov.	355653C91	7380
Belt - A.P.; W/Air Brakes; W/O Gov.	256062C2	7340	Belt - A.P.; W/Hyd. Brakes; W/O Gov.	362887C91	7410
Belt - A.P.; W/Hyd. Brakes; W/Gov.	355653C91	7380			
Belt - A.P.; W/Hyd. Brakes; W/O Gov.	362887C91	7410			
1803			International/Navistar V401		
Belt - Fan & Alt.; W/37A., 52A., 61A. Alt.;			193RE		
C, G, H Chassis; W/P.T.O.	968815R11	②7650	Belt - Fan; W/52 5/8" Belt O.C.	680611R11	②◆◆9520HD
Belt - Fan & Alt.; W/37A., 52A., 61A. Alt.;			Belt - Fan; W/57 5/8" Belt O.C.	261710C11	◆9570HD
C, G, H Chassis; W/O P.T.O.	373457C91	②7612	Belt - Alt. To Compr.; W/37A., 60A. Alt.	243605R11	◆9451HD
Belt - Fan & Alt.; W/37A., 52A., 61A. Alt.;			Belt - Alt. To Compr.; W/55A. Alt.	264975C11	◆9455HD
FD, SB Chassis	968815R1	②7650	Belt - Gen. To Compr.; W/30A. Gen.	133758R1	◆9440HD
Belt - Fan & Alt.; W/37A., 61A. Alt.; W/O			Belt - Gen. To Compr.; W/35A. Gen.	150560R11	◆9451HD
Air Brakes; W/O P.T.O.; W/O X.C.	373456C1	7612	Belt - Gen. To Compr.; W/50A. Gen.	201825R11	◆9435HD
Belt - Fan & Alt.; W/55A., 62A. Alt.; C, G, H			Belt - Gen.; W/Hyd. Brakes	133732R1	◆9360HD
Chassis	369723C91	②7630	Belt - P.S.; W/43 1/8" Belt O.C.	164550R11	◆9425HD
Belt - Fan & Alt.; W/55A., 62A. Alt.; FD, SB			Belt - P.S.; W/44 5/8" Belt O.C.	133758R1	◆9440HD
Chassis	361975C91	②7673	Belt - Idler; W/56 1/8" Belt O.C.	968645R11	◆9555HD
Belt - Fan & Alt.; W/60A. Alt.	359009C91	②7680	Belt - Idler; W/57 5/8" Belt O.C.	261710C11	◆9570HD

School Buses

②Two Required.
◆Standard Belt Available.

③<Cut to Fit.
◆PowerBand Belt May Work, Use Template to Check.

Belts and Coolant Hose for School Buses

School Buses

Application	Mfr. Part No.	Our No.	Application	Mfr. Part No.	Our No.
International/Navistar - Continued			International/Navistar - Continued		
1967 - 1966 - Continued			1967 - 1966 - Continued		
International/Navistar V461			International/Navistar VS478 - Continued		
193RE			193RE - Continued		
Belt - Fan; W/52 5/8" Belt O.C.	680611R11	②♠◆9520HD	Belt - Gen. To Compr.; W/50A. Gen.	201825R11	♠9435HD
Belt - Fan; W/57 5/8" Belt O.C.	261710C11	♠9570HD	Belt - Gen.; W/Hyd. Brakes	133732R1	♠9360HD
Belt - Alt. To Compr.; W/37A., 60A. Alt.	243605R11	♠9451HD	Belt - P.S.; W/43 1/8" Belt O.C.	164550R11	♠9425HD
Belt - Alt. To Compr.; W/55A. Alt.	264975C11	♠9455HD	Belt - P.S.; W/44 5/8" Belt O.C.	133758R1	♠9440HD
Belt - Gen. To Compr.; W/30A. Gen.	133758R1	♠9440HD	Belt - Idler; W/56 1/8" Belt O.C.	968645R11	♠9555HD
Belt - Gen. To Compr.; W/35A. Gen.	150560R11	♠9451HD	Belt - Idler; W/57 5/8" Belt O.C.	261710C11	♠9570HD
Belt - Gen. To Compr.; W/50A. Gen.	201825R11	♠9435HD			
Belt - Gen.; W/Hyd. Brakes	133732R1	♠9360HD	International/Navistar VS549		
Belt - P.S.; W/43 1/8" Belt O.C.	164550R11	♠9425HD	193RE		
Belt - P.S.; W/44 5/8" Belt O.C.	133758R1	♠9440HD	Belt - Fan; W/52 5/8" Belt O.C.	680611R11	②♠◆9520HD
Belt - Idler; W/56 1/8" Belt O.C.	968645R11	♠9555HD	Belt - Fan; W/57 5/8" Belt O.C.	261710C11	♠9570HD
Belt - Idler; W/57 5/8" Belt O.C.	261710C11	♠9570HD	Belt - Alt. To Compr.; W/37A., 60A. Alt.	243605R11	♠9451HD
			Belt - Alt. To Compr.; W/55A. Alt.	264975C11	♠9455HD
International/Navistar V478			Belt - Gen. To Compr.; W/30A. Gen.	133758R1	♠9440HD
193RE			Belt - Gen. To Compr.; W/35A. Gen.	150560R11	♠9451HD
Belt - Fan; W/52 5/8" Belt O.C.	680611R11	②♠◆9520HD	Belt - Gen. To Compr.; W/50A. Gen.	201825R11	♠9435HD
Belt - Fan; W/57 5/8" Belt O.C.	261710C11	♠9570HD	Belt - Gen.; W/Hyd. Brakes	133732R1	♠9360HD
Belt - Alt. To Compr.; W/37A., 60A. Alt.	243605R11	♠9451HD	Belt - P.S.; W/43 1/8" Belt O.C.	164550R11	♠9425HD
Belt - Alt. To Compr.; W/55A. Alt.	264975C11	♠9455HD	Belt - P.S.; W/44 5/8" Belt O.C.	133758R1	♠9440HD
Belt - Gen. To Compr.; W/30A. Gen.	133758R1	♠9440HD	Belt - Idler; W/56 1/8" Belt O.C.	968645R11	♠9555HD
Belt - Gen. To Compr.; W/35A. Gen.	150560R11	♠9451HD	Belt - Idler; W/57 5/8" Belt O.C.	261710C11	♠9570HD
Belt - Gen. To Compr.; W/50A. Gen.	201825R11	♠9435HD			
Belt - Gen.; W/Hyd. Brakes	133732R1	♠9360HD	1965		
Belt - P.S.; W/43 1/8" Belt O.C.	164550R11	♠9425HD	International/Navistar BD220		
Belt - P.S.; W/44 5/8" Belt O.C.	133758R1	♠9440HD	1603		
Belt - Idler; W/56 1/8" Belt O.C.	968645R11	♠9555HD	Belt - Fan & Alt.; W/37A., 52A., 61A., 62A.		
Belt - Idler; W/57 5/8" Belt O.C.	261710C11	♠9570HD	Alt.		
			151532R1		
			②7512		
			Belt - Fan & Alt.; W/60A. Alt.		
			861779R11		
			②♠9440HD		
			Belt - Gen.; W/20A., 50A. Alt.		
			20594VA		
			TR24438		
			Belt - Gen.; W/30A. Alt.		
			81572R2		
			TR28437		
			Belt - Gen.; W/35A., 50A. L.C.I. Gen.		
			164550R1		
			②♠9425HD		
			Belt - P.S.; W/Air Brakes		
			149636R1		
			♠9480HD		
			Belt - P.S.; W/Hyd. Brakes		
			864931R2		
			♠9319HD		
			Belt - Air Brake Compr.; W/4 Cu. Ft. Air		
			Brake Compr.		
			201825R1		
			♠9440HD		
			Belt - Air Brake Compr.; W/20A., 30A.,		
			50A. Gen.		
			115505HA		
			TR22363		
			Hose - Upper		
			26510		
			Hose - Lower - Eng. To Pipe		
			26508		
			Hose - Lower - Pipe To Rad.		
			26514		
			Hose - By Pass		
			20338		
			or		
			28441		
			International/Navistar BD240		
			1603		
			Belt - Fan & Alt.; W/37A., 52A., 61A., 62A.		
			Alt.		
			151532R1		
			②7512		
			Belt - Fan & Alt.; W/60A. Alt.		
			861779R11		
			②♠9440HD		
			Belt - Gen.; W/20A., 50A. Alt.		
			20594VA		
			TR24438		
			Belt - Gen.; W/30A. Alt.		
			81572R2		
			TR28437		
			Belt - Gen.; W/35A., 50A. L.C.I. Gen.		
			164550R1		
			②♠9425HD		
			Belt - P.S.; W/Air Brakes		
			149636R1		
			♠9480HD		
			Belt - P.S.; W/Hyd. Brakes		
			864931R2		
			♠9319HD		
			Belt - Air Brake Compr.; W/4 Cu. Ft. Air		
			Brake Compr.		
			201825R1		
			♠9440HD		
			Belt - Air Brake Compr.; W/20A., 30A.,		
			50A. Gen.		
			115505HA		
			TR22363		
			Hose - Upper		
			26510		
			Hose - Lower - Eng. To Pipe		
			26508		
			Hose - Lower - Pipe To Rad.		
			26514		
			Hose - By Pass		
			20338		
			or		
			28441		
			International/Navistar BD264		
			1603		
			Belt - Fan & Alt.; W/37A., 52A., 61A., 62A.		
			Alt.		
			151532R1		
			②7512		

♠Standard Belt Available.
②Two Required.

◆PowerBand Belt May Work, Use Template to Check.

Belts and Coolant Hose for School Buses

Application	Mfr. Part No.	Our No.	Application	Mfr. Part No.	Our No.
International/Navistar - Continued			International/Navistar - Continued		
1965 - Continued			1965 - Continued		
International/Navistar BD264 - Continued			International/Navistar BD308 - Continued		
1603 - Continued			1703 (School Bus); 1803 - Continued		
Belt - Fan & Alt.; W/60A. Alt.	861779R11	②♣9440HD	Hose - Lower - Eng. To Pipe		≈<20206
Belt - Gen.; W/20A., 50A. Alt.	20594VA	TR24438	Hose - Lower - Pipe To Rad.		24232
Belt - Gen.; W/30A. Alt.	81572R2	TR28437	Hose - By Pass		24232
Belt - Gen.; W/35A., 50A. L.C.I. Gen.	164550R1	②♣9425HD	International/Navistar BG220		
Belt - P.S.; W/Air Brakes	149636R1	♣9480HD	1603		
Belt - P.S.; W/Hyd. Brakes	864931R2	♣9319HD	Belt - Fan & Alt.; W/37A., 52A., 61A., 62A. Alt.	151532R1	②7512
Belt - Air Brake Compr.; W/4 Cu. Ft. Air Brake Compr.	201825R1	♣9440HD	Belt - Fan & Alt.; W/60A. Alt.	861779R11	②♣9440HD
Belt - Air Brake Compr.; W/20A., 30A., 50A. Gen.	115505HA	TR22363	Belt - Gen.; W/20A., 50A. Alt.	20594VA	TR24438
Hose - Upper		26510	Belt - Gen.; W/30A. Alt.	81572R2	TR28437
Hose - Lower - Eng. To Pipe		26508	Belt - Gen.; W/35A., 50A. L.C.I. Gen.	164550R1	②♣9425HD
Hose - Lower - Pipe To Rad.		26514	Belt - P.S.; W/Air Brakes	149636R1	♣9480HD
Hose - By Pass		20338	Belt - P.S.; W/Hyd. Brakes	864931R2	♣9319HD
	or	28441	Belt - Air Brake Compr.; W/4 Cu. Ft. Air Brake Compr.	201825R1	♣9440HD
International/Navistar BD269			Belt - Air Brake Compr.; W/20A., 30A., 50A. Gen.	115505HA	TR22363
1603			Hose - Upper		26510
Belt - Fan & Alt.	862880R11	②♣9490HD	Hose - Lower - Eng. To Pipe		26508
Belt - P.S.	242269R1	♣9405HD	Hose - Lower - Pipe To Rad.		26514
Belt - Air Brake Compr.	280210C1	♣9540HD	Hose - By Pass		20338
Hose - Upper		24232		or	28441
Hose - Lower		≈<20611	International/Navistar BG241		
	or	26509	1603		
Hose - By Pass		24232	Belt - Fan & Alt.; W/37A., 52A., 61A., 62A. Alt.	151532R1	②7512
1703 (School Bus); 1803			Belt - Fan & Alt.; W/60A. Alt.	861779R11	②♣9440HD
Belt - Fan & Alt.	862880R11	②♣9490HD	Belt - Gen.; W/20A., 50A. Alt.	20594VA	TR24438
Belt - P.S.	242269R1	♣9405HD	Belt - Gen.; W/30A. Alt.	81572R2	TR28437
Belt - Air Brake Compr.	280210C1	♣9540HD	Belt - Gen.; W/35A., 50A. L.C.I. Gen.	164550R1	②♣9425HD
Hose - Upper		24232	Belt - P.S.; W/Air Brakes	149636R1	♣9480HD
Hose - Lower - Eng. To Pipe		≈<20206	Belt - P.S.; W/Hyd. Brakes	864931R2	♣9319HD
Hose - Lower - Pipe To Rad.		24232	Belt - Air Brake Compr.; W/4 Cu. Ft. Air Brake Compr.	201825R1	♣9440HD
Hose - By Pass		24232	Belt - Air Brake Compr.; W/20A., 30A., 50A. Gen.	115505HA	TR22363
International/Navistar BD282			Hose - Upper		26510
1603			Hose - Lower - Eng. To Pipe		26508
Belt - Fan & Alt.	862880R11	②♣9490HD	Hose - Lower - Pipe To Rad.		26514
Belt - P.S.	242269R1	♣9405HD	Hose - By Pass		20338
Belt - Air Brake Compr.	280210C1	♣9540HD		or	28441
Hose - Upper		24232	International/Navistar BG265		
Hose - Lower		≈<20611	1603		
	or	26509	Belt - Fan & Alt.; W/37A., 52A., 61A., 62A. Alt.	151532R1	②7512
Hose - By Pass		24232	Belt - Fan & Alt.; W/60A. Alt.	861779R11	②♣9440HD
1703 (School Bus); 1803			Belt - Gen.; W/20A., 50A. Alt.	20594VA	TR24438
Belt - Fan & Alt.	862880R11	②♣9490HD	Belt - Gen.; W/30A. Alt.	81572R2	TR28437
Belt - P.S.	242269R1	♣9405HD	Belt - Gen.; W/35A., 50A. L.C.I. Gen.	164550R1	②♣9425HD
Belt - Air Brake Compr.	280210C1	♣9540HD	Belt - P.S.; W/Air Brakes	149636R1	♣9480HD
Hose - Upper		24232	Belt - P.S.; W/Hyd. Brakes	864931R2	♣9319HD
Hose - Lower - Eng. To Pipe		≈<20206	Belt - Air Brake Compr.; W/4 Cu. Ft. Air Brake Compr.	201825R1	♣9440HD
Hose - Lower - Pipe To Rad.		24232	Belt - Air Brake Compr.; W/20A., 30A., 50A. Gen.	115505HA	TR22363
Hose - By Pass		24232	Hose - Upper		26510
International/Navistar BD308			Hose - Lower - Eng. To Pipe		26508
1603			Hose - Lower - Pipe To Rad.		26514
Belt - Fan & Alt.	862880R11	②♣9490HD	Hose - By Pass		20338
Belt - P.S.	242269R1	♣9405HD		or	28441
Belt - Air Brake Compr.	280210C1	♣9540HD	International/Navistar FTV549		
Hose - Upper		24232	193RE		
Hose - Lower		≈<20611	Belt - Fan; W/52 5/8" Belt O.C.	680611R11	②♣◆9520HD
	or	26509			
Hose - By Pass		24232			
1703 (School Bus); 1803					
Belt - Fan & Alt.	862880R11	②♣9490HD			
Belt - P.S.	242269R1	♣9405HD			
Belt - Air Brake Compr.	280210C1	♣9540HD			
Hose - Upper		24232			

♣Standard Belt Available.
≈<Cut to Fit.

②Two Required.
◆PowerBand Belt May Work, Use Template to Check.

Belts and Coolant Hose for School Buses

School Buses

Application	Mfr. Part No.	Our No.	Application	Mfr. Part No.	Our No.
International/Navistar - Continued			International/Navistar - Continued		
1965 - Continued			1965 - Continued		
International/Navistar FTV549 - Continued			International/Navistar RD450 - Continued		
193RE - Continued			1853		
Belt - Fan; W/57 5/8" Belt O.C.	261710C11	♣9570HD	Belt - Alt.; W/55A., 62A., 145A. Alt.	223794K21	ⓂTR22514
Belt - Alt. To Compr.; W/37A., 60A. Alt.	243605R11	♣9451HD	Belt - Gen.; W/37A. Gen.	193826R11	TR22508
Belt - Alt. To Compr.; W/55A. Alt.	264975C11	♣9455HD	Belt - P.S.	240354R1	TR22344
Belt - Gen. To Compr.; W/30A. Gen.	133758R1	♣9440HD	1853FC		
Belt - Gen. To Compr.; W/35A. Gen.	150560R11	♣9451HD	Belt - Alt.; W/55A., 62A., 145A. Alt.	223794K21	ⓂTR22514
Belt - Gen. To Compr.; W/50A. Gen.	201825R11	♣9435HD	Belt - Gen.; W/37A. Gen.	193826R11	TR22508
Belt - Gen.; W/Hyd. Brakes	133732R1	♣9360HD	Belt - P.S.	240354R1	TR22344
Belt - P.S.; W/43 1/8" Belt O.C.	164550R11	♣9425HD	Hose - Upper; Late FD Chassis; Chassis No. FA66376 ...		26509
Belt - P.S.; W/44 5/8" Belt O.C.	133758R1	♣9440HD	Hose - Lower; Early FD Chassis; Chassis No. FA66376 ..		26508
Belt - Idler; W/56 1/8" Belt O.C.	968645R11	♣9555HD	Hose - Lower; Late FD Chassis; Chassis No. FA66376 ...		24234
Belt - Idler; W/57 5/8" Belt O.C.	261710C11	♣9570HD	or		26508
International/Navistar FTVS549			International/Navistar RD501		
193RE			1823		
Belt - Fan; W/52 5/8" Belt O.C.	680611R11	Ⓜ♣♣9520HD	Hose - Upper		26515
Belt - Fan; W/57 5/8" Belt O.C.	261710C11	♣9570HD	Hose - Lower		24232
Belt - Alt. To Compr.; W/37A., 60A. Alt.	243605R11	♣9451HD	1853		
Belt - Alt. To Compr.; W/55A. Alt.	264975C11	♣9455HD	Belt - Alt.; W/55A., 62A., 145A. Alt.	223794K21	ⓂTR22514
Belt - Gen. To Compr.; W/30A. Gen.	133758R1	♣9440HD	Belt - Gen.; W/37A. Gen.	193826R11	TR22508
Belt - Gen. To Compr.; W/35A. Gen.	150560R11	♣9451HD	Belt - P.S.	240354R1	TR22344
Belt - Gen. To Compr.; W/50A. Gen.	201825R11	♣9435HD	1853FC		
Belt - Gen.; W/Hyd. Brakes	133732R1	♣9360HD	Belt - Alt.; W/55A., 62A., 145A. Alt.	223794K21	ⓂTR22514
Belt - P.S.; W/43 1/8" Belt O.C.	164550R11	♣9425HD	Belt - Gen.; W/37A. Gen.	193826R11	TR22508
Belt - P.S.; W/44 5/8" Belt O.C.	133758R1	♣9440HD	Belt - P.S.	240354R1	TR22344
Belt - Idler; W/56 1/8" Belt O.C.	968645R11	♣9555HD	Hose - Upper; Late FD Chassis; Chassis No. FA66376 ...		26509
Belt - Idler; W/57 5/8" Belt O.C.	261710C11	♣9570HD	Hose - Lower; Early FD Chassis; Chassis No. FA66376 ..		26508
International/Navistar RD372			Hose - Lower; Late FD Chassis; Chassis No. FA66376 ...		24234
1823			or		26508
Hose - Upper		26515	International/Navistar V266		
Hose - Lower		24232	1603; 1703 (School Bus); 1803		
1853			Belt - Fan & Alt.; W/37A., 52A., 61A. Alt.; C, G, H		
Belt - Alt.; W/55A., 62A., 145A. Alt.	223794K21	ⓂTR22514	Chassis		
Belt - Gen.; W/37A. Gen.	193826R11	TR22508	Belt - Fan & Alt.; W/37A., 52A., 61A. Alt.;		
Belt - P.S.	240354R1	TR22344	FD, SB Chassis		
1853FC			255266C3		
Belt - Alt.; W/55A., 62A., 145A. Alt.	223794K21	ⓂTR22514	Ⓜ7640		
Belt - Gen.; W/37A. Gen.	193826R11	TR22508	Belt - Fan & Alt.; W/55A., 62A. Alt.; C, G, H		
Belt - P.S.	240354R1	TR22344	Chassis		
Hose - Upper; Late FD Chassis; Chassis No. FA66376 ...		26509	369725C91		
Hose - Lower; Early FD Chassis; Chassis No. FA66376 ..		26508	Ⓜ7619		
Hose - Lower; Late FD Chassis; Chassis No. FA66376 ...		24234	Belt - Fan & Alt.; W/55A., 62A. Alt.; FD, SB		
or		26508	Chassis		
International/Navistar RD406			358998C91		
1823			Ⓜ7650		
Hose - Upper		26515	Belt - P.S.; W/2WD		
Hose - Lower		24232	151529R2		
1853			7440		
Belt - Alt.; W/55A., 62A., 145A. Alt.	223794K21	ⓂTR22514	Belt - P.S.; W/4WD		
Belt - Gen.; W/37A. Gen.	193826R11	TR22508	151531R2		
Belt - P.S.	240354R1	TR22344	7450		
1853FC			Belt - Air Brake Compr.		
Belt - Alt.; W/55A., 62A., 145A. Alt.	223794K21	ⓂTR22514	236572R2		
Belt - Gen.; W/37A. Gen.	193826R11	TR22508	7460		
Belt - P.S.	240354R1	TR22344	Hose - Upper; W/Rad. Shutters; W/Metal Hood		
Hose - Upper; Late FD Chassis; Chassis No. FA66376 ...		26509	26515		
Hose - Lower; Early FD Chassis; Chassis No. FA66376 ..		26508	Hose - Upper; W/O Rad. Shutters; W/Metal Hood		
Hose - Lower; Late FD Chassis; Chassis No. FA66376 ...		24234	20493		
or		26508	Hose - Lower - Eng. To Pipe; W/Auto. Trans.		
International/Navistar RD450			20532		
1823			Hose - Lower; W/Man. Trans.		
Hose - Upper		26515	21308		
Hose - Lower		24232	Hose - By Pass		
International/Navistar RD450			Ⓜ<20357		
1823			International/Navistar V304		
Hose - Upper		26515	1603; 1703 (School Bus); 1803		
Hose - Lower		24232	Belt - Fan & Alt.; W/37A., 52A., 61A. Alt.; C, G, H		
International/Navistar RD450			Chassis		
1823			Ⓜ7603		
Hose - Upper		26515	Belt - Fan & Alt.; W/37A., 52A., 61A. Alt.;		
Hose - Lower		24232	FD, SB Chassis		
International/Navistar RD450			255266C3		
1823			Ⓜ7640		
Hose - Upper		26515	Belt - Fan & Alt.; W/55A., 62A. Alt.; C, G, H		
Hose - Lower		24232	Chassis		
International/Navistar RD450			369725C91		
1823			Ⓜ7619		
Hose - Upper		26515	Belt - Fan & Alt.; W/55A., 62A. Alt.; FD, SB		
Hose - Lower		24232	Chassis		
International/Navistar RD450			358998C91		
1823			Ⓜ7650		
Hose - Upper		26515	Belt - P.S.; W/2WD		
Hose - Lower		24232	151529R2		
International/Navistar RD450			7440		
1823			Belt - P.S.; W/4WD		
Hose - Upper		26515	151531R2		
Hose - Lower		24232	7450		
International/Navistar RD450			Belt - Air Brake Compr.		
1823			236572R2		
Hose - Upper		26515	7460		
Hose - Lower		24232	Hose - Upper; W/Rad. Shutters; W/Metal Hood		
International/Navistar RD450			26515		
1823			Hose - Upper; W/O Rad. Shutters; W/Metal Hood		
Hose - Upper		26515	20493		
Hose - Lower		24232	Hose - Lower - Eng. To Pipe; W/Auto. Trans.		
International/Navistar RD450			20532		
1823			Hose - Lower; W/Man. Trans.		
Hose - Upper		26515	21308		
Hose - Lower		24232	Hose - By Pass		
International/Navistar RD450			Ⓜ<20357		

♣Standard Belt Available.
ⓂTwo Required.

◆PowerBand Belt May Work, Use Template to Check.
Ⓜ<Cut to Fit.

Belts and Coolant Hose for School Buses

Application	Mfr. Part No.	Our No.	Application	Mfr. Part No.	Our No.
International/Navistar - Continued			International/Navistar - Continued		
1965 - Continued			1965 - Continued		
International/Navistar V345			International/Navistar V345 - Continued		
1603; 1703 (School Bus)			1803 - Continued		
Belt - Fan & Alt.; W/37A., 52A., 61A. Alt.; C, G, H Chassis; W/P.T.O.	968815R11	②7650	Belt - Fan & Alt.; W/37A., 52A., 61A. Alt.; FD, SB Chassis	968815R1	②7650
Belt - Fan & Alt.; W/37A., 52A., 61A. Alt.; C, G, H Chassis; W/O P.T.O.	373457C91	②7612	Belt - Fan & Alt.; W/37A., 61A. Alt.; W/O Air Brakes; W/O P.T.O.; W/O X.C.	373456C1	7612
Belt - Fan & Alt.; W/37A., 52A., 61A. Alt.; FD, SB Chassis	968815R1	②7650	Belt - Fan & Alt.; W/55A., 62A. Alt.; C, G, H Chassis	369723C91	②7630
Belt - Fan & Alt.; W/37A., 61A. Alt.; W/O Air Brakes; W/O P.T.O.; W/O X.C.	373456C1	7612	Belt - Fan & Alt.; W/55A., 62A. Alt.; FD, SB Chassis	361975C91	②7673
Belt - Fan & Alt.; W/55A., 62A. Alt.; C, G, H Chassis	369723C91	②7630	Belt - Fan & Alt.; W/60A. Alt.	359009C91	②7680
Belt - Fan & Alt.; W/55A., 62A. Alt.; FD, SB Chassis	361975C91	②7673	Belt - Fan & Alt.; W/65A., 80A., 105A., 145A. Alt.; W/P.T.O.	361975C91	②7673
Belt - Fan & Alt.; W/60A. Alt.	359009C91	②7680	Belt - Fan & Alt.; W/65A., 80A., 105A., 145A. Alt.; W/O P.T.O.		②7630
Belt - Fan & Alt.; W/65A., 80A., 105A., 145A. Alt.; W/P.T.O.	361975C91	②7673	Belt - Fan & Gen.; W/20A. Alt.	151534R11	②7680
Belt - Fan & Alt.; W/65A., 80A., 105A., 145A. Alt.; W/O P.T.O.		②7630	Belt - Fan & Gen.; W/30A. Alt.	224638R11	②7695
Belt - Fan & Gen.; W/20A. Alt.	151534R11	②7680	Belt - Fan & Gen.; W/35A. Alt.	151535R11	②7695
Belt - Fan & Gen.; W/30A. Alt.	224638R11	②7695	Belt - Fan & Gen.; W/50A. Alt.	151536R11	②7715
Belt - Fan & Gen.; W/35A. Alt.	151535R11	②7695	Belt - P.S.; W/2WD		7460
Belt - Fan & Gen.; W/50A. Alt.	151536R11	②7715	Belt - P.S.; W/4WD	285522C2	7435
Belt - P.S.; W/2WD		7460	Belt - Air Brake Compr.	359007C91	7475
Belt - P.S.; W/4WD	285522C2	7435	Belt - A.P.; W/Air Brakes; W/Gov.	388139C1	7330
Belt - Air Brake Compr.	359007C91	7475	Belt - A.P.; W/Air Brakes; W/O Gov.	256062C2	7340
Belt - A.P.; W/Air Brakes; W/Gov.	388139C1	7330	Belt - A.P.; W/Hyd. Brakes; W/Gov.	355653C91	7380
Belt - A.P.; W/Air Brakes; W/O Gov.	256062C2	7340	Belt - A.P.; W/Hyd. Brakes; W/O Gov.	362887C91	7410
Belt - A.P.; W/Hyd. Brakes; W/Gov.	355653C91	7380	Hose - Upper; W/Rad. Shutters; W/Metal Hood		26515
Belt - A.P.; W/Hyd. Brakes; W/O Gov.	362887C91	7410	Hose - Upper; W/O Rad. Shutters; W/Metal Hood		20493
Hose - Upper; W/Rad. Shutters; W/Metal Hood		26515	Hose - Lower - Eng. To Pipe; W/Auto. Trans.		20532
Hose - Upper; W/O Rad. Shutters; W/Metal Hood		20493	Hose - Lower; W/Man. Trans.		21308
Hose - Lower - Eng. To Pipe; W/Auto. Trans.		20532	Hose - By Pass		≈20357
Hose - Lower; W/Man. Trans.		21308			
Hose - By Pass		≈20357	1823		
			Belt - Fan & Alt.; W/37A., 52A., 61A. Alt.; C, G, H Chassis; W/P.T.O.	968815R11	②7650
1723			Belt - Fan & Alt.; W/37A., 52A., 61A. Alt.; C, G, H Chassis; W/O P.T.O.	373457C91	②7612
Belt - Fan & Alt.; W/37A., 52A., 61A. Alt.; C, G, H Chassis; W/P.T.O.	968815R11	②7650	Belt - Fan & Alt.; W/37A., 52A., 61A. Alt.; FD, SB Chassis	968815R1	②7650
Belt - Fan & Alt.; W/37A., 52A., 61A. Alt.; C, G, H Chassis; W/O P.T.O.	373457C91	②7612	Belt - Fan & Alt.; W/37A., 61A. Alt.; W/O Air Brakes; W/O P.T.O.; W/O X.C.	373456C1	7612
Belt - Fan & Alt.; W/37A., 52A., 61A. Alt.; FD, SB Chassis	968815R1	②7650	Belt - Fan & Alt.; W/55A., 62A. Alt.; C, G, H Chassis	369723C91	②7630
Belt - Fan & Alt.; W/37A., 61A. Alt.; W/O Air Brakes; W/O P.T.O.; W/O X.C.	373456C1	7612	Belt - Fan & Alt.; W/55A., 62A. Alt.; FD, SB Chassis	361975C91	②7673
Belt - Fan & Alt.; W/55A., 62A. Alt.; C, G, H Chassis	369723C91	②7630	Belt - Fan & Alt.; W/60A. Alt.	359009C91	②7680
Belt - Fan & Alt.; W/55A., 62A. Alt.; FD, SB Chassis	361975C91	②7673	Belt - Fan & Alt.; W/65A., 80A., 105A., 145A. Alt.; W/P.T.O.	361975C91	②7673
Belt - Fan & Alt.; W/60A. Alt.	359009C91	②7680	Belt - Fan & Alt.; W/65A., 80A., 105A., 145A. Alt.; W/O P.T.O.		②7630
Belt - Fan & Alt.; W/65A., 80A., 105A., 145A. Alt.; W/P.T.O.	361975C91	②7673	Belt - Fan & Gen.; W/20A. Alt.	151534R11	②7680
Belt - Fan & Alt.; W/65A., 80A., 105A., 145A. Alt.; W/O P.T.O.		②7630	Belt - Fan & Gen.; W/30A. Alt.	224638R11	②7695
Belt - Fan & Gen.; W/20A. Alt.	151534R11	②7680	Belt - Fan & Gen.; W/35A. Alt.	151535R11	②7695
Belt - Fan & Gen.; W/30A. Alt.	224638R11	②7695	Belt - Fan & Gen.; W/50A. Alt.	151536R11	②7715
Belt - Fan & Gen.; W/35A. Alt.	151535R11	②7695	Belt - P.S.; W/2WD		7460
Belt - Fan & Gen.; W/50A. Alt.	151536R11	②7715	Belt - P.S.; W/4WD	285522C2	7435
Belt - P.S.; W/2WD		7460	Belt - Air Brake Compr.	359007C91	7475
Belt - P.S.; W/4WD	285522C2	7435	Belt - A.P.; W/Air Brakes; W/Gov.	388139C1	7330
Belt - Air Brake Compr.	359007C91	7475	Belt - A.P.; W/Air Brakes; W/O Gov.	256062C2	7340
Belt - A.P.; W/Air Brakes; W/Gov.	388139C1	7330	Belt - A.P.; W/Hyd. Brakes; W/Gov.	355653C91	7380
Belt - A.P.; W/Air Brakes; W/O Gov.	256062C2	7340	Belt - A.P.; W/Hyd. Brakes; W/O Gov.	362887C91	7410
Belt - A.P.; W/Hyd. Brakes; W/Gov.	355653C91	7380			
Belt - A.P.; W/Hyd. Brakes; W/O Gov.	362887C91	7410	International/Navistar V392		
			1603; 1703 (School Bus)		
			Belt - Fan & Alt.; W/37A., 52A., 61A. Alt.; C, G, H Chassis; W/P.T.O.	968815R11	②7650
			Belt - Fan & Alt.; W/37A., 52A., 61A. Alt.; C, G, H Chassis; W/O P.T.O.	373457C91	②7612
			Belt - Fan & Alt.; W/37A., 52A., 61A. Alt.; FD, SB Chassis	968815R1	②7650

②Two Required.

≈Cut to Fit.

School Buses

Belts and Coolant Hose for School Buses

Application	Mfr. Part No.	Our No.	Application	Mfr. Part No.	Our No.
International/Navistar - Continued			International/Navistar - Continued		
1965 - Continued			1965 - Continued		
International/Navistar V392 - Continued			International/Navistar V392 - Continued		
1603; 1703 (School Bus) - Continued			1803 - Continued		
Belt - Fan & Alt.: W/37A., 61A. Alt.: W/O Air Brakes; W/O P.T.O.; W/O X.C.	373456C1	7612	Belt - Fan & Alt.: W/55A., 62A. Alt.: FD, SB Chassis	361975C91	②7673
Belt - Fan & Alt.: W/55A., 62A. Alt.: C, G, H Chassis	369723C91	②7630	Belt - Fan & Alt.: W/60A. Alt.	359009C91	②7680
Belt - Fan & Alt.: W/55A., 62A. Alt.: FD, SB Chassis	361975C91	②7673	Belt - Fan & Alt.: W/65A., 80A., 105A., 145A. Alt.; W/P.T.O.	361975C91	②7673
Belt - Fan & Alt.: W/60A. Alt.	359009C91	②7680	Belt - Fan & Alt.: W/65A., 80A., 105A., 145A. Alt.; W/O P.T.O.		②7630
Belt - Fan & Alt.: W/65A., 80A., 105A., 145A. Alt.; W/P.T.O.	361975C91	②7673	Belt - Fan & Gen.: W/20A. Alt.	151534R11	②7680
Belt - Fan & Alt.: W/65A., 80A., 105A., 145A. Alt.; W/O P.T.O.		②7630	Belt - Fan & Gen.: W/30A. Alt.	224638R11	②7695
Belt - Fan & Gen.: W/20A. Alt.	151534R11	②7680	Belt - Fan & Gen.: W/35A. Alt.	151535R11	②7695
Belt - Fan & Gen.: W/30A. Alt.	224638R11	②7695	Belt - Fan & Gen.: W/50A. Alt.	151536R11	②7715
Belt - Fan & Gen.: W/35A. Alt.	151535R11	②7695	Belt - P.S.; W/2WD		7460
Belt - Fan & Gen.: W/50A. Alt.	151536R11	②7715	Belt - P.S.; W/4WD	285522C2	7435
Belt - P.S.; W/2WD		7460	Belt - Air Brake Compr.	359007C91	7475
Belt - P.S.; W/4WD	285522C2	7435	Belt - A.P.; W/Air Brakes; W/Gov.	388139C1	7330
Belt - Air Brake Compr.	359007C91	7475	Belt - A.P.; W/Air Brakes; W/O Gov.	256062C2	7340
Belt - A.P.; W/Air Brakes; W/Gov.	388139C1	7330	Belt - A.P.; W/Hyd. Brakes; W/Gov.	355653C91	7380
Belt - A.P.; W/Air Brakes; W/O Gov.	256062C2	7340	Belt - A.P.; W/Hyd. Brakes; W/O Gov.	362887C91	7410
Belt - A.P.; W/Hyd. Brakes; W/Gov.	355653C91	7380	Hose - Upper; W/Rad. Shutters; W/Metal Hood		26515
Belt - A.P.; W/Hyd. Brakes; W/O Gov.	362887C91	7410	Hose - Upper; W/O Rad. Shutters; W/Metal Hood		20493
Hose - Upper; W/Rad. Shutters; W/Metal Hood		26515	Hose - Lower - Eng. To Pipe; W/Auto. Trans.		20532
Hose - Upper; W/O Rad. Shutters; W/Metal Hood		20493	Hose - Lower; W/Man. Trans.		21308
Hose - Lower - Eng. To Pipe; W/Auto. Trans.		20532	Hose - By Pass		②20357
Hose - Lower; W/Man. Trans.		21308			
Hose - By Pass		②20357	1823		
			Belt - Fan & Alt.: W/37A., 52A., 61A. Alt.; C, G, H Chassis; W/P.T.O.	968815R11	②7650
1723			Belt - Fan & Alt.: W/37A., 52A., 61A. Alt.; C, G, H Chassis; W/O P.T.O.	373457C91	②7612
Belt - Fan & Alt.: W/37A., 52A., 61A. Alt.; C, G, H Chassis; W/P.T.O.	968815R11	②7650	Belt - Fan & Alt.: W/37A., 52A., 61A. Alt.; FD, SB Chassis	968815R1	②7650
Belt - Fan & Alt.: W/37A., 52A., 61A. Alt.; C, G, H Chassis; W/O P.T.O.	373457C91	②7612	Belt - Fan & Alt.: W/37A., 61A. Alt.; W/O Air Brakes; W/O P.T.O.; W/O X.C.	373456C1	7612
Belt - Fan & Alt.: W/37A., 52A., 61A. Alt.; FD, SB Chassis	968815R1	②7650	Belt - Fan & Alt.: W/55A., 62A. Alt.; C, G, H Chassis	369723C91	②7630
Belt - Fan & Alt.: W/37A., 61A. Alt.; W/O Air Brakes; W/O P.T.O.; W/O X.C.	373456C1	7612	Belt - Fan & Alt.: W/55A., 62A. Alt.: FD, SB Chassis	361975C91	②7673
Belt - Fan & Alt.: W/55A., 62A. Alt.; C, G, H Chassis	369723C91	②7630	Belt - Fan & Alt.: W/60A. Alt.	359009C91	②7680
Belt - Fan & Alt.: W/55A., 62A. Alt.: FD, SB Chassis	361975C91	②7673	Belt - Fan & Alt.: W/65A., 80A., 105A., 145A. Alt.; W/P.T.O.	361975C91	②7673
Belt - Fan & Alt.: W/60A. Alt.	359009C91	②7680	Belt - Fan & Alt.: W/65A., 80A., 105A., 145A. Alt.; W/O P.T.O.		②7630
Belt - Fan & Alt.: W/65A., 80A., 105A., 145A. Alt.; W/P.T.O.	361975C91	②7673	Belt - Fan & Gen.: W/20A. Alt.	151534R11	②7680
Belt - Fan & Alt.: W/65A., 80A., 105A., 145A. Alt.; W/O P.T.O.		②7630	Belt - Fan & Gen.: W/30A. Alt.	224638R11	②7695
Belt - Fan & Gen.: W/20A. Alt.	151534R11	②7680	Belt - Fan & Gen.: W/35A. Alt.	151535R11	②7695
Belt - Fan & Gen.: W/30A. Alt.	224638R11	②7695	Belt - Fan & Gen.: W/50A. Alt.	151536R11	②7715
Belt - Fan & Gen.: W/35A. Alt.	151535R11	②7695	Belt - P.S.; W/2WD		7460
Belt - Fan & Gen.: W/50A. Alt.	151536R11	②7715	Belt - P.S.; W/4WD	285522C2	7435
Belt - P.S.; W/2WD		7460	Belt - Air Brake Compr.	359007C91	7475
Belt - P.S.; W/4WD	285522C2	7435	Belt - A.P.; W/Air Brakes; W/Gov.	388139C1	7330
Belt - Air Brake Compr.	359007C91	7475	Belt - A.P.; W/Air Brakes; W/O Gov.	256062C2	7340
Belt - A.P.; W/Air Brakes; W/Gov.	388139C1	7330	Belt - A.P.; W/Hyd. Brakes; W/Gov.	355653C91	7380
Belt - A.P.; W/Air Brakes; W/O Gov.	256062C2	7340	Belt - A.P.; W/Hyd. Brakes; W/O Gov.	362887C91	7410
Belt - A.P.; W/Hyd. Brakes; W/Gov.	355653C91	7380			
Belt - A.P.; W/Hyd. Brakes; W/O Gov.	362887C91	7410	International/Navistar V401		
			193RE		
			Belt - Fan; W/52 5/8" Belt O.C.	680611R11	②◆◆9520HD
			Belt - Fan; W/57 5/8" Belt O.C.	261710C11	◆9570HD
			Belt - Alt. To Compr.; W/37A., 60A. Alt.	243605R11	◆9451HD
			Belt - Alt. To Compr.; W/55A. Alt.	264975C11	◆9455HD
			Belt - Gen. To Compr.; W/30A. Gen.	133758R1	◆9440HD
			Belt - Gen. To Compr.; W/35A. Gen.	150560R11	◆9451HD
			Belt - Gen. To Compr.; W/50A. Gen.	201825R11	◆9435HD
			Belt - Gen.; W/Hyd. Brakes	133732R1	◆9360HD
			Belt - P.S.; W/43 1/8" Belt O.C.	164550R11	◆9425HD
			Belt - P.S.; W/44 5/8" Belt O.C.	133758R1	◆9440HD
			Belt - Idler; W/56 1/8" Belt O.C.	968645R11	◆9555HD
			Belt - Idler; W/57 5/8" Belt O.C.	261710C11	◆9570HD

②Two Required.
◆Standard Belt Available.

②Cut to Fit.
◆PowerBand Belt May Work, Use Template to Check.

Belts and Coolant Hose for School Buses

Application	Mfr. Part No.	Our No.	Application	Mfr. Part No.	Our No.
International/Navistar - Continued			International/Navistar - Continued		
1965 - Continued			1965 - Continued		
International/Navistar V461			International/Navistar VS478 - Continued		
193RE			193RE - Continued		
Belt - Fan; W/52 5/8" Belt O.C.	680611R11	②◆◆9520HD	Belt - Gen. To Compr.; W/50A. Gen.	201825R11	◆9435HD
Belt - Fan; W/57 5/8" Belt O.C.	261710C11	◆9570HD	Belt - Gen.; W/Hyd. Brakes	133732R1	◆9360HD
Belt - Alt. To Compr.; W/37A., 60A. Alt.	243605R11	◆9451HD	Belt - P.S.; W/43 1/8" Belt O.C.	164550R11	◆9425HD
Belt - Alt. To Compr.; W/55A. Alt.	264975C11	◆9455HD	Belt - P.S.; W/44 5/8" Belt O.C.	133758R1	◆9440HD
Belt - Gen. To Compr.; W/30A. Gen.	133758R1	◆9440HD	Belt - Idler; W/56 1/8" Belt O.C.	968645R11	◆9555HD
Belt - Gen. To Compr.; W/35A. Gen.	150560R11	◆9451HD	Belt - Idler; W/57 5/8" Belt O.C.	261710C11	◆9570HD
Belt - Gen. To Compr.; W/50A. Gen.	201825R11	◆9435HD			
Belt - Gen.; W/Hyd. Brakes	133732R1	◆9360HD	International/Navistar VS549		
Belt - P.S.; W/43 1/8" Belt O.C.	164550R11	◆9425HD	193RE		
Belt - P.S.; W/44 5/8" Belt O.C.	133758R1	◆9440HD	Belt - Fan; W/52 5/8" Belt O.C.	680611R11	②◆◆9520HD
Belt - Idler; W/56 1/8" Belt O.C.	968645R11	◆9555HD	Belt - Fan; W/57 5/8" Belt O.C.	261710C11	◆9570HD
Belt - Idler; W/57 5/8" Belt O.C.	261710C11	◆9570HD	Belt - Alt. To Compr.; W/37A., 60A. Alt.	243605R11	◆9451HD
			Belt - Alt. To Compr.; W/55A. Alt.	264975C11	◆9455HD
International/Navistar V478			Belt - Gen. To Compr.; W/30A. Gen.	133758R1	◆9440HD
193RE			Belt - Gen. To Compr.; W/35A. Gen.	150560R11	◆9451HD
Belt - Fan; W/52 5/8" Belt O.C.	680611R11	②◆◆9520HD	Belt - Gen. To Compr.; W/50A. Gen.	201825R11	◆9435HD
Belt - Fan; W/57 5/8" Belt O.C.	261710C11	◆9570HD	Belt - Gen.; W/Hyd. Brakes	133732R1	◆9360HD
Belt - Alt. To Compr.; W/37A., 60A. Alt.	243605R11	◆9451HD	Belt - P.S.; W/43 1/8" Belt O.C.	164550R11	◆9425HD
Belt - Alt. To Compr.; W/55A. Alt.	264975C11	◆9455HD	Belt - P.S.; W/44 5/8" Belt O.C.	133758R1	◆9440HD
Belt - Gen. To Compr.; W/30A. Gen.	133758R1	◆9440HD	Belt - Idler; W/56 1/8" Belt O.C.	968645R11	◆9555HD
Belt - Gen. To Compr.; W/35A. Gen.	150560R11	◆9451HD	Belt - Idler; W/57 5/8" Belt O.C.	261710C11	◆9570HD
Belt - Gen. To Compr.; W/50A. Gen.	201825R11	◆9435HD			
Belt - Gen.; W/Hyd. Brakes	133732R1	◆9360HD	1964 - 1963		
Belt - P.S.; W/43 1/8" Belt O.C.	164550R11	◆9425HD	International/Navistar BD220		
Belt - P.S.; W/44 5/8" Belt O.C.	133758R1	◆9440HD	1603		
Belt - Idler; W/56 1/8" Belt O.C.	968645R11	◆9555HD	Belt - Fan & Alt.; W/37A., 52A., 61A., 62A.		
Belt - Idler; W/57 5/8" Belt O.C.	261710C11	◆9570HD	Alt. 151532R1 ②7512		
			Belt - Fan & Alt.; W/60A. Alt. 861779R11 ②◆9440HD		
International/Navistar V549			Belt - Gen.; W/20A., 50A. Alt. 20594VA TR24438		
193RE			Belt - Gen.; W/30A. Alt. 81572R2 TR28437		
Belt - Fan; W/52 5/8" Belt O.C.	680611R11	②◆◆9520HD	Belt - Gen.; W/35A., 50A. L.C.I. Gen. 164550R1 ②◆9425HD		
Belt - Fan; W/57 5/8" Belt O.C.	261710C11	◆9570HD	Belt - P.S.; W/Air Brakes 149636R1 ◆9480HD		
Belt - Alt. To Compr.; W/37A., 60A. Alt.	243605R11	◆9451HD	Belt - P.S.; W/Hyd. Brakes 864931R2 ◆9319HD		
Belt - Alt. To Compr.; W/55A. Alt.	264975C11	◆9455HD	Belt - Air Brake Compr.; W/4 Cu. Ft. Air		
Belt - Gen. To Compr.; W/30A. Gen.	133758R1	◆9440HD	Brake Compr. 201825R1 ◆9440HD		
Belt - Gen. To Compr.; W/35A. Gen.	150560R11	◆9451HD	Belt - Air Brake Compr.; W/20A., 30A.,		
Belt - Gen. To Compr.; W/50A. Gen.	201825R11	◆9435HD	50A. Gen. 115505HA TR22363		
Belt - Gen. To Compr.; W/50A. Gen.	201825R11	◆9435HD	Hose - Upper 26510		
Belt - Gen.; W/Hyd. Brakes	133732R1	◆9360HD	Hose - Lower - Eng. To Pipe 26508		
Belt - P.S.; W/43 1/8" Belt O.C.	164550R11	◆9425HD	Hose - Lower - Pipe To Rad. 26514		
Belt - P.S.; W/44 5/8" Belt O.C.	133758R1	◆9440HD	Hose - By Pass 20338		
Belt - Idler; W/56 1/8" Belt O.C.	968645R11	◆9555HD	or 28441		
Belt - Idler; W/57 5/8" Belt O.C.	261710C11	◆9570HD			
International/Navistar VS401			International/Navistar BD240		
193RE			1603		
Belt - Fan; W/52 5/8" Belt O.C.	680611R11	②◆◆9520HD	Belt - Fan & Alt.; W/37A., 52A., 61A., 62A.		
Belt - Fan; W/57 5/8" Belt O.C.	261710C11	◆9570HD	Alt. 151532R1 ②7512		
Belt - Alt. To Compr.; W/37A., 60A. Alt.	243605R11	◆9451HD	Belt - Fan & Alt.; W/60A. Alt. 861779R11 ②◆9440HD		
Belt - Alt. To Compr.; W/55A. Alt.	264975C11	◆9455HD	Belt - Gen.; W/20A., 50A. Alt. 20594VA TR24438		
Belt - Gen. To Compr.; W/30A. Gen.	133758R1	◆9440HD	Belt - Gen.; W/30A. Alt. 81572R2 TR28437		
Belt - Gen. To Compr.; W/35A. Gen.	150560R11	◆9451HD	Belt - Gen.; W/35A., 50A. L.C.I. Gen. 164550R1 ②◆9425HD		
Belt - Gen. To Compr.; W/50A. Gen.	201825R11	◆9435HD	Belt - P.S.; W/Air Brakes 149636R1 ◆9480HD		
Belt - Gen.; W/Hyd. Brakes	133732R1	◆9360HD	Belt - P.S.; W/Hyd. Brakes 864931R2 ◆9319HD		
Belt - P.S.; W/43 1/8" Belt O.C.	164550R11	◆9425HD	Belt - Air Brake Compr.; W/4 Cu. Ft. Air		
Belt - P.S.; W/44 5/8" Belt O.C.	133758R1	◆9440HD	Brake Compr. 201825R1 ◆9440HD		
Belt - Idler; W/56 1/8" Belt O.C.	968645R11	◆9555HD	Belt - Air Brake Compr.; W/20A., 30A.,		
Belt - Idler; W/57 5/8" Belt O.C.	261710C11	◆9570HD	50A. Gen. 115505HA TR22363		
International/Navistar VS478			Hose - Upper 26510		
193RE			Hose - Lower - Eng. To Pipe 26508		
Belt - Fan; W/52 5/8" Belt O.C.	680611R11	②◆◆9520HD	Hose - Lower - Pipe To Rad. 26514		
Belt - Fan; W/57 5/8" Belt O.C.	261710C11	◆9570HD	Hose - By Pass 20338		
Belt - Alt. To Compr.; W/37A., 60A. Alt.	243605R11	◆9451HD	or 28441		
Belt - Alt. To Compr.; W/55A. Alt.	264975C11	◆9455HD			
Belt - Gen. To Compr.; W/30A. Gen.	133758R1	◆9440HD	International/Navistar BD264		
Belt - Gen. To Compr.; W/35A. Gen.	150560R11	◆9451HD	1603		
			Belt - Fan & Alt.; W/37A., 52A., 61A., 62A.		
			Alt. 151532R1 ②7512		

◆Standard Belt Available.
②Two Required.

◆PowerBand Belt May Work, Use Template to Check.

Belts and Coolant Hose for School Buses

School Buses

Application	Mfr. Part No.	Our No.	Application	Mfr. Part No.	Our No.
International/Navistar - Continued			International/Navistar - Continued		
1964 - 1963 - Continued			1964 - 1963 - Continued		
International/Navistar BD264 - Continued			International/Navistar BD308 - Continued		
1603 - Continued			1703 (School Bus); 1803 - Continued		
Belt - Fan & Alt.; W/60A. Alt.	861779R11	②♣9440HD	Hose - Lower - Eng. To Pipe		♣20206
Belt - Gen.; W/20A., 50A. Alt.	20594VA	TR24438	Hose - Lower - Pipe To Rad.		24232
Belt - Gen.; W/30A. Alt.	81572R2	TR28437	Hose - By Pass		24232
Belt - Gen.; W/35A., 50A. L.C.I. Gen.	164550R1	②♣9425HD	International/Navistar BG220		
Belt - P.S.; W/Air Brakes	149636R1	♣9480HD	1603		
Belt - P.S.; W/Hyd. Brakes	864931R2	♣9319HD	Belt - Fan & Alt.; W/37A., 52A., 61A., 62A. Alt.	151532R1	②7512
Belt - Air Brake Compr.; W/4 Cu. Ft. Air Brake Compr.	201825R1	♣9440HD	Belt - Fan & Alt.; W/60A. Alt.	861779R11	②♣9440HD
Belt - Air Brake Compr.; W/20A., 30A., 50A. Gen.	115505HA	TR22363	Belt - Gen.; W/20A., 50A. Alt.	20594VA	TR24438
Hose - Upper		26510	Belt - Gen.; W/30A. Alt.	81572R2	TR28437
Hose - Lower - Eng. To Pipe		26508	Belt - Gen.; W/35A., 50A. L.C.I. Gen.	164550R1	②♣9425HD
Hose - Lower - Pipe To Rad.		26514	Belt - P.S.; W/Air Brakes	149636R1	♣9480HD
Hose - By Pass		20338	Belt - P.S.; W/Hyd. Brakes	864931R2	♣9319HD
	or	28441	Belt - Air Brake Compr.; W/4 Cu. Ft. Air Brake Compr.	201825R1	♣9440HD
International/Navistar BD269			Belt - Air Brake Compr.; W/20A., 30A., 50A. Gen.	115505HA	TR22363
1603			Hose - Upper		26510
Belt - Fan & Alt.	862880R11	②♣9490HD	Hose - Lower - Eng. To Pipe		26508
Belt - P.S.	242269R1	♣9405HD	Hose - Lower - Pipe To Rad.		26514
Belt - Air Brake Compr.	280210C1	♣9540HD	Hose - By Pass		20338
Hose - Upper		24232		or	28441
Hose - Lower		♣20611	International/Navistar BG241		
	or	26509	1603		
Hose - By Pass		24232	Belt - Fan & Alt.; W/37A., 52A., 61A., 62A. Alt.	151532R1	②7512
1703 (School Bus); 1803			Belt - Fan & Alt.; W/60A. Alt.	861779R11	②♣9440HD
Belt - Fan & Alt.	862880R11	②♣9490HD	Belt - Gen.; W/20A., 50A. Alt.	20594VA	TR24438
Belt - P.S.	242269R1	♣9405HD	Belt - Gen.; W/30A. Alt.	81572R2	TR28437
Belt - Air Brake Compr.	280210C1	♣9540HD	Belt - Gen.; W/35A., 50A. L.C.I. Gen.	164550R1	②♣9425HD
Hose - Upper		24232	Belt - P.S.; W/Air Brakes	149636R1	♣9480HD
Hose - Lower - Eng. To Pipe		♣20206	Belt - P.S.; W/Hyd. Brakes	864931R2	♣9319HD
Hose - Lower - Pipe To Rad.		24232	Belt - Air Brake Compr.; W/4 Cu. Ft. Air Brake Compr.	201825R1	♣9440HD
Hose - By Pass		24232	Belt - Air Brake Compr.; W/20A., 30A., 50A. Gen.	115505HA	TR22363
International/Navistar BD282			Hose - Upper		26510
1603			Hose - Lower - Eng. To Pipe		26508
Belt - Fan & Alt.	862880R11	②♣9490HD	Hose - Lower - Pipe To Rad.		26514
Belt - P.S.	242269R1	♣9405HD	Hose - By Pass		20338
Belt - Air Brake Compr.	280210C1	♣9540HD		or	28441
Hose - Upper		24232	International/Navistar BG265		
Hose - Lower		♣20611	1603		
	or	26509	Belt - Fan & Alt.; W/37A., 52A., 61A., 62A. Alt.	151532R1	②7512
Hose - By Pass		24232	Belt - Fan & Alt.; W/60A. Alt.	861779R11	②♣9440HD
1703 (School Bus); 1803			Belt - Gen.; W/20A., 50A. Alt.	20594VA	TR24438
Belt - Fan & Alt.	862880R11	②♣9490HD	Belt - Gen.; W/30A. Alt.	81572R2	TR28437
Belt - P.S.	242269R1	♣9405HD	Belt - Gen.; W/35A., 50A. L.C.I. Gen.	164550R1	②♣9425HD
Belt - Air Brake Compr.	280210C1	♣9540HD	Belt - P.S.; W/Air Brakes	149636R1	♣9480HD
Hose - Upper		24232	Belt - P.S.; W/Hyd. Brakes	864931R2	♣9319HD
Hose - Lower - Eng. To Pipe		♣20206	Belt - Air Brake Compr.; W/4 Cu. Ft. Air Brake Compr.	201825R1	♣9440HD
Hose - Lower - Pipe To Rad.		24232	Belt - Air Brake Compr.; W/20A., 30A., 50A. Gen.	115505HA	TR22363
Hose - By Pass		24232	Hose - Upper		26510
International/Navistar BD308			Hose - Lower - Eng. To Pipe		26508
1603			Hose - Lower - Pipe To Rad.		26514
Belt - Fan & Alt.	862880R11	②♣9490HD	Hose - By Pass		20338
Belt - P.S.	242269R1	♣9405HD		or	28441
Belt - Air Brake Compr.	280210C1	♣9540HD	International/Navistar FTV549		
Hose - Upper		24232	193RE		
Hose - Lower		♣20611	Belt - Fan; W/52 5/8" Belt O.C.	680611R11	②♣♣9520HD
	or	26509			
Hose - By Pass		24232			
1703 (School Bus); 1803					
Belt - Fan & Alt.	862880R11	②♣9490HD			
Belt - P.S.	242269R1	♣9405HD			
Belt - Air Brake Compr.	280210C1	♣9540HD			
Hose - Upper		24232			
Hose - Lower		♣20611			
	or	26509			
Hose - By Pass		24232			

♣Standard Belt Available.
♣Cut to Fit.

②Two Required.
◆PowerBand Belt May Work, Use Template to Check.

Belts and Coolant Hose for School Buses

Application	Mfr. Part No.	Our No.	Application	Mfr. Part No.	Our No.
International/Navistar - Continued			International/Navistar - Continued		
1964 - 1963 - Continued			1964 - 1963 - Continued		
International/Navistar FTV549 - Continued			International/Navistar RD450 - Continued		
193RE - Continued			1853		
Belt - Fan; W/57 5/8" Belt O.C.	261710C11	♠9570HD	Belt - Alt.; W/55A., 62A., 145A. Alt.	223794K21	②TR22514
Belt - Alt. To Compr.; W/37A., 60A. Alt.	243605R11	♠9451HD	Belt - Gen.; W/37A. Gen.	193826R11	TR22508
Belt - Alt. To Compr.; W/55A. Alt.	264975C11	♠9455HD	Belt - P.S.	240354R1	TR22344
Belt - Gen. To Compr.; W/30A. Gen.	133758R1	♠9440HD	1853FC		
Belt - Gen. To Compr.; W/35A. Gen.	150560R11	♠9451HD	Belt - Alt.; W/55A., 62A., 145A. Alt.	223794K21	②TR22514
Belt - Gen. To Compr.; W/50A. Gen.	201825R11	♠9435HD	Belt - Gen.; W/37A. Gen.	193826R11	TR22508
Belt - Gen.; W/Hyd. Brakes	133732R1	♠9360HD	Belt - P.S.	240354R1	TR22344
Belt - P.S.; W/43 1/8" Belt O.C.	164550R11	♠9425HD	Hose - Upper; Late FD Chassis; Chassis No. FA66376 ...		26509
Belt - P.S.; W/44 5/8" Belt O.C.	133758R1	♠9440HD	Hose - Lower; Early FD Chassis; Chassis No. FA66376 ...		26508
Belt - Idler; W/56 1/8" Belt O.C.	968645R11	♠9555HD	Hose - Lower; Late FD Chassis; Chassis No. FA66376 ...		24234
Belt - Idler; W/57 5/8" Belt O.C.	261710C11	♠9570HD	or		26508
International/Navistar FTVS549			International/Navistar RD501		
193RE			1823		
Belt - Fan; W/52 5/8" Belt O.C.	680611R11	②♠♠9520HD	Hose - Upper		26515
Belt - Fan; W/57 5/8" Belt O.C.	261710C11	♠9570HD	Hose - Lower		24232
Belt - Alt. To Compr.; W/37A., 60A. Alt.	243605R11	♠9451HD	1853		
Belt - Alt. To Compr.; W/55A. Alt.	264975C11	♠9455HD	Belt - Alt.; W/55A., 62A., 145A. Alt.	223794K21	②TR22514
Belt - Gen. To Compr.; W/30A. Gen.	133758R1	♠9440HD	Belt - Gen.; W/37A. Gen.	193826R11	TR22508
Belt - Gen. To Compr.; W/35A. Gen.	150560R11	♠9451HD	Belt - P.S.	240354R1	TR22344
Belt - Gen. To Compr.; W/50A. Gen.	201825R11	♠9435HD	1853FC		
Belt - Gen.; W/Hyd. Brakes	133732R1	♠9360HD	Belt - Alt.; W/55A., 62A., 145A. Alt.	223794K21	②TR22514
Belt - P.S.; W/43 1/8" Belt O.C.	164550R11	♠9425HD	Belt - Gen.; W/37A. Gen.	193826R11	TR22508
Belt - P.S.; W/44 5/8" Belt O.C.	133758R1	♠9440HD	Belt - P.S.	240354R1	TR22344
Belt - Idler; W/56 1/8" Belt O.C.	968645R11	♠9555HD	Hose - Upper; Late FD Chassis; Chassis No. FA66376 ...		26509
Belt - Idler; W/57 5/8" Belt O.C.	261710C11	♠9570HD	Hose - Lower; Early FD Chassis; Chassis No. FA66376 ...		26508
International/Navistar RD372			International/Navistar V266		
1823			1603		
Hose - Upper		26515	Belt - Fan & Alt.; W/37A., 52A. Alt.	255266C11	②7640
Hose - Lower		24232	Belt - Fan & Alt.; W/55A., 62A. Alt.	968815R11	②7650
1853			Belt - Fan & Alt.; W/60A. Alt.	151533R11	②7673
Belt - Alt.; W/55A., 62A., 145A. Alt.	223794K21	②TR22514	Belt - P.S.	151529R1	7440
Belt - Gen.; W/37A. Gen.	193826R11	TR22508	Belt - Air Brake Compr.; W/46 5/8" Belt		
Belt - P.S.	240354R1	TR22344	O.C.	236572R1	7460
1853FC			Belt - Air Brake Compr.; W/45 5/8" Belt		
Belt - Alt.; W/55A., 62A., 145A. Alt.	223794K21	②TR22514	O.C.	151531R1	7450
Belt - Gen.; W/37A. Gen.	193826R11	TR22508	Hose - Upper; W/Rad. Shutters; W/Metal Hood		26515
Belt - P.S.	240354R1	TR22344	Hose - Upper; W/O Rad. Shutters; W/Metal Hood		20493
Hose - Upper; Late FD Chassis; Chassis No. FA66376 ...		26509	Hose - Lower - Eng. To Pipe; W/Auto. Trans.		20532
Hose - Lower; Early FD Chassis; Chassis No. FA66376 ...		26508	Hose - Lower; W/Man. Trans.		21308
Hose - Lower; Late FD Chassis; Chassis No. FA66376 ...		24234	Hose - By Pass		≈20357
or		26508	1703 (School Bus)		
International/Navistar RD406			Belt - Fan & Alt.; W/37A., 52A. Alt.		
1823			255266C11		
Hose - Upper		26515	Belt - Fan & Alt.; W/55A., 62A. Alt.	968815R11	②7650
Hose - Lower		24232	Belt - Fan & Alt.; W/60A. Alt.	151533R11	②7673
1853			Belt - P.S.; W/4WD	681956R1	7425
Belt - Alt.; W/55A., 62A., 145A. Alt.	223794K21	②TR22514	Belt - Air Brake Compr.; W/46 5/8" Belt		
Belt - Gen.; W/37A. Gen.	193826R11	TR22508	O.C.	236572R1	7460
Belt - P.S.	240354R1	TR22344	Belt - Air Brake Compr.; W/45 5/8" Belt		
1853FC			O.C.	151531R1	7450
Belt - Alt.; W/55A., 62A., 145A. Alt.	223794K21	②TR22514	Hose - Upper; W/Rad. Shutters; W/Metal Hood		26515
Belt - Gen.; W/37A. Gen.	193826R11	TR22508	Hose - Upper; W/O Rad. Shutters; W/Metal Hood		20493
Belt - P.S.	240354R1	TR22344	Hose - Lower - Eng. To Pipe; W/Auto. Trans.		20532
Hose - Upper; Late FD Chassis; Chassis No. FA66376 ...		26509	Hose - Lower; W/Man. Trans.		21308
Hose - Lower; Early FD Chassis; Chassis No. FA66376 ...		26508	Hose - By Pass		≈20357
Hose - Lower; Late FD Chassis; Chassis No. FA66376 ...		24234	1803		
or		26508	Belt - Fan & Alt.; W/37A., 52A. Alt.		
International/Navistar RD450			255266C11		
1823			②7640		
Hose - Upper		26515	Belt - Fan & Alt.; W/55A., 62A. Alt.	968815R11	②7650
Hose - Lower		24232	Belt - Fan & Alt.; W/60A. Alt.	151533R11	②7673
			Belt - P.S.	151529R1	7440
			Belt - Air Brake Compr.; W/46 5/8" Belt		
			O.C.	236572R1	7460

♠Standard Belt Available.
②Two Required.

◆PowerBand Belt May Work. Use Template to Check.
≈Cut to Fit.

School Buses

Belts and Coolant Hose for School Buses

School Buses

Application	Mfr. Part No.	Our No.	Application	Mfr. Part No.	Our No.
International/Navistar - Continued			International/Navistar - Continued		
1964 - 1963 - Continued			1964 - 1963 - Continued		
International/Navistar V266 - Continued			International/Navistar V345 - Continued		
1803 - Continued			1603; 1703 (School Bus) - Continued		
Belt - Air Brake Compr.; W/45 5/8" Belt			Belt - Fan & Alt.; W/65A., 80A., 105A., 145A. Alt; W/P.T.O.	361975C91	②7673
O.C.	151531R1	7450	Belt - Fan & Alt.; W/65A., 80A., 105A., 145A. Alt.; W/O P.T.O.		②7630
Hose - Upper; W/Rad. Shutters; W/Metal Hood		26515	Belt - Fan & Gen.; W/20A. Alt.	151534R11	②7680
Hose - Upper; W/O Rad. Shutters; W/Metal Hood		20493	Belt - Fan & Gen.; W/30A. Alt.	224638R11	②7695
Hose - Lower - Eng. To Pipe; W/Auto. Trans.		20532	Belt - Fan & Gen.; W/35A. Alt.	151535R11	②7695
Hose - Lower; W/Man. Trans.		21308	Belt - Fan & Gen.; W/50A. Alt.	151536R11	②7715
Hose - By Pass		≈20357	Belt - P.S.; W/2WD		7460
International/Navistar V304			Belt - P.S.; W/4WD	285522C2	7435
1603			Belt - Air Brake Compr.	359007C91	7475
Belt - Fan & Alt.; W/37A., 52A. Alt.	255266C11	②7640	Belt - A.P.; W/Air Brakes; W/Gov.	388139C1	7330
Belt - Fan & Alt.; W/55A., 62A. Alt.	968815R11	②7650	Belt - A.P.; W/Air Brakes; W/O Gov.	256062C2	7340
Belt - Fan & Alt.; W/60A. Alt.	151533R11	②7673	Belt - A.P.; W/Hyd. Brakes; W/Gov.	355653C91	7380
Belt - P.S.	225532R1	7450	Belt - A.P.; W/Hyd. Brakes; W/O Gov.	362887C91	7410
Belt - Air Brake Compr.; W/46 5/8" Belt			Hose - Upper; W/Rad. Shutters; W/Metal Hood		26515
O.C.	236572R1	7460	Hose - Upper; W/O Rad. Shutters; W/Metal Hood		20493
Belt - Air Brake Compr.; W/45 5/8" Belt			Hose - Lower - Eng. To Pipe; W/Auto. Trans.		20532
O.C.	151531R1	7450	Hose - Lower; W/Man. Trans.		21308
Hose - Upper; W/Rad. Shutters; W/Metal Hood		26515	Hose - By Pass		≈20357
Hose - Upper; W/O Rad. Shutters; W/Metal Hood		20493	1723		
Hose - Lower - Eng. To Pipe; W/Auto. Trans.		20532	Belt - Fan & Alt.; W/37A., 52A., 61A. Alt.; C, G, H Chassis; W/P.T.O.	968815R11	②7650
Hose - Lower; W/Man. Trans.		21308	Belt - Fan & Alt.; W/37A., 52A., 61A. Alt.; C, G, H Chassis; W/O P.T.O.	373457C91	②7612
Hose - By Pass		≈20357	Belt - Fan & Alt.; W/37A., 52A., 61A. Alt.; FD, SB Chassis	968815R1	②7650
1703 (School Bus)			Belt - Fan & Alt.; W/37A., 61A. Alt.; W/O Air Brakes; W/O P.T.O.; W/O X.C.	373456C1	7612
Belt - Fan & Alt.; W/37A., 52A. Alt.	255266C11	②7640	Belt - Fan & Alt.; W/55A., 62A. Alt.; C, G, H Chassis	369723C91	②7630
Belt - Fan & Alt.; W/55A., 62A. Alt.	968815R11	②7650	Belt - Fan & Alt.; W/55A., 62A. Alt.; FD, SB Chassis	361975C91	②7673
Belt - Fan & Alt.; W/60A. Alt.	151533R11	②7673	Belt - Fan & Alt.; W/60A. Alt.	359009C91	②7680
Belt - P.S.; W/4WD	681956R1	7425	Belt - Fan & Alt.; W/65A., 80A., 105A., 145A. Alt; W/P.T.O.	361975C91	②7673
Belt - Air Brake Compr.; W/46 5/8" Belt			Belt - Fan & Alt.; W/65A., 80A., 105A., 145A. Alt.; W/O P.T.O.		②7630
O.C.	236572R1	7460	Belt - Fan & Gen.; W/20A. Alt.	151534R11	②7680
Belt - Air Brake Compr.; W/45 5/8" Belt			Belt - Fan & Gen.; W/30A. Alt.	224638R11	②7695
O.C.	151531R1	7450	Belt - Fan & Gen.; W/35A. Alt.	151535R11	②7695
Hose - Upper; W/Rad. Shutters; W/Metal Hood		26515	Belt - Fan & Gen.; W/50A. Alt.	151536R11	②7715
Hose - Upper; W/O Rad. Shutters; W/Metal Hood		20493	Belt - P.S.; W/2WD		7460
Hose - Lower - Eng. To Pipe; W/Auto. Trans.		20532	Belt - P.S.; W/4WD	285522C2	7435
Hose - Lower; W/Man. Trans.		21308	Belt - Air Brake Compr.	359007C91	7475
Hose - By Pass		≈20357	Belt - A.P.; W/Air Brakes; W/Gov.	388139C1	7330
1803			Belt - A.P.; W/Air Brakes; W/O Gov.	256062C2	7340
Belt - Fan & Alt.; W/37A., 52A. Alt.	255266C11	②7640	Belt - A.P.; W/Hyd. Brakes; W/Gov.	355653C91	7380
Belt - Fan & Alt.; W/55A., 62A. Alt.	968815R11	②7650	Belt - A.P.; W/Hyd. Brakes; W/O Gov.	362887C91	7410
Belt - Fan & Alt.; W/60A. Alt.	151533R11	②7673	1803		
Belt - P.S.	225532R1	7450	Belt - Fan & Alt.; W/37A., 52A., 61A. Alt.; C, G, H Chassis; W/P.T.O.	968815R11	②7650
Belt - Air Brake Compr.; W/46 5/8" Belt			Belt - Fan & Alt.; W/37A., 52A., 61A. Alt.; C, G, H Chassis; W/O P.T.O.	373457C91	②7612
O.C.	236572R1	7460	Belt - Fan & Alt.; W/37A., 52A., 61A. Alt.; FD, SB Chassis	968815R1	②7650
Belt - Air Brake Compr.; W/45 5/8" Belt			Belt - Fan & Alt.; W/37A., 61A. Alt.; W/O Air Brakes; W/O P.T.O.; W/O X.C.	373456C1	7612
O.C.	151531R1	7450	Belt - Fan & Alt.; W/55A., 62A. Alt.; C, G, H Chassis	369723C91	②7630
Hose - Upper; W/Rad. Shutters; W/Metal Hood		26515	Belt - Fan & Alt.; W/55A., 62A. Alt.; FD, SB Chassis	361975C91	②7673
Hose - Upper; W/O Rad. Shutters; W/Metal Hood		20493	Belt - Fan & Alt.; W/60A. Alt.	359009C91	②7680
Hose - Lower - Eng. To Pipe; W/Auto. Trans.		20532	Belt - Fan & Alt.; W/65A., 80A., 105A., 145A. Alt; W/P.T.O.	361975C91	②7673
Hose - Lower; W/Man. Trans.		21308	Belt - Fan & Alt.; W/65A., 80A., 105A., 145A. Alt.; W/O P.T.O.		②7630
Hose - By Pass		≈20357	International/Navistar V345		
International/Navistar V345			1603; 1703 (School Bus)		
1603; 1703 (School Bus)			Belt - Fan & Alt.; W/37A., 52A., 61A. Alt.; C, G, H Chassis; W/P.T.O.	968815R11	②7650
Belt - Fan & Alt.; W/37A., 52A., 61A. Alt.; C, G, H Chassis; W/O P.T.O.			Belt - Fan & Alt.; W/37A., 52A., 61A. Alt.; C, G, H Chassis; W/O P.T.O.	373457C91	②7612
Belt - Fan & Alt.; W/37A., 52A., 61A. Alt.; FD, SB Chassis			Belt - Fan & Alt.; W/37A., 52A., 61A. Alt.; FD, SB Chassis	968815R1	②7650
Belt - Fan & Alt.; W/37A., 61A. Alt.; W/O Air Brakes; W/O P.T.O.; W/O X.C.			Belt - Fan & Alt.; W/37A., 61A. Alt.; W/O Air Brakes; W/O P.T.O.; W/O X.C.	373456C1	7612
Belt - Fan & Alt.; W/55A., 62A. Alt.; C, G, H Chassis			Belt - Fan & Alt.; W/55A., 62A. Alt.; C, G, H Chassis	369723C91	②7630
Belt - Fan & Alt.; W/55A., 62A. Alt.; FD, SB Chassis			Belt - Fan & Alt.; W/55A., 62A. Alt.; FD, SB Chassis	361975C91	②7673
Belt - Fan & Alt.; W/60A. Alt.			Belt - Fan & Alt.; W/60A. Alt.	359009C91	②7680
Belt - Fan & Alt.; W/65A., 80A., 105A., 145A. Alt; W/P.T.O.			Belt - Fan & Alt.; W/65A., 80A., 105A., 145A. Alt; W/P.T.O.	361975C91	②7673
Belt - Fan & Alt.; W/65A., 80A., 105A., 145A. Alt.; W/O P.T.O.			Belt - Fan & Alt.; W/65A., 80A., 105A., 145A. Alt.; W/O P.T.O.		②7630

≈Cut to Fit.

②Two Required.

Belts and Coolant Hose for School Buses

Application	Mfr. Part No.	Our No.	Application	Mfr. Part No.	Our No.
International/Navistar - Continued			International/Navistar - Continued		
1964 - 1963 - Continued			1964 - 1963 - Continued		
International/Navistar V345 - Continued			International/Navistar V392 - Continued		
1803 - Continued			1603; 1703 (School Bus) - Continued		
Belt - Fan & Gen.; W/20A. Alt.	151534R11	②7680	Belt - Fan & Gen.; W/35A. Alt.	151535R11	②7695
Belt - Fan & Gen.; W/30A. Alt.	224638R11	②7695	Belt - Fan & Gen.; W/50A. Alt.	151536R11	②7715
Belt - Fan & Gen.; W/35A. Alt.	151535R11	②7695	Belt - P.S.; W/2WD		7460
Belt - Fan & Gen.; W/50A. Alt.	151536R11	②7715	Belt - P.S.; W/4WD	285522C2	7435
Belt - P.S.; W/2WD		7460	Belt - Air Brake Compr.	359007C91	7475
Belt - P.S.; W/4WD	285522C2	7435	Belt - A.P.; W/Air Brakes; W/Gov.	388139C1	7330
Belt - Air Brake Compr.	359007C91	7475	Belt - A.P.; W/Air Brakes; W/O Gov.	256062C2	7340
Belt - A.P.; W/Air Brakes; W/Gov.	388139C1	7330	Belt - A.P.; W/Hyd. Brakes; W/Gov.	355653C91	7380
Belt - A.P.; W/Air Brakes; W/O Gov.	256062C2	7340	Belt - A.P.; W/Hyd. Brakes; W/O Gov.	362887C91	7410
Belt - A.P.; W/Hyd. Brakes; W/Gov.	355653C91	7380	Hose - Upper; W/Rad. Shutters; W/Metal Hood		26515
Belt - A.P.; W/Hyd. Brakes; W/O Gov.	362887C91	7410	Hose - Upper; W/O Rad. Shutters; W/Metal Hood		20493
Hose - Upper; W/Rad. Shutters; W/Metal Hood		26515	Hose - Lower - Eng. To Pipe; W/Auto. Trans.		20532
Hose - Upper; W/O Rad. Shutters; W/Metal Hood		20493	Hose - Lower; W/Man. Trans.		21308
Hose - Lower - Eng. To Pipe; W/Auto. Trans.		20532	Hose - By Pass		≈20357
Hose - Lower; W/Man. Trans.		21308			
Hose - By Pass		≈20357	1723		
1823			Belt - Fan & Alt.; W/37A., 52A., 61A. Alt.; C, G, H Chassis; W/P.T.O.	968815R11	②7650
Belt - Fan & Alt.; W/37A., 52A., 61A. Alt.; C, G, H Chassis; W/P.T.O.	968815R11	②7650	Belt - Fan & Alt.; W/37A., 52A., 61A. Alt.; C, G, H Chassis; W/O P.T.O.	373457C91	②7612
Belt - Fan & Alt.; W/37A., 52A., 61A. Alt.; C, G, H Chassis; W/O P.T.O.	373457C91	②7612	Belt - Fan & Alt.; W/37A., 52A., 61A. Alt.; FD, SB Chassis	968815R1	②7650
Belt - Fan & Alt.; W/37A., 52A., 61A. Alt.; FD, SB Chassis	968815R1	②7650	Belt - Fan & Alt.; W/37A., 61A. Alt.; W/O Air Brakes; W/O P.T.O.; W/O X.C.	373456C1	7612
Belt - Fan & Alt.; W/37A., 61A. Alt.; W/O Air Brakes; W/O P.T.O.; W/O X.C.	373456C1	7612	Belt - Fan & Alt.; W/55A., 62A. Alt.; C, G, H Chassis	369723C91	②7630
Belt - Fan & Alt.; W/55A., 62A. Alt.; C, G, H Chassis	369723C91	②7630	Belt - Fan & Alt.; W/55A., 62A. Alt.; FD, SB Chassis	361975C91	②7673
Belt - Fan & Alt.; W/55A., 62A. Alt.; FD, SB Chassis	361975C91	②7673	Belt - Fan & Alt.; W/60A. Alt.	359009C91	②7680
Belt - Fan & Alt.; W/60A. Alt.	359009C91	②7680	Belt - Fan & Alt.; W/65A., 80A., 105A., 145A. Alt; W/P.T.O.	361975C91	②7673
Belt - Fan & Alt.; W/65A., 80A., 105A., 145A. Alt; W/P.T.O.	361975C91	②7673	Belt - Fan & Alt.; W/65A., 80A., 105A., 145A. Alt.; W/O P.T.O.		②7630
Belt - Fan & Alt.; W/65A., 80A., 105A., 145A. Alt.; W/O P.T.O.		②7630	Belt - Fan & Gen.; W/20A. Alt.	151534R11	②7680
Belt - Fan & Gen.; W/20A. Alt.	151534R11	②7680	Belt - Fan & Gen.; W/30A. Alt.	224638R11	②7695
Belt - Fan & Gen.; W/30A. Alt.	224638R11	②7695	Belt - Fan & Gen.; W/35A. Alt.	151535R11	②7695
Belt - Fan & Gen.; W/35A. Alt.	151535R11	②7695	Belt - Fan & Gen.; W/50A. Alt.	151536R11	②7715
Belt - Fan & Gen.; W/50A. Alt.	151536R11	②7715	Belt - P.S.; W/2WD		7460
Belt - P.S.; W/2WD		7460	Belt - P.S.; W/4WD	285522C2	7435
Belt - P.S.; W/4WD	285522C2	7435	Belt - Air Brake Compr.	359007C91	7475
Belt - Air Brake Compr.	359007C91	7475	Belt - A.P.; W/Air Brakes; W/Gov.	388139C1	7330
Belt - A.P.; W/Air Brakes; W/Gov.	388139C1	7330	Belt - A.P.; W/Air Brakes; W/O Gov.	256062C2	7340
Belt - A.P.; W/Air Brakes; W/O Gov.	256062C2	7340	Belt - A.P.; W/Hyd. Brakes; W/Gov.	355653C91	7380
Belt - A.P.; W/Hyd. Brakes; W/Gov.	355653C91	7380	Belt - A.P.; W/Hyd. Brakes; W/O Gov.	362887C91	7410
Belt - A.P.; W/Hyd. Brakes; W/O Gov.	362887C91	7410			
			1803		
			Belt - Fan & Alt.; W/37A., 52A., 61A. Alt.; C, G, H Chassis; W/P.T.O.	968815R11	②7650
			Belt - Fan & Alt.; W/37A., 52A., 61A. Alt.; C, G, H Chassis; W/O P.T.O.	373457C91	②7612
			Belt - Fan & Alt.; W/37A., 52A., 61A. Alt.; FD, SB Chassis	968815R1	②7650
			Belt - Fan & Alt.; W/37A., 61A. Alt.; W/O Air Brakes; W/O P.T.O.; W/O X.C.	373456C1	7612
			Belt - Fan & Alt.; W/55A., 62A. Alt.; C, G, H Chassis	369723C91	②7630
			Belt - Fan & Alt.; W/55A., 62A. Alt.; FD, SB Chassis	361975C91	②7673
			Belt - Fan & Alt.; W/60A. Alt.	359009C91	②7680
			Belt - Fan & Alt.; W/65A., 80A., 105A., 145A. Alt; W/P.T.O.	361975C91	②7673
			Belt - Fan & Alt.; W/65A., 80A., 105A., 145A. Alt.; W/O P.T.O.		②7630
			Belt - Fan & Gen.; W/20A. Alt.	151534R11	②7680
			Belt - Fan & Gen.; W/30A. Alt.	224638R11	②7695
			Belt - Fan & Gen.; W/35A. Alt.	151535R11	②7695
			Belt - Fan & Gen.; W/50A. Alt.	151536R11	②7715
			Belt - P.S.; W/2WD		7460
			Belt - P.S.; W/4WD	285522C2	7435

School Buses

②Two Required.

≈Cut to Fit.

Belts and Coolant Hose for School Buses

School Buses

Application	Mfr. Part No.	Our No.	Application	Mfr. Part No.	Our No.
International/Navistar - Continued			International/Navistar - Continued		
1964 - 1963 - Continued			1964 - 1963 - Continued		
International/Navistar V392 - Continued			International/Navistar V461 - Continued		
1803 - Continued			193RE - Continued		
Belt - Air Brake Compr.	359007C91	7475	Belt - Idler; W/56 1/8" Belt O.C.	968645R11	◆9555HD
Belt - A.P.; W/Air Brakes; W/Gov.	388139C1	7330	Belt - Idler; W/57 5/8" Belt O.C.	261710C11	◆9570HD
Belt - A.P.; W/Air Brakes; W/O Gov.	256062C2	7340	International/Navistar V478		
Belt - A.P.; W/Hyd. Brakes; W/Gov.	355653C91	7380	193RE		
Belt - A.P.; W/Hyd. Brakes; W/O Gov.	362887C91	7410	Belt - Fan; W/52 5/8" Belt O.C.	680611R11	②◆◆9520HD
Hose - Upper; W/Rad. Shutters; W/Metal Hood		26515	Belt - Fan; W/57 5/8" Belt O.C.	261710C11	◆9570HD
Hose - Upper; W/O Rad. Shutters; W/Metal Hood		20493	Belt - Alt. To Compr.; W/37A., 60A. Alt.	243605R11	◆9451HD
Hose - Lower - Eng. To Pipe; W/Auto. Trans.		20532	Belt - Alt. To Compr.; W/55A. Alt.	264975C11	◆9455HD
Hose - Lower; W/Man. Trans.		21308	Belt - Gen. To Compr.; W/30A. Gen.	133758R1	◆9440HD
Hose - By Pass		≈20357	Belt - Gen. To Compr.; W/35A. Gen.	150560R11	◆9451HD
1823			Belt - Gen. To Compr.; W/50A. Gen.	201825R11	◆9435HD
Belt - Fan & Alt.; W/37A., 52A., 61A. Alt.; C, G, H Chassis; W/P.T.O.	968815R11	②7650	Belt - Gen.; W/Hyd. Brakes	133732R1	◆9360HD
Belt - Fan & Alt.; W/37A., 52A., 61A. Alt.; C, G, H Chassis; W/O P.T.O.	373457C91	②7612	Belt - P.S.; W/43 1/8" Belt O.C.	164550R11	◆9425HD
Belt - Fan & Alt.; W/37A., 52A., 61A. Alt.; FD, SB Chassis	968815R1	②7650	Belt - P.S.; W/44 5/8" Belt O.C.	133758R1	◆9440HD
Belt - Fan & Alt.; W/37A., 61A. Alt.; W/O Air Brakes; W/O P.T.O.; W/O X.C.	373456C1	7612	Belt - Idler; W/56 1/8" Belt O.C.	968645R11	◆9555HD
Belt - Fan & Alt.; W/55A., 62A. Alt.; C, G, H Chassis	369723C91	②7630	Belt - Idler; W/57 5/8" Belt O.C.	261710C11	◆9570HD
Belt - Fan & Alt.; W/55A., 62A. Alt.; FD, SB Chassis	361975C91	②7673	International/Navistar V549		
Belt - Fan & Alt.; W/60A. Alt.	359009C91	②7680	193RE		
Belt - Fan & Alt.; W/65A., 80A., 105A., 145A. Alt.; W/P.T.O.	361975C91	②7673	Belt - Fan; W/52 5/8" Belt O.C.	680611R11	②◆◆9520HD
Belt - Fan & Alt.; W/65A., 80A., 105A., 145A. Alt.; W/O P.T.O.		②7630	Belt - Fan; W/57 5/8" Belt O.C.	261710C11	◆9570HD
Belt - Fan & Gen.; W/20A. Alt.	151534R11	②7680	Belt - Alt. To Compr.; W/37A., 60A. Alt.	243605R11	◆9451HD
Belt - Fan & Gen.; W/30A. Alt.	224638R11	②7695	Belt - Alt. To Compr.; W/55A. Alt.	264975C11	◆9455HD
Belt - Fan & Gen.; W/35A. Alt.	151535R11	②7695	Belt - Gen. To Compr.; W/30A. Gen.	133758R1	◆9440HD
Belt - Fan & Gen.; W/50A. Alt.	151536R11	②7715	Belt - Gen. To Compr.; W/35A. Gen.	150560R11	◆9451HD
Belt - P.S.; W/2WD		7460	Belt - Gen. To Compr.; W/50A. Gen.	201825R11	◆9435HD
Belt - P.S.; W/4WD	285522C2	7435	Belt - Gen.; W/Hyd. Brakes	133732R1	◆9360HD
Belt - Air Brake Compr.	359007C91	7475	Belt - P.S.; W/43 1/8" Belt O.C.	164550R11	◆9425HD
Belt - A.P.; W/Air Brakes; W/Gov.	388139C1	7330	Belt - P.S.; W/44 5/8" Belt O.C.	133758R1	◆9440HD
Belt - A.P.; W/Air Brakes; W/O Gov.	256062C2	7340	Belt - Idler; W/56 1/8" Belt O.C.	968645R11	◆9555HD
Belt - A.P.; W/Hyd. Brakes; W/Gov.	355653C91	7380	Belt - Idler; W/57 5/8" Belt O.C.	261710C11	◆9570HD
Belt - A.P.; W/Hyd. Brakes; W/O Gov.	362887C91	7410	International/Navistar VS401		
International/Navistar V401			193RE		
193RE			Belt - Fan; W/52 5/8" Belt O.C.	680611R11	②◆◆9520HD
Belt - Fan; W/52 5/8" Belt O.C.	680611R11	②◆◆9520HD	Belt - Fan; W/57 5/8" Belt O.C.	261710C11	◆9570HD
Belt - Fan; W/57 5/8" Belt O.C.	261710C11	◆9570HD	Belt - Alt. To Compr.; W/37A., 60A. Alt.	243605R11	◆9451HD
Belt - Alt. To Compr.; W/37A., 60A. Alt.	243605R11	◆9451HD	Belt - Alt. To Compr.; W/55A. Alt.	264975C11	◆9455HD
Belt - Alt. To Compr.; W/55A. Alt.	264975C11	◆9455HD	Belt - Gen. To Compr.; W/30A. Gen.	133758R1	◆9440HD
Belt - Gen. To Compr.; W/30A. Gen.	133758R1	◆9440HD	Belt - Gen. To Compr.; W/35A. Gen.	150560R11	◆9451HD
Belt - Gen. To Compr.; W/35A. Gen.	150560R11	◆9451HD	Belt - Gen. To Compr.; W/50A. Gen.	201825R11	◆9435HD
Belt - Gen. To Compr.; W/50A. Gen.	201825R11	◆9435HD	Belt - Gen.; W/Hyd. Brakes	133732R1	◆9360HD
Belt - Gen.; W/Hyd. Brakes	133732R1	◆9360HD	Belt - P.S.; W/43 1/8" Belt O.C.	164550R11	◆9425HD
Belt - P.S.; W/43 1/8" Belt O.C.	164550R11	◆9425HD	Belt - P.S.; W/44 5/8" Belt O.C.	133758R1	◆9440HD
Belt - P.S.; W/44 5/8" Belt O.C.	133758R1	◆9440HD	Belt - Idler; W/56 1/8" Belt O.C.	968645R11	◆9555HD
Belt - Idler; W/56 1/8" Belt O.C.	968645R11	◆9555HD	Belt - Idler; W/57 5/8" Belt O.C.	261710C11	◆9570HD
Belt - Idler; W/57 5/8" Belt O.C.	261710C11	◆9570HD	International/Navistar VS478		
International/Navistar V461			193RE		
193RE			Belt - Fan; W/52 5/8" Belt O.C.	680611R11	②◆◆9520HD
Belt - Fan; W/52 5/8" Belt O.C.	680611R11	②◆◆9520HD	Belt - Fan; W/57 5/8" Belt O.C.	261710C11	◆9570HD
Belt - Fan; W/57 5/8" Belt O.C.	261710C11	◆9570HD	Belt - Alt. To Compr.; W/37A., 60A. Alt.	243605R11	◆9451HD
Belt - Alt. To Compr.; W/37A., 60A. Alt.	243605R11	◆9451HD	Belt - Alt. To Compr.; W/55A. Alt.	264975C11	◆9455HD
Belt - Alt. To Compr.; W/55A. Alt.	264975C11	◆9455HD	Belt - Gen. To Compr.; W/30A. Gen.	133758R1	◆9440HD
Belt - Gen. To Compr.; W/30A. Gen.	133758R1	◆9440HD	Belt - Gen. To Compr.; W/35A. Gen.	150560R11	◆9451HD
Belt - Gen. To Compr.; W/35A. Gen.	150560R11	◆9451HD	Belt - Gen. To Compr.; W/50A. Gen.	201825R11	◆9435HD
Belt - Gen. To Compr.; W/50A. Gen.	201825R11	◆9435HD	Belt - Gen.; W/Hyd. Brakes	133732R1	◆9360HD
Belt - Gen.; W/Hyd. Brakes	133732R1	◆9360HD	Belt - P.S.; W/43 1/8" Belt O.C.	164550R11	◆9425HD
Belt - P.S.; W/43 1/8" Belt O.C.	164550R11	◆9425HD	Belt - P.S.; W/44 5/8" Belt O.C.	133758R1	◆9440HD
Belt - P.S.; W/44 5/8" Belt O.C.	133758R1	◆9440HD	Belt - Idler; W/56 1/8" Belt O.C.	968645R11	◆9555HD
Belt - Idler; W/56 1/8" Belt O.C.	968645R11	◆9555HD	Belt - Idler; W/57 5/8" Belt O.C.	261710C11	◆9570HD
Belt - Idler; W/57 5/8" Belt O.C.	261710C11	◆9570HD	International/Navistar VS549		
International/Navistar V461			193RE		
193RE			Belt - Fan; W/52 5/8" Belt O.C.	680611R11	②◆◆9520HD
Belt - Fan; W/52 5/8" Belt O.C.	680611R11	②◆◆9520HD	Belt - Fan; W/57 5/8" Belt O.C.	261710C11	◆9570HD
Belt - Fan; W/57 5/8" Belt O.C.	261710C11	◆9570HD			

 ≈Cut to Fit.
 ◆Standard Belt Available.

 ②Two Required.
 ◆PowerBand Belt May Work, Use Template to Check.

Belts and Coolant Hose for School Buses

Application	Mfr. Part No.	Our No.	Application	Mfr. Part No.	Our No.
International/Navistar - Continued			International/Navistar - Continued		
1964 - 1963 - Continued			1962 - Continued		
International/Navistar VS549 - Continued			International/Navistar BD264 - Continued		
193RE - Continued			1603 - Continued		
Belt - Alt. To Compr.; W/37A., 60A. Alt.	243605R11	♣9451HD	Hose - Lower - Eng. To Pipe		26508
Belt - Alt. To Compr.; W/55A. Alt.	264975C11	♣9455HD	Hose - Lower - Pipe To Rad.		26514
Belt - Gen. To Compr.; W/30A. Gen.	133758R1	♣9440HD	Hose - By Pass		20338
Belt - Gen. To Compr.; W/35A. Gen.	150560R11	♣9451HD		or	28441
Belt - Gen. To Compr.; W/50A. Gen.	201825R11	♣9435HD	International/Navistar BD269		
Belt - Gen.; W/Hyd. Brakes	133732R1	♣9360HD	1603		
Belt - P.S.; W/43 1/8" Belt O.C.	164550R11	♣9425HD	Belt - Fan & Alt.	862880R11	②♣9490HD
Belt - P.S.; W/44 5/8" Belt O.C.	133758R1	♣9440HD	Belt - P.S.	242269R1	♣9405HD
Belt - Idler; W/56 1/8" Belt O.C.	968645R11	♣9555HD	Belt - Air Brake Compr.	280210C1	♣9540HD
Belt - Idler; W/57 5/8" Belt O.C.	261710C11	♣9570HD	Hose - Upper		24232
			Hose - Lower		♣20611
				or	26509
			Hose - By Pass		24232
1962			1703 (School Bus); 1803		
International/Navistar BD220			Belt - Fan & Alt.		
1603			Belt - P.S.		
Belt - Fan & Alt.; W/37A., 52A., 61A., 62A. Alt.	151532R1	②7512	Belt - Air Brake Compr.	280210C1	♣9540HD
Belt - Fan & Alt.; W/60A. Alt.	861779R11	②♣9440HD	Hose - Upper		24232
Belt - Gen.; W/20A., 50A. Alt.	20594VA	TR24438	Hose - Lower - Eng. To Pipe		♣20206
Belt - Gen.; W/30A. Alt.	81572R2	TR28437	Hose - Lower - Pipe To Rad.		24232
Belt - Gen.; W/35A., 50A. L.C.I. Gen.	164550R1	②♣9425HD	Hose - By Pass		24232
Belt - P.S.; W/Air Brakes	149636R1	♣9480HD	International/Navistar BD282		
Belt - P.S.; W/Hyd. Brakes	864931R2	♣9319HD	1603		
Belt - Air Brake Compr.; W/4 Cu. Ft. Air Brake Compr.	201825R1	♣9440HD	Belt - Fan & Alt.	862880R11	②♣9490HD
Belt - Air Brake Compr.; W/20A., 30A., 50A. Gen.	115505HA	TR22363	Belt - P.S.	242269R1	♣9405HD
Hose - Upper		26510	Belt - Air Brake Compr.	280210C1	♣9540HD
Hose - Lower - Eng. To Pipe		26508	Hose - Upper		24232
Hose - Lower - Pipe To Rad.		26514	Hose - Lower		♣20611
Hose - By Pass		20338		or	26509
	or	28441	Hose - By Pass		24232
International/Navistar BD240			1703 (School Bus); 1803		
1603			Belt - Fan & Alt.		
Belt - Fan & Alt.; W/37A., 52A., 61A., 62A. Alt.	151532R1	②7512	Belt - P.S.	242269R1	♣9405HD
Belt - Fan & Alt.; W/60A. Alt.	861779R11	②♣9440HD	Belt - Air Brake Compr.	280210C1	♣9540HD
Belt - Gen.; W/20A., 50A. Alt.	20594VA	TR24438	Hose - Upper		24232
Belt - Gen.; W/30A. Alt.	81572R2	TR28437	Hose - Lower - Eng. To Pipe		♣20206
Belt - Gen.; W/35A., 50A. L.C.I. Gen.	164550R1	②♣9425HD	Hose - Lower - Pipe To Rad.		24232
Belt - P.S.; W/Air Brakes	149636R1	♣9480HD	Hose - By Pass		24232
Belt - P.S.; W/Hyd. Brakes	864931R2	♣9319HD	International/Navistar BD308		
Belt - Air Brake Compr.; W/4 Cu. Ft. Air Brake Compr.	201825R1	♣9440HD	1603		
Belt - Air Brake Compr.; W/20A., 30A., 50A. Gen.	115505HA	TR22363	Belt - Fan & Alt.	862880R11	②♣9490HD
Hose - Upper		26510	Belt - P.S.	242269R1	♣9405HD
Hose - Lower - Eng. To Pipe		26508	Belt - Air Brake Compr.	280210C1	♣9540HD
Hose - Lower - Pipe To Rad.		26514	Hose - Upper		24232
Hose - By Pass		20338	Hose - Lower		♣20611
	or	28441		or	26509
International/Navistar BD264			Hose - By Pass		24232
1603			1703 (School Bus); 1803		
Belt - Fan & Alt.; W/37A., 52A., 61A., 62A. Alt.	151532R1	②7512	Belt - Fan & Alt.		
Belt - Fan & Alt.; W/60A. Alt.	861779R11	②♣9440HD	Belt - P.S.		
Belt - Gen.; W/20A., 50A. Alt.	20594VA	TR24438	Belt - Air Brake Compr.		
Belt - Gen.; W/30A. Alt.	81572R2	TR28437	Hose - Upper		
Belt - Gen.; W/35A., 50A. L.C.I. Gen.	164550R1	②♣9425HD	Hose - Lower - Eng. To Pipe		
Belt - P.S.; W/Air Brakes	149636R1	♣9480HD	Hose - Lower - Pipe To Rad.		
Belt - P.S.; W/Hyd. Brakes	864931R2	♣9319HD	Hose - By Pass		
Belt - Air Brake Compr.; W/4 Cu. Ft. Air Brake Compr.	201825R1	♣9440HD	International/Navistar BG220		
Belt - Air Brake Compr.; W/20A., 30A., 50A. Gen.	115505HA	TR22363	1603		
Hose - Upper		26510	Belt - Fan & Alt.; W/37A., 52A., 61A., 62A. Alt.		
			Belt - Fan & Alt.; W/60A. Alt.		
			Belt - Gen.; W/20A., 50A. Alt.		
			Belt - Gen.; W/30A. Alt.		

♣Standard Belt Available.
♣<Cut to Fit.

②Two Required.

Belts and Coolant Hose for School Buses

Application	Mfr. Part No.	Our No.	Application	Mfr. Part No.	Our No.
International/Navistar - Continued			International/Navistar - Continued		
1962 - Continued			1962 - Continued		
International/Navistar BG220 - Continued			International/Navistar FTVS549		
1603 - Continued			193RE		
Belt - Gen.; W/35A., 50A. L.C.I. Gen.	164550R1	②♠9425HD	Belt - Fan; W/52 5/8" Belt O.C.	680611R11	②♠♠9520HD
Belt - P.S.; W/Air Brakes	149636R1	♠9480HD	Belt - Fan; W/57 5/8" Belt O.C.	261710C11	♠9570HD
Belt - P.S.; W/Hyd. Brakes	864931R2	♠9319HD	Belt - Alt. To Compr.; W/37A., 60A. Alt.	243605R11	♠9451HD
Belt - Air Brake Compr.; W/4 Cu. Ft. Air Brake Compr.	201825R1	♠9440HD	Belt - Alt. To Compr.; W/55A. Alt.	264975C11	♠9455HD
Belt - Air Brake Compr.; W/20A., 30A., 50A. Gen.	115505HA	TR22363	Belt - Gen. To Compr.; W/30A. Gen.	133758R1	♠9440HD
Hose - Upper	26510		Belt - Gen. To Compr.; W/35A. Gen.	150560R11	♠9451HD
Hose - Lower - Eng. To Pipe	26508		Belt - Gen. To Compr.; W/50A. Gen.	201825R11	♠9435HD
Hose - Lower - Pipe To Rad.	26514		Belt - Gen.; W/Hyd. Brakes	133732R1	♠9360HD
Hose - By Pass	20338		Belt - P.S.; W/43 1/8" Belt O.C.	164550R11	♠9425HD
	28441		Belt - P.S.; W/44 5/8" Belt O.C.	133758R1	♠9440HD
		or	Belt - Idler; W/56 1/8" Belt O.C.	968645R11	♠9555HD
			Belt - Idler; W/57 5/8" Belt O.C.	261710C11	♠9570HD
International/Navistar BG241			International/Navistar RD372		
1603			1853		
Belt - Fan & Alt.; W/37A., 52A., 61A., 62A. Alt.	151532R1	②7512	Belt - Alt.; W/55A., 62A., 145A. Alt.	223794K21	②TR22514
Belt - Fan & Alt.; W/60A. Alt.	861779R11	②♠9440HD	Belt - Gen.; W/37A. Gen.	193826R11	TR22508
Belt - Gen.; W/20A., 50A. Alt.	20594VA	TR24438	Belt - P.S.	240354R1	TR22344
Belt - Gen.; W/30A. Alt.	81572R2	TR28437	1853FC		
Belt - Gen.; W/35A., 50A. L.C.I. Gen.	164550R1	②♠9425HD	Belt - Alt.; W/55A., 62A., 145A. Alt.	223794K21	②TR22514
Belt - P.S.; W/Air Brakes	149636R1	♠9480HD	Belt - Gen.; W/37A. Gen.	193826R11	TR22508
Belt - P.S.; W/Hyd. Brakes	864931R2	♠9319HD	Belt - P.S.	240354R1	TR22344
Belt - Air Brake Compr.; W/4 Cu. Ft. Air Brake Compr.	201825R1	♠9440HD	Hose - Upper; Late FD Chassis; Chassis No. FA66376		26509
Belt - Air Brake Compr.; W/20A., 30A., 50A. Gen.	115505HA	TR22363	Hose - Lower; Early FD Chassis; Chassis No. FA66376 ..		26508
Hose - Upper	26510		Hose - Lower; Late FD Chassis; Chassis No. FA66376		24234
Hose - Lower - Eng. To Pipe	26508				26508
Hose - Lower - Pipe To Rad.	26514				
Hose - By Pass	20338				
	28441				
		or			
			International/Navistar RD406		
International/Navistar BG265			1853		
1603			Belt - Alt.; W/55A., 62A., 145A. Alt. 223794K21 ②TR22514		
Belt - Fan & Alt.; W/37A., 52A., 61A., 62A. Alt.	151532R1	②7512	Belt - Gen.; W/37A. Gen.	193826R11	TR22508
Belt - Fan & Alt.; W/60A. Alt.	861779R11	②♠9440HD	Belt - P.S.	240354R1	TR22344
Belt - Gen.; W/20A., 50A. Alt.	20594VA	TR24438	1853FC		
Belt - Gen.; W/30A. Alt.	81572R2	TR28437	Belt - Alt.; W/55A., 62A., 145A. Alt.	223794K21	②TR22514
Belt - Gen.; W/35A., 50A. L.C.I. Gen.	164550R1	②♠9425HD	Belt - Gen.; W/37A. Gen.	193826R11	TR22508
Belt - P.S.; W/Air Brakes	149636R1	♠9480HD	Belt - P.S.	240354R1	TR22344
Belt - P.S.; W/Hyd. Brakes	864931R2	♠9319HD	Hose - Upper; Late FD Chassis; Chassis No. FA66376		26509
Belt - Air Brake Compr.; W/4 Cu. Ft. Air Brake Compr.	201825R1	♠9440HD	Hose - Lower; Early FD Chassis; Chassis No. FA66376 ..		26508
Belt - Air Brake Compr.; W/20A., 30A., 50A. Gen.	115505HA	TR22363	Hose - Lower; Late FD Chassis; Chassis No. FA66376		24234
Hose - Upper	26510				26508
Hose - Lower - Eng. To Pipe	26508				
Hose - Lower - Pipe To Rad.	26514				
Hose - By Pass	20338				
	28441				
		or			
			International/Navistar RD450		
International/Navistar FTV549			1853		
193RE			Belt - Alt.; W/55A., 62A., 145A. Alt. 223794K21 ②TR22514		
Belt - Fan; W/52 5/8" Belt O.C.	680611R11	②♠♠9520HD	Belt - Gen.; W/37A. Gen.	193826R11	TR22508
Belt - Fan; W/57 5/8" Belt O.C.	261710C11	♠9570HD	Belt - P.S.	240354R1	TR22344
Belt - Alt. To Compr.; W/37A., 60A. Alt.	243605R11	♠9451HD	1853FC		
Belt - Alt. To Compr.; W/55A. Alt.	264975C11	♠9455HD	Belt - Alt.; W/55A., 62A., 145A. Alt.	223794K21	②TR22514
Belt - Gen. To Compr.; W/30A. Gen.	133758R1	♠9440HD	Belt - Gen.; W/37A. Gen.	193826R11	TR22508
Belt - Gen. To Compr.; W/35A. Gen.	150560R11	♠9451HD	Belt - P.S.	240354R1	TR22344
Belt - Gen. To Compr.; W/50A. Gen.	201825R11	♠9435HD	Hose - Upper; Late FD Chassis; Chassis No. FA66376		26509
Belt - Gen.; W/Hyd. Brakes	133732R1	♠9360HD	Hose - Lower; Early FD Chassis; Chassis No. FA66376 ..		26508
Belt - P.S.; W/43 1/8" Belt O.C.	164550R11	♠9425HD	Hose - Lower; Late FD Chassis; Chassis No. FA66376		24234
Belt - P.S.; W/44 5/8" Belt O.C.	133758R1	♠9440HD			26508
Belt - Idler; W/56 1/8" Belt O.C.	968645R11	♠9555HD			
Belt - Idler; W/57 5/8" Belt O.C.	261710C11	♠9570HD			
			International/Navistar RD501		
			1853		
			Belt - Alt.; W/55A., 62A., 145A. Alt. 223794K21 ②TR22514		
			Belt - Gen.; W/37A. Gen. 193826R11 TR22508		
			Belt - P.S. 240354R1 TR22344		
			1853FC		
			Belt - Alt.; W/55A., 62A., 145A. Alt. 223794K21 ②TR22514		
			Belt - Gen.; W/37A. Gen. 193826R11 TR22508		
			Belt - P.S. 240354R1 TR22344		
			Hose - Upper; Late FD Chassis; Chassis No. FA66376 26509		
			Hose - Lower; Early FD Chassis; Chassis No. FA66376 .. 26508		
			Hose - Lower; Late FD Chassis; Chassis No. FA66376 .. 24234		
			26508		

♠Standard Belt Available.
 ♠PowerBand Belt May Work, Use Template to Check.

②Two Required.

Belts and Coolant Hose for School Buses

Application	Mfr. Part No.	Our No.	Application	Mfr. Part No.	Our No.
International/Navistar - Continued			International/Navistar - Continued		
1962 - Continued			1962 - Continued		
International/Navistar RD501 - Continued			International/Navistar V304 - Continued		
1853FC - Continued			1703 (School Bus) - Continued		
Hose - Lower; Late FD Chassis; Chassis No. FA66376		24234	Belt - Air Brake Compr.; W/46 5/8" Belt		
or		26508	O.C.	236572R1	7460
International/Navistar V266			Belt - Air Brake Compr.; W/45 5/8" Belt		
1603			O.C.	151531R1	7450
Belt - Fan & Alt.; W/37A., 52A. Alt.	255266C11	②7640	Hose - Upper; W/Rad. Shutters; W/Metal Hood		26515
Belt - Fan & Alt.; W/55A., 62A. Alt.	968815R11	②7650	Hose - Upper; W/O Rad. Shutters; W/Metal Hood		20493
Belt - Fan & Alt.; W/60A. Alt.	151533R11	②7673	Hose - Lower - Eng. To Pipe; W/Auto. Trans.		20532
Belt - P.S.	151529R1	7440	Hose - Lower; W/Man. Trans.		21308
Belt - Air Brake Compr.; W/46 5/8" Belt			Hose - By Pass		≈<20357
O.C.	236572R1	7460	1803		
Belt - Air Brake Compr.; W/45 5/8" Belt			Belt - Fan & Alt.; W/37A., 52A. Alt.	255266C11	②7640
O.C.	151531R1	7450	Belt - Fan & Alt.; W/55A., 62A. Alt.	968815R11	②7650
Hose - Upper; W/Rad. Shutters; W/Metal Hood		26515	Belt - Fan & Alt.; W/60A. Alt.	151533R11	②7673
Hose - Upper; W/O Rad. Shutters; W/Metal Hood		20493	Belt - P.S.	225532R1	7450
Hose - Lower - Eng. To Pipe; W/Auto. Trans.		20532	Belt - Air Brake Compr.; W/46 5/8" Belt		
Hose - Lower; W/Man. Trans.		21308	O.C.	236572R1	7460
Hose - By Pass		≈<20357	Belt - Air Brake Compr.; W/45 5/8" Belt		
1703 (School Bus)			O.C.	151531R1	7450
Belt - Fan & Alt.; W/37A., 52A. Alt.	255266C11	②7640	Hose - Upper; W/Rad. Shutters; W/Metal Hood		26515
Belt - Fan & Alt.; W/55A., 62A. Alt.	968815R11	②7650	Hose - Upper; W/O Rad. Shutters; W/Metal Hood		20493
Belt - Fan & Alt.; W/60A. Alt.	151533R11	②7673	Hose - Lower - Eng. To Pipe; W/Auto. Trans.		20532
Belt - P.S.; W/4WD	681956R1	7425	Hose - Lower; W/Man. Trans.		21308
Belt - Air Brake Compr.; W/46 5/8" Belt			Hose - By Pass		≈<20357
O.C.	236572R1	7460	International/Navistar V345		
Belt - Air Brake Compr.; W/45 5/8" Belt			1603; 1703 (School Bus)		
O.C.	151531R1	7450	Belt - Fan & Alt.; W/37A., 52A., 61A. Alt.;		
Hose - Upper; W/Rad. Shutters; W/Metal Hood		26515	C, G, H Chassis; W/P.T.O.	968815R11	②7650
Hose - Upper; W/O Rad. Shutters; W/Metal Hood		20493	Belt - Fan & Alt.; W/37A., 52A., 61A. Alt.;		
Hose - Lower - Eng. To Pipe; W/Auto. Trans.		20532	C, G, H Chassis; W/O P.T.O.	373457C91	②7612
Hose - Lower; W/Man. Trans.		21308	Belt - Fan & Alt.; W/37A., 52A., 61A. Alt.;		
Hose - By Pass		≈<20357	FD, SB Chassis	968815R1	②7650
1803			Belt - Fan & Alt.; W/37A., 61A. Alt.; W/O		
Belt - Fan & Alt.; W/37A., 52A. Alt.	255266C11	②7640	Air Brakes; W/O P.T.O.; W/O X.C.	373456C1	7612
Belt - Fan & Alt.; W/55A., 62A. Alt.	968815R11	②7650	Belt - Fan & Alt.; W/55A., 62A. Alt.; C, G, H		
Belt - Fan & Alt.; W/60A. Alt.	151533R11	②7673	Chassis	369723C91	②7630
Belt - P.S.	151529R1	7440	Belt - Fan & Alt.; W/55A., 62A. Alt.; FD, SB		
Belt - Air Brake Compr.; W/46 5/8" Belt			Chassis	361975C91	②7673
O.C.	236572R1	7460	Belt - Fan & Alt.; W/60A. Alt.	359009C91	②7680
Belt - Air Brake Compr.; W/45 5/8" Belt			Belt - Fan & Alt.; W/65A., 80A., 105A.,		
O.C.	151531R1	7450	145A. Alt; W/P.T.O.	361975C91	②7673
Hose - Upper; W/Rad. Shutters; W/Metal Hood		26515	Belt - Fan & Alt.; W/65A., 80A., 105A., 145A. Alt.; W/O		
Hose - Upper; W/O Rad. Shutters; W/Metal Hood		20493	P.T.O.		②7630
Hose - Lower - Eng. To Pipe; W/Auto. Trans.		20532	Belt - Fan & Gen.; W/20A. Alt.	151534R11	②7680
Hose - Lower; W/Man. Trans.		21308	Belt - Fan & Gen.; W/30A. Alt.	224638R11	②7695
Hose - By Pass		≈<20357	Belt - Fan & Gen.; W/35A. Alt.	151535R11	②7695
International/Navistar V304			Belt - Fan & Gen.; W/50A. Alt.	151536R11	②7715
1603			Belt - P.S.; W/2WD		7460
Belt - Fan & Alt.; W/37A., 52A. Alt.	255266C11	②7640	Belt - P.S.; W/4WD	285522C2	7435
Belt - Fan & Alt.; W/55A., 62A. Alt.	968815R11	②7650	Belt - Air Brake Compr.	359007C91	7475
Belt - Fan & Alt.; W/60A. Alt.	151533R11	②7673	Belt - A.P.; W/Air Brakes; W/Gov.	388139C1	7330
Belt - P.S.	225532R1	7450	Belt - A.P.; W/Air Brakes; W/O Gov.	256062C2	7340
Belt - Air Brake Compr.; W/46 5/8" Belt			Belt - A.P.; W/Hyd. Brakes; W/Gov.	355653C91	7380
O.C.	236572R1	7460	Belt - A.P.; W/Hyd. Brakes; W/O Gov.	362887C91	7410
Belt - Air Brake Compr.; W/45 5/8" Belt			Hose - Upper; W/Rad. Shutters; W/Metal Hood		26515
O.C.	151531R1	7450	Hose - Upper; W/O Rad. Shutters; W/Metal Hood		20493
Hose - Upper; W/Rad. Shutters; W/Metal Hood		26515	Hose - Lower - Eng. To Pipe; W/Auto. Trans.		20532
Hose - Upper; W/O Rad. Shutters; W/Metal Hood		20493	Hose - Lower; W/Man. Trans.		21308
Hose - Lower - Eng. To Pipe; W/Auto. Trans.		20532	Hose - By Pass		≈<20357
Hose - Lower; W/Man. Trans.		21308	1723		
Hose - By Pass		≈<20357	Belt - Fan & Alt.; W/37A., 52A., 61A. Alt.;		
1703 (School Bus)			C, G, H Chassis; W/P.T.O.	968815R11	②7650
Belt - Fan & Alt.; W/37A., 52A. Alt.	255266C11	②7640	Belt - Fan & Alt.; W/37A., 52A., 61A. Alt.;		
Belt - Fan & Alt.; W/55A., 62A. Alt.	968815R11	②7650	C, G, H Chassis; W/O P.T.O.	373457C91	②7612
Belt - Fan & Alt.; W/60A. Alt.	151533R11	②7673	Belt - Fan & Alt.; W/37A., 52A., 61A. Alt.;		
Belt - P.S.; W/4WD	681956R1	7425	FD, SB Chassis	968815R1	②7650

School Buses

②Two Required.

≈<Cut to Fit.

Belts and Coolant Hose for School Buses

Application	Mfr. Part No.	Our No.	Application	Mfr. Part No.	Our No.
International/Navistar - Continued			International/Navistar - Continued		
1962 - Continued			1962 - Continued		
International/Navistar V345 - Continued			International/Navistar V345 - Continued		
1723 - Continued			1823 - Continued		
Belt - Fan & Alt.; W/37A., 61A. Alt.; W/O Air Brakes; W/O P.T.O.; W/O X.C.	373456C1	7612	Belt - Fan & Alt.; W/55A., 62A. Alt.; FD, SB Chassis	361975C91	@7673
Belt - Fan & Alt.; W/55A., 62A. Alt.; C, G, H Chassis	369723C91	@7630	Belt - Fan & Alt.; W/60A. Alt.	359009C91	@7680
Belt - Fan & Alt.; W/55A., 62A. Alt.; FD, SB Chassis	361975C91	@7673	Belt - Fan & Alt.; W/65A., 80A., 105A., 145A. Alt.; W/P.T.O.	361975C91	@7673
Belt - Fan & Alt.; W/60A. Alt.	359009C91	@7680	Belt - Fan & Alt.; W/65A., 80A., 105A., 145A. Alt.; W/O P.T.O.		@7630
Belt - Fan & Alt.; W/65A., 80A., 105A., 145A. Alt.; W/P.T.O.	361975C91	@7673	Belt - Fan & Gen.; W/20A. Alt.	151534R11	@7680
Belt - Fan & Alt.; W/65A., 80A., 105A., 145A. Alt.; W/O P.T.O.		@7630	Belt - Fan & Gen.; W/30A. Alt.	224638R11	@7695
Belt - Fan & Gen.; W/20A. Alt.	151534R11	@7680	Belt - Fan & Gen.; W/35A. Alt.	151535R11	@7695
Belt - Fan & Gen.; W/30A. Alt.	224638R11	@7695	Belt - Fan & Gen.; W/50A. Alt.	151536R11	@7715
Belt - Fan & Gen.; W/35A. Alt.	151535R11	@7695	Belt - P.S.; W/2WD	7460	7460
Belt - Fan & Gen.; W/50A. Alt.	151536R11	@7715	Belt - P.S.; W/4WD	285522C2	7435
Belt - P.S.; W/2WD	7460	7460	Belt - Air Brake Compr.	359007C91	7475
Belt - P.S.; W/4WD	285522C2	7435	Belt - A.P.; W/Air Brakes; W/Gov.	388139C1	7330
Belt - Air Brake Compr.	359007C91	7475	Belt - A.P.; W/Air Brakes; W/O Gov.	256062C2	7340
Belt - A.P.; W/Air Brakes; W/Gov.	388139C1	7330	Belt - A.P.; W/Hyd. Brakes; W/Gov.	355653C91	7380
Belt - A.P.; W/Air Brakes; W/O Gov.	256062C2	7340	Belt - A.P.; W/Hyd. Brakes; W/O Gov.	362887C91	7410
Belt - A.P.; W/Hyd. Brakes; W/Gov.	355653C91	7380			
Belt - A.P.; W/Hyd. Brakes; W/O Gov.	362887C91	7410	International/Navistar V392		
1803			1603; 1703 (School Bus)		
Belt - Fan & Alt.; W/37A., 52A., 61A. Alt.; C, G, H Chassis; W/P.T.O.	968815R11	@7650	Belt - Fan & Alt.; W/37A., 52A., 61A. Alt.; C, G, H Chassis; W/O P.T.O.	373457C91	@7612
Belt - Fan & Alt.; W/37A., 52A., 61A. Alt.; C, G, H Chassis; W/O P.T.O.	373457C91	@7612	Belt - Fan & Alt.; W/37A., 52A., 61A. Alt.; FD, SB Chassis	968815R1	@7650
Belt - Fan & Alt.; W/37A., 52A., 61A. Alt.; FD, SB Chassis	968815R1	@7650	Belt - Fan & Alt.; W/37A., 61A. Alt.; W/O Air Brakes; W/O P.T.O.; W/O X.C.	373456C1	7612
Belt - Fan & Alt.; W/37A., 61A. Alt.; W/O Air Brakes; W/O P.T.O.; W/O X.C.	373456C1	7612	Belt - Fan & Alt.; W/55A., 62A. Alt.; C, G, H Chassis	369723C91	@7630
Belt - Fan & Alt.; W/55A., 62A. Alt.; C, G, H Chassis	369723C91	@7630	Belt - Fan & Alt.; W/55A., 62A. Alt.; FD, SB Chassis	361975C91	@7673
Belt - Fan & Alt.; W/55A., 62A. Alt.; FD, SB Chassis	361975C91	@7673	Belt - Fan & Alt.; W/60A. Alt.	359009C91	@7680
Belt - Fan & Alt.; W/60A. Alt.	359009C91	@7680	Belt - Fan & Alt.; W/65A., 80A., 105A., 145A. Alt.; W/P.T.O.	361975C91	@7673
Belt - Fan & Alt.; W/65A., 80A., 105A., 145A. Alt.; W/P.T.O.	361975C91	@7673	Belt - Fan & Alt.; W/65A., 80A., 105A., 145A. Alt.; W/O P.T.O.		@7630
Belt - Fan & Alt.; W/65A., 80A., 105A., 145A. Alt.; W/O P.T.O.		@7630	Belt - Fan & Gen.; W/20A. Alt.	151534R11	@7680
Belt - Fan & Gen.; W/20A. Alt.	151534R11	@7680	Belt - Fan & Gen.; W/30A. Alt.	224638R11	@7695
Belt - Fan & Gen.; W/30A. Alt.	224638R11	@7695	Belt - Fan & Gen.; W/35A. Alt.	151535R11	@7695
Belt - Fan & Gen.; W/35A. Alt.	151535R11	@7695	Belt - Fan & Gen.; W/50A. Alt.	151536R11	@7715
Belt - Fan & Gen.; W/50A. Alt.	151536R11	@7715	Belt - P.S.; W/2WD	7460	7460
Belt - P.S.; W/2WD	7460	7460	Belt - P.S.; W/4WD	285522C2	7435
Belt - P.S.; W/4WD	285522C2	7435	Belt - Air Brake Compr.	359007C91	7475
Belt - Air Brake Compr.	359007C91	7475	Belt - A.P.; W/Air Brakes; W/Gov.	388139C1	7330
Belt - A.P.; W/Air Brakes; W/Gov.	388139C1	7330	Belt - A.P.; W/Air Brakes; W/O Gov.	256062C2	7340
Belt - A.P.; W/Air Brakes; W/O Gov.	256062C2	7340	Belt - A.P.; W/Hyd. Brakes; W/Gov.	355653C91	7380
Belt - A.P.; W/Hyd. Brakes; W/Gov.	355653C91	7380	Belt - A.P.; W/Hyd. Brakes; W/O Gov.	362887C91	7410
Belt - A.P.; W/Hyd. Brakes; W/O Gov.	362887C91	7410	Hose - Upper; W/Rad. Shutters; W/Metal Hood		26515
Hose - Upper; W/Rad. Shutters; W/Metal Hood		26515	Hose - Upper; W/O Rad. Shutters; W/Metal Hood		20493
Hose - Upper; W/O Rad. Shutters; W/Metal Hood		20493	Hose - Lower - Eng. To Pipe; W/Auto. Trans.		20532
Hose - Lower - Eng. To Pipe; W/Auto. Trans.		20532	Hose - Lower; W/Man. Trans.		21308
Hose - Lower; W/Man. Trans.		21308	Hose - By Pass		@20357
Hose - By Pass	@20357	@20357			
1823			1723		
Belt - Fan & Alt.; W/37A., 52A., 61A. Alt.; C, G, H Chassis; W/P.T.O.	968815R11	@7650	Belt - Fan & Alt.; W/37A., 52A., 61A. Alt.; C, G, H Chassis; W/O P.T.O.	373457C91	@7612
Belt - Fan & Alt.; W/37A., 52A., 61A. Alt.; C, G, H Chassis; W/O P.T.O.	373457C91	@7612	Belt - Fan & Alt.; W/37A., 52A., 61A. Alt.; FD, SB Chassis	968815R1	@7650
Belt - Fan & Alt.; W/37A., 52A., 61A. Alt.; FD, SB Chassis	968815R1	@7650	Belt - Fan & Alt.; W/37A., 61A. Alt.; W/O Air Brakes; W/O P.T.O.; W/O X.C.	373456C1	7612
Belt - Fan & Alt.; W/37A., 61A. Alt.; W/O Air Brakes; W/O P.T.O.; W/O X.C.	373456C1	7612	Belt - Fan & Alt.; W/55A., 62A. Alt.; C, G, H Chassis	369723C91	@7630
Belt - Fan & Alt.; W/55A., 62A. Alt.; C, G, H Chassis	369723C91	@7630	Belt - Fan & Alt.; W/55A., 62A. Alt.; FD, SB Chassis	361975C91	@7673
Belt - Fan & Alt.; W/55A., 62A. Alt.; FD, SB Chassis	361975C91	@7673	Belt - Fan & Alt.; W/60A. Alt.	359009C91	@7680
Belt - Fan & Alt.; W/60A. Alt.	359009C91	@7680			

@Two Required.

@Cut to Fit.

Belts and Coolant Hose for School Buses

Application	Mfr. Part No.	Our No.	Application	Mfr. Part No.	Our No.
International/Navistar - Continued			International/Navistar - Continued		
1962 - Continued			1962 - Continued		
International/Navistar V392 - Continued			International/Navistar V392 - Continued		
1723 - Continued			1823 - Continued		
Belt - Fan & Alt.; W/65A., 80A., 105A., 145A. Alt; W/P.T.O.	361975C91	②7673	Belt - Fan & Gen.; W/20A. Alt.	151534R11	②7680
Belt - Fan & Alt.; W/65A., 80A., 105A., 145A. Alt.; W/O P.T.O.		②7630	Belt - Fan & Gen.; W/30A. Alt.	224638R11	②7695
Belt - Fan & Gen.; W/20A. Alt.	151534R11	②7680	Belt - Fan & Gen.; W/35A. Alt.	151535R11	②7695
Belt - Fan & Gen.; W/30A. Alt.	224638R11	②7695	Belt - Fan & Gen.; W/50A. Alt.	151536R11	②7715
Belt - Fan & Gen.; W/35A. Alt.	151535R11	②7695	Belt - P.S.; W/2WD		7460
Belt - Fan & Gen.; W/50A. Alt.	151536R11	②7715	Belt - P.S.; W/4WD	285522C2	7435
Belt - P.S.; W/2WD		7460	Belt - Air Brake Compr.	359007C91	7475
Belt - P.S.; W/4WD	285522C2	7435	Belt - A.P.; W/Air Brakes; W/Gov.	388139C1	7330
Belt - Air Brake Compr.	359007C91	7475	Belt - A.P.; W/Air Brakes; W/O Gov.	256062C2	7340
Belt - A.P.; W/Air Brakes; W/Gov.	388139C1	7330	Belt - A.P.; W/Hyd. Brakes; W/Gov.	355653C91	7380
Belt - A.P.; W/Air Brakes; W/O Gov.	256062C2	7340	Belt - A.P.; W/Hyd. Brakes; W/O Gov.	362887C91	7410
Belt - A.P.; W/Hyd. Brakes; W/Gov.	355653C91	7380			
Belt - A.P.; W/Hyd. Brakes; W/O Gov.	362887C91	7410	International/Navistar V401		
1803			193RE		
Belt - Fan & Alt.; W/37A., 52A., 61A. Alt.; C, G, H Chassis; W/P.T.O.	968815R11	②7650	Belt - Fan; W/52 5/8" Belt O.C.	680611R11	②♣◆9520HD
Belt - Fan & Alt.; W/37A., 52A., 61A. Alt.; C, G, H Chassis; W/O P.T.O.	373457C91	②7612	Belt - Fan; W/57 5/8" Belt O.C.	261710C11	♣9570HD
Belt - Fan & Alt.; W/37A., 52A., 61A. Alt.; FD, SB Chassis	968815R1	②7650	Belt - Alt. To Compr.; W/37A., 60A. Alt.	243605R11	♣9451HD
Belt - Fan & Alt.; W/37A., 61A. Alt.; W/O Air Brakes; W/O P.T.O.; W/O X.C.	373456C1	7612	Belt - Alt. To Compr.; W/55A. Alt.	264975C11	♣9455HD
Belt - Fan & Alt.; W/55A., 62A. Alt.; C, G, H Chassis	369723C91	②7630	Belt - Gen. To Compr.; W/30A. Gen.	133758R1	♣9440HD
Belt - Fan & Alt.; W/55A., 62A. Alt.; FD, SB Chassis	361975C91	②7673	Belt - Gen. To Compr.; W/35A. Gen.	150560R11	♣9451HD
Belt - Fan & Alt.; W/60A. Alt.	359009C91	②7680	Belt - Gen. To Compr.; W/50A. Gen.	201825R11	♣9435HD
Belt - Fan & Alt.; W/65A., 80A., 105A., 145A. Alt; W/P.T.O.	361975C91	②7673	Belt - Gen.; W/Hyd. Brakes	133732R1	♣9360HD
Belt - Fan & Alt.; W/65A., 80A., 105A., 145A. Alt.; W/O P.T.O.		②7630	Belt - P.S.; W/43 1/8" Belt O.C.	164550R11	♣9425HD
Belt - Fan & Gen.; W/20A. Alt.	151534R11	②7680	Belt - P.S.; W/44 5/8" Belt O.C.	133758R1	♣9440HD
Belt - Fan & Gen.; W/30A. Alt.	224638R11	②7695	Belt - Idler; W/56 1/8" Belt O.C.	968645R11	♣9555HD
Belt - Fan & Gen.; W/35A. Alt.	151535R11	②7695	Belt - Idler; W/57 5/8" Belt O.C.	261710C11	♣9570HD
Belt - Fan & Gen.; W/50A. Alt.	151536R11	②7715			
Belt - P.S.; W/2WD		7460	International/Navistar V461		
Belt - P.S.; W/4WD	285522C2	7435	193RE		
Belt - Air Brake Compr.	359007C91	7475	Belt - Fan; W/52 5/8" Belt O.C.	680611R11	②♣◆9520HD
Belt - A.P.; W/Air Brakes; W/Gov.	388139C1	7330	Belt - Fan; W/57 5/8" Belt O.C.	261710C11	♣9570HD
Belt - A.P.; W/Air Brakes; W/O Gov.	256062C2	7340	Belt - Alt. To Compr.; W/37A., 60A. Alt.	243605R11	♣9451HD
Belt - A.P.; W/Hyd. Brakes; W/Gov.	355653C91	7380	Belt - Alt. To Compr.; W/55A. Alt.	264975C11	♣9455HD
Belt - A.P.; W/Hyd. Brakes; W/O Gov.	362887C91	7410	Belt - Gen. To Compr.; W/30A. Gen.	133758R1	♣9440HD
Hose - Upper; W/Rad. Shutters; W/Metal Hood		26515	Belt - Gen. To Compr.; W/35A. Gen.	150560R11	♣9451HD
Hose - Upper; W/O Rad. Shutters; W/Metal Hood		20493	Belt - Gen. To Compr.; W/50A. Gen.	201825R11	♣9435HD
Hose - Lower - Eng. To Pipe; W/Auto. Trans.		20532	Belt - Gen.; W/Hyd. Brakes	133732R1	♣9360HD
Hose - Lower; W/Man. Trans.		21308	Belt - P.S.; W/43 1/8" Belt O.C.	164550R11	♣9425HD
Hose - By Pass		≈<20357	Belt - P.S.; W/44 5/8" Belt O.C.	133758R1	♣9440HD
1823			Belt - Idler; W/56 1/8" Belt O.C.	968645R11	♣9555HD
Belt - Fan & Alt.; W/37A., 52A., 61A. Alt.; C, G, H Chassis; W/P.T.O.	968815R11	②7650	Belt - Idler; W/57 5/8" Belt O.C.	261710C11	♣9570HD
Belt - Fan & Alt.; W/37A., 52A., 61A. Alt.; C, G, H Chassis; W/O P.T.O.	373457C91	②7612			
Belt - Fan & Alt.; W/37A., 52A., 61A. Alt.; FD, SB Chassis	968815R1	②7650	International/Navistar V478		
Belt - Fan & Alt.; W/37A., 61A. Alt.; W/O Air Brakes; W/O P.T.O.; W/O X.C.	373456C1	7612	193RE		
Belt - Fan & Alt.; W/55A., 62A. Alt.; C, G, H Chassis	369723C91	②7630	Belt - Fan; W/52 5/8" Belt O.C.	680611R11	②♣◆9520HD
Belt - Fan & Alt.; W/55A., 62A. Alt.; FD, SB Chassis	361975C91	②7673	Belt - Fan; W/57 5/8" Belt O.C.	261710C11	♣9570HD
Belt - Fan & Alt.; W/60A. Alt.	359009C91	②7680	Belt - Alt. To Compr.; W/37A., 60A. Alt.	243605R11	♣9451HD
Belt - Fan & Alt.; W/65A., 80A., 105A., 145A. Alt; W/P.T.O.	361975C91	②7673	Belt - Alt. To Compr.; W/55A. Alt.	264975C11	♣9455HD
Belt - Fan & Alt.; W/65A., 80A., 105A., 145A. Alt.; W/O P.T.O.		②7630	Belt - Gen. To Compr.; W/30A. Gen.	133758R1	♣9440HD
			Belt - Gen. To Compr.; W/35A. Gen.	150560R11	♣9451HD
			Belt - Gen. To Compr.; W/50A. Gen.	201825R11	♣9435HD
			Belt - Gen.; W/Hyd. Brakes	133732R1	♣9360HD
			Belt - P.S.; W/43 1/8" Belt O.C.	164550R11	♣9425HD
			Belt - P.S.; W/44 5/8" Belt O.C.	133758R1	♣9440HD
			Belt - Idler; W/56 1/8" Belt O.C.	968645R11	♣9555HD
			Belt - Idler; W/57 5/8" Belt O.C.	261710C11	♣9570HD
			International/Navistar V549		
			193RE		
			Belt - Fan; W/52 5/8" Belt O.C.	680611R11	②♣◆9520HD
			Belt - Fan; W/57 5/8" Belt O.C.	261710C11	♣9570HD
			Belt - Alt. To Compr.; W/37A., 60A. Alt.	243605R11	♣9451HD
			Belt - Alt. To Compr.; W/55A. Alt.	264975C11	♣9455HD
			Belt - Gen. To Compr.; W/30A. Gen.	133758R1	♣9440HD
			Belt - Gen. To Compr.; W/35A. Gen.	150560R11	♣9451HD
			Belt - Gen. To Compr.; W/50A. Gen.	201825R11	♣9435HD

School Buses

②Two Required.
♣Standard Belt Available.

≈<Cut to Fit.
◆PowerBand Belt May Work, Use Template to Check.

Belts and Coolant Hose for School Buses

Application	Mfr. Part No.	Our No.	Application	Mfr. Part No.	Our No.
International/Navistar - Continued			Mid Bus		
1961 - 1958 - Continued			1998		
International/Navistar V549 - Continued			GM V-8 5.7 L		
193RE - Continued			SW		
Belt - Gen. To Compr.; W/50A. Gen.	201825R11	♣9435HD	Belt - Serpentine; W/O A.C.; W/130A. Alt. ..	12564760	♣K060875HD
Belt - Gen.; W/Hyd. Brakes	133732R1	♣9360HD	Belt - Accessory Belt Drive Kit; W/O A.C.; W/130A. Alt.		ACK060875HD
Belt - P.S.; W/43 1/8" Belt O.C.	164550R11	♣9425HD	Tensioner Assy.		38103
Belt - P.S.; W/44 5/8" Belt O.C.	133758R1	♣9440HD	Tensioner Pulley		38008
Belt - Idler; W/56 1/8" Belt O.C.	968645R11	♣9555HD	Hose - Upper		22357
Belt - Idler; W/57 5/8" Belt O.C.	261710C11	♣9570HD	Hose - Lower		22425
International/Navistar VS401			Thomas Built		
193RE			2015		
Belt - Fan; W/52 5/8" Belt O.C.	680611R11	②♣♠9520HD	Cummins ISC Diesel		
Belt - Fan; W/57 5/8" Belt O.C.	261710C11	♣9570HD	Saf-T-Liner HDX		
Belt - Alt. To Compr.; W/37A., 60A. Alt.	243605R11	♣9451HD	Tensioner Assy.	3973819	38627
Belt - Alt. To Compr.; W/55A. Alt.	264975C11	♣9455HD	Idler Pulley	3970945	36283
Belt - Gen. To Compr.; W/30A. Gen.	133758R1	♣9440HD	2014		
Belt - Gen. To Compr.; W/35A. Gen.	150560R11	♣9451HD	Cummins ISB6.7 Diesel		
Belt - Gen. To Compr.; W/50A. Gen.	201825R11	♣9435HD	Saf-T-Liner C2; Saf-T-Liner EF		
Belt - Gen.; W/Hyd. Brakes	133732R1	♣9360HD	Belt - Serpentine	0132241065	K080813HD
Belt - P.S.; W/43 1/8" Belt O.C.	164550R11	♣9425HD	Idler Pulley	4991240	36093
Belt - P.S.; W/44 5/8" Belt O.C.	133758R1	♣9440HD	Hose - Lower - Rad. To Pipe		≈24432
Belt - Idler; W/56 1/8" Belt O.C.	968645R11	♣9555HD	Hose - Lower - Pipe To Eng.		≈24432
Belt - Idler; W/57 5/8" Belt O.C.	261710C11	♣9570HD	Hose - Turbo To Pipe (Hot Side)		26200
International/Navistar VS478			Hose - Pipe To Intercooler (Hot Side)		
193RE			26201		
Belt - Fan; W/52 5/8" Belt O.C.	680611R11	②♣♠9520HD	Cummins ISC Diesel		
Belt - Fan; W/57 5/8" Belt O.C.	261710C11	♣9570HD	Saf-T-Liner EF		
Belt - Alt. To Compr.; W/37A., 60A. Alt.	243605R11	♣9451HD	Tensioner Assy.	3973819	38627
Belt - Alt. To Compr.; W/55A. Alt.	264975C11	♣9455HD	Idler Pulley	3970945	36283
Belt - Gen. To Compr.; W/30A. Gen.	133758R1	♣9440HD	Cummins ISL Diesel		
Belt - Gen. To Compr.; W/35A. Gen.	150560R11	♣9451HD	Saf-T-Liner C2		
Belt - Gen. To Compr.; W/50A. Gen.	201825R11	♣9435HD	Belt - Serpentine	0132241051	♣K080806HD
Belt - Gen.; W/Hyd. Brakes	133732R1	♣9360HD	Tensioner Assy.	3973819	38627
Belt - P.S.; W/43 1/8" Belt O.C.	164550R11	♣9425HD	Idler Pulley	4991240	36093
Belt - P.S.; W/44 5/8" Belt O.C.	133758R1	♣9440HD	Hose - Lower - Rad. To Pipe		≈24432
Belt - Idler; W/56 1/8" Belt O.C.	968645R11	♣9555HD	Hose - Lower - Pipe To Eng.		24432
Belt - Idler; W/57 5/8" Belt O.C.	261710C11	♣9570HD	Hose - Pipe To Intercooler (Hot Side)		26201
International/Navistar VS549			Hose - Turbo To Pipe (Hot Side)		
193RE			26200		
Belt - Fan; W/52 5/8" Belt O.C.	680611R11	②♣♠9520HD	PI V-8 8.0 L		
Belt - Fan; W/57 5/8" Belt O.C.	261710C11	♣9570HD	Saf-T-Liner C2		
Belt - Alt. To Compr.; W/37A., 60A. Alt.	243605R11	♣9451HD	Belt - Serpentine - Fan	0133502550	K071005
Belt - Alt. To Compr.; W/55A. Alt.	264975C11	♣9455HD	Belt - Serpentine - A.C.	0132241041	K080803
Belt - Gen. To Compr.; W/30A. Gen.	133758R1	♣9440HD	Hose - Upper		24276
Belt - Gen. To Compr.; W/35A. Gen.	150560R11	♣9451HD	Hose - Lower - Cooler To Pipe		21194
Belt - Gen. To Compr.; W/50A. Gen.	201825R11	♣9435HD	Hose - Lower - Pipe To Cooler		21194
Belt - Gen.; W/Hyd. Brakes	133732R1	♣9360HD	Hose - Lower - Pipe To Eng.		≈24228
Belt - P.S.; W/43 1/8" Belt O.C.	164550R11	♣9425HD	Hose - Lower - Rad. To Pipe		≈20206
Belt - P.S.; W/44 5/8" Belt O.C.	133758R1	♣9440HD	2013		
Belt - Idler; W/56 1/8" Belt O.C.	968645R11	♣9555HD	Cummins ISB6.7 Diesel		
Belt - Idler; W/57 5/8" Belt O.C.	261710C11	♣9570HD	Saf-T-Liner C2		
1952 - 1950			Belt - Serpentine		
International/Navistar BG220			0132241065		
L153			K080813HD		
Belt - Fan & Gen.; W/O 20A., 25A., 40A., 50A. Gen.		TR28445	Idler Pulley	4991240	36093
Belt - Fan & Gen.; W/20A., 25A., 40A., 50A. Gen.		TR28437	Hose - Lower - Pipe To Eng.		≈24632
Belt - P.S.		7350	Saf-T-Liner EF; Saf-T-Liner HDX		
Hose - Upper		20206	Belt - Serpentine	4933075	K080885HD
or		26508	2012		
Hose - Lower		26509	Cummins ISB6.7 Diesel		
Hose - By Pass		20338	Saf-T-Liner C2		
			Belt - Serpentine		
			0132241065		
			K080813HD		
			Idler Pulley		
			4991240		
			Hose - Lower - Rad. To Pipe		
			≈20206		

School Buses

♣Standard Belt Available.
②Two Required.

♠PowerBand Belt May Work, Use Template to Check.
≈Cut to Fit.

Belts and Coolant Hose for School Buses

School Buses

Application	Mfr. Part No.	Our No.	Application	Mfr. Part No.	Our No.
Thomas Built - Continued			Thomas Built - Continued		
2012 - Continued			2010 - Continued		
Cummins ISB6.7 Diesel - Continued			Cummins ISB6.7 Diesel - Continued		
Saf-T-Liner C2 - Continued			Saf-T-Liner C2 - Continued		
Hose - Lower - Pipe To Cooler		≈20206	Hose - Lower - Rad. To Pipe		≈20206
Hose - Lower - Cooler To Pipe		≈20206	Hose - Lower - Pipe To Cooler		≈20206
Hose - Lower - Pipe To Eng.		≈24632	Hose - Lower - Cooler To Pipe		≈20206
Hose - Turbo To Pipe (Hot Side)		26200	Hose - Lower - Pipe To Eng.		≈24632
Hose - Pipe To Intercooler (Hot Side)		26201	Hose - Turbo To Pipe (Hot Side)		26200
Saf-T-Liner EF; Saf-T-Liner HDX			Hose - Pipe To Intercooler (Hot Side)		
Belt - Serpentine	4933075	K080885HD			26201
Cummins ISC Diesel			Cummins ISC Diesel		
Saf-T-Liner EF			Saf-T-Liner EF		
Belt - Accessory Belt Drive Kit - W.P.		ACK080878HD	Belt - W.P.	3972265	♣K080878HD
Belt - Accessory Belt Drive Kit - Fan		ACK080550HD1	Belt - Fan	3911586	♣K080550HD
Belt - W.P.	3972265	♣K080878HD	Tensioner Assy. - Fan	3287277	38518
Belt - Fan	3911586	♣K080550HD	Mercedes-Benz MBE 900 Diesel		
Tensioner Assy. - W.P.	3973819	38627	Saf-T-Liner C2		
Tensioner Assy. - Fan	3287277	38518	Belt - Accessory Belt Drive Kit - Fan & Alt.		ACK080680HD1
Idler Pulley - W.P.	4991240	36093	Belt - Fan & Alt.	0129859724	♣K080680HD
Hose - Return - Pump To Tank	0428833100	DEF7013	Tensioner Assy. - Fan & Alt.	A9062003170	38567
Saf-T-Liner HDX			Hose - Upper - Eng. To Rad.		≈21379
Belt - Serpentine	4938728	K080683HD	Hose - Lower - Eng. To Pipe		≈21124
Belt - Accessory Belt Drive Kit		ACK080683HD	Hose - Lower - Pipe To Rad.		≈21521
Tensioner Assy.	3973819	38627	2009		
Idler Pulley	4991240	36093	Cummins ISB-07 Diesel		
2011			Saf-T-Liner C2		
Cummins ISB6.7 Diesel			Belt - Fan, Alt. & A.C.	0123415077	K080813HD
Saf-T-Liner C2			Idler Pulley	4991240	36093
Belt - Serpentine	0132241065	K080813HD	Hose - Upper - Eng. To Rad.		24033
Belt - Accessory Belt Drive Kit		ACK080813HD	Cummins ISC Diesel		
Tensioner Assy.	5264111	38631	Saf-T-Liner HDX		
Idler Pulley	4991240	36093	Belt - Fan	3289124	♣K080665HD
Hose - Upper		24033	Tensioner Assy.	3973819	38627
Hose - Lower - Rad. To Pipe		≈20206	Idler Pulley	4991240	36093
Hose - Lower - Pipe To Cooler		≈20206	Saf-T-Liner MVP EF		
Hose - Lower - Cooler To Pipe		≈20206	Belt - Accessory Drive	3972378	K080889HD
Hose - Lower - Pipe To Eng.		≈24632	Mercedes-Benz MBE 900 Diesel		
Hose - Turbo To Pipe (Hot Side)		26200	Saf-T-Liner C2		
Hose - Pipe To Intercooler (Hot Side)		26201	Belt - Accessory Belt Drive Kit - Fan & Alt.		ACK080680HD1
Saf-T-Liner EF; Saf-T-Liner HDX			Belt - Fan & Alt.	0129859724	♣K080680HD
Belt - Serpentine	4933075	K080885HD	Belt - Fan, Alt. & A.C.	0129859699	♣K080670HD
Cummins ISC Diesel			Tensioner Assy. - Fan & Alt.	A9062003170	38567
Saf-T-Liner EF			Hose - Upper		≈21379
Belt - Accessory Belt Drive Kit - Fan		ACK080550HD1	Hose - Upper - Eng. To Rad.		≈21379
Belt - W.P.	3972265	♣K080878HD	Hose - Lower - Eng. To Pipe		≈21124
Belt - Fan	3911586	♣K080550HD	2008		
Tensioner Assy. - Fan	3287277	38518	Caterpillar C7 Diesel		
Mercedes-Benz MBE 900 Diesel			Saf-T-Liner C2		
Saf-T-Liner C2			Belt - Accessory Belt Drive Kit - Fan, Alt. & W.P.		ACK080760HD1
Belt - Accessory Belt Drive Kit - Fan & Alt.		ACK080680HD1	Belt - Fan, Alt. & W.P.	0123415060	♣K080760HD
Belt - Fan & Alt.	0129859724	♣K080680HD	Tensioner Assy. - Fan, W.P. & Alt.	2201209	38550
Tensioner Assy. - Fan & Alt.	A9062003170	38567	Idler Pulley - Grooved	1979642	36341
Hose - Upper - Eng. To Rad.		≈21379	Idler Pulley - Upper	1979641	36091
Hose - Lower - Eng. To Pipe		≈21124	Hose - Upper - Eng. To Rad.		22745
Hose - Lower - Pipe To Rad.		≈21521	Hose - Lower - Rad. To Cooler		20206
2010			Saf-T-Liner HDX		
Cummins ISB6.7 Diesel			Belt - Accessory Belt Drive Kit - Fan & Alt.		ACK080780HD
Saf-T-Liner C2			Belt - Fan & Alt.	61160554	♣K080780HD
Belt - Accessory Belt Drive Kit - Fan		ACK080813HD	Belt - W.P.	0366775	♣9341HD
Belt - Fan	0132001065	K080813HD	Tensioner Assy. - Fan & Alt.	1352151	38511
Tensioner Assy.	5264111	38631	Idler Pulley - W.P.	1154237	36349
Idler Pulley	4991240	36093	Idler Pulley - Fan & Alt.	2534525	36096
Hose - Upper		24033			

≈Cut to Fit.

♣Standard Belt Available.

Belts and Coolant Hose for School Buses

Application	Mfr. Part No.	Our No.	Application	Mfr. Part No.	Our No.
Thomas Built - Continued			Thomas Built - Continued		
2008 - Continued			2006 - Continued		
Cummins ISB-07 Diesel			Cummins ISB Diesel		
Saf-T-Liner C2			Saf-T-Liner MVP EF		
Belt - Accessory Belt Drive Kit - Fan, Alt. & W.P.		ACK080813HD	Belt - Accessory Belt Drive Kit		ACK080785HD
Belt - Fan, Alt. & W.P.	0123415077	K080813HD	Belt - Accessory Drive	3289779	▲K080785HD
Tensioner Assy. - Fan, W.P. & Alt.	4937433	38631	Tensioner Assy.	3976833	38517
Cummins ISC Diesel			Idler Pulley		
Saf-T-Liner HDX; Saf-T-Liner MVP EF			4991240		
Belt - Serpentine	3972378	K080889HD	GM V-8 6.0 L		
Mercedes-Benz MBE 900 Diesel			Minotour		
Saf-T-Liner C2			Belt - Serpentine; W/105A. Alt.		
Belt - Accessory Belt Drive Kit - Fan & Alt.		ACK080680HD1		12576450	▲K060923HD
Belt - Fan & Alt.	0129859724	▲K080680HD	Belt - Serpentine; W/145A. Alt.	12576451	▲K060930HD
Tensioner Assy. - Fan & Alt.	A9062003170	38567	Belt - Accessory Belt Drive Kit; W/105A. Alt.		▲K060923HD1
Hose - Lower - Eng. To Pipe		≧21124	Belt - Accessory Belt Drive Kit - A.C.		ACK040378HD
Hose - Lower - Pipe To Cooler		20206	Belt - Accessory Belt Drive Kit; W/145A. Alt.		ACK060930HD
Hose - Lower - Cooler To Rad.		≧21378	Belt - A.C.	12576447	▲K040378HD
2007			Tensioner Assy. - A.C.		
Caterpillar C7 Diesel			12580196		
Conventional			Tensioner Assy. - Serpentine		
Belt - Fan & Alt.	0127110003	▲K080708HD	12580162		
Belt - W.P.	0366775	▲9341HD	Tensioner Pulley - Serpentine		
Saf-T-Liner HDX			12580162		
Belt - Accessory Belt Drive Kit - Fan & Alt.		ACK080780HD	Tensioner Pulley - A.C.		
Belt - Fan & Alt.	61160554	▲K080780HD	12580196		
Belt - W.P.	0366775	▲9341HD	Idler Pulley - Serpentine		
Tensioner Assy. - Fan & Alt.	1352151	38511	12580771		
Idler Pulley - W.P.	1154237	36349	Hose - Upper		
Idler Pulley - Fan & Alt.	2534525	36096	Hose - Lower		
Saf-T-Liner MVP EF			John Deere 6-Cyl. 8.1 L CNG		
Belt - Alt. & W.P.	2737533	▲K080690HD	Saf-T-Liner MVP ER		
John Deere 6-Cyl. 8.1 L CNG			Belt - Accessory Belt Drive Kit		
Saf-T-Liner MVP ER			Belt - Eng. To Alt.		
Tensioner Assy. - A.C.; W/Dual A.C.	RE518097	38507	Tensioner Assy. - Alt.		
Mercedes-Benz MBE 900 Diesel			RE518097		
Conventional			Mercedes-Benz MBE 900 Diesel		
Belt - Accessory Belt Drive Kit - Fan & Alt.		ACK080675HD	Conventional		
Belt - Fan & Alt.	0129859718	▲K080675HD	Belt - Accessory Belt Drive Kit - Fan & Alt.		
Tensioner Assy. - Alt.	9062003170	38567	Belt - Fan & Alt.		
Hose - Upper - Eng. To Rad.		22992	Belt - W.P.		
Hose - Lower - Pipe To W.P.		22991	Tensioner Assy. - Fan & Alt.		
Hose - Lower - Eng. To Pipe		22702	A9062003170		
Saf-T-Liner C2			Hose - Upper		
Belt - Accessory Belt Drive Kit - Fan & Alt.		ACK080680HD1	Hose - Lower - Eng. To Pipe		
Belt - Fan & Alt.	0129859724	▲K080680HD	Hose - Lower - Eng. To Pipe		
Tensioner Assy. - Fan & Alt.	A9062003170	38567	Saf-T-Liner C2		
Hose - Upper		≧21378	Belt - Accessory Belt Drive Kit - Fan & Alt.		
Hose - Lower - Eng. To Pipe		≧21124	Belt - Fan & Alt.		
Hose - Lower - Pipe To Rad.		20206	Belt - W.P.		
2006			Idler Pulley - W.P.		
Caterpillar C7 Diesel			1154237		
Saf-T-Liner HDX			Idler Pulley - Fan & Alt.		
Belt - Accessory Belt Drive Kit - Fan & Alt.		ACK080780HD	2534525		
Belt - Fan & Alt.	61160554	▲K080780HD	Saf-T-Liner MVP EF		
Belt - W.P.	0366775	▲9341HD	Belt - Accessory Belt Drive Kit		
Tensioner Assy. - Fan & Alt.	1352151	38511	Belt - Alt.		
Idler Pulley - W.P.	1154237	36349	Tensioner Assy. - Alt.		
Idler Pulley - Fan & Alt.	2534525	36096	2201209		
Saf-T-Liner MVP EF			Saf-T-Liner MVP ER		
Belt - Accessory Belt Drive Kit		ACK080776HD	Belt - Accessory Belt Drive Kit - Alt. & W.P.		
Belt - Alt.	2390238	▲K080776HD	Belt - Alt. & W.P.		
Tensioner Assy. - Alt.	2201209	38550	Tensioner Assy. - Alt. & W.P.		
Caterpillar C7 Diesel			2201209		
Saf-T-Liner HDX			Cummins ISB Diesel		
Belt - Accessory Belt Drive Kit - Fan & Alt.		ACK080780HD	Saf-T-Liner MVP EF		
Belt - Fan & Alt.	61160554	▲K080780HD	Belt - Accessory Belt Drive Kit		
Belt - W.P.	0366775	▲9341HD	Belt - Accessory Drive		
Tensioner Assy. - Fan & Alt.	1352151	38511	Tensioner Assy.		
Idler Pulley - W.P.	1154237	36349	Idler Pulley		
Idler Pulley - Fan & Alt.	2534525	36096	4991240		
Saf-T-Liner MVP EF			GM V-8 4.8 L		
Belt - Accessory Belt Drive Kit		ACK080776HD	Minotour		
Belt - Alt.	2390238	▲K080776HD	Belt - Accessory Belt Drive Kit - A.C.		
Tensioner Assy. - Alt.	2201209	38550	ACK040378HD		

School Buses

▲Standard Belt Available.

≧Cut to Fit.

Belts and Coolant Hose for School Buses

School Buses

Application	Mfr. Part No.	Our No.	Application	Mfr. Part No.	Our No.
Thomas Built - Continued			Thomas Built - Continued		
2005 - Continued			2004 - Continued		
GM V-8 4.8 L - Continued			Caterpillar C7 Diesel - Continued		
Minotour - Continued			Saf-T-Liner HDX - Continued		
Belt - Accessory Belt Drive Kit - Alt. & W.P.		ACK060930HD	Belt - W.P.	0366775	♣9341HD
Belt - Alt. & W.P.	12576451	♣K060930HD	Tensioner Assy. - Fan & Alt.	1352151	38511
Belt - A.C.	12576447	♣K040378HD	Idler Pulley - W.P.	1154237	36349
Tensioner Assy. - Alt. & W.P.	12580162	38158	Idler Pulley - Fan & Alt.	2534525	36096
Tensioner Assy. - A.C.	12580196	38159	Saf-T-Liner MVP ER		
Hose - Rad. To Throttle Body		18129	Belt - Accessory Belt Drive Kit - Alt. & W.P.		ACK080733HD
GM V-8 6.0 L			Belt - Alt. & W.P.	2193303	♣K080733HD
Minotour			Tensioner Assy. - Alt. & W.P.	2201209	38550
Belt - Serpentine; W/105A. Alt.	12576450	♣K060923HD	Cummins ISC Diesel		
Belt - Serpentine; W/145A. Alt.	12576451	♣K060930HD	Saf-T-Liner MVP ER		
Belt - Accessory Belt Drive Kit; W/105A. Alt.		ACK060923HD1	Belt - Eng. To Alt.	3911581	♣K080690HD
Belt - Accessory Belt Drive Kit - A.C.		ACK040378HD	GM V-8 4.8 L		
Belt - Accessory Belt Drive Kit; W/145A. Alt.		ACK060930HD	Minotour		
Belt - A.C.	12576447	♣K040378HD	Belt - Serpentine; W/105A. Alt.	12576450	♣K060923HD
Tensioner Assy. - A.C.	12580196	38159	Belt - Serpentine; W/145A. Alt.	12576451	♣K060930HD
Tensioner Assy. - Serpentine	12580162	38158	Belt - Accessory Belt Drive Kit; W/105A. Alt.		ACK060923HD1
Idler Pulley - Serpentine	12580771	36299	Belt - Accessory Belt Drive Kit - A.C.		ACK040378HD
Tensioner Pulley - Serpentine	12580162	38009	Belt - Accessory Belt Drive Kit; W/145A. Alt.		ACK060930HD
Tensioner Pulley - A.C.	12580196	36169	Belt - A.C.	12576447	♣K040378HD
Hose - Upper		22755	Tensioner Assy. - A.C.	12565372	38159
Hose - Lower		22756	Tensioner Assy. - Serpentine	12554027	38158
John Deere 6-Cyl. 8.1 L CNG			Idler Pulley - Serpentine	12580771	36299
Saf-T-Liner MVP ER			Tensioner Pulley - Serpentine	12554027	38009
Belt - Accessory Belt Drive Kit		ACK080680HD	Tensioner Pulley - A.C.	12565372	36169
Belt - Eng. To Alt.	R128197	♣K080680HD	Hose - Upper		22755
Tensioner Assy. - Alt.	RE518097	38507	Hose - Lower		22756
Mercedes-Benz MBE 900 Diesel			Hose - Heater To Valve		≈28466
Conventional			John Deere 6-Cyl. 8.1 L CNG		
Belt - Fan & Alt.; W/O A.C.	0127110043	♣K080680HD	Saf-T-Liner MVP ER		
Belt - Fan & Alt.; W/A.C.	0127110042	♣K080839HD	Belt - Accessory Belt Drive Kit		ACK080680HD
Hose - Upper - Eng. To Rad.		22992	Belt - Eng. To Alt.	R128197	♣K080680HD
Hose - Lower - Pipe To W.P.		22991	Tensioner Assy. - Alt.	RE518097	38507
Hose - Lower - Eng. To Pipe		22702	Mercedes-Benz MBE 900 Diesel		
Saf-T-Liner C2			Conventional		
Belt - A.C. - Right Side		♣K080820HD	Belt - Serpentine	0127110043	♣K080680HD
2004			Hose - Upper - Eng. To Rad.		22701
Caterpillar 3126 Diesel			Hose - Lower - Eng. To Pipe		20611
Saf-T-Liner MVP EF			Hose - Lower - Pipe To Rad.		22702
Belt - Accessory Belt Drive Kit - Hub & Fan		ACK080780HD	Saf-T-Liner MVP ER		
Belt - Accessory Belt Drive Kit - Alt.		ACK080797HD	Belt - W.P. & Alt.		♣K080680HD
Belt - Hub & Fan	61160554	♣K080780HD	2003		
Belt - W.P.	0366775	♣9341HD	Caterpillar 3126 Diesel		
Belt - Alt.	61160587	♣K080797HD	Conventional		
Tensioner Assy. - Fan, Alt. & A.C.	1352151	38511	Belt - Accessory Belt Drive Kit		ACK080708HD
Tensioner Pulley - Fan, Alt. & A.C.	1352151	36091	Belt - Fan, Alt. & A.C.	0127110003	♣K080708HD
Hose - Upper - Eng. To Rad.		≈22668	Belt - W.P.	0366775	♣9341HD
Hose - Lower - Eng. To Rad.		22996	Tensioner Assy. - Fan, Alt. & A.C.	1352151	38511
Saf-T-Liner MVP ER			Tensioner Pulley - Fan, Alt. & A.C.	1352151	36091
Belt - Alt.	61160554	♣K080780HD	Hose - Upper - Eng. To Rad.		20735
Belt - W.P.	0366775	♣9341HD	Hose - Lower - Pipe To Rad.		21473
Belt - A.C.; W/Dual A.C.		♣K060716HD	Saf-T-Liner MVP EF		
Tensioner Assy. - Alt.	1352151	38511	Belt - Accessory Belt Drive Kit - Fan, Alt. & A.C.		ACK080780HD
Tensioner Pulley - Alt.	1352151	36091	Belt - Fan, Alt. & A.C.	61160554	♣K080780HD
Caterpillar C7 Diesel			Belt - W.P.	0366775	♣9341HD
Conventional			Tensioner Assy. - Fan, Alt. & A.C.	1352151	38511
Belt - Fan & Alt.	0127110003	♣K080708HD	Tensioner Pulley - Fan, Alt. & A.C.	1352151	36091
Belt - W.P.	0366775	♣9341HD	Saf-T-Liner MVP ER		
Hose - Upper - Eng. To Rad.		22668	Belt - Accessory Belt Drive Kit - Hub & Alt.		ACK080780HD
Saf-T-Liner HDX			Belt - Hub & Alt.	61160554	♣K080780HD
Belt - Accessory Belt Drive Kit - Fan & Alt.		ACK080780HD	Belt - W.P. & Idler	0366775	♣9341HD
Belt - Fan & Alt.	61160554	♣K080780HD	Belt - Fan - Left Side	61160591	2/B86

♣Standard Belt Available.

≈Cut to Fit.

Belts and Coolant Hose for School Buses

Application	Mfr. Part No.	Our No.	Application	Mfr. Part No.	Our No.
Thomas Built - Continued			Thomas Built - Continued		
2003 - Continued			2002 - Continued		
Caterpillar 3126 Diesel - Continued			Caterpillar 3126 Diesel - Continued		
Saf-T-Liner MVP ER - Continued			Saf-T-Liner MVP EF		
Tensioner Assy. - Hub & Alt.	1352151	38511	Belt - Accessory Belt Drive Kit - Fan, Alt. & A.C.		ACK080780HD
Tensioner Pulley - Hub & Alt.	1352151	36091	Belt - Fan, Alt. & A.C.	61160554	▲K080780HD
Caterpillar 3208 Diesel			Belt - W.P.	0366775	▲9341HD
Saf-T-Liner MVP ER			Tensioner Assy. - Fan, Alt. & A.C.	1352151	38511
Belt - Serpentine		▲K080780HD	Tensioner Pulley - Fan, Alt. & A.C.	1352151	36091
Belt - Fan		2/B86	Saf-T-Liner MVP ER		
Hose - Upper - Eng. To Pipe		20206	Belt - Accessory Belt Drive Kit - Hub & Alt.		ACK080780HD
Hose - Turbo To Pipe (Hot Side)		26200	Belt - Hub & Alt.	61160554	▲K080780HD
Hose - Pipe To Intercooler (Hot Side)		26200	Belt - W.P. & Idler	0366775	▲9341HD
Hose - Intercooler To Pipe (Cold Side)		26200	Tensioner Assy. - Hub & Alt.	1352151	38511
Hose - Pipe To Engine (Cold Side)		26200	Tensioner Pulley - Hub & Alt.	1352151	36091
Cummins ISB Diesel			Caterpillar 3208 Diesel		
Conventional			Saf-T-Liner MVP ER		
Belt - Accessory Belt Drive Kit		ACK080694HD	Belt - Fan		2/B86
Belt - Serpentine	3926856	▲K080694HD	Belt - Alt.	449667C1	②▲9650HD
Tensioner Assy.	3936213	38516	Belt - P.S.	862880R2	▲9490HD
Tensioner Pulley	3936213	36093	Cummins ISB Diesel		
Hose - Upper - Eng. To Rad.		22700	Conventional		
Hose - Lower		21473	Belt - Accessory Belt Drive Kit		ACK080694HD
Saf-T-Liner MVP EF			Belt - Serpentine	3926856	▲K080694HD
Belt - Accessory Belt Drive Kit		ACK080694HD	Tensioner Assy.	3936213	38516
Belt - Fan	3926856	▲K080694HD	Tensioner Pulley	3936213	36093
Tensioner Assy. - Fan	3936213	38516	Hose - Upper - Eng. To Rad.		22700
Saf-T-Liner MVP ER			Hose - Lower		21473
Belt - Alt.	3925953	▲K080585HD	Saf-T-Liner MVP EF		
Belt - Fan - From C.S.	61160591	2/B86	Belt - Accessory Belt Drive Kit - Fan, Alt. & Hub		ACK080694HD
Cummins ISC Diesel			Belt - Fan, Alt. & Hub	3926856	▲K080694HD
Saf-T-Liner MVP ER			Tensioner Assy. - Fan & A.C.	3934823	38513
Belt - Serpentine	3911581	▲K080690HD	Tensioner Assy. - Fan, Alt. & Hub	3936213	38516
John Deere 6-Cyl. 8.1 L CNG			Tensioner Pulley - Fan, Alt. & Hub	3936213	36093
Saf-T-Liner MVP ER			Tensioner Pulley - Fan & A.C.	3934823	36091
Belt - Accessory Belt Drive Kit		ACK080680HD	Saf-T-Liner MVP ER		
Belt - Eng. To Alt.	R128197	▲K080680HD	Belt - Alt.	3925953	▲K080585HD
Belt - A.C. To Alt.	13A1105	▲9435HD	Belt - Fan - From C.S.	61160591	2/B86
Belt - A.C.		BX99	John Deere 6-Cyl. 8.1 L CNG		
Tensioner Assy. - Eng. To Alt.	RE70535	38507	Saf-T-Liner MVP ER		
Tensioner Pulley - Eng. To Alt.	RE70535	36091	Belt - Serpentine	R128197	▲K080680HD
Mercedes-Benz MBE 900 Diesel			Belt - Accessory Belt Drive Kit		ACK080680HD
Conventional			Tensioner Assy.	RE70535	38507
Belt - Serpentine	0127110043	▲K080680HD	Tensioner Pulley	RE70535	36091
Hose - Upper - Eng. To Rad.		22701	Hose - Upper - Pipe To Rad.		24232
Hose - Lower - Eng. To Pipe		20611	Hose - Upper - Eng. To Pipe		21891
Hose - Lower - Pipe To Rad.		22702	2001		
Saf-T-Liner MVP ER			Caterpillar 3116 Diesel		
Belt - W.P. & Alt.		▲K080680HD	Saf-T-Liner MVP ER		
2002			Belt - Fan & Alt.		▲K080780HD
Caterpillar 3116 Diesel			Belt - W.P.	7E0744DF	②▲9350HD
Saf-T-Liner MVP ER			Caterpillar 3126 Diesel		
Belt - Fan & Alt.		▲K080780HD	Conventional		
Belt - W.P.	7E0744DF	②▲9350HD	Belt - Accessory Belt Drive Kit		ACK080708HD
Caterpillar 3126 Diesel			Belt - Fan, Alt. & A.C.	0127110003	▲K080708HD
Conventional			Belt - W.P.	0366775	▲9341HD
Belt - Accessory Belt Drive Kit		ACK080708HD	Tensioner Assy. - Fan, Alt. & A.C.	1352151	38511
Belt - Fan, Alt. & A.C.	0127110003	▲K080708HD	Tensioner Pulley - Fan, Alt. & A.C.	1352151	36091
Belt - W.P.	0366775	▲9341HD	Hose - Upper - Eng. To Rad.		20735
Tensioner Assy. - Fan, Alt. & A.C.	1352151	38511	Hose - Lower - Pipe To Rad.		21473
Tensioner Pulley - Fan, Alt. & A.C.	1352151	36091	Saf-T-Liner MVP EF		
Hose - Upper - Eng. To Rad.		20735	Belt - Accessory Belt Drive Kit - Fan, Alt. & A.C.		ACK080780HD
Hose - Lower - Pipe To Rad.		21473	Belt - Fan, Alt. & A.C.	61160554	▲K080780HD
Saf-T-Liner MVP ER			Belt - W.P.	0366775	▲9341HD
Belt - Accessory Belt Drive Kit - Fan, Alt. & A.C.		ACK080780HD	Tensioner Assy. - Fan, Alt. & A.C.	1352151	38511
Belt - Fan, Alt. & A.C.	61160554	▲K080780HD	2002		
Belt - W.P.	0366775	▲9341HD	Caterpillar 3116 Diesel		
Tensioner Assy. - Fan, Alt. & A.C.	1352151	38511	Saf-T-Liner MVP ER		
2002			Belt - Fan & Alt.		▲K080780HD
Caterpillar 3116 Diesel			Belt - W.P.	7E0744DF	②▲9350HD
Conventional			Caterpillar 3126 Diesel		
Belt - Accessory Belt Drive Kit		ACK080708HD	Conventional		
Belt - Fan, Alt. & A.C.	0127110003	▲K080708HD	Belt - Accessory Belt Drive Kit		ACK080708HD
Belt - W.P.	0366775	▲9341HD	Belt - Fan, Alt. & A.C.	0127110003	▲K080708HD
Tensioner Assy. - Fan, Alt. & A.C.	1352151	38511	Belt - W.P.	0366775	▲9341HD
Tensioner Pulley - Fan, Alt. & A.C.	1352151	36091	Tensioner Assy. - Fan, Alt. & A.C.	1352151	38511
Hose - Upper - Eng. To Rad.		20735	Tensioner Pulley - Fan, Alt. & A.C.	1352151	36091
Hose - Lower - Pipe To Rad.		21473	Hose - Upper - Eng. To Rad.		20735
Saf-T-Liner MVP ER			Hose - Lower - Pipe To Rad.		21473
Belt - Accessory Belt Drive Kit - Fan, Alt. & A.C.		ACK080780HD	Saf-T-Liner MVP EF		
Belt - Fan, Alt. & A.C.	61160554	▲K080780HD	Belt - Accessory Belt Drive Kit - Fan, Alt. & A.C.		ACK080780HD
Belt - W.P.	0366775	▲9341HD	Belt - Fan, Alt. & A.C.	61160554	▲K080780HD
Tensioner Assy. - Fan, Alt. & A.C.	1352151	38511	Belt - W.P.	0366775	▲9341HD
2002			Tensioner Assy. - Fan, Alt. & A.C.	1352151	38511
Caterpillar 3116 Diesel			2002		
Saf-T-Liner MVP ER			Caterpillar 3126 Diesel		
Belt - Fan & Alt.		▲K080780HD	Conventional		
Belt - W.P.	7E0744DF	②▲9350HD	Belt - Accessory Belt Drive Kit		ACK080708HD
Caterpillar 3126 Diesel			Belt - Fan, Alt. & A.C.	0127110003	▲K080708HD
Conventional			Belt - W.P.	0366775	▲9341HD
Belt - Accessory Belt Drive Kit		ACK080708HD	Tensioner Assy. - Fan, Alt. & A.C.	1352151	38511
Belt - Fan, Alt. & A.C.	0127110003	▲K080708HD	Tensioner Pulley - Fan, Alt. & A.C.	1352151	36091
Belt - W.P.	0366775	▲9341HD	Hose - Upper - Eng. To Rad.		20735
Tensioner Assy. - Fan, Alt. & A.C.	1352151	38511	Hose - Lower - Pipe To Rad.		21473
Tensioner Pulley - Fan, Alt. & A.C.	1352151	36091	Saf-T-Liner MVP EF		
Hose - Upper - Eng. To Rad.		20735	Belt - Accessory Belt Drive Kit - Fan, Alt. & A.C.		ACK080780HD
Hose - Lower - Pipe To Rad.		21473	Belt - Fan, Alt. & A.C.	61160554	▲K080780HD
Saf-T-Liner MVP ER			Belt - W.P.	0366775	▲9341HD
Belt - Accessory Belt Drive Kit - Fan, Alt. & A.C.		ACK080780HD	Tensioner Assy. - Fan, Alt. & A.C.	1352151	38511
Belt - Fan, Alt. & A.C.	61160554	▲K080780HD	2002		
Belt - W.P.	0366775	▲9341HD	Caterpillar 3116 Diesel		
Tensioner Assy. - Fan, Alt. & A.C.	1352151	38511	Saf-T-Liner MVP ER		

▲Standard Belt Available.

②Two Required.

Belts and Coolant Hose for School Buses

School Buses

Application	Mfr. Part No.	Our No.	Application	Mfr. Part No.	Our No.
Thomas Built - Continued			Thomas Built - Continued		
2001 - Continued			2000 - Continued		
Caterpillar 3126 Diesel - Continued			Caterpillar 3126 Diesel - Continued		
Saf-T-Liner MVP EF - Continued			Saf-T-Liner MVP EF		
Tensioner Pulley - Fan, Alt. & A.C.	1352151	36091	Belt - Accessory Belt Drive Kit - Fan, Alt. & A.C.		ACK080780HD
Saf-T-Liner MVP ER			Belt - Fan, Alt. & A.C.	61160554	▲K080780HD
Belt - Accessory Belt Drive Kit - Hub & Alt.		ACK080780HD	Belt - W.P.	0366775	▲9341HD
Belt - Hub & Alt.	61160554	▲K080780HD	Tensioner Assy. - Fan, Alt. & A.C.	1352151	38511
Belt - W.P. & Idler	0366775	▲9341HD	Tensioner Pulley - Fan, Alt. & A.C.	1352151	36091
Belt - Fan	61160591	2/B86	Caterpillar 3208 Diesel		
Tensioner Assy. - Hub & Alt.	1352151	38511	Saf-T-Liner MVP ER		
Tensioner Pulley - Hub & Alt.	1352151	36091	Belt - Fan		②▲9730HD
Caterpillar 3208 Diesel			Belt - Alt.	449667C1	②▲9650HD
Saf-T-Liner MVP ER			Belt - P.S.	862880R2	▲9490HD
Belt - Fan		②▲9730HD	Cummins ISB Diesel		
Belt - Alt.	449667C1	②▲9650HD	Conventional		
Belt - P.S.	862880R2	▲9490HD	Belt - Accessory Belt Drive Kit		ACK080694HD
Cummins ISB Diesel			Belt - Serpentine	3926856	▲K080694HD
Conventional			Tensioner Assy.	3936213	38516
Belt - Accessory Belt Drive Kit		ACK080694HD	Tensioner Pulley	3936213	36093
Belt - Serpentine	3926856	▲K080694HD	Hose - Upper - Eng. To Rad.		22669
Tensioner Assy.	3936213	38516	Hose - Lower - Eng. To Rad.		22670
Tensioner Pulley	3936213	36093	Saf-T-Liner MVP EF		
Hose - Upper - Eng. To Rad.		22669	Belt - Accessory Belt Drive Kit - Fan, Alt. & Hub		ACK080694HD
Hose - Lower - Eng. To Rad.		22670	Belt - Fan, Alt. & Hub	3926856	▲K080694HD
Saf-T-Liner MVP EF			Belt - Fan & A.C.	2310001067	▲9480HD
Belt - Accessory Belt Drive Kit - Fan, Alt. & Hub		ACK080694HD	Tensioner Assy. - Fan & A.C.	3934823	38513
Belt - Fan, Alt. & Hub	3926856	▲K080694HD	Tensioner Assy. - Fan, Alt. & Hub	3936213	38516
Belt - Fan & A.C.	2310001067	▲9480HD	Tensioner Pulley - Fan, Alt. & Hub	3936213	36093
Tensioner Assy. - Fan & A.C.	3934823	38513	Tensioner Pulley - Fan & A.C.	3934823	36091
Tensioner Assy. - Fan, Alt. & Hub	3936213	38516	Hose - Upper - Eng. To Rad.		22846
Tensioner Pulley - Fan, Alt. & Hub	3936213	36093	Hose - Lower - Eng. To Rad.		22847
Tensioner Pulley - Fan & A.C.	3934823	36091	Saf-T-Liner MVP ER		
Saf-T-Liner MVP ER			Tensioner Assy. - Alt. & W.P.	3945527	38516
Belt - Alt.	3925953	▲K080585HD	Tensioner Pulley - Alt. & W.P.	3945527	36093
Belt - Fan - From C.S.	61160591	2/B86	Cummins ISC Diesel		
GM V-8 5.7 L			Saf-T-Liner MVP ER		
Minotour			Belt - Accessory Belt Drive Kit		ACK080690HD1
Belt - Accessory Belt Drive Kit; W/A.C.		ACK060960HD	Belt - Alt. & W.P.	3911581	▲K080690HD
Belt - Accessory Belt Drive Kit; W/O A.C.; W/130A. Alt.		ACK060875HD	Belt - A.C. - Left Side		▲9550HD
Belt - Serpentine; W/A.C.	12564763	▲K060960HD	Belt - A.C. - Right Side		▲9505HD
Belt - Serpentine; W/O A.C.; W/130A. Alt. ..	12564760	▲K060875HD	Tensioner Assy. - Alt. & W.P.	3945527	38516
Tensioner Assy.; W/O A.C.; W/130A. Alt.		38103	Tensioner Pulley - Alt. & W.P.	3945527	36093
Tensioner Pulley; W/O A.C.; W/130A. Alt.		38008	1999		
Hose - Upper		22357	Caterpillar 3116 Diesel		
Hose - Lower		22425	Saf-T-Liner MVP ER		
John Deere 6-Cyl. 8.1 L CNG			Belt - Fan & Alt.		▲K080780HD
Saf-T-Liner MVP ER			Belt - W.P.	7E0744DF	②▲9350HD
Tensioner Assy. - Hub & Alt.	RE70535	38507	Belt - A.C.	D137Y070027	2/BX85
Tensioner Pulley - Hub & Alt.	RE70535	36091	Caterpillar 3126 Diesel		
2000			Conventional		
Caterpillar 3116 Diesel			Belt - Accessory Belt Drive Kit		ACK080708HD
Saf-T-Liner MVP ER			Belt - W.P.	0366775	▲9341HD
Belt - Fan & Alt.		▲K080780HD	Belt - Fan, Alt. & A.C.	0123415043	▲K080708HD
Belt - W.P.	7E0744DF	②▲9350HD	Tensioner Assy. - Fan, Alt. & A.C.	1352151	38511
Caterpillar 3126 Diesel			Tensioner Pulley - Fan, Alt. & A.C.	1352151	36091
Conventional			Hose - Upper - Eng. To Rad.		22668
Belt - Accessory Belt Drive Kit		ACK080708HD	Hose - Lower - Pipe To Rad.		21473
Belt - Fan, Alt. & A.C.	0127110003	▲K080708HD	Saf-T-Liner MVP EF		
Belt - W.P.	0366775	▲9341HD	Belt - Accessory Belt Drive Kit - Fan, Alt. & A.C.		ACK080780HD
Tensioner Assy. - Fan, Alt. & A.C.	1352151	38511	Belt - Fan, Alt. & A.C.	61160554	▲K080780HD
Tensioner Pulley - Fan, Alt. & A.C.	1352151	36091	Belt - W.P.	0366775	▲9341HD
Hose - Upper - Eng. To Rad.		22668	Tensioner Assy. - Fan, Alt. & A.C.	1352151	38511
Hose - Lower - Pipe To Rad.		21473	Tensioner Pulley - Fan, Alt. & A.C.	1352151	36091
			Idler Pulley	2534525	36096

▲Standard Belt Available.

②Two Required.

Belts and Coolant Hose for School Buses

Application	Mfr. Part No.	Our No.	Application	Mfr. Part No.	Our No.
Thomas Built - Continued			Thomas Built - Continued		
1999 - Continued			1996		
Caterpillar 3208 Diesel			Caterpillar 3116 Diesel		
Saf-T-Liner MVP ER			Saf-T-Liner MVP ER		
Belt - Fan		②♣9730HD	Belt - Fan & Alt.		♣K080780HD
Belt - Alt.	449667C1	②♣9650HD	Belt - W.P.	7E0744DF	②♣9350HD
Belt - P.S.	862880R2	♣9490HD	Caterpillar 3126 Diesel		
Cummins ISB Diesel			Saf-T-Liner MVP EF		
Belt - Serpentine	3926856	♣K080694HD	Belt - Fan, Alt. & A.C.	61160554	♣K080780HD
Saf-T-Liner MVP ER			Cummins B Series 5.9 L Diesel		
Tensioner Assy. - Alt. & W.P.	3945527	38516	Saf-T-Liner MVP EF		
Tensioner Pulley - Alt. & W.P.	3945527	36093	Belt - Alt. & W.P.	3911572	♣K080615HD
1998			Saf-T-Liner MVP ER		
Caterpillar 3116 Diesel			Belt - Eng. To Fan		
Saf-T-Liner MVP ER			Belt - Alt. & W.P.		
Belt - Fan & Alt.		♣K080780HD	Belt - A.C. - Right Side		
Belt - W.P.	7E0744DF	②♣9350HD	Belt - A.C. - Left Side		
Caterpillar 3126 Diesel			International/Navistar T444 Diesel		
Conventional			Vista		
Belt - Accessory Belt Drive Kit		ACK080708HD	Belt - Serpentine		
Belt - W.P.	0366775	♣9341HD	1822830C1		
Belt - Fan, Alt. & A.C.	0123415043	♣K080708HD	1995		
Tensioner Assy. - Fan, Alt. & A.C.	1352151	38511	Caterpillar 3116 Diesel		
Tensioner Pulley - Fan, Alt. & A.C.	1352151	36091	Saf-T-Liner MVP ER		
Hose - Upper - Eng. To Rad.		22668	Belt - Fan & Alt.		
Hose - Lower - Pipe To Rad.		21473	Belt - W.P.		
Saf-T-Liner MVP EF			Westcoast-ER		
Belt - Accessory Belt Drive Kit - Fan, Alt. & A.C.		ACK080780HD	Belt - Fan & Alt.		
Belt - Fan, Alt. & A.C.	61160554	♣K080780HD	61160531		
Tensioner Assy. - Fan, Alt. & A.C.	1352151	38511	Caterpillar 3126 Diesel		
Tensioner Pulley - Fan, Alt. & A.C.	1352151	36091	Saf-T-Liner MVP EF		
Cummins ISB Diesel			Belt - Fan, Alt. & A.C.		
Saf-T-Liner MVP EF			61160554		
Belt - Serpentine	3926856	♣K080694HD	Cummins B Series 5.9 L Diesel		
Cummins ISC Diesel			Saf-T-Liner MVP EF		
Saf-T-Liner MVP ER			Belt - Alt. & W.P.		
Belt - Accessory Belt Drive Kit - Alt. & W.P.		ACK080660HD	3911572		
Belt - Fan		BX85	International/Navistar T444 Diesel		
Belt - A.C. - Left Side		♣9463HD	Vista		
Belt - Alt. & W.P.		♣K080660HD	Hose - Upper		
Belt - A.C. - Right Side		♣9455HD	Hose - Lower - Eng. To Pipe		
Tensioner Assy. - Alt. & W.P.	3937556	38513	Hose - Lower - Pipe To Pipe		
Tensioner Pulley - Hub & Alt.	3937556	36091	Hose - Lower - Pipe To Rad.		
1997			22159		
Caterpillar 3116 Diesel			≈<21042		
Saf-T-Liner MVP ER			24248		
Belt - Fan & Alt.		♣K080780HD	≈<21042		
Belt - W.P.	7E0744DF	②♣9350HD	1994 - 1993		
Caterpillar 3126 Diesel			Caterpillar 3116 Diesel		
Saf-T-Liner MVP EF			Saf-T-Liner MVP ER		
Belt - Fan, Alt. & A.C.	61160554	♣K080780HD	Belt - Fan & Alt.		
Cummins ISB Diesel			Belt - W.P.		
Saf-T-Liner MVP EF			7E0744DF		
Belt - Serpentine	3926856	♣K080694HD	②♣9350HD		
Cummins ISC Diesel			Cummins B Series 5.9 L Diesel		
Saf-T-Liner MVP ER			Saf-T-Liner MVP EF		
Belt - Alt. & W.P.	3926866	K080638HD	Belt - Alt. & W.P.		
Tensioner Assy.	3922901	38513	3911572		
			♣K080615HD		
			GM V-8 5.7 L		
			Minotour		
			Belt - Serpentine; W/A.C.		
			Belt - Serpentine; W/O A.C.		
			Tensioner Assy.; W/A.C.		
			Tensioner Assy.; W/O A.C.		
			Idler Pulley		
			Tensioner Pulley; W/A.C.		
			Tensioner Pulley; W/O A.C.		
			Hose - Upper		
			Hose - Lower		
			or		
			♣K060988HD		
			♣K060905HD		
			38107		
			38106		
			38001		
			38001		
			38009		
			≈<21191		
			21618		
			25530		

School Buses

 ♣Standard Belt Available.
 ≈<Cut to Fit.

②Two Required.

Belts and Coolant Hose for School Buses

School Buses

Application	Mfr. Part No.	Our No.	Application	Mfr. Part No.	Our No.
Thomas Built - Continued			Ward		
1992			1999 - 1991		
Caterpillar 3116 Diesel			GM V-8 7.4 L		
Saf-T-Liner MVP ER			Volunteer		
Belt - Fan & Alt.		♣K080780HD	Belt - Fan & Alt.		②♣9640HD
Belt - W.P.	7E0744DF	②♣9350HD	Belt - Fan To Air Brake Compr.		♣9470HD
1991			Belt - Fan To P.S.		♣9395HD
Caterpillar 3116 Diesel			Hose - Upper		21107
Saf-T-Liner MVP ER			Hose - Lower - Eng. To Pipe		24236
Belt - Fan & Alt.		♣K080780HD	Hose - Lower - Pipe To Rad.		≈<20756
Belt - W.P.	7E0744DF	②♣9350HD	International/Navistar DT466 Diesel		
Cummins B Series 5.9 L Diesel			Volunteer		
Saf-T-Liner MVP ER			Belt - Fan & Alt.		②♣9690HD
Belt - Alt. & W.P.	5080730	♣K080730HD	Belt - Fan & Air Brake Compr.		TR22770
Tensioner Assy. - Alt. & W.P.	3914854	38518	Hose - Upper		≈<21765
Cummins C Series 8.3 L Diesel			Hose - Lower - Pipe To Rad.		≈<20987
Westcoast-ER			1990 - 1989		
Belt - Serpentine		♣K080610HD	GM V-8 7.4 L		
Tensioner Assy.	3936201	38504	Volunteer		
Tensioner Pulley	3936201	36091	Belt - Fan & Alt.		②♣9640HD
1990			Belt - Fan To Air Brake Compr.		♣9470HD
Caterpillar 3116 Diesel			Belt - Fan To P.S.		♣9395HD
Saf-T-Liner MVP ER			Hose - Upper		21107
Belt - Fan & Alt.		♣K080780HD	Hose - Lower - Eng. To Pipe		24236
Belt - W.P.	7E0744DF	②♣9350HD	Hose - Lower - Pipe To Rad.		≈<20756
Caterpillar 3208 Diesel			International/Navistar DT466 Diesel		
Saf-T-Liner MVP ER			Volunteer		
Belt - W.P., Alt. & A.C.; Preferred Belt		2/9650PB	Belt - Fan & Alt.		②♣9690HD
Belt - W.P., Alt. & A.C.; Optional Belt		②♣9650HD	Belt - Fan & Air Brake Compr.		TR22770
Belt - A.C.		♣9500HD	Hose - Upper		≈<21765
Belt - Fan		②♣9730HD	Hose - Lower - Pipe To Rad.		≈<20987
Belt - P.S.		♣9385HD	International/Navistar DTA360 Diesel		
Cummins C Series 8.3 L Diesel			Senator		
Westcoast-ER			Belt - Fan & Alt.		②♣9700HD
Belt - Serpentine		♣K080610HD	Hose - Upper		26532
Tensioner Assy.	3937556	38513	1988 - 1980		
Tensioner Pulley	3937556	36091	GM V-8 7.4 L		
1988			Volunteer		
Caterpillar 3208 Diesel			Belt - Fan & Alt.		②♣9640HD
Saf-T-Liner MVP ER			Belt - Fan To Air Brake Compr.		♣9470HD
Belt - P.S.		♣9395HD	Belt - Fan To P.S.		♣9395HD
Belt - J.S.		②♣9495HD	Hose - Upper		21107
Belt - W.P. & Idler		②♣9495HD	Hose - Lower - Eng. To Pipe		24236
Belt - W.P., Alt. & A.C.; Preferred Belt		2/9650PB	Hose - Lower - Pipe To Rad.		≈<20756
Belt - W.P., Alt. & A.C.; Optional Belt		②♣9650HD	International/Navistar DT466 Diesel		
1986			Volunteer		
Caterpillar 3208 Diesel			Belt - Fan & Alt.		②♣9690HD
22123			Belt - Fan & Air Brake Compr.		TR22770
Belt - Fan		②♣9730HD	Hose - Upper		≈<21765
Belt - W.P.		②♣♣9470HD	Hose - Lower - Pipe To Rad.		≈<20987
Belt - Alt. & Air Brake Compr.		②♣9650HD			
Belt - P.S.		♣9385HD			
Hose - Upper - Eng. To Pipe		24232			
Hose - Upper - Pipe To Rad.		24236			
Hose - Lower		③24232			
Hose - Oil Cooler - Front Inlet		21824			
Hose - Oil Cooler - Rear Inlet		21381			
Hose - Oil Cooler Outlet		21380			

♣Standard Belt Available.
 ◆PowerBand Belt May Work, Use Template to Check.
 ≈<Cut to Fit.

②Two Required.
 ③Three Required.

Belts and Coolant Hose for Transit Buses

Order Belts and Hose by Our Number. Manufacturers' Part Number is shown for reference only.

Application	Mfr. Part No.	Our No.	Application	Mfr. Part No.	Our No.	
ABC Bus Companies, Inc.			Bluebird			
2005			2006			
Cummins ISB Diesel			Caterpillar C7 Diesel			
M1035			Xcel 102			
Belt - Fan To A.C.; W/Dual A.C.			Belt - W.P. 0366775			▲9341HD
Belt - Fan, Alt. & Idler 3915768			Belt - Alt.			▲K080510HD
▲K080605HD			Caterpillar C13 Diesel			
▲K080733HD			Express 4500			
Aerocoach			Belt - A.C.			2/5V950
1952 - 1940			Belt - Alt.; W/Dual Alts. 2534012			▲K120975HD
International/Navistar RD450 Diesel			Cummins ISB Diesel			
P37			Ultra LF			
Belt - Fan & Gen.			Belt - Alt. & W.P. 3289426			▲K080716HD
P373			2005			
Belt - Gen.			Caterpillar C13 Diesel			
T361			Express 4500			
Belt - Alt.			Belt - A.C.			2/5V950
TR22508			Belt - Alt.; W/Dual Alts. 2534012			▲K120975HD
Alexander-Dennis			2004			
2007			Caterpillar C7 Diesel			
Cummins ISM Diesel			Xcel 102			
Trident E500			Belt - A.C.			1454628
Belt - Accessory Drive 3256858			Tensioner Assy. - A.C.			7E3999
▲K100955HD			Tensioner Pulley 7E3999			38509
2005			Caterpillar C12 Diesel			
Cummins ISM Diesel			Express 4500			
Enviro500			Belt - Alt.			0059241
Belt - Accessory Drive 3256858			Belt - A.C.			▲K080922HD
▲K100955HD			2003			
AM General			Cummins ISB Diesel			
1978 - 1976			Ultra LF			
Detroit Diesel 8V-71 Diesel			Belt - A.C.			②BX100
10240B			Ultra LMB			
Belt - A.C.			Belt - A.C.			▲K060559HD
AMG Bus II			Belt - Alt. & W.P. 3926942			▲K080760HD
Belt - Alt. 5953644			2003			
K070370			Cummins ISB Diesel			
1975 - 1974			Ultra LF			
Detroit Diesel 8V-71 Diesel			Belt - Eng. To Alt. 3929003			▲K080774HD
AMG Bus II			Belt - A.C. To Alt. XPA1150			A43
Belt - Alt. 5953644			Xcel 102			
K070370			Belt - Alt. 3926856			▲K080694HD
Beaver Coach			Belt - A.C. To Alt.			▲9476HD
1956 - 1945			2002			
International/Navistar RD361 Diesel			Cummins ISB Diesel			
B31PT; B35PT			Ultra LF			
Belt - Fan; W/13" Belt O.C.			Belt - A.C. & Alt.			A43
Belt - Fan; W/78" Belt O.C.			Belt - A.C.			B98
Belt - A.C.			Belt - Alt. 3929003			▲K080774HD
TR34467			Ultra LMB			
B40PT			Belt - Alt. 3926942			▲K080760HD
Belt - A.C.			Belt - A.C.			A50
TR34456			2001			
International/Navistar RD450 Diesel			John Deere 6-Cyl. 8.1 L CNG			
B31PT; B35PT			Q-Bus RE			
Belt - Fan; W/13" Belt O.C.			Belt - Hub & Alt. R128197			▲K080680HD
Belt - Fan; W/78" Belt O.C.			Tensioner Assy. - Hub & Alt. RE70535			38507
Belt - A.C.			Tensioner Pulley - Hub & Alt. RE70535			36091
TR34467						
B40PT						
Belt - A.C.						
TR34456						

▲Standard Belt Available.

②Two Required.

Transit Buses

Belts and Coolant Hose for Transit Buses

Transit Buses

Application	Mfr. Part No.	Our No.	Application	Mfr. Part No.	Our No.
Bluebird - Continued			Chance Mfg. Co. - Continued		
1999			1992 - Continued		
Cummins ISB Diesel			Caterpillar 3208 Diesel		
Q-Bus RE			RT52		
Belt - Alt. & W.P.	3922562	♣K080716HD	Belt - P.S. & W.P.		♣9555HD
Belt - A.C.		♣9455HD	Belt - W.P. & A.C.		♣9625HD
Tensioner Assy. - Alt. & W.P.	3934820	38513	Belt - Alt. & Air Brake Compr.; W/160A. Leece Neville		
Tensioner Pulley - Alt. & W.P.	3934820	36091	Alt.		ⓂA78
Hose - Upper		20206	Belt - Alt. & Air Brake Compr.; W/190A. Leece Neville		
Hose - Lower		21473	Alt.		Ⓜ9830
1998 - 1997			1991 - 1990		
Cummins ISB CNG			Caterpillar 3208 Diesel		
Q-Bus RE			RT52		
Belt - Hub & Alt.		♣K080605HD	Belt - P.S. & W.P.		♣9555HD
Belt - A.C. - Left Side		♣9451HD	Belt - W.P. & A.C.		♣9625HD
Belt - A.C. - Right Side		♣9451HD	Belt - Alt. & Air Brake Compr.; W/160A. Leece Neville		
Tensioner Assy. - Hub & Alt.	3937556	38513	Alt.		ⓂA78
Tensioner Pulley - Hub & Alt.	3937556	36091	Belt - Alt. & Air Brake Compr.; W/190A. Leece Neville		
1996 - 1994			1989 - 1986		
Cummins B Series 5.9 L CNG			Caterpillar 3208 Diesel		
Q-Bus RE			RT52; VS24		
Belt - Hub & Alt.		♣K080605HD	Belt - P.S. & W.P.		♣9555HD
Belt - A.C.		Ⓜ♣9451HD	Belt - W.P. & A.C.		♣9625HD
Tensioner Assy. - Hub & Alt.	3937556	38513	Belt - Alt. & Air Brake Compr.; W/160A. Leece Neville		
Tensioner Pulley - Hub & Alt.	3937556	36091	Alt.		ⓂA78
Champion Bus			1985 - 1983		
2003			Caterpillar 3208 Diesel		
Cummins ISB Diesel			RT50; VS24		
CTS RE			Belt - P.S. & W.P.		
Belt - A.C.		♣K080585HD	Belt - W.P. & A.C.		♣9555HD
Belt - Alt.	3943348	♣K080738HD	Belt - Alt. & Air Brake Compr.; W/160A. Leece Neville		♣9625HD
Tensioner Assy. - Alt.	3936213	38516	Alt.		ⓂA78
Tensioner Pulley - Alt.	3936213	36093	Belt - Alt. & Air Brake Compr.; W/190A. Leece Neville		
2002			Alt.		
Ford V-10 6.8 L			Ⓜ9830		
Challenger; Crusader			1982 - 1978		
Belt - Serpentine; W/A.C.			Caterpillar 3208 Diesel		
Belt - Serpentine; W/O A.C.		♣K080991HD	RT50		
Tensioner Assy.; W/A.C.		♣K080806HD	Belt - P.S. & W.P.		
Idler Pulley		38133	Belt - W.P. & A.C.		
Tensioner Pulley - Smooth; W/A.C.		38022	Belt - Alt. & Air Brake Compr.; W/160A. Leece Neville		
Hose - Upper		38023	Alt.		
Hose - Lower		22316	Belt - Alt. & Air Brake Compr.; W/190A. Leece Neville		
		22371	Alt.		
Chance Mfg. Co.			Chevrolet		
2000 - 1993			1968 - 1964		
Caterpillar 3208 Diesel			GMC D478 Diesel		
RT52			TDH3501; TDH3502; TDH3502A		
Belt - P.S. & W.P.		♣9555HD	Belt - Fan	2465849	TR22792
Belt - W.P. & A.C.		♣9625HD	Belt - W.P. & Alt.	2466318	Ⓜ♣9630HD
Belt - Alt. & Air Brake Compr.; W/160A. Leece Neville			Belt - Alt.; W/A.C.	668850	♣9425HD
Alt.		ⓂA78	Belt - Air Brake Compr.	2463090	♣9660HD
Belt - Alt. & Air Brake Compr.; W/190A. Leece Neville			Belt - A.C.	78283	5VX850
Alt.		Ⓜ9830	GMC DH478 Diesel		
1992			TDH3501; TDH3502; TDH3502A		
American Motors 6-Cyl. 258			Belt - Fan		
Sunliner			Belt - W.P. & Alt.		
Belt - W.P. & Alt.		♣9470HD	Belt - Alt.; W/A.C.		
Belt - W.P. & Air Compr.		♣9530HD	Belt - Air Brake Compr.		
Belt - P.S.		♣9405HD	Belt - A.C.		
			78283		

♣Standard Belt Available.
ⓂThree Required.

ⓂTwo Required.

Belts and Coolant Hose for Transit Buses

Application	Mfr. Part No.	Our No.	Application	Mfr. Part No.	Our No.
Eagle			El Dorado		
1990 - 1989			2009		
Detroit Diesel 6V-92 Diesel			Cummins ISL Diesel		
Eagle 12			Axess; EZ-Rider II; Transmark RE; XHF		
Belt - Alt.		③3VX450	Belt - Serpentine - A.C.; W/Aftermarket		
Detroit Diesel 8V-71 Diesel			A.C.	1298K6	K061298
Eagle 12			2006		
Belt - Alt.		③3VX450	International/Navistar DT466 Diesel		
1988 - 1980			Aero Elite		
Detroit Diesel 6V-92 Diesel			Belt - Fan, Alt. & A.C.	1842457C1	♣K080825HD
Eagle 10			2005		
Belt - Alt.		③3VX450	Cummins ISB Diesel		
Detroit Diesel 8V-71 Diesel			EZ-Rider II		
Eagle 10			Belt - Eng. To J.S.		2/B90
Belt - Alt.		③3VX450	Tensioner Assy. - Alt. & W.P.	3936213	38516
1979 - 1974			Tensioner Pulley - Alt. & W.P.		
Detroit Diesel 6V-92 Diesel				3936213	36093
Eagle 05; Eagle 07			2003		
Belt - Alt.		③3VX450	Cummins ISC Diesel		
Detroit Diesel 8V-71 Diesel			EZ-Rider		
Eagle 05; Eagle 07			Belt - Eng. To J.S.		6599
Belt - Alt.		③3VX450	Belt - A.C.		②B90
1972			1997		
Detroit Diesel 6V-92 Diesel			Cummins ISC Diesel		
Silver Eagle			EZ-Rider		
Belt - Gen.		②TR24438	Belt - Eng. To Alt.		♣K080653HD
Detroit Diesel 8V-71 Diesel			Belt - A.C.		2/B85
Silver Eagle			Belt - A.C. To Alt.		②♣9463HD
Belt - Gen.		②TR24438	Tensioner Assy. - Eng. To Alt.	3937555	38525
1971 - 1968			1990 - 1984		
Detroit Diesel 6V-92 Diesel			Ford V-8 7.5 L		
Golden Eagle; Silver Eagle			MST2600		
Belt - Gen.		②TR24438	Belt - Fan & P.S.	RW23830	7500
Detroit Diesel 8V-71 Diesel			Belt - Fan & A.C.		♣9600HD
Golden Eagle; Silver Eagle			Belt - Alt.		7395
Belt - Gen.		②TR24438	Belt - A.P.		7340
1967			Flxible		
Detroit Diesel 6V-92 Diesel			1996 - 1995		
Eagle 01			Cummins L10 Diesel		
Belt - Alt.		③3VX450	Metro		
Golden Eagle; Silver Eagle			Belt - Alt.; W/OEM Alt. Mount		♣K120606HD
Belt - Gen.		②TR24438	Belt - Alt.; W/O OEM Alt. Mount		♣K120610HD
Detroit Diesel 8V-71 Diesel			Metro 106		
Eagle 01			Belt - Alt.	97607900002	K040360
Belt - Alt.		③3VX450	Belt - Compr.	97607900001	♣K120525HD
Golden Eagle; Silver Eagle			Cummins M11 Diesel		
Belt - Gen.		②TR24438	Metro		
1966 - 1963			Belt - Alt.; W/OEM Alt. Mount		
Detroit Diesel 6V-92 Diesel			Belt - Alt.; W/O OEM Alt. Mount		♣K120606HD
Golden Eagle					♣K120610HD
Belt - Gen.		②TR24438	Metro 106		
Detroit Diesel 8V-71 Diesel			Belt - Alt.	97607900002	K040360
Golden Eagle			Belt - Compr.	97607900001	♣K120525HD
Belt - Gen.		②TR24438			

③Three Required.
♣Standard Belt Available.

②Two Required.

Belts and Coolant Hose for Transit Buses

Application	Mfr. Part No.	Our No.	Application	Mfr. Part No.	Our No.
Flexible - Continued			Flexible - Continued		
1994 - Continued			1991 - Continued		
Cummins M11 Diesel			Detroit Diesel 8V-71 Diesel		
Metro			53101		
Belt - Alt.; W/OEM Alt. Mount		♣K120606HD	Belt - Alt.; W/Charging System		ⓉTR22664
Belt - Alt.; W/O OEM Alt. Mount		♣K120610HD	Belt - Alt.; W/A.C.; W/39 1/2" Belt O.C.	9120626	♣K060390HD
Detroit Diesel 6V-71 Diesel			Belt - Alt.; W/A.C.; W/40 1/2" Belt O.C.	9120625	♣K060400HD
53101			1990		
Belt - Alt.; W/Charging System		ⓉTR22664	Cummins L10 Diesel		
Belt - Alt.; W/A.C.; W/39 1/2" Belt O.C.	9120626	♣K060390HD	40096-6C		
Belt - Alt.; W/A.C.; W/40 1/2" Belt O.C.	9120625	♣K060400HD	Belt - Alt.	3097268	♣K100575HD
Detroit Diesel 8V-71 Diesel			Metro		
53101			Belt - Alt.	97607900015	♣K100607HD
Belt - Alt.; W/Charging System		ⓉTR22664	Belt - A.C.	97609500010	2/5VX800
Belt - Alt.; W/A.C.; W/39 1/2" Belt O.C.	9120626	♣K060390HD	Tensioner Assy. - Alt.	23512829	38505
Belt - Alt.; W/A.C.; W/40 1/2" Belt O.C.	9120625	♣K060400HD	Tensioner Pulley - Alt.	23512829	36091
Detroit Diesel Series 50 Diesel			Detroit Diesel Series 60 Diesel		
40102-4D			Metro		
Belt - A.C.		6601	Belt - A.C.		2/5VX710
Metro			1989 - 1988		
Belt - Hub & Alt.	23521338	♣K100381HD	Cummins L10 Diesel		
Tensioner Assy. - Hub & Alt.	23512829	38505	Metro		
Tensioner Pulley - Hub & Alt.	23512829	36091	Belt - Alt.	97607900015	♣K100607HD
1993 - 1992			Belt - A.C.	97609500010	2/5VX800
Cummins L10 Diesel			Tensioner Assy. - Alt.	23512829	38505
Metro			Tensioner Pulley - Alt.	23512829	36091
Belt - Alt.; W/OEM Alt. Mount		♣K120606HD	Metro Flex		
Belt - Alt.; W/O OEM Alt. Mount		♣K120610HD	Belt - Serpentine	3097270	♣K100554HD
Metro 106			1987		
Belt - Alt.	97607900002	K040360	Cummins L10 Diesel		
Belt - Compr.	97607900001	♣K120525HD	Metro Flex		
Cummins M11 Diesel			Belt - Serpentine		
Metro				3097270	♣K100554HD
Belt - Alt.; W/OEM Alt. Mount		♣K120606HD	1978 - 1974		
Belt - Alt.; W/O OEM Alt. Mount		♣K120610HD	Detroit Diesel 6V-71 Diesel		
Detroit Diesel 6V-71 Diesel			3135096		
53101			Belt - Alt.; W/Charging System		ⓉTR22664
Belt - Alt.; W/Charging System		ⓉTR22664	Belt - Alt.; W/A.C.; W/39 1/2" Belt O.C.	9120626	♣K060390HD
Belt - Alt.; W/A.C.; W/39 1/2" Belt O.C.	9120626	♣K060390HD	Belt - Alt.; W/A.C.; W/40 1/2" Belt O.C.	9120625	♣K060400HD
Belt - Alt.; W/A.C.; W/40 1/2" Belt O.C.	9120625	♣K060400HD	Detroit Diesel 8V-71 Diesel		
Detroit Diesel 8V-71 Diesel			3135096		
53101			Belt - Alt.; W/Charging System		ⓉTR22664
Belt - Alt.; W/Charging System		ⓉTR22664	Belt - Alt.; W/A.C.; W/39 1/2" Belt O.C.	9120626	♣K060390HD
Belt - Alt.; W/A.C.; W/39 1/2" Belt O.C.	9120626	♣K060390HD	Belt - Alt.; W/A.C.; W/40 1/2" Belt O.C.	9120625	♣K060400HD
Belt - Alt.; W/A.C.; W/40 1/2" Belt O.C.	9120625	♣K060400HD	1973 - 1969		
1991			Detroit Diesel 6V-71 Diesel		
Cummins L10 Diesel			111CC0061		
Metro			Belt - Alt.; W/Charging System		ⓉTR22664
Belt - Alt.; W/OEM Alt. Mount		♣K120606HD	Belt - Alt.; W/A.C.; W/39 1/2" Belt O.C.	9120626	♣K060390HD
Belt - Alt.; W/O OEM Alt. Mount		♣K120610HD	Belt - Alt.; W/A.C.; W/40 1/2" Belt O.C.	9120625	♣K060400HD
Cummins M11 Diesel			Detroit Diesel 8V-71 Diesel		
Metro			111CC0061		
Belt - Alt.; W/OEM Alt. Mount		♣K120606HD	Belt - Alt.; W/Charging System		ⓉTR22664
Belt - Alt.; W/O OEM Alt. Mount		♣K120610HD	Belt - Alt.; W/A.C.; W/39 1/2" Belt O.C.	9120626	♣K060390HD
Detroit Diesel 6V-71 Diesel			Belt - Alt.; W/A.C.; W/40 1/2" Belt O.C.	9120625	♣K060400HD
53101			1968 - 1966		
Belt - Alt.; W/Charging System		ⓉTR22664	Detroit Diesel 6V-71 Diesel		
Belt - Alt.; W/A.C.; W/39 1/2" Belt O.C.	9120626	♣K060390HD	111CC0061		
Belt - Alt.; W/A.C.; W/40 1/2" Belt O.C.	9120625	♣K060400HD	Belt - Alt.; W/Charging System		ⓉTR22664
1994 - Continued			Belt - Alt.; W/A.C.; W/39 1/2" Belt O.C.	9120626	♣K060390HD
1991 - Continued			Belt - Alt.; W/A.C.; W/40 1/2" Belt O.C.	9120625	♣K060400HD

♣Standard Belt Available.

ⓉThree Required.

Transit Buses

Belts and Coolant Hose for Transit Buses

Application	Mfr. Part No.	Our No.	Application	Mfr. Part No.	Our No.
Flxible - Continued			Flxible - Continued		
1968 - 1966 - Continued			1946 - 1943 - Continued		
Detroit Diesel 6V-71 Diesel - Continued			Chrysler V-8 413 - Continued		
111CC0061 - Continued			TC31 Twin Coach - Continued		
Belt - Alt.; W/A.C.; W/40 1/2" Belt O.C.	9120625	▲K060400HD	Belt - Alt.; W/24V. System	A19348	②7430
F2D6V			Belt - Air Brake Compr.		▲9740HD
Belt - Fan	104021	②TR22711	Belt - A.C.; W/6 1/4" Dia. Pulley		▲9451HD
Belt - Alt.; W/4 1/8", 4 3/8" Dia. Alt. Pulleys .	910133	③TR22648	Belt - A.C.; W/10 1/4" Dia. Pulley	A19347	▲9500HD
Belt - Alt.; W/5 1/2" Dia. Alt. Pulley	99061	③TR22664	Chrysler V-8 440		
Belt - Air Brake Compr.	99841	②TR22770	PC31 Twin Coach		
Detroit Diesel 8V-71 Diesel			Belt - W.P. & Alt.; W/12V. System		
111CC0061				962653	②7580
Belt - Alt.; W/Charging System		③TR22664	Belt - Alt.; W/24V. System	68597	7560
Belt - Alt.; W/A.C.; W/39 1/2" Belt O.C.	9120626	▲K060390HD	Belt - Air Brake Compr.		9765
Belt - Alt.; W/A.C.; W/40 1/2" Belt O.C.	9120625	▲K060400HD	Belt - A.C.	962651	▲9720HD
F2D6V			1942		
Belt - Fan	104021	②TR22711	Chrysler V-8 413		
Belt - Alt.; W/4 1/8", 4 3/8" Dia. Alt. Pulleys .	910133	③TR22648	TC25 Twin Coach		
Belt - Alt.; W/5 1/2" Dia. Alt. Pulley	99061	③TR22664	Belt - Fan	10114	▲9540HD
Belt - Air Brake Compr.	99841	②TR22770	Belt - W.P. & Alt.; W/12V. System		②▲◆9660HD
1965 - 1961			Belt - Alt.; W/24V. System	A19348	②7430
Detroit Diesel 6V-71 Diesel			Belt - Air Brake Compr.		▲9740HD
F2D6V			Belt - A.C.; W/6 1/4" Dia. Pulley		▲9451HD
Belt - Fan	104021	②TR22711	Belt - A.C.; W/10 1/4" Dia. Pulley	A19347	▲9500HD
Belt - Alt.; W/4 1/8", 4 3/8" Dia. Alt. Pulleys .	910133	③TR22648	Hose - Upper		≈20611
Belt - Alt.; W/5 1/2" Dia. Alt. Pulley	99061	③TR22664	Hose - Lower - Eng. To Pipe		24232
Belt - Air Brake Compr.	99841	②TR22770	Hose - Lower - Pipe To Rad.		24232
Detroit Diesel 8V-71 Diesel			Gillig		
F2D6V			2010		
Belt - Fan	104021	②TR22711	Cummins ISL Diesel		
Belt - Alt.; W/4 1/8", 4 3/8" Dia. Alt. Pulleys .	910133	③TR22648	Low Floor		
Belt - Alt.; W/5 1/2" Dia. Alt. Pulley	99061	③TR22664	Belt - A.C.	530222076	2/5V1020
Belt - Air Brake Compr.	99841	②TR22770	Tensioner Assy. - A.C.		38655
1948 - 1947			2009 - 2006		
Chrysler V-8 413			Cummins ISL Diesel		
TC31 Twin Coach			Low Floor		
Belt - Fan	10114	▲9540HD	Belt - A.C.	530222076	2/5V1020
Belt - W.P. & Alt.; W/12V. System		②▲◆9660HD	Tensioner Assy. - A.C.		38655
Belt - Alt.; W/24V. System	A19348	②7430	Cummins ISM Diesel		
Belt - Air Brake Compr.		▲9740HD	Low Floor		
Belt - A.C.; W/6 1/4" Dia. Pulley		▲9451HD	Belt - A.C.	530222076	2/5V1020
Belt - A.C.; W/10 1/4" Dia. Pulley	A19347	▲9500HD	Tensioner Assy. - A.C.		38655
Chrysler V-8 440			2005		
PC31 Twin Coach			Cummins ISB Diesel		
Belt - W.P. & Alt.; W/12V. System	962653	②7580	Phantom		
Belt - Alt.; W/24V. System	68597	7560	Belt - Alt.	3288598	▲K080471HD
Belt - Air Brake Compr.		9765	Cummins ISL Diesel		
Belt - A.C.	962651	▲9720HD	Low Floor		
1946 - 1943			Belt - A.C.	530222076	2/5V1020
Chrysler V-8 413			Tensioner Assy. - A.C.		38655
TC25 Twin Coach			Cummins ISM Diesel		
Belt - Fan	10114	▲9540HD	Low Floor		
Belt - W.P. & Alt.; W/12V. System		②▲◆9660HD	Belt - A.C.	530222076	2/5V1020
Belt - Alt.; W/24V. System	A19348	②7430	Tensioner Assy. - A.C.		38655
Belt - Air Brake Compr.		▲9740HD	Detroit Diesel Series 50 Diesel		
Belt - A.C.; W/6 1/4" Dia. Pulley		▲9451HD	Low Floor		
Belt - A.C.; W/10 1/4" Dia. Pulley	A19347	▲9500HD	Belt - A.C.	530222076	2/5V1020
Hose - Upper		≈20611	Tensioner Assy. - A.C.		38655
Hose - Lower - Eng. To Pipe		24232	2005		
Hose - Lower - Pipe To Rad.		24232	Cummins ISB Diesel		
TC31 Twin Coach			Phantom		
Belt - Fan	10114	▲9540HD	Belt - Alt.	3288598	▲K080471HD
Belt - W.P. & Alt.; W/12V. System		②▲◆9660HD	Cummins ISL Diesel		

②Two Required.
 ▲Standard Belt Available.
 ≈Cut to Fit.

③Three Required.
 ◆PowerBand Belt May Work, Use Template to Check.

Transit Buses

Belts and Coolant Hose for Transit Buses

Application	Mfr. Part No.	Our No.	Application	Mfr. Part No.	Our No.
Gillig - Continued			Gillig - Continued		
2004 - 2003			2000 - Continued		
Cummins ISL Diesel			Detroit Diesel Series 40 Diesel		
Low Floor			Low Floor		
Belt - A.C.	530222076	2/5V1020	Belt - A.C.	530222076	2/5V1020
Tensioner Assy. - A.C.		38655	Tensioner Assy. - A.C.		38655
Detroit Diesel Series 40 Diesel			Tensioner Assy.		
Low Floor			23521638		
Belt - A.C.	530222076	2/5V1020	Tensioner Pulley	23521638	36091
Tensioner Assy. - A.C.		38655	1999		
Detroit Diesel Series 50 Diesel			Cummins ISC Diesel		
Low Floor			Low Floor		
Belt - A.C.	530222076	2/5V1020	Tensioner Assy.		
Tensioner Assy. - A.C.		38655	3936212		
2002			38552		
Cummins ISC Diesel			Detroit Diesel 6V-92 Diesel		
Low Floor			Phantom 96TB		
Tensioner Assy.	3936212	38552	Belt - Fan & P.S.; W/Aftercooler		
Cummins ISL Diesel			BX55		
Low Floor			Belt - Alt.; W/O Aftercooler		
Belt - A.C.	530222076	2/5V1020	A79		
Tensioner Assy. - A.C.		38655	Hose - Upper - Eng. To Pipe		
2001			24236		
Cummins ISC Diesel			Hose - Lower - Eng. To Pipe		
Low Floor			24248		
Tensioner Assy.	3936212	38552	Hose - Lower - Pipe To Rad.		
Cummins ISL Diesel			≈<23575		
Low Floor			Detroit Diesel Series 40 Diesel		
Belt - A.C.	530222076	2/5V1020	Low Floor		
Tensioner Assy. - A.C.		38655	Belt - A.C.		
2000			530222076		
Cummins ISC Diesel			2/5V1020		
Low Floor			Tensioner Assy. - A.C.		
Tensioner Assy.	3936212	38552	23521638		
Detroit Diesel 6V-92 Diesel			38551		
Phantom 96TB			Tensioner Pulley		
Belt - Fan & P.S.; W/Aftercooler			23521638		
BX55			Detroit Diesel Series 50 Diesel		
Belt - Alt.; W/O Aftercooler			Low Floor; Phantom		
A79			Belt - A.C.		
Hose - Upper - Eng. To Pipe			530222076		
24236			2/5V1020		
Hose - Lower - Eng. To Pipe			Belt - Alt.; W/450A. Alt.		
24248			23521000		
Hose - Lower - Pipe To Rad.			Tensioner Assy. - A.C.		
≈<23575			38655		
Phantom 102TB			Phantom 96TB		
Belt - Eng. To J.S.			Belt - A.C.		
ⓂB73			530222076		
2/5V975			2/5VX950		
Detroit Diesel Series 40 Diesel			2/5VX950		
Low Floor			Hose - Upper		
Belt - A.C.	530222076	2/5V1020	≈<24636		
Tensioner Assy. - A.C.		38655	Hose - Lower		
Tensioner Assy.	23521638	38551	≈<24636		
Tensioner Pulley	23521638	36091	Detroit Diesel 6V-92 Diesel		
2000			Phantom 96TB		
Cummins ISC Diesel			Belt - Fan & P.S.; W/Aftercooler		
Low Floor			BX55		
Tensioner Assy.	3936212	38552	Belt - Alt.; W/O Aftercooler		
Detroit Diesel 6V-92 Diesel			A79		
Phantom 96TB			Hose - Upper - Eng. To Pipe		
Belt - Fan & P.S.; W/Aftercooler			24236		
BX55			Hose - Lower - Eng. To Pipe		
Belt - Alt.; W/O Aftercooler			24248		
A79			Hose - Lower - Pipe To Rad.		
Hose - Upper - Eng. To Pipe			≈<23575		
24236			1998		
Hose - Lower - Eng. To Pipe			Cummins L10 Diesel		
24248			Phantom		
Hose - Lower - Pipe To Rad.			Belt - A.C.		
≈<23575			2/5VX950		
2000			Hose - Upper		
Cummins ISC Diesel			≈<24636		
Low Floor			Hose - Lower		
Tensioner Assy.	3936212	38552	≈<24636		
Detroit Diesel 6V-92 Diesel			Detroit Diesel 6V-92 Diesel		
Phantom 96TB			Phantom 96TB		
Belt - Fan & P.S.; W/Aftercooler			Belt - Fan & P.S.; W/Aftercooler		
BX55			BX55		
Belt - Alt.; W/O Aftercooler			Belt - Alt.; W/O Aftercooler		
A79			A79		
Hose - Upper - Eng. To Pipe			Hose - Upper - Eng. To Pipe		
24236			24236		
Hose - Lower - Eng. To Pipe			Hose - Lower - Eng. To Pipe		
24248			24248		
Hose - Lower - Pipe To Rad.			Hose - Lower - Pipe To Rad.		
≈<23575			≈<23575		

≈<Cut to Fit.
 ♣Standard Belt Available.

ⓂTwo Required.

Belts and Coolant Hose for Transit Buses

Application	Mfr. Part No.	Our No.	Application	Mfr. Part No.	Our No.
Gillig - Continued			Gillig - Continued		
1997			1995		
Cummins L10 Diesel			Cummins M11 Diesel		
Phantom			Phantom		
Belt - A.C.		2/5VX950	Belt - A.C.		2/5V950
Hose - Upper	≧24636		Tensioner Assy.	3102889	38537
Hose - Lower	≧24636		Cummins N14 Diesel		
Cummins M11 Diesel			Phantom		
Phantom			Belt - A.C.		2/5V950
Belt - A.C.		2/5V950	Detroit Diesel 6V-92 Diesel		
Tensioner Assy.	3102889	38537	Phantom 96TB		
Cummins N14 Diesel			Belt - Fan & P.S.; W/Aftercooler		
Phantom					BX55
Belt - A.C.		2/5V950	Belt - Alt.; W/O Aftercooler		A79
Detroit Diesel 6V-92 Diesel			Hose - Upper - Eng. To Pipe		
Phantom 96TB			Hose - Lower - Eng. To Pipe		
Belt - Fan & P.S.; W/Aftercooler		BX55	Hose - Lower - Pipe To Rad.		
Belt - Alt.; W/O Aftercooler		A79	≧23575		
Hose - Upper - Eng. To Pipe		24236	Detroit Diesel Series 50 Diesel		
Hose - Lower - Eng. To Pipe		24248	Phantom 96TB		
Hose - Lower - Pipe To Rad.		≧23575	Belt - Hub & A.C.		
Detroit Diesel Series 50 Diesel			Belt - Hub & Alt.		
Phantom 96TB			Belt - Hyd. Pump		
Belt - Hub & A.C.		2/5VX950	Tensioner Assy. - Hub & A.C.		
Belt - Hub & Alt.		♣K120720HD	Tensioner Assy. - Hub & Alt.		
Belt - Hyd. Pump		2/5VX600	Tensioner Pulley - Hub & A.C.		
Tensioner Assy. - Hub & A.C.	23512829	38505			
Tensioner Assy. - Hub & Alt.	23526034	38520			
Tensioner Pulley - Hub & A.C.	23512829	36091			
1996			1994		
Cummins L10 Diesel			Cummins M11 Diesel		
Phantom			Phantom		
Belt - A.C.		2/5VX950	Belt - A.C.		
Hose - Upper	≧24636				
Hose - Lower	≧24636		Cummins N14 Diesel		
Cummins M11 Diesel			Phantom		
Phantom			Belt - A.C.		
Belt - A.C.		2/5V950			
Tensioner Assy.	3102889	38537	Detroit Diesel 6V-92 Diesel		
Cummins N14 Diesel			Phantom 96TB		
Phantom			Belt - Fan & P.S.; W/Aftercooler		
Belt - A.C.		2/5V950	Belt - Alt.; W/O Aftercooler		
Detroit Diesel 6V-92 Diesel			Hose - Upper - Eng. To Pipe		
Phantom 96TB			Hose - Lower - Eng. To Pipe		
Belt - Fan & P.S.; W/Aftercooler		BX55	Hose - Lower - Pipe To Rad.		
Belt - Alt.; W/O Aftercooler		A79	≧23575		
Hose - Upper - Eng. To Pipe		24236	Detroit Diesel Series 50 Diesel		
Hose - Lower - Eng. To Pipe		24248	Phantom 96TB		
Hose - Lower - Pipe To Rad.		≧23575	Belt - Hub & A.C.		
Detroit Diesel Series 50 Diesel			Belt - Hub & Alt.		
Phantom			Belt - Hyd. Pump		
Belt - A.C.		2/B99	Tensioner Assy. - Hub & A.C.		
Phantom 96TB			Tensioner Assy. - Hub & Alt.		
Belt - Hub & A.C.		2/5VX950	Tensioner Pulley - Hub & A.C.		
Belt - Hub & Alt.		♣K120720HD			
Belt - Hyd. Pump		2/5VX600			
Tensioner Assy. - Hub & A.C.	23512829	38505			
Tensioner Assy. - Hub & Alt.	23526034	38520			
Tensioner Pulley - Hub & A.C.	23512829	36091			
1993			1993		
Cummins L10 Diesel			Cummins L10 Diesel		
Phantom			Phantom		
Belt - Alt.; W/O OEM Alt. Mount		♣K120594HD	Belt - Alt.; W/O OEM Alt. Mount		
Belt - Alt.; W/OEM Alt. Mount		♣K120559HD			
Cummins M11 Diesel			Cummins M11 Diesel		
Phantom			Phantom		
Belt - A.C.		2/5V950	Belt - A.C.		
Cummins N14 Diesel			Cummins N14 Diesel		
Phantom			Phantom		
Belt - A.C.		2/5V950	Belt - A.C.		
Detroit Diesel 6V-92 Diesel			Detroit Diesel 6V-92 Diesel		
Phantom 96TB			Phantom 96TB		
Belt - Fan & P.S.; W/Aftercooler		BX55	Belt - Fan & P.S.; W/Aftercooler		

≧Cut to Fit.

♣Standard Belt Available.

Transit Buses

Belts and Coolant Hose for Transit Buses

Transit Buses

Application	Mfr. Part No.	Our No.	Application	Mfr. Part No.	Our No.
Gillig - Continued			Gillig - Continued		
1993 - Continued			1988 - 1985 - Continued		
Detroit Diesel 6V-92 Diesel - Continued			Detroit Diesel 6V-92 Diesel - Continued		
Phantom 96TB - Continued			Phantom 96TB - Continued		
Belt - Alt.; W/O Aftercooler		A79	Hose - Upper - Eng. To Pipe		24236
Hose - Upper - Eng. To Pipe		24236	Hose - Lower - Eng. To Pipe		24248
Hose - Lower - Eng. To Pipe		24248	Hose - Lower - Pipe To Rad.		≈23575
Hose - Lower - Pipe To Rad.		≈23575	Phantom 102TB		
1992			Belt - A.C.		⊗B94
Cummins L10 Diesel			Belt - Hyd. Pump		⊗B74
Phantom			1984 - 1980		
Belt - Alt.; W/O OEM Alt. Mount		♣K120594HD	Detroit Diesel 6V-92 Diesel		
Belt - Alt.; W/OEM Alt. Mount		♣K120559HD	Phantom 96TB		
Detroit Diesel 6V-92 Diesel			Belt - Fan & P.S.; W/Aftercooler		
Phantom 96TB			Belt - Alt.; W/O Aftercooler		
Belt - Fan & P.S.; W/Aftercooler		BX55	Hose - Upper - Eng. To Pipe		
Belt - Alt.; W/O Aftercooler		A79	Hose - Lower - Eng. To Pipe		
Hose - Upper - Eng. To Pipe		24236	Hose - Lower - Pipe To Rad.		
Hose - Lower - Eng. To Pipe		24248			
Hose - Lower - Pipe To Rad.		≈23575	GMC		
1991			1988		
Cummins L10 Diesel			Detroit Diesel 6V-92 Diesel		
Phantom			T70204; T70604; T80204; T80604		
Belt - Alt.; W/O OEM Alt. Mount		♣K120594HD	Belt - Fan	2099698	♣K120400HD
Belt - Alt.; W/OEM Alt. Mount		♣K120559HD	Belt - A.C.	2016617	6572
Detroit Diesel 6V-92 Diesel			Detroit Diesel 8V-71 Diesel		
Phantom 96TB			T70204; T70604; T80204; T80604		
Belt - Fan & P.S.; W/Aftercooler		BX55	Belt - Fan	2099698	♣K120400HD
Belt - Alt.; W/O Aftercooler		A79	Belt - A.C.	2016617	6572
Hose - Upper - Eng. To Pipe		24236	1987 - 1985		
Hose - Lower - Eng. To Pipe		24248	Detroit Diesel 6V-71 Diesel		
Hose - Lower - Pipe To Rad.		≈23575	T70204; T70604; T80604		
Detroit Diesel Series 60 Diesel			Belt - Fan	2099698	♣K120400HD
Phantom			Belt - A.C.	2016617	6572
Belt - A.C.		2/5V975	Detroit Diesel 6V-92 Diesel		
1990			T70204; T70604; T80204; T80604		
Cummins L10 Diesel			Belt - Fan	2099698	♣K120400HD
Phantom			Belt - A.C.	2016617	6572
Belt - Alt.; W/O OEM Alt. Mount		♣K120594HD	Detroit Diesel 8V-71 Diesel		
Belt - Alt.; W/OEM Alt. Mount		♣K120559HD	T70204; T70604; T80204; T80604		
Detroit Diesel 6V-92 Diesel			Belt - Fan	2099698	♣K120400HD
Phantom 96TB			Belt - A.C.	2016617	6572
Belt - Fan & P.S.; W/Aftercooler		BX55	1984		
Belt - Alt.; W/O Aftercooler		A79	Detroit Diesel 6V-71 Diesel		
Hose - Upper - Eng. To Pipe		24236	T70204; T70604; T80604		
Hose - Lower - Eng. To Pipe		24248	Belt - Fan	2057625	♣K120390HD
Hose - Lower - Pipe To Rad.		≈23575	Belt - A.C.	2016617	6572
1989			Detroit Diesel 6V-92 Diesel		
Detroit Diesel 6V-92 Diesel			T70204; T70604; T80204; T80604		
Phantom 96TB			Belt - Fan	2057625	♣K120390HD
Belt - Fan & P.S.; W/Aftercooler		BX55	Belt - A.C.	2016617	6572
Belt - Alt.; W/O Aftercooler		A79	Detroit Diesel 8V-71 Diesel		
Hose - Upper - Eng. To Pipe		24236	T70204; T70604; T80204; T80604		
Hose - Lower - Eng. To Pipe		24248	Belt - Fan	2057625	♣K120390HD
Hose - Lower - Pipe To Rad.		≈23575	Belt - A.C.	2016617	6572
1988 - 1985			1983 - 1981		
Detroit Diesel 6V-92 Diesel			Detroit Diesel 6V-71 Diesel		
Phantom 96TB			T70204; T70604; T80604		
Belt - Fan & P.S.; W/Aftercooler		BX55	Belt - Fan	2057625	♣K120390HD
Belt - Alt.; W/O Aftercooler		A79			

≈Cut to Fit.
⊗Two Required.

♣Standard Belt Available.

Belts and Coolant Hose for Transit Buses

Application	Mfr. Part No.	Our No.	Application	Mfr. Part No.	Our No.
GMC - Continued			GMC - Continued		
1983 - 1981 - Continued			1971 - 1970		
Detroit Diesel 6V-71 Diesel - Continued			GMC DH478 Diesel		
T70204; T70604; T80604 - Continued			TDH3301; TDH3301A		
Belt - A.C.	2016617	6572	Belt - Fan	2465849	TR22792
Detroit Diesel 6V-92 Diesel			Belt - W.P. & Alt.	2466318	③▲9630HD
T70204; T70604; T80204; T80604			Belt - Alt.; W/A.C.	668850	▲9425HD
Belt - Fan	2057625	▲K120390HD	Belt - Air Brake Compr.	8867793	▲9640HD
Belt - A.C.	2016617	6572	Belt - A.C.	668300	▲9630HD
1980 - 1979			1969		
Detroit Diesel 6V-71 Diesel			Detroit Diesel 8V-71 Diesel		
T7H603; T7W203; T7W603; T8W203; T8W603			PD4106		
Hose - Upper - Eng. To Pipe		24244	Belt - Alt.	2434116	▲9370HD
Hose - Upper - Pipe To Rad.		24244	PD4107		
Hose - Lower - Eng. To Pipe		24244	Belt - Alt.; W/A.C.	610987	②▲◆9430HD
Hose - Lower - Pipe To Rad.		24244	TD4106		
Detroit Diesel 8V-71 Diesel			Belt - Alt.	2434116	▲9370HD
T7H203; T8H203; T8H603			TD4107		
Hose - Upper - Eng. To Pipe		24244	Belt - Alt.; W/A.C.	610987	②▲◆9430HD
Hose - Upper - Pipe To Rad.		24244	GM V-6 305		
Hose - Lower - Eng. To Pipe		24244	TGH3301		
Hose - Lower - Pipe To Rad.		24244	Belt - Fan	2465849	TR22792
1978			Belt - W.P. & Gen.	2463090	②▲9660HD
Detroit Diesel 6V-71 Diesel			Belt - Compr.		▲9640HD
TW7601			TGH3501; TGH3502		
Hose - Upper - Eng. To Pipe		24244	Belt - Fan	2465849	TR22792
Hose - Upper - Pipe To Rad.		24244	Belt - W.P. & Gen.	2463090	②▲9660HD
Hose - Lower - Eng. To Pipe		24244	Belt - Compr.	8867793	▲9640HD
Hose - Lower - Pipe To Rad.		24244	GM V-6 351		
Detroit Diesel 8V-71 Diesel			TGH3301		
TH8201; TH8601			Belt - Fan	2465849	TR22792
Hose - Upper - Eng. To Pipe		24244	Belt - W.P. & Gen.	2463090	②▲9660HD
Hose - Upper - Pipe To Rad.		24244	Belt - Compr.		▲9640HD
Hose - Lower - Eng. To Pipe		24244	TGH3501; TGH3502		
Hose - Lower - Pipe To Rad.		24244	Belt - Fan	2465849	TR22792
1977			Belt - W.P. & Gen.	2463090	②▲9660HD
Detroit Diesel 6V-71 Diesel			Belt - Compr.	8867793	▲9640HD
TW7601			GM V-6 379		
Hose - Upper - Eng. To Pipe		24244	TGH3301		
Hose - Upper - Pipe To Rad.		24244	Belt - Fan	2465849	TR22792
Hose - Lower - Eng. To Pipe		24244	Belt - W.P. & Gen.	2463090	②▲9660HD
Hose - Lower - Pipe To Rad.		24244	Belt - Compr.		▲9640HD
1976			TGH3501; TGH3502		
Detroit Diesel 6V-71 Diesel			Belt - Fan	2465849	TR22792
T6H4523A; T6H5307A; T6H5308A			Belt - W.P. & Gen.	2463090	②▲9660HD
Belt - Alt.; W/A.C.; W/Pulley No. 664713	610986	②▲9420HD	Belt - Compr.	8867793	▲9640HD
Belt - Alt.; W/A.C.; W/Pulley No. 669856	794452	K070390	GMC D478 Diesel		
Belt - Alt.; W/A.C.; W/Pulley No. 669866	669722	K070370	TDH3301; TDH3301A		
Detroit Diesel 8V-71 Diesel			Belt - Fan	2465849	TR22792
S8H5304A; S8M5304A; T8H5307A; T8H5308A			Belt - W.P. & Alt.	2466318	③▲9630HD
Belt - Alt.; W/A.C.	669722	K070370	Belt - Alt.; W/A.C.	668850	▲9425HD
1972			Belt - Air Brake Compr.	8867793	▲9640HD
GMC DH478 Diesel			Belt - A.C.	668300	▲9630HD
TDH3302A; TDH3302N			GMC DH478 Diesel		
Belt - Fan	2465849	TR22792	TDH3301; TDH3301A		
Belt - W.P. & Alt.	2466318	③▲9630HD	Belt - Fan	2465849	TR22792
Belt - Alt.; W/A.C.	668850	▲9425HD	Belt - W.P. & Alt.	2466318	③▲9630HD
Belt - Air Brake Compr.	8867793	▲9640HD	Belt - Alt.; W/A.C.	668850	▲9425HD
Belt - A.C.	668300	▲9630HD	Belt - Air Brake Compr.	8867793	▲9640HD
			Belt - A.C.	668300	▲9630HD

▲Standard Belt Available.
③Three Required.

②Two Required.
◆PowerBand Belt May Work, Use Template to Check.

Transit Buses

Belts and Coolant Hose for Transit Buses

Application	Mfr. Part No.	Our No.	Application	Mfr. Part No.	Our No.
GMC - Continued			GMC - Continued		
1968			1967		
Detroit Diesel 8V-71 Diesel			Detroit Diesel 8V-71 Diesel		
PD4106			PD4106		
Belt - Alt.	2434116	♣9370HD	Belt - Alt.	2434116	♣9370HD
PD4107			PD4107		
Belt - Alt.; W/A.C.	610987	②♣♣9430HD	Belt - Alt.; W/A.C.	610987	②♣♣9430HD
TD4106			TD4106		
Belt - Alt.	2434116	♣9370HD	Belt - Alt.	2434116	♣9370HD
TD4107			TD4107		
Belt - Alt.; W/A.C.	610987	②♣♣9430HD	Belt - Alt.; W/A.C.	610987	②♣♣9430HD
GM V-6 305			GM V-6 305		
TGH3301			TGH3301		
Belt - Fan	2465849	TR22792	Belt - Fan	2465849	TR22792
Belt - W.P. & Gen.	2463090	②♣9660HD	Belt - W.P. & Gen.	2463090	②♣9660HD
Belt - Compr.		♣9640HD	Belt - Compr.		♣9640HD
TGH3501; TGH3502			TGH3501; TGH3502		
Belt - Fan	2465849	TR22792	Belt - Fan	2465849	TR22792
Belt - W.P. & Gen.	2463090	②♣9660HD	Belt - W.P. & Gen.	2463090	②♣9660HD
Belt - Compr.	8867793	♣9640HD	Belt - Compr.	8867793	♣9640HD
GM V-6 351			GM V-6 351		
TGH3301			TGH3301		
Belt - Fan	2465849	TR22792	Belt - Fan	2465849	TR22792
Belt - W.P. & Gen.	2463090	②♣9660HD	Belt - W.P. & Gen.	2463090	②♣9660HD
Belt - Compr.		♣9640HD	Belt - Compr.		♣9640HD
TGH3501; TGH3502			TGH3501; TGH3502		
Belt - Fan	2465849	TR22792	Belt - Fan	2465849	TR22792
Belt - W.P. & Gen.	2463090	②♣9660HD	Belt - W.P. & Gen.	2463090	②♣9660HD
Belt - Compr.	8867793	♣9640HD	Belt - Compr.	8867793	♣9640HD
GM V-6 379			GM V-6 379		
TGH3301			TGH3301		
Belt - Fan	2465849	TR22792	Belt - Fan	2465849	TR22792
Belt - W.P. & Gen.	2463090	②♣9660HD	Belt - W.P. & Gen.	2463090	②♣9660HD
Belt - Compr.		♣9640HD	Belt - Compr.		♣9640HD
TGH3501; TGH3502			TGH3501; TGH3502		
Belt - Fan	2465849	TR22792	Belt - Fan	2465849	TR22792
Belt - W.P. & Gen.	2463090	②♣9660HD	Belt - W.P. & Gen.	2463090	②♣9660HD
Belt - Compr.	8867793	♣9640HD	Belt - Compr.	8867793	♣9640HD
GMC D478 Diesel			GMC D478 Diesel		
TDH3501; TDH3502			TDH3501; TDH3502; TDH3502A		
Belt - Fan	2465849	TR22792	Belt - Fan	2465849	TR22792
Belt - W.P. & Alt.	2466318	③♣9630HD	Belt - W.P. & Alt.	2466318	③♣9630HD
Belt - Alt.; W/A.C.	668850	♣9425HD	Belt - Alt.; W/A.C.	668850	♣9425HD
Belt - Air Brake Compr.	2463090	②♣9660HD	Belt - Air Brake Compr.	2463090	②♣9660HD
Belt - A.C.	78283	5VX850	Belt - A.C.	78283	5VX850
TDH3502A			GMC DH478 Diesel		
Belt - Fan	2465849	TR22792	TDH3501; TDH3502; TDH3502A		
Belt - W.P. & Alt.	2466318	③♣9630HD	Belt - Fan	2465849	TR22792
Belt - Alt.; W/A.C.	668850	♣9425HD	Belt - W.P. & Alt.	2466318	③♣9630HD
Belt - Air Brake Compr.	2463090	②♣9660HD	Belt - Alt.; W/A.C.	668850	♣9425HD
Belt - A.C.	78283	5VX850	Belt - Air Brake Compr.	2463090	②♣9660HD
GMC DH478 Diesel			1966		
TDH3501; TDH3502			Detroit Diesel 8V-71 Diesel		
Belt - Fan	2465849	TR22792	PD4106		
Belt - W.P. & Alt.	2466318	③♣9630HD	Belt - Alt.	2434116	♣9370HD
Belt - Alt.; W/A.C.	668850	♣9425HD	PD4107		
Belt - Air Brake Compr.	2463090	②♣9660HD	Belt - Alt.; W/A.C.	610987	②♣♣9430HD
Belt - A.C.	78283	5VX850	TD4106		
TDH3502A			Belt - Alt.	2434116	♣9370HD
Belt - Fan	2465849	TR22792	TD4107		
Belt - W.P. & Alt.	2466318	③♣9630HD	Belt - Alt.; W/A.C.	610987	②♣♣9430HD
Belt - Alt.; W/A.C.	668850	♣9425HD	1966		
Belt - Air Brake Compr.	2463090	②♣9660HD	Detroit Diesel 8V-71 Diesel		
Belt - A.C.	78283	5VX850	PD4106		
GMC DH478 Diesel			Belt - Alt.	2434116	♣9370HD
TDH3501; TDH3502			PD4107		
Belt - Fan	2465849	TR22792	Belt - Alt.; W/A.C.	610987	②♣♣9430HD
Belt - W.P. & Alt.	2466318	③♣9630HD	TD4106		
Belt - Alt.; W/A.C.	668850	♣9425HD	Belt - Alt.	2434116	♣9370HD
Belt - Air Brake Compr.	2463090	②♣9660HD	TD4107		
Belt - A.C.	78283	5VX850	Belt - Alt.; W/A.C.	610987	②♣♣9430HD

♣Standard Belt Available.
②Two Required.

◆PowerBand Belt May Work, Use Template to Check.
③Three Required.

Belts and Coolant Hose for Transit Buses

Application	Mfr. Part No.	Our No.	Application	Mfr. Part No.	Our No.
GMC - Continued			GMC - Continued		
1966 - Continued			1965 - Continued		
GM V-6 305			GM V-6 351 - Continued		
TGH3301			TGH3501; TGH3502 - Continued		
Belt - Fan	2465849	TR22792	Belt - W.P. & Gen.	2463090	②♣9660HD
Belt - W.P. & Gen.	2463090	②♣9660HD	Belt - Compr.	8867793	♣9640HD
Belt - Compr.		♣9640HD			
TGH3501; TGH3502			GM V-6 379		
Belt - Fan	2465849	TR22792	TGH3301		
Belt - W.P. & Gen.	2463090	②♣9660HD	Belt - Fan	2465849	TR22792
Belt - Compr.	8867793	♣9660HD	Belt - W.P. & Gen.	2463090	②♣9660HD
			Belt - Compr.		♣9640HD
GM V-6 351			TGH3501		
TGH3301			Belt - Fan	2465849	TR22792
Belt - Fan	2465849	TR22792	Belt - W.P. & Gen.	2463090	②♣9630HD
Belt - W.P. & Gen.	2463090	②♣9660HD	Belt - Compr.	8867793	♣9640HD
Belt - Compr.		♣9640HD			
TGH3501; TGH3502			TGH3502		
Belt - Fan	2465849	TR22792	Belt - Fan	2465849	TR22792
Belt - W.P. & Gen.	2463090	②♣9660HD	Belt - W.P. & Gen.	2463090	②♣9660HD
Belt - Compr.	8867793	♣9660HD	Belt - Compr.	8867793	♣9640HD
GM V-6 379			GMC D478 Diesel		
TGH3301			TDH3501; TDH3502; TDH3502A		
Belt - Fan	2465849	TR22792	Belt - Fan	2465849	TR22792
Belt - W.P. & Gen.	2463090	②♣9660HD	Belt - W.P. & Alt.	2466318	③♣9630HD
Belt - Compr.		♣9640HD	Belt - Alt.; W/A.C.	668850	♣9425HD
			Belt - Air Brake Compr.	2463090	♣9660HD
TGH3501; TGH3502			Belt - A.C.	78283	5VX850
Belt - Fan	2465849	TR22792			
Belt - W.P. & Gen.	2463090	②♣9660HD	GMC DH478 Diesel		
Belt - Compr.	8867793	♣9660HD	TDH3501; TDH3502; TDH3502A		
			Belt - Fan	2465849	TR22792
GMC D478 Diesel			Belt - W.P. & Alt.	2466318	③♣9630HD
TDH3501; TDH3502; TDH3502A			Belt - Alt.; W/A.C.	668850	♣9425HD
Belt - Fan	2465849	TR22792	Belt - Air Brake Compr.	2463090	♣9660HD
Belt - W.P. & Alt.	2466318	③♣9630HD	Belt - A.C.	78283	5VX850
Belt - Alt.; W/A.C.	668850	♣9425HD			
Belt - Air Brake Compr.	2463090	♣9660HD	1964		
Belt - A.C.	78283	5VX850	GM V-6 305		
			TGH3301		
GMC DH478 Diesel			Belt - Fan	2465849	TR22792
TDH3501; TDH3502; TDH3502A			Belt - W.P. & Gen.	2463090	②♣9660HD
Belt - Fan	2465849	TR22792	Belt - Compr.		♣9640HD
Belt - W.P. & Alt.	2466318	③♣9630HD			
Belt - Alt.; W/A.C.	668850	♣9425HD	TGH3501; TGH3502		
Belt - Air Brake Compr.	2463090	♣9660HD	Belt - Fan	2465849	TR22792
Belt - A.C.	78283	5VX850	Belt - W.P. & Gen.	2463090	②♣9660HD
			Belt - Compr.	8867793	♣9640HD
1965					
GM V-6 305			GM V-6 351		
TGH3301			TGH3301		
Belt - Fan	2465849	TR22792	Belt - Fan	2465849	TR22792
Belt - W.P. & Gen.	2463090	②♣9660HD	Belt - W.P. & Gen.	2463090	②♣9660HD
Belt - Compr.		♣9640HD	Belt - Compr.		♣9640HD
TGH3501			TGH3501; TGH3502		
Belt - Fan	2465849	TR22792	Belt - Fan	2465849	TR22792
Belt - W.P. & Gen.	2463090	②♣9630HD	Belt - W.P. & Gen.	2463090	②♣9660HD
Belt - Compr.	8867793	♣9640HD	Belt - Compr.	8867793	♣9640HD
TGH3502					
Belt - Fan	2465849	TR22792	GM V-6 379		
Belt - W.P. & Gen.	2463090	②♣9660HD	TGH3301		
Belt - Compr.	8867793	♣9640HD	Belt - Fan	2465849	TR22792
			Belt - W.P. & Gen.	2463090	②♣9660HD
GM V-6 351			Belt - Compr.		♣9640HD
TGH3301			TGH3501; TGH3502		
Belt - Fan	2465849	TR22792	Belt - Fan	2465849	TR22792
Belt - W.P. & Gen.	2463090	②♣9660HD	Belt - W.P. & Gen.	2463090	②♣9660HD
Belt - Compr.		♣9640HD	Belt - Compr.	8867793	♣9640HD
TGH3501; TGH3502					
Belt - Fan	2465849	TR22792	GM V-6 379		
			TGH3301		
			Belt - Fan	2465849	TR22792
			Belt - W.P. & Gen.	2463090	②♣9660HD
			Belt - Compr.		♣9640HD
			TGH3501; TGH3502		
			Belt - Fan	2465849	TR22792
			Belt - W.P. & Gen.	2463090	②♣9660HD
			Belt - Compr.	8867793	♣9640HD

♣Standard Belt Available.
③Three Required.

②Two Required.

Belts and Coolant Hose for Transit Buses

Application	Mfr. Part No.	Our No.	Application	Mfr. Part No.	Our No.
GMC - Continued			Lag - Continued		
1964 - Continued			1984		
GMC D478 Diesel			Cummins L10 Diesel		
TDH3501; TDH3502; TDH3502A			LAG350T		
Belt - Fan	2465849	TR22792	Belt - Compr.	3046518	◆K120525HD
Belt - W.P. & Alt.	2466318	③◆9630HD	M.A.N.		
Belt - Alt.; W/A.C.	668850	◆9425HD	1989 - 1984		
Belt - Air Brake Compr.	2463090	◆9660HD	M.A.N. D2566MLUH Diesel		
Belt - A.C.	78283	5VX850	40 Ft. Americana		
GMC DH478 Diesel			Belt - Eng. To Fan		
TDH3501; TDH3502; TDH3502A			2/9690PB		
Belt - Fan	2465849	TR22792	Belt - Fan To Fan	2/9435PB	
Belt - W.P. & Alt.	2466318	③◆9630HD	Belt - W.P.	②◆◆9500HD	
Belt - Alt.; W/A.C.	668850	◆9425HD	Belt - Alt.	③◆9560HD	
Belt - Air Brake Compr.	2463090	◆9660HD	M.A.N. D2566MTUM Diesel		
Belt - A.C.	78283	5VX850	BUS		
Goshen Coach			Belt - Fan - Eng. To Idler		
1999			②◆◆9447HD		
Cummins ISB Diesel			Belt - Fan - Idler To Fan		
Sentry			②◆9395HD		
Belt - Alt. & W.P.		◆K080780HD	Belt - W.P.		
Belt - A.C.		AX45	②◆◆9500HD		
Tensioner Assy. - Alt. & W.P.	3924026	38517	Belt - Alt.		
Tensioner Pulley - Alt. & W.P.	3924026	36095	③◆9560HD		
Graf & Stift			Belt - Air Brake Compr.		
1985 - 1984			②◆◆9530HD		
M.A.N. 6-Cyl. Diesel			1983 - 1978		
D2566			M.A.N. D2566MTUM Diesel		
Belt - Alt.		②◆9480HD	BUS		
Belt - P.S.		③◆9630HD	Belt - Fan - Eng. To Idler		
Ikarus			②◆◆9447HD		
1995			Belt - Fan - Idler To Fan		
Cummins M11 Diesel			②◆9395HD		
436-06			Belt - W.P.		
Belt - Hub & Alt.	3097269	◆K100610HD	②◆◆9500HD		
Tensioner Assy. - Alt.	3401041	38537	Belt - Alt.		
International/Navistar			③◆9560HD		
2008			Belt - Air Brake Compr.		
International/Navistar VT365 Diesel			②◆◆9530HD		
HC Series			Marcopolo		
Belt - Fan, Alt. & A.C.	1839963C1	◆K080830HD	1996		
Belt - Fan & Air Compr.	1843218C1	◆K060509HD	Detroit Diesel Series 60 Diesel		
Tensioner Assy. - Fan, Alt. & A.C.	1833688C2	38556	Viaggio 1000		
Tensioner Assy. - Air Brake Compr.	1832711C2	38629	Belt - Hub & Alt.		
Hose - Upper - Eng. To Rad.		22774	23521337		
Hose - Lower - Eng. To Rad.		22775	◆K120720HD		
Lag			Belt - A.C.		
1991 - 1988			394124665		
Cummins L10 Diesel			Belt - Fan - Left Side		
LAG350T			394124665		
Belt - Compr.	3046518	◆K120525HD	MCI		
1987 - 1985			2013		
Cummins L10 Diesel			Cummins ISX12 Diesel		
LAG300T; LAG350T			D4005; D4505; J4500		
Belt - Compr.	3046518	◆K120525HD	Belt - Serpentine - Fan		
			08271207DF		
			K101096HD		
			2009		
			Detroit Diesel 6-Cyl. 14.0 L Diesel		
			D4005; D4505		
			Belt - Serpentine - Fan		
			08271115		
			◆K100884HD		
			2008		
			Caterpillar C13 Diesel		
			D4500		
			Belt - Alt.		
			8L27132		
			◆K120738HD		
			Belt - A.C.		
			8L27157		
			②CX100		
			Belt - Fan - From C.S.		
			08271090		
			3/5VP213.68		
			2007		
			Detroit Diesel 6-Cyl. 12.7 L Diesel		
			D4500		
			Belt - Fan		
			M800347		
			7360		

◆Standard Belt Available.
②Two Required.

③Three Required.
◆PowerBand Belt May Work, Use Template to Check.

Belts and Coolant Hose for Transit Buses

Application	Mfr. Part No.	Our No.	Application	Mfr. Part No.	Our No.
MCI - Continued			MCI - Continued		
2006			2000 - Continued		
Detroit Diesel 6-Cyl. 12.7 L Diesel			Detroit Diesel Series 60 Diesel - Continued		
D4500			102-DL3 - Continued		
Belt - Alt.	23530282	♣K100789HD	Belt - Eng. To Fan	8L27155	C152
J4500			1999		
Belt - A.C.	08271029	CX101	Detroit Diesel 6-Cyl. 11.1 L Diesel		
Belt - Alt.; W/Dual Alts.	23530281	K100879HD	102-EL3		
2005			Belt - Alt. - Left Side		
Detroit Diesel 6-Cyl. 12.7 L Diesel			Belt - Alt. - Right Side		
J4500			Belt - A.C. - Right Side		
Belt - A.C.	08271029	CX101	Tensioner Assy. - Alt. - Right Side		
Belt - Alt.; W/Dual Alts.	23530281	K100879HD	Detroit Diesel Series 60 Diesel		
2004			102-DL3		
Detroit Diesel 6-Cyl. 12.7 L Diesel			Belt - Alt.		
D4000			Belt - A.C.		
Belt - Alt.	23530282	♣K100789HD	Belt - Fan To Fan		
J4500			Belt - Eng. To Fan		
Belt - A.C.	08271029	CX101	Tensioner Assy. - Alt.		
Belt - Alt.; W/Dual Alts.	23530281	K100879HD	1998		
2003			Detroit Diesel 6-Cyl. 12.7 L Diesel		
Detroit Diesel 6-Cyl. 12.7 L Diesel			102-EL3		
D4500			Belt - Alt. - Left Side		
Belt - Alt.	23530282	♣K100789HD	Belt - Alt. - Right Side		
Belt - Fan	8L27163	3/5VP2000	Belt - A.C. - Right Side		
G4500			Tensioner Assy. - Alt. - Right Side		
Belt - A.C.	08276028	2/5VX1075	Detroit Diesel Series 60 Diesel		
Belt - Idler To Fan Shaft	08276027	2/5VX686	102-DL3		
Belt - Fan	08276015	C100	Belt - Alt.		
J4500			Belt - A.C.		
Belt - A.C.	08271029	CX101	Belt - Fan To Fan		
Belt - Alt.; W/Dual Alts.	23530281	K100879HD	Tensioner Assy. - Alt.		
2002			1996		
Detroit Diesel 6-Cyl. 12.7 L Diesel			Detroit Diesel Series 60 Diesel		
G4500			102-DL3		
Belt - A.C.	08276028	2/5VX1075	Belt - A.C.		
Belt - Fan - From Idler	08276027	2/5VX686	Belt - Fan To Fan		
Belt - Eng. To Idler	08276027	2/5VX686			
Belt - Alt.	8L27132	♣K120738HD	1995		
Belt - Fan - From C.S.	08276015	C100	Cummins L10 Diesel		
Tensioner Assy. - Alt.	23526034	38520	102-D3		
2001			Belt - A.C.		
Detroit Diesel Series 60 Diesel			Belt - Alt.		
102-DL3			Belt - Fan - Right Side		
Belt - Fan To Fan	8L27144	C95	Belt - Fan To Fan		
Belt - Eng. To Fan	8L27155	C152	Tensioner Assy. - Alt.		
2000			Detroit Diesel Series 60 Diesel		
Detroit Diesel 6-Cyl. 12.7 L Diesel			102-DL3		
102-EL3			Belt - A.C.		
Belt - A.C.	08271029	CX101	Belt - Fan To Fan		
Belt - Alt. - Left Side	23525817	K060295			
Belt - Alt. - Right Side	8L27132	♣K120738HD	1994		
Tensioner Assy. - Alt. - Right Side	23521020	38520	Detroit Diesel Series 60 Diesel		
Detroit Diesel Series 60 CNG			102-D3		
102-D3			Belt - Alt.		
Belt - A.C. & Idler	8L2788	②CX96	Belt - A.C.		
Tensioner Assy. - Alt.	23526034	38520	Belt - Fan To Fan		
Detroit Diesel Series 60 Diesel			Tensioner Assy. - Alt.		
102-DL3			Detroit Diesel Series 60 Diesel		
Belt - Fan To Fan	8L27144	C95	102-D3		
			Belt - Alt.		
			Belt - A.C.		
			Belt - Fan To Fan		
			Tensioner Assy. - Alt.		

♣Standard Belt Available.

②Two Required.

Belts and Coolant Hose for Transit Buses

Application	Mfr. Part No.	Our No.	Application	Mfr. Part No.	Our No.
MCI - Continued			NABI - Continued		
1987			1999 - Continued		
Detroit Diesel 8V-71 Diesel			Detroit Diesel Series 50 Diesel - Continued		
96-A3			LFW - Continued		
Belt - A.C.		2/B93	Belt - A.C.		2/5VX1000
1986			Tensioner Assy. - Alt.; W/450A. Alt.	23526034	38520
Detroit Diesel 6V-92 Diesel			1998		
102-A3			Detroit Diesel Series 50 Diesel		
Belt - A.C.	8G276	CX90	436		
1985			Belt - W.P. & Alt. (Main Eng.)		
Detroit Diesel 6V-92 Diesel			Belt - A.C. (Main Eng.)		
102-A3			Belt - Alt. (Aux. Eng.)		
Belt - A.C.		2/C90	Belt - W.P. (Aux. Eng.)		
MCR			Tensioner Assy. - W.P. & Alt. (Main Eng.) ..		
1985			LFW		
Detroit Diesel V-8 8.2 L Diesel			Belt - Alt.; W/450A. Alt.		
7000 Series 2			23521000		
Belt - Fan & Alt.		②♠9700HD	♠K120738HD		
Belt - P.S.		♠9425HD			
Belt - Air Brake Compr.		♠9700HD			
NABI			1997		
2006 - 2005			Detroit Diesel Series 50 Diesel		
Cummins ISM Diesel			416		
LFW			Belt - Alt.		
Belt - Alt.	3097269	♠K100610HD	Tensioner Assy. - Alt.		
Tensioner Assy. - Alt.	3102889	38537	23533015		
2004 - 2002			National Coach		
Detroit Diesel Series 50 Diesel			1991 - 1984		
LFW			Detroit Diesel V-8 8.2 L Diesel		
Belt - Alt.		♠K120738HD	Transmark		
Belt - A.C.	2/5VX1040	2/5VX1042	Belt - Alt.; W/O A.C.		
Tensioner Assy. - Alt.	23533015	38520	Belt - Alt.; W/A.C.; Preferred Belt		
2001			Belt - Alt.; W/A.C.; Optional Belt		
Detroit Diesel Series 50 Diesel			Belt - P.S.		
LFW			Belt - Air Brake Compr.		
Belt - Alt.		♠K120738HD	Belt - A.C.		
Belt - A.C.	2/5VX1040	2/5VX1042	②♠♠9700HD		
Tensioner Assy. - Alt.	23533015	38520	2/9570PB		
2000			②♠9570HD		
Cummins ISM Diesel			②♠♠9430HD		
436			♠9700HD		
Tensioner Assy. - Hub & Alt.	4004933	38505	②B88		
Tensioner Pulley - Hub & Alt.	4004933	36091			
Detroit Diesel Series 50 Diesel			Neoplan		
LFW			2003		
Belt - Alt.		♠K120738HD	Detroit Diesel Series 50 Diesel		
Belt - A.C.	2/5VX1040	2/5VX1042	AN460		
Tensioner Assy. - Alt.	23533015	38520	Belt - Hub & Alt.		
Detroit Diesel Series 60 Diesel			Tensioner Assy. - Alt.		
LFW			23521000		
Belt - Alt. & W.P.	23521000	♠K120738HD	♠K120738HD		
Tensioner Assy. - Alt. & W.P.	23526034	38520	38520		
2000			2002		
Cummins ISM Diesel			Cummins ISC CNG		
436			AN440		
Tensioner Assy. - Hub & Alt.	4004933	38505	Belt - A.C.		
Tensioner Pulley - Hub & Alt.	4004933	36091	Belt - Hub & Alt.		
Detroit Diesel Series 50 Diesel			Belt - W.P.		
LFW			PV0107122		
Belt - Alt.		♠K120738HD	2/5VX930		
Belt - A.C.	2/5VX1040	2/5VX1042	♠K080514HD		
Tensioner Assy. - Alt.	23533015	38520	♠K080702HD		
1999			Detroit Diesel Series 50 Diesel		
Detroit Diesel Series 50 Diesel			AN460		
LFW			Belt - A.C.		
Belt - Alt.		♠K120738HD	Belt - A.C. To Alt.		
Belt - A.C.	2/5VX1040	2/5VX1042	Belt - Hub & Alt.		
Tensioner Assy. - Alt.	23533015	38520	Belt - Eng. To J.S.		
1999			Tensioner Assy. - Hub & Alt.		
Detroit Diesel Series 50 Diesel			23526034		
LFW			38520		
Belt - Alt.; W/450A. Alt.	23521000	♠K120738HD			

♠Standard Belt Available.
 ◆PowerBand Belt May Work, Use Template to Check.

②Two Required.

Transit Buses

Belts and Coolant Hose for Transit Buses

Application	Mfr. Part No.	Our No.	Application	Mfr. Part No.	Our No.
Neoplan - Continued			New Flyer - Continued		
2001 - 2000 - Continued			2004		
Detroit Diesel Series 50 Diesel - Continued			Cummins ISC LNG		
BUS - Continued			L40LF		
Belt - A.C.		2/5VX1000	Belt - A.C.	R5VX830/2	2/5VX830
1999 - 1998			2003		
Detroit Diesel 6V-92 Diesel			Cummins ISC CNG		
BUS			C40LF		
Belt - Fan		2/B90	Belt - Hub & Alt.	3939711	▲K080514HD
Detroit Diesel Series 50 Diesel			Tensioner Assy. - Hub & Alt.		
BUS			Tensioner Assy. - W.P.	3937553	38504
Belt - Fan		2/5VX800	Tensioner Assy. - W.P.	3936203	38504
Belt - Alt.		▲K120720HD	Tensioner Pulley - W.P.	3936203	36091
Belt - A.C.		2/5VX1000	Tensioner Pulley - Hub & Alt.	3937553	36091
Metroliner 40 Ft.; Transliner 40 Ft.			John Deere 6-Cyl. 8.1 L CNG		
Belt - Alt.; W/450A. Alt.	23521000	▲K120738HD	C40LF		
1997 - 1996			Tensioner Assy. - Alt.		
Detroit Diesel 6V-92 Diesel			RE506352		
BUS			38591		
Belt - Fan		2/B90	2002		
Detroit Diesel Series 50 Diesel			Cummins ISC CNG		
BUS			C40LF		
Belt - Fan		2/5VX800	Belt - Hub & Alt.		
Belt - Alt.		▲K120720HD	3939711		
Belt - A.C.		2/5VX1000	Tensioner Assy. - Hub & Alt.		
1995			3937553		
Detroit Diesel 6V-92 Diesel			Tensioner Assy. - W.P.		
BUS			3936203		
Belt - Fan		2/B90	Tensioner Pulley - W.P.		
Detroit Diesel Series 50 Diesel			3936203		
BUS			Tensioner Pulley - Hub & Alt.		
Belt - Fan		2/5VX800	3937553		
Belt - Alt.		▲K120720HD	Cummins ISL Diesel		
Belt - A.C.		2/5VX1000	DE40LF		
1994			Tensioner Assy.		
Detroit Diesel 6V-92 Diesel			3945527		
BUS			38516		
Belt - Fan		2/B90	Tensioner Pulley		
Detroit Diesel Series 50 Diesel			3945527		
BUS			2001		
Belt - Fan		2/5VX800	Cummins L10 Diesel		
Belt - Alt.		▲K120720HD	D40		
Belt - A.C.		2/5VX1000	Hose - Upper		
1994 - 1984			③≲24636		
Detroit Diesel 6V-92 Diesel			Hose - Lower - Eng. To Pipe		
BUS			≲24640		
Belt - Fan		2/B90	Detroit Diesel Series 50 CNG		
Detroit Diesel Series 50 Diesel			C40LF		
BUS			Belt - Alt. & W.P.		
Belt - Fan		2/5VX800	6330349		
Belt - Alt.		▲K120720HD	▲K120720HD		
Belt - A.C.		2/5VX1000	Tensioner Assy. - Alt. & W.P.		
Detroit Diesel Series 60 Diesel			23526034		
Citiliner			38520		
Belt - Compr.		②5VX1000	2000		
Belt - Hub To Fan; W/Dual Fans		②5VX850	Cummins L10 Diesel		
Belt - Hub		②5VX800	D40		
Belt - Hub & Alt.	23521337	▲K120720HD	Hose - Upper		
1994 - 1984			③≲24636		
Detroit Diesel 6V-92 Diesel			Hose - Lower - Eng. To Pipe		
BUS			≲24640		
Belt - Fan		2/B90	1999 - 1998		
Detroit Diesel Series 50 Diesel			Cummins L10 Diesel		
BUS			D40		
Belt - Fan		2/5VX800	Hose - Upper		
Belt - Alt.		▲K120720HD	③≲24636		
Belt - A.C.		2/5VX1000	Hose - Lower - Eng. To Pipe		
New Flyer			≲24640		
2005			Cummins L10 Diesel		
Cummins ISL Diesel			D40		
DE40LF			Hose - Upper		
Belt - Alt.	3288634	▲K080496HD	③≲24636		
Belt - W.P.	3288834	▲K080580HD	Hose - Lower - Eng. To Pipe		
			≲24640		

▲Standard Belt Available.
≲Cut to Fit.

②Two Required.
③Three Required.

Transit Buses

Belts and Coolant Hose for Transit Buses

Transit Buses

Application	Mfr. Part No.	Our No.	Application	Mfr. Part No.	Our No.
New Flyer - Continued			New Flyer - Continued		
1997 - 1996			1991 - Continued		
Cummins L10 Diesel			Detroit Diesel 6V-92 Diesel - Continued		
D40			D40 - Continued		
Hose - Upper		③≡24636	Belt - Hub & Fan	JD0107040	2/5VX600
Hose - Lower - Eng. To Pipe		≡24640	1990 - 1987		
Detroit Diesel Series 50 Diesel			Cummins L10 Diesel		
C35LF			D40		
Belt - Hub & A.C.		2/5VX950	Hose - Upper		③≡24636
Belt - Hub & Alt.		♣K120720HD	Hose - Lower - Eng. To Pipe		≡24640
Belt - Hyd. Pump		2/5VX600	Nova Bus		
Tensioner Assy. - Hub & A.C.	23512829	38505	2004		
Tensioner Pulley - Hub & A.C.	23512829	36091	Cummins ISL Diesel		
1995			Nova LFS		
Cummins L10 Diesel			Belt - Hub & Alt.		
D40			3288634		
Hose - Upper		③≡24636	Belt - Eng.	3288812	♣K080496HD
Hose - Lower - Eng. To Pipe		≡24640	Tensioner Assy. - Hub & Alt.	3936212	38552
Detroit Diesel Series 50 Diesel			2003		
D40			Cummins ISC Diesel		
Belt - Fan	029584	♣K120410HD	Nova LFS		
Belt - Alt.	23521338	♣K100381HD	Belt - Hub & W.P.		
D40LF			3939580		
Belt - Alt. & W.P.		♣K120720HD	Belt - Hub & Alt.		
D60			3937661		
Belt - Alt. & W.P.		♣K120738HD	Tensioner Assy. - Hub & Alt.		
Belt - A.C.	024598	2/5VX850	3936213		
Tensioner Assy. - Alt. & W.P.	23526034	38520	Tensioner Assy. - Hub & W.P.		
1994			3936212		
Cummins L10 Diesel			Tensioner Pulley - Hub & Alt.		
D40			36093		
Hose - Upper		③≡24636	Optare		
Hose - Lower - Eng. To Pipe		≡24640	2003		
Detroit Diesel Series 50 Diesel			Cummins ISB Diesel		
D40			30-LFN		
Belt - Fan	029584	♣K120410HD	Belt - Alt. & A.C.		
1993			2/A36		
Cummins L10 Diesel			Hose - Upper - Pipe To Pipe; Reducer Hose		
D40			23282		
Hose - Upper		③≡24636	Optima Bus Corporation		
Hose - Lower - Eng. To Pipe		≡24640	2004		
Detroit Diesel Series 50 Diesel			Cummins ISB Diesel		
D40			Opus 29		
Belt - Fan	029584	♣K120410HD	Belt - Hub & Alt.		
1992			3288598		
Cummins L10 Diesel			♣K080471HD		
D40			Orion		
Hose - Upper		③≡24636	2011		
Hose - Lower - Eng. To Pipe		≡24640	Cummins ISL CNG		
Detroit Diesel Series 50 Diesel			Orion V; Orion VII		
D40			Tensioner Assy.		
Belt - A.C.	6335557	2/5VX670	081310508		
Belt - Alt.	23521338	♣K100381HD	Tensioner Pulley		
1991			36350		
Cummins L10 Diesel			2010		
D40			Cummins ISL CNG		
Hose - Upper		③≡24636	Orion V; Orion VII		
Hose - Lower - Eng. To Pipe		≡24640	Tensioner Assy.		
Detroit Diesel 6V-92 Diesel			081310508		
D40			Tensioner Pulley		
Belt - A.C.		2/5VX800	36350		
Belt - Fan		♣K120400HD	Idle Pulley - A.C.		
2009			081310523		
Cummins L10 Diesel			36352		
D40			2009		
Hose - Upper		③≡24636	Cummins ISL CNG		
Hose - Lower - Eng. To Pipe		≡24640	Orion V; Orion VII		
Detroit Diesel 6V-92 Diesel			Tensioner Assy.		
D40			081310508		
Belt - A.C.		2/5VX800	Tensioner Pulley		
Belt - Fan		♣K120400HD	36350		

≡Cut to Fit.
③Three Required.

♣Standard Belt Available.

Belts and Coolant Hose for Transit Buses

Application	Mfr. Part No.	Our No.	Application	Mfr. Part No.	Our No.
Orion - Continued			Orion - Continued		
2008			1999 - Continued		
Cummins ISL CNG			Cummins ISB Diesel - Continued		
Orion VII			Orion II - Continued		
Belt - Alt.	3288634	♣K080496HD	Tensioner Pulley - A.C.; W/Dual A.C.	3945527	36093
Belt - Fan	070803122	♣K080948HD	Cummins L10 Diesel		
Tensioner Assy. - Alt.	3934830	38552	Orion V		
Tensioner Assy.	3973819	38627	Belt - Alt.	3097269	♣K100610HD
2005			Belt - Compr.		6599
Cummins ISL Diesel			Detroit Diesel 6V-92 Diesel		
Orion VII			Orion		
Belt - Alt.	3288634	♣K080496HD	Belt - Alt.; W/Electrodyne 300A. Alt.		♣K120281HD
Belt - W.P.	3288834	♣K080580HD	Detroit Diesel V-8 8.2 L Diesel		
Tensioner Assy. - Alt.	3976831	38516	Orion II		
Tensioner Assy. - W.P.	3976831	38516	Belt - W.P. & Air Brake Compr.		♣K100710HD
2003 - 2002			Belt - Alt.		♣K080330HD
Cummins ISC CNG			1998 - 1996		
Orion VII			Cummins L10 Diesel		
Belt - Hub & Alt.	3939711	♣K080514HD	Orion V		
Belt - Hub & W.P.	3939709	♣K080702HD	Belt - Alt.	3097269	♣K100610HD
Belt - A.C.		2/B90	Belt - Compr.		6599
Tensioner Assy. - Hub & Alt.	3937553	38504	Detroit Diesel 6V-92 Diesel		
Tensioner Assy. - Hub & W.P.	3936203	38504	Orion		
Tensioner Pulley - W.P.	3936203	36091	Belt - Alt.; W/Electrodyne 300A. Alt.		♣K120281HD
Tensioner Pulley - Hub & Alt.	3937553	36091	Detroit Diesel Series 50 Diesel		
2001			Orion V		
Detroit Diesel 6V-92 Diesel			Belt - Hyd. Pump - Left Side		2/5VX600
Orion			Belt - Hub & A.C.		2/5VX950
Belt - Alt.; W/Electrodyne 300A. Alt.		♣K120281HD	Tensioner Assy. - Hub & A.C.	5326278000	38506
Detroit Diesel V-8 8.2 L Diesel			Tensioner Assy. - Alt.	23526034	38520
Orion II			Tensioner Pulley - Hub & A.C.	5326278000	36091
Belt - W.P. & Air Brake Compr.		♣K100710HD	Detroit Diesel V-8 8.2 L Diesel		
Belt - Alt.		♣K080330HD	Orion II		
2000			Belt - W.P. & Air Brake Compr.		♣K100710HD
Cummins ISM Diesel			Belt - Alt.		♣K080330HD
Orion V			1995		
Tensioner Assy. - Hub & Alt.	4004933	38505	Cummins L10 Diesel		
Tensioner Pulley - Hub & Alt.	4004933	36091	Orion V		
Detroit Diesel 6V-92 Diesel			Belt - Alt.	3097269	♣K100610HD
Orion			Belt - Compr.		6599
Belt - Alt.; W/Electrodyne 300A. Alt.		♣K120281HD	Detroit Diesel 6V-92 Diesel		
Detroit Diesel Series 50 Diesel			Orion		
Orion V			Belt - Alt.; W/Electrodyne 300A. Alt.		♣K120281HD
Belt - Hub & Alt.	23521000	♣K120738HD	Detroit Diesel Series 50 Diesel		
Belt - Hyd.		2/BX97	Orion V		
Tensioner Assy. - Hub & Alt.	23526034	38520	Belt - Alt. & Air Brake Compr.	050764005	K080455
Orion VI			Belt - Hyd. Pump	050764601	K080458
Belt - Hub & Alt.	23521000	♣K120738HD	Detroit Diesel V-8 8.2 L Diesel		
Belt - A.C.	060713026	2/B92	Orion II		
Tensioner Assy. - Hub & Alt.	23526034	38520	Belt - W.P. & Air Brake Compr.		♣K100710HD
Detroit Diesel V-8 8.2 L Diesel			Belt - Alt.		♣K080330HD
Orion II			1994		
Belt - W.P. & Air Brake Compr.		♣K100710HD	Cummins L10 Diesel		
Belt - Alt.		♣K080330HD	Orion V		
1999			Belt - Alt.	3097269	♣K100610HD
Cummins ISB Diesel			Belt - Compr.		6599
Orion II			Orion V		
Belt - Alt.	5080415	♣K080415HD	Orion II		
Belt - A.C.	020736040	♣K080910HD	Orion V		
Tensioner Assy. - A.C.; W/Dual A.C.	3945527	38516	Orion V		
			Belt - Alt.		
			Belt - Compr.		

♣Standard Belt Available.

Transit Buses

Belts and Coolant Hose for Transit Buses

Application	Mfr. Part No.	Our No.	Application	Mfr. Part No.	Our No.
Orion - Continued			Orion - Continued		
1994 - Continued			1989 - 1983		
Detroit Diesel 6V-92 Diesel			Detroit Diesel 6V-92 Diesel		
Orion			Orion		
Belt - Alt.; W/Electrodyne 300A. Alt.		▲K120281HD	Belt - Alt.; W/Electrodyne 300A. Alt.		▲K120281HD
Detroit Diesel V-8 8.2 L Diesel			Detroit Diesel V-8 8.2 L Diesel		
Orion II			Orion II		
Belt - W.P. & Air Brake Compr.		▲K100710HD	Belt - W.P. & Air Brake Compr.		▲K100710HD
Belt - Alt.		▲K080330HD	Belt - Alt.		▲K080330HD
1993			Prevost		
Cummins L10 Diesel			2004		
Orion V			Detroit Diesel 6-Cyl. 12.7 L Diesel		
Belt - Alt. 3097269		▲K100610HD	H3-45		
Belt - Compr.		6599	Belt - A.C.		②BX100
Tensioner Assy. - Alt. 3401041		38537	Belt - Gear Box		③AX74
Detroit Diesel 6V-92 Diesel			Belt - Gear Box To Fan		▲K100495HD
Orion			Belt - Alt.; W/Dual Alts. 23523003		▲K120815HD
Belt - Alt.; W/Electrodyne 300A. Alt.		▲K120281HD	Tensioner Assy. - Alt.; W/Dual Alts. 23526034		38520
Detroit Diesel V-8 8.2 L Diesel			2003		
Orion II			Detroit Diesel 6-Cyl. 12.7 L Diesel		
Belt - W.P. & Air Brake Compr.		▲K100710HD	H3-45		
Belt - Alt.		▲K080330HD	Belt - Gear Box To Fan		▲K100495HD
1992			Belt - Eng. To Gear Box		③AX72
Detroit Diesel 6V-92 Diesel			Tensioner Assy.; W/Dual Alts. 23526034		38520
Orion			2000		
Belt - Alt.; W/Electrodyne 300A. Alt.		▲K120281HD	Detroit Diesel 6-Cyl. 11.1 L Diesel		
Detroit Diesel Series 50 Diesel			LeMirage XL		
Orion V			Belt - Gear Box To Fan		▲K100510HD
Belt - Hub & Alt. 23521000		▲K120738HD	Belt - Eng. To Gear Box		③AX73
Belt - P.S.		▲K080465HD	Belt - A.C. - Right Side		②BX100
Tensioner Assy. - P.S. 3937553		38504	Belt - Gear Box; W/Aux. A.C.; W/A.C.		A35
Tensioner Assy. - Hub & Alt. 23526034		38520	Belt - Hub & Alt. 23523003		▲K120815HD
Tensioner Pulley - P.S. 3937553		36091	Tensioner Assy. - Hub & Alt. 23526034		38520
Detroit Diesel V-8 8.2 L Diesel			Detroit Diesel 6-Cyl. 12.7 L Diesel		
Orion II			H3-45		
Belt - W.P. & Air Brake Compr.		▲K100710HD	Belt - A.C.		②BX100
Belt - Alt.		▲K080330HD	Belt - Eng. To Gear Box		③AX72
1991			Belt - Gear Box To Fan		▲K100495HD
Detroit Diesel 6V-92 Diesel			Belt - Alt.; W/Dual Alts. 23523003		▲K120815HD
Orion			Tensioner Assy. - Alt.; W/Dual Alts. 23526034		38520
Belt - Alt.; W/Electrodyne 300A. Alt.		▲K120281HD	1999		
Detroit Diesel V-8 8.2 L Diesel			Detroit Diesel 6-Cyl. 12.7 L Diesel		
Orion II			H3-45		
Belt - W.P. & Air Brake Compr.		▲K100710HD	Belt - Alt.; W/Dual Alts. 23523003		▲K120815HD
Belt - Alt.		▲K080330HD	1997		
1990			Detroit Diesel 6-Cyl. 12.7 L Diesel		
Detroit Diesel 6V-92 Diesel			H3-45		
Orion			Belt - A.C.		②BX97
Belt - Alt.; W/Electrodyne 300A. Alt.		▲K120281HD	Belt - Eng. To Gear Box		③AX73
Detroit Diesel V-8 8.2 L Diesel			Belt - Gear Box To Fan		▲K100495HD
Orion II			Belt - Alt. 8L27132		▲K120738HD
Belt - W.P. & Air Brake Compr.		▲K100710HD	Tensioner Assy. - Alt.		38520
Belt - Alt.		▲K080330HD	Setra		
Belt - A.C. 020736034		▲K120360HD	2004		
			Detroit Diesel Series 60 Diesel		
			S417		
			Tensioner Assy. - Alt.; W/Dual Alts. 23527677		38569

▲Standard Belt Available.
③Three Required.

②Two Required.

Belts and Coolant Hose for Transit Buses

Application	Mfr. Part No.	Our No.	Application	Mfr. Part No.	Our No.
Setra - Continued			Turtle Top		
2002			2006		
Detroit Diesel Series 60 Diesel			Ford V-10 6.8 L		
S215			Odyssey		
Belt - A.C.		A87	Belt - Fan, Alt., P.S. & A.C.; W/Dual A.C.	204398	♣K061203HD
Belt - Hub To Fan		A52	2005		
Belt - Hub & Alt.		A50	Ford V-10 6.8 L		
Belt - Hub		A76	Odyssey		
Belt - Alt. To Alt.		A43	Belt - Fan, Alt., P.S. & A.C.; W/Dual A.C.	204398	♣K061203HD
Tensioner Assy. - Hub & A.C.	5326278000	38506	GM V-8 6.0 L		
Tensioner Pulley - Hub & A.C.	5326278000	36091	Spirit		
1994			Belt - Serpentine; W/105A. Alt.		
Detroit Diesel Series 60 Diesel				12576450	♣K060923HD
S215			Belt - Serpentine; W/145A. Alt.	12576451	♣K060930HD
Belt - Eng. To Pulley		②AX74	Belt - A.C.	12576447	♣K040378HD
Belt - A.C.		②5VX950	Tensioner Assy. - A.C.	12580196	38159
Belt - Fan		②♣9520HD	Tensioner Assy. - Serpentine	12580162	38158
Belt - Alt. To Alt.		♣9447HD	Idler Pulley - Serpentine	12580771	36299
1993 - 1992			Tensioner Pulley - Serpentine	12580162	38009
Detroit Diesel Series 60 Diesel			Tensioner Pulley - A.C.	12580196	36169
S215			Hose - Upper		22755
Belt - Hub	4.767.882.002	②A76	Hose - Lower		22756
Belt - Hub To Fan	4.767.723.002	②A49	GM V-8 6.6 L Diesel		
Belt - Alt. To Alt.	4.767.717.102	A44	Odyssey XL		
Thomas Built			Belt - Fan	201727	K061490
2003			Tensioner Assy.	97288625	38172
Cummins ISB CNG			Tensioner Pulley	97288625	36239
SLF 200			Hose - Upper - Eng. To Rad.		22763
Belt - Hub		2/5VX850	Hose - Lower - Eng. To Rad.		22771
Belt - Hub & A.C.		②BX40	2000		
Belt - A.C. To Alt.		②AX36	Ford V-10 6.8 L		
Cummins ISB Diesel			Odyssey		
SLF 200			Belt - Fan, Alt., P.S. & A.C.	F7UE 8620 EB	♣K080991HD
Belt - J.S. To Compr.		BX40	Belt - Fan, Alt. & P.S.		♣K080806HD
Belt - Compr. & Alt.		AX39	Tensioner Assy.; W/A.C.		38133
Tensioner Assy. - Hub & Alt.	3936213	38516	Idler Pulley		38022
Tensioner Pulley - Hub & Alt.	3936213	36093	Tensioner Pulley; W/A.C.		38023
Hose - Upper - Eng. To Rad.		21473	Hose - Upper		22316
2000 - 1999			Hose - Lower		22371
Cummins ISB Diesel			1998		
SLF 200			Ford V-8 5.4 L		
Belt - Alt. & W.P.	3911583	♣K080708HD	Van Terra		
Belt - A.C.		A43	Belt - Serpentine; W/A.C.		
Tensioner Assy. - Alt. & W.P.	3945627	38516	Belt - Serpentine; W/O A.C.		♣K080806HD
Hose - Upper		20611	Tensioner Assy.; W/A.C.		38133
Hose - Lower		21891	Tensioner Assy.; W/O A.C.	F75Z 6B209 EA	38330
TMC			Idler Pulley		38022
1995 - 1987			Tensioner Pulley; W/A.C.		38023
Detroit Diesel Series 50 Diesel			Tensioner Pulley; W/O A.C.		38053
RTS06			Hose - Upper		22315
Belt - Alt.	23516111	♣K120702HD	Hose - Lower		22318
1981			U.S. Bus		
Detroit Diesel 6V-53 Diesel			1995 - 1991		
T30			International/Navistar T444 Diesel		
Belt - W.P.	5133177	②7370	BUS		
Belt - Alt.; W/O A.C.	07TA03090	②AX60	Belt - Serpentine		
Belt - Alt.; W/A.C.	16TA03001	②AX46	Hose - Upper		
Belt - A.C.		②C81	Hose - Lower - Pipe To Rad.		
			or		
			♣K080897HD		
			22159		
			26518		
			≧21042		

Transit Buses

 ②Two Required.
 ≧Cut to Fit.

♣Standard Belt Available.

Belts and Coolant Hose for Transit Buses

Application	Mfr. Part No.	Our No.
Van Hool		
2003 - 2002		
Detroit Diesel Series 60 Diesel		
C2045		
Belt - Alt.; W/Dual Alts.	23523003	♣K120815HD
2000		
Cummins ISM Diesel		
C2045		
Belt - Eng. To Pulley		@5VX670
Belt - Fan		@5VX650
Belt - A.C. To Alt.		AX44
Belt - A.C.		@5VX950
Belt - Hub & Alt.	10K1230	♣K100485HD
1999		
Detroit Diesel Series 60 Diesel		
T2140		
Belt - A.C. To Alt.		@AX44
Belt - Eng. To Pulley		@BX65
Belt - Fan		@5VX630
Belt - A.C.		@BX97

Transit Buses

@Two Required.

♣Standard Belt Available.

Belts and Coolant Hose for Road & Construction Equipment

Order Belts and Hose by Our Number. Manufacturers' Part Number is shown for reference only.

Application	Mfr. Part No.	Our No.	Application	Mfr. Part No.	Our No.
Advance Sweeper			Allis-Chalmers - Continued		
5600G			460C - Continued		
Ford 2274E			Detroit Diesel 12V-71 Diesel - Continued		
Belt - Fan & Alt		7320	Belt - Gen.	5133516	▲9380HD
Hose - Upper		25305	Hose - Upper - Left Side		24940
Allis-Chalmers			Hose - Upper - Right Side		
45			Hose - Lower - Eng. To Pipe		
Allis-Chalmers 10000 Diesel			Hose - Lower - Pipe To W.P.		
Belt - Fan; Ser. No. 1780 & After	4363593	②TR28616	Hose - Lower - Heat Exch. To Pipe		
Belt - Fan, Alt. & W.P.		TR28522	Hose - Lower - Pipe To Rad.		
Belt - W.P. & Gen.; Ser. No. 1780 & After ...	4336629	TR28565	545		
Belt - P.T.O.; Ser. No. 1780 & After	097159	③TR22508	Allis-Chalmers 2900 Diesel		
Belt - Aux. Drive To Supercharger & Idler		③TR24562	Belt - Fan & Alt.		
Belt - Hyd. Pump		②B51	Belt - Fan & Hyd. Pump		
Hose - Upper		24440	Hose - Upper		
Hose - Lower		24440	Hose - Lower		
Hose - By Pass		24216	545H		
145			Allis-Chalmers 2900 Diesel		
Allis-Chalmers 6000 Diesel			Belt - Fan & Alt.		
Belt - Fan; Ser. No. 145-400 & Before	4348694	TR28628	Belt - Fan & Hyd. Pump		
Belt - Fan; Ser. No. 145-401 & After	4363593	②TR28616	Hose - Upper		
Belt - P.T.O.	097159	③TR22508	Hose - Lower		
Hose - Upper		23547	560		
Hose - Lower		24240	Allis-Chalmers 21000 Diesel; Allis-Chalmers 25000 Diesel		
145T			Belt - W.P.		
Allis-Chalmers 7000 Diesel			Belt - Air Brake Compr.		
Belt - Fan; Ser. No. 145-400 & Before	4348694	TR28628	4386813		
Belt - Fan; Ser. No. 145-401 & After	4363593	②TR28616	4339463		
Belt - P.T.O.	097159	③TR22508	TR22495		
Hose - Upper		23547	TR28545		
Hose - Lower		24240	615 Backhoe; 615 Wheel Loader		
260			Allis-Chalmers 4-Cyl. 160		
Allis-Chalmers 19000 Mark II Diesel			Belt - Fan & Gen.		
Belt - W.P. & Gen.	4356965	TR28583	233432		
Hose - Upper		24240	7380		
Hose - Lower		24940	②20661		
260A; 260AE; 260E; 260EA			Hose - Upper		
Allis-Chalmers 21000 Mark II Diesel			or		
Belt - Fan		②TR28657	25252		
Belt - W.P.		7500	Allis-Chalmers 4-Cyl. 175 Diesel; Allis-Chalmers 4-Cyl. 200 Diesel		
Belt - Alt		▲9430HD	Belt - Fan & Gen.		
Belt - Air Brake Compr.		TR28501	254075		
Hose - Upper		26532	▲9520HD		
Hose - Lower - Eng. To Pipe		24240	②20498		
Hose - Lower - Pipe To Rad.		24240	645		
460			Allis-Chalmers 3500 Diesel		
Allis-Chalmers 21000H Diesel			Belt - Fan & Gen.; W/61 3/8" Belt O.C.		
Belt - Air Brake Compr.	4386304	TR28545	4025618		
460B			Belt - Fan & Gen.; W/62 1/4" Belt O.C.		
Allis-Chalmers 25000 Mark II Diesel			4026509		
Belt - W.P.	4386813	TR22495	Belt - Air Brake Compr.		
Belt - Air Brake Compr.	4339463	TR28545	4025623		
Belt - Hyd. Pump	4388326	7500	Hose - Upper		
Hose - Upper		26533	②24232		
Hose - Lower		24940	Hose - Lower		
460C			26511		
Detroit Diesel 12V-71 Diesel			645B		
Belt - Fan		②▲9740HD	Allis-Chalmers 3500 Diesel		

②Two Required.
▲Standard Belt Available.

③Three Required.
②Cut to Fit.

Road & Construction Equipment

Belts and Coolant Hose for Road & Construction Equipment

Application	Mfr. Part No.	Our No.	Application	Mfr. Part No.	Our No.
Allis-Chalmers - Continued			Allis-Chalmers - Continued		
715D			AD40 - Continued		
Cummins 4-Cyl. 3.9 L Diesel			Detroit Diesel 6-71 Diesel - Continued		
Belt - Fan & Alt.	1007024	♣9510HD	Hose - Lower		24236
745			BD		
Allis-Chalmers 11000 Diesel			GM 2-Cyl. 142 Diesel		
Belt - Fan		②TR28583	Belt - Fan & Gen.	033138	②TR22625
Belt - Fan & Alt.	3059309	♣9370HD	Belt - P.T.O.	604929	③TR22485
Hose - Upper		②24236	BD2		
Hose - Lower		26536	GM 2-Cyl. 142 Diesel		
816 Backhoe; 816 Wheel Loader			Belt - Fan & Gen.		
Perkins 4-Cyl. 248 Diesel			Belt - P.T.O.	604929	③TR22485
Belt - Fan & Alt.	1007024	♣9510HD	Hose - Upper		24224
Hose - Upper		♣20957	Hose - Lower		24228
	or	26501	BD3		
840 Articulated			Detroit Diesel 3-71 Diesel		
Perkins 4-Cyl. 248 Diesel			Belt - Fan	602944	②TR22578
Belt - Fan & Alt.; Ser. No. 3099 & Before	1011991	♣9480HD	Belt - Gen.	040549	TR20451
Belt - Fan & Alt.; Ser. No. 3100 & After	4021269	♣9525HD	Hose - Upper; W/2" I.D. Hose		24232
Hose - Upper		24228	Hose - Upper; W/2 1/4" I.D. Hose		24236
Hose - Lower		25484	Hose - Lower		24236
840B Articulated			D30		
Allis-Chalmers 2800 Diesel			Allis-Chalmers 11000 Diesel		
Belt - Fan & Gen.; W/30A. Alt.		TR22461	Belt - Fan	4335865	②TR28583
Hose - Upper		♣20611	Belt - Gen.	4613571	♣9451HD
	or	26511	Belt - P.S.	3029700	②♣9405HD
918			Belt - Air Brake Compr.	4640285	TR28583
Allis-Chalmers 2800 Diesel			Hose - Upper		24236
Belt - Fan & Alt.	252145	♣9525HD	Hose - Lower		24236
Hose - Upper		21256	D40		
	or	26504	Allis-Chalmers 21000H Diesel		
Hose - Lower		26504	Belt - Fan	4348162	②TR28657
940 Articulated			Belt - Gen.	4616583	♣9430HD
Allis-Chalmers 2900 Diesel			Belt - W.P.	4386813	TR22495
Belt - Fan & Alt.	3046916	♣9550HD	Belt - Air Brake Compr.	4612058	TR28514
Hose - Upper		26510	Hose - Upper		②24240
Hose - Lower		26523	Hose - Lower		②24240
AD; AD3; AD4; AD30			M70		
Detroit Diesel 3-71 Diesel; Detroit Diesel 4-71 Diesel			Allis-Chalmers 7000 Diesel		
Belt - Fan	602944	②TR22578	Belt - Fan	4348911	②TR28596
Belt - Gen.; W/Sealed Type Gen.	040549	TR20451	Belt - W.P. & Gen.	4336629	TR28565
Belt - Gen.; W/Ventilated Type Gen.	604929	TR22485	Hose - Upper		23547
Belt - Hyd. Pump	604929	③TR22485	Hose - Lower		23550
Hose - Upper; W/2" I.D. Hose		24232	M100		
Hose - Upper; W/2 1/4" I.D. Hose		24236	Allis-Chalmers 10000 Diesel		
Hose - Lower		24236	Belt - Fan	4348911	②TR28596
AD40			Belt - W.P. & Gen.	4349778	TR28522
Detroit Diesel 3-71 Diesel; Detroit Diesel 4-71 Diesel			Belt - Hyd. Pump; W/44 3/4" Belt O.C.		④TR22443
Belt - Fan	602944	②TR22578	Belt - Hyd. Pump; W/45 7/8" Belt O.C.		④TR22455
Belt - Gen.; W/Sealed Type Gen.	040549	TR20451	Hose - Upper		24236
Belt - Gen.; W/Ventilated Type Gen.	604929	TR22485	Hose - Lower		23550
Belt - Hyd. Pump	604929	③TR22485	M100B		
Hose - Upper; W/2" I.D. Hose		24232	Allis-Chalmers 11000 Diesel		
Hose - Upper; W/2 1/4" I.D. Hose		24236	Hose - Upper		26519
Hose - Lower		24236	Hose - Lower		24940
Detroit Diesel 6-71 Diesel			TL10		
Hose - Upper; Ser. No. 648 & Before		24232	Allis-Chalmers 6-Cyl. 262 Diesel		
Hose - Upper; Ser. No. 649 & After		♣20206	Belt - Fan & Gen.	3026011	②♣9480HD
	or	24232	Belt - P.S.	24834	♣9350HD

②Two Required.
 ♣Cut to Fit.
 ④Four Required.

♣Standard Belt Available.
 ③Three Required.

Belts and Coolant Hose for Road & Construction Equipment

Application	Mfr. Part No.	Our No.	Application	Mfr. Part No.	Our No.
Allis-Chalmers - Continued			Allis-Chalmers - Continued		
TL10 - Continued			TL14A		
Allis-Chalmers 6-Cyl. 262 Diesel - Continued			Allis-Chalmers 6-Cyl. 262		
Belt - V.P.	24834	♣9350HD	Belt - Fan & Gen.	26011	②♣9476HD
Hose - Upper		②24228	Belt - P.S.	24834	♣9350HD
Hose - Lower		②24228	Hose - Upper; Ser. No. 323 & Before		26502
Hose - By Pass		②24216	Hose - Upper; Ser. No. 324 & After		②24228
West Allis 4-Cyl. 226			Hose - Lower; Ser. No. 154 & Before		
Belt - Fan & Gen.; Ser. No. 17-1001M-G			Hose - Lower; Ser. No. 155 & After		
Thru 2502	226935	♣9476HD	Hose - By Pass; Ser. No. 323 & Before		
Belt - Fan & Gen.; Ser. No. 2503 & After	14841	♣9470HD	Hose - By Pass; Ser. No. 324 & After		
Belt - P.S.	24834	♣9350HD			24220
Belt - V.P.	3025960	♣9330HD	TL16		
Hose - Upper		24224	Allis-Chalmers 7000 Diesel		
Hose - Lower		24224	Belt - Fan; Ser. No. 555 Thru 1800		
TL11			Belt - Fan & Gen.; Ser. No. 554 & Before		
West Allis 4-Cyl. 226			Belt - Gen.; Ser. No. 555 Thru 1800		
Belt - Fan & Gen.; W/47 1/4" Belt O.C.	14841	♣9470HD	Belt - W.P. & Gen.; Ser. No. 1801 & After ...		
Belt - Fan & Gen.; W/49" Belt O.C.	5828	TR22485	Belt - P.S.		
Hose - Upper		24224	Belt - V.P.		
Hose - Lower		24224	Hose - Upper; Ser. No. 1801 & After		
TL12			Hose - Lower; Ser. No. 1800 & Before		
Allis-Chalmers 6DA273 Diesel; Allis-Chalmers 6-Cyl. 262 Diesel			Hose - Lower; Ser. No. 1801 & After		
Belt - Fan & Gen.; Ser. No. 2002 & Before .	14841	♣9470HD	Hose - By Pass		
Belt - Fan & Gen.; Ser. No. 2003 & After	3026011	②♣9480HD	TL16A		
Belt - P.S.	24834	♣9350HD	Allis-Chalmers 7000 Diesel		
Belt - V.P.	24834	♣9350HD	Belt - Fan; Ser. No. 205 Thru 554		
Belt - Converter	12990	7300	Belt - Fan; Ser. No. 555 Thru 1800		
Hose - Upper		②24228	Belt - Fan; Ser. No. 1801 & After		
Hose - Lower; Ser. No. 2002 & Before		24224	Belt - W.P. & Gen.; Ser. No. 205 Thru 554 .		
Hose - Lower; Ser. No. 2003 & After		②24228	Belt - P.S.		
Hose - By Pass		24216	Belt - V.P.		
West Allis 4-Cyl. 226			Belt - Converter		
Belt - Fan & Gen.; Ser. No. 45-1001-G &			Hose - Upper; Ser. No. 627 & After		
Before	5828	TR22485	Hose - Lower; Ser. No. 626 & Before		
Belt - Fan & Gen.; Ser. No. 17-1001-M &			Hose - Lower; Ser. No. 627 & After		
After	226935	♣9476HD	TL20		
Belt - Fan & Gen.; Ser. No. 2003 & After	14841	♣9470HD	Allis-Chalmers 10000 Diesel		
Belt - P.S.	24834	♣9350HD	Belt - Fan; Ser. No. 535 & Before		
Belt - V.P.	3025960	♣9330HD	Belt - Fan; Ser. No. 536 & After		
Belt - Converter	13031	TR22485	Belt - W.P. & Gen.; Ser. No. 535 & Before ..		
Hose - Upper		24224	Belt - W.P. & Gen.; Ser. No. 536 Thru 996 .		
Hose - Lower		24224	Belt - Gen.; Ser. No. 997 & After		
TL14			Belt - P.S.		
Allis-Chalmers 6-Cyl. 262			Belt - Air Brake Compr.; Ser. No. 997 &		
Belt - Fan & Gen.; Ser. No. 1524 & Before .	26011	②♣9476HD	After		
Belt - P.S.	25960	♣9330HD	Belt - V.P.; Ser. No. 536 Thru 996		
Hose - Upper		②24228	Hose - Upper; Ser. No. 535 & Before		
Hose - Lower		②24228	Hose - Upper; Ser. No. 536 & After		
Hose - By Pass		②24216	Hose - Lower; Ser. No. 996 & Before		
Allis-Chalmers 6000 Diesel			Hose - Lower; Ser. No. 997 & After		
Belt - Fan; Ser. No. 1525 & After	4339461	②TR28565	Hose - By Pass		
Belt - Fan & Gen.; Ser. No. 101 Thru 1524 .	26011	②♣9476HD	TL30		
Belt - W.P. & Gen.; Ser. No. 1525 & After ...	4347818	TR30543	Allis-Chalmers 11000 Diesel		
Belt - P.S.	3025960	♣9330HD	Belt - Fan		
Belt - V.P.	3024834	♣9350HD	Belt - Gen.		
Hose - Upper; Ser. No. 1524 & Before		②24228	Belt - P.S.		
Hose - Upper; Ser. No. 1525 & After		24236	Belt - Air Brake Compr.		
Hose - Lower; Ser. No. 1524 & Before		②24228	Hose - Upper		
Hose - Lower; Ser. No. 1525 & After		24236	Hose - Lower		
Hose - By Pass		②24216	TL40		
Allis-Chalmers 6-Cyl. 262			Allis-Chalmers 21000H Diesel		
Belt - Fan & Gen.; Ser. No. 1524 & Before .	26011	②♣9476HD	Belt - Fan		
Belt - P.S.	25960	♣9330HD	Belt - W.P.		
Hose - Upper		②24228	Belt - Gen.		
Hose - Lower		②24228	Belt - Fan		
Hose - By Pass		②24216	Belt - Gen.		
Allis-Chalmers 6000 Diesel			Belt - Fan		
Belt - Fan; Ser. No. 1525 & After	4339461	②TR28565	Belt - Gen.		
Belt - Fan & Gen.; Ser. No. 101 Thru 1524 .	26011	②♣9476HD	Belt - P.S.		
Belt - W.P. & Gen.; Ser. No. 1525 & After ...	4347818	TR30543	Belt - Air Brake Compr.		
Belt - P.S.	3025960	♣9330HD	Hose - Upper		
Belt - V.P.	3024834	♣9350HD	Hose - Lower		
Hose - Upper; Ser. No. 1524 & Before		②24228	TL40		
Hose - Upper; Ser. No. 1525 & After		24236	Allis-Chalmers 21000H Diesel		
Hose - Lower; Ser. No. 1524 & Before		②24228	Belt - Fan		
Hose - Lower; Ser. No. 1525 & After		24236	Belt - W.P.		
Hose - By Pass		②24216	Belt - Gen.		
Allis-Chalmers 6000 Diesel			Belt - Fan		
Belt - Fan; Ser. No. 1525 & After	4339461	②TR28565	Belt - W.P.		
Belt - Fan & Gen.; Ser. No. 101 Thru 1524 .	26011	②♣9476HD	Belt - Gen.		
Belt - W.P. & Gen.; Ser. No. 1525 & After ...	4347818	TR30543	Belt - Fan		
Belt - P.S.	3025960	♣9330HD	Belt - Gen.		
Belt - V.P.	3024834	♣9350HD	Belt - Fan		
Hose - Upper; Ser. No. 1524 & Before		②24228	Belt - Gen.		
Hose - Upper; Ser. No. 1525 & After		24236	Belt - Fan		
Hose - Lower; Ser. No. 1524 & Before		②24228	Belt - Gen.		
Hose - Lower; Ser. No. 1525 & After		24236	Belt - Fan		
Hose - By Pass		②24216	Belt - Gen.		

②Two Required.

♣Standard Belt Available.

Road & Construction Equipment

Belts and Coolant Hose for Road & Construction Equipment

 Road & Construction
Equipment

Application	Mfr. Part No.	Our No.	Application	Mfr. Part No.	Our No.
Allis-Chalmers - Continued			American Crane Corp. - Continued		
TL40 - Continued			35		
Allis-Chalmers 21000H Diesel - Continued			Detroit Diesel 6V-71 Diesel		
Belt - Air Brake Compr.	4612058	TR28514	Belt - Fan		③♣9510HD
Hose - Upper		②24240	Belt - Alt.		②9279
Hose - Lower		②24240	597C		
TL545			Detroit Diesel 4-71 Diesel		
Allis-Chalmers 2800 Diesel			Belt - Fan		
Belt - Fan	4020984	♣9545HD	Belt - Gen.	5170972	②TR22455
TR260			Belt - Alt.	5133515	♣9370HD
Allis-Chalmers 16000 Diesel			5530		
Belt - Fan & Air Brake Compr.	4372752	②TR28786	Detroit Diesel 4-71 Diesel		
Belt - W.P.	4356965	TR28583	Belt - Fan - Upper Structure		
Belt - Gen.	4372798	TR28545	Belt - Alt. - Upper Structure	5140928	②♣9640HD
Hose - Upper		24240	Detroit Diesel 6-71 Diesel		
Hose - Lower		24940	Belt - Fan & Air Brake Compr. - Lower		
TS160			Structure	5136265	②♣9690HD
Allis-Chalmers TDS516 Diesel			Belt - Alt. - Lower Structure	5145150	♣9430HD
Belt - Fan	4335177	②TR28657	Arrow-Master, Inc.		
Belt - Gen.	4335242	TR28423	HG1250		
Belt - Air Brake Compr.	4341903	TR28473	Ford 6-Cyl. 240		
Belt - Supercharger	4348693	③TR22553	Belt - Fan		
Hose - Upper		24240	Belt - W.P. To Alt.		
Hose - Lower		24240	HJ1250R		
Hose - By Pass		24230	John Deere 4219D Diesel		
TS200			Belt - Fan & Alt.		
Allis-Chalmers TD779 Diesel			Hose - Upper		
Belt - Fan	73889	②TR28406	TR22485		
Belt - W.P.	S2861	TR22434	♣20957		
TS260			Austin-Western		
Allis-Chalmers 15000 Diesel			40		
Belt - Fan & Air Brake Compr.	4372752	②TR28786	IH GAD223		
Belt - W.P.	4356965	TR28583	Belt - W.P. & Gen.		
Belt - Gen.	4372798	TR28545	Belt - Hyd. Pump	ASF5923	TR30408
Allis-Chalmers 16000 Diesel; Allis-Chalmers TD844 Diesel			ASF6087		
Belt - Fan & Air Brake Compr.	4372752	②TR28786	IH SD240 Diesel		
Belt - W.P.	4356965	TR28583	Belt - W.P. & Alt.; W/40A. Alt.		
Belt - Gen.	4372798	TR28545	Belt - W.P. & Alt.; W/50A. Alt.	81572R1	TR28437
Hose - Upper; 2nd Design		24240	Belt - Hyd. Pump	78010R1	TR28445
Hose - Lower; 2nd Design		24940	TR30589		
TS360			IH UB240		
Allis-Chalmers 21000 Diesel			Belt - W.P. & Gen.		
Belt - Fan & Air Brake Compr.; Ser. No.			Belt - Hyd. Pump	ASF6262	TR28445
2000 & Before	4616613	③TR28743	TR28570		
Belt - Fan & Air Brake Compr.; Ser. No.			55		
2001 & After	4372752	③TR28786	IH IU4		
Belt - Gen.; Ser. No. 2000 & Before; W/39			Belt - Fan		
5/8" Belt O.C.	4374914	TR22392	Belt - Gen.	48032D	TR28386
Belt - Gen.; Ser. No. 2000 & Before; W/40			Belt - Hyd. Pump	48878D	♣9313HD
1/8" Belt O.C.	4014631	TR22397	TR28333		
Belt - Gen.; Ser. No. 2001 & After	4372798	TR28545	60		
Hose - Upper; Ser. No. 2001 & After		24240	IH BD264 Diesel		
Hose - Lower		24240	Belt - Fan & Gen.		
American Crane Corp.			ASF6262		
25			TR28445		
Detroit Diesel 6V-53 Diesel			66		
Belt - Fan	5126763	②♣9400HD	Buda 6DT275 Diesel		
Belt - W.P. & Idler	5139228	②7370	Belt - Fan		
Belt - Alt.		②7360	Belt - Hyd. Pump	PGF3062	TR32571
25			PGF3058		
Detroit Diesel 6V-53 Diesel			TR30408		
25			77		
Detroit Diesel 6V-53 Diesel			McD. PD30		
Belt - Fan	5126763	②♣9400HD	Belt - Fan		
Belt - W.P. & Idler	5139228	②7370	Belt - Hyd. Pump		
Belt - Alt.		②7360	TR34506		
25			TR30467		

②Two Required.
③Three Required.

♣Standard Belt Available.
♣<Cut to Fit.

Belts and Coolant Hose for Road & Construction Equipment

Application	Mfr. Part No.	Our No.	Application	Mfr. Part No.	Our No.
Austin-Western - Continued			Austin-Western - Continued		
77 - Continued			210 - Continued		
McD. PD40			Ford 6-Cyl. 332		
Belt - Fan		TR32571	Belt - Hyd. Pump; W/5" Dia. Pulley	HCF6060	TR28423
Belt - Gen.	PGF3061	TR22553	Belt - Hyd. Pump; W/6 1/2" Dia. Pulley	PGF3057	TR28454
Belt - Hyd. Pump	PGF3055	TR28583	Hose - Upper		26612
83			Hose - Lower; Molded Hose		≅20523
Detroit Diesel 2-71 Diesel			Hose - Lower; Strt. Hose		24232
Belt - Gen.	5166844	②TR22625	IH UB264		
Belt - Gov.	WRF1166	♣9350HD	Belt - Gen.	HCF7443	♣9451HD
Belt - Hyd. Pump	PGF7307	TR28522	Belt - Hyd. Pump	PGF12161	TR30448
Ford 6-Cyl. 272			Hose - Upper		26509
Belt - Gen.	B6T 8620 A	♣9451HD	Hose - Lower		26508
Belt - Gov.	WRF1166	♣9350HD	IH UD282 Diesel		
Belt - Hyd. Pump	PGF7307	TR28522	Belt - Fan & Gen.; W/Std. Gen.	53934HA	TR32491
99SW			Belt - Fan & Gen.; W/H.D. Gen.	PGF12037	TR30484
Detroit Diesel 3055 Diesel; Detroit Diesel 3080 Diesel			Hose - Upper		26509
Belt - Fan	PGF12200	②TR22517	Hose - Lower		24232
Belt - Gen.	PGF13820	TR28390	410		
Belt - Hyd. Pump	PGF12357	TR28492	Detroit Diesel 3-71 Diesel		
Detroit Diesel 4080 Diesel			Belt - Fan	HCF6230	TR24562
Belt - Fan	5176420	②TR22588	Belt - Gen.	PGF13820	TR28390
Belt - Gen.	PGF13820	TR28390	Belt - Hyd. Pump	PGF15154	TR28492
Belt - Hyd. Pump	PGF14558	TR28522	Hose - Upper		26603
102			Hose - Lower		24228
Detroit Diesel 2-71 Diesel			Ford 6-Cyl. 332		
Belt - Gen.	5166844	②TR22625	Belt - Hyd. Pump	HCF6060	TR28423
Belt - Gov.	WRF1166	♣9350HD	Hose - Upper		26612
Belt - Hyd. Pump	PGF7307	TR28522	Hose - Lower; Molded Hose		≅20523
Ford 6-Cyl. 272			Hose - Lower; Strt. Hose		24232
Belt - Gen.	B6T 8620 A	♣9451HD	IH UB264		
Belt - Gov.	WRF1166	♣9350HD	Belt - Fan	HCF7443	♣9451HD
Belt - Hyd. Pump	PGF7307	TR28522	Belt - Gen.		♣9447HD
110			Belt - Hyd. Pump	PGF12161	TR30448
Ford 6-Cyl. 240			Hose - Upper		26509
Belt - Fan	HCF7293	7512	Hose - Lower		26508
Belt - Hyd. Pump	HCF6774	♣9463HD	714		
Hose - Upper		25480	Detroit Diesel 4-53 Diesel		
122			Belt - Fan		②♣9470HD
Detroit Diesel 2-71 Diesel			Belt - W.P. & Alt.		②7410
Belt - Gen.	5166844	②TR22625	Hose - Upper		26509
Belt - Gov.	WRF1166	♣9350HD	Hose - Lower		26507
Belt - Hyd. Pump	PGF7307	TR28522	720		
Ford 6-Cyl. 272			Detroit Diesel 6V-53 Diesel		
Belt - Gen.	B6T 8620 A	♣9451HD	Belt - Fan & Air Brake Compr.	5135942	②♣9550HD
Belt - Gov.	WRF1166	♣9350HD	Belt - W.P.	5139228	②7370
Belt - Hyd. Pump	PGF7307	TR28522	Belt - Alt.	5133177	②7370
210			Hose - Upper - Left Side		26506
Ford 6-Cyl. 272			Hose - Upper - Right Side		26506
Belt - Hyd. Pump; W/5" Dia. Pulley	HCF6060	TR28423	Hose - Lower		26508
Belt - Hyd. Pump; W/6 1/2" Dia. Pulley	PGF3057	TR28454	Badger Shovel		
Hose - Upper		②24224	IH WD9		
Hose - Lower		②24228	Belt - Gen.	PGF8422	9300
Ford 6-Cyl. 317			CADET		
Belt - Hyd. Pump; W/5" Dia. Pulley	HCF6060	TR28423	IH GRD233		
Belt - Hyd. Pump; W/6 1/2" Dia. Pulley	PGF3057	TR28454	Belt - Fan	AJF3438	TR28390
Hose - Upper		24232	Belt - Hyd. Pump	AJF2476	TR28693
Hose - Lower		24234	G12		
or		26612	IH U269; IH U282		
			Hose - Upper		26509

②Two Required.
≅Cut to Fit.

♣Standard Belt Available.

Road & Construction Equipment

Belts and Coolant Hose for Road & Construction Equipment

Application	Mfr. Part No.	Our No.	Application	Mfr. Part No.	Our No.
Austin-Western - Continued			Austin-Western - Continued		
G12 - Continued			Pacer 300 - Continued		
IH U269; IH U282 - Continued			IH UD14A Diesel		
Hose - Lower		24232	Belt - Fan	PGF3062	TR32571
IH UV345			Belt - Gen.	PGF8422	9300
Hose - Upper		26525	Hose - Upper		26522
Hose - Lower		26523	Hose - Lower		24232
Pacer 100			Pacer 301		
Cummins JN130 Diesel			Detroit Diesel 4-71 Diesel		
Belt - Fan	70888	②▲9360HD	Belt - Fan		②▲9530HD
Belt - W.P.	101427	TR22299	Belt - Alt.		▲9590HD
Belt - Gen.	70885	TR22495	Hose - Upper		26511
Belt - Hyd. Pump	PGF15156	TR28522	Hose - Lower		26510
Hose - Upper		26509	Pacer 400		
Hose - Lower		26522	Cummins C160 Diesel		
Detroit Diesel 3-71 Diesel			Detroit Diesel 4-71 Diesel		
Belt - Fan	PGF17680	②TR22514	Belt - Fan	124466	②TR24365
Belt - Gen.	PGF13820	TR28390	Belt - W.P.	101427	TR22299
Belt - Gov.	PGF16698	▲9480HD	Belt - Gen.; W/46 5/8" Belt O.C.	70885	TR22461
Belt - Hyd. Pump	PGF15154	TR28492	Belt - Gen.; W/47 7/8" Belt O.C.	106070	TR22474
Hose - Upper		26512	Belt - Gov.	PGF15971	▲9463HD
Hose - Lower		26511	Belt - Hyd. Pump	PGF15156	TR28522
Pacer 200			Detroit Diesel 4-71 Diesel		
Cummins JN130 Diesel			Detroit Diesel 4-71 Diesel		
Belt - Fan	70888	②▲9360HD	Belt - Fan; W/52 1/4" Belt O.C.		②▲9520HD
Belt - W.P.	101427	TR22299	Belt - Fan; W/59 1/8" Belt O.C.	5176420	②TR22588
Belt - Gen.	70885	TR22461	Belt - Alt.		▲9380HD
Belt - Hyd. Pump	PGF15156	TR28522	Belt - Gen.	PGF13820	TR28390
Hose - Upper		26509	Belt - Gov.; W/Allison Trans.	PGF16698	▲9480HD
Hose - Lower		26522	Belt - Gov.; W/Torcson Trans.	PGF15971	▲9463HD
Detroit Diesel 3-71 Diesel			Belt - Hyd. Pump; W/1/2" Belt T.W.; W/52 1/4" Belt O.C. ...		②▲9520HD
Belt - Fan	PGF17680	②TR22514	Belt - Hyd. Pump; W/1/2" Belt T.W.; W/53		
Belt - Gen.	PGF13820	TR28390	1/4" Belt O.C.	PGF16985	②▲9530HD
Belt - Gov.	PGF16698	▲9480HD	Belt - Hyd. Pump; W/21/32" Belt T.W.;		
Belt - Hyd. Pump	PGF15154	TR28492	W/52 7/8" Belt O.C.	PGF15156	TR28522
Hose - Upper		26512	Hose - Upper		26509
Hose - Lower		26511	Hose - Lower		26509
Pacer 300			Pacer 500		
Cummins C160 Diesel			Detroit Diesel 6V-71 Diesel		
Belt - Fan	124466	②TR24365	Belt - Fan	5176420	②TR22588
Belt - W.P.	101427	TR22299	Belt - Gen.	PGF17017	▲9380HD
Belt - Gen.; W/46 5/8" Belt O.C.	70885	TR22461	Belt - Gov.	PGF15971	▲9463HD
Belt - Gen.; W/47 7/8" Belt O.C.	106070	TR22474	Belt - Hyd. Pump	PGF16984	▲9530HD
Belt - Gov.	PGF15971	▲9463HD	Hose - Upper		26523
Belt - Hyd. Pump	PGF15156	TR28522	Hose - Lower		②24244
Hose - Upper		26509	PR11		
Hose - Lower		26522	Ford 6-Cyl. 223		
Detroit Diesel 4-71 Diesel			Ford 6-Cyl. 223		
Belt - Fan; W/52 1/4" Belt O.C.		②▲9520HD	Belt - Fan; W/38 1/8" Belt O.C.		7380
Belt - Fan; W/59 1/8" Belt O.C.	5176420	②TR22588	Belt - Fan; W/40 1/8" Belt O.C.	B7PZ 8620 A	7400
Belt - Alt.		▲9380HD	Belt - Gen.	EAG 8620 B	7360
Belt - Gen.	PGF13820	TR28390	Belt - Hyd. Pump	PGF15971	▲9463HD
Belt - Gov.; W/Allison Trans.	PGF16698	▲9480HD	Hose - Upper		24224
Belt - Gov.; W/Torcson Trans.	PGF15971	▲9463HD	Super 100; Super 200		
Belt - Hyd. Pump; W/1/2" Belt T.W.; W/52 1/4" Belt O.C. ...		②▲9520HD	Cummins JN130 Diesel		
Belt - Hyd. Pump; W/1/2" Belt T.W.; W/53			Belt - Fan	70888	②▲9360HD
1/4" Belt O.C.	PGF16985	②▲9530HD	Belt - W.P.	101427	TR22299
Belt - Hyd. Pump; W/21/32" Belt T.W.;			Belt - Gen.	70885	TR22461
W/52 7/8" Belt O.C.	PGF15156	TR28522	Belt - Hyd. Pump	PGF15156	TR28522
Hose - Upper; W/12" Hose		26508	Hose - Upper		26509
Hose - Upper; W/17" Hose		26510	Hose - Lower		26522
Hose - Lower; W/8 3/4" Hose		24232	Detroit Diesel 3-71 Diesel		
Hose - Lower; W/12" Hose		26508	Detroit Diesel 3-71 Diesel		
			Belt - Fan	PGF17680	②TR22514

▲Standard Belt Available.

②Two Required.

Belts and Coolant Hose for Road & Construction Equipment

Application	Mfr. Part No.	Our No.	Application	Mfr. Part No.	Our No.
Austin-Western - Continued			Austin-Western - Continued		
Super 100; Super 200 - Continued			Super 500		
Detroit Diesel 3-71 Diesel - Continued			Detroit Diesel 6V-71 Diesel		
Belt - Gen.	PGF13820	TR28390	Belt - Fan	5176420	②TR22588
Belt - Gov.	PGF16698	♣9480HD	Belt - Gen.	PGF17017	♣9380HD
Belt - Hyd. Pump	PGF15154	TR28492	Belt - Gov.	PGF15971	♣9463HD
Hose - Upper		26512	Belt - Hyd. Pump	PGF16984	♣9530HD
Hose - Lower		26511	Hose - Upper		26523
Super 300			T53		
Cummins C160 Diesel			Detroit Diesel 2-71 Diesel		
Belt - Fan	124466	②TR24365	Hose - Upper		②25473
Belt - W.P.	101427	TR22299	Ford 6-Cyl. 272		
Belt - Gen.; W/46 5/8" Belt O.C.	70885	TR22461	Belt - Fan	WRF1128	TR24461
Belt - Gen.; W/47 7/8" Belt O.C.	106070	TR22474	Belt - Gen.		♣9451HD
Belt - Gov.	PGF15971	♣9463HD	Belt - Gov.	WRF1166	♣9350HD
Belt - Hyd. Pump	PGF15156	TR28522	Belt - Hyd. Pump	PGF7307	TR28522
Hose - Upper		26509	Hose - Upper		25473
Hose - Lower		26522	T84; T104		
Detroit Diesel 4-71 Diesel			Detroit Diesel 2-71 Diesel		
Belt - Fan; W/52 1/4" Belt O.C.		②♣9520HD	Hose - Upper		②25473
Belt - Fan; W/59 1/8" Belt O.C.	5176420	②TR22588	Ford 6-Cyl. 272		
Belt - Alt.		♣9380HD	Belt - Fan	WRF1128	TR24461
Belt - Gen.	PGF13820	TR28390	Belt - Gen.		♣9451HD
Belt - Gov.; W/Allison Trans.	PGF16698	♣9480HD	Belt - Gov.	WRF1166	♣9350HD
Belt - Gov.; W/Torcson Trans.	PGF15971	♣9463HD	Belt - Hyd. Pump	PGF7307	TR28522
Belt - Hyd. Pump; W/1/2" Belt T.W.; W/52 1/4" Belt O.C. ...		②♣9520HD	Hose - Upper		25480
Belt - Hyd. Pump; W/1/2" Belt T.W.; W/53 1/4" Belt O.C.	PGF16985	②♣9530HD	T1386		
Belt - Hyd. Pump; W/21/32" Belt T.W.; W/52 7/8" Belt O.C.	PGF15156	TR28522	Continental 6-Cyl.		
Hose - Upper; W/12" Hose		26508	Hose - Upper		24230
Hose - Upper; W/17" Hose		26510	Hose - Lower		♣21794
Hose - Lower; W/8 3/4" Hose		24232		or	25474
Hose - Lower; W/12" Hose		26508	Detroit Diesel 2-71 Diesel		
IH UD14A Diesel			Belt - Gen.	5166844	②TR22625
Belt - Fan	PGF3062	TR32571	Belt - Gov.	WRF1166	♣9350HD
Belt - Gen.	PGF8422	9300	Belt - Hyd. Pump	PGF7307	TR28522
Hose - Upper		26522	Badger		
Hose - Lower		24232	1085C		
Super 400			Cummins 6-Cyl. 5.9 L Diesel		
Cummins C160 Diesel			Belt - Fan, Alt. & W.P.		♣K080560HD
Belt - Fan	124466	②TR24365	Bantam		
Belt - W.P.	101427	TR22299	304		
Belt - Gen.; W/46 5/8" Belt O.C.	70885	TR22461	Ford V-8 330		
Belt - Gen.; W/47 7/8" Belt O.C.	106070	TR22474	Belt - Fan & Alt. - Lower Structure		②♣9430HD
Belt - Gov.	PGF15971	♣9463HD	Belt - Compr. - Lower Structure		♣9525HD
Belt - Hyd. Pump	PGF15156	TR28522	Belt - Hyd. Pump - Lower Structure		♣9425HD
Hose - Upper		26509	Hose - Upper - Lower Structure		26611
Hose - Lower		26522	Hose - Lower - Lower Structure		26504
Detroit Diesel 4-71 Diesel			424		
Belt - Fan; W/52 1/4" Belt O.C.		②♣9520HD	Chrysler LB318 Diesel		
Belt - Fan; W/59 1/8" Belt O.C.	5176420	②TR22588	Belt - Fan & Alt. - Lower Structure	1614690	♣9440HD
Belt - Alt.		♣9380HD	Belt - Fan, Compr. & Idler - Lower Structure		7625
Belt - Gen.	PGF13820	TR28390	Belt - Fan To Hyd. Pump - Lower Structure		②♣9435HD
Belt - Gov.; W/Allison Trans.	PGF16698	♣9480HD	Hose - Upper - Lower Structure		26612
Belt - Gov.; W/Torcson Trans.	PGF15971	♣9463HD	Hose - Lower - Lower Structure		26611
Belt - Hyd. Pump; W/1/2" Belt T.W.; W/52 1/4" Belt O.C. ...		②♣9520HD	IH DV549 Diesel		
Belt - Hyd. Pump; W/1/2" Belt T.W.; W/53 1/4" Belt O.C.	PGF16985	②♣9530HD	Belt - Fan & Idler - Lower Structure	133500R1	②TR22434
Belt - Hyd. Pump; W/21/32" Belt T.W.; W/52 7/8" Belt O.C.	PGF15156	TR28522			
Hose - Upper		26509			
Hose - Lower		26509			

♣Standard Belt Available.
♣<Cut to Fit.

②Two Required.

Belts and Coolant Hose for Road & Construction Equipment

Application	Mfr. Part No.	Our No.	Application	Mfr. Part No.	Our No.
Bantam - Continued			Bantam - Continued		
424 - Continued			T725A Teleskoop - Continued		
IH DV549 Diesel - Continued			Detroit Diesel 4-53 Diesel - Continued		
Belt - Fan To Compr. & Alt. - Lower Structure	243605R2	②♣9451HD ②TR22425	Hose - Lower		26509
Belt - Hyd. Pump - Lower Structure		②26611	Detroit Diesel 4-71 Diesel		
Hose - Upper - Lower Structure			Belt - Fan	5119188	②♣9390HD
C166			Belt - W.P. & Gen.	5133174	②7405
Detroit Diesel 4-53 Diesel			Hose - Upper		26511
Belt - Fan	5119188	②♣9390HD	Hose - Lower		26509
Belt - W.P. & Gen.		②7410	TD588 Telekrane		
Hose - Upper		26511	Detroit Diesel 4-53 Diesel		
C266			Belt - Fan	5119188	②♣9390HD
Detroit Diesel 4-71 Diesel			Belt - W.P. & Gen.	5133174	②7405
Belt - Fan	5130528	②♣9451HD	Hose - Upper		26511
Belt - Alt.	5140928	♣9400HD	Hose - Lower		26511
Hose - Upper		26511	Barber-Greene		
Hose - Lower		26509	2		
C366			Hercules IXE		
Detroit Diesel 6V-53 Diesel			Belt - Fan		②TR24489
Belt - Fan	5126763	②♣9400HD	38D		
Belt - Alt.		♣9375HD	Buda HP217		
Hose - Upper		②25482	Belt - Fan		TR28514
Hose - Lower		26511	44		
C451			Buda K393		
Detroit Diesel 4-53 Diesel			Belt - Fan		TR30467
Belt - Fan	5119188	②♣9390HD	82A		
Belt - W.P. & Gen.	5133174	②7405	Buda HP217		
Hose - Upper		26511	Belt - Fan		TR28514
Hose - Lower		26523	Chrysler T118		
C475			Belt - Fan & Gen.		TR24500
Detroit Diesel 4-71 Diesel			IH UD281.4 Diesel		
Belt - Fan		②♣9451HD	Belt - Fan	16131DA	TR30467
Belt - Gen.		♣9370HD	Belt - Gen.	52318DA	9279
Hose - Upper		26510	82AG		
Hose - Lower		26509	Buda HP298; Buda HP326		
S588 Telekruiser			Belt - Belt; W/55 1/8" Belt O.C.	H12096	TR28545
Detroit Diesel 4-53 Diesel			552; 705		
Belt - Fan & Hyd. Pump	5136273	②♣9510HD	IH UD281.4 Diesel		
Belt - W.P. & Alt.	5133172	②7430	Belt - Fan	16131DA	TR30467
Hose - Upper		26612	Belt - Gen.	52318DA	9279
S626 Telekruiser; S628 Telekruiser			774		
Detroit Diesel 4-53 Diesel			Detroit Diesel 3-71 Diesel		
Belt - Alt.		7300	Belt - Fan; W/Low Mount Fan	5170972	②TR22455
Belt - W.P. & Idler		②7365	Belt - Gen.; W/12V. Gen.	3224367	TR28390
Belt - Fan & Hyd. Pump		②♣9451HD	Belt - Gen.; W/24V. Gen.	5155911	TR24400
Hose - Upper		24228	Belt - Compr.	3224451	TR34700
Hose - Lower		26611	777		
T644 Teleskoop			Caterpillar D333 Diesel		
Detroit Diesel 3-53 Diesel			Belt - Fan		②♣9600HD
Belt - Fan - Upper Structure		②♣9412HD	Belt - Fan & Gen.		♣9447HD
Belt - W.P. & Gen. - Upper Structure	5133174	②7405	Hose - Upper		24440
Hose - Upper - Upper Structure		26512	Hose - Lower		24438
Hose - Lower - Upper Structure		26512	T725A Teleskoop		
T725A Teleskoop			Detroit Diesel 4-53 Diesel		
Detroit Diesel 4-53 Diesel			Belt - Fan		②♣9313HD
Belt - Fan		②♣9313HD	Belt - W.P. & Gen.		②7405
Belt - W.P. & Gen.		②7405	Hose - Upper		24232
Hose - Upper		24232			

②Two Required.

♣Standard Belt Available.

Belts and Coolant Hose for Road & Construction Equipment

Application	Mfr. Part No.	Our No.	Application	Mfr. Part No.	Our No.
Barber-Greene - Continued			Bay City - Continued		
835; 837; 838; 845; 847; 848A			15A		
Detroit Diesel 3-71 Diesel; Detroit Diesel 4-71 Diesel; Detroit Diesel 6-71 Diesel			IH U21		
Belt - Fan; W/42 3/4" Belt O.C.	5119186	♣9425HD	Belt - Belt; W/49 3/4" Belt O.C.	22705D	TR32491
Belt - Fan; W/46 1/8" Belt O.C.	5170972	②TR22455	20; 25		
Belt - Gen.; W/12V. Gen.	5108883	♣9365HD	Caterpillar 4400 Diesel		
Belt - Gen.; W/24V. Gen.	5125811	♣9380HD	Belt - Belt; W/46" Belt O.C.	6B1039	TR34456
850			Hercules DJXB Diesel; Hercules DJXC Diesel		
IH UD281.4 Diesel			Belt - Belt; W/41 1/4" Belt O.C.	40276A	TR30408
Belt - Fan	16131DA	TR30467	IH U21		
Belt - Gen.	52318DA	9279	Belt - Belt; W/49 3/4" Belt O.C.	22705D	TR32491
852; 857			30		
Detroit Diesel 3-71 Diesel; Detroit Diesel 4-71 Diesel; Detroit Diesel 6-71 Diesel			Caterpillar D4400 Diesel		
Belt - Fan; W/42 3/4" Belt O.C.	5119186	♣9425HD	Belt - Gov.	2A4062	♣9385HD
Belt - Fan; W/46 1/8" Belt O.C.	5170972	②TR22455	Belt - Fan	6B1039	TR34456
Belt - Gen.; W/12V. Gen.	5108883	♣9365HD	IH U21		
Belt - Gen.; W/24V. Gen.	5125811	♣9380HD	Belt - Belt; W/49 3/4" Belt O.C.	22705DA	TR32491
D			32		
Le Roi			Caterpillar D4600 Diesel		
Belt - Fan & Gen.		TR22416	Belt - Gov.	4B2544	♣9425HD
F48			Hercules DJXC Diesel		
IH UD18			Belt - Belt; W/41 1/4" Belt O.C.	40276A	TR30408
Belt - Belt; W/63 3/4" Belt O.C.	251180R1	TR28628	33		
SA41			Caterpillar D4600 Diesel		
IH D282 Diesel			Belt - Gov.	4B2544	♣9425HD
Belt - Fan & Alt.	610363C1	♣9530HD	37		
TA77			Buda K428		
Caterpillar 3306T Diesel			Belt - Belt; W/47 1/8" Belt O.C.	1624	TR30467
Belt - Fan & Alt.	5L8312	③♣9540HD	45; 60		
Hose - Lower - Eng. To Pipe		24440	Detroit Diesel 3-71 Diesel; Detroit Diesel 4-71 Diesel; Detroit Diesel 6-71 Diesel		
Hose - Lower - Pipe To Rad.		24440	Belt - Fan; W/Low Mount Fan; W/46 1/8" Belt O.C.; W/3/4 Thru 1 1/2 Yard Crawler	5170972	②TR22455
Caterpillar D333C Diesel			Belt - Fan; W/High Mount Fan; W/59 1/8" Belt O.C.; W/3/4 Thru 1 1/2 Yard Crawler	5176420	②TR22588
Belt - Fan & Alt.	5L8312	③♣9540HD	Belt - Fan; W/High Mount Fan; W/70 1/4" Belt O.C.; W/3/4 Thru 1 1/2 Yard Crawler	3224451	TR34700
Hose - Upper		26531	Belt - Fan; W/High Mount Fan; W/74 1/2" Belt O.C.; W/3/4 Thru 1 1/2 Yard Crawler	5175105	②BX71
Hose - Lower		②24440	Belt - Gen.; W/12V. Gen.; W/3/4 Thru 1 1/2 Yard Crawler	3224367	TR28390
TC30			Belt - Gen.; W/12V., 250W. Gen.; W/3/4 Thru 1 1/2 Yard Crawler	5164293	TR22322
Detroit Diesel 3-53 Diesel			Belt - Gen.; W/24V. Gen.; W/3/4 Thru 1 1/2 Yard Crawler	5155911	TR24400
Belt - Fan		②♣9412HD	62		
Belt - W.P. & Gen.		②7405	IH PA100		
Hose - Upper		≈<21794	Belt - Belt; W/54 5/8" Belt O.C.	30748H	②TR30543
	or	25474	63; 72		
Hose - Lower		②24230	Detroit Diesel 3-71 Diesel; Detroit Diesel 4-71 Diesel; Detroit Diesel 6-71 Diesel		
Bay City			Belt - Fan; W/Low Mount Fan; W/46 1/8" Belt O.C.; W/3/4 Thru 1 1/2 Yard Crawler	5170972	②TR22455
10					
Hercules JHC					
Belt - Belt; W/43 1/2" Belt O.C.	30003	TR28429			
Waukesha 6BK					
Belt - Belt; W/47 1/8" Belt O.C.	27948	TR30467			
15					
Hercules JXD					
Belt - Belt; W/41 1/8" Belt O.C.	40352A	TR28406			

②Two Required.
③Three Required.

♣Standard Belt Available.
≈<Cut to Fit.

Belts and Coolant Hose for Road & Construction Equipment

Application	Mfr. Part No.	Our No.	Application	Mfr. Part No.	Our No.
Bay City - Continued			Bay City - Continued		
63; 72 - Continued			450 - Continued		
Detroit Diesel 3-71 Diesel; Detroit Diesel 4-71 Diesel; Detroit Diesel 6-71 Diesel - Continued			Detroit Diesel 3-71 Diesel - Continued		
Belt - Fan; W/High Mount Fan; W/59 1/8" Belt O.C.; W/3/4 Thru 1 1/2 Yard Crawler	5176420	②TR22588	Belt - Gen.; W/12V., 250W. Gen.	5164293	TR22322
Belt - Fan; W/High Mount Fan; W/70 1/4" Belt O.C.; W/3/4 Thru 1 1/2 Yard Crawler	3224451	TR34700	Belt - Gen.; W/24V. Gen.	5155911	TR24400
Belt - Fan; W/High Mount Fan; W/74 1/2" Belt O.C.; W/3/4 Thru 1 1/2 Yard Crawler	5175105	②BX71	535		
Belt - Gen.; W/12V. Gen.; W/3/4 Thru 1 1/2 Yard Crawler	3224367	TR28390	Detroit Diesel 3-71 Diesel; Detroit Diesel 4-71 Diesel		
Belt - Gen.; W/12V., 250W. Gen.; W/3/4 Thru 1 1/2 Yard Crawler	5164293	TR22322	Belt - Fan; W/Low Mount Fan; W/46 1/8" Belt O.C.	5170972	②TR22455
Belt - Gen.; W/24V. Gen.; W/3/4 Thru 1 1/2 Yard Crawler	5155911	TR24400	Belt - Fan; W/High Mount Fan; W/70 1/4" Belt O.C.	3224451	TR34700
151-T41			Belt - Fan; W/High Mount Fan; W/74 1/2" Belt O.C.	5175105	②BX71
Detroit Diesel 2-71 Diesel			Belt - Gen.; W/12V. Gen.	3224367	TR28390
Belt - Fan; W/Truck Mtd. Shovel	5166844	TR22625	Belt - Gen.; W/12V., 250W. Gen.	5164293	TR22322
Belt - Gen.; W/24V. Gen.; W/Truck Mtd. Shovel	5166844	TR22625	Belt - Gen.; W/24V. Gen.	5155911	TR24400
Belt - Compr.; W/Truck Mtd. Shovel	5168993	TR24515	600		
Detroit Diesel 4-71 Diesel			Detroit Diesel 3-71 Diesel		
Belt - Gen.; W/Truck Mtd. Shovel	3224367	TR30408	Belt - Fan; W/Low Mount Fan; W/46 1/8" Belt O.C.	5170972	②TR22455
180; 185			Belt - Fan; W/High Mount Fan; W/70 1/4" Belt O.C.	3224451	TR34700
Waukesha 6SRKR			Belt - Fan; W/High Mount Fan; W/74 1/2" Belt O.C.	5175105	②BX71
Belt - Gen.	78382	TR34545	Belt - Gen.; W/12V. Gen.; W/Truck Mtd. Crane	3224367	TR28390
190-T52; 190-T6430			Belt - Gen.; W/12V., 250W. Gen.; W/Truck Mtd. Crane	5164293	TR22322
Detroit Diesel 3-71 Diesel; Detroit Diesel 4-71 Diesel; Detroit Diesel 6-71 Diesel			Belt - Gen.; W/24V. Gen.; W/Truck Mtd. Crane	5155911	TR24400
Belt - Fan; W/Low Mount Fan; W/46 1/8" Belt O.C.; W/Truck Mtd. Crane	5170972	②TR22455	720		
Belt - Fan; W/High Mount Fan; W/70 1/4" Belt O.C.; W/Truck Mtd. Crane	3224451	TR34700	Detroit Diesel 6-71 Diesel		
Belt - Fan; W/High Mount Fan; W/74 1/2" Belt O.C.; W/Truck Mtd. Crane	5175105	②BX71	Belt - Fan; W/Low Mount Fan; W/46 1/8" Belt O.C.	5170972	②TR22455
Belt - Gen.; W/12V. Gen.; W/Truck Mtd. Crane	3224367	TR28390	Belt - Fan; W/High Mount Fan; W/70 1/4" Belt O.C.	3224451	TR34700
Belt - Gen.; W/12V., 250W. Gen.; W/Truck Mtd. Crane	5164293	TR22322	Belt - Fan; W/High Mount Fan; W/74 1/2" Belt O.C.	5175105	②BX71
Belt - Gen.; W/24V. Gen.; W/Truck Mtd. Crane	5155911	TR24400	Belt - Gen.; W/12V. Gen.	3224367	TR28390
255A; 425; 440			Belt - Gen.; W/12V., 250W. Gen.; W/Truck Mtd. Crane	5164293	TR22322
Detroit Diesel 3-71 Diesel; Detroit Diesel 4-71 Diesel			Belt - Gen.; W/24V. Gen.; W/Truck Mtd. Crane	5155911	TR24400
Belt - Fan; W/Low Mount Fan; W/46 1/8" Belt O.C.	5170972	②TR22455	Blaw-Knox		
Belt - Fan; W/High Mount Fan; W/70 1/4" Belt O.C.	3224451	TR34700	195 Road Widener		
Belt - Fan; W/High Mount Fan; W/74 1/2" Belt O.C.	5175105	②BX71	Detroit Diesel 4-53 Diesel		
Belt - Gen.; W/12V. Gen.	3224367	TR28390	Belt - Fan & Compr.	5136272	②▲9520HD
Belt - Gen.; W/12V., 250W. Gen.	5164293	TR22322	Belt - W.P. & Alt.	5133601	②7410
Belt - Gen.; W/24V. Gen.	5155911	TR24400	Belt - Hyd. Pump		②3VX355
450			Ford 6-Cyl. 300		
Detroit Diesel 3-71 Diesel			Belt - Fan		▲9405HD
Belt - Fan; W/Low Mount Fan; W/46 1/8" Belt O.C.	5170972	②TR22455	Belt - Alt. & W.P.		7420
Belt - Fan; W/High Mount Fan; W/70 1/4" Belt O.C.	3224451	TR34700	Belt - Gov.		7260
Belt - Fan; W/High Mount Fan; W/74 1/2" Belt O.C.	5175105	②BX71	Belt - Compr.		7450
Belt - Gen.; W/12V. Gen.	3224367	TR28390			

②Two Required.

▲Standard Belt Available.

Belts and Coolant Hose for Road & Construction Equipment

Application	Mfr. Part No.	Our No.	Application	Mfr. Part No.	Our No.
Blaw-Knox - Continued			Bobcat-Melroe - Continued		
195 Road Widener - Continued			425		
Ford 6-Cyl. 300 - Continued			Kubota V1505 Diesel		
Belt - Hyd. Pump		♣9550HD	Belt - Fan	6690691	7380
PF25			430; 430H		
Ford V-4 104			Kubota V2203 Diesel		
Belt - Fan, Alt. & W.P.		7430	Belt - Fan; W/O A.C.	6815019	K060445
Belt - Fan, W.P. & Idler		7430	Belt - Fan; W/A.C.	6815018	♣K060635HD
Belt - Gov.		7350	Belt - Pump	6672021	6952BR
PF65			450		
Ford 6-Cyl. 172			Kohler 2-Cyl. 42		
Belt - Fan & Alt.		♣9420HD	1999 - 1994		
Belt - Compr. & Hyd. Pump		7640	Belt - Pump	6564100	BX47
Ford 6-Cyl. 172 Diesel			453		
Belt - Fan & Alt.		♣9415HD	Kubota 3-Cyl. 47 Diesel		
Belt - Compr. & Hyd. Pump		7640	2000 - 1994		
PF120			Belt - Alt.; W/36" Belt O.C.		
Detroit Diesel 4-53 Diesel			Belt - Alt.; W/35 1/2" Belt O.C.		
Belt - Fan & Compr.	5136272	②♣9520HD	Belt - Pump		
Belt - W.P. & Alt.	5133601	②7410	2006 - 1994		
Belt - Hyd. Pump		②3VX355	Belt - Alt.; W/36" Belt O.C.		
Hose - Upper		③<21794	Belt - Alt.; W/35 1/2" Belt O.C.		
	or	25474	Belt - Pump		
Hose - Lower - Eng. To Pipe		24432	2006 - 2001		
Hose - Lower - Pipe To Rad.		24432	Belt - Alt.		
Ford 6-Cyl. 300			Belt - Hydro.		
Belt - Fan		♣9405HD	2006 - 1994		
Belt - Alt. & W.P.		7420	Belt - Alt.; W/38" Belt O.C.		
Belt - Gov.		7260	Belt - Alt.; W/40 1/2" Belt O.C.		
Belt - Compr.		7450	2006 - 1994		
Belt - Hyd. Pump		③7355	Belt - Alt.; W/38" Belt O.C.		
PF500			641		
Detroit Diesel 4-53 Diesel			Deutz F2L511 Diesel		
Belt - W.P. & Alt.	5133601	②7410	1990 - 1981		
Hose - Upper		③<21794	Belt - Blower & Alt.		
	or	25474	②♣9375HD		
Hose - Lower - Eng. To Pipe		24432	642		
Hose - Lower - Pipe To Rad.		24432	Ford 4-Cyl. 98		
Bobcat-Melroe			1986 - 1981		
225			Belt - Fan & Gov.		
Kubota D1402B Diesel			Belt - Alt.		
Belt - Fan & Alt.	6657279	7440	6554888		
324			7420		
Kubota D722 Diesel			651743		
Belt - Fan & Alt.	6808629	7355	642B		
331			Mitsubishi 4G32		
Kubota V2203E Diesel			1993 - 1986		
Belt - Fan & Alt.	6657279	7440	Belt - W.P. To Alt.		
335			Belt - Gov.		
Kubota V2203 Diesel			7400		
Belt - Fan	7101067	♣K060425HD	7315		
418			643		
Kubota D722 Diesel			Kubota D1402BA Diesel		
Belt - Fan & Alt.	6808629	7355	1992 - 1981		
			Belt - W.P. & Alt.		
			Hose - Upper		
			Hose - Lower		
			7420		
			7300		
			25482		
			742		
			Ford 4-Cyl. 98		
			1990 - 1981		
			Belt - W.P. & Gov.		
			Belt - Alt.		
			Hose - Upper		
			6554888		
			6557143		
			7420		
			7300		
			25482		

♣Standard Belt Available.
③<Cut to Fit.

②Two Required.
③Three Required.

Belts and Coolant Hose for Road & Construction Equipment

Application	Mfr. Part No.	Our No.	Application	Mfr. Part No.	Our No.
Bobcat-Melroe - Continued			Bobcat-Melroe - Continued		
743			843		
Kubota V1702BA Diesel			Perkins 4-Cyl. 154 Diesel		
1990 - 1981			1986 - 1981		
Belt - Fan & Alt.	6562693	♣9451HD	Hose - Lower - Pipe To Rad.		≈21794
743B				or	25473
Kubota V1702BA Diesel			843B		
1994 - 1991			Isuzu 4-Cyl. 169 Diesel		
Belt - Fan & Alt.	6562693	♣9451HD	1992 - 1990		
751			Belt - W.P. To Alt.	8942568000	TR24407
Kubota 4-Cyl. 116 Diesel			Hose - By Pass		≈20802
2000 - 1994			853		
Belt - Fan; W/40 1/2" Belt O.C.	6715478	♣9400HD	Isuzu 4JB1PK-03 Diesel		
Belt - Fan; W/41 1/2" Belt O.C.	6732416	♣9412HD	1999 - 1991		
Belt - Alt.; W/Std. Alt.	6704720	♣9463HD	Belt - Fan; W/Std. Fan	6701265	7673
Belt - Alt.; W/90A. Alt.	6675837	7448	Belt - Fan; W/High Speed Fan	6659248	♣9670HD
Belt - Pump 6672445		6959BR	Belt - Pump; W/4-Ribbed Belt	6662855	6956BR
753			Belt - Pump; W/3-Ribbed Belt	6660766	6954BR
Kubota V2203B Diesel			863		
2003 - 1990			Deutz 4-Cyl. 167 Diesel		
Belt - Fan; W/40" Belt O.C.	6715478	♣9400HD	2003 - 1997		
Belt - Fan; W/40 1/2" Belt O.C.	6704607	♣9403HD	Belt - Fan; W/44" Belt O.C.	6707648	7430
Belt - Fan; W/41 1/4" Belt O.C.	6669034	7410	Belt - Fan; W/45" Belt O.C.	6676345	7445
Belt - Alt. 6704720		♣9463HD	Belt - Fan; W/46" Belt O.C.	6715546	7453
753F			Belt - Fan; W/46 1/4" Belt O.C.	6732453	7460
Kubota V2203B Diesel			Belt - Alt.; W/Std. Alt.	6534779	7390
2000 - 1997			Belt - Alt.; W/90A. Alt.	6675839	7405
Belt - Fan; W/40" Belt O.C.	6715478	♣9400HD	Belt - Pump; W/68" Belt O.C.	6670690	6955BR
Belt - Fan; W/40 1/2" Belt O.C.	6704607	♣9403HD	Belt - Pump; W/69" Belt O.C.	6662855	6956BR
Belt - Fan; W/41 1/4" Belt O.C.	6669034	7410	Belt - Pump; W/71" Belt O.C.	6672129	6958BR
Belt - Alt. 6704720		♣9463HD	Belt - A.C. 6725943		♣9403HD
763			863H		
Kubota 4-Cyl. 134 Diesel			Deutz 4-Cyl. 167 Diesel		
2003 - 1994			1999 - 1996		
Belt - Fan; W/40" Belt O.C.	6715478	♣9400HD	Belt - Fan; W/44" Belt O.C.	6707648	7430
Belt - Fan; W/40 1/2" Belt O.C.	6704607	♣9403HD	Belt - Fan; W/45" Belt O.C.	6676345	7445
Belt - Fan; W/41 " Belt O.C.	6732416	♣9412HD	Belt - Fan; W/46" Belt O.C.	6715546	7453
Belt - Alt. 6704720		♣9463HD	Belt - Fan; W/46 1/4" Belt O.C.	6732453	7460
763H			Belt - Alt.; W/Std. Alt.	6534779	7390
Kubota V2203B Diesel			Belt - Alt.; W/90A. Alt.	6675839	7405
2000 - 1995			Belt - Pump; W/68" Belt O.C.	6670690	6955BR
Hose - Upper		25251	Belt - Pump; W/69" Belt O.C.	6662855	6956BR
773			Belt - Pump; W/71" Belt O.C.	6672129	6958BR
Kubota 4-Cyl. 134 Diesel			Belt - A.C. 6725943		♣9403HD
2001 - 1994			864		
Belt - Fan; W/42 1/2" Belt O.C.	6718730	♣9420HD	Deutz 4-Cyl. 178 Diesel		
Belt - Fan; W/41 1/2" Belt O.C.	6732416	♣9412HD	2000		
Belt - Alt.; W/55A. Alt.	6704720	♣9463HD	Belt - Fan; W/45" Belt O.C.	6713382	♣9447HD
Belt - Alt.; W/90A. Alt.	6675837	7448	Belt - Fan; W/46 1/4" Belt O.C.	6732453	7460
Belt - Pump; W/57" Belt O.C.	6672021	6952BR	Belt - Alt.; W/Std. Alt.	6534779	7390
Belt - Pump; W/58" Belt O.C.	6726898	6952BR	Belt - Alt.; W/90A. Alt.	6675839	7405
773H			Belt - Pump 6672152		6957BR
Kubota 4-Cyl. 134 Diesel			Belt - A.C. 6725943		♣9403HD
2000			873		
Belt - Fan; W/42 1/2" Belt O.C.	6718730	♣9420HD	Deutz 4-Cyl. 167 Diesel		
Belt - Fan; W/41 1/2" Belt O.C.	6732416	♣9412HD	2001 - 1994		
Belt - Alt.; W/55A. Alt.	6704720	♣9463HD	Belt - Fan; W/43 1/2" Belt O.C.	6713385	7425
Belt - Alt.; W/90A. Alt.	6675837	7448	Belt - Fan; W/42 1/2" Belt O.C.	6725186	7417
Belt - Pump; W/57" Belt O.C.	6672021	6952BR	Belt - Fan; W/44" Belt O.C.	6707648	7430
Belt - Pump; W/58" Belt O.C.	6726898	6952BR	Belt - Fan; W/45" Belt O.C.	6676345	7445
			Belt - Alt.; W/Std. Alt.	6534779	7390
			Belt - Alt.; W/90A. Alt.	6675839	7405
			Belt - Pump; W/68" Belt O.C.	6670690	6955BR

♣Standard Belt Available.

≈Cut to Fit.

Belts and Coolant Hose for Road & Construction Equipment

Application	Mfr. Part No.	Our No.	Application	Mfr. Part No.	Our No.
Bobcat-Melroe - Continued			Bobcat-Melroe - Continued		
873 - Continued			A220 - Continued		
Deutz 4-Cyl. 167 Diesel - Continued			Deutz 4-Cyl. 178 Diesel - Continued		
2001 - 1994 - Continued			2003 - 2002 - Continued		
Belt - Pump; W/69" Belt O.C.	6662855	6956BR	Belt - Fan; W/46 1/4" Belt O.C.	6732453	7460
Belt - A.C.	6725943	♣9403HD	Belt - Alt.	6675839	7405
873H			Belt - Pump	6662855	6956BR
Deutz 4-Cyl. 167 Diesel			Belt - A.C.	6725943	♣9403HD
2000			A300		
Belt - Fan; W/43 1/2" Belt O.C.	6713385	7425	Deutz 4-Cyl. 178 Diesel		
Belt - Fan; W/42 1/2" Belt O.C.	6725186	7417	2006 - 2002		
Belt - Fan; W/44" Belt O.C.	6707648	7430	Belt - Fan		
Belt - Fan; W/45" Belt O.C.	6676345	7445	Belt - Fan		
Belt - Alt.; W/Std. Alt.	6534779	7390	Kubota 4-Cyl. 203 Diesel		
Belt - Alt.; W/90A. Alt.	6675839	7405	2011 - 2006		
Belt - Pump; W/68" Belt O.C.	6670690	6955BR	Belt - Fan	6713382	♣9447HD
Belt - Pump; W/69" Belt O.C.	6662855	6956BR	Belt - Alt.	6686655	7516
Belt - A.C.	6725943	♣9403HD	Belt - Pump	6662855	6956BR
883			Belt - A.C.	6730819	♣9365HD
Deutz 4-Cyl. 178 Diesel			A770		
2002 - 2001			Kubota 4-Cyl. 230 Diesel		
Belt - Fan; W/42 1/2" Belt O.C.	6725186	7417	2013 - 2011		
Belt - Fan; W/45" Belt O.C.	6676345	7445	Belt - Pump		
Belt - Alt.	6675839	7405	Belt - Pump		
Belt - Pump	6662855	6956BR	Belt - Pump		
Belt - A.C.	6725943	♣9403HD	Belt - A.C.		
883H			E26		
Deutz 4-Cyl. 178 Diesel			Kubota D1105 Diesel		
2001			Belt - Fan & Alt.		
Belt - Fan; W/42 1/2" Belt O.C.	6725186	7417	Belt - Fan & Alt.		
Belt - Fan; W/45" Belt O.C.	6676345	7445	Belt - Fan & Alt.		
Belt - Alt.	6675839	7405	Belt - Fan & Alt.		
Belt - Pump	6662855	6956BR	Belt - Fan & Alt.		
Belt - A.C.	6725943	♣9403HD	Belt - Fan & Alt.		
963			M600D		
Perkins 4-Cyl. 243 Diesel			Deutz F2L410 Diesel		
2003 - 1998			1975 - 1967		
Belt - Alt.	6617875	♣9400HD	Belt - Fan & Alt.		
Belt - Pump	6669565	6964BR	Belt - Fan & Alt.		
Belt - A.C.	6807036	A44	Belt - Fan & Alt.		
975			M620		
John Deere 4-Cyl. 276 Diesel			Wisconsin VH4D		
1990 - 1974			1976 - 1975		
Belt - Fan & Alt.	6511876	♣9500HD	Belt - Alt.		
2000			Belt - Alt.		
Perkins 4-Cyl. 154 Diesel			Belt - Alt.		
Belt - Fan & Alt.			Belt - Alt.		
Belt - Fan & Alt.			Belt - Alt.		
3023			M700		
Kubota V1702BA Diesel			Wisconsin VH4D; Wisconsin VH4D LPG		
Belt - W.P. To Alt.		♣9451HD	1976 - 1972		
Hose - Upper		♣20137	Belt - Alt.		
7753			Belt - Alt.		
Kubota V2203B Diesel			Belt - Alt.		
1993 - 1990			Belt - Alt.		
Hose - Upper		25251	Belt - Alt.		
A220			M970		
Deutz 4-Cyl. 178 Diesel			Continental F227 Diesel		
2003 - 2002			1975 - 1970		
Belt - Fan; W/44" Belt O.C.	6707648	7430	Belt - Fan & Alt.		
Belt - Fan; W/45" Belt O.C.	6676345	7445	Belt - Fan & Alt.		
873H			Perkins 4-Cyl. 236 Diesel		
Deutz 4-Cyl. 167 Diesel			1975 - 1970		
2000			Belt - Fan & Alt.		
Belt - Fan; W/43 1/2" Belt O.C.	6713385	7425	Belt - Fan & Alt.		
Belt - Fan; W/42 1/2" Belt O.C.	6725186	7417	Belt - Fan & Alt.		
Belt - Fan; W/44" Belt O.C.	6707648	7430	Belt - Fan & Alt.		
Belt - Fan; W/45" Belt O.C.	6676345	7445	Belt - Fan & Alt.		
Belt - Alt.; W/Std. Alt.	6534779	7390	Belt - Fan & Alt.		
Belt - Alt.; W/90A. Alt.	6675839	7405	Belt - Fan & Alt.		
Belt - Pump; W/68" Belt O.C.	6670690	6955BR	Belt - Fan & Alt.		
Belt - Pump; W/69" Belt O.C.	6662855	6956BR	Belt - Fan & Alt.		
Belt - A.C.	6725943	♣9403HD	Belt - Fan & Alt.		
883			MT52		
Deutz 4-Cyl. 178 Diesel			Kubota 3-Cyl. 44 Diesel		
2002 - 2001			2013 - 2008		
Belt - Fan; W/42 1/2" Belt O.C.	6725186	7417	Belt - Fan & Alt.; W/34 1/2" Belt O.C.		
Belt - Fan; W/45" Belt O.C.	6676345	7445	Belt - Fan & Alt.; W/36" Belt O.C.		
Belt - Alt.	6675839	7405	Belt - Fan & Alt.; W/36" Belt O.C.		
Belt - Pump	6662855	6956BR	Belt - Fan & Alt.; W/36" Belt O.C.		
Belt - A.C.	6725943	♣9403HD	Belt - Fan & Alt.; W/36" Belt O.C.		
883H			MT55		
Deutz 4-Cyl. 178 Diesel			Kubota 3-Cyl. 55 Diesel		
2001			2013 - 2005		
Belt - Fan; W/42 1/2" Belt O.C.	6725186	7417	Belt - Fan & Alt.		
Belt - Fan; W/45" Belt O.C.	6676345	7445	Belt - Fan & Alt.		
Belt - Alt.	6675839	7405	Belt - Fan & Alt.		
Belt - Pump	6662855	6956BR	Belt - Fan & Alt.		
Belt - A.C.	6725943	♣9403HD	Belt - Fan & Alt.		
963			MT55		
Perkins 4-Cyl. 243 Diesel			Kubota 3-Cyl. 55 Diesel		
2003 - 1998			2013 - 2005		
Belt - Alt.	6617875	♣9400HD	Belt - Fan & Alt.		
Belt - Pump	6669565	6964BR	Belt - Fan & Alt.		
Belt - A.C.	6807036	A44	Belt - Fan & Alt.		
975			MT55		
John Deere 4-Cyl. 276 Diesel			Kubota 3-Cyl. 55 Diesel		
1990 - 1974			2013 - 2005		
Belt - Fan & Alt.	6511876	♣9500HD	Belt - Fan & Alt.		
2000			MT55		
Perkins 4-Cyl. 154 Diesel			Kubota 3-Cyl. 55 Diesel		
Belt - Fan & Alt.			2013 - 2005		
Belt - Fan & Alt.			Belt - Fan & Alt.		
3023			MT55		
Kubota V1702BA Diesel			Kubota 3-Cyl. 55 Diesel		
Belt - W.P. To Alt.			2013 - 2005		
Hose - Upper			Belt - Fan & Alt.		
7753			MT55		
Kubota V2203B Diesel			Kubota 3-Cyl. 55 Diesel		
1993 - 1990			2013 - 2005		
Hose - Upper		25251	Belt - Fan & Alt.		
A220			MT55		
Deutz 4-Cyl. 178 Diesel			Kubota 3-Cyl. 55 Diesel		
2003 - 2002			2013 - 2005		
Belt - Fan; W/44" Belt O.C.	6707648	7430	Belt - Fan & Alt.		
Belt - Fan; W/45" Belt O.C.	6676345	7445	Belt - Fan & Alt.		

♣Standard Belt Available.

♣Cut to Fit.

Road & Construction Equipment

Belts and Coolant Hose for Road & Construction Equipment

Application	Mfr. Part No.	Our No.	Application	Mfr. Part No.	Our No.
Bobcat-Melroe - Continued			Bobcat-Melroe - Continued		
S70			S220 - Continued		
Kubota 3-Cyl. 61 Diesel			Kubota 4-Cyl. 203 Diesel - Continued		
2013 - 2008			2011 - 2003 - Continued		
Belt - Alt.	6571857	7400	Belt - A.C.	6730819	♣9365HD
Belt - Pump	6690471	6967BR	S250		
S100			Deutz 4-Cyl. 178 Diesel		
Kubota 4-Cyl. 92 Diesel			2003		
2013 - 2006			Belt - Fan; W/44 3/4" Belt O.C.		
Belt - Fan; W/Manual Control Steering	7162825	6965BR	6713382		♣9447HD
Belt - Fan; W/Joystick Control Steering	6688525	6966BR	Belt - Fan; W/46" Belt O.C.	6725905	7460
Belt - Alt.	6690143	7405	Belt - Alt.	6686655	7516
S130			Belt - Pump	6662855	6956BR
Kubota 4-Cyl. 134 Diesel			Belt - A.C.	6730819	♣9365HD
2013 - 2003			Kubota 4-Cyl. 203 Diesel		
Belt - Fan; Ser. No. 524614399 & Before, 524711899 & Before	6715478	♣9400HD	2012 - 2006		
Belt - Fan; Ser. No. 524614400 & After, 524711900 & After	7102447	♣9390HD	Belt - Fan; W/44 3/4" Belt O.C.		
Belt - Alt.	7100104	7435	6713382		♣9447HD
Belt - Pump	6667322	6960BR	Belt - Fan; W/46" Belt O.C.	6725905	7460
S150			Belt - Alt.	6686655	7516
Kubota 4-Cyl. 134 Diesel			Belt - Pump	6662855	6956BR
2013 - 2003			Belt - A.C.	6730819	♣9365HD
Belt - Fan	6718730	♣9420HD	S300		
Belt - Alt.	7100104	7435	Kubota 4-Cyl. 203 Diesel		
Belt - Pump	6667322	6960BR	2012 - 2003		
S160			Belt - Fan; W/44 3/4" Belt O.C.		
Kubota 4-Cyl. 122 Diesel			6713382		♣9447HD
2013 - 2003			Belt - Fan; W/46" Belt O.C.	6725905	7460
Belt - Fan	6718730	♣9420HD	Belt - Alt.	6686655	7516
Belt - Alt.	7143498	♣9355HD	Belt - Pump	6662855	6956BR
Belt - Pump	6667322	6960BR	Belt - A.C.	6730819	♣9365HD
Belt - A.C.	6726988	♣9375HD	S330		
S175			Kubota 4-Cyl. 230 Diesel		
Kubota 4-Cyl. 134 Diesel			2012 - 2006		
2013 - 2002			Belt - Fan; W/44 3/4" Belt O.C.		
Belt - Fan	6718730	♣9420HD	6713382		♣9447HD
Belt - Alt.	7100104	7435	Belt - Fan; W/46" Belt O.C.	6725905	7460
Belt - Pump	6667322	6960BR	Belt - Alt.	6686655	7516
S185			Belt - Pump	7130243	6963BR
Kubota 4-Cyl. 122 Diesel			Belt - A.C.	6730819	♣9365HD
2013 - 2002			S510		
Belt - Fan	6718730	♣9420HD	Kubota 4-Cyl. 134 Diesel		
Belt - Alt.	7143498	♣9355HD	2013 - 2012		
Belt - Pump	6667322	6960BR	Belt - Alt.	7100104	7435
Belt - A.C.	6726988	♣9375HD	Belt - Pump	7146391	6961BR
S205			S530		
Kubota 4-Cyl. 149 Diesel			Kubota 4-Cyl. 149 Diesel		
2013 - 2004			2013 - 2012		
Belt - Fan	6718730	♣9420HD	Belt - Alt.		
Belt - Alt.	7143498	♣9355HD	7100104		7435
Belt - Pump	6667322	6960BR	Belt - Pump	7146391	6961BR
Belt - A.C.	6726988	♣9375HD	S550		
S220			Kubota 4-Cyl. 160 Diesel		
Kubota 4-Cyl. 203 Diesel			2013 - 2012		
2011 - 2003			Belt - Alt.		
Belt - Fan; W/44 3/4" Belt O.C.	6713382	♣9447HD	7143498		♣9355HD
Belt - Fan; W/46" Belt O.C.	6725905	7460	Belt - Pump	7146391	6961BR
Belt - Alt.	6686655	7516	S570; S590		
Belt - Pump	6662855	6956BR	Kubota 4-Cyl. 160 Diesel		
S220			2013 - 2012		
Kubota 4-Cyl. 203 Diesel			Belt - Alt.		
2011 - 2003			7143498		♣9355HD
Belt - Fan; W/44 3/4" Belt O.C.	6713382	♣9447HD	Belt - Pump	7146391	6961BR
Belt - Fan; W/46" Belt O.C.	6725905	7460	Belt - A.C.	6625298	♣9365HD
Belt - Alt.	6686655	7516			
Belt - Pump	6662855	6956BR			

♣Standard Belt Available.

Belts and Coolant Hose for Road & Construction Equipment

Application	Mfr. Part No.	Our No.	Application	Mfr. Part No.	Our No.
Bobcat-Melroe - Continued			Bobcat-Melroe - Continued		
S630			T550; T590		
Kubota 4-Cyl. 203 Diesel 2013 - 2012 Belt - Pump	7188792	6962BR	Kubota 4-Cyl. 160 Diesel 2013 - 2012 Belt - Alt.	7143498	▲9355HD
S650			Belt - Pump	7146391	6961BR
Kubota 4-Cyl. 203 Diesel 2013 - 2011 Belt - Pump	7188792	6962BR	Belt - A.C.	6625298	▲9365HD
S770			T630		
Kubota 4-Cyl. 230 Diesel 2013 - 2012 Belt - Pump	7197894	6963BR	Kubota 4-Cyl. 203 Diesel 2013 - 2010 Belt - Pump	7188792	6962BR
S850			T650		
Kubota 4-Cyl. 230 Diesel 2013 - 2011 Belt - Pump	7197894	6963BR	Kubota 4-Cyl. 203 Diesel 2013 - 2011 Belt - Pump	7188792	6962BR
T180			T750; T770		
Kubota 4-Cyl. 122 Diesel 2013 - 2003 Belt - Alt. & A.C.	7143498	▲9355HD	Kubota 4-Cyl. 230 Diesel 2013 - 2012 Belt - Pump	7197894	6963BR
Belt - Pump	6667322	6960BR	T870		
T190			Kubota 4-Cyl. 230 Diesel 2013 - 2011 Belt - Pump	7197894	6963BR
Kubota 4-Cyl. 122 Diesel 2013 - 2001 Belt - Alt. & A.C.	7143498	▲9355HD	Bomag		
Belt - Pump	6667322	6960BR	BW142PD		
T200			Deutz F3L912 Diesel		
Deutz 4-Cyl. 178 Diesel 2003 - 2001 Belt - Fan; W/45" Belt O.C.	6713382	▲9447HD	Belt - Alt.		7445
Belt - Fan; W/46 1/4" Belt O.C.	6732453	7460	BW161AD		
Belt - Alt.; W/Std. Alt.	6534779	7390	Deutz BF4L913 Diesel		
Belt - Alt.; W/90A. Alt.	6675839	7405	Belt - Blower		7530
Belt - Pump	6672152	6957BR	Belt - Alt.		7465
Belt - A.C.	6725943	▲9403HD	BW210AVA		
T250			Deutz F6L912 Diesel		
Kubota 4-Cyl. 203 Diesel 2006 - 2003 Belt - Fan; W/46" Belt O.C.	6715546	7453	Belt - Blower		7535
Belt - Fan; W/46 1/2" Belt O.C.	6725905	7460	Belt - Gen.		7445
Belt - Fan; W/46 1/4" Belt O.C.	6732453	7460	BW213D		
Belt - Alt.	6686655	7516	Deutz F6L912 Diesel		
Belt - Pump; W/Manual Control Steering	6672152	6957BR	Belt - Alt.		7448
Belt - Pump; W/Joystick Control Steering	6662855	6956BR	K45		
Belt - A.C.	6730819	▲9365HD	Cummins JN6B Diesel		
T300			Belt - Fan	124421	②TR24365
Kubota 4-Cyl. 203 Diesel 2006 - 2002 Belt - Fan; W/45" Belt O.C.	6713382	▲9447HD	Belt - W.P.	101427	TR22299
Belt - Fan; W/46" Belt O.C.	6715546	7453	Hose - Upper		26511
Belt - Fan; W/46 1/2" Belt O.C.	6725905	7460	Detroit Diesel 4-71 Diesel		
Belt - Fan; W/46 1/4" Belt O.C.	6732453	7460	Belt - Fan; W/Air Brake Compr.; W/High Mount Fan	3224451	TR34700
Belt - Alt.	6686655	7516	Belt - Fan; W/O Air Brake Compr.; W/High Mount Fan	3224368	TR34545
Belt - Pump; W/Manual Control Steering	6672152	6957BR	Belt - Fan; W/Low Mount Fan		TR22455
Belt - Pump; W/Joystick Control Steering	6662855	6956BR	Belt - Gen.; W/25A. Gen.	3224367	TR28390
Belt - A.C.	6730819	▲9365HD	K300		
			Cummins V555 Diesel		
			Belt - Fan & W.P.	178497	②TR24476
			Belt - Alt.	178459	▲9319HD
			Hose - Upper		26509
			Hose - Lower		26509

Road & Construction Equipment

▲Standard Belt Available.

②Two Required.

Belts and Coolant Hose for Road & Construction Equipment

Application	Mfr. Part No.	Our No.	Application	Mfr. Part No.	Our No.
Bomag - Continued			Broderson - Continued		
KT7B; KT8			MH42A		
Continental Y112			Chrysler 6-Cyl. 225		
Belt - Fan & Gen.	11653	TR22386	Belt - Fan & Alt.		7570
Belt - Hyd. Pump	11894	TR30428	Belt - P.S.		▲9415HD
Hercules DIXC Diesel			Hose - Upper		≈<20137
Belt - Fan		TR24438	Hose - Lower		20229
Belt - Hyd. Pump	11894	TR30428	MH42B		
Hercules IXB5			Perkins 4-Cyl. Diesel		
Belt - Fan & Gen.; W/35 1/2" Belt O.C.	11402	TR26353	Belt - Fan & Alt.		▲9590HD
Belt - Fan & Gen.; W/41 7/8" Belt O.C.	11023	TR24414	Hose - Upper		26506
Belt - Hyd. Pump; Ser. No. 23713 & Before .	11280	TR28429	Hose - Lower		25487
Belt - Hyd. Pump; Ser. No. 23714 & After ...	11609	TR28390	Bros		
KT15			LSPRM8A		
Continental F226			Caterpillar D334TAC Diesel		
Belt - Fan	F600K267	TR24465	Hose - Upper		26532
MPH100S			Cummins NT855 Diesel		
Detroit Diesel 6V-92 Diesel			Belt - Fan	178684	②TR28693
Belt - Fan		③▲9710HD	Hose - Upper		26525
PSR9			Hose - Lower		26525
Continental F226			Detroit Diesel 8V-71N Diesel		
Belt - Fan & Gen.	F226K280	②7460	Hose - Lower		24444
Hose - Upper		24224		or	26525
Hose - Lower		24224	LSPRM84A		
		or 25476	Cummins NHRS6P Diesel		
PSR30			Belt - Fan	178611	②TR28550
Cummins JN6B Diesel			Belt - W.P.	200328	TR24438
Belt - Fan	124421	②TR24365	Belt - Hyd. Pump		TR28423
Belt - W.P.	101427	TR22299	Hose - Upper - Eng. To Pipe		24236
PSRC10			Hose - Upper - Pipe To Rad.		24236
Ford 6-Cyl.			Hose - Lower		24236
Belt - Fan		▲9412HD	SP54C		
Belt - W.P. & Gen.		7360	Continental F162		
Belt - Gov.		7250	Belt - Fan & Gen.	F600K267	TR24465
S46			SP255		
Ford V-4 104			Cummins C160 Diesel		
Belt - Fan, Alt. & W.P.		7445	Belt - Fan		②TR22358
Belt - Gov.		7350	Belt - W.P.		TR22329
Belt - Hyd. Pump		7380	Belt - Gen.		TR22495
Hose - Upper		25473	SP730B		
VM33			Cummins JN6IP Diesel		
Waukesha BKR			Belt - Fan	124421	②TR24365
Belt - Fan & Gen.		TR30448	Belt - W.P.; W/33 3/8" Belt O.C.	178490	TR22329
VT48			Belt - W.P.; W/36 3/8" Belt O.C.	178530	②TR22358
Waukesha 6SRKR			Belt - Alt.	178685	TR22485
Belt - Fan	12910	C78	Belt - Gen.; W/44 3/4" Belt O.C.	101426	TR22443
Belt - Hyd. Pump	11894	TR30428	Belt - Gen.; W/46 5/8" Belt O.C.	70885	TR22461
Broderson			Belt - Gen.; W/47 7/8" Belt O.C.	178470	TR22474
IC701A			Belt - Gen. & V.P.		7550
Ford 4-Cyl. 172 Diesel			Belt - Hyd. Pump		TR24438
Belt - Fan & Alt.		7390	Hose - Upper - Eng. To Pipe		24232
Belt - Hyd. Pump		TR22461	Hose - Upper - Pipe To Rad.		24232
Hose - Upper - Eng. To Pipe		≈<21942	Hose - Lower - Pipe To Rad.		②24236
Hose - Upper - Pipe To Rad.		≈<21942	Hose - Lower - W.P. To Water Manifold		24236
Hose - Lower - Pipe To Rad.		25253	Hose - Lower - Water Manifold To Pipe		②24230
Broderson			SP735		
Cummins Diesel			Belt - Fan	124479	②TR22363
Belt - Fan			Belt - W.P.	101427	TR22299

▲Standard Belt Available.
②Two Required.

③Three Required.
≈<Cut to Fit.

Belts and Coolant Hose for Road & Construction Equipment

Application	Mfr. Part No.	Our No.	Application	Mfr. Part No.	Our No.
Bros - Continued			Bros - Continued		
SP735 - Continued			TE4		
Cummins Diesel - Continued			Ford 6-Cyl. 300 Diesel		
Belt - Gen.	134788	TR22517	Belt - Fan & Alt.		7417
SP4000			Hose - Upper		25478
Perkins 4-Cyl. 236			Hose - Lower		26504
Belt - Fan & Alt.		♣9560HD	Ford 6-Cyl. 330 Diesel		
Hose - Upper		25482	Belt - Fan & Alt.		7495
SP6000			Hose - Upper		26505
Detroit Diesel 3-53 Diesel			Hose - Lower		26510
Belt - Fan		♣9412HD	Brown		
Belt - W.P. & Gen.	5126356	♣TR22373	1200 Series		
Hose - Upper		20065	Honda 9 H.P.		
	or	25474	Belt - Drive		BX71
Hose - Lower - Eng. To Pipe		24232	The Articulator		
Hose - Lower - Pipe To Rad.		24232	Honda 8 H.P.		
SP6000B			Belt - Drive; W/60" Belt O.C.	B57	♣6960
Detroit Diesel 3-53 Diesel			Belt - Drive; W/93" Belt O.C.	B90	6993
Belt - Fan		♣9415HD	Bucyrus-Erie		
Belt - W.P. & Alt.	5133174	♣7400	10B		
Hose - Upper		26504	Hercules		
Hose - Lower - Eng. To Pipe		24232	Belt - Fan & Gen.		
Hose - Lower - Pipe To Rad.		♣20206	TR30467		
SPV627; SPV627VA			IH UD281.4 Diesel		
John Deere 4276D Diesel			Belt - Fan	16131DA	TR30467
Hose - Upper		♣20065	Belt - Gen.	52318DA	9279
	or	25526	10R		
Hose - Lower		26501	Detroit Diesel 6-71 Diesel		
SPV735			Belt - Fan; W/42 3/4" Belt O.C.		
Detroit Diesel 3-53 Diesel				5119186	♣9425HD
Belt - W.P.	5133173	7420	Belt - Fan; W/46 1/8" Belt O.C.	5170972	♣TR22455
Hose - Upper		26501	Belt - Gen.; W/18A. Gen.	5125811	♣9380HD
Hose - Lower - Eng. To Pipe		♣20882	Belt - Gen.; W/25A. Gen.	5108883	♣9365HD
Hose - Lower - Pipe To Rad.		♣20882	15B		
SPV735VA			Detroit Diesel 2-71 Diesel		
Detroit Diesel 3-53 Diesel			Belt - Fan	5166844	TR22625
Belt - Fan	5119188	♣9390HD	Belt - Gen.	5166844	TR22625
Belt - W.P. & Gen.		♣7400	Belt - Compr.	5168993	TR24515
Belt - Hyd. Pump		7340	IH UD9		
Hose - Upper		26504	Belt - Fan	48042D	TR30484
Hose - Lower - Eng. To Pipe		♣20206	Belt - Gen.	54857DB	9300
Hose - Lower - Pipe To Rad.		♣20206	19B		
Detroit Diesel 4-53 Diesel			Caterpillar D318 Diesel		
Belt - W.P. & Alt.	5133174	7400	Belt - Gov.	4B2544	♣9425HD
Hose - Upper		26501	Belt - Starter	6B2746	TR22485
Hose - Lower		24232	20B		
SPV850			Detroit Diesel 3-71 Diesel		
Detroit Diesel 4-53 Diesel			Belt - Fan; W/High Mount Fan; W/70 1/4"		
Hose - Lower		♣20882	Belt O.C.; W/3/4 Thru 1 1/2 Yard	3224451	TR34700
SSPRIN1-7			Belt - Fan; W/Low Mount Fan; W/46 1/8"		
Cummins C160 Diesel			Belt O.C.; W/3/4 Thru 1 1/2 Yard	5170972	♣TR22455
Hose - Upper		26504	Belt - Gen.; W/12V. Gen.; W/3/4 Thru 1 1/2		
SSPRN7			Yard	3224367	TR28390
Cummins C160 Diesel			Belt - Gen.; W/24V. Gen.; W/3/4 Thru 1 1/2		
Belt - Fan		♣TR24407	Yard	5155911	TR24400
Belt - W.P.	178584	TR22350	20H		
Belt - Gen.		TR22495	Detroit Diesel 6-71 Diesel		
Belt - Hyd. Pump		♣TR22495	Belt - Fan	5131395	♣9400HD
			Belt - W.P. & Alt.		♣7417

♣Standard Belt Available.
♣Cut to Fit.

♣Two Required.
♣Five Required.

Road & Construction
Equipment

Belts and Coolant Hose for Road & Construction Equipment

Application	Mfr. Part No.	Our No.	Application	Mfr. Part No.	Our No.
Bucyrus-Erie - Continued			Bucyrus-Erie - Continued		
20H - Continued			30H II		
Detroit Diesel 6-71 Diesel - Continued			Detroit Diesel 6V-71N Diesel		
Belt - Hyd. Pump		7350	Belt - Fan		②▲9455HD
Hose - Upper		≈<20957	Belt - Gen.		▲9360HD
		or	Belt - Hyd. Pump		7355
		≈<20603	Hose - Upper		≈<20731
Hose - Lower		≈<20206	Hose - Lower		24244
				or	26521
20H III			37B		
Cummins V504 Diesel			Wisconsin D3		
Belt - Fan & W.P.	212585	②TR22517	Belt - Fan	15834	TR28628
Belt - Fan To Alt.	178453	②7400	38B		
Hose - Upper		26511	Detroit Diesel 6-71 Diesel		
Hose - Lower		26519	Belt - Fan; W/High Mount Fan; W/Compr. ...		
20R			Belt - Fan; W/High Mount Fan; W/O		
Detroit Diesel 6-71 Diesel			Compr.		
Belt - Fan; W/42 3/4" Belt O.C.	5119186	②▲9425HD	Belt - Fan; W/High Mount Fan; W/O	3224451	TR34700
Belt - Fan; W/46 1/8" Belt O.C.	5170972	②TR22455	Belt - Fan; W/High Mount Fan; W/O	3224368	TR34545
Belt - Gen.; W/18A. Gen.	5125811	▲9380HD	Belt - Fan; W/High Mount Fan; W/O	5177290	TR22455
Belt - Gen.; W/25A. Gen.	5108883	▲9365HD	Belt - Fan; W/Low Mount Fan; W/Compr. ...	517290	TR22455
21H			Belt - Fan; W/Low Mount Fan; W/O Compr. ...		
Cummins V903 Diesel			Belt - Gen.; W/20A. Gen.		
Belt - Fan & W.P.		②TR22525	Belt - Gen.; W/20A. Gen.	5155911	TR28406
Belt - Alt.	178453	②7400	Belt - Gen.; W/25A. Gen.	3224367	TR28390
Detroit Diesel 4-71 Diesel			38TC		
Belt - Fan		②▲9500HD	Detroit Diesel 6-71 Diesel		
Belt - Alt.		▲9370HD	Belt - Fan; W/High Mount Fan; W/70 1/4"		
Hose - Upper		26509	Belt O.C.; W/3/4 Thru 1 1/2 Yard		
Hose - Lower		26510	Belt - Fan; W/Low Mount Fan; W/46 1/8"		
21H IV			Belt O.C.; W/3/4 Thru 1 1/2 Yard		
Cummins V903 Diesel			Belt - Gen.; W/12V. Gen.; W/3/4 Thru 1 1/2		
Hose - Upper		26512	Yard		
Hose - Lower		26519	Belt - Gen.; W/24V. Gen.; W/3/4 Thru 1 1/2		
22B			Yard		
Caterpillar D318 Diesel			5155911		
Belt - Gov.	4B2544	▲9425HD	45CIIB100		
Belt - Starter	6B2746	TR22485	Detroit Diesel 6V-53 Diesel		
Detroit Diesel 3-71 Diesel			Hose - Upper - Right (Upper Structure)		
Belt - Fan; W/High Mount Fan; W/70 1/4"			Hose - Upper - Left (Upper Structure)		
Belt O.C.; W/3/4 Thru 1 1/2 Yard	3224451	TR34700	Hose - Lower - Upper Structure		
Belt - Fan; W/Low Mount Fan; W/46 1/8"			Detroit Diesel 6V-53N Diesel		
Belt O.C.; W/3/4 Thru 1 1/2 Yard	5170972	②TR22455	Belt - Fan - Upper Structure		
Belt - Gen.; W/12V. Gen.; W/3/4 Thru 1 1/2			Belt - W.P. & Idler - Upper Structure		
Yard	3224367	TR28390	Belt - Alt. - Upper Structure		
Belt - Gen.; W/24V. Gen.; W/3/4 Thru 1 1/2			Belt - Hyd. Pump - Upper Structure		
Yard	5155911	TR24400	Detroit Diesel 6V-71N Diesel		
22BM-2			Belt - Fan - Lower Structure		
Cummins C464P160 Diesel			Belt - Alt. - Lower Structure		
Belt - Fan; W/36 5/8" Belt O.C.		②TR22358	Hose - Upper - Lower Structure		
Belt - Fan; W/37 3/8" Belt O.C.	178576	②TR24365	Hose - Lower - Lower Structure		
Belt - W.P.		TR22299	45R		
Belt - Alt.	178470	TR22474	Cummins NT380 Diesel		
25B			Belt - Fan		
Detroit Diesel 4-71 Diesel			Belt - W.P.		
Belt - Fan; W/High Mount Fan; W/70 1/4"			Belt - Gen.		
Belt O.C.; W/3/4 Thru 1 1/2 Yard	3224451	TR34700	Cummins NT855 Diesel		
Belt - Fan; W/Low Mount Fan; W/46 1/8"			Belt - Fan		
Belt O.C.; W/3/4 Thru 1 1/2 Yard	5170972	②TR22455	Belt - W.P.		
Belt - Gen.; W/12V. Gen.; W/3/4 Thru 1 1/2			Belt - Gen.		
Yard	3224367	TR28390	Buda 6-Cyl. Diesel		
Belt - Gen.; W/24V. Gen.; W/3/4 Thru 1 1/2			Belt - Fan		
Yard	5155911	TR24400	Belt - Compr.		
25B			Belt - Starter		
Detroit Diesel 4-71 Diesel			DP1597		
Belt - Fan; W/High Mount Fan; W/70 1/4"			②TR28666		
Belt O.C.; W/3/4 Thru 1 1/2 Yard	3224451	TR34700	TR30589		
Belt - Fan; W/Low Mount Fan; W/46 1/8"			TR28437		
Belt O.C.; W/3/4 Thru 1 1/2 Yard	5170972	②TR22455			
Belt - Gen.; W/12V. Gen.; W/3/4 Thru 1 1/2					
Yard	3224367	TR28390			
Belt - Gen.; W/24V. Gen.; W/3/4 Thru 1 1/2					
Yard	5155911	TR24400			

≈<Cut to Fit.
▲Standard Belt Available.

②Two Required.

Belts and Coolant Hose for Road & Construction Equipment

Application	Mfr. Part No.	Our No.	Application	Mfr. Part No.	Our No.
Bucyrus-Erie - Continued			Case - Continued		
54B			40XT - Continued		
Buda 6-Cyl. Diesel			Case 4-390 Diesel - Continued		
Belt - Fan	DP1597	②TR28666	2004 - 2002 - Continued		
60L			Tensioner Assy. - Fan	J936203	38504
IH UD281.4 Diesel			60XT		
Belt - Fan	16131DA	TR30467	Case 4-390 Diesel		
Belt - Gen.	52318DA	9279	2006 - 2002		
71B			Belt - Fan	J911558	▲K080590HD
Detroit Diesel 6-110 Diesel			Tensioner Assy. - Fan	J936203	38504
Belt - Fan	2304818	7470	70XT		
Belt - Gen.	6107416	TR28429	Case 4-390 Diesel		
88B			2005 - 2002		
Cummins VT12 Diesel			Belt - Fan	J911558	▲K080590HD
Belt - Fan	69201	②▲9650HD	Tensioner Assy. - Fan	J936203	38504
Belt - Gen.	S3133	②TR22344	75XT		
280CSP			Case 4-390 Diesel		
Detroit Diesel 4-53N Diesel			2005 - 1998		
Belt - Fan	5119188	▲9390HD	Belt - Fan	J911559	▲K080620HD
Belt - W.P. & Alt.		7417	85XT		
Hose - Upper		≧20611	Case 4-390 Diesel		
	or	26509	2005		
500H			Belt - Fan	J911559	▲K080620HD
Cummins VT1710 Diesel			Belt - Compr.	308712A1	▲9355HD
Belt - W.P. & Alt.	178520	②▲9390HD	Case 4T390 Diesel		
Belt - A.C.	178663	②▲9365HD	2004 - 1998		
Belt - Compr.		③5VX800	Belt - Fan	J911559	▲K080620HD
Buffalo Springfield			Belt - Compr.	308712A1	▲9355HD
K			90XT; 95XT		
Ford V-8 361			Case 4T390 Diesel		
Belt - Fan		TR28483	2004 - 1998		
Belt - Fan & Alt.		②TR24438	Belt - Fan	J911559	▲K080620HD
Belt - Hyd. Pump		TR22508	Belt - Compr.	359688A1	▲9345HD
Hose - Upper - Eng. To Pipe		26504	125B		
Hose - Upper - Pipe To Rad.		25527	Deutz BF6L913 Diesel		
KF30			Belt - Alt.	P939740	7450
Detroit Diesel 6-71 Diesel			Belt - Blower	P938746	②7430
Belt - Fan; W/36 3/4" Belt O.C.	5108883	▲9365HD	170B		
Belt - Fan; W/42 3/4" Belt O.C.	5119186	▲9425HD	Deutz BF6L913 Diesel		
Belt - Gen.; W/25A. Gen.	5170972	TR22455	Belt - Alt.	P938740	7450
Case			Belt - Blower	P938746	②7430
12+2			220		
Kohl 12 H.P.			Deutz F10L413F Diesel		
Belt - Fan & Alt.	A38824	▲9490HD	Belt - Alt.	T0138776	②7380
Belt - Pump Drive		3VX355	220B		
25+4XP			Deutz F10L413F Diesel		
Wisconsin VH4D			Belt - Alt.	P938762	②7380
Belt - Alt.		6723	320 Loader Backhoe		
30+4			Case 4-Cyl. 148		
Deutz F2L511 Diesel			Belt - Fan & Gen.	VT4886	TR24449
Belt - Alt.		6723	Belt - Fan, Gen. & S.P.	G46083	7270
40XT			Belt - P.S.	G46124	1230
Case 4-390 Diesel			Hose - Upper		24428
2004 - 2002			Hose - Lower		24226
Belt - Fan	J911558	▲K080590HD	Case 4-Cyl. 148 Diesel		
			Belt - Fan & Gen.	G11233	▲9447HD
			Belt - P.S.	G46124	1230

▲Standard Belt Available.
≧Cut to Fit.

②Two Required.
③Three Required.

Road & Construction
Equipment

Belts and Coolant Hose for Road & Construction Equipment

Road & Construction Equipment

Application	Mfr. Part No.	Our No.	Application	Mfr. Part No.	Our No.
Case - Continued			Case - Continued		
320 Loader Backhoe - Continued			430 Skid Steer - Continued		
Case 4-Cyl. 148 Diesel - Continued			Case 445/M2 Diesel - Continued		
Hose - Upper		24428	2010 - 2005 - Continued		
Hose - Lower		@24226	Tensioner Assy. - Fan & Alt.	2852161	38639
320 Wheel Loader			430CK Loader Backhoe		
Case 4-Cyl. 148			Case 4-Cyl. 148		
Belt - Fan & Gen.	VT4886	TR24449	Belt - Fan & Gen.	G46238	♣9476HD
Belt - Fan, Gen. & S.P.	G46083	7270	Hose - Upper		24432
Belt - P.S.	G46124	1230	Hose - Lower		20957
Hose - Upper		24428	Case 4-Cyl. 188 Diesel		
Hose - Lower		24226	Belt - Fan & Alt.	R32782	♣9476HD
Continental 4-Cyl. 157 Diesel			Hose - Upper		24432
Belt - Fan & Gen.; W/O P.S.	G11233	♣9447HD	Hose - Lower		24428
320B Loader Backhoe			435 Skid Steer		
Case 4-Cyl. 148			Case 334T/M2 Diesel		
Belt - Fan & Gen. - Left Side	VT4886	TR24449	2008 - 2005		
Belt - Fan & Gen. - Right Side	G46234	TR24476	Belt - Fan & Alt.	86982540	♣K080590HD
Belt - Fan, Gen. & P.S.	G46083	7270	Belt - A.C.	87438128	♣9390HD
Hose - Upper		24228	440 III		
Hose - Lower		24428	Case 445T/M3 Diesel		
320B Wheel Loader			2012 - 2008		
Case 4-Cyl. 148			Belt - Fan	85826230	♣K080570HD
Belt - Fan & Gen. - Left Side	VT4886	TR24449	440 Skid Steer		
Belt - Fan & Gen. - Right Side	G46238	♣9476HD	Case 445/M2 Diesel		
Belt - Fan, Gen. & P.S.	G46083	7270	2008 - 2005		
Hose - Upper		24228	Belt - Fan & Alt.	85826230	♣K080570HD
Hose - Lower		@24228	Belt - A.C.	87454410	♣9420HD
Continental 4-Cyl. 157 Diesel			Tensioner Assy. - Fan & Alt.	2852161	38639
Belt - Fan & Gen.	G11233	♣9447HD	445 Skid Steer		
Belt - P.S.	G46124	1230	Case 445/M2 Diesel		
350 Crawler			2011 - 2005		
Case 4-Cyl. 188 Diesel			Belt - Fan	86982450	♣K080590HD
Belt - Fan & Alt.	R32782	♣9476HD	Belt - A.C.	87438128	♣9390HD
Hose - Upper		≈20206	Tensioner Assy. - Fan	2852161	38639
		or	450 Crawler		
		26507	Case 4-Cyl. 188 Diesel		
Hose - Lower		@24228	Belt - Fan & Gen.	R32782	♣9476HD
380			Hose - Upper		≈20611
David Brown 3-Cyl. 164 Diesel					or
Belt - Fan & Alt.	A912196	7430	Hose - Lower		26508
Hose - Upper		24224			24228
410 III			450 III		
Case 422T/M3 Diesel			Case 445T/M3 Diesel		
2012 - 2008			2012 - 2008		
Belt - Fan	SBA080109080	A38	Belt - Fan	87681147	♣K080594HD
Belt - A.C.	86401123	♣9470HD	450 Skid Steer		
410 Skid Steer; 420 Skid Steer			Case 445/M2 Diesel		
Case 422/M2 Diesel			2010 - 2005		
2008 - 2004			Belt - Fan	86982450	♣K080590HD
Belt - Fan & Alt.	SBA080109061	A38	Belt - A.C.	87438128	♣9390HD
430 Scatback			Tensioner Assy. - Fan	2852161	38639
Wisconsin VH4D			450B Crawler		
Belt - Alt.	3V400	3VX400	Case 4-Cyl. 188		
430 Skid Steer			Belt - Fan & Alt.; W/O Turbo	A11444	♣9505HD
Case 445/M2 Diesel			Belt - Fan & Alt.; W/Turbo	A22608	②♣9520HD
2010 - 2005			Hose - Upper		≈20611
Belt - Fan & Alt.	85826230	♣K080570HD			or
Belt - A.C.	87454410	♣9420HD	Hose - Lower		26508
					≈20957
					or
					26603

 @Two Required.
 ≈Cut to Fit.

♣Standard Belt Available.

Belts and Coolant Hose for Road & Construction Equipment

Application	Mfr. Part No.	Our No.	Application	Mfr. Part No.	Our No.
Case - Continued			Case - Continued		
450C; 455C			480F; 480FLL		
Case 4-390 Diesel			Case 4-Cyl. 390 Diesel		
Belt - Fan & Alt.	J911563	▲K080605HD	Belt - Fan & Alt.	J911559	▲K080620HD
Tensioner Assy. - Fan & Alt.	J918944	38504	Tensioner Assy. - Fan & Alt.	J918944	38504
465 III			Hose - Upper 26502		
Case 445T/M3 Diesel			500 Travelift; 500B Travelift		
2012 - 2008			Detroit Diesel 3-53 Diesel		
Belt - Fan 87681147		▲K080594HD	Belt - W.P. & Alt. ②7425		
465 Skid Steer			530CK		
Case 445/M2 Diesel			Case 4-Cyl. 159		
2008 - 2005			Belt - Fan & Gen. G46238		
Belt - Fan 86982450		▲K080590HD	Hose - Upper 24432		
Belt - A.C. 87438128		▲9390HD	Hose - Lower 20957		
Tensioner Assy. - Fan 2852161		38639	Case 4-Cyl. 188 Diesel		
480			Belt - Fan & Gen. G46238		
Case 4-Cyl. 148			Hose - Upper 24432		
Belt - Fan & Alt. A38824		▲9490HD	Hose - Lower 24428		
Hose - Upper 24432		20957	550		
Hose - Lower 26602		or	Case 4-390 Diesel		
Case 4-Cyl. 188 Diesel			Belt - Fan, W.P. & Alt. J911563		
Belt - Fan & Alt.; W/Prestolite Alt. A38824		▲9490HD	Tensioner Assy. - Fan, W.P. & Alt. J918944		
Belt - Fan & Alt.; W/Delco Alt. A139089		▲9490HD	580		
Hose - Upper 24432		20957	Case 4-Cyl. 188 Diesel		
Hose - Lower 26602		or	Belt - Fan & Alt. A38824		
480B			Hose - Upper 24432		
Case 4-Cyl. 148			Hose - Lower 24428		
Belt - Fan & Alt. A38824		▲9490HD	580BCK		
Hose - Upper 24432		20957	Case 4-Cyl. 188 Diesel		
Hose - Lower 20957			Belt - Fan & Alt. A38824		
Case 4-Cyl. 188 Diesel			Hose - Upper 24232		
Belt - Fan & Alt.; W/Prestolite Alt. A38824		▲9490HD	Hose - Lower ②24228		
Belt - Fan & Alt.; W/Delco Alt. A135826		▲9490HD	580C		
Hose - Upper 24432		24428	Case 4-Cyl. 207 Diesel		
Hose - Lower 24428			Belt - Fan & Alt. D73446		
480CK			Hose - Upper 20206		
Case 4-Cyl. 148			580CK		
Belt - Fan & Alt.; Ser. No. 2679760 & Before G46238		▲9476HD	Case 4-Cyl. 159		
Belt - Fan & Alt.; Ser. No. 2679761 & After A38824		▲9490HD	Belt - Fan & Alt. A38824		
Hose - Upper 24432		20957	Hose - Upper 24432		
Hose - Lower 20957			Hose - Lower 20957		
Case 4-Cyl. 188 Diesel			Case 4-Cyl. 188; Case 4-Cyl. 188 Diesel		
Belt - Fan & Gen. G46238		▲9476HD	Belt - Fan & Alt. A38824		
Belt - Fan To W.P. & Alt. A38824		▲9490HD	Hose - Upper - Eng. To W.P. 24432		
Hose - Upper 24432		24428	Hose - Upper - Eng. To Rad. 24432		
Hose - Lower 24428			Hose - Lower - Eng. To Rad. 24428		
480D			580D		
Case 4-Cyl. 188 Diesel			Case 4-Cyl. 207 Diesel		
Belt - Fan & Alt. D73446		▲9510HD	Belt - Fan & Alt.; W/O A.C. D73446		
Hose - Upper ②<21379			Belt - Fan & Alt.; W/A.C. D127502		
Case 4-Cyl. 390 Diesel			Belt - A.C. D84316		
Belt - Fan J911559		▲K080620HD	Hose - Upper 21379		
Tensioner Assy. J914086		38504	580E		
480E; 480ELL			Case 4-Cyl. 390 Diesel		
Case 4-Cyl. 390 Diesel			Belt - Fan & Alt. J903099		
Belt - Fan J911559		▲K080620HD	▲K080620HD		
Tensioner Assy. J914086		38504			

▲Standard Belt Available.
②Two Required.

②<Cut to Fit.

Belts and Coolant Hose for Road & Construction Equipment

Application	Mfr. Part No.	Our No.	Application	Mfr. Part No.	Our No.
Case - Continued			Case - Continued		
580K			600 Skid Steer		
Case 4-Cyl. 390 Diesel			Case A336BD Diesel		
Belt - Fan & Alt.	J903099	♣K080620HD	1974 - 1972		
Belt - A.C.	A169970	♣9390HD	Belt - Fan & Alt.	A61048	②TR22578
Tensioner Assy. - Fan & Alt.	J914086	38504	621		
Hose - Upper		26611	Case 6T590 Diesel		
580L			Belt - Fan & Alt.; W/65A. Alt.		
Case 4-Cyl. 390 Diesel			J911566		
Belt - Fan	J921603	♣K080585HD	Belt - Fan & Alt.; W/45A. Alt.	J911559	♣K080620HD
Tensioner Assy.	87326910	38504	Belt - Compr.	S82985	♣9365HD
580M			621B		
Case 4-Cyl. 390 Diesel			Case 6T590 Diesel		
Belt - Fan & Alt.; W/Turbo	86982450	♣K080590HD	Belt - Fan & Alt.	J911566	♣K080638HD
Belt - Fan & Alt.; W/O Turbo	J911573	♣K080615HD	Belt - Fan To A.C.	S82985	②♣9365HD
Tensioner Assy.	87326910	38504	650		
580M II; 580M III			Case 4T390 Diesel		
Case 4-Cyl. 272 Diesel			Belt - Fan & Alt.		
Belt - Fan; W/Std. Fan	85826230	♣K080570HD	Tensioner Assy. - Fan & Alt.	J918944	38504
Belt - Fan; W/Viscous Fan	87415774	K080558	650G Crawler		
580SD			Case 4T390 Diesel		
Case 4-Cyl. 207 Diesel			Belt - Fan, W.P. & Alt.		
Belt - Fan & Alt.	D127502	♣9550HD	Belt - A.C.	S82985	②♣9365HD
Hose - Upper		21379	Tensioner Assy. - Fan, W.P. & Alt.	J918944	38504
580SE			680C		
Case 4-Cyl. 390 Diesel			Case A301BD Diesel		
Belt - Fan	J903099	♣K080620HD	Belt - Fan & Alt.	L49006	②♣9570HD
Tensioner Assy.	87326910	38504	Belt - V.P.	L11403	7365
580SK			Belt - A.C.		
Case 4-Cyl. 390 Diesel			L53604		
Belt - Fan	J911559	♣K080620HD	Hose - Upper		26529
Tensioner Assy.	87326910	38504	Hose - Lower		26529
580SL			680E		
Case 4-Cyl. 390 Diesel			Case 4-Cyl. 336 Diesel		
Belt - Fan	86982450	♣K080590HD	Belt - Fan & Alt.	A59296	②TR24597
Tensioner Assy.	87326910	38504	Belt - Air Brake Compr.; Ser. No. 9121646		
580SL II; 580SM			& Before		
Case 4-Cyl. 390 Diesel			L55580		
Belt - Fan	86982450	♣K080590HD	Belt - Air Brake Compr.; Ser. No. 9121647		
Tensioner Assy.	87326910	38504	& After	L72739	♣9430HD
580SM II; 580SM III; 580SM Plus II; 580SM Plus III			Hose - Lower		
Case 4-Cyl. 390 Diesel			20970		
Belt - Fan	86982450	♣K080590HD	680G		
Tensioner Assy.; W/O Power Shift Trans.	87326910	38504	Case 4-Cyl. 336 Diesel		
580SM II; 580SM III; 580SM Plus II; 580SM Plus III			Belt - Fan & Alt.		
Case 4-Cyl. 272 Diesel			A59296		
Belt - Fan; W/Std. Fan	85826230	♣K080570HD	Belt - Air Brake Compr.	L72739	②TR24597
Belt - Fan; W/Viscous Fan	87415774	K080558	Hose - Lower		♣9430HD
590			20970		
Case 4-Cyl. 390 Diesel			680H		
Belt - Fan	J911559	♣K080620HD	Case A336BDT Diesel		
Tensioner Assy.	87326910	38504	Belt - Fan & Alt.	A59296	TR22607
590SL			Belt - A.C.; Ser. No. 9150699 & Before		
Case 4-Cyl. 390 Diesel			L104202		
Belt - Fan	86982450	♣K080590HD	Belt - A.C.; Ser. No. 9150700 & After	L110264	♣9480HD
Tensioner Assy.	87326910	38504	Belt - Air Brake Compr.; Ser. No. 9150699		♣9510HD
590SL			& Before		
Case 4-Cyl. 390 Diesel			L72739		
Belt - Fan	86982450	♣K080590HD	Belt - Air Brake Compr.; Ser. No. 9150700		♣9430HD
Tensioner Assy.	87326910	38504	& After	L110265	♣9463HD
590SL			680L		
Case 4-Cyl. 390 Diesel			Case 6-Cyl. 590 Diesel		
Belt - Fan	86982450	♣K080590HD	Belt - Fan & Alt.	J911559	♣K080620HD
Tensioner Assy.	87326910	38504	Tensioner Assy. - Fan & Alt.	87326910	38504

♣Standard Belt Available.

②Two Required.

Belts and Coolant Hose for Road & Construction Equipment

Application	Mfr. Part No.	Our No.	Application	Mfr. Part No.	Our No.
Case - Continued			Case - Continued		
688			850G Crawler		
Case 4T390 Diesel			Case 6T590 Diesel		
Belt - Fan & Alt.	J903091	▲K080560HD	Belt - Fan, W.P. & Alt.	J911559	▲K080620HD
Tensioner Assy. - Fan & Alt.	J914086	38504	Belt - A.C.	S82985	▲9365HD
Hose - Upper		26510	Tensioner Assy. - Fan, W.P. & Alt.	J918944	38504
Hose - Lower		26521	855D		
721D			Case 6T590 Diesel		
Case 6T830 Diesel			Case 6T590 Diesel		
Belt - Serpentine	J911567	▲K080670HD	Belt - Fan, W.P. & Alt.	J911559	▲K080620HD
Belt - Fan To A.C.		▲9390HD	Belt - A.C.	R50426	▲9390HD
Hose - Upper		26524	Tensioner Assy. - Fan, W.P. & Alt.	J918944	38504
Hose - Lower - Pipe To Pipe		≧21379	880		
Hose - Lower - Pipe To Rad.		≧21115	Case 4-Cyl. 336 Diesel		
	or	26531	Belt - Fan		
760			Belt - Fan		
Case 4-Cyl. 390 Diesel			Belt - Fan		
Belt - Fan & Alt.	J903091	▲K080560HD	S86287		
Hose - Upper		26502	②TR22625		
Hose - Lower		26520	880B		
780			Case 4-Cyl. 336 Diesel		
Case A336BD Diesel			Belt - Fan		
Belt - Fan & Alt.	L19082	②▲9550HD	S86287		
Belt - Air Brake Compr.: W/Tru-Flow 300 Compr.	L47236	7440	TR22625		
Belt - Air Brake Compr.: W/Tru-Flow 400 Compr.	D81838	▲9470HD	880C		
780B			Case 6-Cyl. 504 Diesel		
Case A336BDT Diesel			Belt - Fan & Alt.		
Belt - Fan & Alt.	A59296	TR22607	L71057		
Belt - Air Brake Compr.	L108218	▲9465HD	②TR22625		
Belt - A.C.	L45532	▲9520HD	Hose - Lower - Eng. To Pipe		
780C			Hose - Lower - Rad. To Pipe		
Case 6-Cyl. 590 Diesel			or		
Belt - Fan & Alt.	J903099	▲K080620HD	24440		
Belt - Air Brake Compr.	D129916	▲9440HD	≧21115		
Belt - A.C.	S94499	▲9530HD	26530		
780D			880D		
Case 6-Cyl. 590 Diesel			Case 6-Cyl. 504 Diesel		
Belt - Fan & Alt.	J911559	▲K080620HD	Belt - Fan & Alt.		
Belt - Air Brake Compr.	D129916	▲9440HD	J903091		
Tensioner Assy.	87326910	38504	▲K080560HD		
800 Skid Steer; 825			Tensioner Assy. - Fan & Alt.		
Case A336BD Diesel			J907469		
1976 - 1972			38504		
Belt - Fan & Alt.	A61048	②TR22578	888		
850B Crawler			Case 6T590 Diesel		
Case A336BD Diesel			Belt - Fan		
Belt - Fan & Alt.	D47563	②TR22570	J911557		
Hose - Lower - Eng. To Pipe		24444	▲K080560HD		
850D Crawler			Tensioner Assy. - Fan		
Case 4-Cyl. 301 Diesel			J914086		
Belt - Fan & Alt.	D43913	②TR22545	38504		
Case 6T590 Diesel			980		
Belt - Fan, W.P. & Alt.	J911559	▲K080620HD	Case 6-Cyl. 504 Diesel		
Belt - A.C.	R50426	▲9390HD	Belt - Fan & Alt.		
Tensioner Assy. - Fan, W.P. & Alt.	J918944	38504	A59296		
880G Crawler			Hose - Lower		
Case 451BD Diesel			②TR22607		
Belt - Fan & Alt.	R27266	②TR22578	24940		
Hose - Upper		21115	980B		
		26530	Case 6-Cyl. 504 Diesel		
	or	26532	Belt - Alt.		
Hose - Lower		26532	S104812		
Hose - By Pass		24220	②TR22578		
1150E			1088		
Case 6T590 Diesel			Case 6T590 Diesel		
Belt - Fan & Alt.	J911559	▲K080560HD	Belt - Fan, W.P. & Alt.		
Belt - A.C.	S82985	▲9365HD	J911557		
Tensioner Assy. - Fan & Alt.	J912246	38504	▲K080560HD		
Tensioner Pulley	J912246	36091	Tensioner Assy. - Fan, W.P. & Alt.		

▲Standard Belt Available.
②Two Required.

≧Cut to Fit.

Belts and Coolant Hose for Road & Construction Equipment

Application	Mfr. Part No.	Our No.	Application	Mfr. Part No.	Our No.
Case - Continued			Case - Continued		
1150E - Continued			1816		
Case 6T830 Diesel			Tecumseh OH160		
Belt - Fan & Alt.	J911561	K080655	1977 - 1973		
Belt - A.C.	R50426	♣9390HD	Belt - Fan & Alt.	D56917	♣9330HD
Tensioner Assy. - Fan & Alt.	J918944	38504	Belt - Hyd. Pump - Loader	D56917	♣9330HD
1150G Crawler			Belt - Hyd. Pump - Steering	D60572	7330
Case 6T590 Diesel			1816C		
Belt - Fan & Alt.	J911559	♣K080620HD	Onan 543M		
Belt - A.C.	S82985	②♣9365HD	1984 - 1982		
Tensioner Assy. - Fan & Alt.	J918944	38504	Belt - Fan & Alt.	D56917	♣9330HD
1155E			Belt - Hyd. Pump - Loader	D56917	♣9330HD
Case 6T590 Diesel			Belt - Hyd. Pump - Steering	D60572	7330
Belt - Fan & Alt.	J911559	♣K080620HD	1818		
Belt - A.C.	S82985	♣9365HD	Kubota Diesel		
Tensioner Assy. - Fan & Alt.	J912246	38504	1997		
Tensioner Pulley	J912246	36091	Belt - Fan	1959646C1	7375
Case 6T830 Diesel			Belt - Eng. To Hyd. Pump	S202900	3V500
Belt - Fan & Alt.	J911561	K080655	Belt - Variable Displacement Pump - Left ...	H438262	A31
Belt - A.C.	R50426	♣9390HD	Belt - Variable Displacement Pump - Right ...	H438262	A31
Tensioner Assy. - Fan & Alt.	J918944	38504	Onan 2-Cyl. 48		
1280			1997 - 1987		
Case 6-Cyl. 504 Diesel			Belt - Eng. To Hyd. Pump	H437092	3V475
Belt - Fan & Alt.	A59296	②TR24597	Belt - Variable Displacement Pump - Left ...	H438262	A31
1280B			Belt - Variable Displacement Pump - Right ...	H438262	A31
Case 6-Cyl. 504 Diesel			1825		
Belt - Fan & Alt.	A59296	②TR24597	Nissan 4-Cyl. 71		
Detroit Diesel 6V-53 Diesel			1997 - 1987		
Belt - Alt.	S211672	②7375	Belt - Fan	1972211C1	7385
1550			Belt - Gov.	1960027C1	♣9309HD
Case 6T830 Diesel			1825B		
Belt - Fan & Alt.; W/65 1/2" Belt O.C.	J911561	K080655	Kubota 4-Cyl. 91 Diesel		
Belt - Fan & Alt.; W/76 1/2" Belt O.C.	J911567	♣K080670HD	2003 - 1997		
Belt - A.C.	R50426	♣9390HD	Belt - Fan	125570A1	7375
Tensioner Assy. - Fan & Alt.	J914086	38504	1835C		
1737			Teledyne 3-Cyl. 123		
Case 4-Cyl. 148			1997 - 1987		
1975 - 1971			Belt - Fan & Alt.	X27019500	♣9500HD
Belt - Fan		♣9570HD	Hose - Lower		26502
Belt - Fan & Alt.		♣9490HD	Hose - By Pass		28441
1740			1838		
Case 4-Cyl. 188 Diesel			Kubota 4-Cyl. 134 Diesel		
1975 - 1971			1999 - 1995		
Belt - Fan		♣9570HD	Belt - Fan	127113A1	♣9430HD
Belt - Fan & Alt.		♣9490HD	1840		
Hose - Upper		26521	Case 4-390 Diesel		
Hose - Lower		21256	2001 - 1989		
	or	26504	Belt - Fan & Alt.	J911558	♣K080590HD
1740 Wheel Loader			Tensioner Assy. - Fan	J918944	38504
Case 4-Cyl. 188 Diesel			Hose - Upper		20046
Belt - Fan		♣9570HD	1845		
Belt - Fan & Alt.		♣9490HD	Case 4-Cyl. 188		
Hose - Upper		26521	1982 - 1974		
Hose - Lower		21256	Hose - Lower		♣20957
	or	26504	Case 4-Cyl. 188 Diesel		
			1982 - 1974		
			Belt - Fan & Alt.	A11444	♣9505HD

♣Standard Belt Available.
 ⓂCut to Fit.

②Two Required.

Belts and Coolant Hose for Road & Construction Equipment

Application	Mfr. Part No.	Our No.	Application	Mfr. Part No.	Our No.
Case - Continued			Case - Continued		
1845C			9060B		
Case 4-390 Diesel			Cummins M11 Diesel		
2001 - 1985			Belt - Fan; Ser. No. EAC0601026 & After ... 171285A1		
Belt - Fan & Alt.	J911558	♣K080590HD	Belt - W.P.; Ser. No. EAC0601025 & Before	134616A1	TR22443
Tensioner Assy. - Fan	J918944	38504	Belt - Fan & Alt.; Ser. No. EAC0601025 & Before	134828A1	TR30589
Hose - Upper		20046	Belt - Compr.; Ser. No. EAC0601025 & Before	162458A1	TR22495
7760			DH4B		
Detroit Diesel 6-71 Diesel			Mitsubishi 4DQ50 Diesel		
Hose - Upper - Eng. To Pipe		26516	Belt - Fan & Alt.		TR22410
Hose - Lower - Eng. To Pipe		24432	Hose - Upper		25476
Hose - Lower - Pipe To Rad.		②24436	DH5		
9010			Case 4-Cyl. 207 Diesel		
Case 4T390 Diesel			Belt - Fan & Alt. AP47		
Belt - Fan, W.P. & Alt.	J911557	♣K080560HD	Hose - Upper		26512
Tensioner Assy. - Fan, W.P. & Alt.	J918944	38504	Hose - Lower		26511
9010B			SR175; SV185		
Case 4T390 Diesel			New Holland ISM N844T/M3 Diesel		
Belt - Fan, W.P. & Alt.	J911557	♣K080560HD	2012 - 2011		
Belt - A.C.	84214730	♣9420HD	Belt - Alt.	47396938	7400
Tensioner Assy. - Fan, W.P. & Alt.	J918944	38504	Belt - A.C.	84323065	♣9490HD
9020			W5		
Case 4T390 Diesel			Case 4-Cyl. 164		
Belt - Fan, W.P. & Alt.	J911557	♣K080560HD	Belt - Fan	G46234	TR24476
Tensioner Assy. - Fan, W.P. & Alt.	J918944	38504	Hose - Lower		20357
9020B			W5A		
Case 4T390 Diesel			Case 4-Cyl. 188; Case 4-Cyl. 188 Diesel		
Belt - Fan, W.P. & Alt.	J911557	♣K080560HD	Belt - Fan	G46238	♣9476HD
Belt - A.C.	84214730	♣9420HD	Belt - Fan & Alt.	A20383	♣9510HD
Tensioner Assy. - Fan, W.P. & Alt.	J918944	38504	W7		
9030			Case 4-Cyl. 284		
Case 6T590 Diesel			Belt - Fan & Alt.	A22608	②♣9520HD
Belt - Fan, W.P. & Alt.	J911557	♣K080560HD	Belt - Fan & Gen.	A17490	②♣9490HD
Tensioner Assy. - Fan, W.P. & Alt.	J918944	38504	Hose - Lower		26510
9030B			Case 4-Cyl. 301 Diesel		
Case 6T590 Diesel			Belt - Fan & Alt.	A21457	♣9505HD
Belt - Fan, W.P. & Alt.	J911557	♣K080560HD	Belt - Fan & Gen.	A17490	②♣9490HD
Belt - A.C.	84214730	♣9420HD	Hose - Lower		26510
Tensioner Assy. - Fan, W.P. & Alt.	J918944	38504	Hose - By Pass		24228
9040; 9040B			W7E		
Case 6T830 Diesel			Case 4-Cyl. 301		
Belt - Fan, W.P. & Alt.	J911572	♣K080610HD	Belt - Fan & Alt.	L19082	②♣9550HD
Tensioner Assy. - Fan, W.P. & Alt.	J918944	38504	Hose - By Pass		24220
9050			Case 4-Cyl. 301 Diesel		
Mitsubishi 6D22T Diesel			Belt - Fan & Alt.	L19082	②♣9550HD
Belt - W.P.	134755A1	TR22434	Belt - V.P.	A18537	7390
9050B			Case 6-Cyl. 377; Case 6-Cyl. 401 Diesel		
Mitsubishi 6D22T Diesel			Belt - Fan & Alt.	A18426	②♣9530HD
Belt - W.P.	134755A1	TR22434	Belt - Fan & Gen.	A22608	②♣9520HD
Belt - Fan & Alt.	134828A1	②TR30589	Belt - V.P.	A18537	7390
Belt - A.C.	162458A1	TR22495	Hose - Upper		23550
9060			Case 6-Cyl. 377; Case 6-Cyl. 401 Diesel		
Mitsubishi 6D22T Diesel			Belt - Fan & Alt.	A18426	②♣9530HD
Belt - W.P.	134616A1	TR22443	Belt - Fan & Gen.	A22608	②♣9520HD
Belt - Fan & Alt.	134828A1	TR30589	Belt - V.P.	A18537	7390
			Hose - Upper		23550
			Hose - Lower		26522
			Hose - By Pass		24224

②Two Required.

♣Standard Belt Available.

Road & Construction Equipment

Belts and Coolant Hose for Road & Construction Equipment

Road & Construction Equipment

Application	Mfr. Part No.	Our No.	Application	Mfr. Part No.	Our No.
Case - Continued			Case - Continued		
W8C			W9B		
Case 6-Cyl. 377			Case 6-Cyl. 377; Case 6-Cyl. 401 Diesel		
Belt - Fan & Alt.	A22608	②♣9520HD	Belt - Fan & Alt.	A18426	②♣9530HD
Hose - Upper		23550	Belt - Fan & Gen.	A22608	②♣9520HD
Hose - Lower		26522	Belt - P.S.; Ser. No. 816001 & Before	A11441	7290
Hose - By Pass		24224	Belt - P.S.; Ser. No. 816002 & After	A14505	7375
Case 6-Cyl. 401 Diesel			Hose - Upper		
Belt - Fan & Alt.	A21457	②♣9505HD	23550		
Belt - V.P.	A18537	7390	Hose - Lower		
Hose - Upper		23550	26522		
Hose - Lower		26522	Hose - By Pass		
Hose - By Pass		24224	24228		
W8E			W9E		
Case 6-Cyl. 377			Case 6-Cyl. 377		
Belt - Fan & Alt.	L19082	②♣9550HD	Belt - Fan & Alt.		
Case 6-Cyl. 401 Diesel			L19082		
Belt - Fan & Alt.	L19082	②♣9550HD	②♣9550HD		
Belt - V.P.	L41636	7400	Case 6-Cyl. 401 Diesel		
W9			Belt - Fan & Alt.		
Case 4-Cyl. 284			L41636		
Belt - Fan & Alt.		②♣9530HD	7400		
Belt - Fan & Gen.; Ser. No. 816001 & Before	A11444	♣9505HD	W10		
Belt - Fan & Gen.; Ser. No. 816002 & After; W/50 3/4" Belt O.C.	A21457	②♣9505HD	Case 6-Cyl. 401 Diesel		
Belt - Fan & Gen.; Ser. No. 816002 & After; W/52 1/4" Belt O.C.	A22608	②♣9520HD	Belt - Fan & Gen.		
Belt - P.S.; Ser. No. 816001 & Before	A11441	7290	A21647		
Belt - P.S.; Ser. No. 816002 & After	A14505	7375	A18426		
Hose - Lower; W/22" Rad.		26510	A16759		
Hose - By Pass		24228	A18537		
Case 4-Cyl. 301 Diesel			Hose - Upper		
Belt - Fan & Alt.		②♣9530HD	23550		
Belt - Fan & Gen.; Ser. No. 816001 & Before	A11444	♣9505HD	Hose - Lower		
Belt - Fan & Gen.; Ser. No. 816002 & After; W/50 3/4" Belt O.C.	A21457	②♣9505HD	26522		
Belt - Fan & Gen.; Ser. No. 816002 & After; W/52 1/4" Belt O.C.	A22608	②♣9520HD	Hose - By Pass		
Belt - P.S.; Ser. No. 816001 & Before	A11441	7290	24228		
Belt - P.S.; Ser. No. 816002 & After	A14505	7375	W10E		
Hose - Upper		24940	Case 6-Cyl. 401 Diesel		
Hose - Lower		26516	Belt - Fan & Alt.		
Hose - By Pass		24228	L19082		
W9A			L41636		
Case 4-Cyl. 284			7400		
Belt - Fan & Alt.	A18426	②♣9530HD	W11		
Belt - Fan & Gen.	A22608	②♣9520HD	Case 4-Cyl. 207 Diesel		
Belt - P.S.	A16759	7375	Belt - Fan & Alt.		
Belt - V.P.	A18537	7390	L57804		
Hose - Upper		23550	♣9500HD		
Hose - Lower		26516	W11B		
Hose - By Pass		24228	Case 4-Cyl. 390 Diesel		
Case 4-Cyl. 301 Diesel			Belt - Fan & Alt.		
Belt - Fan & Alt.		②♣9530HD	J911557		
Belt - Fan & Gen.	A22608	②♣9520HD	♣K080560HD		
Belt - P.S.	A16759	7375	W12		
Hose - Upper		23550	Case 6-Cyl. 451 Diesel		
Hose - Lower		26516	Belt - Fan & Gen.		
Hose - By Pass		24228	A21647		
W9A			A18426		
Case 4-Cyl. 284			A16759		
Belt - Fan & Alt.	A18426	②♣9530HD	A18537		
Belt - Fan & Gen.	A22608	②♣9520HD	7390		
Belt - P.S.	A16759	7375	Hose - Upper		
Belt - V.P.	A18537	7390	23550		
Hose - Upper		23550	Hose - Lower		
Hose - Lower		26516	26522		
Hose - By Pass		24228	Hose - By Pass		
Case 4-Cyl. 301 Diesel			24224		
Belt - Fan & Alt.		②♣9530HD	W14		
Belt - Fan & Gen.	A22608	②♣9520HD	Case A336BD Diesel		
Belt - P.S.	A16759	7375	Belt - Fan & Alt.; W/40A. Alt.		
Hose - Upper		23550	L51181		
Hose - Lower		26516	②TR22553		
Hose - By Pass		24228	Belt - Fan & Alt.; W/65A. Alt.		
W9A			L74972		
Case 4-Cyl. 284			②TR22570		
Belt - Fan & Alt.	A18426	②♣9530HD	Belt - Air Brake Compr.; W/41 7/8" Belt O.C.		
Belt - Fan & Gen.	A22608	②♣9520HD	L51182		
Belt - P.S.	A16759	7375	♣9415HD		
Hose - Upper		23550	Belt - Air Brake Compr.; W/49" Belt O.C.		
Hose - Lower		26516	L57802		
Hose - By Pass		24228	♣9490HD		
Case 4-Cyl. 301 Diesel			Hose - Upper		
Belt - Fan & Alt.		②♣9530HD	24240		
Belt - Fan & Gen.	A22608	②♣9520HD			
Belt - P.S.	A16759	7375			
Hose - Upper		23550			
Hose - Lower		26516			
Hose - By Pass		24228			

 ♣Standard Belt Available.
 ∞Cut to Fit.

②Two Required.

Belts and Coolant Hose for Road & Construction Equipment

Application	Mfr. Part No.	Our No.	Application	Mfr. Part No.	Our No.
Case - Continued			Case - Continued		
W14 - Continued			W24B - Continued		
Case A336BD Diesel - Continued			Case A504BD Diesel - Continued		
Hose - Lower		≅21115	Belt - A.C.	L58838	♣9570HD
	or	26531	Hose - Upper		21115
Hose - By Pass		24220		or	26531
W14B			Hose - Lower		20530
Case 6-Cyl. 590 Diesel				or	26529
Belt - Fan & Alt.; W/40A. Alt.	J903091	♣K080560HD	Hose - By Pass		24220
Belt - Fan & Alt.; W/65A. Alt.	J903093	♣K080580HD	W24C		
Belt - A.C.; W/44" Belt O.C.	A75577	♣9440HD	Case A504BD Diesel		
Belt - A.C.; W/46" Belt O.C.	L110265	♣9463HD	Belt - Fan & Alt.	T38546	②TR22657
W18			Belt - Compr.	L57802	♣9490HD
Case A401BD Diesel			Belt - A.C.	L58838	♣9570HD
Belt - Fan & Alt.; W/30A., 35A. Alt.	L48204	②TR22625	Hose - Upper		21115
Belt - Fan & Alt.; W/70A. Alt.	L51524	②TR22607	Hose - Lower; W/L15781, L109500 Rad.		26529
Belt - Air Brake Compr.; W/Tru-Flow 300 Compr.	L48195	♣9500HD	Hose - By Pass		24220
Belt - Air Brake Compr.; W/Tru-Flow 400 Compr.	L57804	♣9500HD	W26B		
Hose - Upper		21115	Case A504BDT Diesel		
Hose - Lower		≅20760	Belt - Fan & Alt.; Ser. No. 9107521 & After .	T38546	TR22657
Hose - By Pass		24220	Belt - Air Brake Compr.	L45826	♣9520HD
W18B			Belt - A.C.	L16462	♣9400HD
Case 6-Cyl. 504 Diesel			Hose - Lower		26530
Belt - Fan & Alt.; W/40A. Alt.	A59296	②TR24597	Hose - By Pass		24220
Belt - Air Brake Compr.	L112651	♣9480HD	W30		
Belt - A.C.	L59258	TR22578	Case A504BDT Diesel		
Hose - Upper		21115	Belt - Fan & Alt.; W/40A. Alt.	L71057	②TR22625
Hose - Lower		21115	Belt - Fan & Alt.; W/65A. Alt.	T38546	②TR22657
W20			Belt - Compr.	L105654	♣9463HD
Case A401BD Diesel			Belt - A.C.	L71058	♣9470HD
Belt - Fan & Alt.; W/30A., 35A. Alt.	L48204	②TR22625	Hose - Upper		21115
Belt - Fan & Alt.; W/70A. Alt.	L51524	TR22607	Hose - By Pass		24220
Belt - Air Brake Compr.; W/Tru-Flow 300 Compr.	L48195	♣9500HD	W36		
Belt - Air Brake Compr.; W/Tru-Flow 400 Compr.	L57804	♣9500HD	Case A504BDTI Diesel		
Belt - A.C.	L59258	TR22578	Belt - Fan & Alt.; Ser. No. 17754000 & After	J903113	K080644
Hose - Upper		21115	Belt - Fan & Alt.; Ser. No. 17753999 & Before; W/40A. Alt.	L71057	②TR22625
Hose - Lower		20760	Belt - Fan & Alt.; Ser. No. 17753999 & Before; W/65A. Alt.	T38546	②TR22657
Hose - By Pass		24220	Belt - A.C.; Ser. No. 17754000 & After	396829R1	♣9440HD
W20B			Belt - A.C.; Ser. No. 17753999 & Before	L57804	♣9500HD
Case A401BD Diesel			Belt - Compr.; Ser. No. 17753999 & Before	L71058	♣9470HD
Belt - Fan & Alt.	L71057	②TR22625	Hose - Upper; Ser. No. 17753999 & Before		21115
Belt - Air Brake Compr.	L48195	♣9500HD	Caterpillar		
Belt - A.C.	L59258	TR22578	12E (99E)		
Hose - Upper		21115	Caterpillar D333 Diesel		
Hose - Lower		20760	Belt - Gen.; W/47" Belt O.C.	1S5138	TR24465
W20C			Belt - Gen.; W/48 1/8" Belt O.C.	5M5345	TR24476
Case A401BD Diesel			12F (13K)		
Belt - Fan & Alt.; W/40A. Alt.	A59296	②TR24597	Caterpillar D333 Diesel		
Belt - Fan & Alt.; W/65A. Alt.	L71057	②TR22625	Belt - Fan; Ser. No. 13K1 Thru 13K907	5S9506	②TR24688
Belt - Air Brake Compr.	L112651	♣9480HD	Belt - Fan; Ser. No. 13K908 Thru 13K2275	5S9505	②BX65
Belt - A.C.	L59258	TR22578	Belt - Fan & Alt.; Ser. No. 13K2276 & After; W/67" Belt O.C.	8M1715	②TR24664
Hose - Upper		21115	Belt - Fan & Alt.; W/68 3/8" Belt O.C.	5S9505	②BX65
Hose - Lower		21115	Belt - Fan & Gen.	5S9505	②BX65
W24B			Belt - Air Brake Compr.	4M9386	②TR24709
Case A504BD Diesel			Belt - A.C.; W/49 1/4" Belt O.C.	1P3085	♣9490HD
Belt - Fan & Alt.	T38546	②TR22657	Belt - A.C.; W/54 1/4" Belt O.C.	4N6013	♣9540HD
Belt - Air Brake Compr.; W/L14814 Air Compr.	L50593	②♣9490HD	Hose - Upper		24440
			Hose - Lower		24448

♣Standard Belt Available.
≅Cut to Fit.

②Two Required.

Road & Construction Equipment

Belts and Coolant Hose for Road & Construction Equipment

Application	Mfr. Part No.	Our No.	Application	Mfr. Part No.	Our No.
Caterpillar - Continued			Caterpillar - Continued		
12F (73G)			15 (4W)		
Caterpillar D333 Diesel			Caterpillar D326 Diesel		
Belt - Gen.; W/47" Belt O.C.	1S5138	TR24465	Belt - Gov.	5B7168	▲9390HD
Belt - Gen.; W/48 1/8" Belt O.C.	5M5345	TR24476	16 (49G)		
12F (89H)			Caterpillar D343T Diesel		
Caterpillar D333 Diesel			Belt - W.P. & Alt.	8M8335	②▲9640HD
Belt - Fan; Ser. No. 89H1 Thru 89H405	5S9506	②TR24688	Belt - Alt./Gen.	5S1817	②▲9650HD
Belt - Fan; Ser. No. 89H406 Thru 89H572 ..	5S9505	②BX65	Belt - A.C.	4N6130	▲9520HD
Belt - Fan; Ser. No. 89H573 & After	8M1715	②TR24664	Hose - Upper; Ser. No. 49G1 & After		24448
Belt - Alt.; W/67" Belt O.C.	8M1715	②TR24664	Hose - Lower; Ser. No. 49G1 & After		24460
Belt - Alt.; W/68 3/8" Belt O.C.	5S9505	②BX65	30D MH (LEM)		
Belt - Air Brake Compr.	4M9386	②TR24709	Caterpillar C9 Diesel		
Belt - A.C.; W/49 1/4" Belt O.C.	1P3085	▲9490HD	Belt - Fan	1834494	▲K080859HD
Belt - A.C.; W/54 1/4" Belt O.C.	4N6013	▲9540HD	Tensioner Assy.	1900643	38620
Hose - Upper; Ser. No. 89H1 & After		24444	66 (4D)		
Hose - Lower; Ser. No. 89H1 & After		24448	Caterpillar Diesel		
12G (61M)			Belt - Fan	3B6909	③TR24578
Caterpillar 3306 Diesel			70 (8C)		
Belt - Fan & Alt.; W/72 5/8" Belt O.C.	5H7448	②TR30722	Caterpillar Diesel		
Hose - Upper - Eng. To Pipe		24440	Belt - Gov.	4B2544	▲9425HD
Hose - Upper - Pipe To Rad.		24440	77 (4D)		
Hose - Lower - Eng. To Pipe		24448	Caterpillar Diesel		
Hose - Lower - Pipe To Rad.		24448	Belt - Fan	3B6909	③TR24578
14B (64C)			80 (5W)		
Caterpillar D333T Diesel			Caterpillar Diesel		
Belt - Gov.	4B2544	▲9425HD	Belt - Gov.; W/39 1/4" Belt O.C.	5B7168	▲9390HD
14D (96F)			Belt - Gov.; W/42 3/4" Belt O.C.	4B2544	▲9425HD
Caterpillar D333T Diesel			112E (91G)		
Belt - Gen.; W/47" Belt O.C.	1S5138	TR24465	Caterpillar D330 Diesel		
Belt - Gen.; W/48 1/8" Belt O.C.	5M5345	TR24476	Belt - Gen.	6B8536	TR28628
14E (12K)			112F (89J)		
Caterpillar D333T Diesel			Caterpillar D333 Diesel		
Belt - Fan & Alt.; Ser. No. 12K1 Thru			Belt - Fan; Ser. No. 89J1 Thru 89J707	7S9802	②TR24664
12K364	5S9505	②BX65	Belt - Fan; Ser. No. 89J708 & After	7S9812	②TR24647
Belt - Fan & Alt.; Ser. No. 12K365 Thru			Belt - Gen.	7S9857	②TR24638
12K1002	5S9506	②TR24688	Belt - A.C.	2P6818	▲9470HD
14E (72G)			120 (10R); 120 (13U)		
Caterpillar D333T Diesel			Caterpillar D333 Diesel		
Belt - Fan & Alt.; Ser. No. 72G1 Thru			Belt - Fan	8M1715	②TR24664
72G244	5S9506	②TR24688	Belt - Fan & A.C.	7M5535	②TR24709
Belt - Fan & Alt.; Ser. No. 72G245 & After ..	5S9505	②BX65	Belt - A.C.		▲9490HD
Belt - Air Brake Compr.	4M9386	②TR24709	120 (14K)		
Belt - A.C.; W/52 3/4" Belt O.C.	2P4191	▲9525HD	Caterpillar D333 Diesel		
Belt - A.C.; W/54 1/4" Belt O.C.	4N6013	▲9540HD	Belt - Fan; Ser. No. 14K1 Thru 14K1103	5S9506	②TR24688
Hose - Upper; Ser. No. 72G1 & After		24444	Belt - Fan; Ser. No. 14K1104 Thru		
Hose - Lower; Ser. No. 72G1 & After		24448	14K1569	5S9505	②BX65
14E (99G)			Belt - Fan; Ser. No. 14K1570 & After	8M1715	②TR24664
Caterpillar D333T Diesel			Belt - Fan & A.C.	4M9386	②TR24709
Belt - Gen.; W/47" Belt O.C.	1S5138	TR24465	Belt - Alt.; W/67" Belt O.C.	8M1715	②TR24664
Belt - Gen.; W/48 1/8" Belt O.C.	5M5345	TR24476	Belt - Alt.; W/68 3/8" Belt O.C.	5S9505	②BX65
14G (96U)			Belt - Gen.	5S9505	②BX65
Caterpillar 3306T Diesel			Belt - A.C.	1P3085	▲9490HD
Belt - Fan & Alt.	7B344	TR30722	120 (89G)		
Belt - A.C.	1P9744	▲9415HD	Caterpillar D333 Diesel		
Hose - Upper		②24440	Belt - Gen.; W/47" Belt O.C.	1S5138	TR24465
Hose - Lower		②24448			

②Two Required.
③Three Required.

▲Standard Belt Available.

Belts and Coolant Hose for Road & Construction Equipment

Application	Mfr. Part No.	Our No.	Application	Mfr. Part No.	Our No.
Caterpillar - Continued			Caterpillar - Continued		
120 (89G) - Continued			206 (2RC)		
Caterpillar D333 Diesel - Continued			Deutz F4L912 Diesel		
Belt - Gen.; W/48 1/8" Belt O.C.	5M5345	TR24476	Belt - Fan	5W4713	7508
120G (87V)			Belt - Alt.	5W4712	7435
Caterpillar 3304T Diesel			Belt - Compr.	5W2826	▲9425HD
Belt - A.C.	1P9744	▲9415HD	206 (3GC)		
130G (74V)			Perkins 4.236 Diesel		
Caterpillar 3304T Diesel			Belt - Alt.	5M8135	▲9510HD
Belt - Fan & Alt.		②TR30722	206B (9BF)		
Belt - A.C.	1P9744	▲9415HD	Caterpillar 3114T Diesel		
Hose - Upper		②24440	Belt - Fan	9L1127	②▲9570HD
Hose - Lower		③24448	Belt - W.P.	0366775	▲9341HD
140 (11R)			Belt - Compr.	1P9744	▲9412HD
Caterpillar D333 Diesel			211B (6XG)		
Belt - Fan		②TR24664	Caterpillar 3114T Diesel		
Belt - Fan & A.C.	4M9386	②TR24709	Belt - Fan	9L1127	②▲9570HD
Belt - A.C.	4N6013	▲9540HD	Belt - W.P.	0618384	▲9335HD
140 (14U)			Belt - Compr.	1P9744	▲9412HD
Caterpillar D333 Diesel			212 (5DC)		
Belt - Fan; W/68 3/8" Belt O.C.	5S9505	②BX65	Perkins 4.236 Diesel		
Belt - Fan; W/71 1/8" Belt O.C.	4M9386	②TR24709	Belt - Alt.	5M8135	▲9510HD
Belt - Fan & A.C.	4M9386	②TR24709	212B (3PJ)		
Belt - Air Brake Compr.	4M9386	②TR24709	Caterpillar 3114T Diesel		
Belt - A.C.; W/52 3/4" Belt O.C.	2P4191	▲9525HD	Belt - Fan	9L1127	②▲9570HD
Belt - A.C.; W/54 1/4" Belt O.C.	4N6013	▲9540HD	Belt - W.P.	0366775	▲9341HD
Hose - Upper		24440	Belt - Compr.	1P9744	▲9412HD
Hose - Lower		24452	213 (3ZC)		
140 (24R)			Perkins 6.354 Diesel		
Caterpillar D333 Diesel			Belt - Alt.	5L3308	②▲9530HD
Belt - Fan		②TR24664	213B (1EJ)		
Belt - Fan & A.C.	4M9386	②TR24709	Caterpillar 3114 Diesel		
Belt - A.C.	4N6013	▲9540HD	Belt - Fan	9L1128	②▲9570HD
140G (13W)			Belt - W.P.	0618384	▲9335HD
Caterpillar 3306T Diesel			214 (1KB)		
Belt - Fan & Alt.		②TR28733	Perkins 6.354 Diesel		
Hose - Upper		②24440	Belt - Alt.	5L3308	②▲9530HD
Hose - Lower		②24448	214B (4CF); 214B FT (9MF)		
140G (72V)			Caterpillar 3116T Diesel		
Caterpillar 3306 Diesel			Belt - Fan; W/Std. Fan	9L1128	②▲9570HD
Belt - Fan & Alt.	5H7448	TR30722	Belt - Fan; W/High Ambient Temp. Fan	2S2756	②▲9555HD
Belt - A.C.	1P9744	▲9415HD	Belt - W.P.	0366775	▲9341HD
Hose - Upper		②24440	215 (14Z); 215 (57Y); 215 (61Z)		
Hose - Lower		②24448	Caterpillar 3204 Diesel		
160H			Belt - Fan; W/Std. Fan	1N4223	②▲9435HD
Caterpillar 3306 Diesel			Belt - Fan; W/High Ambient Temp. Fan	1W3402	▲9451HD
Belt - Fan To Alt.	166-3351	▲9710HD	Belt - Alt.	8S5154	②▲9650HD
205 (3HC); 205 (4DC)			Belt - Compr.	1W9693	▲9740HD
Deutz F4L912 Diesel			Hose - Upper		20957
Belt - Fan	5W4713	7508	215 (95Z)		
Belt - Alt.	5W4712	7435	Caterpillar 3304 Diesel		
205B (5ZF)			Belt - Alt.	7M4711	②TR28545
Caterpillar 3114T Diesel			215 (96L)		
Belt - Fan	9L1127	②▲9570HD	Caterpillar 3304 Diesel		
Belt - W.P.	0618384	▲9335HD	Belt - Fan	7M4711	②TR28545
Belt - Compr.	1P9744	▲9415HD			

▲Standard Belt Available.
③Three Required.

②Two Required.

Road & Construction Equipment

Belts and Coolant Hose for Road & Construction Equipment

Road & Construction Equipment

Application	Mfr. Part No.	Our No.	Application	Mfr. Part No.	Our No.
Caterpillar - Continued			Caterpillar - Continued		
215B (2XC)			225 (61X)		
Caterpillar 3204 Diesel			Caterpillar 3208 Diesel		
Belt - Fan; W/Std. Fan	1N4223	②♣9435HD	Belt - Alt.	9S6760	③♣9510HD
Belt - Fan; W/High Ambient Temp. Fan	1W3402	♣9451HD	Belt - Compr.	3P0130	♣9500HD
Belt - Alt.	8S5154	②♣9650HD	225 (76U)		
Belt - Compr.	1W9693	♣9740HD	Caterpillar 3304 Diesel		
Hose - Upper		20957	Belt - Fan	7M4711	②TR28545
215B (4FC); 215B (4JC); 215B (9YB); 215C (4HG)			Belt - Alt.	4N6529	6968BR
Caterpillar 3304 Diesel			225B (2ZD)		
Belt - Fan; W/Std. Fan	7M4711	②TR28545	Caterpillar 3208 Diesel		
Belt - Fan; W/High Ambient Temp. Fan	7M4715	②TR30589	Belt - Alt.	9S6760	③♣9510HD
215D (9TF)			Belt - Compr.	9L1130	♣9670HD
Caterpillar 3304 Diesel			225B (3YD)		
Belt - Fan; W/Std. Fan	7E5097	②TR30543	Caterpillar 3304 Diesel		
Belt - Fan; W/High Ambient Temp. Fan	7E5113	②TR34545	Belt - Fan	7M4711	②TR28545
Belt - Compr.	7C2163	♣9309HD	Belt - Alt.	7M4716	②TR28628
Hose - By Pass		24236	225D (2SJ)		
216 (4NZ)			Caterpillar 3208 Diesel		
Caterpillar 3024C Diesel			Belt - Fan; W/High Ambient Temp. Fan	7E5799	③♣9600HD
2005 - 2000			Belt - Fan; W/Std. Fan	5N4851	③♣9555HD
Belt - Alt.	5L3834	♣9447HD	Belt - Alt.	9S6760	③♣9510HD
Belt - W.P.	2516789	♣9395HD	Belt - Compr.	6F2590	♣9710HD
Belt - A.C.	2P6818	♣9470HD	225D (6RG)		
216B (RLL)			Caterpillar 3304 Diesel		
Caterpillar 3024C Diesel			Belt - Fan	7M4711	②TR28545
2008 - 2004			Belt - Alt.	4N6529	6968BR
Belt - W.P.	2516789	♣9395HD	Belt - Compr.	1P6868	♣9610HD
216B III (DSN); 216B III (JXM)			226 (5FZ)		
Caterpillar C2.2 Diesel			Caterpillar 3034 Diesel		
2013 - 2010			2004 - 1999		
Belt - W.P.	2115172	♣9400HD	Belt - Alt.	5L3834	♣9447HD
219 (5CF)			Belt - W.P.	2516789	♣9395HD
Caterpillar 3304 Diesel			Belt - A.C.	2P6818	♣9470HD
Belt - Fan; W/High Ambient Temp. Fan	7M4715	②TR30589	226B (MJH)		
219D (5XG)			Caterpillar 3024C T Diesel		
Caterpillar 3304 Diesel			2008 - 2004		
Belt - Fan; W/Std. Fan	7E5097	②TR30543	Belt - W.P.	2516789	♣9395HD
Belt - Fan; W/High Ambient Temp. Fan	7E5113	②TR34545	226B II		
Belt - Compr.	7C2163	♣9309HD	Caterpillar 3024C T Diesel		
Hose - By Pass		24236	2007		
224 (5TC)			Belt - W.P.	2516789	♣9395HD
Perkins 6.354 Diesel			226B III (AS2)		
Belt - Alt.	4N8771	②♣9530HD	Caterpillar C2.2 T Diesel		
224B (7WF)			2013 - 2010		
Caterpillar 3116T Diesel			Belt - W.P.	2115172	♣9400HD
Belt - Fan	9L1128	②♣9570HD	226B III (MWD); 226B III (SNA)		
Belt - W.P.	0618384	♣9335HD	Caterpillar C2.2 Diesel		
225 (20S)			2013 - 2010		
Caterpillar 3304T Diesel			Belt - W.P.	2115172	♣9400HD
Belt - Fan	7M4715	②TR30589	228 (6BZ)		
225 (51U)			Caterpillar 3034 Diesel		
Caterpillar 3208 Diesel			2003 - 2000		
Belt - Fan & Alt.	3N1490	④♣9510HD	Belt - Alt.	5L3834	♣9447HD
Belt - A.C.	3P130	♣9500HD	Belt - W.P.	2516789	♣9395HD
			Belt - A.C.	2P6818	♣9470HD

♣Standard Belt Available.
④Four Required.

②Two Required.
③Three Required.

Belts and Coolant Hose for Road & Construction Equipment

Application	Mfr. Part No.	Our No.	Application	Mfr. Part No.	Our No.
Caterpillar - Continued			Caterpillar - Continued		
229 (1AG)			236B II		
Caterpillar 3304 Diesel			Caterpillar 3044C Diesel		
Belt - Fan	7M4711	②TR28545	2011 - 2008		
Belt - Alt	7M4716	②TR28628	Belt - W.P.	3524169	♣9470HD
229 (1GF)			236B III (A9H)		
Caterpillar 3208 Diesel			Caterpillar C3.4 Diesel		
Belt - Alt	9S6760	③♣9510HD	2012 - 2010		
Belt - Compr.	9L1130	♣9670HD	Belt - W.P.	3524169	♣9470HD
229D (2LJ)			Belt - Compr.	2583539	♣9380HD
Caterpillar 3304 Diesel			242 (CMB)		
Belt - Fan	7M4711	②TR28545	Caterpillar 3034 Diesel		
Belt - Alt	4N6529	6968BR	2004 - 2002		
Belt - Compr.	1P6868	♣9610HD	Belt - Alt	8N3504	♣9395HD
231D (1NK); 231D (5WJ)			Belt - W.P.	2516789	♣9395HD
Caterpillar 3208T Diesel			Belt - A.C.	2P6818	♣9470HD
Belt - Fan; W/High Ambient Temp. Fan	7E5799	③♣9600HD	242B (BXM)		
Belt - Fan; W/Std. Fan	5N4851	③♣9555HD	Caterpillar 3024C T Diesel		
Belt - Alt	3N1491	③♣9510HD	2008 - 2004		
Belt - Compr.	6F2590	♣9710HD	Belt - W.P.	2516789	♣9395HD
232 (CAB)			242B III (SRS)		
Caterpillar 3024C Diesel			Caterpillar C3.4 Diesel		
2004 - 2002			2013 - 2010		
Belt - Alt	8N3504	♣9395HD	Belt - W.P.	3524169	♣9470HD
Belt - W.P.	2516789	♣9395HD	Belt - Compr.	2583539	♣9380HD
Belt - A.C.	2P6818	♣9470HD	245 (82X); 245 (84X)		
232B (SCH)			Caterpillar 3406 Diesel		
Caterpillar 3024C Diesel			Belt - Fan	4N6302	③B73
2008 - 2004			Belt - Alt	6N0073	TR22720
Belt - W.P.	2516789	♣9395HD	Belt - Compr.	8M3092	9770
235 (32K); 235 (62X); 235 (64R); 235 (81X); 235 (83X); 235B (1FD); 235B (4ED); 235B (7WC); 235B (9PC)			Hose - Upper		24440
Caterpillar 3306 Diesel			Hose - Lower		24448
Belt - Alt	4N6529	6968BR	245 (94L)		
Belt - Compr.	4N7335	♣9430HD	Caterpillar 3406T Diesel		
Hose - Lower		24440	Belt - Fan	4N6302	③B73
235C (2PG); 235C (3WG); 235C (5AF); 235D (8KJ)			Belt - Alt	6N0073	TR22720
Caterpillar 3306 Diesel			Belt - Compr.	9L1629	♣9740HD
Belt - Fan	7M4711	②TR28545	Hose - Upper		24440
Belt - Alt	4N6529	6968BR	Hose - Lower		24448
Belt - Compr.	7C2163	♣9309HD	245 (95V)		
Hose - Lower		24440	Caterpillar 3406 Diesel		
235D (8TJ)			Belt - Fan	4N6302	③B73
Caterpillar 3306 Diesel			Belt - Alt	6N0073	TR22720
Belt - Fan	7M4711	②TR28545	Belt - Compr.	8M3092	9770
Belt - Alt	4N6529	6968BR	Hose - Upper		24440
Belt - Compr.	7C2163	♣9309HD	Hose - Lower		24448
236 (4YZ)			245B (1SJ); 245B (6MF)		
Caterpillar 3034 Diesel			Caterpillar 3406 Diesel		
2004 - 1999			Belt - Fan	4N6302	②B73
Belt - Alt	5L3834	♣9447HD	Belt - Alt	7N8538	BX81
Belt - A.C.	2P6818	♣9470HD	Belt - Compr.	5M0923	A73
236B (HEN)			Hose - Upper		24440
Caterpillar 3044C Diesel			Hose - Lower		24448
2008 - 2003			245D (4LK); 245D (7ZJ)		
Belt - W.P.	3524169	♣9470HD	Caterpillar 3406 Diesel		
			Belt - Fan	4P8087	③TR22770
			Belt - Alt	7N8538	BX81
			Belt - Compr.	5M0923	A73
			Hose - Upper		24440

②Two Required.
③Three Required.

♣Standard Belt Available.

Road & Construction Equipment

Belts and Coolant Hose for Road & Construction Equipment

Application	Mfr. Part No.	Our No.	Application	Mfr. Part No.	Our No.
Caterpillar - Continued			Caterpillar - Continued		
245D (4LK); 245D (7ZJ) - Continued			256C (DWS) - Continued		
Caterpillar 3406 Diesel - Continued			Caterpillar 3044C Diesel - Continued		
Hose - Lower		24448	2011 - 2006 - Continued		
246 (5SZ)			Belt - Compr.	2583539	♣9380HD
Caterpillar 3034T Diesel			Caterpillar C3.4 Diesel		
2004 - 2000			2012 - 2011		
Belt - Alt.	5L3834	♣9447HD	Belt - W.P.	3524169	♣9470HD
Belt - A.C.	2P6818	♣9470HD	Belt - Attachment Drive	2475895	BX57
246B (PAT)			Belt - Compr.	2583539	♣9380HD
Caterpillar 3034T Diesel			307 (2WM)		
2007 - 2004			Caterpillar 3054 Diesel		
Belt - W.P.	3524169	♣9470HD	Belt - Fan	5M8135	♣9510HD
Caterpillar 3044C Diesel			Belt - Compr.	0617139	♣9425HD
2007 - 2005			311 (2KM); 311 (9LJ)		
Belt - W.P.	3524169	♣9470HD	Caterpillar 3064 Diesel		
246C (JAY)			Belt - Fan	0969527	ⓂTR22461
Caterpillar 3044C Diesel			Belt - Alt.	1R7171	ⓂBX44
2011 - 2007			Belt - Compr.	1W5555	♣9435HD
Belt - W.P.	3524169	♣9470HD	311B (2LS); 311B (8GR); 311B (9MR)		
Belt - Compr.	2583539	♣9380HD	Caterpillar 3064T Diesel		
Caterpillar C3.4 Diesel			Belt - Fan	5I8115	ⓂBX45
2013 - 2010			Belt - Alt.	1352409	ⓂTR22485
Belt - W.P.	3524169	♣9470HD	Belt - Compr.	0685590	♣9440HD
Belt - Compr.	2583539	♣9380HD	311C (CKE); 311C (CLK)		
248 (6LZ)			Caterpillar 3064 Diesel		
Caterpillar 3034 Diesel			Belt - Fan	2175420	ⓂTR22485
2004 - 2000			Belt - Compr.	2553014	♣9463HD
Belt - Alt.	5L3834	♣9447HD	311C (PAD)		
Belt - A.C.	2P6818	♣9470HD	Caterpillar 3064 Diesel		
248B (SCL)			Belt - Compr.	2553014	♣9463HD
Caterpillar 3044C Diesel			311D LRR (AKW); 311D LRR (CLA); 311D LRR (DDW); 311D LRR (DWR)		
2007 - 2003			Caterpillar C4.2 Diesel		
Belt - W.P.	3524169	♣9470HD	Belt - Fan & Alt.; W/Idler	3109592	♣K090609HD
252 (FDG)			Belt - Fan & Alt.; W/O Idler	3109543	K090490HD
Caterpillar 3034 Diesel			Belt - Compr.	2553016	♣9455HD
2003 - 2001			311D LRR (LKA)		
Belt - Alt.	5L3834	♣9447HD	Caterpillar C4.2 Diesel		
Belt - A.C.	2P6818	♣9470HD	Belt - Fan & Alt.	3109543	K090490HD
252B (SCP)			Belt - Compr.	2553016	♣9455HD
Caterpillar 3044C Diesel			311D LRR (PNJ)		
2007 - 2003			Caterpillar C4.2 Diesel		
Belt - W.P.	3524169	♣9470HD	Belt - Fan & Alt.; W/Idler	3109592	♣K090609HD
252B II			Belt - Fan & Alt.; W/O Idler	3109543	K090490HD
Caterpillar 3044C Diesel			Belt - Compr.	2553016	♣9455HD
2011 - 2007			312 (6BL)		
Belt - W.P.	3524169	♣9470HD	Caterpillar 3064T Diesel		
252B III (TNK)			Belt - Fan; W/Std. Fan	1013282	Ⓜ♣9530HD
Caterpillar C3.4 Diesel			Belt - Fan; W/High Ambient Temp. Fan	0617140	Ⓜ♣9540HD
2013 - 2010			Belt - Compr.	1W5555	♣9435HD
Belt - W.P.	3524169	♣9470HD	312 (6GK)		
Belt - Compr.	2583539	♣9380HD	Caterpillar 3064T Diesel		
256C (DWS)			Belt - Fan	0969527	ⓂTR22461
Caterpillar 3044C Diesel			Belt - Alt.	1R7171	ⓂBX44
2011 - 2006			Belt - Compr.	1W5555	♣9435HD
Belt - W.P.	3524169	♣9470HD			
Belt - Attachment Drive	2475895	BX57			

♣Standard Belt Available.

ⓂTwo Required.

Belts and Coolant Hose for Road & Construction Equipment

Application	Mfr. Part No.	Our No.	Application	Mfr. Part No.	Our No.
Caterpillar - Continued			Caterpillar - Continued		
312B (2KW)			312D (HJX); 312D (KCD)		
Caterpillar 3054T Diesel			Caterpillar C4.2 Diesel		
Belt - Fan	1013282	②▲9530HD	Belt - Fan & Alt.	3109543	K090490HD
Belt - Compr.	0617139	▲9425HD	Belt - Compr.	2553016	▲9455HD
312B (2NS); 312B (3ES); 312B (3FS)			312D (LRK)		
Caterpillar 3064T Diesel			Caterpillar C4.2 Diesel		
Belt - Fan	518115	②BX45	Belt - Fan & Alt.; W/Idler	3109592	▲K090609HD
Belt - Alt.	1352409	②TR22485	Belt - Fan & Alt.; W/O Idler	3109543	K090490HD
Belt - Compr.	0685590	▲9440HD	Belt - Compr.	2553016	▲9455HD
312B (6SW)			312D (PHH)		
Caterpillar 3054 Diesel			Caterpillar C4.2 Diesel		
Belt - Fan	1013282	②▲9530HD	Belt - Fan & Alt.	3109543	K090490HD
Belt - Compr.	0617139	▲9425HD	Belt - Compr.	2553016	▲9455HD
312B (8JR)			312D (RHL); 312D L (JBC); 312D L (KES); 312D L (L5W)		
Caterpillar 3054 Diesel			Caterpillar C4.2 Diesel		
Belt - Fan	518115	②BX45	Belt - Fan & Alt.; W/Idler	3109592	▲K090609HD
Belt - Alt.	1352409	②TR22485	Belt - Fan & Alt.; W/O Idler	3109543	K090490HD
Belt - Compr.	0685590	▲9440HD	Belt - Compr.	2553016	▲9455HD
312B (9FS)			312D L (RKF); 312D L (SKA)		
Caterpillar 3064T Diesel			Caterpillar C4.2 Diesel		
Belt - Fan	1013282	②▲9530HD	Belt - Fan & Alt.	3109543	K090490HD
Belt - Compr.	0617139	▲9425HD	Belt - Compr.	2553016	▲9455HD
312B (9GR); 312B (9HR)			312D L (TGY); 312D L (XGK)		
Caterpillar 3064T Diesel			Caterpillar C4.2 Diesel		
Belt - Fan	518115	②BX45	Belt - Fan & Alt.; W/Idler	3109592	▲K090609HD
Belt - Alt.	1352409	②TR22485	Belt - Fan & Alt.; W/O Idler	3109543	K090490HD
Belt - Compr.	0685590	▲9440HD	Belt - Compr.	2553016	▲9455HD
312B (9NW)			312D2 (KLE); 312D2 GC (RXZ); 312D2 L (MGJ)		
Caterpillar 3054 Diesel			Caterpillar 3054C Diesel		
Belt - Fan	1013282	②▲9530HD	Belt - Fan	2985872	▲K080694HD
Belt - Compr.	0617139	▲9425HD	312E (GAC); 312E (PZL); 312E L (MJD); 312E L (WEY)		
312C (BNN)			Caterpillar C4.4 Diesel		
Caterpillar 3064T Diesel			Belt - Fan	2985880	▲K080716HD
Belt - Fan	1013282	②▲9530HD	313B (AEX); 313B (BAS); 313B (9PR); 313C (HGF)		
Belt - Compr.	9M1091	▲9463HD	Mitsubishi 4D34TE1 Diesel		
312C (BWH); 312C (CAE); 312C (CBA)			Belt - Compr.	1251795	▲9610HD
Caterpillar 3064T Diesel			313D (KXD); 313D (WPK); 313D CR (LCE); 313D SR (LBR)		
Belt - Fan	2175420	②TR22485	Caterpillar C4.4 Diesel		
Belt - Compr.	9M1091	▲9463HD	Belt - Fan & Alt.	3109543	K090490HD
312C (CBT)			Belt - Compr.	2553016	▲9455HD
Caterpillar 3064T Diesel			313D2 (PLD)		
Belt - Fan	1013282	②▲9530HD	Caterpillar C4.4 Diesel		
Belt - Compr.	9M1091	▲9463HD	Belt - Fan	2985872	▲K080694HD
312C (DBN); 312C (FDS)			314C (KHB); 314C (KJA); 314C (PCA)		
Caterpillar 3064T Diesel			Caterpillar 3064T Diesel		
Belt - Fan	2175420	②TR22485	Belt - Fan	518115	②BX45
Belt - Compr.	9M1091	▲9463HD	Belt - W.P.	2175420	②TR22485
312D (DLP); 312D (FBJ); 312D (HCW)			Belt - Compr.	2553015	▲9440HD
Caterpillar C4.2 Diesel			Belt - Fan & Alt.; W/Idler	3109592	▲K090609HD
Belt - Fan & Alt.; W/Idler	3109543	K090490HD	Belt - Fan & Alt.; W/O Idler	3109543	K090490HD
Belt - Compr.	2553016	▲9455HD	Belt - Compr.	2553015	▲9440HD

▲Standard Belt Available.

②Two Required.

Road & Construction Equipment

Belts and Coolant Hose for Road & Construction Equipment

Application	Mfr. Part No.	Our No.	Application	Mfr. Part No.	Our No.
Caterpillar - Continued			Caterpillar - Continued		
314C (SNY)			315B L (3AW) - Continued		
Caterpillar 3064T Diesel			Caterpillar 3054 Diesel - Continued		
Belt - Fan	2175420	ⓉTR22485	Belt - Fan; W/High Ambient Temp. Fan	1477177	ⓉBX47
Belt - Compr.	2553015	♣9440HD	Belt - Compr.	8L8646	♣9470HD
314D CR (MFK); 314D CR (PDP); 314D CR (WLN); 314D LCR (BYJ)			315B L (5SW)		
Caterpillar C4.2 Diesel			Caterpillar 3054 Diesel		
Belt - Fan & Alt.; W/Idler	3109592	♣K090609HD	Belt - Fan	1013282	Ⓣ♣9530HD
Belt - Fan & Alt.; W/O Idler	3109778	♣K090609HD	Belt - Compr.	0617139	♣9425HD
Belt - Compr.	2553016	♣9455HD	315B L (7RZ)		
314D LCR (SBP)			Caterpillar 3054 Diesel		
Caterpillar C4.2 Diesel			Belt - Fan; W/Std. Fan		
Belt - Fan & Alt.; W/Idler	3109592	♣K090609HD	Belt - Fan; W/High Ambient Temp. Fan	1477177	ⓉBX47
Belt - Fan & Alt.; W/O Idler	3109543	K090490HD	Belt - Compr.	8L8646	♣9470HD
Belt - Compr.	2553016	♣9455HD	315C (AKE)		
314D LCR (SSZ)			Caterpillar 3046 Diesel		
Caterpillar C4.2 Diesel			Belt - Fan		
Belt - Fan & Alt.; W/Idler	3109592	♣K090609HD	Belt - Compr.	2553014	ⓉTR22514
Belt - Fan & Alt.; W/O Idler	3109778	♣K090609HD	315C (ANF); 315C (BTL)		
Belt - Compr.	2553016	♣9455HD	Caterpillar 3046T Diesel		
314D LCR (TXN)			Belt - Fan		
Caterpillar C4.2 Diesel			Belt - Compr.		
Belt - Fan & Alt.	3109543	K090490HD	Belt - Fan	5M8135	Ⓣ♣9510HD
Belt - Compr.	2553016	♣9455HD	Belt - Compr.	6L3408	♣9476HD
314D LCR (XHR)			315C (CFB)		
Caterpillar C4.2 Diesel			Caterpillar 3046 Diesel		
Belt - Fan & Alt.; W/Idler	3109592	♣K090609HD	Belt - Fan		
Belt - Fan & Alt.; W/O Idler	3109778	♣K090609HD	Belt - Compr.	2553014	ⓉTR22514
Belt - Compr.	2553016	♣9455HD	315C (CFL); 315C (CFT); 315C (CJC)		
314E CR (ECN); 314E LCR (DKD); 314E LCR (YCW); 314E LCR (ZJT)			Caterpillar 3046T Diesel		
Caterpillar C4.4 Diesel			Belt - Fan		
Belt - Fan	2985880	♣K080716HD	Belt - Compr.	2553014	ⓉTR22514
315 (3ZM)			315D L (BYK); 315D L (BZN); 315D L (CJN); 315D L (JGS); 315D L (JHA); 315D L (KBD); 315D L (NCM); 315D L (TLE)		
Caterpillar 3054T Diesel			Caterpillar C4.2 Diesel		
Belt - Fan	1013282	Ⓣ♣9530HD	Belt - Fan & Alt.		
Belt - Alt.	0617140	♣9540HD	Belt - Compr.	2553016	K090586HD
Belt - Compr.	0617139	♣9425HD	316E L (DZW); 316E L (WZY); 316E L (YZZ)		
315 (4YM); 315 L (6YM)			Caterpillar C4.4 Diesel		
Caterpillar 3046T Diesel			Belt - Fan		
Belt - Fan	9L0361	ⓉTR22514	Belt - Compr.		
Belt - Compr.	4L6060	♣9451HD	317 (4MM)		
315B (1SW); 315B (2DW)			Caterpillar 3054 Diesel		
Caterpillar 3046 Diesel			Belt - Fan		
Belt - Fan; W/Std. Fan	9L0361	ⓉTR22514	Belt - Alt.	0617140	Ⓣ♣9540HD
Belt - Fan; W/High Ambient Temp. Fan	1477177	ⓉBX47	317B L (9WW); 317B LN (6DZ)		
Belt - Compr.	4L6060	♣9451HD	Caterpillar 3046 Diesel		
315B FM L (7RZ)			Belt - Fan		
Caterpillar 3054T Diesel			Belt - Compr.		
Belt - Fan; W/Std. Fan	9L0361	ⓉTR22514	Belt - Fan	9L0361	ⓉTR22514
Belt - Fan; W/High Ambient Temp. Fan	1477177	ⓉBX47	Belt - Compr.	4L6060	♣9451HD
Belt - Compr.	8L8646	♣9470HD	317N (9SR)		
315B L (3AW)			Caterpillar 3054 Diesel		
Caterpillar 3054 Diesel			Belt - Fan		
Belt - Fan; W/Std. Fan	9L0361	ⓉTR22514	Belt - Alt.	0617140	Ⓣ♣9540HD
			Belt - Compr.	0617139	♣9425HD

♣Standard Belt Available.

ⓉTwo Required.

Belts and Coolant Hose for Road & Construction Equipment

Application	Mfr. Part No.	Our No.	Application	Mfr. Part No.	Our No.
Caterpillar - Continued			Caterpillar - Continued		
318B (ADC)			320 (4ZJ)		
Caterpillar 3046 Diesel			Caterpillar 3116T Diesel		
Belt - Fan	9L0361	②TR22514	Belt - Fan	7L5001	②♣9580HD
Belt - Compr.	4L6060	♣9451HD	Belt - W.P.	0366775	♣9341HD
318B (3LR)			Belt - Compr.		
Caterpillar 3046 Diesel			320 (7WK)		
Belt - Fan	9L0361	②TR22514	Caterpillar 3116 Diesel		
Belt - Compr.	8L8646	♣9470HD	Belt - Fan	9L1226	②♣9580HD
318B N (AEJ)			Belt - W.P.		
Caterpillar 3046 Diesel			Belt - Compr.		
Belt - Fan	9L0361	②TR22514	320 (8HL); 320 (8LK); 320B (1CS)		
Belt - Compr.	4L6060	♣9451HD	Caterpillar 3066T Diesel		
318B N (7KZ)			Belt - Alt.		
Caterpillar 3046 Diesel			Belt - Compr.		
Belt - Fan	9L0361	②TR22514	320B (1XS)		
Belt - Compr.	8L8646	♣9470HD	Caterpillar 3116T Diesel		
318C (BTG); 318C (CWP); 318C (DAH); 318C (FAA)			Belt - Fan		
Caterpillar 3066T Diesel			Belt - Alt.		
Belt - Alt.	2175420	②TR22485	Belt - W.P.		
Belt - Compr.	9L2248	♣9480HD	Belt - Compr.		
318C (GPA); 318C (MDY)			320B (3MR)		
Caterpillar 3066T Diesel			Caterpillar 3066T Diesel		
Belt - Alt.	2175420	②TR22485	Belt - Alt.		
Belt - Compr.	2552927	♣9480HD	Belt - Compr.		
318D L (ZKJ)			320B (3YZ)		
Caterpillar 3054C Diesel			Caterpillar 3116 Diesel		
Belt - Fan & Alt.	2964737	K090586HD	Belt - Fan		
Belt - Compr.	2553016	♣9455HD	Belt - Alt.		
318D2 L (TZS); 318D2 L (WGR)			Belt - W.P.		
Caterpillar 3054C Diesel			Belt - Compr.		
Belt - Fan	2985872	♣K080694HD	320B (4FS); 320B (4XW)		
318E L (DZF); 318E L (WZS)			Caterpillar 3066T Diesel		
Caterpillar C4.4 Diesel			Belt - Alt.		
Belt - Fan	2610370	♣K080755HD	Belt - Compr.		
319C (KGL)			320B (5BR)		
Caterpillar 3066T Diesel			Caterpillar 3066 Diesel		
Belt - Alt.	2175420	②TR22485	Belt - Fan; W/Std. Fan		
Belt - Compr.	9L2248	♣9480HD	Belt - Fan; W/High Ambient Temp. Fan		
319D (BZH); 319D (DAY); 319D L (AYF); 319D L (EAW); 319D L (KRM); 319D L (ZCA); 319D L (ZGZ); 319D LN (FMH); 319D LN (KFM); 319D LN (RJP); 319D LN (WBJ)			Belt - Compr.		
Caterpillar C4.2 Diesel			320B (8ES)		
Belt - Fan & Alt.	2964737	K090586HD	Caterpillar 3116 Diesel		
Belt - Compr.	2553016	♣9455HD	Belt - Fan		
320 (2BN); 320 (2DL); 320 (3RK)			Belt - Alt.		
Caterpillar 3066 Diesel			Belt - W.P.		
Belt - Alt.	1252944	②TR22508	Belt - Compr.		
Belt - Compr.	9M1091	♣9463HD	320B (9KR)		
320 (3XM)			Caterpillar 3066 Diesel		
Caterpillar 3066T Diesel			Belt - Fan; W/Std. Fan		
Belt - Alt.	1252944	②TR22508	Belt - Fan; W/High Ambient Temp. Fan		
Belt - Compr.	9M1091	♣9463HD	Belt - Compr.		
			320B FM LL (6LS); 320B FM LL (9JS)		
			Caterpillar 3066T Diesel		
			Belt - Alt.		
			Belt - Compr.		

♣Standard Belt Available.

②Two Required.

Road & Construction Equipment

Belts and Coolant Hose for Road & Construction Equipment

Application	Mfr. Part No.	Our No.	Application	Mfr. Part No.	Our No.
Caterpillar - Continued			Caterpillar - Continued		
320B L (AED)			320B N (4NR)		
Caterpillar 3306T Diesel			Caterpillar 3066T Diesel		
Belt - Alt.	1765006	ⓉTR22474	Belt - Alt.; W/Std. Fan	518115	ⓉBX45
Belt - Compr.	8L8646	♣9470HD	Belt - Alt.; W/High Ambient Temp. Fan	1253001	K090578HD
320B L (1DS); 320B L (1ES); 320B L (2WZ); 320B L (4MR)			Belt - Compr.		
Caterpillar 3306T Diesel			8L8646		
Belt - Alt.	518115	ⓉBX45	320B S (5MS)		
Belt - Compr.	6L3408	♣9476HD	Caterpillar 3116T Diesel		
320B L (5CS)			Belt - Fan		
Caterpillar 3066T Diesel			4N2532		
Belt - Fan; W/Std. Fan	1765006	ⓉTR22474	Belt - Alt.	9L6644	ⓉTR22607
Belt - Fan; W/High Ambient Temp. Fan	1253001	K090578HD	Belt - W.P.	0366775	♣9341HD
Belt - Compr.	8L8646	♣9470HD	Belt - Compr.	3S3961	♣9570HD
320B L (5GW)			Belt - Compr.		
Caterpillar 3306T Diesel			3S3961		
Belt - Alt.	1765006	ⓉTR22474	320B U (BAN); 320B U (8GZ)		
Belt - Compr.	8L8646	♣9470HD	Caterpillar 3066T Diesel		
320B L (6CR)			Belt - Fan; W/Std. Fan		
Caterpillar 3066T Diesel			1765006		
Belt - Fan; W/Std. Fan	1765006	ⓉTR22474	Belt - Fan; W/High Ambient Temp. Fan	1253001	ⓉTR22474
Belt - Fan; W/High Ambient Temp. Fan	1253001	K090578HD	Belt - Compr.	8L8646	K090578HD
Belt - Compr.	8L8646	♣9470HD	Belt - Compr.		
320B L (6LW)			8L8646		
Caterpillar 3116 Diesel			320C (AKH); 320C (ALF)		
Belt - Fan	4N2532	ⓉBX59	Caterpillar 3066 Diesel		
Belt - Alt.	9L6644	ⓉTR22607	Belt - W.P.		
Belt - W.P.	0366775	♣9341HD	1838207		
Belt - Compr.	3S3961	♣9570HD	Belt - Compr.		
320B L (7JR)			8L8646		
Caterpillar 3116T Diesel			ⓉTR22485		
Belt - Fan	4N2532	ⓉBX59	♣9470HD		
Belt - Alt.	9L6644	ⓉTR22607	320C (ALX); 320C (AMC); 320C (ANB); 320C (APA); 320C (AXK)		
Belt - W.P.	0366775	♣9341HD	Caterpillar 3066 Diesel		
Belt - Compr.	3S3961	♣9570HD	Belt - W.P.		
320B L (9CS); 320B L (9WS)			1838235		
Caterpillar 3116 Diesel			K090613HD		
Belt - Fan	4N2532	ⓉBX59	Belt - Compr.		
Belt - Alt.	9L6644	ⓉTR22607	2552927		
Belt - W.P.	0366775	♣9341HD	320C (BBL)		
Belt - Compr.	3S3961	♣9570HD	Caterpillar 3066 Diesel		
320B LL (6LS); 320B LL (9JS)			Belt - W.P.		
Caterpillar 3116T Diesel			2175420		
Belt - Alt.	1253001	K090578HD	Belt - Compr.		
Belt - Compr.	8L8646	♣9470HD	9L2248		
320B LU (BBG); 320B LU (7ZZ)			ⓉTR22485		
Caterpillar 3116T Diesel			♣9480HD		
Belt - Fan; W/Std. Fan	1765006	ⓉTR22474	320C (BCB)		
Belt - Fan; W/High Ambient Temp. Fan	1253001	K090578HD	Caterpillar 3066 Diesel		
Belt - Compr.	8L8646	♣9470HD	Belt - W.P.		
320B N (2AS)			1838207		
Caterpillar 3116T Diesel			ⓉTR22485		
Belt - Fan	4N2532	ⓉBX59	♣9470HD		
Belt - Alt.	9L6644	ⓉTR22607	320C (BCN)		
Belt - W.P.	0366775	♣9341HD	Caterpillar 3066 Diesel		
Belt - Compr.	3S3961	♣9570HD	Belt - W.P.		
320B N (2AS)			1838235		
Caterpillar 3116T Diesel			K090613HD		
Belt - Fan	4N2532	ⓉBX59	Belt - Compr.		
Belt - Alt.	9L6644	ⓉTR22607	9L2248		
Belt - W.P.	0366775	♣9341HD	320C (BDB)		
Belt - Compr.	3S3961	♣9570HD	Caterpillar 3066 Diesel		
320B N (2AS)			Belt - W.P.		
Caterpillar 3116T Diesel			1838207		
Belt - Fan	4N2532	ⓉBX59	ⓉTR22485		
Belt - Alt.	9L6644	ⓉTR22607	♣9470HD		
Belt - W.P.	0366775	♣9341HD	320C (BDC)		
Belt - Compr.	3S3961	♣9570HD	Caterpillar 3066 Diesel		
320B N (2AS)			Belt - W.P.		
Caterpillar 3116T Diesel			2175420		
Belt - Fan	4N2532	ⓉBX59	Belt - Compr.		
Belt - Alt.	9L6644	ⓉTR22607	9L2248		
Belt - W.P.	0366775	♣9341HD	320C (BDE); 320C (BEA)		
Belt - Compr.	3S3961	♣9570HD	Caterpillar 3066 Diesel		
320B N (2AS)			Belt - W.P.		
Caterpillar 3116T Diesel			2175420		
Belt - Fan	4N2532	ⓉBX59	ⓉTR22485		
Belt - Alt.	9L6644	ⓉTR22607	♣9480HD		
Belt - W.P.	0366775	♣9341HD	320C (BER)		
Belt - Compr.	3S3961	♣9570HD	Caterpillar 3066 Diesel		
320B N (2AS)			Belt - W.P.		
Caterpillar 3116T Diesel			1838235		
Belt - Fan	4N2532	ⓉBX59	K090613HD		
Belt - Alt.	9L6644	ⓉTR22607	Belt - Compr.		
Belt - W.P.	0366775	♣9341HD	9L2248		
Belt - Compr.	3S3961	♣9570HD	♣9480HD		

♣Standard Belt Available.

ⓉTwo Required.

Road & Construction Equipment

Belts and Coolant Hose for Road & Construction Equipment

Application	Mfr. Part No.	Our No.	Application	Mfr. Part No.	Our No.
Caterpillar - Continued			Caterpillar - Continued		
320C (BMZ)			320C FM (BKK)		
Caterpillar 3066 Diesel			Caterpillar 3066T Diesel		
Belt - W.P.	1838235	K090613HD	Belt - W.P.	2175420	②TR22485
Belt - Compr.	2552927	♣9480HD	Belt - Compr.	8L8646	♣9470HD
320C (BPR); 320C (BRX); 320C (CLM); 320C (CLZ)			320C FM (SAH); 320C FM (TBR)		
Caterpillar 3066 Diesel			Caterpillar 3066T Diesel		
Belt - W.P.	1838235	K090613HD	Belt - Fan	2228311	♣K080751HD
Belt - Compr.	9L2248	♣9480HD	Belt - Compr.	2552927	♣9480HD
320C (DBG)			320C L (EAG)		
Caterpillar 3306 Diesel			Caterpillar 3066T Diesel		
Belt - Fan	2228372	K120732HD	Belt - Fan	2128585	♣K120738HD
Belt - Compr.	2552927	♣9480HD	Belt - Compr.	2552927	♣9480HD
320C (EGA); 320C (EGL); 320C (FBA); 320C (FBB)			320D (A6F); 320D (AZR); 320D (BWZ); 320D (BZP); 320D (CXY); 320D (DFT); 320D (EBT); 320D (FAL); 320D (GKS); 320D (JFZ); 320D (JGZ); 320D (JPD); 320D (KLM); 320D (MCH)		
Caterpillar 3066 Diesel			Caterpillar C6.4 Diesel		
Belt - Fan	2228372	K120732HD	Belt - Fan	2128585	♣K120738HD
Belt - Compr.	2552927	♣9480HD	Belt - Compr.	2552927	♣9480HD
320C (GAA); 320C (GAB); 320C (GAD)			320D (MZD); 320D (SNS)		
Caterpillar 3066 Diesel			Caterpillar C6.6 Diesel		
Belt - Fan	2128585	♣K120738HD	Belt - Fan	3572637	K120855HD
Belt - Compr.	2552927	♣9480HD	320D FM (BWW); 320D FM (BZF); 320D FM (CYZ); 320D FM (EAX); 320D FM (KHN)		
320C (GLA)			Caterpillar C6.4 Diesel		
Caterpillar 3066 Diesel			Belt - Fan	2128585	♣K120738HD
Belt - Fan	2228372	K120732HD	Belt - Compr.	2552927	♣9480HD
Belt - Compr.	2552927	♣9480HD	320D FM RR (SRT)		
320C (GNG)			Caterpillar C6.4 Diesel		
Caterpillar 3066 Diesel			Belt - Fan	2941781	K120729HD
Belt - Fan	2128585	♣K120738HD	Belt - Compr.	2552927	♣9480HD
Belt - Compr.	2552927	♣9480HD	320D GC (JZA)		
320C (HBC)			Caterpillar C6.4 Diesel		
Caterpillar 3066 Diesel			Belt - Fan	3572637	K120855HD
Belt - W.P.	1838235	K090613HD	320D GC (KTF); 320D GC (PCM)		
Belt - Compr.	2553017	♣9476HD	Caterpillar C6.4 Diesel		
320C (HKT)			Belt - Fan	2941781	K120729HD
Caterpillar 3066 Diesel			Belt - Compr.	2552927	♣9480HD
Belt - Fan	2128585	♣K120738HD	320D L (A8F)		
Belt - Compr.	2552927	♣9480HD	Caterpillar C6.4 Diesel		
320C (JPL)			Belt - Fan	2128585	♣K120738HD
Caterpillar 3066 Diesel			Belt - Compr.	2552927	♣9480HD
Belt - W.P.	2175420	②TR22485	320D L (A9F); 320D L (BWP)		
Belt - Compr.	9L2248	♣9480HD	Caterpillar C6.4 Diesel		
320C (JTG)			Belt - Fan	2941781	K120729HD
Caterpillar 3066 Diesel			Belt - Compr.	2552927	♣9480HD
Belt - Fan	2228372	K120732HD	320D L (DFB); 320D L (DHK)		
Belt - Compr.	2552927	♣9480HD	Caterpillar C6.4 Diesel		
320C (MAA); 320C (MAB); 320C (MAC); 320C (PAA); 320C (PAB); 320C (PAC); 320C (RAW); 320C (SBN)			Belt - Fan	2128585	♣K120738HD
Caterpillar 3066 Diesel			Belt - Compr.	2552927	♣9480HD
Belt - Fan	2128585	♣K120738HD	320D L (FNA); 320D L (GDP)		
Belt - Compr.	2552927	♣9480HD	Caterpillar C6.4 Diesel		
320C FM (BGB)			Belt - Fan	2941781	K120729HD
Caterpillar 3066T Diesel					
Belt - W.P.	2175420	②TR22485			
Belt - Compr.	9L2248	♣9480HD			

♣Standard Belt Available.

②Two Required.

Road & Construction Equipment

Belts and Coolant Hose for Road & Construction Equipment

Application	Mfr. Part No.	Our No.	Application	Mfr. Part No.	Our No.
Caterpillar - Continued			Caterpillar - Continued		
320D L (FNA); 320D L (GDP) - Continued			320E (AWS); 320E (SXE); 320E L (KLT); 320E L (LAK); 320E L (NAZ); 320E L (REE); 320E L (TEX); 320E L (TNJ); 320E L (WBK); 320E LN (DFG); 320E LRR (MEW); 320E LRR (PNL); 320E LRR (TFX); 320E RR (LHN)		
Caterpillar C6.4 Diesel - Continued			Caterpillar C6.6 Diesel		
Belt - Compr.	2552927	♣9480HD	Belt - Fan	3508747	♣K120842HD
320D L (KGF)			320L (1KL)		
Caterpillar C6.4 Diesel			Caterpillar 3116T Diesel		
Belt - Fan	2128585	♣K120738HD	Belt - Alt.	517967	ⓉTR22508
Belt - Compr.	2552927	♣9480HD	Belt - Compr.	9M1091	♣9463HD
320D L (KZF)			320L (1TL)		
Caterpillar C6.4 Diesel			Caterpillar 3116T Diesel		
Belt - Fan	3572637	K120855HD	Belt - Fan	9L1226	Ⓣ♣9580HD
320D L (MDE); 320D L (MGG); 320D L (PDS); 320D L (PHX); 320D L (SPN); 320D L (TDH); 320D L (WJN)			Belt - W.P.	0618384	♣9335HD
Caterpillar C6.4 Diesel			Belt - Compr.	3S3961	♣9570HD
Belt - Fan	2128585	♣K120738HD	320L (3XK)		
Belt - Compr.	2552927	♣9480HD	Caterpillar 3116T Diesel		
320D LN (KAF); 320D LN (PCX); 320D LN (WBN); 320D LRR (CWN); 320D LRR (DHE)			Belt - Fan	7L5001	Ⓣ♣9580HD
Caterpillar C6.4 Diesel			Belt - W.P.	0366775	♣9341HD
Belt - Fan	2941781	K120729HD	Belt - Compr.	3S3961	♣9570HD
Belt - Compr.	2552927	♣9480HD	320L (4BK); 320L (4JM); 320L (9KK); 320N (1XM)		
320D LRR (EBY)			Caterpillar 3066T Diesel		
Caterpillar C6.4 Diesel			Belt - Alt.	1253001	K090578HD
Belt - Fan	2128585	♣K120738HD	Belt - Compr.	9M1091	♣9463HD
Belt - Compr.	2552927	♣9480HD	320N (9WG); 320S (6KM)		
320D LRR (EJT)			Caterpillar 3066T Diesel		
Caterpillar C6.4 Diesel			Belt - Fan	9L1226	Ⓣ♣9580HD
Belt - Fan	2941781	K120729HD	Belt - W.P.	0366775	♣9341HD
Belt - Compr.	2552927	♣9480HD	Belt - Compr.	3S3961	♣9570HD
320D LRR (FXK)			321B (AKG); 321B (KGA); 321B (9CZ)		
Caterpillar C6.4 Diesel			Caterpillar 3066T Diesel		
Belt - Fan	2228372	K120732HD	Belt - Alt.	1765006	ⓉTR22474
Belt - Compr.	2552927	♣9480HD	Belt - Compr.	1623492	♣9451HD
320D LRR (HJC); 320D LRR (SCW); 320D LRR (TAE); 320D LRR (XCK); 320D LRR (ZGB)			321C (DAX); 321C (KBB); 321C (KCR); 321C (MCF)		
Caterpillar C6.4 Diesel			Caterpillar 3066T Diesel		
Belt - Fan	2941781	K120729HD	Belt - Fan	2228372	K120732HD
Belt - Compr.	2552927	♣9480HD	Belt - Compr.	2552960	♣9520HD
320D RR (AMR); 320D RR (GKL)			321D CR (JCX); 321D LCR (KBH); 321D LCR (KBZ); 321D LCR (MDT); 321D LCR (MPG); 321D LCR (NAS); 321D LCR (PBD); 321D LCR (TXA)		
Caterpillar C6.4 Diesel			Caterpillar C6.4 Diesel		
Belt - Fan	2128585	♣K120738HD	Belt - Fan	2941781	K120729HD
Belt - Compr.	2552927	♣9480HD	Belt - Compr.	2552960	♣9520HD
320D RR (GMX); 320D RR (RBL); 320D RR (YDS)			322 (7WL)		
Caterpillar C6.4 Diesel			Caterpillar 3116 Diesel		
Belt - Fan	2941781	K120729HD	Belt - Fan & Alt.	9L6642	ⓉTR22588
Belt - Compr.	2552927	♣9480HD	Belt - W.P.	0618384	♣9335HD
320D2 (DFM); 320D2 (KHR); 320D2 (LMA); 320D2 (NBT); 320D2 (TMF)			Belt - Compr.	5M8135	♣9510HD
Caterpillar C6.4 Diesel			322 FM L (9RL)		
Belt - Fan	3572637	K120855HD	Caterpillar 3126 Diesel		
			Belt - W.P.	0366775	♣9341HD
			Belt - Fan	4N6373	ⓉTR22588
			Belt - Compr.	5M8135	♣9510HD

♣Standard Belt Available.

ⓉTwo Required.

Belts and Coolant Hose for Road & Construction Equipment

Application	Mfr. Part No.	Our No.	Application	Mfr. Part No.	Our No.
Caterpillar - Continued			Caterpillar - Continued		
322 LN (4RM); 322B (3NR)			322C FM (C3R)		
Caterpillar 3116 Diesel			Caterpillar 3126TA Diesel		
Belt - Fan & Alt.	9L6642	②TR22588	Belt - Fan	1834494	▲K080859HD
Belt - W.P.	0366775	▲9341HD	Tensioner Assy.	1900643	38620
Belt - Compr.	5M8135	▲9510HD	322C FM (CAM); 322C FM (CBY)		
322B (8MR)			Caterpillar 3126TA Diesel		
Caterpillar 3116T Diesel			Belt - Fan		
Belt - Fan & Alt.	9L6642	②TR22588	Belt - W.P.	4N2532	②BX59
Belt - W.P.	0618384	▲9335HD	Belt - Compr.	0366775	▲9341HD
Belt - Compr.	5M8135	▲9510HD	322C FM (LAR); 322C FM (M2H)		
322B L (1AS); 322B L (1BS)			Caterpillar 3126TA Diesel		
Caterpillar 3116T Diesel			Belt - Fan		
Belt - Fan & Alt.	4N6373	②TR22588	Tensioner Assy.	1834494	▲K080859HD
Belt - W.P.	0618384	▲9335HD	322L (8CL)		
Belt - Compr.	5M8135	▲9510HD	Caterpillar 3116 Diesel		
322B L (1YS); 322B L (2ES); 322B L (5CR)			Belt - Fan & Alt.		
Caterpillar 3116T Diesel			Belt - W.P.		
Belt - Fan & Alt.	9L6642	②TR22588	Belt - Compr.	9L6642	②TR22588
Belt - W.P.	0366775	▲9341HD	Belt - W.P.		
Belt - Compr.	5M8135	▲9510HD	Belt - Compr.		
322B L (8NR)			Caterpillar 3116 Diesel		
Caterpillar 3116T Diesel			Belt - Fan & Alt.		
Belt - Fan & Alt.	9L6644	②TR22607	Belt - W.P.	0366775	▲9341HD
Belt - W.P.	0618384	▲9335HD	Belt - Compr.	5M8135	▲9510HD
Belt - Compr.	9L1128	▲9570HD	322L (9RL); 322N (9LJ)		
322B LN (1ZS)			Caterpillar 3116 Diesel		
Caterpillar 3116T Diesel			Belt - Fan & Alt.		
Belt - Fan & Alt.	9L6642	②TR22588	Belt - W.P.	4N6373	②TR22588
Belt - W.P.	0366775	▲9341HD	Belt - Compr.	0366775	▲9341HD
Belt - Compr.	5M8135	▲9510HD	Belt - Compr.		
322C (ADX); 322C (BFK); 322C (BFN); 322C (BFX); 322C (BGR); 322C (BKJ); 322C (BKM); 322C (BLP); 322C (BMX); 322C (BNY); 322C (BTE)			323D (WNE); 323D L (BYM); 323D L (GTF); 323D L (JLG); 323D L (LFL); 323D L (NDE)		
Caterpillar 3126 Diesel			Caterpillar C6.4 Diesel		
Belt - Fan & Alt.	4N6373	②TR22588	Belt - Fan	2941781	K120729HD
Belt - W.P.	0366775	▲9341HD	Belt - Compr.	2552927	▲9480HD
Belt - Compr.	5M8135	▲9510HD	323D L (NZF)		
322C (BYL)			Caterpillar C6.4 Diesel		
Caterpillar 3126 Diesel			Belt - Fan		
Belt - Fan	1834494	▲K080859HD	Belt - Compr.		
Tensioner Assy.	1900643	38620	323D L (PBE)		
322C (DAA); 322C (EMR); 322C (FED); 322C (HBG); 322C (HEK)			Caterpillar C6.4 Diesel		
Caterpillar 3116 Diesel			Belt - Fan		
Belt - Fan	1834494	▲K080859HD	Belt - Compr.	2941781	K120729HD
Tensioner Assy.	1900643	38620	Belt - Compr.		
322C (KCF); 322C (MAR)			323D L (PBM); 323D L (SDC)		
Caterpillar 3126 Diesel			Caterpillar C6.4 Diesel		
Belt - Fan	1834494	▲K080859HD	Belt - Fan		
Tensioner Assy.	1900643	38620	Belt - Compr.		
322C FM (BPH)			323D L (WGC)		
Caterpillar 3126TA Diesel			Caterpillar C6.4 Diesel		
Belt - W.P.	0366775	▲9341HD	Belt - Fan		
Belt - Fan	4N2532	②BX59	Belt - Compr.		
Belt - Compr.	5M8135	▲9510HD	323D L (YSD)		
			Caterpillar C6.4 Diesel		
			Belt - Fan		
			Belt - Compr.		

▲Standard Belt Available.

②Two Required.

Road & Construction Equipment

Belts and Coolant Hose for Road & Construction Equipment

Application	Mfr. Part No.	Our No.	Application	Mfr. Part No.	Our No.
Caterpillar - Continued			Caterpillar - Continued		
323D L (ZMF); 323D LN (CWG)			324D L (LAB)		
Caterpillar C6.4 Diesel			Caterpillar C7 Diesel		
Belt - Fan	2941781	K120729HD	Belt - Fan; W/High Ambient Temp. Fan	3748478	▲K080839HD
Belt - Compr.	2552927	▲9480HD	324D L (PYT)		
323D LN (CYD); 323D LN (FAW)			Caterpillar C7 Diesel		
Caterpillar C6.4 Diesel			Belt - Fan; W/Std. Fan		
Belt - Fan	2228372	K120732HD	Belt - Fan; W/High Ambient Temp. Fan	3748478	▲K080839HD
Belt - Compr.	2552927	▲9480HD	324D L (SYM)		
323D LN (RAC)			Caterpillar C7 Diesel		
Caterpillar C6.4 Diesel			Belt - Fan		
Belt - Fan	2941781	K120729HD	Belt - Fan	3748478	▲K080839HD
Belt - Compr.	2552927	▲9480HD	324D L (TSN)		
323D LN (TDW)			Caterpillar C7 Diesel		
Caterpillar C6.6 Diesel			Belt - Fan; W/High Ambient Temp. Fan		
Belt - Fan	3508747	▲K120842HD	Belt - Fan	3748478	▲K080839HD
323D S (DKW)			324D LN (EJC); 324D LN (TRH)		
Caterpillar C6.4 Diesel			Caterpillar C7 Diesel		
Belt - Fan	2228372	K120732HD	Belt - Fan		
Belt - Compr.	2552927	▲9480HD	Belt - Fan	3748478	▲K080839HD
323D S (SED); 323D SA (NES); 323D2 L (GBF); 323D2 L (WGP)			324E (JCZ); 324E L (KTE); 324E L (PNW)		
Caterpillar C6.4 Diesel			Caterpillar C7.1 Diesel		
Belt - Fan	2941781	K120729HD	Belt - Fan		
Belt - Compr.	2552927	▲9480HD	Belt - Fan	3572637	K120855HD
323E L (RAP); 323E SA (YRP)			325 (5WK)		
Caterpillar C6.6 Diesel			Caterpillar 3116TA Diesel		
Belt - Fan	3508747	▲K120842HD	Belt - Fan	4N6373	ⓉTR22588
324D (AWN); 324D (CJX); 324D (LBW); 324D (MND)			Belt - W.P.	0618384	▲9335HD
Caterpillar C7 Diesel			Belt - Compr.	5M8135	▲9510HD
Belt - Fan; W/Std. Fan	2412896	K080850HD	325 (6RM); 325 (7TG)		
Belt - Fan; W/High Ambient Temp. Fan	3748478	▲K080839HD	Caterpillar 3116TA Diesel		
324D (T2D)			Belt - Fan		
Caterpillar C7 Diesel			Belt - W.P.	0366775	▲9341HD
Belt - Fan; W/High Ambient Temp. Fan	3748478	▲K080839HD	Belt - Compr.	5M8135	▲9510HD
324D FM (JGK)			325 (8JG); 325 (8NL)		
Caterpillar C7 Diesel			Caterpillar 3116TA Diesel		
Tensioner Assy.	1900643	38620	Belt - Fan		
324D L (BTK); 324D L (BYE)			Belt - W.P.	0366775	▲9341HD
Caterpillar C7 Diesel			Belt - Compr.	5M8135	▲9510HD
Belt - Fan	3748478	▲K080839HD	325B (ABD); 325B (8GM); 325B (8PR)		
324D L (DFP)			Caterpillar 3116TA Diesel		
Caterpillar C7 Diesel			Belt - Fan; W/Std. Fan		
Belt - Fan; W/Std. Fan	2412896	K080850HD	Belt - Fan; W/High Ambient Temp. Fan	9L6644	ⓉTR22607
Belt - Fan; W/High Ambient Temp. Fan	3748478	▲K080839HD	Belt - W.P.	0618384	▲9335HD
324D L (GPK)			Belt - Compr.	9L1128	▲9570HD
Caterpillar C7 Diesel			325B L (1GS); 325B L (1HS)		
Belt - Fan	3748478	▲K080839HD	Caterpillar 3116TA Diesel		
324D L (JAT)			Belt - Fan		
Caterpillar C7 Diesel			Belt - W.P.	0618384	▲9335HD
Belt - Fan; W/High Ambient Temp. Fan	3748478	▲K080839HD	Belt - Compr.	9L1128	▲9570HD
Belt - Fan; W/Std. Fan	2412896	K080850HD	325B L (2JR)		
324D L (JAT)			Caterpillar 3116TA Diesel		
Caterpillar C7 Diesel			Belt - Fan		
Belt - Fan; W/High Ambient Temp. Fan	3748478	▲K080839HD	Belt - Fan	9L6640	ⓉTR22570
Belt - Fan; W/Std. Fan	2412896	K080850HD	Belt - Fan & Alt.	9L6642	ⓉTR22588

▲Standard Belt Available.

ⓉTwo Required.

Road & Construction Equipment

Belts and Coolant Hose for Road & Construction Equipment

Application	Mfr. Part No.	Our No.	Application	Mfr. Part No.	Our No.
Caterpillar - Continued			Caterpillar - Continued		
325B L (2JR) - Continued			325D (SCR)		
Caterpillar 3116TA Diesel - Continued			Caterpillar C7 Diesel		
Belt - W.P.	0366775	▲9341HD	Belt - Fan; W/Std. Fan	2412896	K080850HD
Belt - Compr.	5M8135	▲9510HD	Belt - Fan; W/High Ambient Temp. Fan	3748478	▲K080839HD
325B L (4DS); 325B L (5BS); 325B L (5LW); 325B L (6DN); 325B L (7EN); 325B L (8RR); 325B LN (8FN)			325D (T2S); 325D L (AZP)		
Caterpillar 3116TA Diesel			Caterpillar C7 Diesel		
Belt - Fan	4N6373	②TR22588	Belt - Fan; W/High Ambient Temp. Fan	3748478	▲K080839HD
Belt - W.P.	0366775	▲9341HD	325D L (GBR); 325D L (MCL)		
Belt - Compr.	5M8135	▲9510HD	Caterpillar C7 Diesel		
325C (AMH)			Belt - Fan		
Caterpillar 3126B Diesel			3748478 ▲K080839HD		
Belt - Fan	1834494	▲K080859HD	325D L (NAC); 325D L (PAL); 325D L (PEH)		
Tensioner Assy.	1900643	38620	Caterpillar C7 Diesel		
325C (BFE); 325C (BKH); 325C (BKT); 325C (BKW); 325C (BLA); 325C (BLX)			Belt - Fan; W/High Ambient Temp. Fan		
Caterpillar 3126B Diesel			3748478 ▲K080839HD		
Belt - Fan; W/Std. Fan	1834494	▲K080859HD	325L (2JK); 325L (2SL)		
Tensioner Assy.	1900643	38620	Caterpillar 3116TA Diesel		
325C (CRB); 325C (CSJ); 325C (DTF); 325C (JLC); 325C (JLD)			Belt - Fan		
Caterpillar 3126B Diesel			4N6373 ②TR22588		
Belt - Fan; W/Std. Fan	1834494	▲K080859HD	Belt - W.P.	0366775	▲9341HD
Tensioner Assy.	1900643	38620	Belt - Compr.	5M8135	▲9510HD
325C (FM); 325C (G1L)			325L (6KK); 325L (7CJ)		
Caterpillar 3126B Diesel			Caterpillar 3116TA Diesel		
Belt - Fan	1834494	▲K080859HD	Belt - Fan		
Tensioner Assy.	1900643	38620	4N6373 ②TR22588		
325C (S2C)			Belt - W.P.		
Caterpillar 3126B Diesel			0618384 ▲9335HD		
Belt - Fan; W/Std. Fan	1834494	▲K080859HD	Belt - Compr.	5M8135	▲9510HD
Tensioner Assy.	1900643	38620	325L (7LJ)		
325C FM (M2K); 325C FM (S3M); 325C FM (Y4P)			Caterpillar 3116TA Diesel		
Caterpillar 3126B Diesel			Belt - Fan		
Belt - Fan	1834494	▲K080859HD	4N6373 ②TR22588		
Tensioner Assy.	1900643	38620	Belt - W.P.	0366775	▲9341HD
325C L (BMM); 325C L (BTD)			Belt - Compr.	5M8135	▲9510HD
Caterpillar 3126B Diesel			325L (7LM)		
Belt - Fan; W/Std. Fan	1834494	▲K080859HD	Caterpillar 3116 Diesel		
Tensioner Assy.	1900643	38620	Belt - Fan		
325D (GPB)			4N6373 ②TR22588		
Caterpillar C7 Diesel			Belt - W.P.		
Belt - Fan	3748478	▲K080839HD	0366775 ▲9341HD		
325D (JCL)			Belt - Compr.		
Caterpillar C7 Diesel			5M8135 ▲9510HD		
Belt - Fan; W/Std. Fan	2412896	K080850HD	325L (8NK)		
Tensioner Assy.	1900643	38620	Caterpillar 3116TA Diesel		
325D (KDG)			Belt - Fan		
Caterpillar C7 Diesel			4N6373 ②TR22588		
Belt - Fan; W/Std. Fan	2412896	K080850HD	Belt - W.P.	0366775	▲9335HD
Belt - Fan; W/High Ambient Temp. Fan	3748478	▲K080839HD	Belt - Compr.	5M8135	▲9510HD
325D (PKE)			325LN (2SK); 325LN (3LL)		
Caterpillar C7 Diesel			Caterpillar 3116TA Diesel		
Belt - Fan	3748478	▲K080839HD	Belt - Fan		
			4N6373 ②TR22588		
			Belt - W.P.		
			0366775 ▲9341HD		
			Belt - Compr.		
			5M8135 ▲9510HD		
			328D LCR (BYH); 328D LCR (GTN); 328D LCR (MKR); 328D LCR (RMX); 328D LCR (SWF)		
			Caterpillar C7 Diesel		
			Belt - Fan		
			3748478 ▲K080839HD		

▲Standard Belt Available.

②Two Required.

Road & Construction Equipment

Belts and Coolant Hose for Road & Construction Equipment

Application	Mfr. Part No.	Our No.	Application	Mfr. Part No.	Our No.
Caterpillar - Continued			Caterpillar - Continued		
329D (DTZ); 329D (WDK)			330 (9WJ)		
Caterpillar C7 Diesel			Caterpillar 3306 Diesel		
Belt - Fan; W/Std. Fan	2412896	K080850HD	Belt - Fan	7M4715	ⓉTR30589
Belt - Fan; W/High Ambient Temp. Fan	3748478	♣K080839HD	Belt - Compr.	0303289	♣9350HD
329D L (BFC)			330 FM L (8FK)		
Caterpillar C7 Diesel			Caterpillar C9 Diesel		
Belt - Fan	3748478	♣K080839HD	Belt - Fan	7M4715	ⓉTR30589
329D L (CZF); 329D L (DJF); 329D L (LFW)			Belt - Compr.	0303289	♣9350HD
Caterpillar C7 Diesel			330B (2RR); 330B (4YW); 330B (5EZ); 330B (8SR); 330B (9HN)		
Belt - Fan; W/High Ambient Temp. Fan	3748478	♣K080839HD	Caterpillar 3306TA Diesel		
329D L (LGN)			Belt - Fan	4N6529	6968BR
Caterpillar C7 Diesel			Belt - Compr.	0303289	♣9350HD
Belt - Fan; W/Std. Fan	2412896	K080850HD	330B L (1JS); 330B L (1KS)		
Tensioner Assy.	1900643	38620	Caterpillar 3306TA Diesel		
329D L (MNB)			Belt - Fan	7M4715	ⓉTR30589
Caterpillar C7 Diesel			Belt - Compr.	1N4635	♣9390HD
Belt - Fan; W/Std. Fan	2412896	K080850HD	330B L (3YR); 330B L (3ZZ); 330B L (4RS); 330B L (5LS)		
Belt - Fan; W/High Ambient Temp. Fan	3748478	♣K080839HD	Caterpillar 3306TA Diesel		
329D L (TPM)			Belt - Fan	4N6529	6968BR
Caterpillar C7 Diesel			Belt - Compr.	0303289	♣9350HD
Belt - Fan; W/High Ambient Temp. Fan	3748478	♣K080839HD	330B L (6DR)		
329D L (TZL)			Caterpillar 3306TA Diesel		
Caterpillar C7 Diesel			Belt - Fan	1S1127	ⓉBX55
Belt - Fan	3748478	♣K080839HD	Belt - Compr.	0303289	♣9350HD
329D L (WLT)			330B L (8TR); 330B LN (5LR)		
Caterpillar C7 Diesel			Caterpillar 3306TA Diesel		
Belt - Fan	3748478	♣K080839HD	Belt - Fan	4N6529	6968BR
329D L (XDB)			Belt - Compr.	0303289	♣9350HD
Caterpillar C7 Diesel			330C (BTM); 330C (GAG); 330C (HAA); 330C (JCD); 330C (JNK); 330C (MCA); 330C (MKM); 330C (RBH); 330C FM (B1K); 330C FM (B2L); 330C FM (B3M); 330C FM (B4N); 330C L (CAP); 330C L (CYA); 330C L (DKY); 330C L (GKX); 330C L (JAB); 330C L (KDD); 330C L (RDA); 330C LN (CGZ); 330C MH (D3C)		
Belt - Fan	3748478	♣K080839HD	Caterpillar C9 Diesel		
329D L (YFW)			Belt - Fan	1904155	K080885HD
Caterpillar C7 Diesel			Tensioner Assy.	1900643	38620
Belt - Fan; W/Std. Fan	2412896	K080850HD	330D (EAH); 330D (JJM); 330D (KAB); 330D (LCJ); 330D (MEY); 330D (PCK); 330D (PFC); 330D FM (E4K); 330D FM (H3K); 330D FM (L2K); 330D L (B6H); 330D L (EDX); 330D L (ERN); 330D L (FFK); 330D L (GBC); 330D L (HAS); 330D L (JLP); 330D L (LDR); 330D L (LRM); 330D L (MAG); 330D L (MWP); 330D L (NBD); 330D L (NEF); 330D L (R2D); 330D L (RAS); 330D L (RDK); 330D L (T2Y); 330D L (THJ); 330D LN (GGE); 330D MH (C5K); 330D MH (LEM); 330D MH (PEL)		
Belt - Fan; W/High Ambient Temp. Fan	3748478	♣K080839HD	Caterpillar C9 Diesel		
329D LN (EBM); 329D LN (SCY)			Belt - Fan	1834494	♣K080859HD
Caterpillar C7 Diesel			Tensioner Assy.	1900643	38620
Belt - Fan	3748478	♣K080839HD	330E (PTY); 329E L (RDX); 329E L (WJK)		
329E (PTY); 329E L (RDX); 329E L (WJK)			Caterpillar C7.1 Diesel		
Caterpillar C7.1 Diesel			Belt - Fan	3572637	K120855HD
Belt - Fan	3572637	K120855HD	330 (ZM)		
330 (ZM)			Caterpillar 3306 Diesel		
Caterpillar 3306 Diesel			Belt - Fan	7M4715	ⓉTR30589
Belt - Fan	7M4715	ⓉTR30589	Belt - Compr.	0303289	♣9350HD
Belt - Compr.	0303289	♣9350HD	330 (6ZK)		
330 (6ZK)			Caterpillar 3306 Diesel		
Caterpillar 3306 Diesel			Belt - Fan	7E5113	ⓉTR34545
Belt - Fan	7E5113	ⓉTR34545	Belt - Compr.	0303289	♣9350HD
Belt - Compr.	0303289	♣9350HD	330 (8RL); 330 (9NG); 330 (9PJ)		
330 (8RL); 330 (9NG); 330 (9PJ)			Caterpillar 3306 Diesel		
Caterpillar 3306 Diesel			Belt - Fan	1S1127	ⓉBX55
Belt - Fan	1S1127	ⓉBX55	Belt - Compr.	0303289	♣9350HD
Belt - Compr.	0303289	♣9350HD			

♣Standard Belt Available.

ⓉTwo Required.

Belts and Coolant Hose for Road & Construction Equipment

Application	Mfr. Part No.	Our No.	Application	Mfr. Part No.	Our No.
Caterpillar - Continued			Caterpillar - Continued		
330L (2EL)			345B (2NW); 345B (8KW)		
Caterpillar 3306 Diesel			Caterpillar 3176TA Diesel		
Belt - Fan	7E5113	②TR34545	Belt - Fan	2395944	K081044HD
Belt - Compr.	0303289	♣9350HD	Tensioner Assy.	1900643	38620
330L (5YM)			345B II (AGS)		
Caterpillar 3306 Diesel			Caterpillar 3176C Diesel		
Belt - Fan	4N6529	6968BR	Belt - Fan	2395944	K081044HD
Belt - Compr.	0303289	♣9350HD	Tensioner Assy.	1900643	38620
330L (6SK); 330L (6WJ)			345B II (AKJ); 345B II (AKX)		
Caterpillar 3306 Diesel			Caterpillar 3176C Diesel		
Belt - Fan	1S1127	②BX55	Belt - Fan; W/A.C.	2395944	K081044HD
Belt - Compr.	0303289	♣9350HD	Tensioner Assy.; W/A.C.	1900643	38620
330L (8FK)			345B II (ALB)		
Caterpillar 3306 Diesel			Caterpillar 3176C Diesel		
Belt - Fan	7M4715	②TR30589	Belt - Fan	2395944	K081044HD
Belt - Compr.	0303289	♣9350HD	Tensioner Assy.	1900643	38620
330L (9ML)			345B II (ALD); 345B II (ALL)		
Caterpillar 3306 Diesel			Caterpillar 3176C Diesel		
Belt - Fan	1S1127	②BX55	Belt - Fan; W/A.C.	2395944	K081044HD
Belt - Compr.	0303289	♣9350HD	Tensioner Assy.; W/A.C.	1900643	38620
330LN (8CK)			345B II (CCC); 345B II (CDJ); 345B II (DCW); 345B II (DET); 345B II (FEE); 345B II MH (APB); 345B L (2SW); 345B L (4SS); 345B L (7KS); 345B L (8RW); 345B L (9CW); 345B L (9GS)		
Caterpillar 3306 Diesel			Caterpillar 3176C Diesel		
Belt - Fan	7E5113	②TR34545	Belt - Fan	2395944	K081044HD
Belt - Compr.	0303289	♣9350HD	Tensioner Assy.	1900643	38620
336D (EMX); 336D (JBT); 336D (JER); 336D (KKT); 336D (PGW); 336D L (DTS); 336D L (J2F); 336D L (JBF); 336D L (JWR); 336D L (KDJ); 336D L (LMG); 336D L (M2P); 336D L (M4T); 336D L (MDS); 336D L (MPL); 336D L (NLS); 336D L (PPN); 336D L (PRF); 336D L (PTB); 336D L (SKE); 336D L (W3K); 336D L (WET); 336D L (WRK); 336D L (ZML); 336D LN (L5K); 336D LN (MYG); 336D LN (MYP); 340D L (JTN)			Caterpillar 3176C Diesel		
Caterpillar C9 Diesel			Belt - Fan	2395944	K081044HD
Belt - Fan	1834494	♣K080859HD	Tensioner Assy.	1900643	38620
345B (AMD); 345B (AMJ); 345B (AMN)			345C		
Caterpillar 3176TA Diesel			Caterpillar C13 Diesel		
Belt - Fan	2395944	K081044HD	Belt - Serpentine	2213775	♣K080876HD
Tensioner Assy.	1900643	38620	345C (BMY); 345C (DHP); 345C (ELS); 345C (ESD); 345C (GBH); 345C (GCL); 345C (JAR); 345C (M2R); 345C (MDC); 345C (MTE); 345C (PJW); 345C (RFN); 345C (TAJ); 345C (TBA); 345C (TDG); 345C (WDE); 345C L (FPC); 345C L (GPH); 345C L (L5B); 345C L (L5L); 345C L (LYS); 345C L (S5M); 345C L (SCN); 345C L (SPC); 345C MH (D3S); 345D (BYW); 345D (FES); 345D (L5R); 345D (NEG); 345D L (BYC); 345D L (DPA); 345D L (EEH); 345D L (HLC); 345D L (JKN); 345D L (KFH); 345D L (MLK); 345D L (PBT); 345D L (RAE); 345D L (RAJ); 345D L (RGD); 345D L (RGG); 345D L (YEE); 345D L VG (LKY); 345D L VG (NLM); 349D (GKF); 349D (MEN); 349D L (JGB); 349D L (KHS); 349D L (KLH); 349D L (NNF); 349D L (PZG); 349D L (RBJ); 349D L (WTD)		
345B (AYR)			Caterpillar C13 Diesel		
Caterpillar Diesel			Belt - Fan	2213775	♣K080876HD
Belt - Fan	2395944	K081044HD	350 (2ZL); 350 (3ML); 350 (7RK); 350 (8HK)		
Tensioner Assy.	1900643	38620	Caterpillar 3306 Diesel		
345B (BFG)			Belt - Compr.		
Caterpillar 3176TA Diesel			7C2163		
Belt - Fan	2395944	K081044HD	♣9309HD		
Tensioner Assy.	1900643	38620			
345B (CFM)					
Caterpillar 3176C Diesel					
Belt - Fan	2395944	K081044HD			
Tensioner Assy.	1900643	38620			

♣Standard Belt Available.

②Two Required.

Road & Construction Equipment

Belts and Coolant Hose for Road & Construction Equipment

Application	Mfr. Part No.	Our No.	Application	Mfr. Part No.	Our No.
Caterpillar - Continued			Caterpillar - Continued		
350 L (8KZ); 350 L (9DK); 350 L (9FL)			416D (B2D)		
Caterpillar 3306 Diesel			Caterpillar 3054C Diesel		
Belt - Compr.	0618384	♣9335HD	Belt - Alt.	5L3308	♣9530HD
365B (BTH); 365B (CFJ); 365B (CTY); 365B (PEG); 365B (SDL); 365B (9PZ); 365B (9TZ); 365B II (DER); 365B II (JMB); 365B L (AGD); 365B L (4XZ); 365B L (9TZ)			Belt - A.C.	1W2934	♣9476HD
Caterpillar 3196 Diesel			416D (BFP); 416D (BGJ); 416D (BKG); 416D (CXP)		
Belt - Fan	2395944	K081044HD	Caterpillar 3054C Diesel		
Tensioner Assy.	1900643	38620	Belt - Fan; W/Std. Fan	7W3896	♣9525HD
375 (6NK)			Belt - Fan; W/High Ambient Temp. Fan	4N8597	♣9520HD
Caterpillar 3406C Diesel			Belt - A.C.	1N3743	♣9440HD
Belt - Fan	6N6655	ⓐBX67	416E (BWC)		
Belt - Alt.	7N8538	BX81	Caterpillar C4.4 Diesel		
Belt - Compr.	1S4699	♣9660HD	Belt - Fan; W/A.C.	2129353	♣K080708HD
375 (6RL)			Belt - Fan; W/O A.C.	3243408	♣K080530HD
Caterpillar 3406C Diesel			416E (CBD)		
Belt - Fan	6N6655	ⓐBX67	Caterpillar C4.4 Diesel		
Belt - Alt.	7N8538	BX81	Belt - Fan	1303216	♣9540HD
Belt - Compr.	5S5249	♣9670HD	Belt - A.C.	1P4334	♣9495HD
375 (8WJ)			416E (LMS); 416E (MFG)		
Caterpillar 3406C Diesel			Caterpillar C4.4 Diesel		
Belt - Fan	6N6655	ⓐBX67	Belt - Fan; W/A.C.	2129353	♣K080708HD
Belt - Alt.	7N8538	BX81	Belt - Fan; W/O A.C.	3243408	♣K080530HD
Belt - Compr.	5S5249	♣9670HD	416E (SHA)		
375 (8XG)			Caterpillar C4.4 Diesel		
Caterpillar 3406C Diesel			Belt - Fan	1303216	♣9540HD
Belt - Fan; W/Std. Fan	6N9158	ⓐBX66	Belt - A.C.	1P4334	♣9495HD
Belt - Fan; W/High Ambient Temp. Fan	6N6655	ⓐBX67	416F (KSF)		
Belt - Alt.	7N8538	BX81	Caterpillar C4.4 Diesel		
Belt - Compr.	1S4699	♣9660HD	Belt - Fan; W/O A.C.	3900535	♣K080550HD
375 (8XG)			Belt - Fan; W/A.C.	3900537	♣K080726HD
Caterpillar 3406C Diesel			416F (LWT)		
Belt - Fan; W/Std. Fan	6N9158	ⓐBX66	Caterpillar C4.4 Diesel		
Belt - Fan; W/High Ambient Temp. Fan	6N6655	ⓐBX67	Belt - Fan; W/O A.C.	3900532	♣K080530HD
Belt - Alt.	7N8538	BX81	Belt - Fan; W/A.C.	3900536	♣K080700HD
Belt - Compr.	5S5249	♣9670HD	420B (4NR)		
375 L (1JM); 375 L (9WL)			Caterpillar 3066T Diesel		
Caterpillar 3406C Diesel			Belt - Alt.; W/Std. Fan	518115	ⓐBX45
Belt - Fan; W/Std. Fan	6N9158	ⓐBX66	Belt - Alt.; W/High Ambient Temp. Fan	1253001	K090578HD
Belt - Fan; W/High Ambient Temp. Fan	6N6655	ⓐBX67	Belt - Compr.	8L8646	♣9470HD
Belt - Alt.	7N8538	BX81	420D (BKC); 420D (BLN); 420D (BMC); 420D (FDP)		
Belt - Compr.	1S4699	♣9660HD	Caterpillar 3054T Diesel		
414E			Caterpillar 3054T Diesel		
Caterpillar 3054C Diesel			Belt - Fan; W/Std. Fan	7W3896	♣9525HD
Belt - Fan	0617140	ⓐ♣9540HD	Belt - Fan; W/High Ambient Temp. Fan	4N8597	♣9520HD
416 (5PC)			Belt - A.C.	1N3743	♣9440HD
Perkins 4-Cyl. 236 Diesel			420D (MBH)		
Belt - Alt.	2S9506	ⓐ♣9600HD	Caterpillar 3054T Diesel		
Belt - A.C.	7W5207	ⓐ♣9720HD	Belt - Fan	3N1491	♣9510HD
416B (8SG); 416B (8ZK)			Belt - A.C.	1W2934	♣9476HD
Caterpillar 3054 Diesel			420E (DAN); 420E (DJL)		
Belt - Fan; W/Std. Fan	8M8340	♣9640HD	Caterpillar C4.4 Diesel		
Belt - Fan; W/High Ambient Temp. Fan	8M8341	♣9620HD	Belt - Fan; W/A.C.	2129353	♣K080708HD
Belt - A.C.	9L1126	♣9412HD	Belt - Fan; W/O A.C.	3243408	♣K080530HD
416C (1WR); 416C (1XR); 416C (4ZN); 416C (5YN)			420E (GAN)		
Caterpillar 3054T Diesel			Caterpillar C4.4 Diesel		
Belt - Fan; W/Std. Fan	7W3896	♣9525HD	Belt - Fan	3S8447	♣9525HD
Belt - Fan; W/High Ambient Temp. Fan	4N8597	♣9520HD			
Belt - A.C.	1N3743	♣9440HD			

ⓐThree Required.
ⓐTwo Required.

♣Standard Belt Available.

Belts and Coolant Hose for Road & Construction Equipment

Application	Mfr. Part No.	Our No.	Application	Mfr. Part No.	Our No.
Caterpillar - Continued			Caterpillar - Continued		
420E (GAN) - Continued			424D (RXA)		
Caterpillar C4.4 Diesel - Continued			Caterpillar C4.4 Diesel		
Belt - A.C.	2P6818	♣9470HD	Belt - Fan	4N8597	♣9520HD
420E (GEK)			Belt - A.C.	1W2934	♣9476HD
Caterpillar C4.4 Diesel			426 (7BC)		
Belt - Fan	2129353	♣K080708HD	Perkins 4-Cyl. 236 Diesel		
420E (HLS); 420E (KMW)			Belt - Alt.	2S9506	♣9600HD
Caterpillar C4.4 Diesel			Belt - A.C.	7W5207	♣9720HD
Belt - Fan	3S8447	♣9525HD	426B (5YJ); 426B (6KL)		
Belt - A.C.	2P6818	♣9470HD	Caterpillar 3054 Diesel		
420E (PHC); 420E (PRA)			Belt - Fan; W/Std. Fan	8M8340	♣9640HD
Caterpillar C4.4 Diesel			Belt - Fan; W/High Ambient Temp. Fan	8M8341	♣9620HD
Belt - Fan; W/A.C.	2129353	♣K080708HD	Belt - A.C.	9L1126	♣9412HD
Belt - Fan; W/O A.C.	3243408	♣K080530HD	426C (1CR); 426C (1ER); 426C (1MR); 426C (1NR); 426C (1YR); 426C (1ZR); 426C (6XN); 426C (7WN)		
420F (JWJ)			Caterpillar 3054 DIT Diesel		
Caterpillar C4.4 Diesel			Belt - Fan; W/Std. Fan	7W3896	♣9525HD
Belt - Fan; W/O A.C.	3900533	♣K080545HD	Belt - Fan; W/High Ambient Temp. Fan	4N8597	♣9520HD
Belt - Fan; W/A.C.	3900537	♣K080726HD	Belt - A.C.	1N3743	♣9440HD
420F (LKH); 420F (LTG)			428 (6TC)		
Caterpillar C4.4 Diesel			Perkins 4-Cyl. 236 Diesel		
Belt - Fan; W/O A.C.	3900532	♣K080530HD	Belt - Alt.	2S9506	♣9600HD
Belt - Fan; W/A.C.	3900536	♣K080700HD	Belt - A.C.	7W5207	♣9720HD
420F (SKR)			428B (7EJ)		
Caterpillar C4.4 Diesel			Caterpillar 3054 Diesel		
Belt - Fan; W/O A.C.	3900533	♣K080545HD	Belt - Fan; W/Std. Fan	8M8340	♣9640HD
Belt - Fan; W/A.C.	3900537	♣K080726HD	Belt - Fan; W/High Ambient Temp. Fan	8M8341	♣9620HD
422E (DSK)			Belt - A.C.	9L1126	♣9412HD
Caterpillar 3054C Diesel			428C (2CR); 428C (8RN)		
Belt - Fan; W/A.C.	2129353	♣K080708HD	Caterpillar 3054 Diesel		
Belt - Fan; W/O A.C.	3243408	♣K080530HD	Belt - Fan; W/Std. Fan	7W3896	♣9525HD
422E (HBE)			Belt - Fan; W/High Ambient Temp. Fan	4N8597	♣9520HD
Caterpillar 3054C Diesel			Belt - A.C.	1N3743	♣9440HD
Belt - Fan	1303216	♣9540HD	428D (BLL); 428D (BMT); 428D (BNB); 428D (BNS)		
Belt - A.C.	1P4334	♣9495HD	Caterpillar 3054T Diesel		
422E (MAW)			Belt - Fan; W/Std. Fan	7W3896	♣9525HD
Caterpillar 3054C Diesel			Belt - Fan; W/High Ambient Temp. Fan	4N8597	♣9520HD
Belt - Fan; W/A.C.	2129353	♣K080708HD	Belt - A.C.	1N3743	♣9440HD
Belt - Fan; W/O A.C.	3243408	♣K080530HD	428D (BXC); 428D (DSX); 428D (MBM)		
422F (LRH)			Caterpillar 3054T Diesel		
Caterpillar 3054C Diesel			Belt - Fan	4N8597	♣9520HD
Belt - Fan; W/O A.C.	3900532	♣K080530HD	Belt - A.C.	1W2934	♣9476HD
Belt - Fan; W/A.C.	3900536	♣K080700HD	428E (SNL)		
424D (BGP); 424D (BKR)			Caterpillar 3054C Diesel		
Caterpillar 3054B Diesel			Belt - Fan	1303216	♣9540HD
Belt - Fan; W/Std. Fan	7W3896	♣9525HD	Belt - A.C.	1P4334	♣9495HD
Belt - Fan; W/High Ambient Temp. Fan	4N8597	♣9520HD	428E (DPH); 428E (DXC)		
Belt - A.C.	1N3743	♣9440HD	Caterpillar 3054C Diesel		
424D (CJZ)			Belt - Fan; W/A.C.	2129353	♣K080708HD
Caterpillar 3054B Diesel			Belt - Fan; W/O A.C.	3243408	♣K080530HD
Belt - Fan	4N8597	♣9520HD	428F (LBH); 428F (SJW)		
Belt - A.C.	1W2934	♣9476HD	Caterpillar 3054C Diesel		
			Belt - Fan; W/O A.C.	3900532	♣K080530HD
			Belt - Fan; W/A.C.	3900536	♣K080700HD

♣Standard Belt Available.

Road & Construction
Equipment

Belts and Coolant Hose for Road & Construction Equipment

Road & Construction Equipment

Application	Mfr. Part No.	Our No.	Application	Mfr. Part No.	Our No.
Caterpillar - Continued			Caterpillar - Continued		
430D (BML); 430D (BNK)			434F (FLY); 434F (LDH)		
Caterpillar 3054T Diesel			Caterpillar 3054C Diesel		
Belt - Fan; W/Std. Fan	7W3896	♣9525HD	Belt - Fan; W/O A.C.	3900532	♣K080530HD
Belt - Fan; W/High Ambient Temp. Fan	4N8597	♣9520HD	Belt - Fan; W/A.C.	3900536	♣K080700HD
Belt - A.C.	1N3743	♣9440HD	436 (5KF)		
430E (DDT); 430E (EAT)			Perkins 4-Cyl. 236 Diesel		
Caterpillar 3054C Diesel			Belt - Alt.		
Belt - Fan	3S8447	♣9525HD	Belt - A.C.	2S9506	♣9600HD
Belt - A.C.	2P6818	♣9470HD	Belt - A.C.		
430E (MXB); 430E (RLN); 430E (SCD); 430E (SWC)			436B (6MJ); 436B (7FL)		
Caterpillar 3054C Diesel			Caterpillar 3054T Diesel		
Belt - Fan; W/A.C.	2129353	♣K080708HD	Belt - Fan; W/Std. Fan	8M8340	♣9640HD
Belt - Fan; W/O A.C.	3243408	♣K080530HD	Belt - Fan; W/High Ambient Temp. Fan	8M8341	♣9620HD
430F (LDY); 430F (LNH)			Belt - A.C.	9L1126	♣9412HD
Caterpillar C4.4 Diesel			436C (1FR); 436C (1PR)		
Belt - Fan; W/O A.C.	3900532	♣K080530HD	Caterpillar 3054T Diesel		
Belt - Fan; W/A.C.	3900536	♣K080700HD	Belt - Fan; W/Std. Fan		
430F (RDF); 430F (RGS)			Belt - Fan; W/High Ambient Temp. Fan	7W3896	♣9525HD
Caterpillar C4.4 Diesel			Belt - Fan; W/A.C.	4N8597	♣9520HD
Belt - Fan; W/O A.C.	3900533	♣K080545HD	Belt - A.C.	1N3743	♣9440HD
Belt - Fan; W/A.C.	3900537	♣K080726HD	436C (1RR)		
432D (BLD)			Caterpillar 3054 Diesel		
Caterpillar 3054T Diesel			Belt - Fan; W/Std. Fan		
Belt - Fan; W/Std. Fan	7W3896	♣9525HD	Belt - Fan; W/High Ambient Temp. Fan	7W3896	♣9525HD
Belt - Fan; W/High Ambient Temp. Fan	4N8597	♣9520HD	Belt - A.C.	4N8597	♣9520HD
Belt - A.C.	1N3743	♣9440HD	Belt - A.C.		
432D (TDR)			436C (2AR); 436C (2BR); 436C (8TN); 436C (9JN)		
Caterpillar 3054T Diesel			Caterpillar 3054T Diesel		
Belt - Fan	4N8597	♣9520HD	Belt - Fan; W/Std. Fan		
Belt - A.C.	1W2934	♣9476HD	Belt - Fan; W/High Ambient Temp. Fan	7W3896	♣9525HD
432D (WEP)			Belt - A.C.	4N8597	♣9520HD
Caterpillar 3054T Diesel			Belt - A.C.		
Belt - Fan	4N8597	②♣9520HD	Belt - A.C.		
Belt - A.C.	1W2934	♣9476HD	438 (3DJ)		
432E (BXE)			Perkins 4-Cyl. 236 Diesel		
Caterpillar 3054C Diesel			Belt - Alt.		
Belt - Fan	3S8447	♣9525HD	Belt - A.C.	2S9506	♣9600HD
Belt - A.C.	2P6818	♣9470HD	Belt - A.C.		
432E (JBA); 432E (RXS)			438B (3KK)		
Caterpillar 3054C Diesel			Caterpillar 3054T Diesel		
Belt - Fan; W/A.C.	2129353	♣K080708HD	Belt - Fan; W/Std. Fan		
Belt - Fan; W/O A.C.	3243408	♣K080530HD	Belt - Fan; W/High Ambient Temp. Fan	8M8340	♣9640HD
432F (LNR); 432F (SEJ)			Belt - A.C.	8M8341	♣9620HD
Caterpillar 3054C Diesel			Belt - A.C.		
Belt - Fan; W/O A.C.	3900532	♣K080530HD	Belt - A.C.		
Belt - Fan; W/A.C.	3900536	♣K080700HD	438C (1JR); 438C (1TR); 438C (2DR); 438C (9KN); 438D (BPE); 438D (BPN); 442D (BRG); 442D (BRY)		
434E (FSH)			Caterpillar 3054T Diesel		
Caterpillar 3054C Diesel			Belt - Fan; W/Std. Fan		
Belt - Fan	3S8447	②♣9525HD	Belt - Fan; W/High Ambient Temp. Fan	7W3896	②♣9525HD
Belt - A.C.	2P6818	♣9470HD	Belt - A.C.	4N8597	②♣9520HD
434E (SEF); 434E (SJL); 434E (SXB)			Belt - A.C.		
Caterpillar 3054C Diesel			Belt - A.C.		
Belt - Fan; W/A.C.	2129353	♣K080708HD	442D (SMJ); 442D (TBD)		
Belt - Fan; W/O A.C.	3243408	♣K080530HD	Caterpillar 3054T Diesel		
434E (SEF); 434E (SJL); 434E (SXB)			Belt - Fan		
Caterpillar 3054C Diesel			Belt - A.C.	4N8597	②♣9520HD
Belt - Fan; W/A.C.	2129353	♣K080708HD	Belt - A.C.		
Belt - Fan; W/O A.C.	3243408	♣K080530HD	442E (EME)		
434E (SEF); 434E (SJL); 434E (SXB)			Caterpillar 3054C Diesel		
Caterpillar 3054C Diesel			Belt - Fan; W/A.C.		
Belt - Fan	3S8447	②♣9525HD	Belt - Fan; W/O A.C.	2129353	♣K080708HD
Belt - A.C.	2P6818	♣9470HD	Belt - Fan; W/O A.C.		
442E (GKZ)			Caterpillar 3054C Diesel		
Caterpillar 3054C Diesel			Belt - Fan		
Belt - Fan	3S8447	②♣9525HD	Belt - A.C.	2P6818	♣9470HD
Belt - A.C.	2P6818	♣9470HD			

♣Standard Belt Available.

②Two Required.

Belts and Coolant Hose for Road & Construction Equipment

Application	Mfr. Part No.	Our No.	Application	Mfr. Part No.	Our No.
Caterpillar - Continued			Caterpillar - Continued		
442E (PCR); 444E (HXB)			571F (95N) Pipelayer		
Caterpillar 3054C Diesel			Caterpillar D333 Diesel		
Belt - Fan; W/A.C.	2129353	▲K080708HD	Belt - Fan	3L6052	②TR30808
Belt - Fan; W/O A.C.	3243408	▲K080530HD	571G (16W) Pipelayer		
444E (LBE)			Caterpillar D3306 Diesel		
Caterpillar 3054C Diesel			Belt - Fan & Alt.		②CX81
Belt - Fan	3S8447	②▲9525HD	Hose - Upper		24446
Belt - A.C.	2P6818	▲9470HD	Hose - Lower		24440
444E (NBA)			572C (21A) Pipelayer		
Caterpillar 3054C Diesel			Caterpillar D399 Diesel		
Belt - Fan; W/A.C.	2129353	▲K080708HD	Belt - Fan; Ser. No. 21A270 Thru 21A331 ..	2M8183	TR30672
Belt - Fan; W/O A.C.	3243408	▲K080530HD	572D (21A) Pipelayer		
444F (FBN); 444F (LJJ)			Caterpillar D339 Diesel		
Caterpillar 3054C Diesel			Belt - Fan; Ser. No. 21A270 Thru 21A331 ..	2M8183	TR30672
Belt - Fan; W/O A.C.	3900532	▲K080530HD	572E (65A) Pipelayer		
Belt - Fan; W/A.C.	3900536	▲K080700HD	Caterpillar D399T Diesel		
446 (6XF)			Belt - Fan; W/81 1/8" Belt O.C.	3L6052	②TR30808
Caterpillar 3114T Diesel			Belt - Fan; W/85 5/8" Belt O.C.	5H7371	②CX81
Belt - Alt.	6L6557	②▲9720HD	Belt - Alt.	2S9778	▲9590HD
Belt - W.P.	0366775	▲9341HD	Belt - Gen.; Ser. No. 65A151 Thru 65A313 .	3S6272	▲9530HD
Belt - A.C.	1W6039	▲9710HD	Belt - Gen.; Ser. No. 65A314 & After	2S5218	▲9580HD
446B (5BL)			572F PS (96N) Pipelayer		
Caterpillar 3114T Diesel			Caterpillar D333T Diesel		
Belt - Alt.	6L6557	②▲9720HD	Belt - Fan	3L6052	②TR30808
Belt - W.P.	0366775	▲9341HD	Belt - Alt.	5M8135	②▲9520HD
Belt - A.C.	1P9744	▲9415HD	572G Pipelayer		
446D (DBL)			Caterpillar 3306T Diesel		
Caterpillar 3114DIT Diesel			Hose - Upper		24444
Belt - Alt.	6L6557	②▲9720HD	Hose - Lower - Eng. To Pipe		24440
Belt - W.P.	0366775	▲9341HD	Hose - Lower - Pipe To Rad.		24440
Belt - A.C.	1P9744	▲9415HD	583H (61A) Pipelayer		
450E (EBL); 450E (LYR); 450E (RBA)			Caterpillar D343T Diesel		
Caterpillar C4.4 Diesel			Belt - Fan; W/75 7/8" Belt O.C.	2M8255	③TR30754
Belt - Fan; W/O A.C.	2831171	▲K080590HD	Belt - Fan; W/81 1/8" Belt O.C.	3L6052	③TR30808
Belt - Fan; W/A.C.	2831172	▲K080776HD	Belt - Alt.; W/62 1/2" Belt O.C.	3P25	TR24619
561B (62A) Pipelayer			Belt - Alt.; W/3/4" Belt T.W.; W/64" Belt		
Caterpillar D333 Diesel			O.C.	1P2421	TR24638
Belt - W.P.	4M9386	②TR24709	Belt - Alt.; W/1/2" Belt T.W.; W/64 1/4" Belt		
Belt - Gen.; W/69 1/4" Belt O.C.	7M5972	②TR24688	O.C.	8M8335	②▲9640HD
Belt - Gen.; W/71 1/8" Belt O.C.	5M6096	②TR24709	Belt - Gen.; Ser. No. 61A1 Thru 61A96	3S3961	▲9570HD
Belt - Starter; Ser. No. 62A1 Thru 62A191 ..	5M6096	②TR24709	Belt - Gen.; Ser. No. 61A97 Thru 61A120 ...	2S2743	②▲9550HD
561C (85H) Pipelayer			Belt - Gen.; Ser. No. 61A121 Thru 61A192 .	2S5218	▲9580HD
Caterpillar D333 Diesel			Belt - Gen.; Ser. No. 61A193 Thru 61A679 .	8M8335	▲9640HD
Belt - Gen.	5M6096	②TR24709	594 (62H) Pipelayer		
571E PS (64A) Pipelayer			Caterpillar D353TA Diesel		
Caterpillar D333 Diesel			Belt - Fan; W/85 5/8" Belt O.C.	2P8624	②CX81
Belt - Fan; Ser. No. 64A1 Thru 64A151;			Belt - Alt.; W/47" Belt O.C.	1S5138	TR24465
W/81 1/8" Belt O.C.	3L6052	②TR30808	Belt - Alt.; W/48 1/8" Belt O.C.	5M5345	TR24476
Belt - Fan; Ser. No. 64A1 Thru 64A151;			Belt - Alt.; W/66 1/4" Belt O.C.	5S5249	▲9660HD
W/85 5/8" Belt O.C.	5H7371	②CX81	613		
Belt - Alt.	2S9778	▲9590HD	Caterpillar 3208 Diesel		
Belt - Gen.; Ser. No. 64A152 Thru 64A221 .	3S6272	▲9530HD	Belt - Fan & Alt.	2P5617	②▲9710HD
Belt - Gen.; Ser. No. 64A222 & After	2S5218	▲9580HD	Belt - W.P.	3P130	②▲9500HD
571E PS (64A) Pipelayer			Belt - Hyd. Pump		▲9610HD
Caterpillar D333 Diesel			613A (71M)		
Belt - Fan; Ser. No. 64A1 Thru 64A151;			Caterpillar 3208 Diesel		
W/81 1/8" Belt O.C.	3L6052	②TR30808	Belt - Fan; W/Noise Restriction	6F2590	▲9700HD
Belt - Fan; Ser. No. 64A1 Thru 64A151;					
W/85 5/8" Belt O.C.	5H7371	②CX81			
Belt - Alt.	2S9778	▲9590HD			
Belt - Gen.; Ser. No. 64A152 Thru 64A221 .	3S6272	▲9530HD			
Belt - Gen.; Ser. No. 64A222 & After	2S5218	▲9580HD			

▲Standard Belt Available.
③Three Required.

②Two Required.

Belts and Coolant Hose for Road & Construction Equipment

Application	Mfr. Part No.	Our No.	Application	Mfr. Part No.	Our No.
Caterpillar - Continued			Caterpillar - Continued		
613A (71M) - Continued			623E (5SG); 623E (6CB); 623E (6DB); 623E (6YF)		
Caterpillar 3208 Diesel - Continued			Caterpillar 3406 Diesel		
Belt - Fan & Alt.	5M8135	③▲9520HD	Belt - Fan		③BX71
Belt - Air Brake Compr.	9M1091	▲9463HD	Belt - Alt.		TR22657
Belt - A.C.	4N2745	▲9600HD	Hose - Upper		②24440
Hose - Lower - Eng. To Pipe		24432	Hose - Lower		②24448
Hose - Lower - Pipe To Rad.		24432	627 (54K)		
613B (38W)			Caterpillar D333T Diesel		
Caterpillar 3208 Diesel			Belt - Fan; Ser. No. 54K1 Thru 54K785	2M8183	②TR30672
Belt - Fan & Alt.	2P5617	②▲9710HD	Belt - Fan; Ser. No. 54K786 & After	4M9386	②TR24709
Belt - W.P.	3P130	②▲9500HD	627 (68M)		
Belt - Hyd. Pump		▲9610HD	Caterpillar 3306 Diesel		
Hose - Upper		≧21379	Belt - Fan & Alt.; Ser. No. 68M1 Thru		
Hose - Lower - Pipe To Rad.		≧20882	68M702	2M8183	②TR30672
613C			Belt - Fan & Alt.; Ser. No. 68M703 & After ..	4M9386	②TR24709
Caterpillar 3208 Diesel			627B (14S)		
Belt - Fan & Alt.	2P5617	②▲9710HD	Caterpillar 3306T Diesel		
Belt - W.P.	3P130	②▲9500HD	Belt - Fan & Alt.	35H4207	TR30698
Belt - Hyd. Pump		▲9610HD	Belt - A.C.	2P4191	▲9525HD
613C (92X)			627B (15S)		
Caterpillar 3208 Diesel			Caterpillar 3306 Diesel		
Hose - Upper		≧21379	Belt - Fan & Alt.	35H4207	TR30698
Hose - Lower - Eng. To Pipe		≧20206	Belt - A.C.	2P4191	▲9525HD
Hose - Lower - Pipe To Rad.		≧20206	627B (38V)		
615 (46Z)			Caterpillar 3306 Diesel		
Caterpillar 3306 Diesel			Belt - Fan	2M8183	②TR30672
Belt - Fan & Alt.		②BX78	630B (14G)		
Hose - Lower - Pipe To Rad.		≧21891	Caterpillar D343 Diesel		
Hose - By Pass		23520	Belt - Fan; Ser. No. 14G1 Thru 14G333	5M1044	③TR30770
619C (61F)			Belt - Alt.; W/62 1/4" Belt O.C.	8M8336	②▲9620HD
Caterpillar D340T Diesel			Belt - Alt.; W/65 1/4" Belt O.C.	5S1817	②▲9650HD
Belt - Gen.	9M1091	③▲9463HD	Belt - Gen.; W/64 1/4" Belt O.C.	8M8335	②▲9640HD
Hose - Upper; Ser. No. 61F1 & After		24448	Belt - Gen.; W/65 1/4" Belt O.C.	5S1817	②▲9650HD
Hose - Lower; Ser. No. 61F1 & After		24452	631B (13G)		
621 (23H)			Caterpillar D343 Diesel		
Caterpillar D336 Diesel			Belt - Fan; Ser. No. 13G1 Thru 13G1693	5M1044	③TR30770
Belt - Fan; Ser. No. 23H1 Thru 23H4278	3S9652	③▲9680HD	Belt - W.P. & Gen.	1S4699	②▲9660HD
Belt - Fan; Ser. No. 23H4279 & After	2P5619	③▲9720HD	Belt - Alt.; W/62 1/4" Belt O.C.	8M8336	②▲9620HD
Belt - Alt.	2S2481	②▲9700HD	Belt - Alt.; W/65 1/4" Belt O.C.	5S1817	②▲9650HD
Belt - Gen.	1S4761	▲9720HD	Belt - Gen.; W/64 1/4" Belt O.C.	8M8335	②▲9640HD
Hose - Upper; Ser. No. 23H1 & After		24452	Belt - Gen.; W/65 1/4" Belt O.C.	5S1817	②▲9650HD
621B (45P)			632 (14G)		
Caterpillar 3406 Diesel			Caterpillar D343 Diesel		
Belt - Fan		③TR22720	Belt - Fan; Ser. No. 14G1 Thru 14G333	5M1044	③TR30770
Belt - Alt.		TR22720	Belt - Alt.; W/62 1/4" Belt O.C.	8M8336	②▲9620HD
Belt - A.C.	4N2745	▲9600HD	Belt - Alt.; W/65 1/4" Belt O.C.	5S1817	②▲9650HD
Hose - Upper		23550	Belt - Gen.; W/64 1/4" Belt O.C.	8M8335	②▲9640HD
Hose - Lower		②24448	Belt - Gen.; W/65 1/4" Belt O.C.	5S1817	②▲9650HD
623 (52U)			633		
Caterpillar 3306 Diesel			Caterpillar D343 Diesel		
Belt - Fan	2P5619	③▲9720HD	Hose - Upper		24448
Belt - Alt.	2P5617	②▲9700HD	Hose - Lower		24460
623B (46P)			633 (44J)		
Caterpillar 3406 Diesel			Caterpillar D343 Diesel		
Belt - A.C.	4N2745	▲9600HD	Belt - Alt.	5S1817	②▲9650HD
Hose - Upper		23550			
Hose - Lower - Eng. To Pipe		24448			
Hose - Lower - Pipe To Rad.		24448			

▲Standard Belt Available.
≧Cut to Fit.

②Two Required.
③Three Required.

Belts and Coolant Hose for Road & Construction Equipment

Application	Mfr. Part No.	Our No.	Application	Mfr. Part No.	Our No.
Caterpillar - Continued			Caterpillar - Continued		
633C (66M)			651B (67K)		
Caterpillar D343 Diesel			Caterpillar D346 Diesel		
Belt - W.P. & Alt.		②▲9640HD	Belt - Alt.		BX50
637 (79P)			Belt - A.C.	2P8720	▲9650HD
Caterpillar D343 Diesel			657 (19G)		
Belt - Alt.	8M8335	②▲9640HD	Caterpillar D346 Diesel		
Belt - A.C.	2P4230	▲9580HD	Belt - Fan; Ser. No. 19G1 Thru 19G217 5M1044		
637D (23W)			Belt - W.P.; Ser. No. 19G1 Thru 19G91 8M8335		
Caterpillar D343 Diesel			Belt - W.P.; Ser. No. 19G92 & After 5S1817		
Belt - Fan 1L5681		②TR30652	657 (31G)		
637D (27W)			Caterpillar D343 Diesel		
Caterpillar 3408 Diesel			Belt - Fan; Ser. No. 31G1 Thru 31G273 2H1383		
Belt - Fan 6N5338		②BX77	Belt - W.P. 4M6292		
Belt - Alt. 9L6639		TR22570	Belt - Gen.; Ser. No. 31G1 Thru 31G143 8M3092		
641 (41M)			657 (46M)		
Caterpillar D346 Diesel			Caterpillar D343 Diesel		
Belt - W.P. 4M6292		TR24619	Belt - W.P. 4M6292		
Hose - Upper - Eng. To Water Manifold 24436			TR24619		
Hose - Upper - Eng. To Pipe 24460			657B (47M)		
Hose - Lower - Eng. To Pipe 24480			Caterpillar D346 Diesel		
Hose - Lower - Water Manifold To Pipe 24448			Belt - W.P. 5S1817		
641 (50G)			657B (68K)		
Caterpillar D346 Diesel			Caterpillar D346 Diesel		
Hose - Upper - Eng. To Water Manifold 24436			Belt - A.C. 2P8720		
Hose - Upper - Eng. To Pipe 24460			▲9650HD		
Hose - Lower - Eng. To Pipe 24480			657E (86Z)		
Hose - Lower - Water Manifold To Pipe 24448			Caterpillar 3408/3412 Diesel		
641 (64F)			Belt - Fan - Front & Rear Eng. 6N0073		
Caterpillar D346 Diesel			Belt - Alt. - Front Eng. ▲9570HD		
Belt - Fan; Ser. No. 64F1 Thru 64F586 2H1383		③TR30672	Belt - Alt. - Rear Eng. TR22570		
Belt - W.P. 4M6292		TR24619	Belt - A.C. ▲9500HD		
Belt - Gen.; Ser. No. 64F1 Thru 64F194 8M3092		9765	Hose - Upper - Front Eng. ④24440		
Hose - Upper - Eng. To Water Manifold 24436			Hose - Upper - Rear Eng. ②24440		
Hose - Upper - Eng. To Pipe 24460			Hose - Lower - Front Eng. ②24464		
Hose - Lower - Eng. To Pipe 24480			Hose - Lower - Rear Eng. ②24456		
Hose - Lower - Water Manifold To Pipe 24448			660B (58K)		
641 (70G); 641 (80F)			Caterpillar D346 Diesel		
Caterpillar D346 Diesel			Belt - A.C. 2P8720		
Hose - Upper - Eng. To Water Manifold 24436			▲9650HD		
Hose - Upper - Eng. To Pipe 24460			666 (77F)		
Hose - Lower - Eng. To Pipe 24480			Caterpillar D346 Diesel		
Hose - Lower - Water Manifold To Pipe 24448			Belt - Fan; Ser. No. 77F1 Thru 77F246 2H1383		
641B (65K)			Belt - W.P. 4M6292		
Caterpillar D346 Diesel			TR24619		
Belt - A.C. 2P8720		▲9650HD	666B (66K)		
651 (33G)			Caterpillar D346 Diesel		
Caterpillar D346 Diesel			Belt - A.C. 2P8720		
Belt - Fan; Ser. No. 33G1 Thru 33G199 2H1383		③TR30672	▲9650HD		
Belt - W.P. 4M6292		TR24619	768C (02X)		
Belt - Gen.; Ser. No. 33G1 Thru 33G143 8M3092		9765	Caterpillar 3408 Diesel		
651 (44M)			Belt - Fan 1L5681		
Caterpillar D346 Diesel			Belt - W.P. & Gen. 1S4699		
Belt - W.P. 4M6292		TR24619	Belt - Alt. 5S1817		
651 (33G)			769 (99F)		
Caterpillar D346 Diesel			Caterpillar D343T Diesel		
Belt - Fan; Ser. No. 33G1 Thru 33G199 2H1383		③TR30672	Belt - Fan 1L5681		
Belt - W.P. 4M6292		TR24619	Belt - W.P. & Gen. 1S4699		
Belt - Gen.; Ser. No. 33G1 Thru 33G143 8M3092		9765	Belt - Alt. 5S1817		
651 (44M)			②TR30652		
Caterpillar D346 Diesel			②▲9660HD		
Belt - W.P. 4M6292		TR24619	②▲9650HD		

▲Standard Belt Available.
③Three Required.

②Two Required.
④Four Required.

Belts and Coolant Hose for Road & Construction Equipment

Application	Mfr. Part No.	Our No.	Application	Mfr. Part No.	Our No.
Caterpillar - Continued			Caterpillar - Continued		
773 (63G)			910 (80U)		
Caterpillar D346T Diesel			Caterpillar 3204 Diesel		
Belt - A.C.; W/63 1/4" Belt O.C.	2P6161	▲9630HD	Belt - Fan & Alt.; W/3/4" Belt T.W.; W/60 7/8" Belt O.C.	7M3921	②TR24597
Belt - A.C.; W/65 1/4" Belt O.C.	2P8720	▲9650HD	Belt - Fan & Alt.; W/1/2" Belt T.W.; W/62 1/4" Belt O.C.	8M8336	③▲9620HD
814 (90P)			Hose - Upper		
Caterpillar 3306 Diesel			or		
Belt - Fan & Alt.; Ser. No. 90P120 & After ...	5H1678	②TR30722	Hose - Lower		
Belt - A.C.; Ser. No. 90P1 Thru 90P202	2P4191	▲9525HD	③<20046		
Belt - A.C.; Ser. No. 90P203 & After	4N6130	▲9520HD	26501		
Hose - Upper	24446		③<20431		
Hose - Lower	24440		920 (41J)		
815 (91P)			Caterpillar 3304 Diesel		
Caterpillar 3306 Diesel			Hose - Upper		
Belt - Fan & Gen.; Ser. No. 91P129 & After ...	5H1678	②TR30722	Hose - Lower		
Belt - A.C.; Ser. No. 91P129 Thru 91P527 ..	2P4191	▲9525HD	24444		
Belt - A.C.; Ser. No. 91P528 & After	4N6130	▲9520HD	24444		
Hose - Upper - Eng. To Pipe	24444		920 (62K)		
Hose - Upper - Pipe To Rad.	24444		Caterpillar 3304 Diesel		
Hose - Lower - Pipe To Rad.	24442		Hose - Upper		
816 (57U)			Hose - Lower		
Caterpillar 3306 Diesel			24444		
Belt - Fan & Alt.	5H1678	②TR30722	920 (75J)		
Belt - A.C.	4N6130	▲9520HD	Caterpillar 3304 Diesel		
824			Belt - Fan & Alt.		
Caterpillar D340 Diesel			5H1678		
Hose - Upper			TR30722		
24448			Hose - Upper		
824 (29G)			24444		
Caterpillar D340 Diesel			Hose - Lower		
Belt - Alt.	3L5751	TR24500	24444		
Belt - W.P.	8M1715	TR24664	922A (59A)		
824B			Caterpillar D320 Diesel		
Caterpillar D343 Diesel			Belt - Gen.		
Hose - Upper			8M760		
24448			9775		
824B (36H)			Belt - Air Brake Compr.		
Caterpillar D343 Diesel			5M923		
Belt - Alt.	3L5751	TR24500	▲9740HD		
Belt - W.P.	8M1715	TR24664	Hose - Upper		
824B			24448		
Caterpillar D343 Diesel			Hose - Lower		
Hose - Upper			24448		
24448			922A (63A)		
824B (36H)			Caterpillar D320 Diesel		
Caterpillar D343 Diesel			Belt - Fan; Ser. No. 63A1 Thru 63A604		
Belt - Alt.; W/64 1/4" Belt O.C.	8M8335	②▲9640HD	3K8774		
Belt - Alt.; W/65 1/4" Belt O.C.	5S1817	②▲9650HD	②TR24578		
Hose - Upper	24448		Belt - Gen.		
Hose - Lower; Ser. No. 36H1 Thru 36H192	24444		3K9746		
Hose - Lower; Ser. No. 36H193 Thru 36H580	24444		②TR24578		
825B (43N)			Belt - Air Brake Compr.		
Caterpillar D343T Diesel			3K3408		
Belt - W.P. & Alt.	8M8335	②▲9640HD	Hose - Upper		
834			24448		
Caterpillar D343 Diesel			Hose - Lower		
Hose - Upper			24448		
24452			922B (88J)		
834 (43E)			Caterpillar D330 Diesel		
Caterpillar D343 Diesel			Belt - Fan		
Belt - W.P. & Gen.	8M8335	②▲9640HD	4M6292		
Belt - Alt.	5S1817	②▲9650HD	②TR24619		
835 (44N)			Belt - Gen.		
Caterpillar D343 Diesel			1M2045		
Belt - Alt.			②TR24607		
8M8335			24448		
835 (44N)			Hose - Upper		
Caterpillar D343 Diesel			24448		
Belt - Alt.			Hose - Lower		
8M8335			24448		
835 (44N)			922B (94A)		
Caterpillar D343 Diesel			Caterpillar D330 Diesel		
Belt - Alt.			Belt - Fan		
8M8335			2N1493		
835 (44N)			②▲9425HD		
Caterpillar D343 Diesel			Belt - W.P.		
Belt - Alt.			8M9708		
8M8335			TR30589		
835 (44N)			Belt - Gen.		
Caterpillar D343 Diesel			1S5138		
Belt - Alt.			TR24465		
8M8335			926 (4NB); 926 (4TC); 926 (7TC); 926 (8NB); 926 (94Z)		
835 (44N)			Caterpillar 3204 Diesel		
Caterpillar D343 Diesel			Hose - Upper - Eng. To Pipe		
Belt - Alt.			24428		
8M8335			Hose - Upper - Pipe To Rad.		
835 (44N)			24428		
Caterpillar D343 Diesel			Hose - Lower - Eng. To Pipe		
Belt - Alt.			24436		
8M8335			Hose - Lower - Pipe To Rad.		
835 (44N)			24436		
Caterpillar D343 Diesel			926E (94Z)		
Belt - Alt.			Caterpillar 3204 Diesel		
8M8335			Belt - Fan & Alt.		
835 (44N)			②▲9680HD		

▲Standard Belt Available.
③Three Required.

②Two Required.
③<Cut to Fit.

Belts and Coolant Hose for Road & Construction Equipment

Application	Mfr. Part No.	Our No.	Application	Mfr. Part No.	Our No.
Caterpillar - Continued			Caterpillar - Continued		
926E (94Z) - Continued			941 (80H) - Continued		
Caterpillar 3204 Diesel - Continued			Caterpillar D330 Diesel - Continued		
Belt - W.P.		♣9485HD	Belt - A.C.; Ser. No. 80H2462 Thru 80H3039	2P6819	♣9463HD
Hose - Upper		②24428	Belt - A.C.; Ser. No. 80H3040 & After	2P6818	♣9470HD
Hose - Lower		②24436	941B (80H)		
930 (8CB); 930 (17B)			Caterpillar 3304 Diesel		
Caterpillar 3304 Diesel			Belt - Fan; Ser. No. 80H1 Thru 80H2461		
Hose - Upper		24444		2M8502	②TR24638
Hose - Lower		24248	Belt - Fan; Ser. No. 80H2462 & After	4M6292	②TR24619
930 (41K)			Belt - Alt.	4M6292	②TR24619
Caterpillar 3304 Diesel			Belt - Gen.	7S9857	②TR24638
Belt - Fan; Ser. No. 41K1708 & After	7M5535	②TR24709	Belt - A.C.; Ser. No. 80H2462 Thru 80H3039	2P6819	♣9463HD
Belt - Fan & Alt.; W/68 5/8" Belt O.C.		②TR28680	Belt - A.C.; Ser. No. 80H3040 & After	2P6818	♣9470HD
Belt - Fan & Alt.; W/11/16" Belt T.W.; W/72 5/8" Belt O.C. .		②TR22720	943 (19Z)		
Belt - Fan & Alt.; W/15/16" Belt T.W.; W/72 5/8" Belt O.C.	5H1678	TR30722	Caterpillar 3204 Diesel		
Belt - Fan & A.C.; Ser. No. 41K1 Thru 41K3207	7M5535	②TR24709	Belt - W.P. & Alt.	8M8336	②♣9620HD
Hose - Upper		24242	Hose - Upper		②24428
Hose - Lower		24242	Hose - Lower		②24436
930 (57Z); 930 (60G); 930 (71H); 930 (73U); 930 (79J)			944 (87J)		
Caterpillar 3304 Diesel			Caterpillar D330 Diesel		
Hose - Upper		24444	Belt - Fan	7S9812	②TR24647
Hose - Lower		24248	Belt - Alt.	1P2421	②TR24638
930G			Belt - Gen.	7S9857	②TR24638
Caterpillar 3056 Diesel			950 (58H)		
Belt - Fan	0617140	②♣9540HD	Caterpillar 3304 Diesel		
Belt - A.C.	1W2934	♣9476HD	Hose - Upper; Ser. No. 58H1 Thru 58H520		
933C (11A); 933E (11A)			24444		
Caterpillar D311 Diesel			950 (81J)		
Belt - Alt.	5B7168	♣9390HD	Caterpillar 3304 Diesel		
Belt - Gov.	5B7168	♣9390HD	Belt - Fan; W/62 1/2" Belt O.C.	4M6292	②TR24619
Belt - Starter	6B5653	TR24438	Belt - Fan; W/64" Belt O.C.	7M6100	②TR24638
933G (42A)			Belt - Fan & Alt.	6N735	②TR30652
Caterpillar D320T Diesel			Belt - Alt.	2P1233	②TR24619
Belt - W.P.	8H9832	②TR24638	Belt - Gen.	7S9857	②TR24638
Belt - W.P. & Gen.	2M8502	②TR24638	Belt - A.C.; W/54 1/4" Belt O.C.	4N6013	♣9540HD
936 (2ZB); 936 (4SB); 936 (5GC); 936 (33Z); 936 (45Z)			Belt - A.C.; W/56 1/4" Belt O.C.	2P4685	♣9560HD
Caterpillar 3304 Diesel			950 (90A)		
Hose - Upper - Eng. To Pipe		24440	Caterpillar 3304 Diesel		
Hose - Upper - Pipe To Rad.		24440	Hose - Upper; Ser. No. 90A1 Thru 90A3142		
Hose - Lower - Eng. To Pipe		21891	24444		
Hose - Lower - Pipe To Rad.		24440	950B (22Z)		
936E (33Z)			Caterpillar 3304 Diesel		
Caterpillar 3304 Diesel			Belt - Fan & Alt.		
Hose - Upper		②24440	Belt - A.C.		
938G			Hose - Upper		
Caterpillar 3126 Diesel			Hose - Lower		
Belt - W.P.	0366775	♣9341HD	②24440		
Belt - Fan & Alt.		2/9447PB	951B (69H)		
Belt - A.C.	1P4334	♣9495HD	Caterpillar D330 Diesel		
941 (80H)			Belt - Fan & Gen.		
Caterpillar D330 Diesel			1P2421		
Belt - Fan; Ser. No. 80H1 Thru 80H2461	2M8502	②TR24638	951B (79H)		
Belt - Fan; Ser. No. 80H2462 & After	4M6292	②TR24619	Caterpillar D330 Diesel		
Belt - Alt.	4M6292	②TR24619	Belt - W.P.		
Belt - Gen.	7S9857	②TR24638	4S7755		
941 (80H)			Belt - Gen.; W/47" Belt O.C.		
Caterpillar D330 Diesel			1S5138		
Belt - Fan; Ser. No. 80H1 Thru 80H2461	2M8502	②TR24638	Belt - Gen.; W/48 1/8" Belt O.C.		
Belt - Fan; Ser. No. 80H2462 & After	4M6292	②TR24619	5M5345		
Belt - Alt.	4M6292	②TR24619	951C (69H)		
Belt - Gen.	7S9857	②TR24638	Caterpillar 3304 Diesel		
941 (80H)			Belt - Fan & Gen.		
Caterpillar D330 Diesel			1P2421		
Belt - Fan; Ser. No. 80H1 Thru 80H2461	2M8502	②TR24638	②TR24638		
Belt - Fan; Ser. No. 80H2462 & After	4M6292	②TR24619			
Belt - Alt.	4M6292	②TR24619			
Belt - Gen.	7S9857	②TR24638			

②Two Required.

♣Standard Belt Available.

Road & Construction
Equipment

Belts and Coolant Hose for Road & Construction Equipment

Application	Mfr. Part No.	Our No.	Application	Mfr. Part No.	Our No.	
Caterpillar - Continued			Caterpillar - Continued			
951C (86J)			966C (9KC); 966C (18B); 966C (25U)			
Caterpillar 3304 Diesel			Caterpillar 3306 Diesel			
Belt - Fan & Alt.; Ser. No. 86J1902 Thru 86J1991	2P1385	②TR24619	Hose - Upper; W/2 1/2" I.D. Hose		24440	
Belt - Fan & Alt.; Ser. No. 86J1992 & After . 7S9812		②TR24647	Hose - Upper; W/2 3/4" I.D. Hose		24444	
Belt - Fan & Gen.; Ser. No. 86J1 Thru 86J1901	7S9857	②TR24638	Hose - Upper; W/3" I.D. Hose		24448	
Belt - A.C.; Ser. No. 86J1 Thru 86J1991	2P6819	♣9463HD	Hose - Lower; W/2 1/4" I.D. Hose		24436	
Belt - A.C.; Ser. No. 86J1992 & After	2P6818	♣9470HD	Hose - Lower; W/2 1/2" I.D. Hose		24440	
953 (76Y)			966C (30K)			
Caterpillar 3204T Diesel			Caterpillar 3306 Diesel			
Belt - Fan	2S2481	②♣9700HD	Hose - Upper; Ser. No. 30K1 & After		24444	
Belt - Alt.	8M8341	②♣9620HD	Hose - Lower; Ser. No. 30K1 & After		24448	
955C (12A)			966C (42J)			
Caterpillar D315 Diesel			Caterpillar 3306 Diesel			
Belt - Fan & W.P.; Ser. No. 12A1 Thru 12A5737	4F7956	TR34506	Hose - Upper; W/2 1/2" I.D. Hose		24440	
Belt - W.P.; Ser. No. 12A5738 Thru 12A8418		TR34506	Hose - Upper; W/2 3/4" I.D. Hose		24444	
Belt - Alt.	5B7168	♣9390HD	Hose - Upper; W/3" I.D. Hose		24448	
Belt - Gov.	5B7168	♣9390HD	Hose - Lower; W/2 1/4" I.D. Hose		24436	
Belt - Starter	6B5653	TR24438	Hose - Lower; W/2 1/2" I.D. Hose		24440	
955E (12A)			966C (76J)			
Caterpillar D330 Diesel			Caterpillar 3306 Diesel			
Belt - Fan & W.P.; Ser. No. 12A1 Thru 12A5737	4F7956	TR34506	Belt - Fan; Ser. No. 76J1 Thru 76J2516	1H6929	②TR30770	
Belt - W.P.; Ser. No. 12A5738 Thru 12A8418		TR34506	Belt - Fan & Alt.; Ser. No. 76J2517 Thru 76J4250		②TR30710	
Belt - Alt.	5B7168	♣9390HD	Belt - Fan & Alt.; Ser. No. 76J4251 & After . 5H1678		②TR30722	
Belt - Gov.	5B7168	♣9390HD	Belt - A.C.; Ser. No. 76J4251 Thru 76J6388	2P4191	♣9525HD	
Belt - Starter	6B5653	TR24438	Belt - A.C.; Ser. No. 76J6389 & After	4N6130	♣9520HD	
955H (60A)			Hose - Upper; Ser. No. 76J1 & After			24444
Caterpillar D330T Diesel			Hose - Lower; Ser. No. 76J1 & After			24448
Belt - W.P.; Ser. No. 60A1 Thru 60A220	4M9678	②TR24578	966C (78G)			
Belt - W.P.; Ser. No. 60A3263 Thru 60A10341	8M1715	②TR24664	Caterpillar 3306 Diesel			
Belt - W.P.; Ser. No. 60A10342 Thru 60A11298	2M8502	②TR24638	Hose - Upper; W/2 1/2" I.D. Hose			24440
Belt - W.P.; Ser. No. 60A11299 & After	4S7755	②TR24647	Hose - Upper; W/2 3/4" I.D. Hose			24444
Belt - Gen.; W/41 7/8" Belt O.C.	5M5344	TR24414	Hose - Upper; W/3" I.D. Hose			24448
Belt - Gen.; W/47" Belt O.C.	1S5138	TR24465	Hose - Lower; W/2 1/4" I.D. Hose			24436
Belt - Gen.; W/48 1/8" Belt O.C.	5M5345	TR24476	Hose - Lower; W/2 1/2" I.D. Hose			24440
955K (61H)			Hose - Lower; W/3" I.D. Hose			♣23575
Caterpillar D330T Diesel			966D (99Y)			
Belt - W.P.	4S7755	②TR24647	Caterpillar 3306 Diesel			
Belt - Gen.	1S5138	TR24465	Belt - A.C.			♣9451HD
955L (85J)			Hose - Upper; W/2 1/2" I.D. Hose			24440
Caterpillar D330T Diesel			Hose - Upper; W/3" I.D. Hose			24448
Belt - Fan	7S9812	②TR24647	Hose - Lower			24440
Belt - Fan & Alt.	1P2421	②TR24638	973 (66G)			
966A (33A)			Caterpillar 3306 Diesel			
Caterpillar D333T Diesel			Belt - Fan & Alt.			7N9417
Hose - Upper; Ser. No. 33A1 Thru 33A2110		24444	Belt - Compr.			1N3743
Hose - Lower; Ser. No. 33A1 Thru 33A2110		24448	Hose - Upper			②24440
966B (75A)			Hose - Lower - Eng. To Pipe			24440
Caterpillar D333T Diesel			973 (86G)			
Belt - Fan	5H1678	TR30722	Caterpillar 3306 Diesel			
Belt - Gen. & Air Brake Compr.	1S4760	②♣9720HD	Belt - Fan & Alt.			②B86
Hose - Upper; Ser. No. 75A1 & After		24444	Hose - Upper			②24440
Hose - Lower; Ser. No. 75A1 & After		24448	Hose - Lower - Eng. To Pipe			24440
966C (12A)			977D (20A); 977E (20A)			
Caterpillar D315 Diesel			Caterpillar D318 Diesel			
Belt - Fan & W.P.; Ser. No. 12A1 Thru 12A5737	4F7956	TR34506	Belt - Gov.			4B2544
Belt - W.P.; Ser. No. 12A5738 Thru 12A8418		TR34506				②♣9425HD
Belt - Alt.	5B7168	♣9390HD				
Belt - Gov.	5B7168	♣9390HD				
Belt - Starter	6B5653	TR24438				

②Two Required.
♣Cut to Fit.

♣Standard Belt Available.

Road & Construction Equipment

Belts and Coolant Hose for Road & Construction Equipment

Application	Mfr. Part No.	Our No.	Application	Mfr. Part No.	Our No.
Caterpillar - Continued			Caterpillar - Continued		
977H (53A)			CB514 (6YD)		
Caterpillar D333T Diesel			Detroit Diesel 3-53 Diesel		
Belt - Alt	2S2743	▲9550HD	Belt - Fan & Alt	5133173	②7420
Belt - Gen.; Ser. No. 53A1 Thru 53A2271 ...	7M169	TR24530	Hose - Upper		③<20957
Hose - Upper; Ser. No. 53A3000 Thru 53A8886		24444		or	26501
Hose - Lower; Ser. No. 53A3000 Thru 53A8886		24448			
977K (11K)			D2 (4U)		
Caterpillar D333T Diesel			Caterpillar D311 Diesel		
Belt - Fan; Ser. No. 11K1 Thru 11K3219	2M8255	②TR30754	1957 - 1948		
977L (11K)			Belt - Fan; Ser. No. 4U1 Thru 4U6905		
Caterpillar D318 Diesel			5F7676		
Belt - Fan; Ser. No. 11K1 Thru 11K3219	2M8255	②TR30754	TR30484		
980 (42H)			Belt - Fan; Ser. No. 5U1 Thru 5U15474		
Caterpillar D336 Diesel			5F7676		
Belt - Alt	4S8353	②▲9700HD	TR30506		
Belt - Gen.	1S4761	②▲9720HD	Belt - Fan; Ser. No. 4U6906 Thru 4U7560 ..		
Hose - Upper; Ser. No. 42H1 & After		24452	5H2896		
Hose - Lower; Ser. No. 42H1 & After		24464	TR30506		
980B (89P)			Belt - Fan; Ser. No. 5U15475 Thru		
Caterpillar 3306 Diesel			5U18894		
Belt - A.C.; W/54 1/4" Belt O.C.	4N6013	▲9540HD	5H2896		
Belt - A.C.; W/58 1/4" Belt O.C.	2P4230	▲9580HD	TR30506		
Hose - Lower; Ser. No. 89P1 & After		24448	Belt - Starter		
980C			5B5653		
Caterpillar 3306DITA Diesel			TR24438		
Hose - Upper		24440	D2 (5U)		
Hose - Lower		24448	Caterpillar D311 Diesel		
980C (63X)			1958 - 1948		
Caterpillar 3406 Diesel			Belt - Fan; Ser. No. 4U1 Thru 4U6905		
Belt - Fan	4N8219	③B72	5F7676		
Belt - Alt	6N0341	TR22514	TR30484		
983 (38K)			Belt - Fan; Ser. No. 4U6906 Thru 4U7560 ..		
Caterpillar D343T Diesel			5H2896		
Belt - Alt	4S6209	②▲9650HD	TR30506		
Belt - A.C.	2P4685	▲9560HD	Belt - Fan; Ser. No. 5U15475 Thru		
988 (87A)			5U18894		
Caterpillar D343T Diesel			5H2896		
Belt - Alt.; W/64 1/4" Belt O.C.	8M8335	②▲9640HD	TR30506		
Belt - Alt.; W/65 1/4" Belt O.C.	5S1817	②▲9650HD	Belt - Starter		
Hose - Upper; Ser. No. 87A531 & After		24448	5B5653		
988B (50W)			TR24438		
Caterpillar 3408 Diesel			D3 (79U)		
Belt - Fan		③TR22770	Caterpillar 3204 Diesel		
Belt - Alt	9L6639	TR22570	1979 - 1973		
Belt - Hyd. Pump	3P130	▲9500HD	Belt - Fan & Alt		
Hose - Upper		②23550	7M3921		
Hose - Lower		23585	TR24597		
992 (25K)			D3B (27Y)		
Caterpillar D348T Diesel			Caterpillar 3204 Diesel		
Belt - Fan	3L6052	④TR30808	1988 - 1979		
Belt - A.C.	9M1091	▲9463HD	Belt - Fan & Alt		
Hose - Upper; Ser. No. 25K1 & After		24464	②▲9620HD		
Hose - Lower; Ser. No. 25K1 & After		24480	Hose - Upper		
			26501		

②Two Required.
③Three Required.
④Cut to Fit.

▲Standard Belt Available.
④Four Required.

Road & Construction Equipment

Belts and Coolant Hose for Road & Construction Equipment

Application	Mfr. Part No.	Our No.	Application	Mfr. Part No.	Our No.
Caterpillar - Continued			Caterpillar - Continued		
D3C (5ZG)			D3G (CFC)		
Caterpillar 3204 Diesel			Caterpillar 3046 Diesel		
1993 - 1990			2003 - 2001		
Belt - Fan	8N2818	♣9610HD	Belt - Alt.	1S1193	♣9500HD
D3C (6PF)			Belt - Compr.	1N3743	♣9440HD
Caterpillar 3204 Diesel			D3G (CFF)		
1991 - 1988			Caterpillar 3046 Diesel		
Belt - Fan	8N2818	♣9610HD	2002		
D3C (7JF)			Belt - Alt.	1S1193	♣9500HD
Caterpillar 3204 Diesel			Belt - Compr.	1N3743	♣9440HD
1993 - 1988			D3G XL (JMH)		
Belt - Fan	6L7954	②♣9463HD	Caterpillar 3046 Diesel		
Belt - Alt.	4W6025	②♣9570HD	2003		
D3C (7JG)			Belt - Alt.	1110575	②♣9485HD
Caterpillar 3204 Diesel			Belt - Compr.	1N3743	♣9440HD
1993 - 1991			D3K		
Belt - Fan	8N2818	♣9610HD	Caterpillar C4.4 Diesel		
D3C (8BF)			2012 - 2008		
Caterpillar 3204 Diesel			Belt - Fan	3096666	♣K080550HD
1990 - 1988			D3K LGP (JTD)		
Belt - Fan	8N2818	♣9610HD	Caterpillar C4.4 Diesel		
D3C (8DG)			2013 - 2008		
Caterpillar 3204 Diesel			Belt - Fan	3096666	♣K080550HD
1993 - 1990			D3K LGP (LLL)		
Belt - Fan	8N2818	♣9610HD	Caterpillar C4.4 Diesel		
D3C II (4HJ)			2013 - 2008		
Caterpillar 3204 Diesel			Belt - Fan	3096666	♣K080876HD
1994 - 1990			D3K LGP II (GAE); D3K LGP II (KLL)		
Belt - Fan	8N2818	♣9610HD	Caterpillar C4.4 Diesel		
D3C III (4KS); D3C III (4TS); D3C III (5GS)			2013 - 2012		
Caterpillar 3046 Diesel			Belt - Fan	2610370	♣K080755HD
2002 - 1997			D3K XL (FFF)		
Belt - Fan	5L4995	②♣9505HD	Caterpillar C4.4 Diesel		
Belt - Compr.	2P6820	♣9451HD	2013 - 2008		
D3C III (6SL)			Belt - Fan	3096666	♣K080876HD
Caterpillar 3046 Diesel			D3K XL II (KFF)		
2002 - 1994			Caterpillar C4.4 Diesel		
Belt - Alt.	6L8161	②♣9476HD	2013 - 2012		
Belt - Compr.	2P6820	♣9451HD	Belt - Fan	2610370	♣K080755HD
D3C LGP III (7XL)			D3K2		
Caterpillar 3046 Diesel			Caterpillar C4.4 Diesel		
2001 - 1994			2012		
Belt - Alt.	6L8161	②♣9476HD	Belt - Fan	2610370	♣K080755HD
Belt - Compr.	2P6820	♣9451HD	D4 (6U)		
D3C XL III (9TS)			Caterpillar 4-Cyl. 350 Diesel		
Caterpillar 3046 Diesel			1959 - 1947		
2000 - 1997			Belt - Fan & W.P.; Ser. No. 6U1 Thru		
Belt - Alt.	6L8161	②♣9476HD	6U10843	4F7956	TR34506
Belt - Compr.	2P6820	♣9451HD	Belt - Fan & W.P.; Ser. No. 7U1 Thru		
D3G (BYR)			7U31974	4F7956	TR34506
Caterpillar 3046 Diesel			Belt - Alt. & Gov.		♣9390HD
2003 - 2001			Belt - Starter	6B5653	TR24438
Belt - Alt.	1110575	②♣9485HD	D4 (7J)		
Belt - Compr.	1N3743	♣9440HD	Caterpillar D4400 Diesel		
			1944 - 1939		
			Belt - Fan & W.P.	7B4032	TR34495
			Belt - Alt.	5B7168	♣9390HD

♣Standard Belt Available.

②Two Required.

Belts and Coolant Hose for Road & Construction Equipment

Application	Mfr. Part No.	Our No.	Application	Mfr. Part No.	Our No.
Caterpillar - Continued			Caterpillar - Continued		
D4 (7J) - Continued			D4C III (8CS)		
Caterpillar D4400 Diesel - Continued			Caterpillar 3046 Diesel		
1944 - 1939 - Continued			2002 - 1997		
Belt - Starter		TR24438	Belt - Fan	5L4995	②♣9505HD
D4 (7U)			Belt - Compr.	2P6820	♣9451HD
Caterpillar 4-Cyl. 350 Diesel			D4C LGP (2CJ)		
1959 - 1947			Caterpillar 3204 Diesel		
Belt - Fan & W.P.; Ser. No. 6U1 Thru			1990 - 1988		
6U10843	4F7956	TR34506	Belt - Fan	8N2818	♣9610HD
Belt - Fan & W.P.; Ser. No. 7U1 Thru			D4C XL III (1FW)		
7U31974	4F7956	TR34506	Caterpillar 3046 Diesel		
Belt - Alt. & Gov.		♣9390HD	2002 - 1998		
Belt - Starter	6B5653	TR24438	Belt - Alt.	6L8161	②♣9476HD
D4C (1RJ)			Belt - Compr.	2P6820	♣9451HD
Caterpillar 3204 Diesel			D4D		
1992 - 1987			Caterpillar 3304 Diesel		
Belt - Fan	8N2818	♣9610HD	1977 - 1963		
D4C (39A)			Hose - Upper		
Caterpillar D330 Diesel			Hose - Lower		
1966 - 1959			24444		
Belt - W.P.	8M1715	TR24664	24440		
Belt - W.P. & Gen.; Ser. No. 39A1 Thru			D4D (22C)		
39A581	8M1715	TR24664	Caterpillar 3304 Diesel; Caterpillar D315 Diesel; Caterpillar		
Belt - W.P. & Gen.; Ser. No. 40A1 Thru			D330 Diesel		
40A5253	8M1715	TR24664	1968 - 1967		
D4C (40A)			Belt - W.P.	5S1817	②♣9650HD
Caterpillar D330 Diesel			Belt - Gen.	4M6291	♣9415HD
1963 - 1959			D4D (78A)		
Belt - W.P.	8M1715	TR24664	Caterpillar 3304 Diesel		
Belt - W.P. & Gen.; Ser. No. 39A1 Thru			1968 - 1963		
39A581	8M1715	TR24664	Belt - Fan	5S1817	②♣9650HD
Belt - W.P. & Gen.; Ser. No. 40A1 Thru			Belt - W.P.; Ser. No. 78A1 & After	8M1715	TR24664
40A5253	8M1715	TR24664	Belt - Gen.		♣9415HD
D4C II (7KG); D4C II (9BG)			D4D (82J)		
Caterpillar 3204 Diesel			Caterpillar 3304 Diesel		
1994 - 1990			1977 - 1968		
Belt - Fan	8N2818	♣9610HD	Belt - Fan; Ser. No. 82J1 Thru 82J2979	2M8502	②TR24638
D4C III (4LS)			Belt - Fan; Ser. No. 82J2980 Thru 82J3259	2P1385	②TR24619
Caterpillar 3046 Diesel			Belt - Fan; Ser. No. 82J3260 & After	1P2421	②TR24638
2000 - 1994			Belt - Alt.	4M6292	②TR24619
Belt - Fan	5L4995	②♣9505HD	Belt - Gen.; Ser. No. 82J1 Thru 82J2979	7S9857	②TR24638
Belt - Compr.	2P6820	♣9451HD	Belt - A.C.; Ser. No. 82J1 Thru 82J3259;		
D4C III (6BS)			W/47 1/4" Belt O.C.	2P6818	♣9470HD
Caterpillar 3046 Diesel			Belt - A.C.; Ser. No. 82J1 Thru 82J3259;		
2002 - 1996			W/62 1/2" Belt O.C.	2P1385	②TR24619
Belt - Fan	5L4995	②♣9505HD	Belt - A.C.; Ser. No. 82J3260 & After; W/47		
Belt - Compr.	2P6820	♣9451HD	1/4" Belt O.C.	2P6818	♣9470HD
D4C III (6YL)			Belt - A.C.; Ser. No. 82J3260 & After;		
Caterpillar 3046 Diesel			W/64" Belt O.C.	1P2421	②TR24638
2001 - 1994			Belt - A.C.; Ser. No. 82J3260 & After; W/72		
Belt - Alt.	6L8161	②♣9476HD	1/4" Belt O.C.	2P5619	♣9720HD
Belt - Compr.	2P6820	♣9451HD	D4D (83J)		
D4C III (7SL)			Caterpillar 3304 Diesel		
Caterpillar 3046 Diesel			1977 - 1968		
2000 - 1994			Belt - Fan; Ser. No. 83J1 Thru 83J1455		
Belt - Alt.	6L8161	②♣9476HD	Belt - Fan; Ser. No. 83J1456 Thru 83J1821	2P1385	②TR24619
Belt - Compr.	2P6820	♣9451HD	Belt - Fan; Ser. No. 83J1822 & After	1P2421	②TR24638
			Belt - Alt.	4M6292	②TR24619
			Belt - Gen.; Ser. No. 83J1 Thru 83J1455	7S9857	②TR24638
			Belt - A.C.; W/45 1/4" Belt O.C.	2P6820	♣9451HD
			Belt - A.C.; W/62 1/2" Belt O.C.	2P1385	②TR24619
			Belt - A.C.; W/72 1/4" Belt O.C.	2P5619	②♣9720HD

♣Standard Belt Available.

②Two Required.

Road & Construction Equipment

Belts and Coolant Hose for Road & Construction Equipment

Application	Mfr. Part No.	Our No.	Application	Mfr. Part No.	Our No.
Caterpillar - Continued			Caterpillar - Continued		
D4D LGP (7R)			D4E (31C) - Continued		
Caterpillar 3304 Diesel			Caterpillar 3304 Diesel - Continued		
1977 - 1970			1992 - 1983 - Continued		
Belt - Fan; Ser. No. 7R1 Thru 7R414	2M8502	②TR24638	Hose - Upper		24444
Belt - Fan; Ser. No. 7R415 Thru 7R433	4M6292	②TR24619	Hose - Lower		24440
Belt - Fan; Ser. No. 7R434 Thru 7R507	1P2421	②TR24638			
D4D LGP (61J)			D4E (34C)		
Caterpillar 3304 Diesel			Caterpillar 3304 Diesel		
1978 - 1967			1993 - 1987		
Belt - Fan; W/64" Belt O.C.	7M6100	②TR24638	Belt - Fan	2P1388	②CX60
Belt - Fan; W/67 1/2" Belt O.C.	3L7540	②TR30672	Hose - Upper		24444
Belt - Gen.	7S9858	②TR24638	Hose - Lower		24440
D4D SA (20J)			D4E (70X)		
Caterpillar 3304 Diesel			Caterpillar 3304 Diesel		
1968 - 1966			1987 - 1978		
Belt - W.P.	8M8335	②♣9640HD	Belt - Fan & Alt.	2P1272	②CX60
Belt - Gen.	4M6291	♣9415HD	Belt - A.C.		♣9510HD
Belt - Starter	5B8473	TR24515	Hose - Upper		24440
			Hose - Lower		24440
D4D SA (84J)			D4E (76W)		
Caterpillar 3304 Diesel			Caterpillar 3304 Diesel		
1977 - 1968			1993 - 1981		
Belt - Fan; Ser. No. 84J1 Thru 84J1290	2M8502	②TR24638	Belt - Alt.	2P2696	②TR30624
Belt - Fan; Ser. No. 84J1291 Thru 84J1390	2P1385	②TR24619			
Belt - Fan; Ser. No. 84J1391 & After	1P2421	②TR24638			
Belt - Alt.	4M6292	②TR24619			
Belt - Gen.; Ser. No. 84J1 Thru 84J1200	7S9857	②TR24638			
Belt - A.C.; W/45 1/4" Belt O.C.	2P6820	♣9451HD			
Belt - A.C.; W/47 1/4" Belt O.C.	2P6818	♣9470HD			
Belt - A.C.; W/62 1/2" Belt O.C.	2P1385	②TR24619			
Belt - A.C.; W/64" Belt O.C.	1P2423	②TR24638			
Belt - A.C.; W/72 1/4" Belt O.C.	2P5619	②♣9720HD			
D4E			D4E (77W)		
Caterpillar 3304 Diesel			Caterpillar 3304 Diesel		
1987 - 1977			1993 - 1979		
Hose - Upper		24444	Belt - Alt.	2P2696	②TR30624
Hose - Lower		24440	Hose - Upper		24444
			Hose - Lower		24440
D4E (2CB)			D4G LGP (FDC)		
Caterpillar 3304 Diesel			Caterpillar 3046 Diesel		
1992 - 1988			2003 - 2001		
Belt - Fan	2P1388	②CX60	Belt - Fan	1S1193	②♣9500HD
Hose - Lower		24440	Belt - Compr.	1N3743	♣9440HD
D4E (2DJ)			D4G LGP (TLX)		
Caterpillar 3304 Diesel			Caterpillar 3046 Diesel		
1998 - 1989			2003		
Belt - Alt.	2P2696	②TR30624	Belt - Fan	9L0619	②♣9480HD
Hose - Upper		24444	Belt - Compr.	4N7335	♣9430HD
Hose - Lower		24440			
D4E (28X)			D4G XL (CFN)		
Caterpillar 3304 Diesel			Caterpillar 3046 Diesel		
1984 - 1977			2003 - 2001		
Hose - Upper		24244	Belt - Fan	1S1193	②♣9500HD
			Belt - Compr.	1N3743	♣9440HD
D4E (29X)			D4G XL (HYD)		
Caterpillar 3304 Diesel			Caterpillar 3046 Diesel		
1984 - 1978			2003		
Belt - Fan & Alt.	5M5965	②TR30624	Belt - Fan	9L0619	②♣9480HD
			Belt - Compr.	4N7335	♣9430HD
D4E (31C)			D4H (2AC)		
Caterpillar 3304 Diesel			Caterpillar 3204 Diesel		
1992 - 1983			1995 - 1986		
Belt - Fan	2P1388	②CX60	Belt - Alt.	9L1129	②♣9670HD
			Belt - Compr.	2P6532	♣9680HD
			Hose - Upper - Pipe To Rad.		20357
			D4H (8PB)		
			Caterpillar 3204 Diesel		
			1995 - 1985		
			Belt - Fan & Alt.	5S3244	②♣9670HD

②Two Required.

♣Standard Belt Available.

Belts and Coolant Hose for Road & Construction Equipment

Application	Mfr. Part No.	Our No.	Application	Mfr. Part No.	Our No.
Caterpillar - Continued			Caterpillar - Continued		
D4H (8PB) - Continued			D5B		
Caterpillar 3204 Diesel - Continued			Caterpillar 3306 Diesel		
1995 - 1985 - Continued			1987 - 1977		
Belt - W.P.		▲9490HD	Hose - Upper		24444
Hose - Upper - Eng. To Pipe		24226	Hose - Lower		24440
Hose - Lower - Eng. To Pipe		≡21194	D5B (5LD)		
Hose - Lower - Pipe To Rad.		24436	Caterpillar 3306 Diesel		
D4H LGP (3AC)			1992 - 1988		
Caterpillar 3204 Diesel			Hose - Upper		
1993 - 1986			Hose - Lower		
Belt - Alt.	9L1129	②▲9670HD	24444		
Belt - Compr.	2P6532	▲9680HD	24440		
Hose - Upper - Pipe To Rad.		20357	D5B LGP (46X)		
D4H LGP (9DB)			Caterpillar 3306 Diesel		
Caterpillar 3204 Diesel			1987 - 1977		
1992 - 1986			Belt - A.C.		
Belt - Alt.	4W8729	②▲9670HD	▲9470HD		
Belt - Compr.	2P6532	▲9680HD	D5C (6PJ)		
Hose - Upper - Pipe To Rad.		20357	Caterpillar 3204 Diesel		
D4H LGP III (4NK)			1994 - 1991		
Caterpillar 3304 Diesel			Belt - Fan		
1996 - 1992			5N4692		
Belt - Fan	7M4706	②TR28693	▲9610HD		
D4H LGP III (9GJ); D4H XL III (8PJ)			D5C (6ZL)		
Caterpillar 3304 Diesel			Caterpillar 3046T Diesel		
1996 - 1992			2000 - 1994		
Belt - Fan	7M4721	②CX75	Belt - Alt.	6L8161	②▲9476HD
D4K			Belt - Compr.	2P6820	▲9451HD
Caterpillar C4.4 Diesel			D5C III (5HS)		
2012 - 2008			Caterpillar 3046 Diesel		
Belt - Fan	3160446	▲K080545HD	2003 - 1997		
D4K LGP (RRR); D4K XL (MMM)			Belt - Fan		
Caterpillar C4.4 Diesel			1S1193		
2013 - 2008			②▲9500HD		
Belt - Fan	3160446	▲K080545HD	Belt - Compr.		
D4K2			2P6820		
Caterpillar C4.4 Diesel			▲9451HD		
2012			D5C III (9DL)		
Belt - Fan	3691107	▲K080740HD	Caterpillar 3046T Diesel		
D4K2 LGP (KRR); D4K2 XL (KMM)			2000 - 1994		
Caterpillar C4.4 Diesel			Belt - Alt.		
2013 - 2012			6L8161		
Belt - Fan	3691107	▲K080740HD	②▲9476HD		
D5 (21J)			Belt - Compr.		
Caterpillar D333 Diesel			2P6820		
1968 - 1967			▲9451HD		
Belt - Gen.	5M6096	②TR24709	D5C LGP (3MK)		
D5 (81H)			Caterpillar 3204 Diesel		
Caterpillar D333 Diesel			1994 - 1992		
1969 - 1967			Belt - Fan		
Belt - Gen.	5M6096	②TR24709	5N4692		
D5 (82H); D5 (83H); D5 (84H)			▲9610HD		
Caterpillar D333 Diesel			D5C LGP III (6CS)		
1968 - 1967			Caterpillar 3046T Diesel		
Belt - Gen.	5M6096	②TR24709	2002 - 1997		
D5E XL III (9RG)			Belt - Fan		
Caterpillar 3306 Diesel			1S1193		
1999 - 1993			②▲9500HD		
Hose - Upper			Belt - Compr.		
			2P6820		
			▲9451HD		
			D5C XL (7PS)		
			Caterpillar 3046T Diesel		
			2004 - 1997		
			Belt - Alt.		
			1110575		
			②▲9485HD		
			Belt - Fan		
			1S1193		
			②▲9500HD		
			Belt - Compr.		
			2P6820		
			▲9451HD		
			D5C XL (8ZS)		
			Caterpillar 3046T Diesel		
			2000 - 1997		
			Belt - Alt.		
			6L8161		
			②▲9476HD		
			Belt - Compr.		
			2P6820		
			▲9451HD		
			D5E XL III (9RG)		
			Caterpillar 3306 Diesel		
			1999 - 1993		
			Hose - Upper		
			24444		

≡Cut to Fit.
②Two Required.

▲Standard Belt Available.

Belts and Coolant Hose for Road & Construction Equipment

Application	Mfr. Part No.	Our No.	Application	Mfr. Part No.	Our No.
Caterpillar - Continued			Caterpillar - Continued		
D5E XL III (9RG) - Continued			D5H (9HC)		
Caterpillar 3306 Diesel - Continued			Caterpillar 3304 Diesel		
1999 - 1993 - Continued			1996 - 1986		
Hose - Lower		24440	Belt - Fan	7M4719	ⓉCX68
D5G LGP (FDW)			Belt - Compr.	2W3906	A87
Caterpillar 3046T Diesel			Hose - Upper		24440
2003 - 2001			Hose - Lower		24440
Belt - Fan	5L4995	Ⓣ♣9505HD	D5H LGP II (2SD)		
Belt - Alt.	1S1193	Ⓣ♣9500HD	Caterpillar 3304 Diesel		
Belt - Compr.	1N3743	♣9440HD	1996 - 1986		
D5G LGP (RKG)			Belt - Fan	7M4705	ⓉTR30722
Caterpillar 3046T Diesel			Hose - Upper		24440
2003			Hose - Lower		24440
Belt - W.P.	6L8161	Ⓣ♣9476HD	D5H LGP II (4KD)		
Belt - Compr.	1P9744	♣9415HD	Caterpillar 3304 Diesel		
D5G XL (FDH)			1997 - 1986		
Caterpillar 3046T Diesel			Belt - Fan	7M4719	ⓉCX68
2003 - 2001			Belt - Compr.	2W3906	A87
Belt - W.P.	5L4995	Ⓣ♣9505HD	Hose - Lower		24440
Belt - Alt.	1S1193	Ⓣ♣9500HD	D5K		
Belt - Compr.	1N3743	♣9440HD	Caterpillar C4.4 Diesel		
D5G XL (WGB)			2012 - 2008		
Caterpillar 3046T Diesel			Belt - Fan	3160446	♣K080545HD
2004 - 2003			D5K LGP (JLF)		
Belt - W.P.	6L8161	Ⓣ♣9476HD	Caterpillar C4.4 Diesel		
Belt - Compr.	1P9744	♣9415HD	2013 - 2008		
D5H (1DD)			Belt - Fan	3160446	♣K080545HD
Caterpillar 3304 Diesel			D5K2		
1997 - 1987			Caterpillar C4.4 Diesel		
Belt - Alt.	7M4719	ⓉCX68	2012		
D5H (1YD)			Belt - Fan	2193303	♣K080733HD
Caterpillar 3304 Diesel			D6		
1996 - 1986			Caterpillar 6-Cyl. 525 Diesel		
Belt - Fan	7M4705	ⓉTR30722	1956 - 1942		
Hose - Lower		24440	Hose - Upper; W/Power Shift Trans.; Ser. No. 76A1 Thru		
D5H (3MD)			76A6061		
Caterpillar 3304 Diesel			76A6061		
1996 - 1989			Hose - Upper; W/Power Shift Trans.; Ser. No. 9U10270		
Belt - Alt.	7M4719	ⓉCX68	& After		
Hose - Lower		24440	24236		
D5H (7NC)			Hose - Lower; W/Power Shift Trans.; Ser. No. 76A1 Thru		
Caterpillar 3304 Diesel			76A6061		
1994 - 1987			24448		
Belt - Fan	7M4719	ⓉCX68	D6 (8U); D6 (9U)		
Belt - Compr.	2W3906	A87	Caterpillar D318 Diesel		
Hose - Upper		24440	1959 - 1947		
Hose - Lower		24440	Belt - Fan	1M2045	ⓉTR24607
D5H (8RC)			Belt - Gen.	8F2434	TR24500
Caterpillar 3304 Diesel			Belt - Gov.; Ser. No. 9U1 Thru 9U29764	4B2544	♣9425HD
1996 - 1986			Belt - Starter; Ser. No. 9U1 Thru 9U29764	5B8473	TR24515
Belt - Fan	7M4719	ⓉCX68	D6B (37A); D6B (44A)		
Belt - Compr.	2W3906	A87	Caterpillar D333 Diesel		
Hose - Upper		24440	1967 - 1959		
Hose - Lower		24440	Belt - Fan	5M6096	ⓉTR24709
D5H (8RJ)			Belt - Fan & Gen.	7M5972	ⓉTR24688
Caterpillar 3304 Diesel			Belt - Starter; W/50 5/8" Belt O.C.	8F2434	TR24500
1996 - 1992			Belt - Starter; W/71 1/8" Belt O.C.	5M6096	TR24709
Belt - Alt.	7M4719	ⓉCX68	D6C (10K)		
D5H (8RJ)			Caterpillar D333 Diesel		
Caterpillar 3304 Diesel			1976 - 1967		
1996 - 1992			Belt - Fan & Alt.	7B344	ⓉCX68
Belt - Alt.	7M4719	ⓉCX68	Belt - A.C.	2P4191	♣9525HD

♣Standard Belt Available.

ⓉTwo Required.

Belts and Coolant Hose for Road & Construction Equipment

Application	Mfr. Part No.	Our No.	Application	Mfr. Part No.	Our No.
Caterpillar - Continued			Caterpillar - Continued		
D6C (71A)			D6H (4RC)		
Caterpillar D333 Diesel			Caterpillar 3306 Diesel		
1967 - 1963			1995 - 1986		
Belt - W.P.	7M169	TR24530	Hose - Upper		②24440
Belt - Alt.	7M169	TR24530	Hose - Lower		②24440
Belt - Gen.; W/49 3/8" Belt O.C.	3L9717	TR24489	D6K		
Belt - Gen.; W/53 5/8" Belt O.C.	7M169	TR24530	Caterpillar C6.6 Diesel		
Belt - Clutch	8M8335	②▲9640HD	2012 - 2007		
D6C (73A)			Belt - Fan		
Caterpillar D333 Diesel			2915837		
1968 - 1964			▲K080630HD		
Belt - W.P.	7M169	TR24530	D6N		
Belt - Alt.	7M169	TR24530	Caterpillar 3126 Diesel		
Belt - Gen.; W/49 3/8" Belt O.C.	3L9717	TR24489	2006 - 2004		
Belt - Gen.; W/53 5/8" Belt O.C.	7M169	TR24530	Belt - Fan		
Belt - Clutch	8M8335	②▲9640HD	2534531		
D6C (74A); D6C (76A)			▲K080991HD		
Caterpillar D333 Diesel			Caterpillar C6.6 Diesel		
1967 - 1963			2012 - 2007		
Belt - W.P.	7M169	TR24530	Belt - Fan		
Belt - Alt.	7M169	TR24530	2534531		
Belt - Gen.; W/49 3/8" Belt O.C.	3L9717	TR24489	▲K080991HD		
Belt - Gen.; W/53 5/8" Belt O.C.	7M169	TR24530	D6T		
Belt - Clutch	8M8335	②▲9640HD	Caterpillar C9 Diesel		
D6C (99J)			2010 - 2007		
Caterpillar D333 Diesel			Belt - Fan		
1977 - 1967			4P8087		
Belt - Fan; Ser. No. 99J830 Thru 99J1549 ..	5S9506	②TR24688	③TR22770		
Belt - Alt.	5S9506	②TR24688	Belt - Alt.		
Belt - A.C.	2P4191	▲9525HD	2414981		
D6C LGP (69U)			Belt - Compr.		
Caterpillar 3306 Diesel			2160349		
1977 - 1972			▲9640HD		
Belt - A.C.	4N6013	▲9540HD	D7		
D6D (3X)			Caterpillar D8800 Diesel		
Caterpillar 3306 Diesel			1955 - 1947		
1988 - 1977			Hose - Upper; Ser. No. 17A1 & After		
Belt - Fan & Alt.	4M5413	TR30710	24444		
D6D (4X)			Hose - Upper; W/Power Shift Trans.; Ser. No. 48A6393		
Caterpillar 3306 Diesel			& After		
1987 - 1977			24440		
Belt - Fan & Alt.	4M5413	TR30710	Hose - Lower		
Hose - Upper		24444	24448		
Hose - Lower		24440	D7C (17A); D7D (17A)		
D6D SA (5X)			Caterpillar D339 Diesel		
Caterpillar 3306 Diesel			1962 - 1954		
1990 - 1976			Belt - Fan; Ser. No. 17A11981 Thru		
Belt - Fan & Alt.		②TR28706	17A19442		
Belt - A.C.		▲9540HD	2M8183		
Hose - Upper		24444	TR30672		
Hose - Lower		24440	Belt - Gen.		
D6H (3ZF)			8H9832		
Caterpillar 3306 Diesel			②TR24638		
1990 - 1987			D7E		
Belt - Fan & Alt.	7M4710	②CX81	Caterpillar C9 Diesel		
Belt - Compr.	1P9744	▲9415HD	2010 - 2009		
			Belt - Fan		
			4P8087		
			③TR22770		
			Belt - Alt.		
			2414981		
			▲K080530HD		
			Belt - Compr.		
			2160349		
			▲9640HD		

▲Standard Belt Available.
③Three Required.

②Two Required.

Belts and Coolant Hose for Road & Construction Equipment

Application	Mfr. Part No.	Our No.	Application	Mfr. Part No.	Our No.	
Caterpillar - Continued			Caterpillar - Continued			
D7E (47A) - Continued			D8 (14A)			
Caterpillar D339 Diesel - Continued			Caterpillar D13000 Diesel			
1969 - 1961 - Continued			1958 - 1954			
Belt - Gen.; W/52 1/4" Belt O.C.	5M8135	♣9520HD	Belt - Fan; W/72 5/8" Belt O.C.		②CX68	
Belt - Gen.; W/53 1/4" Belt O.C.	3S6272	♣9530HD	Belt - Fan; W/77 1/8" Belt O.C.	7H9806	②TR30770	
Belt - Gen.; W/58 1/4" Belt O.C.	2S5218	♣9580HD	D8E (14A)			
D7E (48A)			Caterpillar D342 Diesel			
Caterpillar D339 Diesel			1958 - 1955			
1970 - 1961			Belt - Fan; W/72 5/8" Belt O.C.			②CX68
Belt - Fan; W/81 1/8" Belt O.C.	3L6052	②TR30808	Belt - Fan; W/77 1/8" Belt O.C.	7H9806	②TR30770	
Belt - Fan; W/85 5/8" Belt O.C.	5H7371	②CX81	D8G (15A)			
Belt - Alt.; W/59 1/4" Belt O.C.	2S9778	②♣9590HD	Caterpillar D342 Diesel			
Belt - Alt.; W/60 1/4" Belt O.C.	2S9506	♣9600HD	1959 - 1955			
Belt - Gen.; Ser. No. 48A6393 Thru			Belt - Fan; W/72 5/8" Belt O.C.			②CX68
48A9314	3S6272	♣9530HD	Belt - Fan; W/77 1/8" Belt O.C.	7H9806	②TR30770	
Belt - Gen.; Ser. No. 48A9315 & After	2S5218	♣9580HD	D8H (22A)			
D7E (93N)			Caterpillar D342 Diesel			
Caterpillar D339 Diesel			1969 - 1959			
1974 - 1969			Belt - Fan; Ser. No. 22A1 Thru 22A1145			2M7863
Belt - Fan	3L6052	②TR30808	Belt - Fan; Ser. No. 22A1146 & After	3L6052	③TR30808	
Belt - A.C.	1P3085	♣9490HD	Belt - Alt.; W/59 1/4" Belt O.C.	2S9778	②♣9590HD	
D7F			Belt - Alt.; W/62 1/4" Belt O.C.	8M8336	②♣9620HD	
Caterpillar 3306 Diesel			Belt - Alt.; W/64 1/4" Belt O.C.	8M8335	②♣9640HD	
1974 - 1969			Belt - Gen.; W/60 1/4" Belt O.C.	2S9506	♣9600HD	
Hose - Upper		24444	Belt - Gen.; W/64 1/4" Belt O.C.	8M8335	♣9640HD	
Hose - Lower		24448	D8H (35A)			
D7F (93N); D7F (94N)			Caterpillar D342 Diesel			
Caterpillar 3306 Diesel			1961 - 1958			
1975 - 1969			Belt - Fan			2M8255
Belt - Fan	3L6052	②TR30808	Belt - Gen.	8H9832	③TR30754	
Belt - A.C.	1P3085	♣9490HD	D8H (36A)			
D7G			Caterpillar D342 Diesel			
Caterpillar 3306 Diesel			1974 - 1958			
1998 - 1974			Belt - Fan; Ser. No. 36A1 Thru 36A4468			2M7863
Hose - Upper		24444	Belt - Fan; Ser. No. 36A4649 & After	3L6052	③TR30808	
Hose - Lower - Eng. To Pipe		24440	D8H (46A)			
Hose - Lower - Pipe To Rad.		24440	Caterpillar D342 Diesel			
D7G (92V)			1974 - 1959			
Caterpillar 3306 Diesel			Belt - Alt.; Ser. No. 46A1 Thru 46A28136;			
1988 - 1975			W/59 1/4" Belt O.C.			2S9778
Belt - Fan & Alt.	5H7371	②CX81	Belt - Alt.; Ser. No. 46A1 Thru 46A28136;		②♣9590HD	
D7H (79Z)			W/62 1/4" Belt O.C.			8M8336
Caterpillar 3306 Diesel			Belt - Alt.; Ser. No. 46A1 Thru 46A28136;			②♣9620HD
1989 - 1986			W/64 1/4" Belt O.C.			8M8335
Belt - Fan & Alt.		CX85	Belt - Alt.; Ser. No. 46A28137 Thru		♣9640HD	
Belt - A.C.		♣9430HD	46A32842	1P2421	TR24638	
Hose - Upper		②24440	Belt - Alt.; Ser. No. 46A32843 & After	3P25	TR24619	
Hose - Lower		②24440	Belt - Gen.; Ser. No. 46A1 Thru 46A8081 ...	3S3961	♣9570HD	
D8			Belt - Gen.; Ser. No. 46A8082 Thru			
Caterpillar D13000 Diesel			46A10725			②♣9550HD
1955 - 1945			Belt - Gen.; Ser. No. 46A10726 Thru			
Hose - Upper; W/Direct Drive Trans.; Ser. No. 36A1 Thru			46A12671			2S5218
36A3215		24444	Belt - Gen.; Ser. No. 46A12672 & After	8M8335	♣9580HD	
Hose - Upper; W/Power Shift Trans.; Ser. No. 46A1 Thru			Belt - A.C.; Ser. No. 46A12085 Thru 46A28136		♣9640HD	
46A10724		24444	Belt - A.C.; Ser. No. 46A12137 & After	1P4334	♣9610HD	
Hose - Upper; W/Power Shift Trans.; Ser. No. 46A10725			D8H (52A)			
Thru 46A24432		24440	Caterpillar D342 Diesel			
Hose - Lower; W/Power Shift Trans.; Ser. No. 46A10725			1961 - 1959			
Thru 46A24432		24444	Belt - Fan; W/Blower			2M8255
Hose - Lower; W/O Power Shift Trans.; Ser. No.						③TR30754
46A10725 Thru 46A24432		24448				

♣Standard Belt Available.
③Three Required.

②Two Required.

Belts and Coolant Hose for Road & Construction Equipment

Application	Mfr. Part No.	Our No.	Application	Mfr. Part No.	Our No.
Caterpillar - Continued			Caterpillar - Continued		
D8H (68A)			D9G (66A) - Continued		
Caterpillar D342 Diesel			Caterpillar D353TA Diesel - Continued		
1974 - 1960			1974 - 1961 - Continued		
Belt - Fan; Ser. No. 68A1 Thru 68A759	2M8255	③TR30754	Belt - Gen.; Ser. No. 66A8509 Thru	66A9418	9S9010 TR24457
Belt - Fan; Ser. No. 68A1003 Thru	68A4586	③TR30808	Belt - Air Brake Compr.	8M8335	②▲9640HD
Belt - Alt.; W/62 1/4" Belt O.C.	8M8336	②▲9620HD	Hose - Upper		24444
Belt - Alt.; W/64 1/4" Belt O.C.	8M8335	②▲9640HD	Hose - Lower - Eng. To Pipe		24448
Belt - Gen.; Ser. No. 68A1003 Thru	68A1187	▲9580HD	Hose - By Pass		24240
Belt - Gen.; Ser. No. 68A1188 Thru	68A3846	▲9640HD			
	8M8335		D9G (90J)		
D8K (77V)			Caterpillar D353 Diesel		
Caterpillar D342 Diesel			1975 - 1969		
1984 - 1974			Belt - Fan; Ser. No. 90J106 & After		
Belt - Fan; W/74 1/2" Belt O.C.	6N4548	③BX71	Belt - Alt.; Ser. No. 90J1 Thru 90J105	1S5138	TR24465
Belt - Fan; W/81" Belt O.C.		③BX78	Belt - Alt.; Ser. No. 90J106 & After	5M5345	TR24476
Belt - Alt.		TR22657	Belt - Gen.; Ser. No. 90J86 Thru 90J99	9S9010	TR24457
Hose - Upper		24444	D9H (90V)		
Hose - Lower		24444	Caterpillar D353 Diesel		
D8L			1981 - 1974		
Caterpillar 3408 Diesel			Belt - Fan & W.P.; W/85 5/8" Belt O.C.		
1992 - 1982			Belt - Alt.	5M5345	③CX81 TR24476
Belt - Fan	6N6650	③BX71	Belt - Fan To A.C.	2P6532	▲9680HD
Belt - Alt.	3S9652	②▲9680HD	Hose - Upper - Eng. To Pipe		24444
Hose - Upper		24438	Hose - Upper - Pipe To Rad.		24456
Hose - Lower		24448	Hose - By Pass		24440
D8L (53Y)			D9L (14Y)		
Caterpillar 3408 Diesel			Caterpillar 3412 Diesel		
1987 - 1981			1980		
Belt - Fan		B79	Belt - Fan	4N8277	③BX70
Belt - Alt.		TR22711	Hose - Upper		④24440
Hose - Upper		②24440	Hose - Lower		②24464
Hose - Lower		②24464	Caterpillar 3416 Diesel		
D8N (9TC)			1987 - 1981		
Caterpillar 3406DIT Diesel			Belt - Fan		
1992 - 1986			Belt - Upper	4N8277	③BX70
Belt - Fan		BX79	Hose - Upper		④24440
Hose - Upper		②24440	Hose - Lower		②24464
Hose - Lower		②24464	D10T		
D8T			Caterpillar C27 Diesel		
Caterpillar C15 Diesel			2012 - 2004		
2012 - 2004			Belt - Compr.		
Belt - Fan	3505391	▲K081035HD	Belt - Upper	4N2745	▲9600HD
Hose - Upper - Pipe To Rad.		24440	Hose - Lower		24456
Hose - Lower		24448			24456
D9			D11N		
Caterpillar 6-Cyl. 1473 Diesel			Caterpillar C27 Diesel		
1959 - 1955			2012		
Hose - Lower; W/Power Shift Trans.; Ser. No. 66A1 Thru	66A8408	24448	Belt - Alt.	1003725	▲K080415HD
Hose - Lower; W/Power Shift Trans.; Ser. No. 66A8409	66A9417	24456	Belt - Compr.	1P9744	▲9415HD
Thru 66A9417			Hose - Lower		24480
D9G (66A)			D11T		
Caterpillar D353TA Diesel			Caterpillar C32 Diesel		
1974 - 1961			2012 - 2008		
Belt - Fan & W.P.; Ser. No. 66A1905 Thru	66A3143; W/81 1/8" Belt O.C.	③TR30808	Belt - Fan	2661464	▲K080680HD
Belt - Alt.; W/47" Belt O.C.	1S5138	TR24465	E70 (3BG)		
Belt - Alt.; W/48 1/8" Belt O.C.	5M5345	TR24476	Mitsubishi 4D31 Diesel		
Belt - Gen.; Ser. No. 66A1209 Thru	66A3846	▲9640HD	Belt - Fan	0948990	BX45
	8M8335		Belt - A.C.	0856581	▲9590HD
D9G (66A)			E70B (5TG); E70B (6AK)		
Caterpillar D353TA Diesel			Mitsubishi 4D32 Diesel		
1974 - 1961			Belt - Fan; Ser. No. 767796 & After		
Belt - Fan & W.P.; Ser. No. 66A1905 Thru	66A3143; W/81 1/8" Belt O.C.	③TR30808		0948990	BX45
Belt - Alt.; W/47" Belt O.C.	1S5138	TR24465			
Belt - Alt.; W/48 1/8" Belt O.C.	5M5345	TR24476			
Belt - Gen.; Ser. No. 66A1209 Thru	66A3846	▲9640HD			
	8M8335				

③Three Required.
②Two Required.

▲Standard Belt Available.
④Four Required.

Road & Construction Equipment

Belts and Coolant Hose for Road & Construction Equipment

Application	Mfr. Part No.	Our No.	Application	Mfr. Part No.	Our No.
Caterpillar - Continued			Caterpillar - Continued		
E110 (3FG)			EL180 (4EF) - Continued		
Mitsubishi 4D31T Diesel			Caterpillar 3204 Diesel - Continued		
Belt - A.C.	0856581	▲9590HD	Belt - Compr.	1P6868	▲9610HD
E110B (4FJ); E110B (5GK); E110B (8MF)			EL200B (5EG)		
Caterpillar 3114T Diesel			Mitsubishi 6D14T Diesel		
Belt - Fan; W/Std. Fan	0618384	▲9335HD	Belt - Alt.	1R7171	②BX44
Belt - Fan; W/High Ambient Temp. Fan	9L1106	▲9600HD	Belt - A.C.	0861361	TR22416
Belt - Alt.	9L1557	▲9550HD	EL200B (7DF)		
E110B (9HF)			Caterpillar 3116T Diesel		
Caterpillar 3114T Diesel			Belt - Fan	6L4100	②▲9610HD
Belt - Alt.	1R7171	②BX44	Belt - W.P.	0618384	▲9335HD
Belt - A.C.	0861361	TR22416	Belt - A.C.	1P4334	▲9495HD
E120B (4XK); E120B (6JF)			EL240 (4JF)		
Caterpillar 3114T Diesel			Caterpillar 3304 Diesel		
Belt - Fan; W/Std. Fan	0618384	▲9335HD	Belt - Alt.	4N6529	6968BR
Belt - Fan; W/High Ambient Temp. Fan	9L1106	▲9600HD	Belt - A.C.	7C2163	▲9309HD
Belt - Alt.	9L1557	▲9550HD	EL240B (5WG)		
Belt - A.C.	1N3743	▲9440HD	Caterpillar 3116T Diesel		
E120B (7NF)			Belt - Fan & Alt.	9L1106	②▲9600HD
Mitsubishi S4K-T Diesel			Belt - W.P.	618384	▲9335HD
Belt - Alt.	1R7171	②BX44	Belt - A.C.	0857361	▲9505HD
Belt - A.C.	0861361	TR22416	EL240C (9PK)		
E180 (1RF)			Caterpillar 3116T Diesel		
Caterpillar 3204 Diesel			Belt - Fan	9L1106	②▲9600HD
Belt - Alt.	8M8341	②▲9620HD	Belt - W.P.	0618384	▲9335HD
Belt - Compr.	1P6868	▲9610HD	Belt - A.C.	0857361	▲9505HD
E200B (4SG)			EL300 (4NF)		
Mitsubishi S6K-T Diesel			Caterpillar 3306 Diesel		
Belt - Alt.	1R7171	②BX44	Belt - Alt.	1S1127	BX55
Belt - A.C.	0861361	TR22416	Belt - Compr.	7C2163	▲9309HD
E200B (6KF)			EL300B (3FJ)		
Caterpillar 3116 Diesel			Caterpillar 3306 Diesel		
Belt - Fan	6L4100	②▲9610HD	Belt - Alt.	9Y8864	②TR30543
Belt - W.P.	0618384	▲9335HD	Belt - A.C.	7C2163	▲9309HD
Belt - A.C.	1P4334	▲9495HD	IT12B (1KF)		
E240 (1FG)			Caterpillar 3114 Diesel		
Caterpillar 3116T Diesel			Belt - Fan & Alt.	8M8336	②▲9620HD
Belt - Alt.	4N6529	6968BR	Belt - W.P.		▲9350HD
Belt - A.C.	7C2163	▲9309HD	Hose - Upper		26511
E240B (8SF); E240C (2RL)			Hose - Lower		26511
Caterpillar 3116T Diesel			IT14B (3NJ)		
Belt - W.P.	0618384	▲9335HD	Caterpillar 3114 Diesel		
Belt - A.C.	0857361	▲9505HD	Belt - Fan & Alt.	8M8336	②▲9620HD
E300 (2CF)			Belt - W.P.		▲9350HD
Caterpillar 3306T Diesel			Hose - Upper		26511
Belt - Alt.	1S1127	BX55	Hose - Lower		26512
Belt - Compr.	7C2163	▲9309HD	IT28B (1HF)		
E300B (1WJ)			Caterpillar 3204 Diesel		
Caterpillar 3306T Diesel			Belt - Fan & Alt.		②▲9690HD
Belt - Alt.	9Y8864	②TR30543	Belt - W.P.	6N3113	▲9485HD
Belt - A.C.	7C2163	▲9309HD	Hose - Upper		②24428
EL180 (4EF)			Hose - Lower		②24436
Caterpillar 3204 Diesel			M312 (6TL)		
Belt - Alt.	8M8341	②▲9620HD	Caterpillar 3054 Diesel		
			Belt - Fan & Alt.	1069331	②▲9525HD

▲Standard Belt Available.

②Two Required.

Belts and Coolant Hose for Road & Construction Equipment

Application	Mfr. Part No.	Our No.	Application	Mfr. Part No.	Our No.
Caterpillar - Continued			Caterpillar - Continued		
M312 (6TL) - Continued			M322C (BDK); M322C (BDY); M322C (H2E); M322C (H2G)		
Caterpillar 3054 Diesel - Continued			Caterpillar 3056 Diesel		
Belt - A.C.	3K3408	▲9490HD	Belt - Fan	2S2756	②▲9555HD
M313C (BDR); M313C (H2A)			Belt - Compr.	1457211	A48
Caterpillar 3054E Diesel			M322D; M322D (D2W); M322D (W2S); M322D MH (D3X); M322D MH (W2T)		
Belt - Fan	4N8771	②▲9530HD	Caterpillar C6.6 Diesel		
Belt - A.C.	1457211	A48	Belt - Fan	2852040	K080558
M313D; M313D (J3A); M313D (W3H)			Belt - Compr.	2754909	A49
Caterpillar C4.4 Diesel			M325B (BGN)		
Belt - Fan	2852040	K080558	Caterpillar 3056 Diesel		
Belt - Compr.	2754909	A49	Belt - W.P.	0366775	▲9341HD
M315 (7ML)			Belt - Fan & Alt.	9L6642	②TR22588
Caterpillar 3054 Diesel			Belt - Compr.	5M8135	▲9510HD
Belt - Fan & Alt.	1069331	②▲9525HD	M325C MH (PAN); M325C MH (XJA)		
Belt - A.C.	3K3408	▲9490HD	Caterpillar 3126B Diesel		
M315C (BDM); M315C (H2B)			Belt - Fan	1834494	▲K080859HD
Caterpillar 3054E Diesel			Tensioner Assy.	1900643	38620
Belt - Fan	4N8771	②▲9530HD	M325D L MH (KAY); M325D L MH (KGG); M325D MH (EDF)		
Belt - A.C.	1457211	A48	Caterpillar C7 Diesel		
M315D; M315D (H9A); M315D (J5B); M315D (W5M)			Belt - Fan	3748478	▲K080839HD
Caterpillar C4.4 Diesel			M330D (KRE); M330D (MBR)		
Belt - Fan	2852040	K080558	Caterpillar C9 Diesel		
Belt - Compr.	2754909	A49	Belt - Fan	1834494	▲K080859HD
M316C (BDX); M316C (H2C)			Tensioner Assy.	1900643	38620
Caterpillar 3056 Diesel			W330B (AME)		
Belt - Fan	2S2756	②▲9555HD	Caterpillar 3306T Diesel		
Belt - Compr.	1457211	A48	Belt - Alt.	1S1127	②BX55
M316D; M316D (D6W); M316D (W6A)			Belt - Compr.	0303289	▲9530HD
Caterpillar C6.6 Diesel			W345B II (ANJ); W345B II (CDY)		
Belt - Fan	2852040	K080558	Caterpillar 3176C Diesel		
Belt - Compr.	2754909	A49	Belt - Fan	2395944	K081044HD
M318 (6ES); M318 (8AL); M318 (8SS)			Tensioner Assy.	1900643	38620
Caterpillar 3116 Diesel			W345C MH (R5K)		
Belt - W.P.	0366775	▲9341HD	Caterpillar C13 Diesel		
Belt - Alt.	9L1127	②▲9570HD	Belt - Fan	2213775	▲K080876HD
M318C (BCZ); M318C (H2D); M318C (H2F); M318C MH (BEB)			Cedar Rapids		
Caterpillar 3056 Diesel			BSF2		
Belt - Fan	2S2756	②▲9555HD	Continental F244		
Belt - Compr.	1457211	A48	Belt - Fan	F600K267	TR24465
M318D; M318D (D8W); M318D (W8P); M318D MH (D9X); M318D MH (W8R)			Belt - Gen.; W/12V. Gen.; W/49 1/4" Belt O.C.		▲9490HD
Caterpillar C6.6 Diesel			Belt - Gen.; W/12V. Gen.; W/50 1/4" Belt O.C.		▲9500HD
Belt - Fan	2852040	K080558	Belt - Gen.; W/115V. Gen.		B71
Belt - Compr.	2754909	A49	Continental F245		
M320 (6WL); M320 (9PS)			Belt - Fan	G193K201	▲9463HD
Caterpillar 3116 Diesel			Belt - Gen.; W/12V. Gen.; W/49 1/4" Belt O.C.		▲9490HD
Belt - Fan	2S2756	②▲9555HD	Belt - Gen.; W/12V. Gen.; W/50 1/4" Belt O.C.		▲9500HD
Belt - Alt.	9L1128	②▲9570HD	Belt - Gen.; W/12V. Gen.; W/58" Belt O.C.		TR22578
Belt - W.P.	0366775	▲9341HD	Belt - Gen.; W/115V., 120V. Gen.		B71
			Hose - Upper		25526
			Hose - Lower; W/1800 R.P.M.		≈<20623
			Continental FA244		
			Belt - Fan	F600K267	TR24465

▲Standard Belt Available.
≈<Cut to Fit.

②Two Required.

Belts and Coolant Hose for Road & Construction Equipment

Application	Mfr. Part No.	Our No.	Application	Mfr. Part No.	Our No.
Cedar Rapids - Continued			Cedar Rapids - Continued		
BSF2 - Continued			CR331		
Continental FA244 - Continued			Cummins 4-Cyl. 3.9 L Diesel		
Belt - Gen.; W/12V. Gen.; W/49 1/4" Belt O.C.		▲9490HD	Belt - Fan & Alt.	3911560	▲K080550HD
Belt - Gen.; W/12V. Gen.; W/50 1/4" Belt O.C.		▲9500HD	CR461		
Belt - Gen.; W/115V. Gen.		B71	Cummins 4-Cyl. 3.9 L Diesel		
Continental HD277 Diesel			Hose - Upper		26611
Belt - Gen.; W/120V. Gen.		B78	Champion		
Detroit Diesel 3-53 Diesel			560		
Belt - Fan	5131395	②▲9412HD	Detroit Diesel 3-71 Diesel		
Belt - Alt.		②3VX400	Belt - Fan & Alt.		②B60
Belt - Gen.; W/12V. Gen.		3VX400	Belt - Hyd. Pump; W/36 3/4" Belt O.C.		▲9365HD
Belt - Gen.; W/115V., 120V. Gen.; W/1800 R.P.M.		B85	Belt - Hyd. Pump; W/42" Belt O.C.		TR22416
Belt - Gen.; W/115V., 120V. Gen.; W/2000 R.P.M.		B68	600		
Hose - Upper		≈<20957	Detroit Diesel 6-71C Diesel		
Hose - Lower		24232	Belt - Fan	172856	②TR24457
Ford 4-Cyl. 256; Ford 4-Cyl. 256 Diesel			Belt - Alt.		TR22392
Belt - Fan		3VX530	Belt - Hyd. Pump; W/40 3/8" Belt O.C.		TR22397
Belt - Alt./Gen.; W/12V. Gen.		3VX530	Belt - Hyd. Pump; W/43" Belt O.C.		TR22425
Belt - Gen.; W/115V., 120V. Gen.		B68	Belt - Hyd. Pump; W/50 1/4" Belt O.C.		▲9500HD
Hose - Upper		≈<20065	Hose - Upper		26511
		25526	Hose - Lower		≈<20401
		26502			or 26523
Ford 6-Cyl. 240			720A		
Belt - Fan	C7JZ 8620 A	▲9395HD	Cummins 6-Cyl. 8.3 L Diesel		
Belt - Alt.		7417	Belt - Fan, Alt. & Idler; W/70 5/8" Belt O.C. .	3911582	▲K080700HD
Belt - Gen.; W/12V. Gen.	C4AZ 8620 A	7417	Belt - Fan, Alt. & Idler; W/72 5/8" Belt O.C. .	3911585	▲K080720HD
Belt - Gen.; W/115V., 120V. Gen.; W/1800 R.P.M.		B78	Belt - A.C.		▲9370HD
Belt - Gen.; W/115V., 120V. Gen.; W/2000 R.P.M.		B68	Hose - Lower - Eng. To Pipe		21901
BSF2H			Hose - Lower - Pipe To Cooler		24438
Detroit Diesel 3-71 Diesel			Hose - Lower - Cooler To Rad.		≈<20731
Belt - Alt.		3VX530	730A		
Belt - Gen.; W/12V. Gen.		2420	Cummins 6-Cyl. 8.3 L Diesel		
Belt - Gen.; W/120V. Gen.; W/43" Belt O.C.		2430	Hose - Lower - Eng. To Pipe		21901
Belt - Gen.; W/120V. Gen.; W/53" Belt O.C.		3VX530	Hose - Lower - Pipe To Cooler		24438
Hose - Upper		26504	Hose - Lower - Cooler To Rad.		≈<20731
Hose - Lower		26510	C80A		
BSF3R			Cummins 4-Cyl. 3.9 L Diesel		
Caterpillar D330 Diesel			Belt - Fan & Alt.		▲K080550HD
Belt - Alt./Gen.; W/12V. Gen.		2460	Chicago Pneumatic		
Belt - Gen.; W/120V. Gen.		2590	85RGH1		
Detroit Diesel 4-53 Diesel			Continental F163		
Belt - Alt./Gen.; W/12V. Gen.		3VX400	Belt - Fan & Alt.		▲9480HD
Belt - Gen.; W/120V. Gen.		3VX375	Hose - Upper		≈<20088
IH UC301					25474
Belt - Alt./Gen.; W/12V. Gen.	312515R1	▲9525HD	Hose - Lower		25478
Belt - Gen.; W/120V. Gen.; W/53" Belt O.C.		3VX530	Hose - By Pass		≈<20605
Belt - Gen.; W/120V. Gen.; W/59" Belt O.C.		2590	125RG2		
IH UD282 Diesel			Hercules GO198		
Belt - Alt./Gen.; W/12V. Gen.	312515R1	▲9520HD	Belt - Fan	1PS1090	▲9470HD
Belt - Gen.; W/120V. Gen.; W/53" Belt O.C.		3VX530	Hercules JX4D		
Belt - Gen.; W/120V. Gen.; W/59" Belt O.C.		2590	Belt - Fan	18PS398	TR22508
BSF4			Hercules JX4D3		
Detroit Diesel 4-71 Diesel			Belt - Fan	1PS863	TR24489
Belt - Alt.		3VX530			
Belt - Gen.; W/12V. Gen.		2420			
Belt - Gen.; W/120V. Gen.; W/43" Belt O.C.		2430			
Belt - Gen.; W/120V. Gen.; W/53" Belt O.C.		3VX530			
Hose - Upper		26504			
Hose - Lower		26510			

▲Standard Belt Available.
≈<Cut to Fit.

②Two Required.

Belts and Coolant Hose for Road & Construction Equipment

Application	Mfr. Part No.	Our No.	Application	Mfr. Part No.	Our No.
Chicago Pneumatic - Continued			Clark-Lima - Continued		
125R02			500TC - Continued		
Hercules DD198			Cummins NHF240 Diesel - Continued		
Belt - Fan		7550	Belt - Alt. - Lower Structure; W/38" Belt O.C.	178655	TR22373
175RG1			Belt - Hyd. Pump - Lower Structure	178544	TR28463
Ford 6-Cyl. 300			Hose - Upper - Lower Structure		26522
Belt - Fan & Alt.		7405	Hose - Lower - Lower Structure		26526
Belt - Gov.		7260	700TC		
Hose - Upper		25527	Cummins H743 Diesel		
Hose - Lower - Eng. To Pipe		24228	Belt - Fan - Upper Structure	172856	②TR24457
Hose - Lower - Pipe To Rad.		24228	Belt - Alt. - Upper Structure	178436	TR22358
210RG2			Belt - Hyd. Pump - Upper Structure	178554	▲9375HD
Hercules GO339			Hose - Upper - Upper Structure		24236
Belt - Fan	1PS1090	▲9470HD	Hose - Lower - Upper Structure		24236
Hercules JXLD			Cummins NHF240 Diesel		
Belt - Fan	19PS398	TR28545	Belt - Fan - Lower Structure	172856	②TR24457
250RG2			Belt - Alt. - Lower Structure; W/36 1/2" Belt O.C.		TR22358
Hercules GO339A			Belt - Alt. - Lower Structure; W/38" Belt O.C.	178655	TR22373
Belt - Fan	6PS398	②TR22485	Belt - Hyd. Pump - Lower Structure	178544	TR28463
250R02			Hose - Upper - Lower Structure		24238
Detroit Diesel 4-51 Diesel; Detroit Diesel 4-53 Diesel			Hose - Lower - Lower Structure		26528
Belt - Fan	1PS398	②▲9480HD	703SC		
365R02			Cummins NHC250 Diesel		
Detroit Diesel 4-71 Diesel			Belt - Fan		②TR22455
Belt - Fan	14PS398	②TR22578	Belt - Fan To Alt.		TR22448
Belt - Gen.	5133515	▲9370HD	Hose - Upper		26526
600R02			Hose - Lower		③24436
Detroit Diesel 6-71 Diesel			720		
Belt - Fan	14PS398	②TR22578	Detroit Diesel 6V-53N Diesel		
Belt - Gen.	5133515	▲9370HD	Belt - Fan & Air Brake Compr. - Upper Structure	5135942	②▲9550HD
Hose - Upper		24232	Belt - Alt. - Upper Structure	5133177	②7370
Hose - Lower		24232	Belt - Hyd. Pump - Upper Structure	5133177	②7370
900R02			Hose - Upper - Upper Structure		26612
Cummins NRTO Diesel; Detroit Diesel 6-110 Diesel			Hose - Lower - Upper Structure		26508
Belt - Fan; W/71 1/8" Belt O.C.		②TR28706	Detroit Diesel 8V-71 Diesel		
Belt - Fan; W/73 3/8" Belt O.C.		②TR28733	Belt - Fan & W.P. - Lower Structure		②TR22508
CPS130			Belt - Fan To Alt. - Lower Structure		7530
Isuzu 3KR1 Diesel			Hose - Upper - Lower Structure		26524
Belt - Fan & Alt.		7405	Hose - Lower - Lower Structure		24936
Hose - Upper		25252	Clark-Michigan-VME		
CPS270			12B		
Isuzu 4BD1 Diesel			Waukesha 180GKB		
Belt - Fan & Alt.		TR22474	Belt - Fan & Gen.; W/41 3/4" Belt O.C.	0155103	②▲9415HD
Clark-Lima			Belt - Fan & Gen.; W/42 1/4" Belt O.C.	730226	②▲9420HD
500TC			Belt - Fan & Gen.; W/42 3/4" Belt O.C.	0190303	▲9430HD
Cummins H743 Diesel			Belt - Fan & Gen.; W/43 1/4" Belt O.C.		②▲9430HD
Belt - Fan - Upper Structure	172856	②TR24457	Belt - Fan	212588	③TR24379
Belt - Alt. - Upper Structure	178436	TR22358	Belt - W.P.	178519	TR22299
Belt - Hyd. Pump - Upper Structure	178554	▲9375HD	Belt - Alt.	178571	TR22434
Hose - Upper - Upper Structure		24236	Hose - Upper		≅20267
Hose - Lower - Upper Structure		24236			or 25472
Cummins NHF240 Diesel			Hose - Lower; Ser. No. 1386 Thru 1816		≅21660
Belt - Fan - Lower Structure	172856	②TR24457			or 25474
Belt - Alt. - Lower Structure; W/36 1/2" Belt O.C.		TR22358	Hose - Lower; Ser. No. 7423 Thru 7617		≅21660
					or 25474
			Hose - Lower; Ser. No. 1AA681 & After		≅21660
					or 25474

▲Standard Belt Available.
③Three Required.

②Two Required.
≅Cut to Fit.

Belts and Coolant Hose for Road & Construction Equipment

Application	Mfr. Part No.	Our No.	Application	Mfr. Part No.	Our No.
Clark-Michigan-VME - Continued			Clark-Michigan-VME - Continued		
12BR Control			45BP		
Waukesha 180DLC Diesel			Perkins 6-Cyl. 354 Diesel		
Belt - Fan & Gen.; W/41 3/4" Belt O.C.	0155103	②♣9415HD	Hose - Upper		②24432
Belt - Fan & Gen.; W/42 1/4" Belt O.C.	730226	②♣9420HD	Hose - Lower		②♣<20611
Belt - Fan & Gen.; W/42 3/4" Belt O.C.	0190303	♣9430HD	45C		
Belt - Fan & Gen.; W/43 1/4" Belt O.C.		②♣9430HD	Detroit Diesel 3-53T Diesel		
Belt - Fan	212588	③TR24379	Hose - Upper - Eng. To Pipe		24232
Belt - W.P.	178519	TR22299	Hose - Upper - Pipe To Rad.		24232
Belt - Alt.	178571	TR22434	Hose - Lower - Eng. To Pipe		♣<20882
Hose - Upper		♣<20267	Hose - Lower - Pipe To Rad.		24232
		or 25472	55		
Hose - Lower; Ser. No. 1386 Thru 1816		♣<21660	Detroit Diesel 3-53 Diesel		
		or 25474	Hose - Upper		25476
Hose - Lower; Ser. No. 7423 Thru 7617		♣<21660	Hose - Lower		26509
		or 25474	55 III		
Hose - Lower; Ser. No. 1AA681 & After		♣<21660	Detroit Diesel 3-53 Diesel		
		or 25474	Hose - Upper		♣<21794
35A					or 25476
Detroit Diesel 3-53 Diesel			Hose - Lower		26508
Belt - Fan; W/48 1/4" Belt O.C.		②♣9480HD	55A I; 55A II		
Belt - Fan; W/65 1/4" Belt O.C.	948146	②♣9650HD	Continental F244		
Belt - W.P. & Alt.; W/41 5/8" Belt O.C.	5133601	②7410	Hose - Upper		26502
Belt - W.P. & Alt.; W/42 1/4" Belt O.C.		♣9420HD	Hose - Lower		♣<21794
Belt - W.P. & Gen.	5116450	②7405			or 25480
Hose - Upper		♣<21794	Detroit Diesel 3-53 Diesel		
		or 25474	Hose - Upper		♣<21794
Hose - Lower		26508			or 25476
35AWS			55A III		
Continental F226			Detroit Diesel 3-53 Diesel		
Hose - Upper		26502	Hose - Upper - Eng. To Pipe; Ser. No. 416A101 & After ...		♣<20065
Hose - Lower		♣<21794			or 25472
		or 25480	Hose - Upper - Pipe To Rad.		24226
Detroit Diesel 3-53 Diesel			Hose - Lower - Eng. To Pipe; Ser. No. 416A101 Thru		
Hose - Upper		♣<21794	416A395		24232
		or 25474	Hose - Lower - Eng. To Pipe; Ser. No. 416A400 Thru		
Hose - Lower		26508	416A413		24232
Waukesha 190GLB			Hose - Lower - Eng. To Pipe; Ser. No. 416A415,		
Hose - Upper		26502	416A101FSC & After		24232
Hose - Lower		♣<21794	Hose - Lower - Eng. To Pipe; Ser. No. 416A396 Thru		
		or 25480	416A399		26508
35B			Hose - Lower - Eng. To Pipe; Ser. No. 416A414,		
Continental F226			416A416 & After		26508
Hose - Upper		26502	Hose - Lower - Eng. To Pipe; Ser. No. 416C101FSU &		
Hose - Lower		♣<21794	After		26508
		or 25480	Hose - Lower - Pipe To Rad.		24232
Detroit Diesel 3-53 Diesel			55B		
Hose - Upper		♣<21794	Detroit Diesel 4-53N Diesel		
		or 25474	Hose - Upper		②24432
Hose - Lower		26508	Hose - Lower		②24436
45; 45A			55C		
Waukesha 190GLB			Detroit Diesel 4-53 Diesel		
Hose - Upper		♣<21794	Hose - Upper		②24232
		or 25476	Hose - Lower		③24232
Hose - Lower; Ser. No. C3ZA9-10 & After		♣<21794	75		
		or 25477	Detroit Diesel 4-53 Diesel		
45B			Detroit Diesel 4-53 Diesel		
Detroit Diesel 4-53 Diesel			Hose - Upper; Ser. No. C-91800 & After		26509
Hose - Upper		♣<21794	Hose - Lower; Ser. No. C-91800 & After		♣<21794
		or 25474			or 25480
Hose - Lower		26508			

♣Standard Belt Available.
③Three Required.

②Two Required.
♣<Cut to Fit.

Belts and Coolant Hose for Road & Construction Equipment

Application	Mfr. Part No.	Our No.	Application	Mfr. Part No.	Our No.
Clark-Michigan-VME - Continued			Clark-Michigan-VME - Continued		
75 III			85A I - Continued		
Detroit Diesel 4-53 Diesel			Waukesha 197DLC - Continued		
Hose - Upper		≈20065	Belt - Air Brake Compr.; W/40 3/4" Belt		
	or	25472	O.C.	151466	♣9405HD
Hose - Lower		20685	Belt - Air Brake Compr.; W/41 3/4" Belt		
	or	26507	O.C.	155103	♣9415HD
75A II			85A II		
Detroit Diesel 4-53 Diesel			Cummins JN6CI Diesel		
Hose - Upper		20065	Belt - Fan	124466	②TR24365
	or	25473	Belt - W.P.; W/30 1/2" Belt O.C.	101427	TR22299
Hose - Lower		26507	Belt - W.P.; W/34 1/8" Belt O.C.	111726	TR22329
Waukesha F283			Belt - Gen.; W/46 5/8" Belt O.C.	70885	TR22461
Hose - Upper		≈20611	Belt - Gen.; W/47 7/8" Belt O.C.	106070	TR22474
	or	26510	Cummins JN130CI Diesel		
Hose - Lower - Eng. To Pipe; Ser. No. 2CA101 Thru 3CA175		24228	Hose - Upper; Ser. No. 2DC101 Thru 4DC999		26509
Hose - Lower - Pipe To Rad.		24228	Hose - Lower; Ser. No. 2DC101 Thru 4DC999		②24236
75A III			Detroit Diesel 4-53 Diesel		
Cummins LT464C Diesel			Hose - Upper; Ser. No. 2DG101 Thru 4DG999		≈21794
Hose - Upper; Ser. No. 408A101 & After		26508		or	25476
Hose - Upper; Ser. No. 1ACC101 & After		26508	Hose - Lower; Ser. No. 2DG101 Thru 4DG999		20685
Hose - Lower; Ser. No. 408A101 & After		26523		or	26507
Detroit Diesel 4-71N Diesel			Waukesha 135GZ		
Hose - Upper - Eng. To Pipe		≈20206	Belt - Fan; W/49 1/4" Belt O.C.	A197003	②♣9490HD
	or	26507	Belt - Fan; W/56 1/4" Belt O.C.	0152423	②♣9560HD
Hose - Lower - Eng. To Pipe		24232	Belt - Gen.	195203	♣9451HD
Hose - Lower - Pipe To Rad.		24232	Belt - Air Brake Compr.; W/40 3/4" Belt		
75B			O.C.	151466	♣9405HD
Cummins V504 Diesel			Belt - Air Brake Compr.; W/41 3/4" Belt		
Hose - Upper		26508	O.C.	155103	♣9415HD
Hose - Lower		26523	Hose - Upper		26508
75C			Hose - Lower - Eng. To Pipe		24240
Cummins V504 Diesel			Hose - Lower - Pipe To Rad.		24236
Belt - Fan & W.P.		②TR22534	85A III		
Belt - Alt.	554876	②7450	Cummins V785 Diesel		
Hose - Upper - Eng. To Pipe		24232	Belt - Fan	178532	③TR24562
Hose - Upper - Pipe To Rad.		24232	Belt - W.P.; W/3/8" Belt T.W.; W/37 1/8"		
Hose - Lower - Eng. To Pipe		24232	Belt O.C.	947952	②7370
Hose - Lower - Pipe To Rad.		24232	Belt - W.P.; W/23/32" Belt T.W.; W/37 1/8"		
Detroit Diesel 4-53 Diesel			Belt O.C.	178530	TR24365
Belt - Fan & Air Brake Compr.		②♣9680HD	Belt - Alt.; W/37 1/8" Belt O.C.	557527	7370
Belt - Alt.		②7430	Belt - Alt.; W/46 5/8" Belt O.C.	178593	TR22461
85A I			Hose - Upper - Eng. To Pipe		②24236
Detroit Diesel 4-53 Diesel			Hose - Upper - Pipe To Rad.		②24236
Belt - Fan	124466	②TR24365	Hose - Lower - Eng. To Pipe		24236
Belt - W.P.; W/30 1/2" Belt O.C.	101427	TR22299	Hose - Lower - Pipe To Rad.		≈20172
Belt - W.P.; W/34 1/8" Belt O.C.	111726	TR22329	Detroit Diesel 6V-53N Diesel		
Belt - Gen.; W/46 5/8" Belt O.C.	70885	TR22461	Belt - W.P.	5116451	7370
Belt - Gen.; W/47 7/8" Belt O.C.	106070	TR22474	Belt - Alt.	5133177	7370
Hose - Upper; Ser. No. 1DG26 Thru 1DG999		≈21794	Hose - Upper		②24226
	or	25473	Hose - Lower		②24232
Hose - Lower; Ser. No. 1DG26 Thru 1DG999		26507	85C		
Waukesha 190GL			Cummins V785 Diesel		
Hose - Upper		26508	Belt - Fan	178532	③TR24562
Hose - Lower - Pipe To Rad.		24232	Belt - W.P.	178530	TR24365
Waukesha 197DLC			Belt - Alt.	178593	TR22461
Belt - Fan; W/49 1/4" Belt O.C.	A197003	②♣9490HD	Hose - Upper		④24436
Belt - Fan; W/56 1/4" Belt O.C.	0152423	②♣9560HD	Hose - Lower - Eng. To Pipe		≈20172
Belt - Gen.	195203	♣9451HD	Hose - Lower - Pipe To Rad.		24436
75 III			110 III-H14		
Detroit Diesel 4-53 Diesel			Detroit Diesel 4-71 Diesel		
Hose - Upper		≈21794	Hose - Upper; Ser. No. 6TGH101 Thru 6TGH999		④24236
	or	25473	Hose - Lower; Ser. No. 6TGH101 Thru 6TGH999		②24244
Hose - Lower; Ser. No. 1DG26 Thru 1DG999		26507			

≈Cut to Fit.
♣Standard Belt Available.
④Four Required.

②Two Required.
③Three Required.

Road & Construction Equipment

Belts and Coolant Hose for Road & Construction Equipment

Application	Mfr. Part No.	Our No.	Application	Mfr. Part No.	Our No.
Clark-Michigan-VME - Continued			Clark-Michigan-VME - Continued		
110-9			125A I - Continued		
Cummins V504 Diesel			Waukesha 135GZB Diesel		
Belt - Fan & W.P.		②TR22495	Hose - Upper; Ser. No. 12123D Thru 13559D		②<20611
Belt - Alt.; W/34 7/8" Belt O.C.		TR22344		or	26508
Belt - Alt.; W/68 3/8" Belt O.C. 178543		②▲9680HD	Hose - Lower		②24232
Hose - Upper; Ser. No. 222A101 & After		26511	125A II		
Hose - Lower - Eng. To Pipe; Ser. No. 222A101 & After ...		24436	Cummins C175CI Diesel		
Hose - Lower - Pipe To Rad.; Ser. No. 222A101 & After ..		26519	Belt - Fan	124466	②TR24365
110-11			Belt - W.P.; W/30 1/2" Belt O.C.	101427	TR22299
Detroit Diesel 4-71 Diesel			Belt - W.P.; W/34 1/8" Belt O.C.	111726	TR22329
Belt - Fan & Air Brake Compr.		TR34700	Belt - Gen.; W/46 5/8" Belt O.C.	70885	TR22461
Hose - Upper; Ser. No. 415A101 & After		26510	Belt - Gen.; W/47 7/8" Belt O.C.	106070	TR22474
Hose - Lower; Ser. No. 415A101 & After		26504	Hose - Upper; Ser. No. 39123 Thru 2FC999		②③<20685
110-11B			Hose - Lower; Ser. No. 39123 Thru 2FC999		②24236
Cummins V504 Diesel			Detroit Diesel 6V-53 Diesel		
Belt - Fan & W.P.		②TR22495	Belt - Fan	5116778	②▲9470HD
Belt - Alt.; W/34 7/8" Belt O.C.		TR22344	Belt - W.P.	5116451	②7370
Belt - Alt.; W/68 3/8" Belt O.C. 178543		②▲9680HD	Belt - Gen.	5124814	7365
Hose - Upper; W/1 3/4" I.D. Hose		26612	Belt - V.P.	672073	▲9350HD
Hose - Upper; W/2" I.D. Hose		26512	Hose - Upper; Ser. No. 13337 Thru 16417		26507
Hose - Lower; W/1 3/4" I.D. Hose		26612	Hose - Upper; Ser. No. 2FG1 Thru 2FG999		24232
Hose - Lower; W/2" I.D. Hose		26512	Hose - Lower; Ser. No. 13337 Thru 16417		26508
110-15			Hose - Lower; Ser. No. 2FG1 Thru 2FG999		26508
Detroit Diesel 6V-71 Diesel			125A III		
Belt - Fan	5133761	③▲9530HD	Cummins C175CI Diesel		
Belt - Alt.	5140927	②9279	Belt - Fan	178717	TR24562
Hose - Upper; Ser. No. 224A101 & After		④24236	Belt - W.P.	178530	TR24365
Hose - Lower - Eng. To Pipe		②24234	Belt - Alt.	178435	TR22455
Hose - Lower - Pipe To Rad.		②24234	Hose - Upper; Ser. No. 39123 Thru 2FC999		②③<20685
110HT			Hose - Upper - Eng. To Pipe; Ser. No. 7AFC101 Thru 13AFC999		②24236
Detroit Diesel 4-71N Diesel			Hose - Upper - Eng. To Pipe; Ser. No. 404A101 & After ...		②24236
Belt - Fan		②▲9550HD	Hose - Upper - Pipe To Rad.; Ser. No. 7AFC101 Thru 13AFC999		②24236
Belt - Fan & Air Brake Compr.; W/69 1/4" Belt O.C.		②▲9690HD	Hose - Upper - Pipe To Rad.; Ser. No. 404A101 & After ..		②24236
Belt - Fan & Air Brake Compr.; W/70 1/4" Belt O.C. 5138868		TR34700	Hose - Lower; Ser. No. 39123 Thru 2FC999		②24236
Belt - Gen.		▲9395HD	Hose - Lower - Eng. To Pipe; Ser. No. 7AFC101 Thru 13AFC999		24236
Hose - Upper		24932	Hose - Lower - Eng. To Pipe; Ser. No. 404A101 & After ...		24236
		or	Hose - Lower - Pipe To Rad.; Ser. No. 7AFC101 Thru 13AFC999		24244
Hose - Lower - Eng. To Pipe		24932	Hose - Lower - Pipe To Rad.; Ser. No. 404A101 & After ..		24244
Hose - Lower - Pipe To Rad.		26504	Detroit Diesel 6V-53 Diesel		
125A I			Belt - Fan		▲9620HD
Cummins C175 Diesel			Belt - Alt.		7370
Belt - Fan	124466	②TR24365	Belt - Air Brake Compr.		TR28473
Belt - W.P.; W/30 1/2" Belt O.C.	101427	TR22299	Hose - Upper; Ser. No. 11AFG101 Thru 12AFG999		④24236
Belt - W.P.; W/34 1/8" Belt O.C.	111726	TR22329	Hose - Upper; Ser. No. 403A101 & After		④24236
Belt - Gen.; W/46 5/8" Belt O.C.	70885	TR22461	Hose - Lower; Ser. No. 11AFG101 Thru 12AFG999		②24244
Belt - Gen.; W/47 7/8" Belt O.C.	106070	TR22474	Hose - Lower; Ser. No. 403A101 & After		②24244
Hose - Upper; Ser. No. 39123 Thru 2FC999		②③<20685	125B		
Hose - Lower; Ser. No. 39123 Thru 2FC999		②24236	Cummins 6-Cyl. 8.3 L Diesel		
Waukesha 135GZB			Belt - Fan & Alt.	3911567	▲K080670HD
Belt - Fan; W/49 1/4" Belt O.C.	A197003	②▲9490HD	Cummins VT555C Diesel		
Belt - Fan; W/56 1/4" Belt O.C.	0152423	②▲9560HD	Belt - Fan & W.P.		③▲9590HD
Belt - Gen.	195203	▲9451HD	Belt - Alt.		②7500
Belt - Air Brake Compr.; W/40 3/4" Belt O.C. 151466		▲9405HD	Hose - Upper - Eng. To Pipe		24432
Belt - Air Brake Compr.; W/41 3/4" Belt O.C. 155103		▲9415HD	Hose - Upper - Pipe To Rad.		24432
Hose - Upper; Ser. No. 12123 Thru 14130		③<20611	Hose - Lower - Eng. To Pipe		24436
		or	Hose - Lower - Pipe To Rad.		24436
Hose - Upper; Ser. No. 14131 & After		26508			
Hose - Lower; Ser. No. 12123 Thru 14130		②24232			
Hose - Lower; Ser. No. 14131 & After		②24236			

▲Standard Belt Available.

③Three Required.

③<Cut to Fit.

②Two Required.

④Four Required.

Belts and Coolant Hose for Road & Construction Equipment

Application	Mfr. Part No.	Our No.	Application	Mfr. Part No.	Our No.
Clark-Michigan-VME - Continued			Clark-Michigan-VME - Continued		
125C			175A - Continued		
Cummins LT10-225 Diesel			Waukesha 135DK Diesel - Continued		
Belt - Fan	178717	③TR24562	Hose - Lower - Pipe To Rad.; Ser. No. 17123D Thru 18568D		24236
Belt - W.P.	178530	TR24365	Hose - Lower - Pipe To Rad.; Ser. No. 18570D Thru 18575D		24236
Belt - Alt.	178435	TR22455	Hose - Lower - Pipe To Rad.; Ser. No. 18603D, 18608D, 19128D Thru 19177D		24236
Hose - Upper - Eng. To Pipe		24436	Hose - Lower - Pipe To Rad.; Ser. No. 2HB50 & After		24236
Hose - Upper - Pipe To Rad.		24436	Hose - Lower - Pipe To Rad.; Ser. No. 18569D, 18576D Thru 18602D		26520
Hose - Lower - Eng. To Pipe		21901	Hose - Lower - Pipe To Rad.; Ser. No. 18604D Thru 18607D		26520
Hose - Lower - Pipe To Rad.		26511	Hose - Lower - Pipe To Rad.; Ser. No. 18609D Thru 19127D		26520
175A			Waukesha 135GK		
Cummins JT6BI Diesel			Belt - Fan; W/49 1/4" Belt O.C.	A197003	②④9490HD
Belt - Fan	109179	②④9385HD	Belt - Fan; W/56 1/4" Belt O.C.	0152423	②④9560HD
Belt - W.P.	111726	TR22329	Belt - Gen.	195203	④9451HD
Belt - Gen.	70885	TR22461	Hose - Upper - Pipe To Rad.; Ser. No. 17123 Thru 19127		24232
Hose - Upper		②④20685	Hose - Lower - Pipe To Rad.; Ser. No. 17123 Thru 19127		24236
Hose - Lower		②24236	175A III		
Detroit Diesel 4-71 Diesel			Cummins C175 Diesel		
Belt - Fan & Compr.		TR28657	Belt - Fan	197028	TR24379
Belt - Gen.		TR30408	Belt - W.P.	178461	TR22299
Hose - Upper; Ser. No. 18340 Thru 25540		④20611	Belt - Alt.	178571	TR22434
Hose - Upper; Ser. No. 25541 Thru 25730		26508	Hose - Upper; Ser. No. 5HC101 Thru 6HC999		④24236
Hose - Upper; Ser. No. 2HG191 & After		26508	Hose - Lower; Ser. No. 5HC101 Thru 6HC999		26520
Hose - Lower; Ser. No. 18340 Thru 25540		26508	Detroit Diesel 8V-71 Diesel		
Hose - Lower; Ser. No. 25541 Thru 25730		24232	Belt - Fan	5133761	③④9530HD
	or	26509	Belt - Alt.; W/V-Ribbed Belt Drive		K080370
Hose - Lower; Ser. No. 2HG191 & After		24232	Belt - Alt.; W/V-Belt Drive	556878	②7370
	or	26509	Belt - Air Brake Compr.	5126405	TR28473
Waukesha 135DK Diesel			Hose - Upper; Ser. No. 5AHG101 Thru 7AHG999		④24236
Belt - Fan; W/49 1/4" Belt O.C.	A197003	②④9490HD	Hose - Upper; Ser. No. 8AHG101 Thru 13AHG999		②24244
Belt - Fan; W/56 1/4" Belt O.C.	0152423	②④9560HD	Hose - Lower; Ser. No. 8AHG101 Thru 13AHG999		②24244
Belt - Gen.	195203	④9451HD	175B		
Hose - Upper - Eng. To Pipe; W/Turbo; Ser. No. 17123D Thru 18568D		24232	Detroit Diesel 8V-71 Diesel		
Hose - Upper - Eng. To Pipe; W/Turbo; Ser. No. 18570D Thru 18575D, 18603D, 18608D		24232	Belt - Fan		④④9530HD
Hose - Upper - Eng. To Pipe; Ser. No. 18569D		④20611	Belt - Alt.; W/30 5/8" Belt O.C.	949282	K080300
	or	26508	Belt - Alt.; W/37 5/8" Belt O.C.	5138935	K080370
Hose - Upper - Eng. To Pipe; Ser. No. 18576D Thru 18602D		④20611	Belt - Air Brake Compr.	5145730	TR28480
	or	26508	Hose - Upper - Eng. To Pipe		②24236
Hose - Upper - Eng. To Pipe; Ser. No. 18604D Thru 18607D		④20611	Hose - Upper - Pipe To Rad.		②24236
	or	26508	Hose - Lower - Eng. To Pipe		24244
Hose - Upper - Eng. To Pipe; Ser. No. 18609D Thru 19127D		④20611	Hose - Lower - Pipe To Rad.		24244
	or	26508	175C		
Hose - Upper - Eng. To Pipe; Ser. No. 19128D Thru 19177D		26509	Cummins NTA855 Diesel		
Hose - Upper - Eng. To Pipe; Ser. No. 2HB50 & After		26509	Belt - Fan	178662	③④9510HD
Hose - Upper - Pipe To Rad.; Ser. No. 17123 Thru 19127		24232	Belt - Alt.		②④9463HD
Hose - Lower - Eng. To Pipe; W/O Turbo; Ser. No. 17123D Thru 18568D		24236	Belt - W.P.		②6596
Hose - Lower - Eng. To Pipe; W/O Turbo; Ser. No. 18570D Thru 18575D, 18603D, 18608D		24236	Hose - Upper		②24436
Hose - Lower - Eng. To Pipe; W/Turbo; Ser. No. 17123D Thru 18568D		24232	Hose - Lower		②24440
Hose - Lower - Eng. To Pipe; W/Turbo; Ser. No. 18570D Thru 18575D, 18603D, 18608D		24232	180		
Hose - Lower - Eng. To Pipe; Ser. No. 18569D, 18576D Thru 18602D		24236	Cummins C175 Diesel		
Hose - Lower - Eng. To Pipe; Ser. No. 18604D Thru 18607D		24236	Belt - Fan	124466	②TR24365
Hose - Lower - Eng. To Pipe; Ser. No. 18609D Thru 19177D		24236	Belt - W.P.	101427	TR22299
Hose - Lower - Eng. To Pipe; Ser. No. 2HB50 & After		24236	Belt - Gen.	70885	TR22461
Hose - Lower - Pipe To Rad.; Ser. No. 17123 Thru 19127		24236	Hose - Upper; Ser. No. 1896, 1898 Thru 1902		②④20685
			Hose - Upper; Ser. No. 2823 Thru 2891		②④20685
			Hose - Lower; Ser. No. 1896, 1898 Thru 1902		②24236

④Standard Belt Available.
 ④Cut to Fit.
 ③Three Required.

②Two Required.
 ④Four Required.

Road & Construction Equipment

Belts and Coolant Hose for Road & Construction Equipment

Application	Mfr. Part No.	Our No.	Application	Mfr. Part No.	Our No.
Clark-Michigan-VME - Continued			Clark-Michigan-VME - Continued		
180 - Continued			275 Articulated - Continued		
Cummins C175 Diesel - Continued			Cummins NT855 Diesel - Continued		
Hose - Lower; Ser. No. 2823 Thru 2891		②24236	Belt - Gen.; W/41 1/2" Belt O.C.	178599	TR22410
Cummins JT6BI Diesel			275 III		
Belt - Fan	109179	②♣9385HD	Cummins NT310 Diesel		
Belt - W.P.	111726	TR22329	Hose - Upper; Ser. No. 4JC101 & After		②24236
Belt - Gen.	134816	TR22495	Hose - Lower; Ser. No. 4JC101 & After		②24236
Detroit Diesel 6V-53 Diesel			Detroit Diesel 8V-71N Diesel		
Belt - Fan	5109052	②♣9600HD	Hose - Upper; Ser. No. 6JG101 Thru 8JG999		④24236
Belt - W.P.	5116451	②7370	275A I		
Belt - Gen.	5124814	7375	Cummins NTO6BI Diesel		
Waukesha 135DK Diesel			Belt - Fan; W/51 7/8" Belt O.C.	S3094	②TR28514
Hose - Upper; Ser. No. 1823 Thru 1895, 1897, 1903, 1904		②24232	Belt - Fan; W/55 1/8" Belt O.C.	178725	③TR28545
Hose - Lower; Ser. No. 1823 Thru 1895, 1897, 1903, 1904		②24236	Belt - Fan; W/58 1/4" Belt O.C.	178626	③TR24578
180 I			Belt - Fan; W/61 1/8" Belt O.C.	178526	③TR24607
Cummins C175 Diesel; Cummins JT6BI Diesel			Belt - W.P.	200328	TR24438
Hose - Upper; Ser. No. 2892 Thru 2942	②♣20685		Belt - Alt.	200549	②♣9465HD
Hose - Upper; Ser. No. 2LC52 Thru 2LC999	②♣20685		Belt - Gen.; W/36 3/8" Belt O.C.	70350	TR22358
Hose - Lower; Ser. No. 2892 Thru 2942	②24236		Belt - Gen.; W/40 1/8" Belt O.C.	178573	TR22397
Hose - Lower; Ser. No. 2LC52 Thru 2LC999	②24236		Belt - Gen.; W/41 1/2" Belt O.C.	178599	TR22410
180 III			275A III		
Cummins C175 Diesel; Cummins JT6BI Diesel			Cummins NT310 Diesel		
Hose - Upper - Eng. To Pipe; Ser. No. 3LC101 Thru 3LC999		24232	Belt - Fan; W/51 7/8" Belt O.C.	S3094	②TR28514
Hose - Upper - Eng. To Pipe; Ser. No. 5LC101 & After		24232	Belt - Fan; W/55 1/8" Belt O.C.	178725	③TR28545
Hose - Upper - Pipe To Rad.; Ser. No. 3LC101 Thru 3LC999	♣20685		Belt - Fan; W/58 1/4" Belt O.C.	178626	③TR24578
Hose - Upper - Pipe To Rad.; Ser. No. 5LC101 & After	♣20685		Belt - Fan; W/61 1/8" Belt O.C.	178526	③TR24607
Hose - Upper; Ser. No. 4MC102 Thru 6MC999	②24236		Belt - W.P.	200328	TR24438
Hose - Lower - Eng. To Pipe; Ser. No. 3LC101 Thru 3LC999		24236	Belt - Alt.	200549	②♣9465HD
Hose - Lower - Eng. To Pipe; Ser. No. 5LC101 & After		24236	Belt - Gen.; W/36 3/8" Belt O.C.	70350	TR22358
Hose - Lower - Pipe To Rad.; Ser. No. 3LC101 Thru 3LC999		24236	Belt - Gen.; W/40 1/8" Belt O.C.	178573	TR22397
Hose - Lower - Pipe To Rad.; Ser. No. 5LC101 & After		24236	Belt - Gen.; W/41 1/2" Belt O.C.	178599	TR22410
Hose - Lower; Ser. No. 4MC102 Thru 6MC999	②24236		Cummins NT855 Diesel		
Detroit Diesel 6V-53 Diesel			Hose - Upper - Eng. To Pipe; Ser. No. 5AJC101 & After ..		24236
Hose - Upper; Ser. No. 4MG101 Thru 8MG999	②24236		Hose - Upper - Pipe To Rad.; Ser. No. 5AJC101 & After ..		24236
Hose - Lower; Ser. No. 5LG101 & After	②24232		Hose - Lower - Eng. To Pipe; Ser. No. 5AJC101 & After ..		24236
Hose - Lower; Ser. No. 4MG101 Thru 8MG999	②24244		Hose - Lower - Pipe To Rad.; Ser. No. 5AJC101 Thru 9ACJ999		24236
210H			Hose - Lower - Pipe To Rad.; Ser. No. 10AJC101 & After ..		♣20172 or 26519
Cummins NT855 Diesel			275B		
Hose - Upper - Eng. To Pipe; Ser. No. 5UCH165 & After ..		24236	Cummins KT1150C Diesel		
Hose - Upper - Eng. To Pipe; Ser. No. 411A101 & After ...		24236	Hose - Upper - Eng. To Pipe		24440
Hose - Upper - Pipe To Rad.; Ser. No. 5UCH165 & After ..		24236	Hose - Upper - Pipe To Rad.		24440
Hose - Upper - Pipe To Rad.; Ser. No. 411A101 & After ..		24236	Hose - Lower - Eng. To Pipe		24256
Hose - Lower - Eng. To Pipe; Ser. No. 5UCH165 & After ..		24236	Hose - Lower - Pipe To Rad.		24256
Hose - Lower - Eng. To Pipe; Ser. No. 411A101 & After ...		24236	Cummins NTA855 Diesel		
Hose - Lower - Pipe To Pipe; Ser. No. 5UCH165 & After ..		24244	Belt - Fan	③♣9525HD	
Hose - Lower - Pipe To Pipe; Ser. No. 411A101 & After ...		24244	Belt - Alt.	②7465	
275 Articulated			Belt - W.P.	②♣9451HD	
Cummins NT855 Diesel			275C		
Belt - Fan; W/51 7/8" Belt O.C.	S3094	②TR28514	Cummins KT19C Diesel		
Belt - Fan; W/55 1/8" Belt O.C.	178725	③TR28545	Hose - Upper - Eng. To Pipe		24440
Belt - Fan; W/58 1/4" Belt O.C.	178626	③TR24578	Hose - Upper - Pipe To Rad.		24440
Belt - Fan; W/61 1/8" Belt O.C.	178526	③TR24607	Hose - Lower - Eng. To Pipe		24256
Belt - W.P.	200328	TR24438	Hose - Lower - Pipe To Rad.		24256
Belt - Alt.	200549	②♣9465HD	Cummins KT1150C Diesel		
Belt - Gen.; W/36 3/8" Belt O.C.	70350	TR22358	Belt - Alt.		K050370
Belt - Gen.; W/40 1/8" Belt O.C.	178573	TR22397	Detroit Diesel 8V-92 Diesel		
			Belt - Fan		③♣9640HD

♣Standard Belt Available.
 ♣Cut to Fit.
 ④Four Required.

②Two Required.
 ③Three Required.

Belts and Coolant Hose for Road & Construction Equipment

Application	Mfr. Part No.	Our No.	Application	Mfr. Part No.	Our No.
Clark-Michigan-VME - Continued			Clark-Michigan-VME - Continued		
275C - Continued			380 I - Continued		
Detroit Diesel 8V-92 Diesel - Continued			Cummins NFT6BI Diesel - Continued		
Belt - Alt		②7475	Belt - W.P.	S3163	TR22434
280			Belt - Gen.	70350	TR22358
Cummins NH Diesel; Cummins NT Diesel			Hose - Lower; Ser. No. 42123 & After		②24236
Belt - Fan; W/51 7/8" Belt O.C.	S3094	②TR28514	Cummins NHH12BI Diesel		
Belt - Fan; W/55 1/8" Belt O.C.	178725	③TR28545	Belt - Fan	S3094	②TR28514
Belt - Fan; W/58 1/4" Belt O.C.	178626	③TR24578	Belt - Gen.	70350	TR22358
Belt - Fan; W/61 1/8" Belt O.C.	178526	③TR24607	Hose - Lower; Ser. No. 42123 & After		②24236
Belt - W.P.	200328	TR24438	Cummins NT380 Diesel		
Belt - Alt	200549	②▲9465HD	Belt - Fan	134835	②TR24578
Belt - Gen.; W/36 3/8" Belt O.C.	70350	TR22358	Belt - W.P.	132013	TR22434
Belt - Gen.; W/40 1/8" Belt O.C.	178573	TR22397	Belt - Gen.	132010	TR22363
Belt - Gen.; W/41 1/2" Belt O.C.	178599	TR22410	Hose - Lower; Ser. No. 42123 & After		②24236
280 I			380 II		
Cummins NH Diesel; Cummins NT Diesel			Cummins NFT6BI Diesel		
Hose - Lower; Ser. No. 32123 Thru 32999		②24236	Belt - Fan	532778	③▲9640HD
Hose - Lower; Ser. No. 1MC156 Thru 3MC999		②24236	Belt - W.P.	S3163	TR22434
Detroit Diesel 8V-71 Diesel			Belt - Gen.	70350	TR22358
Hose - Upper; Ser. No. 1MG1 Thru 3MG999		②24236	Hose - Lower - Pipe To Rad.; Ser. No. 2RC1 Thru 2RC999		②24240
280 III			Cummins NHH12BI Diesel		
Detroit Diesel 8V-71 Diesel			Belt - Fan	S3094	②TR28514
Belt - Fan		③▲9610HD	Belt - Gen.	70350	TR22358
Belt - Alt		7380	Hose - Lower - Pipe To Rad.; Ser. No. 2RC1 Thru 2RC999		②24240
Belt - Hyd. Pump		TR28463	Cummins NT380 Diesel		
280A III			Belt - Fan	134835	②TR24578
Detroit Diesel 8V-71 Diesel			Belt - W.P.	132013	TR22434
Hose - Upper; Ser. No. 8AMG101 Thru 9AMG999		②24236	Belt - Gen.	132010	TR22363
Hose - Lower; Ser. No. 8AMG101 Thru 9AMG999		②24244	Hose - Lower - Pipe To Rad.; Ser. No. 2RC1 Thru 2RC999		②24240
301S			Detroit Diesel 8V-71 Diesel		
Detroit Diesel 4-71 Diesel			Hose - Upper; Ser. No. 2RG1 Thru 4RG999		②24240
Belt - Fan		②▲9530HD	Hose - Upper; Ser. No. 5RG101 & After		②24240
Belt - Alt		▲9385HD	Hose - Lower; Ser. No. 5RG101 & After		②24256
Hose - Upper		26511	380 III		
Hose - Lower - Eng. To Pipe		24432	Cummins NFT6BI Diesel; Cummins NHH12BI Diesel; Cummins NT380 Diesel		
310			Hose - Lower - Pipe To Rad.; Ser. No. 2RC1 Thru 2RC999		②24240
Detroit Diesel 12V-71 Diesel			Detroit Diesel 8V-71 Diesel		
Belt - Fan		③▲9630HD	Hose - Upper; Ser. No. 2RG1 Thru 4RG999		②24240
Belt - Alt		②▲9405HD	Hose - Upper; Ser. No. 5RG101 & After		②24240
Belt - Air Brake Compr.		TR28473	Hose - Lower; Ser. No. 5RG101 & After		②24256
Hose - Upper - Eng. To Pipe		24440	475 Articulated		
Hose - Upper - Pipe To Rad.		24440	Cummins VT1710 Diesel		
Hose - Lower - Eng. To Pipe		24456	Belt - Fan; Ser. No. 421E290 & After		③TR28666
Hose - Lower - Pipe To Rad.		24456	Belt - W.P.; Ser. No. 421E101 & After	178665	②TR28390
310 III			Belt - Alt.; Ser. No. 421E101 & After	178520	②▲9380HD
Detroit Diesel 12V-71 Diesel			475A III		
Hose - Upper; Ser. No. 4VG101 Thru 6VG999		④24240	Cummins VT1710 Diesel		
Hose - Upper; Ser. No. 8VG101 & After		④24240	Hose - Upper - Eng. To Pipe; Ser. No. 421F101 & After ...		②23572
Hose - Lower; Ser. No. 8VG101 & After		②24256	Hose - Upper - Pipe To Rad.; Ser. No. 1AYC101 Thru 1AYC999		②23572
375A			Hose - Upper - Pipe To Rad.; Ser. No. 421E101 Thru 421E999		②23572
Cummins NRTO6BI Diesel			Hose - Upper - Pipe To Rad.; Ser. No. 421F101 & After ...		②23572
Belt - Fan	134809	②TR28492	Hose - Lower - Eng. To Pipe; Ser. No. 421F101 & After ...		②24456
Belt - W.P.	178628	TR24438	Hose - Lower - Pipe To Rad.; Ser. No. 421F101 & After ...		②24456
Belt - Gen.	132010	TR22363	380 I		
380 I			Cummins NFT6BI Diesel		
Cummins NFT6BI Diesel			Belt - Fan	532778	③▲9640HD

②Two Required.
▲Standard Belt Available.

③Three Required.
④Four Required.

Belts and Coolant Hose for Road & Construction Equipment

Application	Mfr. Part No.	Our No.	Application	Mfr. Part No.	Our No.
Clark-Michigan-VME - Continued			Clark-Michigan-VME - Continued		
475B			664B		
Cummins VTA1710C Diesel			Cummins V378 Diesel		
Belt - Fan; Ser. No. 421E290 & After		③TR28666	Belt - Fan	178685	②TR22485
Belt - W.P.; Ser. No. 421E101 & After	178665	②TR28390	Belt - Alt.	178471	♣9365HD
Belt - Alt.; Ser. No. 421E101 & After	178520	②♣9380HD	Detroit Diesel 3-53 Diesel		
Hose - Upper - Eng. To Pipe; Ser. No. 421F101 & After ...		②23572	Belt - Fan; W/31 1/8" Belt O.C.	5134094	②♣9309HD
Hose - Upper - Pipe To Rad.; Ser. No. 1AYC101 Thru 1AYC999		②23572	Belt - Fan; W/31 3/4" Belt O.C.	5135298	②♣9313HD
Hose - Upper - Pipe To Rad.; Ser. No. 421E101 Thru 421E999		②23572	Belt - Fan; W/35 1/4" Belt O.C.	5126447	②♣9350HD
Hose - Upper - Pipe To Rad.; Ser. No. 421F101 & After ...		②23572	Belt - W.P. & Alt.	1305106	②7410
Hose - Lower - Eng. To Pipe; Ser. No. 421F101 & After ...		②24456	Hose - Upper - Pipe To Rad.		20351
Hose - Lower - Pipe To Rad.; Ser. No. 421F101 & After ...		②24456	Hose - Lower - Eng. To Pipe		♣20206
480			Hose - Lower - Pipe To Rad.		24232
Cummins VT12 Diesel			Detroit Diesel 4-53 Diesel		
Belt - Fan	522125	③♣9610HD	Belt - Fan; W/31 1/8" Belt O.C.	5134094	②♣9309HD
Belt - W.P.	125367	TR28376	Belt - Fan; W/31 3/4" Belt O.C.	5135298	②♣9313HD
Belt - Gen.; W/34 3/4" Belt O.C.	134813	TR22344	Belt - Fan; W/35 1/4" Belt O.C.	5126447	②♣9350HD
Belt - Gen.; W/36 3/8" Belt O.C.	70350	TR22358	Belt - W.P. & Alt.	1305106	②7410
Hose - Upper - Pipe To Rad.; Ser. No. 3SC101 Thru 4SC999		②24240	664C		
Hose - Lower - Pipe To Rad.; Ser. No. 43123 Thru 43999		②24240	Detroit Diesel 4-53 Diesel		
Hose - Lower - Pipe To Rad.; Ser. No. 2SC1 Thru 2SC999		②24240	Belt - Fan		②♣9290HD
Hose - Lower - Pipe To Rad.; Ser. No. 4SG101 Thru 4SG999		②24240	Belt - W.P. & Alt.		7430
501S			Hose - Lower - Eng. To Pipe		♣20611
Detroit Diesel 6V-71 Diesel			Hose - Lower - Pipe To Rad.		24432
Hose - Upper		②26524	666		
Hose - Lower		24940	Cummins V378 Diesel		
662			Belt - Fan	178685	②TR22485
Cummins V378 Diesel			Belt - Alt.	178471	♣9365HD
Hose - Lower - Eng. To Pipe		♣20172	Hose - Lower - Eng. To Pipe		♣20172
Hose - Lower - Pipe To Rad.		24236	Hose - Lower - Pipe To Rad.		24236
Detroit Diesel 3-53 Diesel			Detroit Diesel 3-53 Diesel; Detroit Diesel 4-53 Diesel		
Belt - Fan		②♣9330HD	Belt - Fan; W/31 1/8" Belt O.C.	5134094	②♣9309HD
Belt - W.P. & Alt.	1305106	②7410	Belt - Fan; W/31 3/4" Belt O.C.	5135298	②♣9313HD
Hose - Upper		26502	Belt - Fan; W/35 1/4" Belt O.C.	5126447	②♣9350HD
Hose - Lower - Eng. To Pipe		24232	Belt - W.P. & Alt.	1305106	②7410
Hose - Lower - Pipe To Rad.		26508	Hose - Upper		26502
Detroit Diesel 4-53 Diesel			Hose - Lower - Eng. To Pipe		24232
Hose - Upper		26502	Hose - Lower - Pipe To Rad.		26508
Hose - Lower - Eng. To Pipe		24232	666B		
Hose - Lower - Pipe To Rad.		26508	Cummins V378 Diesel		
664			Belt - Fan	178685	②TR22485
Cummins V378 Diesel			Belt - Alt.	178471	♣9365HD
Belt - Fan	178685	②TR22485	Detroit Diesel 3-53 Diesel; Detroit Diesel 4-53 Diesel		
Belt - Alt.	178471	♣9365HD	Belt - Fan; W/31 1/8" Belt O.C.	5134094	②♣9309HD
Hose - Lower - Eng. To Pipe		♣20172	Belt - Fan; W/31 3/4" Belt O.C.	5135298	②♣9313HD
Hose - Lower - Pipe To Rad.		24236	Belt - Fan; W/35 1/4" Belt O.C.	5126447	②♣9350HD
Detroit Diesel 3-53 Diesel; Detroit Diesel 4-53 Diesel			Belt - W.P. & Alt.	1305106	②7410
Belt - Fan; W/31 1/8" Belt O.C.	5134094	②♣9309HD	666C		
Belt - Fan; W/31 3/4" Belt O.C.	5135298	②♣9313HD	Detroit Diesel 6-71 Diesel		
Belt - Fan; W/35 1/4" Belt O.C.	5126447	②♣9350HD	Belt - Fan		②♣9330HD
Belt - W.P. & Alt.	1305106	②7410	Belt - W.P. & Alt.		②7417
Hose - Upper		26502	Hose - Lower - Pipe To Rad.		24432
Hose - Lower - Eng. To Pipe		24232	675		
Hose - Lower - Pipe To Rad.		26508	Cummins VT1710 Diesel		
664			Belt - Fan	210118	③TR28666
Cummins V378 Diesel			Belt - W.P.		②TR28390
Belt - Fan	178685	②TR22485	Belt - Alt.		②♣9380HD
Belt - Alt.	178471	♣9365HD	Hose - Upper - Eng. To Pipe; Ser. No. 421F101 & After ...		②23572
Hose - Lower - Eng. To Pipe		♣20172	Hose - Upper - Pipe To Rad.; Ser. No. 1AYC101 Thru 1AYC999		②23572
Hose - Lower - Pipe To Rad.		24236			

②Two Required.
③Three Required.

♣Standard Belt Available.
♣Cut to Fit.

Belts and Coolant Hose for Road & Construction Equipment

Application	Mfr. Part No.	Our No.	Application	Mfr. Part No.	Our No.
Clark-Michigan-VME - Continued			Dart - Continued		
675 - Continued			D600B - Continued		
Cummins VT1710 Diesel - Continued			Cummins V1710 Diesel - Continued		
Hose - Upper - Pipe To Rad.; Ser. No. 421E101 Thru 421E999		②23572	Hose - Lower - Pipe To Pipe		24456
Hose - Upper - Pipe To Rad.; Ser. No. 421F101 & After ...		②23572	Hose - Lower - Pipe To Rad.		24456
Hose - Lower - Eng. To Pipe; Ser. No. 421F101 & After ...		②24456	D2551		
Hose - Lower - Pipe To Rad.; Ser. No. 421F101 & After ...		②24456	Cummins VT1710 Diesel		
CS70			Belt - Fan; W/64" Belt O.C.		
Detroit Diesel 4-53 Diesel			Belt - Fan; W/71 1/8" Belt O.C.		
Belt - Fan & Alt.	1305106	②7410	Belt - Alt.	132896	③TR28706
RW181			Belt - Gen.	148270	②TR22329
Deutz F6L514 Diesel			Belt - W.P.; W/38 3/8" Belt O.C.	101427	②TR22299
Belt - Fan		②7640	Belt - W.P.; W/39 3/4" Belt O.C.	125367	TR28376
Cleveland			Belt - W.P.; W/39 3/4" Belt O.C.	171583	②TR28390
247			Belt - Compr.		②♣9560HD
Detroit Diesel 4-53 Diesel			Belt - Converter	129949	♣9309HD
Belt - Fan		②♣9415HD	Belt - V.P.		④♣9590HD
Belt - W.P. & Alt.		②7430	D2552		
Hose - Upper		♣20065	Detroit Diesel 16V-71N Diesel		
J36HD			Belt - Fan		
Detroit Diesel 3-53 Diesel			Belt - Alt.		
Belt - Fan		②♣9412HD	Belt - Gen.		
Belt - W.P. & Alt.		②7425	Belt - Compr.		
Hose - Upper		♣21660	Belt - Converter		
		or 25474	Belt - V.P.		
Hose - Lower - Eng. To Pipe		♣20882	④♣9590HD		
Hose - Lower - Pipe To Rad.		♣20882	D2561; D2562; D2661		
CMI			Cummins VTA1710C Diesel		
AG65			Belt - Fan; W/64" Belt O.C.		
Caterpillar D343TA Diesel			Belt - Fan; W/71 1/8" Belt O.C.		
Belt - Fan; W/54 1/4" Belt O.C.		③♣9540HD	Belt - Alt.		
Belt - Fan; W/55" Belt O.C.		③TR22545	Belt - Gen.		
Belt - Alt.		TR22495	Belt - W.P.; W/38 3/8" Belt O.C.		
Hose - Upper		24448	Belt - W.P.; W/39 3/4" Belt O.C.		
Hose - Lower		②24448	Belt - Compr.		
Hose - By Pass		24224	Belt - Converter		
RS425			Belt - V.P.		
Caterpillar 3406BDITA Diesel			④♣9590HD		
Belt - Fan		5V1500	D2662		
TR225			Detroit Diesel 16V-71T Diesel		
Caterpillar 3160 Diesel			Belt - Fan		
Belt - Fan & Alt.		③♣9550HD	Belt - Alt.		
Belt - V.P.		TR22625	Belt - Gen.		
Belt - Hyd. Pump		③BX71	Belt - Compr.		
Hose - Upper		24940	Belt - Converter		
Hose - Lower		24932	Belt - V.P.		
Dart			④♣9590HD		
D600B			DE2772		
Cummins V1710 Diesel			Cummins VTA1710C Diesel		
Belt - Alt.	178520	②♣9380HD	Belt - Fan; W/64" Belt O.C.		
Belt - W.P.	178665	②TR28390	Belt - Fan; W/71 1/8" Belt O.C.		
Belt - A.C.		5VX560	Belt - Alt.		
Belt - Hyd. Pump		②TR22363	Belt - Gen.		
Hose - Upper - Eng. To Pipe		②24448	Belt - W.P.; W/38 3/8" Belt O.C.		
Hose - Upper - Pipe To Pipe		②24448	Belt - W.P.; W/39 3/4" Belt O.C.		
Hose - Upper - Pipe To Rad.		②24448	Belt - Compr.		
Hose - Lower - Eng. To Pipe		24456	Belt - Converter		
			Belt - V.P.		
			④♣9590HD		
			Ditch Witch		
			1025SK		
			Continental TMD20 Diesel		
			Belt - Fan & Alt.		
			Hose - Upper		
			♣9440HD		
			♣21660		
			2020		
			Kohler M20QS		
			Belt - Hyd. Pump		
			3VX335		

②Two Required.
 ♣Cut to Fit.
 ④Four Required.

♣Standard Belt Available.
 ③Three Required.

Road & Construction Equipment

Belts and Coolant Hose for Road & Construction Equipment

Road & Construction Equipment

Application	Mfr. Part No.	Our No.	Application	Mfr. Part No.	Our No.
Ditch Witch - Continued			Dresser-Dressta - Continued		
2300			125G		
Wisconsin VH4D			KDC 410T Diesel		
Belt - Alt.	2180		Belt - Fan & Alt.; W/56 5/8" Belt O.C.	1240873H1	♣K080560HD
2310			Belt - Fan & Alt.; W/62 5/8" Belt O.C.	1257759H1	♣K080620HD
Deutz F2L511 Diesel			150		
Belt - Blower & Alt.	170036	②3VX355	IH DT282 Diesel		
3500			Belt - Fan	328539R1	TR28616
Deutz F3L1011 Diesel			Belt - Alt.	670572C1	TR22495
Belt - Blower & Alt.	7470		Belt - Gen.	306658R1	TR22514
4010; 5010			165		
Deutz F3L912 Diesel			IH D310 Diesel		
Belt - Blower	2235175	7512	Belt - Fan	3117726R91	②♣9710HD
Belt - Alt.	170053	7417	175B		
8020			IH DT407 Diesel		
John Deere 4045D Diesel			Belt - Fan & Alt.; Ser. No. 32317 & After	670711C1	②TR22692
Hose - Upper	25477		175C		
Hose - Lower	25530		IH DT466 Diesel		
R30			Belt - Alt.; Ser. No. 17398 & Before	673481C1	TR22648
Wisconsin VH4D			Belt - Alt.; Ser. No. 17399 & After	1213134H91	②TR22664
Belt - Alt.	6821		Komatsu 610T Diesel		
R65			Belt - Fan & Alt.	1257762H1	♣K080605HD
Ford 4-Cyl. 192; Ford 4-Cyl. 192 Diesel			200		
Belt - Fan & Alt.	170043	♣9415HD	Dresser D505T Diesel		
Wisconsin V465D			Belt - Fan & Alt.	1257778H1	♣K080685HD
Belt - Fan & Alt.	170003	6718	210M		
R100D			Cummins KTA19C Diesel		
Detroit Diesel 4-53 Diesel			Belt - A.C.		②♣9380HD
Belt - Fan		♣9380HD	Hose - Upper - Eng. To Pipe		②23562
Belt - W.P.	7360		Hose - Upper - Pipe To Rad.		②23562
Belt - Alt.	7312		Hose - Lower - Eng. To Pipe		23585
V30			Hose - Lower - Pipe To Rad.		23585
Wisconsin VH4D			250B		
Belt - Alt.	6821		IH DT429 Diesel		
Dresser-Dressta			Belt - Fan & Alt.	670741C1	②TR22570
100C			Belt - Fan & Gen.	1800001C91	②TR22578
IH D206 Diesel			Belt - W.P.	328502R1	TR22485
Belt - Fan & W.P.	621770C1	♣9555HD	250C		
Belt - Alt.	670572C1	TR22495	IH DVT573B Diesel		
100E			Belt - Alt.; Ser. No. 7500 & After	673947C1	♣9447HD
IH D239 Diesel			Hose - Upper - Eng. To Pipe		24228
Belt - Fan & W.P.	621770C1	♣9555HD	Hose - Upper - Pipe To Rad.		24228
100G			Hose - Lower - Eng. To Pipe		24248
KDC 410T Diesel			Hose - Lower - Pipe To Rad.		24248
Belt - Fan & Alt.	1240873H1	♣K080560HD	250E		
125C			Cummins LTA10C Diesel		
IH D239 Diesel			Belt - Fan	1240466H1	♣K080585HD
Belt - Fan & W.P.		♣9555HD	Belt - Alt.		♣K050323HD
125E			Belt - A.C.		TR22664
IH DT239 Diesel			Hose - Upper		②24436
Belt - Fan & W.P.		♣9555HD	412B		
Dresser-Dressta			Dresser D505T Diesel		
100C			Belt - Fan & Alt.	1257778H1	♣K080685HD
IH D206 Diesel			Hose - Upper - Eng. To Pipe		24436
Belt - Fan & W.P.	621770C1	♣9555HD	Hose - Upper - Pipe To Rad.		24436
Belt - Alt.	670572C1	TR22495	Hose - Lower - Eng. To Pipe		♣21473
100E			Hose - Lower - Pipe To Rad.		24448
IH D239 Diesel					
Belt - Fan & W.P.	621770C1	♣9555HD			
100G					
KDC 410T Diesel					
Belt - Fan & Alt.	1240873H1	♣K080560HD			
125C					
IH D239 Diesel					
Belt - Fan & W.P.		♣9555HD			
125E					
IH DT239 Diesel					
Belt - Fan & W.P.		♣9555HD			

 ②Two Required.
 ⚡Cut to Fit.

♣Standard Belt Available.

Belts and Coolant Hose for Road & Construction Equipment

Application	Mfr. Part No.	Our No.	Application	Mfr. Part No.	Our No.
Dresser-Dressta - Continued			Dresser-Dressta - Continued		
500C			550 - Continued		
IH D155			IH DVT800 Diesel		
Belt - Fan & Alt.	596313R1	7445	Belt - Fan	673949C91	②TR22692
IH D155 Diesel			Belt - Alt.	686613C91	②♣9530HD
Belt - Fan & Alt.	676835R1	♣9520HD	555		
500E			Cummins NTA855 Diesel		
IH D155 Diesel			Belt - Fan	1238447H1	K060450
Belt - Fan & Alt.	676835R1	♣9520HD	Belt - W.P.	1238934H1	♣K060435HD
510B			Belt - A.C.; W/1/2" Belt T.W.	1251357H1	♣9425HD
IH D268 Diesel			Belt - A.C.; W/3/4" Belt T.W.	1232822H1	TR24414
Belt - Alt.		②♣9670HD	560		
510C			IH DT817C Diesel		
Dresser D240T Diesel			Belt - Fan & Alt.	670464C1	TR22578
Hose - Upper		②24428	Belt - Air Brake Compr.	672445C1	TR24538
Hose - Lower - Eng. To Pipe		24436	Belt - A.C.	670740C1	TR22570
515B			560B		
Dresser D359T Diesel			Cummins KT1150C Diesel		
Belt - Fan & Alt.	J911566	♣K080638HD	Belt - Alt.	1238776H1	K050370
Hose - Upper - Eng. To Pipe		24428	Belt - A.C.		TR22664
Hose - Upper - Pipe To Rad.		24432	570		
Hose - Lower - Eng. To Pipe		24436	Cummins VT1710 Diesel		
Hose - Lower - Pipe To Rad.		24444	Belt - Fan	1238446H1	♣K060615HD
IH D358 Diesel			Belt - W.P.	1259899H1	K050450
Belt - Alt.		②♣9680HD	630; 630W; 635		
520B			Case 6-Cyl. 358 Diesel		
Dresser D359T Diesel			Belt - Fan, Alt. & W.P.	3144098R91	②♣9660HD
Belt - Fan & Alt.	J911566	♣K080638HD	635B		
IH D358 Diesel			Dresser D359T Diesel		
Belt - Alt.		②♣9680HD	Belt - Fan & Alt.	1250454H1	♣K080560HD
IH DT358 Diesel			635E		
Belt - Fan & Alt.		②♣9690HD	Dresser D359T Diesel		
530			Belt - Fan & Alt.	1257784H1	♣K080550HD
Dresser D505T Diesel			635W		
Belt - Fan & Alt.		♣K080685HD	Case 6-Cyl. 358 Diesel		
Belt - A.C.	1251357H1	♣9425HD	Belt - Fan, Alt. & W.P.	3144098R91	②♣9660HD
Tensioner Assy. - Fan & Alt.	3978022	38504	640		
Hose - Upper		②24436	Case 6-Cyl. 358 Diesel		
Hose - Lower - Eng. To Pipe		21901	Belt - Fan, Alt. & W.P.	3139157R91	②♣9630HD
Hose - Lower - Pipe To Rad.		24448	645		
IH DT414 Diesel			Dresser D359TA Diesel		
Belt - Fan & Alt.	683548C91	②TR22664	Belt - Fan & Alt.	J911566	♣K080638HD
Belt - Air Brake Compr.		TR22770	970; 970 Turbo Articulated; 970C		
540			Cummins VTA28C Diesel		
Dresser D505T Diesel			Belt - Alt.		②♣9380HD
Belt - Fan & Alt.	1257778H1	♣K080685HD	Belt - A.C.		TR22461
Belt - A.C.	1251357H1	♣9425HD	Hose - Upper - Eng. To Pipe		24448
IH DT466 Diesel			Hose - Upper - Pipe To Rad.		24448
Belt - Fan & Alt.	683548C91	②TR22664	Hose - Lower - Eng. To Pipe		24456
Belt - Air Brake Compr.		TR22770	Hose - Lower - Pipe To Rad.		24456
550			Hose - By Pass		③24242
Cummins NTA855 Diesel			6200LC; 6220LC		
Belt - Fan	1238447H1	K060450	Komatsu 610T Diesel		
Belt - W.P.	1238934H1	♣K060435HD	Belt - Fan & Alt.	3911557	♣K080560HD
Belt - Alt.	1239751H1	K040460			
Belt - A.C.		♣9415HD			

♣Standard Belt Available.
③Three Required.

②Two Required.

Road & Construction
Equipment

Belts and Coolant Hose for Road & Construction Equipment

Application	Mfr. Part No.	Our No.	Application	Mfr. Part No.	Our No.
Dresser-Dressta - Continued			Dresser-Dressta - Continued		
D90C			S8		
Cummins V-6 200 Diesel			Detroit Diesel 3-53 Diesel		
Belt - Fan	178720	②TR24597	Belt - Fan		②♣9390HD
Belt - W.P.	178530	TR24365	Belt - W.P. & Alt.		②7410
Belt - Gen.	178571	TR22434	TD7C		
Hose - Upper		24236	IH D206 Diesel		
Hose - Lower		26520	1974 - 1969		
Detroit Diesel 6V-53 Diesel			Belt - Fan		
Belt - Fan	5136268	②♣9610HD		621770C1	♣9555HD
Hose - Upper - Eng. To Pipe		24236	TD7E Crawler		
Hose - Upper - Pipe To Rad.		24226	IH D239 Diesel		
D100B			1989 - 1974		
Cummins NT310CI Diesel			Belt - Fan		
Belt - Fan	178617	②TR30506		621770C1	♣9555HD
Belt - W.P.	178628	TR24438	TD7G Crawler		
Belt - Gen.	178599	TR22410	Dresser D240N Diesel		
Detroit Diesel 6V-71 Diesel			1994 - 1987		
Belt - Fan	5130662	③♣9580HD	Belt - Fan & Alt.		
D120C				1240873H1	♣K080560HD
Cummins NT310CI Diesel			TD8C		
Belt - Fan	178617	②TR30506	IH D239 Diesel		
Belt - W.P.	178628	TR24438	1973 - 1969		
Belt - Gen.	178599	TR22410	Belt - Fan		
Detroit Diesel 8V-71 Diesel				621770C1	♣9555HD
Belt - Fan	5130662	③♣9580HD	TD8E Crawler		
Hose - Upper		24236	IH DT239 Diesel		
Hose - Lower		24244	1989 - 1974		
D400			Belt - Fan		
Cummins V12-525-CI Diesel				621770C1	♣9555HD
Belt - Fan; W/57" Belt O.C.	178674	③TR28565	TD8G Crawler		
Belt - Fan; W/62 1/8" Belt O.C.	178629	③TR28616	Dresser D240T Diesel		
Belt - W.P.	178665	②TR28390	1994 - 1987		
Belt - Gen.	178613	TR22344	Belt - Fan & Alt.; W/56 5/8" Belt O.C.		
Detroit Diesel 12V-71 Diesel				1240873H1	♣K080560HD
Belt - Fan		③♣9570HD	Belt - Fan & Alt.; W/62 5/8" Belt O.C.		
D500				1257759H1	♣K080620HD
Cummins VT1710 Diesel			TD12 Crawler		
Belt - Fan	178578	③TR28706	IH D466B Diesel		
Belt - W.P.; W/38" Belt O.C.	125367	TR28376	1991 - 1985		
Belt - W.P.; W/39 1/2" Belt O.C.	178665	②TR28390	Belt - Fan & Alt.		
Belt - Alt.		②TR22350		1213134H91	②TR22664
Belt - Gen.	178613	TR22344	TD12B		
Hose - Upper - Eng. To Pipe		24448	Dresser D505N Diesel		
Hose - Upper - Pipe To Rad.		24440	1989		
Hose - Lower - Eng. To Pipe		24448	Belt - Fan & Alt.		
Hose - Lower - Pipe To Rad.		24452		1257778H1	♣K080685HD
Detroit Diesel 16V-71 Diesel			TD15B		
Belt - Fan	5133768	②♣9640HD	IH DT407 Diesel		
S7			1972 - 1963		
Detroit Diesel 3-53 Diesel			Belt - Fan & Alt.		
Belt - Fan		②♣9390HD		612134C11	TR24688
Ford 4-Cyl. 172			TD15C Articulated Crawler		
Belt - Fan	207463H1	♣9425HD	Dresser D505T Diesel		
Ford 4-Cyl. 172 Diesel			2001 - 1972		
Belt - Fan	206307H1	♣9415HD	Belt - Fan & Alt.		
				1257762H1	♣K080605HD
			TD15C Crawler		
			Dresser D505T Diesel		
			2001 - 1972		
			Belt - Fan & Alt.		
				1257770H1	♣K080610HD
			IH DT466 Diesel		
			2001 - 1972		
			Belt - Alt.; Ser. No. 17399 & Before		
				673481C1	TR22648
			Belt - Alt.; Ser. No. 17400 & After		
				1213134H91	②TR22664

♣Standard Belt Available.
③Three Required.

②Two Required.

Belts and Coolant Hose for Road & Construction Equipment

Application	Mfr. Part No.	Our No.	Application	Mfr. Part No.	Our No.
Dresser-Dressta - Continued			Dresser-Dressta - Continued		
TD15E Crawler			TD40 Crawler		
Dresser D505T Diesel			Cummins KTA1150C Diesel		
2000 - 1986			1993 - 1991		
Belt - Fan & Alt.	1253462H1	♣K080670HD	Belt - Alt.	1238776H1	K050370
Belt - A.C.	1251357H1	♣9425HD	Belt - A.C.		TR22664
Hose - Upper - Eng. To Pipe		24436	TD40B Crawler		
Hose - Upper - Pipe To Rad.		24436	Cummins KTA19C Diesel		
Hose - Lower - Eng. To Pipe		♣21473	1998 - 1989		
IH DT466C Diesel			Belt - Alt.		
2000 - 1986			1238776H1		
Belt - Fan & Alt.	1213134H91	②TR22664	Belt - A.C.		
TD20B			TR22664		
IH DT429 Diesel			Dresser-Galion		
1970 - 1963			3-5 Ton; 4-6 TON		
Belt - Fan & Alt.	670741C1	②TR22570	Continental Y112		
Belt - Fan & Gen.	1800001C91	②TR22578	Belt - Fan		
Belt - W.P.	328502R1	TR22485	Y112K368		
TD20C			Belt - Gen.		
IH DV573B Diesel			Y112K367		
1975 - 1970			♣9451HD		
Belt - Fan	673946C91	④TR22752	♣9415HD		
Belt - Alt.; Ser. No. 7500 & After	673947C1	♣9447HD	Waukesha VRG155		
TD20E Crawler			Belt - Fan		
IH DVT800 Diesel			RD50739		
1988 - 1974			TR22386		
Belt - Fan	673946C91	④TR22752	Belt - Hyd. Pump		
Belt - Alt.; Ser. No. 30277 & Before	683723C1	♣9476HD	R20011		
Belt - Alt.; Ser. No. 30278 & After	673029C1	♣9470HD	TR28423		
Belt - A.C.		♣9680HD	5 Ton		
TD20G Crawler			IH UD281.4 Diesel		
Cummins LTA10C Diesel			Belt - Gen.		
1998 - 1987			52318DA		
Belt - Fan	1246274H1	♣K080605HD	9279		
Belt - Alt.	1246253H1	K050317	5-8 Ton; 8-10 Ton		
Belt - A.C.		TR24562	Continental F162		
TD25B			Belt - Fan		
IH DT817B Diesel			RD40434		
1978 - 1962			TR24465		
Belt - Fan & Gen.	403348R1	♣9463HD	Belt - Hyd. Pump		
TD25C			R20011		
IH DT817C Diesel			TR28423		
1978 - 1968			Hose - Upper		
Belt - Alt.	326998R1	②TR22570	24220		
TD25E Crawler			Hose - Lower		
IH DT817C Diesel			24224		
1988 - 1979			Continental F226		
Belt - Fan & Alt.; Ser. No. 12007 & Before		TR22517	Belt - Fan		
Belt - Fan & Alt.; Ser. No. 12008 & After	326998R1	②TR22570	R30767		
TD25G Crawler			Belt - Hyd. Pump		
Cummins KT19C Diesel			R20011		
2001 - 1985			TR24476		
Belt - Alt.	1238776H1	K050370	TR28423		
Belt - A.C.		TR22664	IH UB220		
Hose - Upper - Eng. To Pipe		②24440	Belt - Fan & Gen.		
Hose - Upper - Pipe To Rad.		②24440	TR24578		
			Belt - Hyd. Pump		
			R20011		
			TR28423		
			Hose - Upper		
			26511		
			Hose - Lower		
			26511		
			IH UD6 Diesel; IH UD6A Diesel		
			Belt - Fan		
			16131D		
			TR30467		
			Belt - Hyd. Pump		
			R20011		
			TR28423		
			8-12 Ton; 10-14 Ton		
			IH UD9 Diesel; IH UD350 Diesel		
			Belt - Fan		
			48042DA		
			TR30484		
			Belt - Gen.		
			54857DA		
			9300		
			Belt - Hyd. Pump		
			R20011		
			TR28423		
			14-20 Ton		
			Continental M330		
			Belt - Fan & Gen.		
			RD34611		
			TR24562		
			Belt - Hyd. Pump		
			R20011		
			TR28423		
			80		
			IH UB264; IH UC263; IH UD282		
			Belt - Fan & Alt.		
			151532R1		
			②7512		
			Hose - Upper		
			26509		
			Hose - Lower		
			26512		
			85RM2		
			Case 4-Cyl. 188		
			Hose - Upper		
			25477		
			Hose - Lower		
			25530		

♣Standard Belt Available.
②Two Required.

♣Cut to Fit.
④Four Required.

Belts and Coolant Hose for Road & Construction Equipment

Application	Mfr. Part No.	Our No.	Application	Mfr. Part No.	Our No.
Dresser-Galion - Continued			Dresser-Galion - Continued		
85RM2 - Continued			118C - Continued		
Case 4-Cyl. 188 Diesel			Detroit Diesel 4-71 Diesel - Continued		
Hose - Upper		25480	Hose - Upper		26509
Hose - Lower		25530	Hose - Lower		26516
Continental F163			125; 125A		
Belt - Fan & Gen.	80928	♣9425HD	Detroit Diesel 4-71 Diesel		
Belt - P.S.	74799	7425	Belt - Fan		♣9470HD
Hose - Upper; W/12" Hose		25474	Belt - W.P. & Alt.		7410
Hose - Upper; W/20" Hose		25480	Hose - Upper		26510
Hose - Lower		25480	Hose - Lower		26529
Ford 4-Cyl. 172 Diesel; Ford 4-Cyl. 220 Diesel			IH UB264		
Hose - Upper; W/12" Hose		25474	Belt - Fan		♣9463HD
Hose - Upper; W/20" Hose		25480	Belt - W.P. & Alt.		♣9451HD
Hose - Lower		25484	Hose - Upper		26511
104			Hose - Lower		26511
Cummins J6 Diesel			150		
Belt - Fan	S1792	②TR22405	Detroit Diesel 4-53N Diesel		
Cummins J6BI Diesel			Belt - Fan & W.P.		②TR22570
Belt - Fan	106258	②♣9365HD	Belt - Alt.		♣9330HD
Belt - Gen.	112203	TR24449	Hose - Upper		26517
Cummins NH6-4BI Diesel			Hose - Lower - Pipe To Pipe		♣20206
Belt - Fan	S1792	②TR22405		or	26507
Detroit Diesel 3-71 Diesel			Hose - Lower - Pipe To Rad.		♣20206
Belt - Fan	5170972	②TR22455		or	26507
Hose - Upper		26509	150A		
IH UD14A Diesel			Detroit Diesel 4-53N Diesel		
Belt - Fan	30982D	TR32571	Belt - Fan	89816	②♣9476HD
Belt - Gen.	54857DA	9300	KDC 359T Diesel		
Belt - Hyd. Pump	D23474	TR28390	Belt - Fan & Alt.; W/59 5/8" Belt O.C.	1250637H1	♣K080590HD
Hose - Upper		24236	Belt - Fan & Alt.; W/62 5/8" Belt O.C.	1257759H1	♣K080620HD
Hose - Lower		26509	150F		
118			Cummins 6BTA Diesel		
Cummins H743C Diesel			Belt - Fan & Alt.		♣K080630HD
Belt - Fan		②TR24457	Hose - Upper		②24232
Belt - Alt.		TR22392	Hose - Lower		26523
Cummins NH6-4BI Diesel			150FA		
Belt - P.S.	D51276	TR28596	Detroit Diesel 4-53N Diesel		
Hose - Upper		26509	Belt - Fan	89816	②♣9476HD
Hose - Lower		26531	KDC 359T Diesel		
Detroit Diesel 3-71 Diesel			Belt - Fan & Alt.; W/59 5/8" Belt O.C.	1250637H1	♣K080590HD
Belt - Fan	5170972	②TR22455	Belt - Fan & Alt.; W/62 5/8" Belt O.C.	1257759H1	♣K080620HD
Hose - Upper		26509	160		
Hose - Lower		26516	Cummins H6BI Diesel; Cummins HC6I Diesel		
Detroit Diesel 4-71 Diesel			Belt - Fan	70524	②TR22410
Belt - Fan	5176420	②TR22588	Belt - W.P.	70524	②TR22410
Belt - Gen.	3224367	TR28390	Belt - P.S.	D51276	TR28596
Hose - Upper		26509	Belt - Hyd. Pump	D50926	TR28628
Hose - Lower		26516	Detroit Diesel 3-71 Diesel		
IH UD16 Diesel			Belt - P.S.	D51277	TR28412
Belt - Fan & Gen.	251753R11	②TR28616	160RF2		
IH UD525 Diesel; IH UD554 Diesel			Detroit Diesel 3-53 Diesel		
Belt - Fan & Gen.	251753R11	②TR28616	Belt - Fan	205839	②7425
Hose - Upper		26531	Belt - V.P.	208005	②♣9510HD
Hose - Lower		24236	Hose - Upper		26509
118C			Hose - Lower		20685
Detroit Diesel 4-71 Diesel			IH D282 Diesel		
Belt - Fan	5176420	②TR22588	Hose - Upper		26511
Belt - Gen.	3224367	TR28390			

♣Standard Belt Available.
 ⓧCut to Fit.

②Two Required.

Belts and Coolant Hose for Road & Construction Equipment

Application	Mfr. Part No.	Our No.	Application	Mfr. Part No.	Our No.
Dresser-Galion - Continued			Dresser-Galion - Continued		
160RF2 - Continued			303 - Continued		
IH D282 Diesel - Continued			IH UB282		
Hose - Lower		26509	Hose - Upper		26509
IH UC263			IH UD6 Diesel		
Hose - Upper		26511	Belt - Fan	69490DA	TR30467
Hose - Lower		26508	Belt - Gen.	54857DB	9300
200RF2			IH UD281.4 Diesel		
Cummins V352 Diesel			Belt - Fan		
Belt - V.P.	83343	▲9400HD	Belt - Gen.	16131DA	TR28454
Hose - Upper		26512		54857DB	9300
Detroit Diesel 4-53 Diesel			IH UD282 Diesel		
Belt - Alt.	205839	7425	Hose - Upper		26509
Belt - P.S.	81958	▲9350HD	503A		
Belt - V.P.	208005	▲9510HD	IH UD236 Diesel		
Hose - Upper		26511	Hose - Upper		26510
Hose - Lower		26509	Hose - Lower		≧20611
IH 6-Cyl. 301			503L		
Belt - Fan & Alt.	81044	▲9490HD	Continental F162		
Belt - P.S.	81914	7500	Belt - Fan & Gen.	F162K208	②TR22386
IH UC301			Continental F226		
Hose - Upper		26511	Belt - Fan & Gen.		TR24461
Hose - Lower		26512	IH UD236 Diesel		
Perkins 6-Cyl. 354			Belt - Fan		
Belt - V.P.	82753	▲9570HD	Belt - W.P. & Alt.	149635R2	▲9463HD
Hose - Upper		26512		304436R1	▲9505HD
220S			708		
Detroit Diesel 6V-53N Diesel			Dresser D240T Diesel		
Belt - Fan	5126763	②▲9400HD	Belt - Fan & Alt.	1257759H1	▲K080620HD
Belt - W.P.		②7370	Hose - Upper - Eng. To Pipe		24224
Belt - Alt.	D126431	②7410	Hose - Upper - Pipe To Rad.		24224
Hose - Upper		②26612	Hose - Lower		24440
Hose - Lower		24932	710; 712; 714		
Hose - By Pass		24218	Dresser D240T Diesel		
250RF2			Belt - Fan & Alt.		
Cummins V352 Diesel			Belt - Fan & Alt.	1257759H1	▲K080620HD
Belt - V.P.	83343	▲9400HD	830		
Hose - Upper		26512	Dresser D359T Diesel		
Detroit Diesel 4-53 Diesel			Belt - Fan & Alt.		
Belt - Alt.	205839	7425	Belt - Fan & Alt.	1240874H1	K080655
Belt - P.S.	81958	▲9350HD	850; 870		
Belt - V.P.	208005	▲9510HD	Dresser D505T Diesel		
Hose - Upper		26511	Belt - Fan & Alt.; W/71 5/8" Belt O.C.	1257782H1	▲K080710HD
Hose - Lower		26509	Belt - Fan & Alt.; W/72 5/8" Belt O.C.	1257783H1	▲K080720HD
IH 6-Cyl. 301			Belt - Fan To Hyd. Pump		▲9400HD
Belt - Fan & Alt.	81044	▲9490HD	Hose - Upper		26517
Belt - P.S.	81914	7500	Hose - Lower - Eng. To Pipe		21901
IH UC301			Hose - Lower - Pipe To Rad.		24432
Hose - Upper		26511	A400E		
Hose - Lower		26512	IH D466 Diesel		
Perkins 6-Cyl. 354			Belt - Fan & Alt.		
Belt - V.P.	82753	▲9570HD	Belt - Fan & Alt.	120304	②TR22648
Hose - Upper		26512	A450E		
303			Dresser D359T Diesel		
IH U281			Belt - Fan & Alt.		
Belt - Fan	16131DA	TR28454	Belt - Fan & Alt.	1240874H1	K080655
Belt - Gen.	49341D	▲9335HD	IH D466 Diesel		
			Belt - Fan & Alt.		
			Belt - Fan & Alt.	120304	②TR22648
			A500		
			IH D466 Diesel		
			Belt - Fan & Alt.		
			Belt - Fan & Alt.	120304	②TR22648

▲Standard Belt Available.
≧Cut to Fit.

②Two Required.

Belts and Coolant Hose for Road & Construction Equipment

Application	Mfr. Part No.	Our No.	Application	Mfr. Part No.	Our No.
Dresser-Galion - Continued			Dresser-Galion - Continued		
A550			RP60		
IH DT466 Diesel			Waukesha 6-Cyl. Diesel		
Belt - Fan & Alt.		②TR22657	Belt - Fan		♣9640HD
Hose - Upper		26517	Belt - Hyd. Pump		9300
Hose - Lower		24236	Belt - Upper		26517
A560E			Hose - Lower - Eng. To Pipe		
IH D466 Diesel			Hose - Lower - Pipe To Rad.		
Belt - Fan & Alt.	120304	②TR22648	Rubber Tire Compactor		
Hose - Upper		26517	IH UB220		
Hose - Lower		24436	Belt - Fan & Alt.	274705R1	TR28445
A600			Belt - Gov.		7380
Dresser D505T Diesel			Belt - Hyd. Pump	RD53075	TR28346
Belt - Fan & Alt.	1257782H1	♣K080710HD	S5-8A; S8-10.5A; S8-12A; S10-14A		
IH DT466 Diesel			Cummins 4-Cyl. 3.9 L Diesel		
Belt - Fan & Alt.		②TR22657	Belt - Fan & Alt.		
Hose - Upper		26525	1257759H1		
Hose - Lower		24440	♣K080620HD		
A606			Detroit Diesel 3-53 Diesel		
Dresser D505T Diesel			Belt - Fan		
Belt - Fan & Alt.	1257782H1	♣K080710HD	88834		
IH DT466 Diesel			Belt - Alt.		
Belt - Fan & Alt.		②TR22657	126431		
CHIEF			T400A		
Continental F226			IH UD407 Diesel		
Belt - Fan & Gen.	A600K206	TR24424	Belt - Fan & Alt.; W/Single Belt		
Belt - Hyd. Pump	R20011	TR28423	Belt - Fan & Alt.; W/Dual Belts		
Continental F244; Continental FA244			Hose - Upper		
Belt - Fan	RD40434	TR24465	Hose - Lower		
Belt - Hyd. Pump	R20011	TR28423	Hose - By Pass		
Continental HD260 Diesel			T500		
Belt - Fan	RD43268	TR24500	Cummins C160CI Diesel		
Belt - Hyd. Pump	R20011	TR28423	Belt - Fan		
Cummins J4BT Diesel			124466		
Belt - Fan & W.P.	118637	②♣9440HD	Belt - W.P.		
Hercules WXLC3			178437		
Belt - Gen.	54857DA	9300	Belt - Alt.		
IH UD14A Diesel			178450		
Belt - Fan & W.P.	30982DA	TR32571	Hose - Upper		
Belt - Gen.	54857DB	9300	Hose - Lower		
CR-D			Cummins JN6BI Diesel		
IH UD282 Diesel			Belt - Fan		
Belt - Fan & Alt.		♣9505HD	70888		
Belt - Hyd. Pump		TR28423	Belt - W.P.		
Hose - Upper		26508	Belt - Gen.; W/49 3/8" Belt O.C.		
Hose - Lower		26512	Belt - Gen.; W/50" Belt O.C.		
K1D			Belt - P.S.		
IH UD16 Diesel			D51277		
Belt - Fan	251753R21	②TR28616	Cummins JT6B Diesel		
Pneumatic Tire Roller			Belt - Fan		
IH UB220			70888		
Belt - P.S.	RD53075	TR28346	Belt - W.P.		
Belt - Gov.	RD57423	7380	Belt - Gen.		
Hose - Upper		♣20611	Belt - P.S.		
		26509	D51277		
Hose - Lower		26510	T500A		
T500L			IH DT407 Diesel		
IH DT407 Diesel			Belt - Fan & Gen.		
Belt - Fan & Alt.; W/Single Belt		TR22664	Belt - Fan & Gen.		
Belt - Fan & Alt.; W/Dual Belts		②TR22664	Hose - Upper		
Hose - Upper		26517	Hose - Lower		
Hose - Lower - Eng. To Pipe		26523	T500C		
Hose - Lower - Pipe To Rad.		24236	IH D466 Diesel		
T500L			Belt - Fan & Alt.		
IH DT407 Diesel			673409C1		
Belt - Fan & Alt.; W/Single Belt		TR22664	②TR22648		
Belt - Fan & Alt.; W/Dual Belts		②TR22664	T500L		
Hose - Upper		26517	IH DT407 Diesel		
Hose - Lower - Eng. To Pipe		26523	Belt - Fan & Alt.; W/Single Belt		
Hose - Lower - Pipe To Rad.		24236	Belt - Fan & Alt.; W/Dual Belts		

②Two Required.
♣Cut to Fit.

♣Standard Belt Available.

Belts and Coolant Hose for Road & Construction Equipment

Application	Mfr. Part No.	Our No.	Application	Mfr. Part No.	Our No.
Dresser-Galion - Continued			Dresser-Galion - Continued		
T500L - Continued			VOS66A - Continued		
IH DT407 Diesel - Continued			Dresser D240T Diesel		
Hose - By Pass		≈20573	Belt - Fan	135009	②♣9490HD
T600			Belt - Alt.	126431	②7410
Cummins JB15 Diesel			VOS84A		
Belt - Fan	106258	②♣9365HD	Detroit Diesel 4-53N Diesel		
Belt - Gen.	101426	TR22443	Belt - Fan	89816	②♣9476HD
Belt - P.S.	D51277	TR28412	Belt - Alt.	126431	②7410
Cummins JBS600 Diesel			VOSA66A		
Belt - Fan		♣9375HD	Dresser D240T Diesel		
Belt - Gen.	101426	TR22443	Belt - Fan	135009	②♣9490HD
Belt - P.S.	D51277	TR28412	Belt - Alt.	126431	②7410
Cummins JNS6BI Diesel			VOSA84A		
Belt - Fan	124421	②TR24365	Detroit Diesel 4-53N Diesel		
Belt - Gen.	S1944	TR22443	Belt - Fan	89816	②♣9476HD
Belt - P.S.	D51277	TR28412	Belt - Alt.	126431	②7410
Cummins JS6BI Diesel			VOSD66A		
Belt - Fan		②♣9365HD	Dresser D240T Diesel		
Belt - Gen.	112203	TR24449	Belt - Fan	135009	②♣9490HD
Belt - P.S.	D51277	TR28412	Belt - Alt.	126431	②7410
T700			VOSD84A		
Cummins HRF6BI Diesel			Detroit Diesel 4-53N Diesel		
Belt - Fan	S3115	②TR28492	Belt - Fan	89816	②♣9476HD
Belt - Gen.	S3095	TR24400	Belt - Alt.	126431	②7410
TH8-12D			VOSPD66A		
Hercules WXC; Hercules WXLC			Dresser D240T Diesel		
Hose - Upper		25480	Belt - Fan	135009	②♣9490HD
Hose - Lower		25478	Belt - Alt.	126431	②7410
IH UD282 Diesel			VOSPD84A		
Belt - Fan & Alt.		♣9505HD	Detroit Diesel 4-53 Diesel		
Belt - Hyd. Pump		TR28423	Hose - Lower		26509
Hose - Upper		26507	Detroit Diesel 4-53N Diesel		
Hose - Lower		26513	Belt - Fan	89816	②♣9476HD
TH8-12G			Belt - Alt.	126431	②7410
IH UB264			VOST2-42A		
Belt - Fan & Alt.	274705R1	TR28445	Dresser D140N Diesel		
Belt - Gov.		7380	Belt - Fan & Alt.	156051	②7470
Belt - Hyd. Pump		TR28376	Belt - P.S.	155936	7312
Hose - Upper		26508	VR84H		
Hose - Lower		26513	IH UD407 Diesel		
Hose - By Pass		20338	Belt - Fan & Alt.	612134C1	TR22692
VOS2-42A			Belt - Hyd. Pump	D104126	②♣9435HD
Dresser D140N Diesel			Hose - Upper		26517
Belt - Fan & Alt.	156051	②7470	Hose - Lower		26517
Belt - P.S.	155936	7312	Warrior		
VOS2-66B			Continental F162		
Dresser D359T Diesel			Belt - Fan & Gen.	RD40434	TR24465
Belt - Fan	89816	②♣9476HD	Belt - Hyd. Pump	R20011	TR28423
Belt - Alt.	69437	7410	Hercules WXLC3		
VOS66A			Belt - Fan & Gen.; W/P.S.	76305A	TR28565
Detroit Diesel 3-53 Diesel			Belt - Fan & Gen.; W/O P.S.	40278A	TR28483
Belt - Fan		②♣9490HD	IH UD6 Diesel		
Belt - W.P. & Alt.		②7410	Belt - Gen.	54857DA	9300
Belt - Hyd. Pump		7370	Belt - Hyd. Pump	R20011	TR28423
Hose - Upper		26515			
Hose - Lower		26523			

♣Standard Belt Available.

②Two Required.

Road & Construction Equipment

Belts and Coolant Hose for Road & Construction Equipment

Application	Mfr. Part No.	Our No.	Application	Mfr. Part No.	Our No.
Dresser-Hough			Dresser-Hough - Continued		
510			550 - Continued		
IH D268 Diesel			IH DVT800 Diesel		
Belt - Fan & Alt.	683826C1	②♣9670HD	Belt - Fan	673949C91	②TR22692
Hose - Upper - Eng. To Pipe		24432	Belt - Alt.	686613C91	②♣9530HD
Hose - Upper - Pipe To Rad.		24432	555		
Hose - Lower - Eng. To Pipe		24436	Cummins NTA855 Diesel		
Hose - Lower - Pipe To Rad.		24436	Belt - Fan	1238447H1	K060450
510B			Belt - W.P.	1238934H1	♣K060435HD
IH D268 Diesel			Belt - A.C.; W/1/2" Belt T.W.	1251357H1	♣9425HD
Belt - Alt.	683826C1	②♣9670HD	Belt - A.C.; W/3/4" Belt T.W.	1232822H1	TR24414
510C			560		
Dresser D240T Diesel			IH DT817 Diesel		
Hose - Upper		②24428	Hose - Upper - Eng. To Pipe		24444
Hose - Lower - Eng. To Pipe		24436	Hose - Upper - Pipe To Rad.		24444
515			Hose - Lower - Eng. To Pipe		24456
IH D358 Diesel			Hose - Lower - Pipe To Rad.		24456
Belt - Fan & Alt.	673417C1	②TR22648	IH DT817B Diesel		
515B			Belt - Alt.	670464C1	TR22578
Dresser D359T Diesel			Belt - A.C.	670741C1	②TR22570
Belt - Fan & Alt.	J911566	♣K080638HD	IH DT817C Diesel		
Hose - Upper - Eng. To Pipe		24428	Belt - Fan & Alt.	670464C1	TR22578
Hose - Upper - Pipe To Rad.		24432	Belt - Air Brake Compr.	672445C1	TR24538
Hose - Lower - Eng. To Pipe		24436	Belt - A.C.	670740C1	TR22570
Hose - Lower - Pipe To Rad.		24444	560B		
IH D358 Diesel			Cummins KT1150C Diesel		
Belt - Alt.		②♣9680HD	Belt - Alt.	1238776H1	K050370
520B			Belt - A.C.		TR22664
Dresser D359T Diesel			570		
Belt - Fan & Alt.	J911566	♣K080638HD	Cummins VT1710 Diesel		
IH D358 Diesel			Belt - Fan	1238446H1	♣K060615HD
Belt - Alt.		②♣9680HD	Belt - W.P.	1259899H1	K050450
IH DT358 Diesel			580		
Belt - Fan & Alt.		②♣9690HD	Detroit Diesel 16V-149 Diesel		
530			Hose - Upper		
Dresser D505T Diesel			24272		
Belt - Fan & Alt.		♣K080685HD	D90C		
Belt - A.C.	1251357H1	♣9425HD	IH DT573 Diesel		
Hose - Upper		②24436	Belt - Fan	328927R11	TR28680
Hose - Lower - Eng. To Pipe		21901	Belt - W.P.	345013R1	TR22455
Hose - Lower - Pipe To Rad.		24448	Belt - Gen. & Air Brake Compr.	341190R1	TR22474
IH DT414 Diesel			Hose - Upper		24236
Belt - Fan & Alt.	683548C91	②TR22664	Hose - Lower		24248
Belt - Air Brake Compr.		TR22770	D100B		
540			IH D817 Diesel		
Dresser D505T Diesel			Belt - Gen.	323987R1	♣9465HD
Belt - Fan & Alt.	1257778H1	♣K080685HD	Belt - Air Brake Compr.; W/50 5/8" Belt		
Belt - A.C.	1251357H1	♣9425HD	O.C.	601684C1	TR24500
IH DT466 Diesel			Belt - Air Brake Compr.; W/51 7/8" Belt		
Belt - Fan & Alt.	683548C91	②TR22664	O.C.	278714R1	TR24515
Belt - Air Brake Compr.		TR22770	Hose - Upper		24948
550			Hose - Lower - Eng. To Pipe		24256
Cummins NTA855 Diesel			Hose - Lower - Pipe To Rad.		24256
Belt - Fan	1238447H1	K060450	D120C		
Belt - W.P.	1238934H1	♣K060435HD	IH DT817 Diesel		
Belt - Alt.	1239751H1	K040460	Belt - Gen.	323987R1	♣9465HD
Belt - A.C.		♣9415HD	Belt - Air Brake Compr.; W/50 5/8" Belt		
			O.C.	601684C1	TR24500
			Belt - Air Brake Compr.; W/51 7/8" Belt		
			O.C.	278714R1	TR24515

♣Standard Belt Available.

②Two Required.

Belts and Coolant Hose for Road & Construction Equipment

Application	Mfr. Part No.	Our No.	Application	Mfr. Part No.	Our No.
Dresser-Hough - Continued			Dresser-Hough - Continued		
D120C - Continued			H30		
IH DT817 Diesel - Continued			Detroit Diesel 3-53 Diesel		
Hose - Upper		24946	Belt - Fan	5126447	②▲9350HD
Hose - Lower - Eng. To Pipe		24256	Belt - W.P. & Gen.		②7430
Hose - Lower - Pipe To Rad.		24256	Hose - Upper		24232
D400				or	26507
Detroit Diesel 12V-71 Diesel			Hose - Lower		26507
Belt - Fan		③▲9570HD	Hercules QXD3		
D500			Hose - Lower		≈<20206
Cummins VT1710 Diesel			IH 4-Cyl. 263		
Belt - Fan	178578	③TR28706	Belt - Fan & Gen.	372596R1	▲9480HD
Belt - W.P.; W/38" Belt O.C.	125367	TR28376	Belt - Fan, W.P. & Gen.	378113R2	▲9480HD
Belt - W.P.; W/39 1/2" Belt O.C.	178665	②TR28390	Hose - Upper		26509
Belt - Alt		②TR22350	Hose - Lower		26508
Belt - Gen.	178613	TR22344	IH D236 Diesel		
Hose - Upper - Eng. To Pipe		24448	Belt - Fan & Alt	670261C1	▲9500HD
Hose - Upper - Pipe To Rad.		24440	Belt - Fan & Gen.	304436R1	▲9505HD
Hose - Lower - Eng. To Pipe		24448	Hose - Upper		26509
Hose - Lower - Pipe To Rad.		24452	Hose - Lower		26509
H12			IH U240		
IH UD350 Diesel			Hose - Upper		26509
Belt - Fan	48042DA	TR30484	Hose - Lower		26508
Belt - Gen.	54857DB	9300	H30A		
H25			Detroit Diesel 3-53 Diesel		
IH 4-Cyl. 153			Belt - Fan	5126447	②▲9350HD
Belt - Fan	149636R2	▲9480HD	Belt - W.P. & Gen.		②7430
Belt - W.P. & Alt.		7440	Hose - Upper		24232
IH D188 Diesel				or	26507
Belt - Fan	149636R2	▲9480HD	Hose - Lower		26507
Belt - W.P. & Gen.	315969R1	▲9490HD	Hercules QXD3		
Waukesha 180DLC Diesel			Belt - Fan	109847	TR30467
Belt - Fan		▲9455HD	Hose - Lower		≈<20206
Belt - W.P. & Gen.	190303	②▲9425HD	IH 4-Cyl. 263		
Hose - Upper		25476	Belt - Fan & Gen.	372596R1	▲9480HD
Hose - Lower		25476	Hose - Upper		26509
Waukesha 180GKB			Hose - Lower		26508
Belt - Fan		▲9455HD	IH D236 Diesel		
Belt - W.P. & Gen.	190303	②▲9425HD	Belt - Fan & Alt	670261C1	▲9500HD
Waukesha 180GLB			Belt - Fan & Gen.	304436R1	▲9505HD
Hose - Upper		25476	Hose - Upper		26509
Hose - Lower		25476	Hose - Lower		26509
H25B			IH U240		
IH 4-Cyl. 153			Belt - Fan & Gen.		TR28445
Belt - Fan	149636R2	▲9480HD	Hose - Upper		26509
Belt - Alt./Gen.	349175R1	7440	Hose - Lower		26508
Belt - W.P. & Alt.		7440	IH UD236 Diesel		
Hose - Upper		26509	Belt - Fan & Gen.	304436R1	▲9505HD
Hose - Lower - Eng. To Pipe		24222	IH UD240 Diesel		
Hose - Lower - Pipe To Rad.		24232	Belt - Fan & Gen.		TR28445
IH D188 Diesel			H30B		
Belt - Fan		▲9480HD	Detroit Diesel 3-53 Diesel		
Belt - Gen. & W.P.; Ser. No. 6800 & Before .	315969R1	▲9490HD	Belt - Fan	5126447	②▲9350HD
Belt - Gen. & W.P.; Ser. No. 6801 & After ...	672908C1	▲9485HD	Belt - W.P. & Gen.		②7430
Hose - Upper		26509	Hose - Upper		24232
Hose - Lower		26509		or	26507
Waukesha 180GKB			Hose - Lower		26507
Belt - Fan		▲9455HD	Hercules QXD3		
Belt - W.P. & Gen.	190303	②▲9425HD	Hose - Lower		≈<20206

▲Standard Belt Available.
②Two Required.

③Three Required.
≈<Cut to Fit.

Belts and Coolant Hose for Road & Construction Equipment

Application	Mfr. Part No.	Our No.	Application	Mfr. Part No.	Our No.
Dresser-Hough - Continued			Dresser-Hough - Continued		
H30B - Continued			H30R - Continued		
IH 4-Cyl. 263			IH 4-Cyl. 263 - Continued		
Belt - Fan & Gen.	372596R1	♣9480HD	Hose - Lower		26508
Belt - Fan, W.P. & Gen.	378113R2	♣9480HD	IH D236 Diesel		
Hose - Upper		26509	Belt - Fan & Alt.	670261C1	♣9500HD
Hose - Lower		26508	Belt - Fan & Gen.	304436R1	♣9505HD
IH D236 Diesel			Hose - Upper		26509
Belt - Fan & Alt.	670261C1	♣9500HD	Hose - Lower		26509
Belt - Fan & Gen.	304436R1	♣9505HD	IH U240		
Hose - Upper		26509	Belt - Fan & Gen.		TR28445
Hose - Lower		26509	Hose - Upper		26509
IH U240			Hose - Lower		26508
Belt - Fan, W.P. & Gen.	274705R1	TR28445	IH UD236 Diesel		
Hose - Upper		26509	Belt - Fan & Gen.	304436R1	♣9505HD
Hose - Lower		26508	IH UD240 Diesel		
H30F			Belt - Fan & Gen.		TR28445
Detroit Diesel 3-53 Diesel			H30RB		
Belt - Fan	5126447	②♣9350HD	IH 4-Cyl. 263		
Belt - W.P. & Gen.		②7430	Belt - Fan & Gen.	372596R1	♣9480HD
Hose - Upper		24232	H40		
		26507	IH 4-Cyl. 264		
Hose - Lower		26507	Belt - Fan	274705R1	TR28445
Hercules QXD3			IH D282 Diesel		
Belt - Fan	109847	TR30467	Belt - Fan; Ser. No. 17BH-2286 & After	149636R1	♣9480HD
Hose - Lower		≧20206	Belt - W.P. & Gen.; Ser. No. 17BH-2286 & After	601379C1	♣9510HD
IH 4-Cyl. 263			Belt - Fan & Gen.; Ser. No. 17BH-2285 & Before	304436R1	♣9505HD
Belt - Fan & Gen.	372596R1	♣9480HD	IH U240		
Hose - Upper		26509	Belt - Fan & Gen.	155836	TR28445
Hose - Lower		26508	Belt - Air Brake Compr.	176106	♣9415HD
IH D236 Diesel			Hose - Upper - Eng. To Pipe		24230
Belt - Fan & Alt.	670261C1	♣9500HD	Hose - Upper - Pipe To Rad.		24230
Belt - Fan & Gen.	304436R1	♣9505HD	Hose - Lower		26509
Hose - Upper		26509	IH UD236 Diesel		
Hose - Lower		26509	Belt - Fan & Gen.	304436R1	♣9505HD
IH U240			Belt - Air Brake Compr.	191615	♣9400HD
Belt - Fan & Gen.		TR28445	Hose - Upper - Eng. To Pipe		24230
Hose - Upper		26509	Hose - Upper - Pipe To Rad.		24230
Hose - Lower		26508	Hose - Lower		26508
IH UD236 Diesel			H50		
Belt - Fan & Gen.	304436R1	♣9505HD	Detroit Diesel 3-53 Diesel		
IH UD240 Diesel			Belt - Fan	5137300	②♣9390HD
Belt - Fan & Gen.		TR28445	IH 4-Cyl. 263		
H30FB			Belt - Fan & Gen.	372596R1	♣9480HD
IH 4-Cyl. 263			Belt - Air Brake Compr.	176106	♣9415HD
Belt - Fan & Gen.	372596R1	♣9480HD	IH U264		
H30R			Belt - Fan		TR28445
Detroit Diesel 3-53 Diesel			Belt - Fan & Gen.	155836	TR28445
Belt - Fan	5126447	②♣9350HD	Belt - Air Brake Compr.	176106	♣9415HD
Belt - W.P. & Gen.		②7430	Hose - Upper		26509
Hose - Upper		24232	Hose - Lower		26509
		26507	IH UD282 Diesel		
Hose - Lower		26507	Belt - Fan; Ser. No. 17BH-2286 & After	149636R1	♣9480HD
Hercules QXD3			Belt - W.P. & Gen.; Ser. No. 17BH-2286 & After	612089C1	♣9510HD
Belt - Fan	109847	TR30467	Belt - Fan & Gen.; Ser. No. 17BH-2285 & Before	304436R1	♣9505HD
Hose - Lower		≧20206	Belt - Air Brake Compr.	176106	♣9415HD
IH 4-Cyl. 263					
Belt - Fan & Gen.	372596R1	♣9480HD			
Hose - Upper		26509			

♣Standard Belt Available.
≧Cut to Fit.

②Two Required.

Belts and Coolant Hose for Road & Construction Equipment

Application	Mfr. Part No.	Our No.	Application	Mfr. Part No.	Our No.
Dresser-Hough - Continued			Dresser-Hough - Continued		
H50 - Continued			H60 - Continued		
IH UD282 Diesel - Continued			Detroit Diesel 3-71 Diesel - Continued		
Hose - Upper		26509	Hose - Upper		26508
H50B			Hose - Lower		26508
Detroit Diesel 3-53 Diesel			IH G372		
Belt - Fan	5137300	②▲9390HD	Belt - Fan & Gen.	147985H3	②TR22517
Hose - Upper		24232	Belt - Air Brake Compr.		▲9490HD
Hose - Lower		26507	Hose - Upper		24232
IH 4-Cyl. 263			Hose - Lower		24232
Belt - Fan & Gen.	372596R1	▲9480HD	IH RD372 Diesel		
Belt - Air Brake Compr.	176106	▲9415HD	Hose - Upper		24232
Hose - Upper		26508	Hose - Lower		24232
Hose - Lower		26509	H60B		
IH U240			Cummins V352 Diesel		
Hose - Upper		26508	Belt - Fan & W.P.	178605	②TR22553
Hose - Lower		26509	Belt - Alt.	178376	▲9330HD
IH U264			Hose - Upper		26511
Belt - Fan		TR28445	Hose - Lower - Eng. To Pipe		≧<20172
Belt - Fan & Gen.	155836	TR28445	Hose - Lower - Pipe To Rad.		≧<20172
Belt - Air Brake Compr.	176106	▲9415HD	Cummins V378 Diesel		
IH UD282 Diesel			Belt - Fan & W.P.	178595	②TR22570
Belt - Fan; Ser. No. 17BH-2286 & After	149636R1	▲9480HD	Belt - Alt.		TR24365
Belt - W.P. & Gen.; Ser. No. 17BH-2286 & After	612089C1	▲9510HD	Hose - Upper		26511
Belt - Fan & Gen.; Ser. No. 17BH-2285 & Before	304436R1	▲9505HD	Hose - Lower - Eng. To Pipe		≧<20172
Belt - Air Brake Compr.	176106	▲9415HD	Hose - Lower - Pipe To Rad.		≧<20172
Hose - Upper		26507	IH 6-Cyl. 301		
Hose - Lower		26507	Belt - Fan	401192R1	▲9670HD
H50C			Belt - W.P. & Alt.	170481R2	▲9463HD
IH 6-Cyl. 301			Belt - Air Brake Compr.; Ser. No. 1322 & Before	181492H1	▲9440HD
Belt - Fan	208033H1	▲9476HD	Belt - Air Brake Compr.; Ser. No. 1323 & After	891831C1	▲9451HD
Belt - Fan, W.P. & Gen.	378113R2	▲9480HD	IH D301 Diesel		
Belt - W.P. & Alt./Gen.		▲9480HD	Belt - Fan	358326C91	▲9480HD
Belt - Alt. & W.P.	188839H1	▲9480HD	Belt - W.P. & Alt.	670261C1	▲9505HD
Belt - Air Brake Compr.; Ser. No. 2795 Thru 3186		▲9400HD	Belt - Air Brake Compr.; Ser. No. 1322 & Before	181492H1	▲9440HD
Belt - Air Brake Compr.; Ser. No. 3199 Thru 3209		▲9400HD	Belt - Air Brake Compr.; Ser. No. 1323 & After	891831C1	▲9451HD
Belt - Air Brake Compr.; Ser. No. 3187 Thru 3198	170780R21	▲9470HD	H60E		
Belt - Air Brake Compr.; Ser. No. 3210 & After	170780R21	▲9470HD	IH D360 Diesel		
Hose - Lower		26511	Belt - Fan & Alt.; W/65 3/8" Belt O.C.	680600C1	②TR22648
IH D282 Diesel			Belt - Fan & Alt.; W/66 1/8" Belt O.C.		②TR22657
Belt - Fan & Alt.	670261R1	▲9505HD	Belt - Air Brake Compr.; Ser. No. 4407 & Before	673029C1	▲9470HD
Belt - Fan & Gen.	612089C1	▲9510HD	Belt - Air Brake Compr.; Ser. No. 4408 & After	683457C1	TR22770
Belt - Air Brake Compr.; Ser. No. 3186 & Before	191615H1	▲9400HD	Hose - Upper - Eng. To Pipe		24436
Belt - V.P.	170780R2	▲9470HD	Hose - Upper - Pipe To Rad.		24436
Hose - Upper - Eng. To Pipe		24432	Hose - Lower - Eng. To Pipe		24448
Hose - Upper - Pipe To Rad.		24432	Hose - Lower - Pipe To Rad.		24448
Hose - Lower		26509	H65		
H60			Cummins C160CI Diesel; Cummins JN130 Diesel		
Cummins JF6CI Diesel			Belt - Fan	124479	②TR22363
Belt - Fan	124479	②TR22363	Belt - W.P.; W/3/4" Belt T.W.; W/31 3/4" Belt O.C.	124424	TR24315
Belt - W.P.	124424	TR24315	Belt - W.P.; W/5/8" Belt T.W.; W/32 1/4" Belt O.C.	178456	6932
Belt - Gen.		TR22461	Belt - Gen.	70885	TR22461
Hose - Upper		26509	Cummins JN6CI Diesel		
Hose - Lower - Eng. To Pipe		24236	Hose - Upper		26509
Hose - Lower - Pipe To Rad.		24236	Detroit Diesel 3-71 Diesel		
Detroit Diesel 3-71 Diesel			Belt - Fan	5128579	②▲9500HD
Belt - Fan	5128579	②▲9500HD	Belt - Gen.	5164293	②TR22322
Belt - Gen.	5164293	②TR22322			

▲Standard Belt Available.
≧<Cut to Fit.

②Two Required.

Road & Construction Equipment

Belts and Coolant Hose for Road & Construction Equipment

Application	Mfr. Part No.	Our No.	Application	Mfr. Part No.	Our No.
Dresser-Hough - Continued			Dresser-Hough - Continued		
H65 - Continued			H70 - Continued		
IH G372			Cummins CI6CI Diesel - Continued		
Belt - Fan & Gen.	147985H2	ⓉTR22517	Hose - Lower		26522
Belt - Air Brake Compr.	189527	♣9490HD	Cummins JF6BI Diesel		
Hose - Upper		24232	Belt - Fan	124479	ⓉTR22363
Hose - Lower		24232	Belt - W.P.	124478	TR22322
IH U372			Belt - Gen.		TR22461
Hose - Upper		24232	Hose - Upper - Eng. To Pipe		24232
Hose - Lower		24246	Hose - Upper - Pipe To Rad.		24232
H65B			Hose - Lower		24236
Cummins JN6CI Diesel			Cummins JN6BI Diesel		
Hose - Upper		26509	Hose - Upper - Eng. To Pipe		24232
Cummins JN130 Diesel			Hose - Upper - Pipe To Rad.		24232
Belt - Fan	124479	ⓉTR22363	Hose - Lower		24236
Belt - W.P.; W/3/4" Belt T.W.; W/31 3/4" Belt O.C.	124424	TR24315	IH U372		
Belt - W.P.; W/5/8" Belt T.W.; W/32 1/4" Belt O.C.	178456	6932	Belt - Fan	87878HA	ⓉTR22517
Belt - Gen.	70885	TR22461	Hose - Upper - Eng. To Pipe		24232
IH G372			Hose - Upper - Pipe To Rad.		24232
Belt - Fan & Gen.	147985H2	ⓉTR22517	H70B		
Belt - Air Brake Compr.	189527	♣9490HD	Cummins JF6BI Diesel		
Hose - Upper		24232	Belt - Fan	124479	ⓉTR22363
Hose - Lower		24232	Belt - W.P.	124478	TR22322
IH U372			Belt - Gen.		TR22461
Hose - Upper		24232	IH U372		
Hose - Lower		24246	Belt - Fan	87878HA	ⓉTR22517
H65C			H70C		
Cummins JN6CI Diesel			Cummins C160CI Diesel		
Hose - Upper		26509	Belt - Fan	124479	ⓉTR22363
IH DT361 Diesel			Belt - W.P.	124424	TR24315
Belt - Fan & Alt.	612134C11	ⓉTR24688	Belt - Gen.	178450	TR22495
Belt - Air Brake Compr.	612142C1	7520	Cummins CI6CI Diesel		
IH DT407 Diesel			Hose - Upper		26509
Hose - Upper - Eng. To Pipe		24238	Hose - Lower		26522
Hose - Upper - Pipe To Rad.		24238	Cummins JF6BI Diesel; Cummins JN6BI Diesel		
Hose - Lower - Eng. To Pipe		24236	Hose - Upper - Eng. To Pipe		24232
Hose - Lower - Pipe To Rad.		24236	Hose - Upper - Pipe To Rad.		24232
IH G372			Hose - Lower		24236
Hose - Upper		24232	Detroit Diesel 4-71 Diesel		
Hose - Lower		24232	Belt - Gen.; W/12V. Gen.	3224367	TR28390
IH U372			Belt - V.P.	151167	TR28570
Hose - Upper		24232	IH U372		
Hose - Lower		24246	Hose - Upper - Eng. To Pipe		24232
H65G			Hose - Upper - Pipe To Rad.		24232
Cummins C160CI Diesel; Cummins JN130 Diesel			H70D		
Belt - Fan	124479	ⓉTR22363	Cummins CI6CI Diesel		
Belt - W.P.; W/3/4" Belt T.W.; W/31 3/4" Belt O.C.	124424	TR24315	Hose - Upper		26509
Belt - W.P.; W/5/8" Belt T.W.; W/32 1/4" Belt O.C.	178456	6932	Hose - Lower		26522
Belt - Gen.	70885	TR22461	Cummins JF6BI Diesel; Cummins JN6BI Diesel		
IH G372			Hose - Upper - Eng. To Pipe		24232
Belt - Fan & Gen.	147985H2	ⓉTR22517	Hose - Upper - Pipe To Rad.		24232
Belt - Air Brake Compr.	189527	♣9490HD	Hose - Lower		24236
H70			IH U372		
Cummins CI6CI Diesel			Hose - Upper - Eng. To Pipe		24232
Hose - Upper		26509	Hose - Upper - Pipe To Rad.		24232
H80A			Cummins CS464C Diesel		
Cummins CS464C Diesel			Belt - Fan	178530	ⓉTR24365
Hose - Upper		26509			

♣Standard Belt Available.

ⓉTwo Required.

Belts and Coolant Hose for Road & Construction Equipment

Application	Mfr. Part No.	Our No.	Application	Mfr. Part No.	Our No.
Dresser-Hough - Continued			Dresser-Hough - Continued		
H80A - Continued			H90E		
Cummins CS464C Diesel - Continued			IH DT573 Diesel		
Belt - Alt	178470	TR22474	Hose - Upper - Eng. To Pipe		24232
IH DT429 Diesel			Hose - Upper - Pipe To Rad.		24232
Belt - Fan & Alt.	670914C91	②TR22553	Hose - Lower - Eng. To Pipe		24248
Belt - W.P.	328502R1	TR22485	Hose - Lower - Pipe To Rad.		24248
H80B			IH DVT573 Diesel		
IH DT466 Diesel			Belt - Fan	670340C11	②TR28596
Belt - Fan & Alt.	673481C1	②TR22648	Belt - W.P.	345013R1	TR22455
Belt - Fan, Alt. & W.P.; Ser. No. 10210 & Before	674117C1	TR22657	Belt - Alt./Gen. & Air Brake Compr.	670339C1	TR22517
Belt - Fan, Alt. & W.P.; Ser. No. 10211 & After	683548C91	②TR22664	Hose - Upper - Eng. To Pipe		24232
Belt - Air Brake Compr.	673029C1	♣9470HD	Hose - Upper - Pipe To Rad.		24232
H90B			Hose - Lower - Eng. To Pipe		24248
Cummins C175 Diesel			Hose - Lower - Pipe To Rad.		24248
Belt - Fan	124421	②TR24365	IH DVT573B Diesel		
Belt - W.P.	101427	TR22299	Belt - Fan; Ser. No. 7500 & After	673949C91	②TR22692
Belt - Gen.	70885	TR22461	Belt - Alt.; Ser. No. 7500 Thru 9487	673950C1	♣9495HD
Hose - Lower - Eng. To Pipe		24236	Belt - Alt.; Ser. No. 9488 & After	877414R11	②♣9485HD
Hose - Lower - Pipe To Rad.		24236	H100		
Cummins JN6BI Diesel			Cummins NH220CF Diesel		
Belt - Fan	70888	②♣9360HD	Belt - Fan	178617	②TR28498
Belt - Gen.	70885	TR22461	Belt - W.P.	178570	TR24400
Belt - V.P.	70886	TR22299	Belt - Gen.	178567	TR22350
Hose - Lower - Eng. To Pipe		24236	Detroit Diesel 6V-71 Diesel; Detroit Diesel 8V-71 Diesel		
Hose - Lower - Pipe To Rad.		24236	Belt - Fan; W/51 7/8" Belt O.C.	5168993	TR24515
Detroit Diesel 4055C Diesel			Belt - Fan; W/58 1/4" Belt O.C.	5130662	③♣9580HD
Hose - Upper		26507	Belt - Gen.	5164293	②TR22322
Hose - Lower		26509	IH D817 Diesel		
H90C			Belt - Gen.	323987R1	♣9465HD
Cummins V588C			Belt - Air Brake Compr.	278714R1	TR24515
Hose - Upper		24236	Hose - Upper		24948
Hose - Lower		26520	Hose - Lower - Eng. To Pipe		24252
Detroit Diesel 6V-53 Diesel			Hose - Lower - Pipe To Rad.		24252
Hose - Upper		24236	H100A		
IH DT573 Diesel			Cummins NH220CF Diesel		
Belt - Fan	328927R11	TR28680	Belt - Fan	178617	②TR28498
Belt - W.P.	345013R1	TR22455	Belt - W.P.	178570	TR24400
Belt - Gen. & Air Brake Compr.	341190R1	TR22474	Belt - Gen.	178567	TR22350
Hose - Upper		24236	Detroit Diesel 6V-71 Diesel; Detroit Diesel 8V-71 Diesel		
H90D			Belt - Fan; W/51 7/8" Belt O.C.	5168993	TR24515
Cummins C175 Diesel			Belt - Fan; W/58 1/4" Belt O.C.	5130662	③♣9580HD
Belt - Fan	124421	②TR24365	Belt - Gen.	5164293	②TR22322
Belt - W.P.	101427	TR22299	IH D817 Diesel		
Belt - Gen.	70885	TR22461	Belt - Gen.	323987R1	♣9465HD
Hose - Lower - Eng. To Pipe		24236	Belt - Air Brake Compr.	278714R1	TR24515
Hose - Lower - Pipe To Rad.		24236	H100B		
Cummins JH6BI Diesel			Cummins NH220CF Diesel		
Belt - Fan	70888	②♣9360HD	Belt - Fan	178617	②TR28498
Belt - Gen.	70885	TR22461	Belt - W.P.	178570	TR24400
Belt - V.P.	70886	TR22299	Belt - Gen.	178567	TR22350
Cummins JN6BI Diesel			Cummins NH220CI Diesel; Cummins NH250CI Diesel		
Hose - Lower - Eng. To Pipe		24236	Hose - Upper		26511
Hose - Lower - Pipe To Rad.		24236	Hose - Lower		24236
Detroit Diesel 4055C Diesel			Detroit Diesel 6V-71 Diesel		
Hose - Upper		26507	Belt - Fan; W/51 7/8" Belt O.C.	5168993	TR24515
Hose - Lower		26509	Belt - Fan; W/58 1/4" Belt O.C.	5130662	③♣9580HD
			Belt - Gen.	5164293	②TR22322
			Hose - Lower		24236

②Two Required.
③Three Required.

♣Standard Belt Available.

Belts and Coolant Hose for Road & Construction Equipment

Road & Construction Equipment

Application	Mfr. Part No.	Our No.	Application	Mfr. Part No.	Our No.
Dresser-Hough - Continued			Dresser-Hough - Continued		
H100B - Continued			H120B - Continued		
Detroit Diesel 8V-71 Diesel			Cummins NRT6CI Diesel		
Belt - Fan; W/51 7/8" Belt O.C.	5168993	TR24515	Belt - Fan	178617	TR28498
Belt - Fan; W/58 1/4" Belt O.C.	5130662	③▲9580HD	Belt - W.P.	178628	TR24438
Belt - Gen.	5164293	②TR22322	Belt - Gen.	178568	TR22363
IH D817 Diesel			Cummins NT310CI Diesel		
Belt - Gen.	323987R1	▲9465HD	Belt - Fan	178617	②TR28498
Belt - Air Brake Compr.	278714R1	TR24515	Belt - W.P.	178628	TR24438
Hose - Upper		24946	Belt - Gen.	178599	TR22410
Hose - Lower		24256	Detroit Diesel 6V-71 Diesel		
H100C			Detroit Diesel 8V-71 Diesel		
IH DT817C Diesel			Detroit Diesel 8V-71 Diesel		
Belt - Air Brake Compr.	601684C1	TR24500	Belt - Fan	5130662	③▲9580HD
Hose - Lower - Eng. To Pipe		24256	Belt - Fan	5130662	③▲9580HD
Hose - Lower - Pipe To Rad.		24256	Hose - Upper		24236
H120			Hose - Lower		24244
Cummins NRT6BI Diesel			IH D817 Diesel		
Belt - Fan	178617	TR28498	Belt - Fan & Gen.	310081R1	▲9480HD
Belt - W.P.	178628	TR24438	Belt - Air Brake Compr.	278714R1	TR24515
Belt - Gen.	178568	TR22363	IH DT817 Diesel		
Hose - Upper		26509	Belt - Fan & Gen.	310081R1	▲9480HD
Hose - Lower - Eng. To Pipe		24236	Belt - Air Brake Compr.	278714R1	TR24515
Hose - Lower - Pipe To Rad.		24236	Hose - Upper		24946
Cummins NRT6CI Diesel			Hose - Lower		24256
Belt - Fan	178617	TR28498	H120C		
Belt - W.P.	178628	TR24438	IH 817H Diesel		
Belt - Gen.	178568	TR22363	Belt - Fan, W.P. & Gen.; Ser. No. 501 Thru 3876		
Cummins NT310CI Diesel			Belt - Fan, W.P. & Gen.; Ser. No. 3877 & After	385738R1	▲9490HD
Belt - Fan	178617	②TR28498	Belt - Air Brake Compr.		TR24500
Belt - W.P.	178628	TR24438	IH DT817 Diesel		
Belt - Gen.	178599	TR22410	Belt - Fan & Gen.	316250R1	▲9490HD
Detroit Diesel 6V-71 Diesel			Belt - Air Brake Compr.	601684C1	TR24500
Belt - Fan	5130662	③▲9580HD	IH DT817B Diesel		
Detroit Diesel 8V-71 Diesel			Belt - Fan & Alt.		
Belt - Fan	5130662	③▲9580HD	Belt - Air Brake Compr.	601684C1	TR24500
Hose - Upper		24236	H400		
Hose - Lower		24244	Detroit Diesel 12V-71 Diesel		
IH D817 Diesel			Belt - Fan; W/55 1/4" Belt O.C.		
Belt - Fan & Gen.	310081R1	▲9480HD	Belt - Fan; W/57 1/4" Belt O.C.	5133765	③▲9550HD
Belt - Air Brake Compr.	278714R1	TR24515	Belt - Gen.		③▲9570HD
IH DT817 Diesel			Belt - Air Brake Compr.		TR22392
Belt - Fan & Gen.	310081R1	▲9480HD	Hose - Upper - Eng. To Pipe		TR28473
Belt - Air Brake Compr.	278714R1	TR24515	Hose - Upper - Pipe To Rad.		24240
Hose - Upper		24946	Hose - Lower - Eng. To Pipe		24240
Hose - Lower		24256	Hose - Lower - Eng. To Pipe		24256
H120A			Hose - Lower - Pipe To Rad.		24256
IH DT817 Diesel			H400B		
Belt - Fan, W.P. & Gen.	323987R1	▲9465HD	Cummins VT1710 Diesel		
Belt - Air Brake Compr.		TR24500	Belt - Fan; W/57" Belt O.C.		
H120B			Belt - Fan; W/62 1/8" Belt O.C.	135415	③TR28565
Cummins NRT6BI Diesel			Belt - W.P.; W/39 1/2" Belt O.C.	178665	③TR28616
Belt - Fan	178617	TR28498	Belt - W.P.; W/40 1/2" Belt O.C.	178657	②TR28390
Belt - W.P.	178628	TR24438	Belt - Alt.	178520	②▲9380HD
Belt - Gen.	178568	TR22363	Belt - Gen.; W/33 3/8" Belt O.C.		②TR22329
Hose - Upper		26509	Belt - Gen.; W/34 3/4" Belt O.C.	178613	②TR22344
Hose - Lower - Eng. To Pipe		24236	H400C		
Hose - Lower - Pipe To Rad.		24236	Cummins VT1710 Diesel		
			Belt - Fan; W/57" Belt O.C.		
			Belt - Fan; W/62 1/8" Belt O.C.	135415	③TR28565
			Belt - Fan; W/62 1/8" Belt O.C.		
			135415 ③TR28616		

▲Standard Belt Available.
②Two Required.

③Three Required.

Belts and Coolant Hose for Road & Construction Equipment

Application	Mfr. Part No.	Our No.	Application	Mfr. Part No.	Our No.
Dresser-Hough - Continued			Drott - Continued		
H400C - Continued			35 - Continued		
Cummins VT1710 Diesel - Continued			Cummins 6V-53 Diesel		
Belt - W.P.; W/39 1/2" Belt O.C.	178665	②TR28390	Belt - Fan	178685	②TR22485
Belt - W.P.; W/40 1/2" Belt O.C.	178657	②TR28400	Belt - Alt.	178471	♣9365HD
Belt - Alt.	178520	②♣9380HD	Cummins V352 Diesel		
Belt - Gen.; W/33 3/8" Belt O.C.		②TR22329	Hose - Upper		26512
Belt - Gen.; W/34 3/4" Belt O.C.	178613	②TR22344	Hose - Lower; W/19" Hose		26523
Hose - Upper - Eng. To Pipe		24448	Hose - Lower; W/24" Hose		26512
Hose - Upper - Pipe To Rad.		24448	Detroit Diesel 3-53 Diesel		
Hose - Lower - Eng. To Pipe		24456	Belt - Fan	62939M1	♣9430HD
Hose - Lower - Pipe To Rad.		24456	Belt - Alt.	27955	7425
H560			Hose - Upper		26511
IH DT817B Diesel			Detroit Diesel 4-53N Diesel		
Belt - Alt.	670464C1	TR22578	Belt - Alt.	S27955	②♣9390HD
Belt - Air Brake Compr.	672445C1	TR24538	Hose - Upper; W/8 1/2" Hose		24240
Belt - A.C.	670741C1	TR22570	Hose - Upper; W/14 1/2" Hose		26509
HF			Hose - Lower; W/9 1/2" Hose		26507
IH UD281.4 Diesel			Hose - Lower; W/12 1/4" Hose		26508
Belt - Fan	16131DA	TR28454	IH D263 Diesel		
Belt - Gen.	52318DA	9279	Hose - Upper		26508
HH			IH D282 Diesel		
Hercules JXD Diesel			Hose - Upper		26508
Belt - Fan & V.P.	40515A	②TR28522	Hose - Lower		26511
Belt - Gen.		TR28346	IH D301 Diesel		
HM			Belt - Fan & Alt.	81044	♣9490HD
Hercules DJXH Diesel			Hose - Upper; W/14 1/2" Hose		26509
Belt - Fan & Gen.; Ser. No. 90490 & Before		TR30448	Hose - Upper; W/24" Hose		26512
Belt - Fan & Gen.; Ser. No. 90491 & After ..	113177	TR30467	Hose - Lower		26512
Belt - Gen.; Ser. No. 90491 & After	113175	TR26353	Perkins 6-Cyl. 354 Diesel		
HO			Belt - Fan & Alt.	81486	♣9540HD
Cummins JN6BI Diesel			Hose - Upper; W/14 1/2" Hose		26509
Belt - Fan; W/30 1/2" Belt O.C.	101427	TR22299	Hose - Upper; W/24" Hose		26512
Belt - Fan; W/36 1/4" Belt O.C.	70888	②♣9360HD	Hose - Lower		26512
Belt - Gen.	70885	TR22461	35D		
Belt - Hyd. Pump	70886	TR22299	Case A336BDT Diesel		
TC60			Hose - Lower		26531
IH U240			35EC		
Belt - Fan	78910R1	TR28445	Detroit Diesel 4-53 Diesel		
Drott			Belt - Fan & Alt.	27955	②7425
30DH			Hose - Upper		26511
Cummins NH230 Diesel			Hose - Lower		26510
Belt - Fan		②TR24457	40 Crawler		
Belt - Alt.		TR22363	Case A504BDT Diesel		
Belt - Hyd. Pump	178509	②TR28454	Belt - Fan & Alt.	S88836	TR22607
30YC			Cummins V352 Diesel		
IH C263 Diesel			Belt - Fan	178685	②TR22485
Belt - Fan & Alt.	64231	♣9476HD	Belt - Alt.	178471	♣9365HD
Hose - Upper		♣20611	Detroit Diesel 4-53N Diesel		
		or	Belt - Fan		②♣9430HD
Hose - Lower		26508	Belt - Alt.	27955	②7425
		26511	Detroit Diesel 4-71 Diesel		
35			Belt - Fan		②7420
Allis-Chalmers 2900 Diesel			Belt - Alt.	82985	②♣9365HD
Hose - Upper; W/20" Hose		26511	40 Cruz-Air		
Hose - Upper; W/24" Hose		26512	Allis-Chalmers 2900 Diesel		
Hose - Lower		26511	Belt - V.P.	82628	♣9620HD
			Hose - Upper		26512

②Two Required.
♣Cut to Fit.

♣Standard Belt Available.

Road & Construction Equipment

Belts and Coolant Hose for Road & Construction Equipment

Application	Mfr. Part No.	Our No.	Application	Mfr. Part No.	Our No.
Drott - Continued			Drott - Continued		
40 Cruz-Air - Continued			40R		
Allis-Chalmers 2900 Diesel - Continued			Cummins V352 Diesel		
Hose - Lower		26511	Belt - Pump	83343	♣9400HD
Case A504BDT Diesel			Detroit Diesel 4-53 Diesel		
Hose - Upper; W/14" Hose		26530	Belt - Fan	208005	♣9510HD
Hose - Upper; W/16" Hose		26531	Belt - P.S.	71811	7400
Hose - Lower; W/16" Hose		26531	Ford V-8 361		
Hose - Lower; W/24" Hose		26532	Hose - Upper		26512
Cummins V352 Diesel			Perkins 6-Cyl. 354 Diesel		
Belt - Fan	178685	②TR22485	Belt - Hyd. Pump	82753	♣9570HD
Belt - Alt.; W/36 3/4" Belt O.C.	178471	♣9365HD	Hose - Upper		26512
Belt - Alt.; W/39 1/4" Belt O.C.		♣9390HD	40YR		
Belt - P.S.	71811	7400	Detroit Diesel 4-53 Diesel		
Hose - Lower		26522	Belt - Fan & Air Brake Compr.		②♣9530HD
Cummins V378 Diesel			Belt - W.P. & Alt.	27955	②7425
Belt - Fan	178685	②TR22485	Belt - P.S.		②7405
Belt - Alt.	178471	♣9365HD	Hose - Upper		26509
Hose - Upper		26511	Hose - Lower		26507
Hose - Lower		26521	50		
Detroit Diesel 4-53N Diesel			Case A504BDT Diesel		
Belt - Fan & Air Brake Compr.	5137637	②♣9530HD	Belt - Fan & Alt.	S88836	TR22607
Belt - W.P. & Alt.		②7445	Hose - Upper		26530
Belt - Alt.		②7425	Hose - Lower; W/21" Hose		24940
Belt - P.S.	71811	②7400	Hose - Lower; W/24" Hose		26532
Belt - V.P.	208005	②♣9510HD	Detroit Diesel 6V-53N Diesel		
Hose - Upper; W/14 1/2" Hose		26509	Belt - Fan	S84944	②♣9420HD
Hose - Upper; W/17" Hose		26510	Belt - Alt.		②7375
Hose - Lower; W/9 1/2" Hose		26507	Hose - Upper; W/15 1/2" Hose		25477
Hose - Lower; W/12 1/4" Hose		26508	Hose - Upper; W/20" Hose		25480
Detroit Diesel 4-71 Diesel			Hose - Lower		26511
Hose - Upper		26502	50BEC		
Hose - Lower; W/12 1/4" Hose		26508	Detroit Diesel 6V-53 Diesel		
Hose - Lower; W/14 1/2" Hose		26509	Belt - Fan	5139026	②♣9420HD
Ford V-8 330			Belt - W.P.	5139228	②7370
Belt - Fan & Alt.	84149	②♣9451HD	Belt - Alt.	211672	②7375
Belt - P.S.	84150	②♣9590HD	Hose - Upper		②25480
Hose - Upper		26512	Hose - Lower		26511
Hose - Lower		20685	80 Cruz-Air		
Perkins 6-Cyl. 354 Diesel			Cummins V785 Diesel		
Belt - Fan & Alt.	69966	♣9510HD	Belt - Fan	178691	③TR22517
Belt - V.P.	83695	♣9560HD	Belt - W.P.	178530	TR24365
Hose - Upper		26509	Belt - Alt.	178685	TR22485
Hose - Lower; W/20" Hose		26511	Hose - Upper		②26523
Hose - Lower; W/24" Hose		26512	Hose - Lower		26523
40C			Detroit Diesel 8V-53 Diesel		
Allis-Chalmers 2900 Diesel			Hose - Upper		
Hose - Upper		26512	Detroit Diesel 8V-71 Diesel		
Cummins V352 Diesel			Hose - Upper		
Hose - Upper		26512	Hose - Lower		
Hose - Lower		26522	②26522		
Detroit Diesel 4-53 Diesel			②26536		
Belt - Alt.	205839	7425	250 Travelift		
Detroit Diesel 4-71 Diesel			Continental F163		
Hose - Upper		26501	Hose - Upper		25480
Hose - Lower		26508	Hose - Lower		25476
Perkins 6-Cyl. 354 Diesel			Detroit Diesel 3-53 Diesel		
Hose - Upper		26512	Hose - Upper		26509
			Hose - Lower		20685

②Two Required.
③Three Required.

♣Standard Belt Available.

Belts and Coolant Hose for Road & Construction Equipment

Application	Mfr. Part No.	Our No.	Application	Mfr. Part No.	Our No.
Drott - Continued			Drott - Continued		
250AI Travelift			1000A Travelift - Continued		
Continental F163			Ford V-8 361		
Belt - Fan & Gen.	74799	7425	Hose - Upper		26508
Detroit Diesel 3-53 Diesel; Detroit Diesel 4-53 Diesel			Hose - Lower		26508
Belt - Fan	62939M1	▲9430HD	1000AI Travelift		
Belt - Alt.	27955	7425	Detroit Diesel 4-71 Diesel		
500A Travelift			Belt - Alt.	74061	TR26366
Detroit Diesel 3-53 Diesel			1500; 1800		
Hose - Upper; Ser. No. 999 & Before		26509	Case A504BD Diesel		
Hose - Upper; Ser. No. 1000 & After		26512	Belt - Fan & Alt.	S88836	TR22607
Hose - Lower; Ser. No. 999 & Before		26507	Belt - Air Brake Compr.; W/35 1/8" Belt		
Hose - Lower; Ser. No. 1000 & After		26511	O.C.	S88837	7350
IH			Belt - Air Brake Compr.; W/55 1/4" Belt O.C.		▲9550HD
Hose - Upper		26508	Hose - Upper		26529
Hose - Lower		26511	Hose - Lower - Eng. To Pipe		24240
IH Diesel			Hose - Lower - Pipe To Rad.		26531
Hose - Upper		26508	Cummins V504 Diesel		
Hose - Lower		26508	Belt - Fan	178685	②TR22485
500AI Travelift; 600A Travelift			Belt - Alt.	178471	▲9365HD
Continental F163			Hose - Lower		26521
Belt - Fan & Gen.	74799	7425	Detroit Diesel 6V-53 Diesel		
Detroit Diesel 3-53 Diesel; Detroit Diesel 4-53 Diesel			Hose - Upper		25480
Belt - Fan	62939M1	▲9430HD	Hose - Lower		26511
Belt - Alt.	27955	7425	2500		
650A Travelift			Case A504BDT Diesel		
Continental F163			Belt - P.S.	S86046	②▲9660HD
Belt - Fan & Gen.	74799	7425	Belt - Air Brake Compr.	S86213	▲9490HD
Detroit Diesel 3-53 Diesel			Hose - Upper		26529
Belt - Fan	62939M1	▲9430HD	Hose - Lower - Eng. To Pipe		24240
Belt - Alt.	27955	7425	Hose - Lower - Pipe To Rad.		26531
Detroit Diesel 4-53 Diesel			Detroit Diesel 6V-53 Diesel		
Belt - Fan	62939M1	▲9430HD	Belt - Fan	S84944	②▲9420HD
Belt - Alt.	27955	7425	Belt - Alt.	S71811	②7400
Hose - Upper; Ser. No. 1000 & After		26511	Belt - P.S.		②▲9690HD
Hose - Lower; Ser. No. 1000 & After		26508	Hose - Upper		25480
Ford V-8 361			Hose - Lower		26511
Hose - Upper		26512	2510		
Hose - Lower		26509	Detroit Diesel 6-71N Diesel		
800AC Travelift			Belt - Fan	5135882	②▲9570HD
Detroit Diesel 4-71 Diesel			Belt - Alt.		▲9400HD
Belt - Alt.	74061	TR26366	Hose - Upper		26516
990TC			Hose - Lower - Eng. To Y		24232
Cummins 6-Cyl. 855 Diesel			Hose - Lower - Y To Rad. (Left Side)		24236
Hose - Upper - Eng. To Pipe		24436	Hose - Lower - Y To Rad. (Right Side)		24236
Hose - Lower - Eng. To Pipe		24438	7760		
Hose - Lower - Pipe To Rad.		24436	Detroit Diesel 6-71 Diesel		
Cummins NTC290 Diesel			Hose - Upper - Eng. To Pipe		26516
Hose - Lower - Eng. To Pipe		26533	Hose - Lower - Eng. To Pipe		24432
1000A Travelift			Hose - Lower - Pipe To Rad.		②24436
Cummins V504 Diesel			Dynahoe		
Hose - Upper		26515	140; 160		
Hose - Lower		26522	Detroit Diesel 3-53 Diesel		
Detroit Diesel 4-71 Diesel			Belt - Fan	5172384	②▲9470HD
Hose - Upper		26508	Belt - W.P. & Alt.	5133601	②7410
Hose - Lower		26509	Hose - Upper		≅20611
		26507		or	26509
		26507	Hose - Lower		20685
		26507		or	26507

▲Standard Belt Available.
≅Cut to Fit.

②Two Required.

Belts and Coolant Hose for Road & Construction Equipment

Road & Construction Equipment

Application	Mfr. Part No.	Our No.	Application	Mfr. Part No.	Our No.
Dynahoe - Continued			Elite - Continued		
190 4			DD8		
Detroit Diesel 4-53 Diesel			Honda 5.5 H.P.		
Belt - Fan & Compr.	5135655	②▲9580HD	Belt - Belt		③3VX335
Belt - W.P. & Alt.		②7410	DD10		
Hose - Upper		26511	Honda 6.5 H.P.		
Hose - Lower		26509	Belt - Belt		③3VX315
Dynapac			Euclid		
CA12PD; CA12PDB			2FD; 2LDT; 3LDT; 4FD; 5FD; 5LDT		
John Deere 3179DF Diesel			Cummins HB Diesel		
Belt - Fan & Alt.		TR22474	Belt - Fan	9043021	②TR22405
CA15PD			Belt - Supercharger	9108209	③TR28522
Detroit Diesel 4-53 Diesel			12RT		
Belt - Fan		▲9470HD	Detroit Diesel 6-71 Diesel		
Belt - W.P. & Alt.		7430	Belt - Fan & Air Brake Compr.	5177909	②TR22625
John Deere 4-Cyl. 239 Diesel			16TDT; 21LDT		
Belt - Fan & Alt.	T24473	TR22514	Detroit Diesel 6-71 Diesel		
Hose - Upper		25484	Belt - Fan	5175105	②BX71
Hose - Lower		25478	Belt - Gen.	2068846	TR22336
Hose - By Pass		28441	21TD; 21TDT; 22TD; 22TDT		
CA25PD			Detroit Diesel 6-110 Diesel		
Caterpillar 3208 Diesel			Belt - Fan	5114268	④7590
Belt - Fan & Alt.; W/55A. Alt.		▲9520HD	Belt - Fan & Air Brake Compr.	5188884	②TR22711
Hose - Upper		26523	Belt - Gen.	3222608	TR28429
Hose - Lower		26511	24TDT		
CT25			Cummins NRT6BI Diesel		
Detroit Diesel 6V-53T Diesel			Belt - Fan	S3116	②TR28557
Belt - Fan		②▲9412HD	Belt - W.P.	S3163	TR22434
Belt - W.P.	5133177	②7370	Belt - P.S.; W/Vickers P.S. Pump	S2295	②TR22461
Belt - Alt.		②7370	Cummins NVHBI1200 Diesel		
Hose - Upper - Eng. To Pipe		25528	Belt - Fan	69159	②▲9550HD
Hose - Lower - Cooler To Rad.		≧21115	28TDT		
Hose - Lower - Eng. To Cooler		≧21115	Cummins NRT6BI Diesel		
Easi-Doer			Belt - Fan	9020495	②TR28545
SW77			Belt - W.P.	9021241	TR22434
Detroit Diesel ST6 Diesel			31TD		
Belt - Fan		②▲9420HD	Cummins NHRS Diesel		
Belt - Alt.		▲9390HD	Belt - Fan	9045097	②TR28514
Hose - Lower - Eng. To Pipe		24432	Belt - W.P.	9021241	TR22434
Hose - Lower - Pipe To Rad.		24432	Belt - P.S.; W/46 5/8" Belt O.C.	9021578	②TR22461
Elgin			Belt - P.S.; W/50" Belt O.C.	9040981	②TR22495
L; M			Belt - Air Brake Compr.	9045099	②TR24355
IH BD264 Diesel			82-40 Crawler		
Belt - Fan & Gen.	81572R2	TR28437	Detroit Diesel 8V-71N Diesel		
Belt - Hyd. Pump	S9074	②▲9463HD	1968 - 1966		
N; S; T			Belt - Fan & Gen.		
IH BD264 Diesel				9177465	②BX77
Belt - Fan & Gen.	81572R2	TR28437	C61; C62; C63		
Belt - Hyd. Pump	S9060	②▲9470HD	Detroit Diesel 6-71 Diesel		
Elite			1963 - 1959		
DD6			Belt - Gen.; W/34 1/8" Belt O.C.	2068846	TR22336
Honda 3.5 H.P.			Belt - Gen.; W/44 3/4" Belt O.C.	9174657	TR22443
Belt - Belt		②3VX280	C64; C65		
			Detroit Diesel 6-71 Diesel		
			1968 - 1963		
			Belt - Gen.; W/34 1/8" Belt O.C.	2068846	TR22336

②Two Required.
 ≧Cut to Fit.
 ④Four Required.

▲Standard Belt Available.
 ③Three Required.

Belts and Coolant Hose for Road & Construction Equipment

Application	Mfr. Part No.	Our No.	Application	Mfr. Part No.	Our No.
Euclid - Continued			Euclid - Continued		
C64; C65 - Continued			R50 (201LD) - Continued		
Detroit Diesel 6-71 Diesel - Continued			Detroit Diesel 16V-71N Diesel - Continued		
1968 - 1963 - Continued			Hose - Upper - Left Side		
Belt - Gen.; W/44 3/4" Belt O.C. 9174657		 24948		
..... TR22443			Hose - Upper - Right Side		
R15 (91FD); R18 (91FD)		 24948		
Detroit Diesel 6-71 Diesel			Hose - Lower - Eng. To Pipe (Left Side)		
Belt - Fan 24440		
..... 5175105			②BX71		
Belt - Gen. 5164293		 TR22322		
Hose - Upper 24932		
..... 24932			Hose - Lower - Pipe To Pipe (Left Side)		
Hose - Lower 24440		
..... 24932			Hose - Lower - Pipe To Rad. (Left Side)		
R22 (59TD); R22 (63TD)		 24460		
Detroit Diesel 6-110 Diesel			Hose - Lower - Eng. To Pipe (Right Side)		
Belt - Fan; W/3/8" Belt T.W.; W/59 1/8" Belt		 24460		
O.C. 5114268			④7590		
Belt - Fan; W/1/2" Belt T.W.; W/59 1/4" Belt		 ③♣9590HD		
O.C. 9185576		 TR22322		
Belt - Fan; W/11/16" Belt T.W.; W/61 1/4"		 ②TR22607		
Belt O.C. 5167565		 ④7680		
Belt - Fan; W/3/8" Belt T.W.; W/68 1/8" Belt		 ③♣9680HD		
O.C. 5114266		 TR24400		
Belt - Fan; W/1/2" Belt T.W.; W/68 1/4" Belt		 TR28429		
O.C. 5115053		 3222608		
Belt - Gen.; W/40 3/8" Belt O.C. 5155911					
Belt - Gen.; W/43 3/8" Belt O.C. 3222608					
R30 (71TD)			S12 (77FDT)		
Detroit Diesel 8V-71 Diesel			Detroit Diesel 6-71 Diesel		
Belt - Fan; W/61 1/4" Belt O.C. 5133828			Belt - Fan; W/46 5/8" Belt O.C. 5110267		
..... ③♣9610HD		 ③TR22461		
Belt - Fan; W/62 3/4" Belt O.C. 5125467			Belt - Fan; W/74 1/2" Belt O.C. 5175105		
..... ③♣9625HD		 ②BX71		
Belt - Gen. 5133516			Belt - Gen.; W/32 3/4" Belt O.C. 5164293		
..... ♣9380HD		 TR22322		
Belt - Air Brake Compr. 5137905			Belt - Gen.; W/39 1/2" Belt O.C. 3224367		
..... TR28473		 TR28390		
R35 (74TD)			Belt - Gen.; W/41 1/4" Belt O.C. 9176958		
Cummins KT1150C Diesel		 ♣9412HD		
Belt - Alt. 206996			Belt - P.S. 9125309		
..... K050370		 TR28454		
Detroit Diesel 12V-71 Diesel			S12 (78FDT)		
Belt - Fan			Detroit Diesel 6-71 Diesel		
..... 5137906			Belt - Fan; Ser. No. 16714 Thru E Series 5175105		
Belt - Alt. 5133516		 ②BX71		
..... ③♣9630HD			Belt - Gen.; W/32 3/4" Belt O.C.; Ser. No.		
..... ②♣9380HD			16714 Thru E Series 5164293		
Belt - Air Brake Compr. 5137905		 TR22322		
..... TR28473			Belt - Gen.; W/39 1/2" Belt O.C.; Ser. No.		
R35 (201TD)			16714 Thru E Series 3224367		
Cummins KT1150C Diesel		 TR28390		
Belt - Alt. 206996			SS12 (77FDT)		
..... K050370			Detroit Diesel 6-71 Diesel		
Hose - Upper			Belt - Fan; Ser. No. 16714 Thru E Series 5175105		
..... 24440		 ②BX71		
Hose - Lower - Eng. To Pipe			Belt - Gen.; W/32 3/4" Belt O.C.; Ser. No.		
..... 24456			16714 Thru E Series 5164293		
Hose - Lower - Pipe To Rad. 24456		 TR22322		
Detroit Diesel 12V-71 Diesel			Belt - Gen.; W/39 1/2" Belt O.C.; Ser. No.		
Belt - Fan			16714 Thru E Series 3224367		
..... 5137906		 TR28390		
Belt - Alt. 5133516			SS12 (78FDT)		
..... ②♣9380HD			Detroit Diesel 6-71 Diesel		
Belt - Air Brake Compr. 5137905			Hose - Upper		
..... TR28473		 24932		
Hose - Upper - Eng. To Pipe			Hose - Lower		
..... 24440		 24932		
Hose - Upper - Pipe To Rad. 24440			SS18 (23TDT)		
Hose - Lower - Eng. To Pipe			Detroit Diesel 6-110 Diesel		
..... 24456			Belt - Fan; W/59 1/8" Belt O.C. 5111547		
Hose - Lower - Pipe To Rad. 24456		 ④7590		
R40 (9FFD); R45 (9FFD)			Belt - Fan; W/68 1/4" Belt O.C. 5115053		
Detroit Diesel 6-71 Diesel		 ③♣9680HD		
Belt - Fan			Belt - Fan; W/71 1/4" Belt O.C. 5188884		
..... 9185986		 ②TR22711		
Belt - Gen. 5183923			Belt - Fan; W/77 1/8" Belt O.C. 5114267		
..... TR24424		 ④7775		
R50 (201LD)			Belt - Gen.; W/40 3/8" Belt O.C. 5155911		
Detroit Diesel 16V-71N Diesel		 TR24400		
Belt - Alt. 5134212			Belt - Gen.; W/43 3/8" Belt O.C. 3222608		
..... ②♣9480HD		 TR28429		
Belt - Air Brake Compr. 5133175			Hose - Upper		
..... 7390		 24944		
			Hose - Lower		
		 24944		
			SS24 (33LOT)		
			Cummins NRTO6BI Diesel		
			Belt - Fan; Ser. No. 23474 Thru 26773 9021068		
		 ②TR28545		
			Belt - W.P.; Ser. No. 23474 Thru 26773 9026236		
		 TR22434		
			TC12		
			Detroit Diesel 6-71 Twin Diesel		
			1966 - 1954		
			Belt - Fan		
		 9151954		
		 ②TR22711		

②Two Required.
♣Standard Belt Available.

④Four Required.
③Three Required.

Road & Construction Equipment

Belts and Coolant Hose for Road & Construction Equipment

Application	Mfr. Part No.	Our No.	Application	Mfr. Part No.	Our No.
Ferguson Shovel Supply			Fiat-Allis - Continued		
5-8A			65B - Continued		
John Deere 4-Cyl. 276 Diesel			Fiat-Iveco 8061 Diesel - Continued		
Hose - Upper		25476	Hose - Lower - Eng. To Pipe		24224
Hose - Lower - Eng. To Pipe		24228	Hose - Lower - Pipe To Rad.		24224
Hose - Lower - Pipe To Rad.		24228	100C; 150C		
8-12 Ton			Allis-Chalmers 11000 Diesel		
Ford 6-Cyl. 240			Belt - Fan	4320755	②TR28596
Belt - Fan		♣9412HD	Belt - Fan, Alt. & W.P.	4349778	TR28522
Belt - W.P. & Alt.		7420	Belt - Fan, W.P. & Gen.		TR28545
Belt - Alt. To Gov.		7260	Belt - Hyd. Pump	675084	④TR22443
Belt - Hyd. Pump		♣9385HD	Hose - Upper		26520
46			Hose - Lower		24440
Continental TM27 Diesel			Hose - By Pass		24430
Belt - Fan & Alt.		♣9463HD	161		
Belt - Hyd. Pump		♣9451HD	Cummins V903 Diesel		
Hose - Upper		25527	Hose - Upper - Eng. To Pipe		②24436
Hose - Lower		26603	Hose - Upper - Pipe To Rad.		②24436
SP75D			Hose - Lower - Eng. To Pipe		24444
Detroit Diesel 4-53N Diesel			Hose - Lower - Pipe To Rad.		24444
Hose - Upper		25476	200C		
Hose - Lower - Eng. To Pipe		24228	Allis-Chalmers 11000 Diesel		
Hose - Lower - Pipe To Rad.		24228	Belt - Fan	4320755	②TR28596
SP120B			Belt - Fan, Alt. & W.P.	4349778	TR28522
Detroit Diesel 6V-53 Diesel			Belt - Fan, W.P. & Gen.		TR28545
Belt - Fan	78	②♣9395HD	Belt - Hyd. Pump	675084	④TR22443
Belt - Gen.		②7580	Hose - Upper		26520
Belt - W.P. & Idler	5139228	②7370	Hose - Lower		24440
Hose - Upper - Left Side		26611	Hose - By Pass		24430
Hose - Upper - Right Side		26611	261B		
Hose - Lower		26508	Allis-Chalmers 25000 Mark II Diesel		
Fiat-Allis			Belt - Fan & Air Brake Compr.	4394324	③CX81
16B			Belt - Alt.	4394323	♣9425HD
Allis-Chalmers 17000 Diesel			Belt - Hyd. Pump	4391351	7490
1981 - 1972			Hose - Upper		26532
Belt - Fan & Alt.		TR28786	605B		
Hose - Upper - Eng. To Pipe		24442	Allis-Chalmers 2900 Mark II Diesel		
Hose - Upper - Pipe To Rad.		24442	Belt - Fan & Alt.	73046916	♣9550HD
41B			Hose - Upper		26525
Cummins VT1710 Diesel			645B		
1983 - 1970			Allis-Chalmers 3500 Diesel		
Belt - Alt.	70663945	TR22358	Belt - Fan & Alt.		③♣9610HD
Belt - W.P.	178665	②TR28390	Belt - Air Brake Compr.		TR22578
Hose - Upper - Eng. To Pipe (Left Side)		24448	745B		
Hose - Upper - Eng. To Pipe (Right Side)		24448	Allis-Chalmers 11000 Diesel		
Hose - Upper - Pipe To Rad. (Left Side)		24448	Belt - Fan		②TR28583
Hose - Upper - Pipe To Rad. (Right Side)		24448	Belt - W.P. & Air Brake Compr.		TR28583
Hose - Lower - Eng. To Pipe		24456	Belt - Alt.		♣9370HD
Hose - Lower - Pipe To Rad.		24456	Hose - Upper - Eng. To Pipe		24432
65			Hose - Upper - Pipe To Rad.		24432
Allis-Chalmers 6-Cyl. 262 Diesel			745HB		
Belt - Fan & Alt.		♣9480HD	Allis-Chalmers 11000 Diesel		
Hose - Upper		24428	Belt - Fan		②TR28583
Hose - Lower		25526	Belt - W.P. & Air Brake Compr.		TR28583
65B			Belt - Alt.		♣9370HD
Fiat-Iveco 8061 Diesel			Hose - Upper - Eng. To Pipe		24436
Belt - Fan & Alt.	73117688	②7508	Hose - Upper - Pipe To Rad.		24436
Hose - Upper		♣21794	Hose - Lower		26536
		or			
		25480			

♣Standard Belt Available.

⚡Cut to Fit.

③Three Required.

②Two Required.

④Four Required.

Belts and Coolant Hose for Road & Construction Equipment

Application	Mfr. Part No.	Our No.	Application	Mfr. Part No.	Our No.
Fiat-Allis - Continued			Ford - Continued		
945B			420		
Allis-Chalmers 25000 Diesel			Ford 4-Cyl. 183 Diesel		
Belt - W.P.	4391351	7490	Belt - Fan & Alt.	C9NN 10C318 A	▲9555HD
Belt - Alt.		▲9560HD	Hose - Upper		≧21794
Hose - Upper - Eng. To Pipe		24444		or	25474
Hose - Upper - Pipe To Rad.		24444	445C Backhoe		
Hose - Lower - Eng. To Pipe		24440	Ford 4-Cyl. 192 Diesel		
Hose - Lower - Pipe To Rad.		24440	Belt - Fan & Alt.	D3NN 10C318 C	▲9555HD
FR12B			Hose - Upper		≧20065
Fiat 6-Cyl. 335 Diesel			445C Wheel		
Belt - W.P. & Alt.		▲9470HD	Ford 3-Cyl. 201 Diesel		
Belt - Fan & Hyd. Pump		②▲9650HD	Belt - Fan & Alt.	D3NN 10C318 C	▲9555HD
Hose - Upper		24928	Hose - Upper		≧20065
Hose - Lower - Eng. To Pipe		24824	545C; 545C Backhoe		
Hose - Lower - Pipe To Rad.		25477	Ford 3-Cyl. 201 Diesel		
Hose - By Pass		26241	Belt - Fan & Alt.	D3NN 10C318 C	▲9555HD
FR15B			Hose - Upper		≧21794
Fiat 6-Cyl. 494 Diesel			545D Backhoe; 545D Wheel		
Belt - Fan & Alt.		②▲9670HD	Ford 3-Cyl. 201 Diesel		
Belt - W.P.		7450	Belt - Fan & Alt.	D3NN 10C318 C	▲9555HD
Belt - A.C.		7445	Hose - Upper		20957
Hose - Upper		②23533	550		
Hose - Lower		②23533	Ford 3-Cyl. 201		
FMC			Belt - Fan & Alt.; May 1977 & Older		
Vanguard 4000SP			D3NN 10C318 D		
Detroit Diesel V-8 8.2 L Diesel			▲9555HD		
Belt - Fan & Alt.		②▲9680HD	Belt - Fan & Alt.; W/O 72A. Alt.; Jun. 1977		
Hose - Upper - Eng. To Pipe		≧20611	& Newer		
Hose - Upper - Pipe To Rad.		26513	D6NN 8620 A		
Hose - Lower - Eng. To Pipe		26522	▲9463HD		
Hose - Lower - Pipe To Rad.		26521	Belt - W.P. & Alt.; W/72A. Alt.; Jun. 1977 &		
Vanguard V3000SP			Newer		
John Deere 4-Cyl. Diesel			D7NN 10C318 A		
Belt - Fan & Alt.	H79235	②▲9590HD	▲9313HD		
Belt - Fan To A.C.		▲9480HD	555C		
Hose - Upper - Pipe To Rad.		26513	Ford 3-Cyl. 201 Diesel		
Hose - Lower - Eng. To Pipe		26523	Belt - Fan & Alt.		
Hose - Lower - Pipe To Rad.		26521	D3NN 10C318 C		
Ford			▲9555HD		
250C			Ford 4-Cyl. 256 Diesel		
Ford 3-Cyl. 201 Diesel			Hose - Upper		
Belt - Fan & Alt.	D3NN 10C318 C	▲9555HD	≧20065		
Hose - Upper		≧21794	655D		
260C			Ford 4-Cyl. 256 Diesel		
Ford 3-Cyl. 201 Diesel			Belt - Fan & Alt.		
Belt - Fan & Alt.	D3NN 10C318 C	▲9555HD	D3NN 10C318 C		
Hose - Upper		≧20065	▲9555HD		
340			Hose - Upper		
Ford V-4 140			≧20357		
Belt - Fan, Alt. & W.P.		7460	or		
Hose - Lower		25474	26602		
Hose - By Pass		28441	750; 755		
345C			Ford 4-Cyl. 256		
Ford 4-Cyl. 192 Diesel			Belt - Fan & Alt.		
Belt - Fan & Alt.	D3NN 10C318 C	▲9555HD	D3NN 10C318 D		
			▲9555HD		
			1800		
			Ford 3-Cyl. 158 Diesel		
			Belt - Fan & Gen.		
			EAF 8577 A		
			▲9415HD		
			Belt - P.S.; W/45 7/8" Belt O.C.		
			CONN 8620 C		
			TR20451		
			Belt - P.S.; W/47 7/8" Belt O.C.		
			313149		
			TR22474		
			Hose - Upper		
			24220		
			4040		
			Ford 4000; Ford 4000 Diesel		
			Belt - P.S.; Ser. No. 144291 & Before		
			313149		
			TR22474		
			Belt - P.S.; Ser. No. 144292 & After		
			CONN 8620 C		
			TR20451		
			6500		
			Ford 4-Cyl. 256 Diesel		
			Belt - Fan & Alt.		
			▲9560HD		

▲Standard Belt Available.
≧Cut to Fit.

②Two Required.

Belts and Coolant Hose for Road & Construction Equipment

Road & Construction Equipment

Application	Mfr. Part No.	Our No.	Application	Mfr. Part No.	Our No.
Ford - Continued			Ford - Continued		
6500 - Continued			A66 - Continued		
Ford 4-Cyl. 256 Diesel - Continued			Ford 6-Cyl. 401 Diesel - Continued		
Hose - Upper		≈21794	Hose - Lower - Eng. To Pipe		24226
	or	25474	Hose - Lower - Pipe To Rad.		20357
Hose - Lower		26502	CL40		
7500			Ford 104GF		
Ford 3-Cyl.; Ford 3-Cyl. Diesel; Ford 4-Cyl.			1984 - 1974		
Belt - Fan & Alt.; W/55 1/4" Belt O.C.		♣9550HD	Belt - Fan, Alt. & W.P.		♣9490HD
Belt - Fan & Alt.; W/56 1/4" Belt O.C.		♣9560HD	Belt - Gov.		7350
Belt - W.P. & Alt. D5NN 10C318 A		♣9325HD	CL65		
Ford 4-Cyl. Diesel			Shibaura V1004 Diesel		
Belt - Fan & Alt.; W/55 1/4" Belt O.C.		♣9550HD	1986 - 1983		
Belt - Fan & Alt.; W/56 1/4" Belt O.C.		♣9560HD	Belt - Fan, Alt. & W.P.		
Belt - W.P. & Alt. D5NN 10C318 A		♣9325HD	Belt - Gov.		
Hose - Upper		≈21794	7350		
	or	25477	H48		
Hose - Lower		26611	Ford 6-Cyl. Diesel		
A62			Belt - Fan & Alt.		
Ford 4-Cyl. 256 Diesel			♣9550HD		
Belt - Fan & W.P. D3NN 8620 A		♣9463HD	Hose - Upper - Eng. To Pipe		≈20573
Belt - W.P. & Alt.; W/A.C. D3NN 10C318 E		♣9480HD	Hose - Upper - Pipe To Rad.		≈20573
Belt - W.P. & Alt.; W/O A.C.; May 1976 & Older	D3NN 10C318 F	♣9555HD	Hose - Lower - Eng. To Pipe		≈20957
Belt - W.P. & Alt.; W/O A.C.; Jun. 1976 Thru Apr. 1978	D5NN 10C318 A	♣9325HD	Hose - Lower - Pipe To Pipe		≈20957
Belt - W.P. & Alt.; W/O A.C.; May 1978 & Newer	D8NN 10C318 BA	♣9309HD	Hose - Lower - Pipe To Rad.		24438
Hose - Upper		25530	Fresia		
Hose - Lower - Eng. To Pipe		24428	F90		
Hose - Lower - Pipe To Pipe		≈20357	Detroit Diesel 8V-92 Diesel		
A64			Belt - Fan		
Ford 6-Cyl. 401 Diesel			♣9580HD		
Belt - Fan; Aug. 1976 & Older	D3NN 8620 B	♣9610HD	FC100; LM200		
Belt - Fan; Sept. 1976 & Newer	D5NN 8620 E	♣9625HD	Cummins 6-Cyl. 8.3 L Diesel		
Belt - W.P. & Alt.; W/A.C. D3NN 10C318 E		♣9480HD	Belt - Fan & Alt. 3911573		
Belt - W.P. & Alt.; W/O A.C.; May 1976 & Older	C9NN 10C318 A	♣9555HD	Hose - Lower - Eng. To Pipe		
Belt - W.P. & Alt.; W/O A.C.; Jun. 1976 Thru Apr. 1978	D6NN 8620 B	♣9585HD	Hose - Lower - Pipe To Rad.		
Belt - W.P. & Alt.; W/O A.C.; May 1978 Thru Feb. 1979	D8NN 10C318 DA	♣9600HD	≈20611		
Belt - W.P. & Alt.; W/O A.C.; Mar. 1979 & Newer	D8NN 10C318 AA	♣9580HD	Gardner-Denver		
Belt - A.C. D3NN 8620 B		♣9610HD	450		
Hose - Upper - Eng. To Pipe		24224	Caterpillar 3204 Diesel		
Hose - Upper - Pipe To Rad.		≈20945	Belt - Fan & Alt.		
Hose - Lower - Eng. To Pipe		24226	③♣9660HD		
Hose - Lower - Pipe To Rad.		20357	AAG		
A66			Buda JH; Buda JV		
Ford 6-Cyl. 401 Diesel			Belt - Fan		
Belt - Fan; Aug. 1976 & Older	D3NN 8620 B	♣9610HD	13C39		
Belt - Fan; Sept. 1976 & Newer	D5NN 8620 E	♣9625HD	TR34506		
Belt - W.P. & Alt.; W/A.C. D3NN 10C318 E		♣9480HD	D125		
Belt - W.P. & Alt.; W/O A.C.; May 1976 & Older	D4NN 10C318 A	♣9540HD	John Deere 3179D Diesel		
Belt - W.P. & Alt.; W/O A.C.; Jun. 1976 Thru Apr. 1978	D6NN 8620 B	♣9585HD	Belt - Fan & Alt. T20334		
Belt - W.P. & Alt.; W/O A.C.; May 1978 Thru Feb. 1979	D8NN 10C318 DA	♣9600HD	Hose - By Pass		
Belt - W.P. & Alt.; W/O A.C.; Mar. 1979 & Newer	D8NN 10C318 AA	♣9580HD	≈20802		
Belt - A.C. D3NN 8620 B		♣9610HD	John Deere 4239D Diesel		
Hose - Upper - Eng. To Pipe		24224	Hose - By Pass		
Hose - Upper - Pipe To Rad.		≈20945	≈20802		

♣Standard Belt Available.
③Three Required.

≈Cut to Fit.

Belts and Coolant Hose for Road & Construction Equipment

Application	Mfr. Part No.	Our No.	Application	Mfr. Part No.	Our No.
Gardner-Denver - Continued			Gardner-Denver - Continued		
D825			SPHGA; SPHGC		
Caterpillar 3306B Diesel			Ford 6-Cyl. 240		
Belt - Fan & Alt.	5M0923	A73	Belt - W.P. & Alt.	C7JZ 8620 D	7405
HT3100			Belt - Gov.	C7JZ 8620 D	7405
Caterpillar 4-Cyl. Diesel			Ford 6-Cyl. 300		
Belt - Fan & Alt.		③▲9660HD	Belt - Fan & Alt.	C9PZ 8620 T	②7417
RP125DA			Belt - Gov.	C7JZ 8620 P	7260
Hercules DD198 Diesel			SPKDB		
Belt - Fan	13C178	B48	Detroit Diesel 4-53 Diesel		
RP125G			Belt - Fan; W/41 3/4" Belt O.C.		②7417
Hercules GO198A			Belt - Fan; W/42 3/4" Belt O.C.		②7425
Belt - Fan	13C178	B48	Belt - Alt.	5133173	②7420
RP210DA			Belt - Gen.	5116450	②7405
Hercules DD339 Diesel			SPNDA		
Belt - Fan	13C61	B51	Detroit Diesel 4-71 Diesel; Detroit Diesel 6-71 Diesel		
Belt - Aux. Pump	13C58	2480	Belt - Fan	13AE2	②TR22461
RP210GA			Belt - Gen.	5133516	▲9380HD
Hercules GO339			SPNDB		
Belt - Fan	13C85	TR22625	Detroit Diesel 4-71 Diesel; Detroit Diesel 6-71 Diesel		
Belt - Aux. Pump	13C84	B55	Belt - Fan		②TR20451
RP365			Belt - Gen.	5133516	▲9380HD
Detroit Diesel 4-53 Diesel; Detroit Diesel 4-71 Diesel			SPQDA		
Belt - Fan	13E342	②B64	Detroit Diesel 6-71 Diesel		
RP600; RP600D; RP600DB			Belt - Fan	13AE2	②TR22461
Detroit Diesel 4-53 Diesel; Detroit Diesel 4-71 Diesel			Belt - Gen.	13AE1	AX38
Belt - Fan	13E7	②B60	SPQDB		
RP900			Detroit Diesel 4-71 Diesel; Detroit Diesel 6-71 Diesel		
Detroit Diesel 6-110 Diesel			Belt - Fan	13AE2	②TR22461
Belt - Fan		TR28743	Belt - Gen.	5133516	▲9380HD
SP600DK			SPQDC		
Caterpillar D333CT Diesel; Caterpillar M3306T Diesel			Detroit Diesel 4-71 Diesel; Detroit Diesel 6-71 Diesel		
Belt - Fan & Alt.		②▲9540HD	Belt - Fan		②TR20451
SP1200DE			Belt - Gen.	5133516	▲9380HD
Detroit Diesel 8V-71 Diesel; Detroit Diesel 12V-71 Diesel			SPQDD		
Belt - Fan		②5VX630	Cummins V903 Diesel		
Belt - Gen.	5133516	▲9380HD	Belt - Fan & W.P.	202051	②▲9670HD
SP1200DF			Belt - Alt.		②▲9520HD
Caterpillar D343T Diesel; Caterpillar D343TA Diesel			SPTDA		
Belt - Fan		②5VX630	Detroit Diesel 8V-71 Diesel; Detroit Diesel 12V-71 Diesel		
Belt - Alt.	6L3408	▲9476HD	Belt - Fan		②5VX630
SPCGA			Belt - Gen.	5133516	▲9380HD
IH UC135B			SPTDB		
Belt - Fan & Alt.; W/44 1/4" Belt O.C.	349175R1	7440	Caterpillar D343T Diesel; Caterpillar D343TA Diesel		
Belt - Fan & Alt.; W/45 1/8" Belt O.C.	678200C1	7450	Belt - Fan		②5VX630
SPFGA; SPFGB; SPFGC			Belt - Alt.	6L3408	▲9476HD
Ford V-4 104			SPTDC		
Belt - Fan & Alt.	C9PZ 8620 GF	7380	Detroit Diesel 8V-71 Diesel; Detroit Diesel 12V-71 Diesel		
Belt - Gov.		7350	Belt - Fan		②5VX630
SPHDA			Belt - Gen.	5133516	▲9380HD
Ford 6-Cyl. 254 Diesel			SPTDD		
Belt - W.P. & Alt.		▲9455HD	Caterpillar 3406DI Diesel		
			Belt - Fan		②5VX630
			Belt - Alt.	8F2434	TR22485

▲Standard Belt Available.
②Two Required.

③Three Required.

Belts and Coolant Hose for Road & Construction Equipment

Application	Mfr. Part No.	Our No.	Application	Mfr. Part No.	Our No.
Gardner-Denver - Continued			Gardner-Denver - Continued		
SPWDA; SPWDB			WHF		
Detroit Diesel 8V-71 Diesel; Detroit Diesel 12V-71 Diesel			Buda L525		
Belt - Fan		@5VX630	Belt - Fan	13C161	TR28522
Belt - Gen.	5133516	▲9380HD	Belt - Intercooler	13C154	TR28406
SPWDC			WHHDA		
Caterpillar D343T Diesel; Caterpillar D343TA Diesel			Buda		
Belt - Fan		@5VX630	Belt - Fan	13C162	TR28501
Belt - Alt.	6L3408	▲9476HD	WHHDB		
WBD			Buda		
Buda 6DT317 Diesel			Belt - Fan		
Belt - Fan	13C161	TR28522	Belt - Fan	13C154	TR28406
Belt - Intercooler	13C50	TR24461	WHHDC		
Buda HP326			Buda		
Belt - Fan	13C153	TR28473	Belt - Fan	13C162	TR28501
Buda HP351			WHHDD		
Belt - Fan		TR30467	Buda		
WBG			Belt - Fan		
Buda JK4; Buda JL4; Buda JL877			Belt - Fan	13C154	TR28406
Belt - Fan	13C39	TR34506	WHK		
Caterpillar D11000 Diesel			Buda		
Belt - Intercooler	13C39	@TR34506	Belt - Intercooler	13C39	@TR34506
WBH; WBK			WHL		
Caterpillar D11000 Diesel; Caterpillar D13000 Diesel			Buda		
Belt - Intercooler	13C39	TR34506	Belt - Fan	13C162	TR28501
WGH			WHX		
Buda			Buda		
Belt - Intercooler	13C162	TR28501	Belt - Intercooler	13C39	@TR34506
WH105GB; WH105GC; WH105GJ; WH105GK			Gehl		
Buda			SL6625		
Belt - Fan	13C152	TR28514	Perkins 4-Cyl. 154 Diesel		
WH105GP; WH105GQ			1996 - 1987		
Buda			Belt - Fan & Alt.	A45	▲9463HD
Belt - Fan	13C146	TR28437	Hose - Upper		≧20957
WH315G				or	26603
Caterpillar D339 Diesel			Hose - Lower - Eng. To Pipe		24228
Belt - Fan		@TR30652	Gomaco		
Belt - Compr.	13C154	TR28406	GT6000-66		
WH600			Detroit Diesel 2-53 Diesel		
Buda			Belt - Fan	5119188	@▲9390HD
Belt - Fan	13C39	@TR34506	Belt - W.P. & Gen.		@7410
WHD			Hose - Upper		24924
Buda 6B230			Hose - Lower - Eng. To Pipe		24932
Belt - Compr.; W/Man. Start	13C146	TR28437	Hose - Lower - Pipe To Rad.		24932
Buda HP234			GT6000-78		
Belt - Compr.; W/Elec. Start	13C152	TR28514	Detroit Diesel 3-53 Diesel		
Belt - Compr.; W/Man. Start	13C153	TR28473	Belt - Fan	5126447	@▲9350HD
Detroit Diesel 2055 Diesel			Belt - W.P. & Alt.	5133172	@7430
Belt - Fan	13C85	@TR22625	Hose - Upper		24926
Hercules QXD5			Hose - Lower - Eng. To Pipe		≧20882
Belt - Fan	13C169	TR28454	Hose - Lower - Pipe To Rad.		≧20882
			Grimmer-Schmidt		
			175		
			Ford V-8 351		
			Belt - Fan & Alt.; W/42A. Alt.		7420
			Hose - Upper		25477

▲Standard Belt Available.
≧Cut to Fit.

@Two Required.

Belts and Coolant Hose for Road & Construction Equipment

Application	Mfr. Part No.	Our No.	Application	Mfr. Part No.	Our No.
Grimmer-Schmidt - Continued			Grove - Continued		
175 - Continued			RT400		
Ford V-8 351 - Continued			Cummins 4-Cyl. 3.9 L Diesel		
Hose - Lower		26502	Hose - Upper - Eng. To Pipe		24428
210			Hose - Upper - Pipe To Rad.		24428
Cummins V378			Hose - Lower		26522
Belt - Fan To Alt.	178473	▲9350HD	RT500C		
Belt - Fan & W.P.	178685	②TR22485	Cummins 6-Cyl. 5.9 L Diesel		
Hose - Upper - Eng. To Pipe (Left Side)		≧<20206	Belt - Fan & Alt.	3911563	▲K080605HD
Hose - Upper - Pipe To Rad. (Left Side)		24932	Hose - Upper		②24432
Hose - Upper - Right Side		26511	Hose - Lower - Eng. To Pipe		24436
Hose - Lower		26521	Hose - Lower - Pipe To Rad.		24440
Grove			RT500DXL		
64-18			Cummins 6-Cyl. 5.9 L Diesel		
Detroit Diesel 6V-53 Diesel			Belt - Fan & Alt.		②▲9690HD
Belt - Fan	5126768	②▲9505HD	RT522		
Belt - W.P. & Idler	5139228	②7370	Detroit Diesel 4-53 Diesel		
Belt - Alt.		②7375	Belt - Fan & Compr.; W/60 1/4" Belt O.C.		②▲9600HD
Hose - Upper - Right Side		26502	Belt - W.P. & Alt.; W/90A. Alt.; W/43 1/8" Belt O.C.		②7430
Hose - Upper - Left Side		26502	Hose - Upper - Eng. To Pipe		24228
Hose - Lower		26507	Hose - Upper - Pipe To Rad.		24228
68			Hose - Lower - Eng. To Pipe		24232
Ford 6-Cyl. 300			Hose - Lower - Pipe To Rad.		24232
Belt - Fan		▲9447HD	RT625		
Belt - W.P. & Alt.		7417	Cummins V504 Diesel		
Belt - Alt. To Gov.	C7JZ 8620 P	7260	Belt - Fan To Alt.; W/50 1/8" Belt O.C.		②7500
Belt - Compr.		▲9476HD	Belt - Fan & W.P.; W/50" Belt O.C.		②TR22495
Hose - Upper		25530	Hose - Upper		26511
Hose - Lower		26505	Hose - Lower		26529
4420G			RT630		
Cummins V-8 210 Diesel			Caterpillar 3208 Diesel		
Belt - Fan & W.P.	178598	②TR22495	Belt - Fan & W.P.; W/43 1/4" Belt O.C.		②▲9430HD
Hose - Upper - Eng. To Pipe		24232	Belt - W.P., Alt. & Compr.; W/68 1/4" Belt O.C.		▲9680HD
Hose - Upper - Pipe To Rad.		24232	Hose - Upper		26510
Hose - Lower		26510	Hose - Lower - Eng. To Pipe		24232
8435G			Hose - Lower - Pipe To Rad.		24236
Detroit Diesel 6-71 Diesel			Cummins V504 Diesel		
Belt - Fan		②▲9560HD	Belt - Fan & W.P.		②TR22392
Belt - Gen.		▲9412HD	Belt - Fan To Alt.		②7395
Hose - Upper		26517	Hose - Upper		26523
Hose - Lower		26517	RT745		
AP206			Caterpillar 3208 Diesel		
Continental TMD27 Diesel			Belt - Fan		②▲9400HD
Belt - Fan & Alt.		▲9480HD	Belt - W.P.		②▲9495HD
Hose - Upper		25804	Belt - W.P., Alt. & Hyd. Pump		②▲9650HD
Hose - Lower		②24228	Hose - Upper		26526
RT48			Hose - Lower - Eng. To Pipe		24432
Ford 6-Cyl. 300 Diesel			Hose - Lower - Pipe To Rad.		24432
Belt - Fan		TR22405	TM2500		
Belt - W.P. & Alt.		7410	M.A.N. D2566MTE Diesel		
Belt - Gov.		7260	Belt - Fan & Idler		▲9490HD
Hose - Upper		26505	Belt - Alt.		②▲9470HD
Hose - Lower		26505	Hamm		
RT59S			2210		
Detroit Diesel 4-53 Diesel			Deutz F3L912 Diesel		
Belt - Fan & Compr.		②▲9490HD	Belt - Alt.		7590
Belt - W.P. & Alt.		②7448			
Hose - Upper		26611			
Hose - Lower		26508			

▲Standard Belt Available.
≧<Cut to Fit.

②Two Required.

Road & Construction
Equipment

Belts and Coolant Hose for Road & Construction Equipment

Application	Mfr. Part No.	Our No.	Application	Mfr. Part No.	Our No.
Hamm - Continued			Huber-Warco - Continued		
HC100; HC120			5-8 Ton - Continued		
Deutz F2L511 Diesel			Hercules G2000		
Belt - Alt.		7370	Belt - Fan & Gen.		204163A ♣9530HD
Herc			Hose - Upper 25480		
14YD			Hose - Lower 24226		
Detroit Diesel 4-53 Diesel			Hercules GO173		
Belt - Fan - Front Eng.		③♣9451HD	Belt - Fan & Gen.		♣9520HD
Belt - Fan - Rear Eng.		13AV1075 ②♣9425HD	Hercules QXC5		
Belt - Alt. - Front Eng.		A33 ②♣9341HD	Belt - Fan & Hyd. Pump		BG989 TR28492
Belt - Alt. - Rear Eng.		5133173 ②7420	Belt - W.P.		8T1356 ♣9530HD
Hose - Upper - Front Eng.		24932	6D2		
Hose - Upper - Rear Eng.		24932	Cummins JN6BI Diesel		
Hose - Lower - Front Eng.		24932	Belt - Fan		109179 ②♣9385HD
Hose - Lower - Rear Eng.		24932	Belt - W.P.		111726 TR22329
Hose - By Pass		24216	Belt - Gen.		70885 TR22461
Hitachi			7D2		
UH20; UH30			Cummins JB15 Diesel		
Isuzu E120 Diesel			Belt - Fan		106258 ②♣9365HD
Belt - Fan & Alt.; W/Left & Right Eng.		9136713380 ③TR20619	8-10 Ton		
Belt - Hyd. Pump; W/Left Eng.		TR22570	Detroit Diesel 2-71 Diesel		
Belt - Hyd. Pump; W/Right Eng.		TR22485	Hose - Upper		25473
UH062			Hose - Lower		24226
Isuzu 6BD1 Diesel			Hercules DOOC Diesel		
Belt - Fan & Alt.		5136710160 ②TR22474	Belt - Fan & Hyd. Pump		L3403 TR28514
UH122; UH172			Belt - Gen.		27290A TR28390
Isuzu E120 Diesel			Hercules G2000		
Belt - Fan & Alt.; W/Left & Right Eng.		9136713380 ③TR20619	Belt - Fan & Gen.		204163A ♣9530HD
Hose - Lower		21115	Hose - Upper		25480
Huber-Warco			Hose - Lower		24226
3-5 Ton			Hercules GO173		
Hercules IXB			Belt - Fan & Gen.		♣9520HD
Belt - Fan & Gen.		3T1613 TR28423	Hercules QXC5		
Hose - Lower		≈20563	Belt - Fan & Hyd. Pump		BG989 TR28492
Hose - By Pass		24220	Belt - W.P.		8T1356 ♣9530HD
4-6 TON			8-12 Ton		
Hercules IXB			Continental F226		
Belt - Fan & Gen.		81294A TR28423	Hose - Upper		25480
Hose - Lower		≈20563	Hose - Lower		25480
Hose - By Pass		24220	Detroit Diesel 2-71 Diesel		
5 Ton			Hose - Upper		25476
Hercules DOOC Diesel			Hose - Lower		25480
Belt - Fan; W/3-Wheels		L3403 TR28514	Hercules GO226		
Belt - Gen.; W/3-Wheels		27290A TR28390	Belt - Fan & Gen.		♣9530HD
5-6 Ton			Belt - W.P.		8T1356 ♣9530HD
Hercules QXC5			Hercules JXD		
Belt - Fan; W/3-Wheels		BG989 TR28492	Belt - W.P.		8T1356 ♣9530HD
5-8 Ton			Hercules QXC5		
Detroit Diesel 2-71 Diesel			Belt - Fan		TR28483
Hose - Upper		25473	Belt - W.P.		8T1356 ♣9530HD
Hose - Lower		24226	9D		
Hercules DOOC Diesel			Detroit Diesel 3-71 Diesel		
Belt - Fan & Hyd. Pump		L3403 TR28514	Belt - Fan		5170972 ②TR22455
Belt - Gen.		27290A TR28390	Belt - Gen.		3224367 TR28390

♣Standard Belt Available.
②Two Required.

③Three Required.
≈Cut to Fit.

Belts and Coolant Hose for Road & Construction Equipment

Application	Mfr. Part No.	Our No.	Application	Mfr. Part No.	Our No.
Huber-Warco - Continued			Huber-Warco - Continued		
10 Ton			M150; M180		
Caterpillar D311H Diesel			Continental F162		
Belt - Fan	B762	TR30428	Belt - Fan	BG1215	TR28545
Belt - Hyd. Pump	L7399	TR28557	Maintainer		
Hercules GO339			Continental F162		
Belt - Fan		TR24438	Belt - Fan & Gen.	F401K200	TR24465
Belt - Hyd. Pump	L3585	TR24400	Hose - Upper		25473
10-14 Ton			Hose - Lower		25478
Continental F226			Continental GD193 Diesel		
Hose - Upper		25480	Belt - Fan & Gen.	GD193K210	▲9440HD
Hose - Lower		25480	Hose - Lower		25473
Detroit Diesel 2-71 Diesel			Three Wheel		
Hose - Upper		25476	Detroit Diesel 2-71 Diesel		
Hose - Lower		25480	Hose - Upper		26508
Hercules GO226			Hose - Lower		26508
Belt - Fan & Gen.		▲9530HD	Hercules G3400		
Belt - W.P.	8T1356	▲9530HD	Belt - Fan & Gen.	204163A	▲9530HD
10D			Hose - Upper		26512
Cummins C160CI Diesel			Hose - Lower		26512
Belt - Fan	124421	②TR24365	Hercules GO339		
Belt - Gen.	70885	TR22461	Belt - Fan & Gen.	204163A	▲9530HD
Cummins H135CI Diesel			Hughes-Keenan		
Belt - Fan	70524	②TR22410	V6 Roustabout; V10 Roustabout		
Detroit Diesel 4-71 Diesel			Chrysler Ind.		
Belt - Fan	5170972	②TR22455	Belt - Fan		TR22648
Belt - Gen.	3224367	TR28390	Belt - W.P. & Gen.		TR22485
11D			VH10 Roustabout		
Cummins H6CI Diesel			Chrysler Ind.		
Belt - Fan	70524	②TR22410	Belt - Fan		BX71
Detroit Diesel 6-71 Diesel			Belt - W.P. & Gen.		TR22455
Belt - Fan	5170972	②TR22455	VH20 Roustabout		
Belt - Gen.	3224367	TR28390	Chrysler Ind.		
D1700			Belt - W.P. & Gen.		TR22455
Cummins HR160CI Diesel			Hydra-Mac		
Belt - Fan	172856	②TR24457	14C-VD		
Belt - Alt.		TR22350	Isuzu 3-Cyl. 43 Diesel		
Hose - Upper		26509	1989 - 1984		
Hose - Lower		26516	Belt - Fan & Alt.		▲9390HD
F1500			Hose - Upper		25476
Cummins V-8 470 Diesel			Hose - Lower		25487
Belt - Fan & W.P.	178600	②TR22525	Hyhoe		
Belt - Alt.	178409	▲9341HD	695		
Hose - Upper		≅20401	Detroit Diesel 4-53 Diesel		
	or	26524	Belt - Fan	5131395	②▲9412HD
Hose - Lower		24232	Belt - Gen. & W.P.	5133172	7430
Cummins V504 Diesel			Hose - Upper		≅21794
Belt - Fan & W.P.	178600	②TR22525		or	25474
Belt - Alt.	178409	▲9341HD	Hose - Lower - Eng. To Pipe		24232
Hose - Upper		26511	Hose - Lower - Pipe To Rad.		24232
Hose - Lower		26514	895		
M120			Detroit Diesel 6V-53 Diesel		
Hercules QXC5			Belt - Fan		②▲9405HD
Belt - Fan	BG989	TR28492	Belt - W.P. & Idler		②7365
			Belt - Gen.		7360
			Hose - Upper		②25530

▲Standard Belt Available.
≅Cut to Fit.

②Two Required.

Road & Construction
Equipment

Belts and Coolant Hose for Road & Construction Equipment

Road & Construction Equipment

Application	Mfr. Part No.	Our No.	Application	Mfr. Part No.	Our No.
Hyhoe - Continued			Hyster - Continued		
895 - Continued			C450A - Continued		
Detroit Diesel 6V-53 Diesel - Continued			Caterpillar D330 Diesel		
Hose - Lower		26508	Belt - Fan & Alt.		TR22517
Hyster			Hose - Upper		26526
C330A; C330B			Hose - Lower		26526
Onan L423 Diesel			C500		
Belt - Fan & Alt.	511014713	7490	Continental F244		
Belt - Hyd. Pump	172895	7375	Hose - Upper; Ser. No. A78L-1535, P-1530 & Before		
C340A			Hose - Upper; Ser. No. A78L-1536, P-1531 & After		
Chevrolet 6-Cyl. 250			Hose - Lower; Ser. No. A78L-1535, P-1530 & Before		
Belt - Fan & P.S.	86071	Ⓣ7470	Hose - Lower - Eng. To Pipe; Ser. No. A78L-1536,		
Belt - Alt.	148370	7330	P1531 & After		
Hose - Upper		25474	Hose - Lower - Pipe To Rad.; Ser. No. A78L-1536,		
Hose - Lower		25528	P1531 & After		
Perkins 4-Cyl. 236 Diesel			C500A		
Belt - Fan & Alt.	142526	♣9490HD	Caterpillar D311H Diesel		
Hose - Upper - Eng. To Pipe		25473	Belt - Fan		
Hose - Lower - Eng. To Pipe		20121	Belt - Fan		
		25480	Belt - Fan		
		25472	Belt - Fan		
Hose - Lower - Pipe To Rad.		25472	Belt - W.P.		
C350			C530		
Chevrolet 6-Cyl. 250			Chevrolet 6-Cyl. 230		
Hose - Upper		25474	Hose - Upper		
Hose - Lower		25530	Hose - Lower		
Detroit Diesel 3-53 Diesel			Perkins 4-Cyl. 236 Diesel		
Hose - Upper		26502	Hose - Upper		
Hose - Lower		26508	Hose - Lower		
Perkins 4-Cyl. 236 Diesel			Hose - Lower		
Hose - Upper		25474	or		
Hose - Lower - Eng. To Pipe		20573	25477		
		25527			
Hose - Lower - Pipe To Rad.		25472			
C350A; C350AD			C530A		
Chevrolet 6-Cyl. 250			Chevrolet 6-Cyl. 250		
Belt - Fan & P.S.; W/37 1/8" Belt O.C.	170087	Ⓣ7370	Belt - Fan & Alt.		
Belt - Fan & P.S.; W/38 1/8" Belt O.C.	155465	Ⓣ7380	Belt - P.S.		
Belt - Fan & P.S.; W/46 1/8" Belt O.C.	61807	Ⓣ7460	155442		
Belt - Alt.; W/38 1/8" Belt O.C.	155442	7380	A170087		
Belt - Alt.; W/66 1/4" Belt O.C.	148370	♣9660HD	Ⓣ7380		
Perkins 4-Cyl. 236 Diesel			Ⓣ7370		
Belt - Fan & Alt.	142526	♣9490HD	Perkins 4-Cyl. 236 Diesel		
Hose - Upper		25478	Belt - Fan & Alt.		
Hose - Lower		25528	142526		
C350D			♣9490HD		
Chevrolet 6-Cyl. 250			C610B; C612B		
Belt - Fan & P.S.; W/37 1/8" Belt O.C.	170087	Ⓣ7370	Detroit Diesel 3-53 Diesel		
Belt - Fan & P.S.; W/38 1/8" Belt O.C.	155465	Ⓣ7380	Hose - Upper		
Belt - Fan & P.S.; W/46 1/8" Belt O.C.	61807	Ⓣ7460	Hose - Upper		
Belt - Alt.; W/38 1/8" Belt O.C.	155442	7380	Perkins 4-Cyl. 236 Diesel		
Belt - Alt.; W/66 1/4" Belt O.C.	148370	♣9660HD	Hose - Upper		
Perkins 4-Cyl. 236 Diesel			C615A		
Belt - Fan & Alt.	142526	♣9490HD	Detroit Diesel 3-53 Diesel		
Hose - Upper		25478	Belt - Fan		
Hose - Lower		25528	Belt - W.P. & Alt.		
C450A			Hose - Upper		
Caterpillar D311H Diesel			Hose - Lower - Eng. To Pipe		
Hose - Upper		25480	Hose - Lower - Pipe To Rad.		
Hose - Lower		25480	24232		
			24232		
			C615B		
			Detroit Diesel 3-53 Diesel		
			Hose - Upper		
			Perkins 4-Cyl. 236 Diesel		
			Hose - Upper		
			C617B		
			Detroit Diesel 3-53 Diesel		
			Belt - Fan		
			Belt - W.P. & Alt.		
			Hose - Upper		

ⓉTwo Required.
 ⓧCut to Fit.

♣Standard Belt Available.

Belts and Coolant Hose for Road & Construction Equipment

Application	Mfr. Part No.	Our No.	Application	Mfr. Part No.	Our No.
Hyster - Continued			ICC - Continued		
C617B - Continued			DL7000		
Perkins 4-Cyl. 236 Diesel			Cummins 4-Cyl. 3.9 L Diesel		
Hose - Upper		25526	Hose - Upper		20573
C624B; C625B; C627B			Ingersoll		
Detroit Diesel 3-53 Diesel			185		
Hose - Upper		25474	John Deere 4239D Diesel		
Perkins 4-Cyl. 236 Diesel			Belt - Fan		7425
Hose - Upper		25526	Belt - Alt.		TR22495
C727A			Hose - Upper - Eng. To Pipe		25478
John Deere 6466D Diesel			Hose - Upper - Pipe To Rad.		24224
Hose - Lower		26528	Hose - Lower - Eng. To Pipe		≈20452
C748A			Hose - Lower - Pipe To Pipe		24224
Cummins 4-Cyl. 3.9 L Diesel			Hose - Lower - Pipe To Rad.		25477
Belt - Fan & Alt.	3911563	♣K080605HD	CM695D		
C832A			Caterpillar 3306 Diesel		
Cummins 4-Cyl. 3.9 L Diesel			Belt - Fan, Alt. & A.C.		②BX71
Hose - Upper		26611	D5000		
C852A			Detroit Diesel 4-71 Diesel		
Caterpillar 3208 Diesel			Belt - Fan	5139026	②♣9420HD
Belt - Fan		②♣9500HD	Belt - Gen.		♣9463HD
Hose - Lower		≈21194	Belt - Compr.		♣9480HD
Detroit Diesel V-8 8.2 L Diesel			D6000		
Belt - Fan & Alt.		②♣9740HD	Detroit Diesel 6-71 Diesel		
Hose - Upper		26516	Belt - Fan		②♣9430HD
C852B			Belt - Gen.	5133515	♣9370HD
Caterpillar 3208 Diesel			Hose - Upper		≈20046
Hose - Lower		≈21194	Hose - Lower - Eng. To Pipe		24432
Detroit Diesel V-8 8.2 L Diesel			Hose - Lower - Pipe To Rad.		24432
Belt - Fan & Alt.		②♣9700HD	D7505		
Hose - Upper		26516	Cummins V903 Diesel		
K360B			Belt - Alt.	178662	②♣9510HD
Detroit Diesel 4-53N Diesel			Hose - Upper - Eng. To Pipe (Left)		≈20397
Belt - W.P. & Alt.		②7417	Hose - Upper - Eng. To Pipe (Right)		24436
Belt - Air Brake Compr. & Idler		②♣9530HD	Hose - Upper - Pipe To Rad.		24936
KE			Hose - Lower		24444
Continental F162; Continental F163			DA40		
Hose - Upper; W/10 1/2" Hose		25473	Detroit Diesel 3-53 Diesel		
Hose - Upper; W/15 1/2" Hose		25477	Belt - Fan & Alt.	5133172	7430
Hose - Lower		24224	L64MH		
Perkins 4-Cyl. 203 Diesel			Kubota D905PG		
Hose - Upper		25474	Belt - Fan	FM376	7385
Hose - Lower		≈20450	SD70		
or		25474	Cummins 4-Cyl. 3.9 L Diesel		
Perkins P4 Diesel			Belt - Fan & Alt.		♣K080537HD
Hose - Lower		≈20065	SP42		
ICC			Ford 2514E		
6000W			Hose - Upper		≈20573
Kubota 900 Diesel			or		25473
Belt - Fan		7365	Hose - Lower		26502
DL6000			IH UD236 Diesel		
Continental TMD27 Diesel			Belt - Fan & Alt.	670261C1	♣9505HD
Hose - Upper		20121	Hose - Upper		26510
			SP54		
			Detroit Diesel 4-53 Diesel		
			Belt - Fan	5130529	②♣9451HD

♣Standard Belt Available.
≈Cut to Fit.

②Two Required.

Belts and Coolant Hose for Road & Construction Equipment

Application	Mfr. Part No.	Our No.	Application	Mfr. Part No.	Our No.
Ingersoll - Continued			Insley - Continued		
SP54 - Continued			H1500		
Detroit Diesel 4-53 Diesel - Continued			Detroit Diesel 6-71 Diesel		
Belt - W.P. & Gen.		7410	Belt - Fan		②♣9440HD
Hose - Upper		≈<20046	Belt - Alt.		♣9480HD
		or	Belt - A.C.		②♣9400HD
Hose - Lower		26502	Hose - Upper		26516
		26507	Hose - Lower		26518
T4			International		
Detroit Diesel 8V-71 Diesel			2T551		
Belt - Gen.	5133516	②♣9380HD	Cummins HRBI Diesel		
Detroit Diesel 12V-71 Diesel			Belt - Fan		
Hose - Upper		②26532		S1792	②TR22405
Hose - Lower		24256	Belt - Gen.	134814	TR22350
XP750			55		
Detroit Diesel 6V-71N Diesel			Cummins HRBI Diesel; Cummins NTO6BI Diesel		
Hose - Upper - Eng. To Pipe		②24436	Belt - Fan & W.P.	S1792	TR22405
Hose - Upper - Pipe To Rad.		②24436	Hose - Upper - Eng. To Pipe		23533
Hose - Lower - Eng. To Pipe		24440	Hose - Upper - Pipe To Rad.		23533
XP750WJD			Hose - Lower		
John Deere 6076A Diesel			23533		
Belt - Fan		♣9710HD	65		
Ingram			Cummins NRT6BI Diesel; Cummins NRT06BI Diesel		
9-2800			Belt - Fan; W/11/16" Belt T.W.; W/46 5/8"		
IH 6-Cyl. 221 Diesel			Belt O.C.	S2295	②TR22461
Hose - Upper		≈<20611	Belt - Fan; W/5/8" Belt T.W.; W/47 1/8" Belt O.C.		TR24465
Hose - Lower - Eng. To Pipe		24232	Belt - Fan; W/15/16" Belt T.W.; W/54 3/4"		
Hose - Lower - Pipe To Rad.		24232	Belt O.C.	S3180	②TR30543
10 Ton			Belt - W.P.	S3163	TR22434
Detroit Diesel 3-53 Diesel			65C		
Belt - Fan		②♣9412HD	IH DVT573 Diesel		
Belt - W.P. & Alt.		②♣9420HD	Belt - Fan	328927R11	②TR28680
Hose - Upper		≈<20957	Belt - W.P.	345013R1	TR22455
Hose - Lower - Eng. To Pipe		≈<20882	Belt - Gen. & Air Brake Compr.	341190R1	TR22474
Hose - Lower - Pipe To Rad.		≈<20882	IH DVT573B Diesel		
11-5400			Belt - Fan; Eng. No. 7500 & After		
Detroit Diesel 3-71 Diesel				673949C91	②TR22692
Belt - Fan	5139026	②♣9420HD	Belt - Alt.; Eng. No. 7500 & After	673950C1	♣9490HD
Belt - Gen.	5133517	♣9390HD	Belt - P.S.	611802C1	TR28545
Hose - Upper		26603	75		
Hose - Lower - Eng. To Pipe		24232	Cummins HRBI Diesel; Cummins NTO6BI Diesel		
Hose - Lower - Pipe To Rad.		24232	Belt - Fan & W.P.		
Insley					
H560B			Belt - Fan & W.P.		
Detroit Diesel 4-53 Diesel			S1792		
Belt - Fan		②♣9390HD	TR22405		
Belt - W.P. & Gen.		②7405	Hose - Upper - Eng. To Pipe		
Hose - Upper		25474	23533		
Hose - Lower		26507	Hose - Upper - Pipe To Rad.		
H875			23533		
Detroit Diesel 6-71 Diesel			Hose - Lower		
Belt - Fan	5126767	②♣9455HD	23533		
Belt - Gen.		♣9380HD	95		
Hose - Upper		26611	IH D817 Diesel; IH DT817 Diesel		
Hose - Lower		26520	Belt - Fan & Gen.; W/48 1/4" Belt O.C.		
Insley			310081R2		
H560B			♣9480HD		
Detroit Diesel 4-53 Diesel			Belt - Fan & Gen.; W/52 3/8" Belt O.C.		
Belt - Fan		②♣9390HD	TR22517		
Belt - W.P. & Gen.		②7405	Belt - Air Brake Compr.		
Hose - Upper		25474	278714R1		
Hose - Lower		26507	TR24515		
H875			100 Hauler		
Detroit Diesel 6-71 Diesel			IH DT817 Diesel		
Belt - Fan		②♣9455HD	Belt - Fan & Alt.		
Belt - Gen.		♣9380HD	323987R3		
Hose - Upper		26611	♣9465HD		
Hose - Lower		26520	Belt - Air Brake Compr.		
Insley			278714R1		
H560B			TR24515		
Detroit Diesel 4-53 Diesel			100B		
Belt - Fan		②♣9390HD	IH DT817B Diesel		
Belt - W.P. & Gen.		②7405	Belt - Fan & Alt.		
Hose - Upper		25474	670464C1		
Hose - Lower		26507	TR22578		
H875			Belt - Air Brake Compr.		
Detroit Diesel 6-71 Diesel			278714R1		
Belt - Fan		②♣9455HD	TR24515		
Belt - Gen.		♣9380HD			
Hose - Upper		26611			
Hose - Lower		26520			

≈<Cut to Fit.
②Two Required.

♣Standard Belt Available.

Belts and Coolant Hose for Road & Construction Equipment

Application	Mfr. Part No.	Our No.	Application	Mfr. Part No.	Our No.
International - Continued			International - Continued		
100E			180 - Continued		
IH D239 Diesel			Detroit Diesel 16V-71 Diesel - Continued		
Belt - Fan	621770C1	♣9555HD	Hose - Upper - Pipe To Rad.		24248
Hose - By Pass		≧20267	250		
125C			IH DT429 Diesel		
IH D239 Diesel			Belt - Fan & Gen.	326998R1	③TR22570
Belt - Fan & W.P.	621770C1	♣9555HD	Belt - W.P.	328502R1	TR22485
Hose - Lower		26508	Hose - Upper - Eng. To Pipe		24240
140			Hose - Upper - Pipe To Rad.		24240
IH DT817B Diesel			Hose - Lower - Eng. To Pipe		24248
Belt - Fan	600168C11	②♣9610HD	Hose - Lower - Pipe To Rad.		24248
Belt - Alt.	670464C1	TR22578	Hose - By Pass		②24224
Belt - Air Brake Compr.	332338R1	TR24489	250B		
150 Crawler			IH DT429 Diesel		
IH DT282 Diesel			Belt - Fan & Alt./Gen.	670741C1	②TR22570
Belt - Fan; W/Man. Trans.	328540R1	TR28575	Belt - W.P.	328502R1	TR22485
Belt - Fan; W/Power Shift Trans.		TR28616	250C		
Belt - Alt.	670572C1	TR22495	IH DVT573B Diesel		
Belt - Gen.	306658R1	TR22514	Belt - Alt.; Eng. No. 7500 & After	673947C1	♣9447HD
Hose - Upper		26511	270		
Hose - Lower		26507	IH DVT573B Diesel		
Hose - By Pass		28441	Belt - Fan; Eng. No. 7500 & After	673949C91	TR22692
175			Belt - Alt.; Eng. No. 7500 & After	673950C1	♣9490HD
IH DT361 Diesel			Hose - Upper - Eng. To Pipe		24228
Hose - Upper; Ser. No. 9601 Thru 10125		26520	Hose - Upper - Pipe To Rad.		24228
Hose - Upper; Ser. No. 10126 & After		≧20459	Hose - Lower		24248
or		26521	295		
Hose - Lower - Eng. To Pipe; Ser. No. 9601 & After		24236	IH DT817 Diesel		
Hose - Lower - Pipe To Rad.; Ser. No. 9601 & After		24228	Belt - Fan & Gen.	323987R1	♣9465HD
Hose - By Pass; Ser. No. 9601 Thru 10125		24224	Belt - Air Brake Compr.	332338R1	TR24489
IH DT407 Diesel			Hose - Upper - Eng. To Pipe		24246
Belt - Fan & Gen.	304071R11	②TR24709	Hose - Upper - Pipe To Rad.		24246
175B			Hose - Lower		24256
IH DT361 Diesel; IH DT407 Diesel			295B		
Belt - Fan & Alt.; Eng. No. 32317 & After	670711C1	②TR22692	IH DT817B Diesel		
Belt - Fan & Gen.; Eng. No. 32317 & Before	326758R11	②TR22720	Belt - Fan & Alt.	670464C1	TR22578
175C			Belt - Air Brake Compr.	332338R1	TR24489
IH DT466 Diesel			Hose - Upper - Eng. To Pipe		24236
Belt - Fan & Alt.	673482C1	②TR22648	Hose - Upper - Pipe To Rad.		24236
Hose - Upper		21308	Hose - Lower		24256
Hose - Lower		≧20744	330; 340		
180			IH DT817B Diesel		
Cummins VT1710 Diesel			Belt - Fan	600168C11	②♣9610HD
Belt - Fan		③♣9610HD	Belt - Alt.	670464C1	TR22578
Belt - W.P.	178665	②TR28390	Belt - Air Brake Compr.	332338R1	TR24489
Belt - Alt.	178520	②♣9380HD	350		
Hose - Upper - Eng. To Pipe		24240	Detroit Diesel 12V-71 Diesel		
Hose - Upper - Pipe To Rad.		24240	Belt - Fan	600168C11	③♣9610HD
Hose - Lower - Eng. To Pipe		24264	Belt - Alt.; W/30A. Alt.	643446C1	♣9305HD
Hose - Lower - Pipe To Rad.		24256	Belt - Alt.; W/50A. Alt.	284583C2	♣9313HD
Detroit Diesel 12V-71 Diesel			Belt - Air Brake Compr.	670740C1	TR22570
Belt - Fan	600168C1	③♣9610HD	Hose - Upper - Eng. To Pipe		24448
Belt - Alt.	643446C1	♣9305HD	Hose - Upper - Pipe To Rad.		24448
Hose - Upper - Eng. To Pipe		24240	Hose - Lower - Eng. To Pipe		24464
Hose - Upper - Pipe To Rad.		24240	Hose - Lower - Pipe To Rad.		24464
Detroit Diesel 16V-71 Diesel			412		
Hose - Upper - Eng. To Pipe		24248	IH DT466 Diesel		
180 - Continued			Belt - Alt.	673489C1	②TR22625

≧Cut to Fit.
②Two Required.

♣Standard Belt Available.
③Three Required.

Road & Construction Equipment

Belts and Coolant Hose for Road & Construction Equipment

Application	Mfr. Part No.	Our No.	Application	Mfr. Part No.	Our No.
International - Continued			International - Continued		
412 - Continued			442 - Continued		
IH DT466 Diesel - Continued			IH DVT800 Diesel - Continued		
Belt - Fan & Alt.	683548C91	②TR22664	Belt - A.C.	683341C91	②♣9590HD
Belt - Air Brake Compr.	673089C1	TR22405	Hose - Upper - Eng. To Pipe		24428
Belt - A.C.	683448C1	TR22448	Hose - Upper - Pipe To Rad.		24428
Hose - Upper - Eng. To Pipe		24240	Hose - Lower		24448
Hose - Upper - Pipe To Rad.		24240			
431			442B		
IH DT466 Diesel			IH DVT800 Diesel		
Belt - Fan	673949C91	③TR22692	Belt - Alt.	673947C1	♣9447HD
Belt - Alt.	673950C1	TR22485	Belt - A.C.	683341C91	②♣9590HD
IH DVT800 Diesel			444		
Belt - Fan & W.P.	673948C1	③TR22692	IH DT466 Diesel		
Belt - Fan & Air Brake Compr.		③BX71	Belt - Fan	673949C91	③TR22692
Belt - Alt.	673947C1	♣9447HD	Belt - Fan & Alt.	673481C91	②TR22648
Belt - A.C.	683341C91	②♣9590HD	Belt - Alt.	673950C1	TR22485
Hose - Upper - Eng. To Pipe		24428	Hose - Upper - Eng. To Pipe		24236
Hose - Upper - Pipe To Rad.		24428	Hose - Upper - Pipe To Rad.		24236
Hose - Lower		24448	IH DVT800 Diesel		
431B			Belt - Fan & W.P.		
IH DVT800 Diesel			Belt - Fan & Air Brake Compr.		
Belt - Alt.	673947C1	♣9447HD	Belt - Alt.		
Belt - A.C.	683341C91	②♣9590HD	Belt - A.C.		
433			Hose - Upper - Eng. To Pipe (Front Eng.)		
IH DT466 Diesel			Hose - Upper - Pipe To Rad. (Front Eng.)		
Belt - Fan	673949C91	③TR22692	Hose - Upper - Eng. To Pipe (Rear Eng.)		
Belt - Alt.	673950C1	TR22485	Hose - Upper - Pipe To Rad. (Rear Eng.)		
Belt - Fan & Alt.	673481C91	②TR22648	Hose - Lower		
Hose - Upper - Eng. To Pipe		24436	444B		
Hose - Upper - Pipe To Rad.		24436	IH DT466 Diesel		
Hose - Lower		24446	Belt - Fan & Alt.		
IH DVT800 Diesel			Belt - Fan & Alt.		
Belt - Fan & W.P.	673948C1	③TR22692	Belt - Alt.		
Belt - Fan & Air Brake Compr.		③BX71	Belt - A.C.		
Belt - Alt.	673947C1	♣9447HD	Hose - Upper - Eng. To Pipe		
Belt - A.C.	683341C91	②♣9590HD	Hose - Upper - Pipe To Rad.		
Hose - Upper - Eng. To Pipe		24428	Hose - Lower		
Hose - Upper - Pipe To Rad.		24428	444B		
Hose - Lower		24448	IH DT466 Diesel		
433B			Belt - Fan & Alt.		
IH DT466 Diesel			Belt - Fan & Alt.		
Belt - Fan		②♣9670HD	Belt - Alt.		
Belt - Fan & Alt.	673481C91	②TR22648	Belt - A.C.		
Hose - Upper - Eng. To Pipe		24436	Hose - Upper - Eng. To Pipe		
Hose - Upper - Pipe To Rad.		24436	Hose - Upper - Pipe To Rad.		
Hose - Lower		24446	Hose - Lower		
IH DVT800 Diesel			2500 Constructall		
Belt - Alt.	673947C1	♣9447HD	IH C153		
Belt - A.C.	683341C91	②♣9590HD	Belt - Fan & Alt.		
Hose - Upper - Eng. To Pipe		24428	Belt - Fan & Gen.		
Hose - Upper - Pipe To Rad.		24428	Hose - Upper		
Hose - Lower		24448	Hose - Lower		
442			Hose - By Pass		
IH DT466 Diesel			IH D188 Diesel		
Belt - Fan	673949C91	③TR22692	Belt - Fan		
Belt - Alt.	673950C1	TR22485	Belt - W.P. & Gen.		
IH DVT800 Diesel			Hose - Upper		
Belt - Fan & W.P.	673948C1	③TR22692	Hose - Lower - Eng. To Pipe		
Belt - Fan & Air Brake Compr.		③BX71	Hose - Lower - Pipe To Rad.		
Belt - Alt.	673947C1	♣9447HD	Hose - By Pass		
442B			3400A		
IH DT466 Diesel			IH C175		
Belt - Fan	673949C91	③TR22692	Belt - Fan & Alt.		
Belt - Alt.	673950C1	TR22485	Belt - Lower		
IH DVT800 Diesel			Belt - Lower		
Belt - Fan & W.P.	673948C1	③TR22692	532030R2		
Belt - Fan & Air Brake Compr.		③BX71	7516		
Belt - Alt.	673947C1	♣9447HD	♣21660		
442B			or		
IH DVT800 Diesel			25474		
Belt - Fan & W.P.	673948C1	③TR22692			
Belt - Fan & Air Brake Compr.		③BX71			
Belt - Alt.	673947C1	♣9447HD			

③Three Required.
②Two Required.

♣Standard Belt Available.
♣<Cut to Fit.

Belts and Coolant Hose for Road & Construction Equipment

Application	Mfr. Part No.	Our No.	Application	Mfr. Part No.	Our No.
International - Continued			International - Continued		
3400A - Continued			3820A		
IH D179 Diesel			IH D310 Diesel		
Belt - Fan & Alt.	534310R1	▲9630HD	Belt - Fan & Alt.	530076R1	▲9640HD
Hose - Upper		26503	Belt - W.P. & Alt.	396543R1	▲9640HD
3444			3850		
IH BC144; IH BD154 Diesel			IH C263		
Belt - Fan; W/31 3/4" Belt O.C.	48878D	▲9313HD	Belt - Fan	378113R2	▲9480HD
Belt - Fan; W/34 3/4" Belt O.C.	376371R1	TR22344	Belt - W.P. & Gen.	403348R1	▲9463HD
Belt - Alt.	401691R1	▲9341HD	Hose - By Pass		20338
3514			IH D282 Diesel		
IH 4-Cyl. 153			IH 6-Cyl. 358 Diesel		
Belt - Fan		▲9490HD	Belt - Fan & Alt.		②▲9630HD
Belt - W.P. & Gen.	151529R1	7440	Hose - Upper		26512
Hose - Upper		26510	Hose - Lower		26511
Hose - Lower		24222	Hose - By Pass		24232
Hose - By Pass		28439	3964		
IH 4-Cyl. 175			IH 6-Cyl. 358 Diesel		
Belt - Fan & Alt.	403303R1	7545	Belt - Fan & Alt.		②▲9625HD
IH 4-Cyl. 188 Diesel			3984		
Belt - Fan	385674R1	▲9490HD	IH 6-Cyl. 358 Diesel		
Belt - W.P. & Gen.	315969R1	▲9490HD	Belt - Fan & Alt.		②▲9625HD
Hose - Upper		26510	Hose - Upper		26508
Hose - Lower		24232	Hose - Lower		26511
Hose - By Pass		20338	C9A		
IH 4-Cyl. 239 Diesel			IH Diesel		
Belt - Fan & Alt.; W/Syncro Mesh Trans.	403303R1	7545	Belt - Fan & Alt.	886010C91	▲9360HD
Belt - Fan & Alt.; W/O Syncro Mesh Trans. .	401128R1	▲9580HD	E200		
3600; 3600A			IH DT414 Diesel		
IH C263			IH DT407 Diesel		
Belt - Fan	406097R1	▲9570HD	Belt - Fan & Gen.	612175C11	②TR22664
Belt - W.P. & Alt.	393415R1	▲9470HD	Belt - A.C.	345236R1	7420
IH D282 Diesel			E270		
Belt - Fan	406097R1	▲9570HD	IH DVT573 Diesel		
Belt - W.P. & Alt.		▲9490HD	Belt - Fan	328927R11	②TR28680
Hose - Upper		26510	Belt - W.P.	345013R1	TR22455
Hose - Lower		26507	Belt - Gen. & Air Brake Compr.	341190R1	TR22474
3616			3800		
IH 6-Cyl. 221			IH C263		
Belt - Fan	403348R1	▲9463HD	Belt - Fan	378113R2	▲9480HD
Belt - W.P. & Gen.	403348R1	▲9463HD	Belt - W.P. & Gen.	403348R1	▲9463HD
Hose - By Pass		20338	Hose - By Pass		20338
IH 6-Cyl. 236 Diesel			IH D282 Diesel		
Belt - Fan	403348R1	▲9463HD	Belt - Fan	385674R1	▲9490HD
Belt - W.P. & Gen.		▲9490HD	Belt - W.P. & Gen.	316250R1	▲9490HD
3820			3820		
IH D310 Diesel			IH D310 Diesel		
Hose - Lower - Eng. To Pipe		≧<20206	Hose - Lower - Eng. To Pipe		≧<20206
Hose - Lower - Pipe To Rad.		≧<20206	Hose - Lower - Pipe To Rad.		≧<20206

▲Standard Belt Available.
②Two Required.

≧<Cut to Fit.

Road & Construction Equipment

Belts and Coolant Hose for Road & Construction Equipment

Application	Mfr. Part No.	Our No.	Application	Mfr. Part No.	Our No.
International - Continued			Jaeger - Continued		
T225; T225SL; T300; T300SL			160 - Continued		
IH			Continental M330 - Continued		
Belt - Fan & W.P.	133500R11	TR22434	Belt - Intercooler		TR24438
Belt - Alt.; Eng. No. 335 & Before	154849H2	▲9319HD	IH UD9; IH UD9A		
Belt - Alt.; Eng. No. 336 & After	243608R1	▲9365HD	Belt - Fan	48042D	TR30484
T500S			Belt - Fuel Pump	49341D	▲9335HD
Detroit Diesel 6V-53 Diesel			Belt - Intercooler		TR24438
Belt - Fan & Alt.	528419R91	②TR22664	175A		
Belt - Air Brake Compr.	5130529	②▲9455HD	White G2300		
Hose - Upper - Eng. To Pipe		24244	Belt - Fan & Alt.		▲9490HD
Hose - Upper - Pipe To Rad.		24236	Hose - Upper		24928
Hose - Lower - Eng. To Pipe		24256	Hose - Lower		24928
Hose - Lower - Pipe To Rad.		24244	180		
T800S			Continental M330		
IH V-8 401			Belt - Fan	M330K229	TR30506
Belt - Fan	678186C1	②TR22455	Belt - Intercooler		TR24438
Belt - Alt.	358324C91	▲9455HD	IH UD9; IH UD9A		
IH V-8 402			Belt - Fan	48042D	TR30484
Belt - Alt.	358324C91	▲9455HD	Belt - Fuel Pump	49341D	▲9335HD
TD180FB; TD225SL			Belt - Intercooler		TR24438
Detroit Diesel 6V-53 Diesel			210		
Belt - Fan	5136268	②▲9610HD	Caterpillar D318 Diesel; Caterpillar D4600 Diesel		
TD300SL			Belt - Intercooler		TR24500
Detroit Diesel 6V-53 Diesel			Continental B427		
Belt - Fan	5136273	②▲9510HD	Belt - Fan	M330K229	TR30506
Jaeger			Belt - Intercooler		TR24500
60; 75			IH UD14 Diesel; IH UD14A Diesel		
Continental F140			Belt - Fan	30982D	TR32571
Belt - Fan	F140K215	TR28483	Belt - Fuel Pump	48878D	▲9309HD
75A; 75B; 85A; 85B			Belt - Intercooler		TR24500
Continental F140; Continental F162			250		
Belt - Fan	G157K208	TR24461	Caterpillar D318 Diesel; Caterpillar D4600 Diesel		
105			Belt - Intercooler		TR24500
Continental F226			Continental B427		
Belt - Fan	F140K215	TR28483	Belt - Fan	M330K200	TR32491
Belt - Intercooler		TR24438	Belt - Intercooler		TR24500
IH UD6; IH UD6A			Detroit Diesel 3-71 Diesel		
Belt - Fan	16131D	TR30467	Belt - Fan		③3600
Belt - Fuel Pump	48878D	▲9309HD	Belt - Gen.	3224367	TR28390
Belt - Intercooler		TR24438	IH UD14 Diesel; IH UD14A Diesel		
125			Belt - Fan	30982D	TR32571
Continental F226			Belt - Fuel Pump	48878D	▲9309HD
Belt - Fan	F140K215	TR28483	Belt - Intercooler		TR24500
Continental G193			315		
Belt - Fan	G193K201	▲9463HD	Continental R602		
Continental HD260 Diesel			Belt - Fan	R602K208	②TR28657
Belt - Fan		TR28501	IH UD18		
IH UD6; IH UD6A			Belt - Fan	42937DX	②TR28616
Belt - Fan	16131D	TR30467	Belt - Fuel Pump	49341D	▲9335HD
Belt - Fuel Pump		▲9309HD	Belt - Intercooler		TR24530
Belt - Intercooler		TR24438	IH UD18A		
160			Belt - Fan	251180R11	②TR28628
Continental M330			Belt - Fuel Pump	49341D	▲9335HD
Belt - Fan	M330K229	TR30506	Belt - Intercooler		TR24530

▲Standard Belt Available.

②Two Required.

Belts and Coolant Hose for Road & Construction Equipment

Application	Mfr. Part No.	Our No.	Application	Mfr. Part No.	Our No.
Jaeger - Continued			John Deere - Continued		
365			17G		
Cummins HRBI Diesel			Yanmar 3-Cyl. 61 Diesel		
Belt - Fan		TR22405	Belt - Fan	MIU800681	▲9350HD
Detroit Diesel 4-71 Diesel			24		
Belt - Fan		②3610	John Deere 3-Cyl. 152 Diesel		
Belt - Gen.	3224367	TR28390	1975 - 1970		
600			Belt - Fan & Alt.	T20334	TR22474
Detroit Diesel 6-71 Diesel			Hose - Upper; Early		25480
Belt - Fan		②3600	Hose - Upper; Late		≡20065
Belt - Gen.	3224367	TR28390		or	25526
IH UD24			Hose - Lower - Eng. To Pipe		24930
Belt - Fan		②CX68	Hose - Lower - Pipe To Rad.		≡20357
Belt - Intercooler		TR32571	Hose - By Pass		28439
Murphy ME66			Wisconsin VG4D		
Belt - Fan	MD6595	TR28733	1975 - 1970		
Belt - Intercooler		TR32571	Belt - Alt.	GG02032156	▲9319HD
900			25		
Detroit Diesel 6-110 Diesel			Yanmar 3TN78 Diesel		
Belt - Fan		③TR22664	Belt - Fan	M801821	▲9390HD
Belt - Gen.	5155911	TR28406	26G		
H			Yanmar 3-Cyl. 77 Diesel		
Continental			Belt - Fan	MIU800681	▲9350HD
Belt - Front P.T.O.; W/6-8 Yard Mixing			27C ZTS		
Capacity	30601188	3490	Isuzu 3-Cyl. 91 Diesel		
Belt - Front P.T.O.; W/9-10 Yard Mixing			Belt - Fan	8972606490	▲9335HD
Capacity	30601188	3490	Belt - A.C.	H81742	▲9530HD
Belt - Flywheel P.T.O.; W/6-8 Yard Mixing			27D		
Capacity	30601225	3680	Yanmar 3-Cyl. 100 Diesel		
Belt - Flywheel P.T.O.; W/9-10 Yard Mixing			Belt - Fan; Ser. No. 250001 & After	MIU800031	▲9395HD
Capacity	30601227	3690	Belt - A.C.	4615852	▲9345HD
Belt - Eng. Drive; W/6-8 Yard Mixing			27ZTS		
Capacity	30601187	3480	Isuzu 3-Cyl. 91 Diesel		
JCB			Belt - Fan; Ser. No. 220207 & Before	8972113170	7325
210S			Belt - Fan; Ser. No. 220208 & After	4445212	AX32
Perkins 1004 Diesel			35C ZTS		
Belt - Fan & Alt.		▲9590HD	Isuzu 3-Cyl. 91 Diesel		
406			Belt - Fan	8972606490	▲9335HD
Perkins 3-Cyl. Diesel			Belt - A.C.	H81742	▲9530HD
Belt - Fan & Alt.	2614B556	▲9530HD	35D		
Hose - Upper		25528	Yanmar 3-Cyl. 100 Diesel		
Hose - Lower - Eng. To Pipe		≡21794	Belt - Fan	MIU800031	▲9395HD
Hose - Lower - Cooler To Rad.		≡21794	Belt - A.C.	4615852	▲9345HD
1550B			35ZTS		
Perkins 4-Cyl. 236 Diesel			Isuzu 3-Cyl. 91 Diesel		
Belt - Fan & Alt.		▲9680HD	Belt - Fan; Ser. No. 230253 & Before	8972113170	7325
1700B			Belt - Fan; Ser. No. 230254 & After	4445212	AX32
Perkins 4-Cyl. 236 Diesel			50C ZTS		
Belt - Fan & Alt.		▲9570HD	Isuzu 4-Cyl. 133 Diesel		
Belt - A.C.		▲9313HD	Belt - Fan	8972606490	▲9335HD
John Deere			Belt - A.C.	H81742	▲9530HD
15			50D		
Yanmar 3TNA72 Diesel			Yanmar 4-Cyl. 134 Diesel		
Belt - Fan	M800347	7360	Belt - Fan	MIU800031	▲9395HD
			Belt - A.C.	4615852	▲9345HD

②Two Required.
▲Standard Belt Available.

③Three Required.
≡Cut to Fit.

Belts and Coolant Hose for Road & Construction Equipment

Application	Mfr. Part No.	Our No.	Application	Mfr. Part No.	Our No.
John Deere - Continued			John Deere - Continued		
50ZTS			135C		
Isuzu 4-Cyl. 133 Diesel			Isuzu 4-Cyl. 264 Diesel		
Belt - Fan; Ser. No. 240093 & Before	8972113170	7325	Belt - A.C.	4612283	TR22410
Belt - Fan; Ser. No. 240094 & After	4445212	AX32	160C		
70D			John Deere 4-Cyl. 276 Diesel		
John Deere 4-Cyl. 239 Diesel			Belt - Fan	R123442	♣K080623HD
Belt - Fan	T23526T	TR22495	Belt - A.C.; W/48" Belt O.C.	P70104	BX45
75C			Belt - A.C.; W/45" Belt O.C.	AT397199	BX45
Isuzu 4-Cyl. 187 Diesel			160D		
Belt - A.C.	4612876	TR22380	John Deere 4-Cyl. 276 Diesel		
75D			Belt - Fan	R500242	♣K080626HD
Isuzu 4-Cyl. 133 Diesel			Belt - A.C.; W/49" Belt O.C.	FF100493	BX46
Belt - Fan	8980952030	ⓂBX35	Belt - A.C.; W/45" Belt O.C.	AT397199	BX45
Belt - A.C.	4640040	BX51	Tensioner Assy.	RE518097	38507
80C			160G LC		
Isuzu 4-Cyl. 187 Diesel			John Deere 4-Cyl. 275 Diesel		
Belt - A.C.	4612876	TR22380	Belt - Fan	R500242	♣K080626HD
84			Belt - A.C.	R502418	♣K080816HD
Yanmar 4TN100 Diesel			Tensioner Assy.	RE518097	38507
Belt - Fan & Alt.	T113931	TR22474	170		
85D			Wisconsin VG4D		
Isuzu 4-Cyl. 133 Diesel			1977 - 1975		
Belt - Fan	8980952030	ⓂBX35	Belt - Fan	M81037	6832
Belt - A.C.	4640040	BX51	180G LC		
110 Backhoe			John Deere 4-Cyl. 275 Diesel		
Yanmar 4-Cyl. 121 Diesel			Belt - Fan	R500242	♣K080626HD
Belt - Fan	LVU11835	♣9405HD	Belt - A.C.	R502418	♣K080816HD
110 TLB			Tensioner Assy.	RE518097	38507
Yanmar 4-Cyl. 134 Diesel			190D W		
Belt - Fan	LVU11835	♣9405HD	Isuzu 4-Cyl. 317 Diesel		
120 Excavator			Belt - Fan	8973628150	K080455
John Deere 4-Cyl. 276 Diesel			Belt - A.C.	4630087	TR22434
Belt - Fan; Ser. No. 765348 & Before	R123432	♣K080615HD	190E		
Belt - Fan; Ser. No. 777135 & After	R122126	♣K080600HD	John Deere 4-Cyl. 239 Diesel		
120C			Belt - Fan	T24757	TR22508
John Deere 4-Cyl. 276 Diesel			190G W		
Belt - Fan	R123442	♣K080623HD	Isuzu 4-Cyl. 317 Diesel		
Belt - A.C.; W/48" Belt O.C.	P70104	BX45	Belt - Fan	8973628150	K080455
Belt - A.C.; W/45" Belt O.C.	AT397199	BX45	Belt - A.C.	4630087	TR22434
120D			200C LC		
John Deere 4-Cyl. 276 Diesel			John Deere 6-Cyl. 414 Diesel		
Belt - Fan	R500242	♣K080626HD	Belt - Fan	R500242	♣K080626HD
Belt - A.C.; W/49" Belt O.C.	FF100493	BX46	Belt - A.C.	DH400223	BX48
Belt - A.C.; W/45" Belt O.C.	AT397199	BX45	Tensioner Assy.	RE518097	38507
Tensioner Assy.	RE518097	38507	200D; 200D LC		
125			John Deere 6-Cyl. 414 Diesel		
Teledyne TM20 Diesel			Belt - Fan	R500242	♣K080626HD
1984 - 1976			Belt - A.C.; W/49" Belt O.C.	FF100493	BX46
Belt - Fan	GG02032188	♣9385HD	Belt - A.C.; W/45" Belt O.C.	AT397199	BX45
130G			Tensioner Assy.	RE518097	38507
John Deere 4-Cyl. 275 Diesel			200LC		
Tensioner Assy.	RE518097	38507	John Deere 6-Cyl. 414 Diesel		
			Belt - Fan	R123432	♣K080615HD
			Belt - A.C.	4661031	BX50

ⓂTwo Required.

♣Standard Belt Available.

Belts and Coolant Hose for Road & Construction Equipment

Application	Mfr. Part No.	Our No.	Application	Mfr. Part No.	Our No.
John Deere - Continued			John Deere - Continued		
210C Backhoe			245G LC		
John Deere 4-Cyl. 239 Diesel			Isuzu 4-Cyl. 317 Diesel		
Belt - Fan & Alt.; Ser. No. 309201 & Before	T24757	TR22508	Belt - Fan	8973628150	K080455
Belt - Fan & Alt.; Ser. No. 309202 thru 310648	T24473	TR22514	250 Skid Steer		
Belt - Fan & Alt.; Ser. No. 310649 & After	R82602	TR22517	John Deere 3-Cyl. 179 Diesel		
210C Excavator			2004 - 1999		
Isuzu 6-Cyl. 396 Diesel			Belt - Fan; W/52" Belt O.C.		
Belt - A.C.	4612283	TR22410		R97939	TR22517
210C Wheel Loader			Belt - Fan; W/55" Belt O.C.		
John Deere 4039D Diesel				R505792	TR22545
Belt - Fan; Ser. No. 309201 & Before	T24757	TR22508	Belt - A.C.	H87459	▲9395HD
Belt - Fan; Ser. No. 310649 & After	R82602	TR22517	250D		
Belt - Fan; Ser. No. 309202 thru 310648	T24473	TR22514	John Deere 6-Cyl. 549 Diesel		
210G LC			Belt - Fan & A.C.		
John Deere 6-Cyl. 415 Diesel				H166870	▲K080878HD
Belt - Fan	R500242	▲K080626HD	250G LC		
Belt - A.C.	R228566	▲K080855HD	John Deere 6-Cyl. 415 Diesel		
Tensioner Assy.	RE518097	38507	Belt - Fan		
210LE				R500242	▲K080626HD
John Deere 4045D Diesel				R228566	▲K080855HD
Belt - Fan & Alt.	R135195	▲K080645HD		RE518097	38507
Tensioner Assy. - Fan & Alt.	RE518097	38507	260 Skid Steer		
Tensioner Pulley - Fan & Alt.	RE518097	36091	John Deere 3-Cyl. 179 Diesel		
220D W			2004 - 1999		
Isuzu 4-Cyl. 317 Diesel			Belt - Fan; W/52" Belt O.C.		
Belt - Fan	8973628150	K080455		R97939	TR22517
Belt - A.C.	4630087	TR22434		R97939	TR22517
225C LC				R505792	TR22545
Isuzu 6-Cyl. 396 Diesel				R505792	TR22545
Belt - A.C.	4612283	TR22410		H87459	▲9395HD
230C LC			270 Skid Steer		
John Deere 6-Cyl. 414 Diesel			John Deere 4045D Diesel		
Belt - Fan	R504963	▲K080615HD	2004 - 1999		
Belt - A.C.	DH400223	BX48	Belt - Fan; W/57 1/2" Belt O.C.		
Tensioner Assy.	RE518097	38507		R503726	▲K080566HD
230G W				R123439	▲K080605HD
Isuzu 4-Cyl. 317 Diesel				T178423	▲K080806HD
Belt - Fan	8973628150	K080455		RE518097	38507
Belt - A.C.	4630087	TR22434	270C LC		
240 Skid Steer			John Deere 6-Cyl. 414 Diesel		
John Deere 3-Cyl. 179 Diesel			Belt - Fan		
2004 - 1999				R504963	▲K080615HD
Belt - Fan; W/52" Belt O.C.	R97939	TR22517		DH400223	BX48
Belt - Fan; W/55" Belt O.C.	R87153	TR22545		RE518097	38507
Belt - A.C.	H87459	▲9395HD	270D LC		
240D LC			John Deere 6-Cyl. 414 Diesel		
John Deere 6-Cyl. 414 Diesel			Belt - Fan		
Belt - Fan	R500242	▲K080626HD		R500242	▲K080626HD
Belt - A.C.	DH400223	BX48		DH400223	BX48
Tensioner Assy.	RE518097	38507		RE518097	38507
244J			280 Skid Steer		
John Deere 4-Cyl. 149 Diesel			John Deere 4-Cyl. 276 Diesel		
Belt - Fan	R505810	▲K060923HD	2004 - 2002		
240G W			Belt - Fan		
Isuzu 4-Cyl. 317 Diesel				R123449	▲K080605HD
Belt - Fan	8973628150	K080455		R128206	▲K080790HD
Belt - A.C.	4630087	TR22434	290G LC		
240J			John Deere 6-Cyl. 415 Diesel		
John Deere 4-Cyl. 149 Diesel			Belt - Fan		
Belt - Fan	R505810	▲K060923HD		R500242	▲K080626HD
240K				FF100493	BX46
John Deere 4-Cyl. 149 Diesel				RE518097	38507
Belt - Fan	R505810	▲K060923HD	300 Backhoe		
240L			John Deere 3-Cyl. 135		
John Deere 4-Cyl. 149 Diesel			Belt - Fan & Alt.		
Belt - Fan	R505810	▲K060923HD		R97758	TR22485
240M					25477
John Deere 4-Cyl. 149 Diesel					26502
Belt - Fan	R505810	▲K060923HD	Hose - Upper		
240N			Hose - Lower		
John Deere 4-Cyl. 149 Diesel					
Belt - Fan	R505810	▲K060923HD			

▲Standard Belt Available.

Road & Construction Equipment

Belts and Coolant Hose for Road & Construction Equipment

Application	Mfr. Part No.	Our No.	Application	Mfr. Part No.	Our No.
John Deere - Continued			John Deere - Continued		
300 Backhoe - Continued			301 Wheel Loader - Continued		
John Deere 3-Cyl. 152 Diesel			John Deere 3-Cyl. 152 Diesel - Continued		
Belt - Fan & Alt.	R97758	TR22485	Hose - By Pass		28439
Hose - Upper		③<20065	301A Backhoe		
		or 25473	John Deere 3-Cyl. 135		
Hose - Lower		21182	Belt - Fan & Alt.	R97758	TR22485
		or 26502	Hose - Upper		25477
Hose - By Pass		28439	Hose - Lower		26502
300 Wheel Loader			John Deere 3-Cyl. 152 Diesel		
John Deere 3-Cyl. 135			Belt - Fan & Alt.	R97758	TR22485
Belt - Fan & Alt.	R97758	TR22485	Hose - Lower		21182
Hose - Upper		25477			or 26502
Hose - Lower		26502	Hose - By Pass		28439
John Deere 3-Cyl. 152 Diesel			301A Wheel Loader		
Belt - Fan	R97758	TR22485	John Deere 3-Cyl. 135		
Hose - Lower		21182	Belt - Fan & Alt.	R97758	TR22485
Hose - By Pass		28439	Hose - Upper		20450
300B Backhoe					or 25474
John Deere 3-Cyl. 152 Diesel			Hose - Lower		26502
Belt - Fan & Alt.	R97758	TR22485	John Deere 3-Cyl. 152 Diesel		
Hose - Upper		③<20065	Belt - Fan & Alt.	R97758	TR22485
		or 25473	Hose - Upper		20065
Hose - Lower		21182			or 25477
		or 26502	Hose - Lower		21182
Hose - By Pass		28439	Hose - By Pass		28439
300B Wheel Loader			302 Backhoe		
John Deere 3-Cyl. 152 Diesel			John Deere 3-Cyl. 147		
Belt - Fan	R97758	TR22485	Belt - Fan & Alt.	R97758	TR22485
Hose - Upper		③<20065	Hose - Upper		20450
		or 25473			or 25474
Hose - Lower		21182	Hose - Lower		21182
300D					or 26502
John Deere 4039D Diesel			John Deere 3-Cyl. 164 Diesel		
Belt - Fan	RE51551	②♣9585HD	Belt - Fan & Alt.	R97758	TR22485
Belt - A.C.	T60985	♣9420HD	Hose - Upper		21794
Hose - Upper		26508			or 25477
300G LC			Hose - Lower		21182
John Deere 6-Cyl. 415 Diesel			Hose - By Pass		28439
Belt - Fan	R500242	♣K080626HD	302 Wheel Loader		
Belt - A.C.	R228566	♣K080855HD	John Deere 3-Cyl. 147		
301 Backhoe			Belt - Fan & Alt.	R97758	TR22485
John Deere 3-Cyl. 135			Hose - Upper		20450
Belt - Fan & Alt.	R97758	TR22485			or 25474
Hose - Upper		25477	Hose - Lower		21182
Hose - Lower		26502	John Deere 3-Cyl. 164 Diesel		
John Deere 3-Cyl. 152 Diesel			Belt - Fan & Alt.	R97758	TR22485
Belt - Fan & Alt.	R97758	TR22485	Hose - Upper		21794
Hose - Lower		21182			or 25477
		or 26502	Hose - Lower		21182
Hose - By Pass		28439	Hose - By Pass		28439
301 Wheel Loader			302A Backhoe		
John Deere 3-Cyl. 135			John Deere 3-Cyl. 147		
Belt - Fan & Alt.	R97758	TR22485	Belt - Fan & Alt.	R97758	TR22485
Hose - Upper		25477	Hose - Upper		20450
Hose - Lower		26502			or 25474
John Deere 3-Cyl. 152 Diesel			Hose - Lower		21182
Belt - Fan & Alt.	R97758	TR22485			or 26502
Hose - Lower		21182	John Deere 3-Cyl. 164 Diesel		
		or 26502	Belt - Fan & Alt.	R97758	TR22485
Hose - By Pass		28439	Hose - Lower		21182
301 Wheel Loader					or 26502
John Deere 3-Cyl. 135			John Deere 3-Cyl. 164 Diesel		
Belt - Fan & Alt.	R97758	TR22485	Belt - Fan & Alt.	R97758	TR22485
Hose - Upper		25477			
Hose - Lower		26502			

③<Cut to Fit.
②Two Required.

♣Standard Belt Available.

Belts and Coolant Hose for Road & Construction Equipment

Application	Mfr. Part No.	Our No.	Application	Mfr. Part No.	Our No.
John Deere - Continued			John Deere - Continued		
302A Backhoe - Continued			310J		
John Deere 3-Cyl. 164 Diesel - Continued			John Deere 4-Cyl. 276 Diesel		
Hose - Upper		21794	Belt - Fan; W/O A.C.; W/O Ambient Air Pkg.	T240080	♣K080653HD
	or	25477	Belt - Fan; W/O A.C.; W/Ambient Air Pkg. ...	T240082	♣K080649HD
Hose - Lower		21182	Belt - Fan; W/A.C.; W/Ambient Air Pkg.	T240081	♣K080926HD
Hose - By Pass		28439	Belt - Fan; W/A.C.; W/O Ambient Air Pkg.; Ser. No. 171948 & Before	T225495	♣K080939HD
302A Wheel Loader			Belt - Fan; W/A.C.; W/O Ambient Air Pkg.; Ser. No. 171949 & After		
John Deere 3-Cyl. 147			T227401		
Belt - Fan & Alt.	R97758	TR22485	Tensioner Assy.	RE518097	♣K080934HD
Hose - Upper		20450			38507
	or	25474	310K; 310K EP		
Hose - Lower		21182	John Deere 4-Cyl. 276 Diesel		
John Deere 3-Cyl. 164 Diesel			Belt - Fan; W/O A.C.		
Belt - Fan & Alt.	R97758	TR22485		T280021	♣K080626HD
Hose - Upper		21794	Belt - Fan; W/A.C.	T320267	♣K080939HD
	or	25477	Tensioner Assy.	RE518097	38507
Hose - Lower		21182	310L		
Hose - By Pass		28439	John Deere 4-Cyl. 276 Diesel		
310			Belt - Fan; W/A.C.		
John Deere 3-Cyl.				T328595	♣K081051HD
Belt - Fan & Alt.	R97758	TR22485	Belt - Fan; W/O A.C.	T328528	♣K080839HD
Hose - Upper		25476	310L EP		
Hose - Lower		21182	John Deere 4-Cyl. 276 Diesel		
	or	26502	Belt - Fan; W/O A.C.		
John Deere 3-Cyl. Diesel				T323621	♣K080620HD
Belt - Fan & Alt.	R97758	TR22485	Tensioner Assy.	RE518097	38507
Hose - Upper		21794	310SE		
Hose - Lower		21182	John Deere 4-Cyl. 276 Diesel		
	or	26502	Belt - Fan; W/A.C.		
310A; 310B				R135194	♣K080926HD
John Deere 4-Cyl. 219 Diesel			Belt - Fan; W/O A.C.		
Belt - Fan	T24757	TR22508		R135195	♣K080645HD
Hose - Upper		21794	310SJ		
Hose - Lower		21182	John Deere 4-Cyl. 276 Diesel		
310C			Belt - Fan; W/O A.C.; W/O Ambient Air Pkg.		
John Deere 4-Cyl. 239 Diesel				T240080	♣K080653HD
Belt - Fan; Ser. No. 770247 & Before	AT24833	♣9570HD	Belt - Fan; W/O A.C.; W/Ambient Air Pkg. ...	T240082	♣K080649HD
Belt - Fan; Ser. No. 770248 & After	RE44538	♣9580HD	Belt - Fan; W/A.C.; W/Ambient Air Pkg.	T240081	♣K080926HD
Belt - A.C.	T60985	♣9420HD	Belt - Fan; W/A.C.; W/O Ambient Air Pkg.; Ser. No. 171948 & Before	T225495	♣K080939HD
310D			Belt - Fan; W/A.C.; W/O Ambient Air Pkg.; Ser. No. 171949 & After		
John Deere 4039D Diesel			T227401		
Belt - Fan & Alt.	RE51551	②♣9585HD	Tensioner Assy.	RE518097	38507
Belt - A.C.	T60985	♣9420HD	310SK		
Hose - Upper		26509	John Deere 4-Cyl. 276 Diesel		
310E			Belt - Fan; W/O A.C.		
John Deere 4-Cyl. 276 Diesel				T303621	♣K080830HD
Belt - Fan; W/A.C.	R135194	♣K080926HD	Tensioner Assy.	RE518097	38507
Belt - Fan; W/O A.C.	R135195	♣K080645HD	310SK TC		
310G			John Deere 4-Cyl. 276 Diesel		
John Deere 4045D Diesel			Belt - Fan; W/A.C.		
Belt - Fan; W/A.C.	T225495	♣K080939HD		T303624	♣K081035HD
Belt - Fan; W/O A.C.	T225494	♣K080630HD	Belt - Fan; W/O A.C.	T303623	♣K080820HD
Belt - A.C.	R504023	♣K080926HD	Tensioner Assy.	RE518097	38507
Tensioner Assy. - Fan & Alt.	RE70535	38507	310SL		
Tensioner Pulley - Fan & Alt.	RE70535	36091	John Deere 4-Cyl. 276 Diesel		
			Belt - Fan; W/O A.C.		
				T303621	♣K080830HD

♣Standard Belt Available.

②Two Required.

Belts and Coolant Hose for Road & Construction Equipment

Application	Mfr. Part No.	Our No.	Application	Mfr. Part No.	Our No.
John Deere - Continued			John Deere - Continued		
313; 315			319D		
John Deere 4-Cyl. 149 Diesel 2015 - 2007			John Deere 4-Cyl. 149 Diesel 2011 - 2009		
Belt - Fan	R505810	♣K060923HD	Belt - Fan	R528335	K060926
315C			320 Skid Steer		
John Deere 4-Cyl. 239 Diesel			John Deere 4-Cyl. 149 Diesel 2010 - 2000		
Belt - Fan; Ser. No. 770370 & Before	AT24833	♣9570HD	Belt - Fan; W/O A.C.; Ser. No. 133514 & Before	R505809	K060966
Belt - Fan; Ser. No. 770371 & After	RE44538	♣9580HD	Belt - Fan; W/A.C.; Ser. No. 133514 & Before	R517042	K061073
Belt - A.C.	T60985	♣9420HD	Belt - Fan; W/O A.C.; Ser. No. 133515 & After	R515218	K060950
315D			Belt - Fan; W/A.C.; Ser. No. 133515 & After		
John Deere 4-Cyl. 239 Diesel			T225941		
Belt - Fan & Alt.	RE51551	②♣9585HD	320D		
Belt - A.C.	T60985	♣9420HD	John Deere 4-Cyl. 149 Diesel 2013 - 2010		
Hose - Upper		26509	Belt - Fan; W/O A.C.	R528334	K060705
315SE			Belt - Fan; W/A.C.	R528335	K060926
John Deere 4-Cyl. 276 Diesel			323D		
Belt - Fan; W/A.C.	R135194	♣K080926HD	John Deere 4-Cyl. 149 Diesel 2011 - 2009		
Belt - Fan; W/O A.C.	R135195	♣K080645HD	Belt - Fan; W/O A.C.	R528334	K060705
315SG			Belt - Fan; W/A.C.	R528335	K060926
John Deere 4045D Diesel			325 Skid Steer		
Belt - Fan; W/A.C.	R504023	♣K080926HD	John Deere 5-Cyl. 186 Diesel 2010 - 2004		
Belt - Fan; W/O A.C.	R504022	K080644	Belt - Fan; W/O A.C.; W/Electro-Hydraulic Fan	R519408	K060984
Belt - A.C.	R504023	♣K080926HD	Belt - Fan; W/O A.C.; W/2-Speed Fan	R515221	K060980
Tensioner Assy. - Fan & Alt.	RE70535	38507	Belt - Fan; W/A.C.; W/Std. Fan	R517040	♣K061080HD
Tensioner Pulley - Fan & Alt.	RE70535	36091	Belt - Fan; W/A.C.; W/Electro-Hydraulic Fan	R517038	K061093
315SJ			326D		
John Deere 4-Cyl. 276 Diesel			John Deere 5-Cyl. 186 Diesel 2013 - 2010		
Belt - Fan; W/O A.C.; W/O Ambient Air Pkg.	T240080	♣K080653HD	Belt - Fan; W/O A.C.	R528334	K060705
Belt - Fan; W/O A.C.; W/Ambient Air Pkg. ...	T240082	♣K080649HD	Belt - Fan; W/A.C.	R528335	K060926
Belt - Fan; W/A.C.; W/Ambient Air Pkg.	T240081	♣K080926HD	328 Skid Steer		
Belt - Fan; W/A.C.; W/O Ambient Air Pkg.; Ser. No. 171948 & Before	T225495	♣K080939HD	John Deere 5-Cyl. 186 Diesel 2010 - 2005		
Belt - Fan; W/A.C.; W/O Ambient Air Pkg.; Ser. No. 171949 & After	T227401	♣K080934HD	Belt - Fan; W/O A.C.; W/Electro-Hydraulic Fan	R519408	K060984
Tensioner Assy.	RE518097	38507	Belt - Fan; W/O A.C.; W/2-Speed Fan	R515221	K060980
315SL			Belt - Fan; W/A.C.; W/Std. Fan	R517040	♣K061080HD
John Deere 4-Cyl. 276 Diesel			Belt - Fan; W/A.C.; W/Electro-Hydraulic Fan	R517038	K061093
Belt - Fan; W/A.C.	T328595	♣K081051HD	328D		
Belt - Fan; W/O A.C.	T328528	♣K080839HD	John Deere 5-Cyl. 186 Diesel 2013 - 2010		
317 Skid Steer			Belt - Fan; W/O A.C.	R528334	K060705
John Deere 4-Cyl. 149 Diesel 2010 - 2005			Belt - Fan; W/A.C.	R528335	K060926
Belt - Fan; W/O A.C.; Ser. No. 133514 & Before	R505809	K060966	329D		
Belt - Fan; W/A.C.; Ser. No. 133514 & Before	R517042	K061073	John Deere 5-Cyl. 186 Diesel 2011 - 2009		
Belt - Fan; W/O A.C.; Ser. No. 133515 & After	R515218	K060950	Belt - Alt.; W/A.C.	R528335	K060926
Belt - Fan; W/A.C.; Ser. No. 133515 & After	T225941	K061054	Belt - Alt.; W/O A.C.	R528334	K060705
318D					
John Deere 4-Cyl. 149 Diesel 2013 - 2010					
Belt - Fan; W/O A.C.	R528334	K060705			
Belt - Fan; W/A.C.	R528335	K060926			

♣Standard Belt Available.

②Two Required.

Belts and Coolant Hose for Road & Construction Equipment

Application	Mfr. Part No.	Our No.	Application	Mfr. Part No.	Our No.
John Deere - Continued			John Deere - Continued		
330C LC			350C Crawler Loader - Continued		
John Deere 6-Cyl. 494 Diesel			John Deere 3-Cyl. 152 Diesel - Continued		
Belt - Fan	R133702	♣K080700HD	Hose - Upper		25476
Belt - A.C.	4372746	BX52	Hose - By Pass		28439
330LC			John Deere 3-Cyl. 164 Diesel		
John Deere 6-Cyl. 494 Diesel			Belt - Fan & Alt.	T24473	TR22514
Belt - Fan	R135596	♣K080710HD	Hose - Upper		20065
Belt - A.C.	4372746	BX52	350C Crawler Tractor		
332 Skid Steer			John Deere 3-Cyl. 152 Diesel		
John Deere 5-Cyl. 186 Diesel			1986 - 1975		
2010 - 2004			Belt - Fan	T24473	TR22514
Belt - Fan; W/O A.C.; W/Std. Fan	R515221	K060980	Hose - By Pass		28439
Belt - Fan; W/O A.C.; W/Electro-Hydraulic Fan	R519408	K060984	John Deere 3-Cyl. 164 Diesel		
Belt - Fan; W/A.C.; W/Std. Fan	R517040	♣K061080HD	1986 - 1975		
Belt - Fan; W/A.C.; W/Electro-Hydraulic Fan	R517038	K061093	Belt - Fan	T24473	TR22514
332D			350D LC		
John Deere 5-Cyl. 186 Diesel			John Deere 6-Cyl. 542 Diesel		
2013 - 2010			Belt - Fan	T178418	K080480HD
Belt - Fan; W/O A.C.	R528334	K060705	Belt - A.C.	DH400223	BX48
Belt - Fan; W/A.C.	R528335	K060926	Tensioner Assy.	RE518097	38507
333D			350G LC		
John Deere 5-Cyl. 186 Diesel			John Deere 6-Cyl. 549 Diesel		
2011 - 2009			Belt - Fan	T178418	K080480HD
Belt - Alt.; W/A.C.	R528335	K060926	Belt - A.C.	FF502547	TR22514
Belt - Alt.; W/O A.C.	R528334	K060705	Tensioner Assy.	RE518097	38507
344E			355D Crawler Loader		
John Deere 4045D Diesel; John Deere 4-Cyl. 276 Diesel			John Deere 3-Cyl. 179 Diesel		
Belt - Fan & Alt.	RE44538	♣♣9580HD	Belt - Fan	T24473	TR22514
Belt - A.C.	AT121408	♣9490HD	370		
350 Crawler Loader			John Deere 6-Cyl. 494 Diesel		
John Deere 3-Cyl. 152			Belt - Fan	R135596	♣K080710HD
Belt - Fan & Alt.; W/50" Belt O.C.	T20161	TR22495	Belt - A.C.	4372746	BX52
Belt - Fan & Alt.; W/51 1/4" Belt O.C.	T24757	TR22508	370C		
Belt - Fan & Alt.; W/51 7/8" Belt O.C.	T24473	TR22514	John Deere 6-Cyl. 494 Diesel		
John Deere 3-Cyl. 152 Diesel			Belt - Fan	R133702	♣K080700HD
Belt - Fan & Alt.; W/50" Belt O.C.	T20161	TR22495	Belt - A.C.	4372746	BX52
Belt - Fan & Alt.; W/51 1/4" Belt O.C.	T24757	TR22508	375		
Belt - Fan & Alt.; W/51 7/8" Belt O.C.	T24473	TR22514	Yanmar 3TN66 Diesel		
Hose - Upper		20065	1994 - 1987		
350 Crawler Tractor			Belt - W.P.	M800048	7340
John Deere 3-Cyl. 152; John Deere 3-Cyl. 152 Diesel			Belt - Hyd. Pump	M125661	3VX425
1970 - 1965			380G LC		
Belt - Fan & Alt.; W/50" Belt O.C.	T20161	TR22495	John Deere 6-Cyl. 542 Diesel		
Belt - Fan & Alt.; W/51 1/4" Belt O.C.	T24757	TR22508	Belt - Fan	R521053	K080889HD
Belt - Fan & Alt.; W/51 7/8" Belt O.C.	T24473	TR22514	Belt - A.C.	FF502547	TR22514
350B Crawler Loader			Tensioner Assy.	RE506352	38591
John Deere 3-Cyl. 135; John Deere 3-Cyl. 152 Diesel			400 Backhoe		
Belt - Fan	T24473	TR22514	John Deere 4-Cyl. 180		
350B Crawler Tractor			Belt - Fan & Alt.	R97758	TR22485
John Deere 3-Cyl. 152 Diesel			John Deere 4-Cyl. 219 Diesel		
1975 - 1970			Belt - Fan & Alt.	R97758	TR22485
Belt - Fan	T24473	TR22514	Hose - Lower		21182
350C Crawler Loader			400 Wheel Loader		
John Deere 3-Cyl. 152 Diesel			John Deere 4-Cyl. 180		
Belt - Fan & Alt.	T24473	TR22514	Belt - Fan & Alt.	T20334T	TR22474

♣Standard Belt Available.

♣♣Two Required.

Road & Construction Equipment

Belts and Coolant Hose for Road & Construction Equipment

Road & Construction Equipment

Application	Mfr. Part No.	Our No.	Application	Mfr. Part No.	Our No.
John Deere - Continued			John Deere - Continued		
400 Wheel Loader - Continued			401D - Continued		
John Deere 4-Cyl. 180 - Continued			John Deere 4-Cyl. 219 Diesel - Continued		
Hose - Upper		25474	Hose - Upper		21794
Hose - Lower		26603	Hose - Lower		21182
John Deere 4-Cyl. 219 Diesel			410		
Belt - Fan & Alt.	T20334T	TR22474	John Deere 4-Cyl. 180		
Hose - Upper		25477	Belt - Fan & Alt.	T24757	TR22508
Hose - Lower		26502	Hose - Upper		25476
401 Backhoe			Hose - Lower		21182
John Deere 4-Cyl. 180				or	26502
Belt - Fan & Alt.	R97758	TR22485	John Deere 4-Cyl. 219 Diesel		
John Deere 4-Cyl. 219 Diesel			Belt - Fan & Alt.	T24757	TR22508
Belt - Fan & Alt.	R97758	TR22485	Hose - Upper		25474
Hose - Lower		21182	Hose - Lower		21182
401 Wheel Loader				or	26502
John Deere 4-Cyl. 180			Hose - By Pass		28439
Belt - Fan & Alt.	R97758	TR22485	410B		
Hose - Upper		25476	John Deere 4-Cyl. 219 Diesel		
John Deere 4-Cyl. 219 Diesel			Belt - Fan & Alt.	AR69141	②♣9640HD
Belt - Fan & Alt.	R97758	TR22485	410C		
Hose - Upper		25477	John Deere 4-Cyl. 276 Diesel		
Hose - Lower		21182	Belt - Fan	AR54592	②♣9625HD
Hose - By Pass		28439	Belt - A.C.	T38174	TR22405
401B			Hose - By Pass		28439
John Deere 4-Cyl. 180			410D		
Belt - W.P., Fan & Alt.	T24757	TR22508	John Deere 4-Cyl. 180		
Hose - Lower		21182	Hose - Upper		25476
John Deere 4-Cyl. 219 Diesel			Hose - Lower		26502
Belt - W.P., Fan & Alt.	T24757	TR22508	John Deere 4-Cyl. 219 Diesel		
Hose - Upper		21794	Belt - Fan & Alt.	AR54592	②♣9625HD
	or	25476	Belt - A.C.	R82437	♣9395HD
Hose - Lower		21182	Hose - Lower		26502
401B Backhoe			Hose - By Pass		28439
John Deere 4-Cyl. 180			John Deere 4045D Diesel		
Belt - Fan & Alt.; W/50" Belt O.C.	T20161	TR22495	Belt - Fan & Alt.	AR54592	②♣9625HD
Belt - Fan & Alt.; W/51 1/4" Belt O.C.	T24757	TR22508	Belt - A.C.	R82437	♣9395HD
Belt - Fan & Alt.; W/51 7/8" Belt O.C.	T24473	TR22514	410E		
Hose - Lower		21182	John Deere 4-Cyl. 276 Diesel		
John Deere 4-Cyl. 219 Diesel			Belt - Fan; W/A.C.	R135194	♣K080926HD
Belt - Fan	T24757	TR22508	Belt - Fan; W/O A.C.	R135195	♣K080645HD
Hose - Upper; Ser. No. 305415 & After		21794	410G		
Hose - Lower		21182	John Deere 4045D Diesel		
401C Backhoe			Belt - Fan; W/A.C.; Ser. No. 958703 & Before	R504023	♣K080926HD
John Deere 4-Cyl. 219 Diesel			Belt - Fan; W/A.C.; Ser. No. 958704 & After	T225495	♣K080939HD
Belt - Fan & Alt.	T24757	TR22508	Belt - Fan; W/O A.C.; Ser. No. 958703 & Before	R504022	K080644
Hose - Upper; Ser. No. 305414 & Before		25476	Belt - Fan; W/O A.C.; Ser. No. 958704 & After	T225494	♣K080630HD
Hose - Upper; Ser. No. 305415 & After		21794	Tensioner Assy.	RE518097	38507
Hose - Lower		21182	410J		
401C Wheel Loader			John Deere 4-Cyl. 276 Diesel		
John Deere 4-Cyl. 239 Diesel			Belt - Fan; W/O A.C.; W/O Ambient Air Pkg.	T240082	♣K080649HD
Belt - Fan & Alt.	T24757	TR22508	Belt - Fan; W/O A.C.; W/Ambient Air Pkg. ...	T240084	K080644
Hose - Upper		21794	Belt - Fan; W/A.C.; W/Ambient Air Pkg.	T240081	♣K080926HD
	or	25476	Belt - Fan; W/A.C.; W/O Ambient Air Pkg.; Ser. No. 171948 & Before	T225495	♣K080939HD
Hose - Lower		21182			
401D					
John Deere 4-Cyl. 219 Diesel					
Belt - Fan & Alt.	T24757	TR22508			

♣Standard Belt Available.

②Two Required.

Belts and Coolant Hose for Road & Construction Equipment

Application	Mfr. Part No.	Our No.	Application	Mfr. Part No.	Our No.
John Deere - Continued			John Deere - Continued		
410J - Continued			440B Skidder - Continued		
John Deere 4-Cyl. 276 Diesel - Continued			John Deere 4-Cyl. 276 Diesel		
Belt - Fan; W/A.C.; W/O Ambient Air Pkg.;			Belt - Fan & Alt.; Ser. No. 15142 & Before ..		
Ser. No. 171949 & After			T227401		
			♣K080934HD		
Tensioner Assy.			RE518097		
			38507		
410K; 410K TC			Belt - Fan & Alt.; Ser. No. 15143 Thru		
John Deere 4-Cyl. 276 Diesel			49999		
Belt - Fan; W/O A.C.			T25130		
Belt - Fan; W/A.C.			T24757		
Tensioner Assy.			T24473		
			TR22508		
			TR22514		
			25474		
			26603		
410L			440C Skidder		
John Deere 4-Cyl. 276 Diesel			John Deere 4-Cyl. 276 Diesel		
Belt - Fan; W/O A.C.			Belt - Fan & Alt.; W/56 1/4" Belt O.C.		
T303621			AT31820		
♣K080830HD			②♣9560HD		
			Belt - Fan & Alt.; W/57 1/4" Belt O.C.		
			T26755		
			②♣9570HD		
			Hose - Upper		
			26521		
			444C		
415B			John Deere 6-Cyl. 329 Diesel		
John Deere 4-Cyl. 239 Diesel			Belt - Fan & Alt.		
Belt - Fan & Alt.			AR69141		
			②♣9640HD		
440 Skidder			Belt - A.C.		
John Deere 4-Cyl. 180			H79236		
Belt - Fan & Alt.; Ser. No. 15142 & Before ..			Hose - Upper - Eng. To Pipe		
T20334			26522		
Belt - Fan & Alt.; Ser. No. 15143 Thru			Hose - Upper - Pipe To Rad.		
49999			26519		
T25130			Hose - Lower - Eng. To Pipe		
TR22495			24822		
Belt - Fan & Alt.; Ser. No. 50000 Thru			444E		
81723			John Deere 4-Cyl. 276 Diesel		
T24757			Belt - Fan		
TR22508			RE44538		
Belt - Fan & Alt.; Ser. No. 81724 & After			②♣9580HD		
T24473			Belt - A.C.		
TR22514			AT121408		
Hose - Upper			♣9490HD		
25474			26515		
Hose - Lower			26603		
			444J		
			John Deere 4-Cyl. 276 Diesel		
			Belt - Alt.; W/55A. Alt.; W/O A.C.		
			T197521		
			♣K080620HD		
			Belt - Alt.; W/55A. Alt.; W/A.C.		
			T197520		
			♣K080842HD		
			Belt - Alt.; W/80A. Alt.; W/O A.C.		
			R500384		
			♣K080626HD		
			Belt - Alt.; W/80A. Alt.; W/A.C.		
			T195188		
			K080850HD		
			Belt - Alt.; W/H.D. Alt.; W/O A.C.		
			T186776		
			K080638HD		
			Belt - Alt.; W/H.D. Alt.; W/A.C.		
			T208891		
			♣K080859HD		
			Belt - Alt.; W/100A. Alt.; W/O A.C.		
			T186776		
			K080638HD		
			Belt - Alt.; W/100A. Alt.; W/A.C.		
			T210568		
			♣K080780HD		
			450 Crawler Loader		
440B Skidder			John Deere 4-Cyl. 180		
John Deere 4-Cyl. 180			Belt - Fan & Alt.; W/50" Belt O.C.		
Belt - Fan & Alt.; Ser. No. 15142 & Before ..			T20161		
T20334			TR22495		
Belt - Fan & Alt.; Ser. No. 15143 Thru			Belt - Fan & Alt.; W/51 1/4" Belt O.C.		
49999			T24757		
T25130			TR22508		
TR22495			Belt - Fan & Alt.; W/51 7/8" Belt O.C.		
Belt - Fan & Alt.; Ser. No. 50000 Thru			T24473		
81723			TR22514		
T24757			John Deere 4-Cyl. 202 Diesel		
TR22508			Belt - Fan & Alt.; W/50" Belt O.C.		
Belt - Fan & Alt.; Ser. No. 81724 & After			T20161		
T24473			TR22495		
TR22514			Belt - Fan & Alt.; W/51 1/4" Belt O.C.		
Hose - Upper; W/Syncro Mesh Trans.			T24757		
			TR22508		
			Belt - Fan & Alt.; W/51 7/8" Belt O.C.		
			T24473		
			TR22514		
			Hose - Upper		
			20065		
			450 Crawler Tractor		
			John Deere 4-Cyl. 180; John Deere 4-Cyl. 202 Diesel		
			1970 - 1965		
			Belt - Fan & Alt.; W/50" Belt O.C.		
			T20161		
			TR22495		
			Belt - Fan & Alt.; W/51 1/4" Belt O.C.		
			T24757		
			TR22508		
			Belt - Fan & Alt.; W/51 7/8" Belt O.C.		
			T24473		
			TR22514		
			450B Crawler Loader		
			John Deere 4-Cyl. 219 Diesel		
			Belt - Fan		
			T24473		
			TR22514		
			Hose - Upper		
			20065		
			450B Crawler Tractor		
			John Deere 4-Cyl. 219 Diesel		
			1976 - 1970		
			Belt - Fan		
			T24473		
			TR22514		

♣Standard Belt Available.
 ≧Cut to Fit.

②Two Required.

Belts and Coolant Hose for Road & Construction Equipment

Application	Mfr. Part No.	Our No.	Application	Mfr. Part No.	Our No.
John Deere - Continued			John Deere - Continued		
450B Crawler Tractor - Continued			490D		
John Deere 4-Cyl. 219 Diesel - Continued 1976 - 1970 - Continued			John Deere 4-Cyl. 276 Diesel		
Hose - Upper		20065	Belt - Fan & Alt.	R82602	TR22517
450C Crawler Loader			Hose - By Pass		24220
John Deere 4-Cyl. 219 Diesel			490E		
Belt - Fan & Alt.	T24473	TR22514	John Deere 4-Cyl. 276 Diesel		
Hose - Upper		20065	Belt - Fan	R108842	♣K080745HD
450C Crawler Tractor			495D		
John Deere 4-Cyl. 219 Diesel			John Deere 4-Cyl. 276 Diesel		
1984 - 1975			Belt - Fan	RE44538	②♣9580HD
Belt - Fan	T24473	TR22514	Belt - Compr.	R71459	♣9580HD
450C LC			500 Backhoe		
John Deere 6-Cyl. 763 Diesel			John Deere 4-Cyl. 241		
Belt - Alt.	R503324	♣K080545HD	Belt - Fan & Alt./Gen.	AR41628	②7555
Belt - A.C.	4661031	BX50	Hose - Upper		26509
450D LC			John Deere 4-Cyl. 270 Diesel		
Isuzu 6-Cyl. 957 Diesel			Belt - Fan & Alt./Gen.	AR41576	②7560
Belt - A.C.	4612763	BX55	Hose - Upper		26509
450J Crawler Dozer			500 Wheel Loader		
John Deere 4-Cyl. 276 Diesel			John Deere 4-Cyl. 227		
2015 - 2004			Belt - Fan & Alt./Gen.	AR41628	②7555
Belt - Fan; W/O A.C.; Ser. No. 138178 & Before	R500377	♣K080638HD	Hose - Upper		26509
Belt - Fan; W/O A.C.; Ser. No. 138179 thru 159986	R505186	K080655	Hose - Lower		20590
Belt - Fan; W/O A.C.; Ser. No. 159987 & After	R505186	K080655	500 Wheel Tractor		
Belt - Fan; W/A.C.; Ser. No. 138178 & Before	R500378	K080981	John Deere 4-Cyl. 241		
Belt - Fan; W/A.C.; Ser. No. 138179 thru 159986	R135612	K080994HD	Belt - Fan & Gen.	AR32659R	7555
Belt - Fan; W/A.C.; Ser. No. 159987 & After	R500173	♣K080893HD	Hose - Upper		26509
450LC			Hose - Lower		20590
John Deere 6-Cyl. 619 Diesel			500A Backhoe; 500A Wheel Loader; 500B Backhoe		
Belt - Fan	RE50059	②BX50	John Deere 4-Cyl. 241		
Belt - A.C.	4661031	BX50	Belt - Fan	AR41628	②7555
455D			Hose - Upper		26509
John Deere 4-Cyl. 219 Diesel			500C Backhoe		
Belt - Fan & Alt.	T24473	TR22514	John Deere 4-Cyl. 219 Diesel		
455E			Belt - Fan	AR41576	②7560
John Deere 4-Cyl. 276 Diesel			Hose - Upper		26509
Belt - Fan	R82602	TR22517	John Deere 4-Cyl. 270 Diesel; John Deere 6-Cyl. 329 Diesel		
455G			Belt - Fan & Alt.	AR41576	②7560
John Deere 4-Cyl. 276 Diesel			Hose - Upper		26509
Belt - Fan & Alt.	T184594	♣K080653HD	510		
470G LC			John Deere 4-Cyl. 241		
Isuzu 6-Cyl. 600 Diesel			Belt - Fan & Alt./Gen.	AR41628	②7555
Belt - A.C.	4612763	BX55	John Deere 4-Cyl. 270 Diesel		
490			Belt - Fan & Alt./Gen.	AR41576	②7560
John Deere 4-Cyl. 239 Diesel			Hose - Upper		24232
Belt - Fan	RE17782	②♣9550HD			26509
			510B		
			John Deere 4039D Diesel		
			Belt - Fan	AR54592	②♣9625HD
			Belt - A.C.	T79843	♣9390HD
			Hose - Upper		26515

♣Standard Belt Available.

②Two Required.

Belts and Coolant Hose for Road & Construction Equipment

Application	Mfr. Part No.	Our No.	Application	Mfr. Part No.	Our No.
John Deere - Continued			John Deere - Continued		
510C			544C		
John Deere 4-Cyl. 276 Diesel			John Deere 6-Cyl. 414 Diesel		
Belt - Fan	AR54592	②▲9625HD	Belt - Fan & Alt.	AT24833	②▲9570HD
Belt - A.C.	R82437	▲9395HD	Belt - A.C.	H79236	▲9635HD
Hose - By Pass		28439	544E		
510D			John Deere 6-Cyl. 359 Diesel		
John Deere 4-Cyl. 276 Diesel			Belt - Fan & Alt.; W/65A. Alt.		
Belt - Fan	AR54592	②▲9625HD	Belt - Fan & Alt.; W/105A. Alt.	AR54592	②▲9625HD
Belt - A.C.	T38174	TR22405	Belt - Fan & Alt.; W/130A. Alt.; W/63 1/2" Belt O.C.	AR57266	②▲9630HD
Hose - By Pass		28439	Belt - Fan & Alt.; W/130A. Alt.; W/63" Belt O.C.	AR54592	②▲9625HD
524K			Belt - A.C.	H63772	②▲9540HD
John Deere 6-Cyl. 414 Diesel			Hose - Upper		26511
Belt - Alt.; W/A.C.; W/100A. Alt.	T210568	▲K080780HD	544G		
Belt - Alt.; W/A.C.; W/80A. Alt.	R135606	▲K080774HD	John Deere 6059T Diesel		
Belt - Alt.; W/O A.C.	T186776	K080638HD	Belt - Fan & Alt.; W/95A. Alt.		
Tensioner Assy.	RE518097	38507	Belt - Fan & Alt.; W/135A. Alt.	AR69141	②▲9635HD
540; 540A			Belt - A.C.; W/R134 Coolant	T149108	▲9530HD
John Deere 4-Cyl. 276 Diesel			Belt - A.C.; W/R12 Coolant	H63772	▲9540HD
Belt - Fan & Alt.; W/56 1/4" Belt O.C.	AT31820	②▲9560HD	Hose - Upper		④21115
Belt - Fan & Alt.; W/57 1/4" Belt O.C.	T26755	②▲9570HD	544J		
540B			John Deere 6-Cyl. 414 Diesel		
John Deere 4-Cyl. 276 Diesel			Belt - Alt.; W/55A. Alt.; W/O A.C.		
Belt - Fan & Alt.; W/56 1/4" Belt O.C.	AT31820	②▲9560HD	Belt - Alt.; W/55A. Alt.; W/A.C.	T197520	▲K080842HD
Belt - Fan & Alt.; W/57 1/4" Belt O.C.	T26755	②▲9570HD	Belt - Alt.; W/80A. Alt.; W/O A.C.	R500384	▲K080626HD
Hose - Upper		26521	Belt - Alt.; W/80A. Alt.; W/A.C.	T195188	K080850HD
540D			Belt - Alt.; W/100A. Alt.; W/O A.C.	T186776	K080638HD
John Deere 4015T Diesel			Belt - Alt.; W/100A. Alt.; W/A.C.	T208891	▲K080859HD
Belt - Fan & Alt.; W/56 1/4" Belt O.C.	AT31820	②▲9560HD	550LC		
Belt - Fan & Alt.; W/57 1/4" Belt O.C.	T26755	②▲9570HD	Cummins N14 Diesel		
Hose - Upper		26509	Belt - Alt.		
544 Skidder			4S00293		
John Deere 6-Cyl. 414 Diesel			▲K060435HD		
Belt - Fan & Alt.; W/56 1/4" Belt O.C.	AT31820	②▲9560HD	555; 555A		
Belt - Fan & Alt.; W/57 1/4" Belt O.C.	T26755	②▲9570HD	John Deere 4-Cyl. 276 Diesel		
Hose - Upper; Ser. No. 165809 Thru 171243		26522	Belt - Fan & Alt.		
Hose - Lower		26523	AT31820		
Hose - By Pass		28442	②▲9560HD		
544 Wheel Loader			555G		
John Deere 6-Cyl. 414 Diesel			John Deere 4-Cyl. 276 Diesel		
Belt - Fan & Alt.	AT24833	②▲9570HD	Belt - Fan & Alt.		
Hose - Upper; Ser. No. 165809 Thru 171243		26522	T184594		
Hose - Lower		26523	▲K080653HD		
Hose - By Pass		28442	570		
544B Skidder			John Deere 6-Cyl. 303 Diesel		
John Deere 6-Cyl. 414 Diesel			Belt - Fan & Alt.; W/56 1/8" Belt O.C.		
Hose - Upper - Cooler To Rad.		≧20685	Belt - Fan & Alt.; W/57" Belt O.C.	AR49925	②7560
Hose - Lower		25528	Belt - Fan & Alt.; W/57 5/8" Belt O.C.	T25619	②A55
544B Wheel Loader			Hose - Upper; Ser. No. 001699 & Before		②7575
John Deere 6-Cyl. 414 Diesel			Hose - Upper; Ser. No. 001700 & After		26524
Belt - Fan; W/O A.C.	AT24833	②▲9570HD	570A		
Belt - Fan; W/A.C.	AT59850	②▲9620HD	John Deere 6-Cyl. 329 Diesel		
Belt - A.C.	H79236	▲9635HD	Belt - Fan & Alt.; W/56 1/8" Belt O.C.		
Hose - Upper - Cooler To Rad.		≧20685	Belt - Fan & Alt.; W/57" Belt O.C.	AR49925	②A55
Hose - Lower		25528	Belt - Fan & Alt.; W/57 5/8" Belt O.C.	T25619	②7575
544B Wheel Loader			Hose - Upper; Ser. No. 001699 & Before		26524
John Deere 6-Cyl. 414 Diesel			Hose - Upper; Ser. No. 001700 & After		26512
Belt - Fan; W/O A.C.	AT24833	②▲9570HD	575		
Belt - Fan; W/A.C.	AT59850	②▲9620HD	Yanmar 3-Cyl. 83 Diesel		
Belt - A.C.	H79236	▲9635HD	1994 - 1987		
Hose - Upper - Cooler To Rad.		≧20685	Belt - Fan		
Hose - Lower		25528	M806512		
544B Wheel Loader			▲9420HD		

▲Standard Belt Available.
≧Cut to Fit.

②Two Required.
④Four Required.

Road & Construction Equipment

Belts and Coolant Hose for Road & Construction Equipment

Application	Mfr. Part No.	Our No.	Application	Mfr. Part No.	Our No.
John Deere - Continued			John Deere - Continued		
590D			624G; 624GH - Continued		
John Deere 4-Cyl. 276 Diesel			John Deere 6068T Powertech Diesel - Continued		
Belt - Fan	RE44538	②▲9580HD	Belt - A.C.; W/R12 Coolant	H63772	▲9540HD
595; 595D			624H		
John Deere 4-Cyl. 276 Diesel			John Deere 6068T Powertech Diesel		
Belt - Fan	RE44538	②▲9580HD	Belt - Fan, Alt. & A.C.; W/55A., 80A. Alt.	T178416	▲K081005HD
Belt - Compr.	R71459	▲9580HD	Belt - Fan & Alt.; W/55A. Alt.; W/O A.C.	T178415	▲K080626HD
600 Backhoe			Belt - Fan & Alt.; W/80A. Alt.; W/O A.C.	T178417	▲K080645HD
John Deere 6-Cyl. 341			Belt - Fan & Alt.; W/100A. Alt.; W/O A.C.	T184594	▲K080653HD
Belt - Fan & Alt./Gen.	AR41628	②7555	Belt - Fan, Alt. & A.C.; W/100A. Alt.	R130899	K081015HD
Hose - Upper		26509	Tensioner Assy. - Fan & Alt.; W/O A.C.	RE70536	38654
Hose - Lower		20590	624J		
John Deere 6-Cyl. 404 Diesel			John Deere 6-Cyl. 414 Diesel		
Belt - Fan & Alt./Gen.; Ser. No. 200999 & Before	AR41576	②7560	Belt - Alt.; W/55A. Alt.; W/O A.C.	T197521	▲K080620HD
Belt - Fan & Alt./Gen.; Ser. No. 201000 & After	AR41629	②7570	Belt - Alt.; W/55A. Alt.; W/A.C.	T197520	▲K080842HD
Hose - Upper		26509	Belt - Alt.; W/80A. Alt.; W/O A.C.	R500384	▲K080626HD
Hose - Lower		20590	Belt - Alt.; W/80A. Alt.; W/A.C.	T135193	▲K080865HD
600 Wheel Loader			Belt - Alt.; W/100A. Alt.; W/O A.C.	T186776	K080638HD
John Deere 6-Cyl. 341			Belt - Alt.; W/100A. Alt.; W/A.C.	T208891	▲K080859HD
Belt - Fan & Alt./Gen.	AR41628	②7555	Tensioner Assy.	RE518097	38507
Hose - Upper		26509	640		
John Deere 6-Cyl. 404 Diesel			John Deere 6-Cyl. 414 Diesel		
Belt - Fan & Alt./Gen.; Ser. No. 200999 & Before	AR41576	7560	Belt - Fan & Alt.	T26755	▲9570HD
Belt - Fan & Alt.; Ser. No. 201000 & After ...	AR41629	7570	644 Wheel Loader		
Hose - Upper		26509	John Deere 6-Cyl. 404 Diesel		
Hose - Lower		20590	Belt - Fan	AT30181	②TR22607
600C LC			Belt - Alt.	T31165	7335
Isuzu 6-Cyl. 957 Diesel			Hose - Upper; Ser. No. 164553 & Before		26522
Belt - Fan	1136714890	②BX67	Hose - Upper; Ser. No. 164554 & After		26522
Belt - A.C.	4612763	BX55	Hose - Lower		26532
605K			644B Wheel Loader		
John Deere 4-Cyl. 276 Diesel			John Deere 6466A Diesel; John Deere 6-Cyl. 531 Diesel		
Belt - A.C.	R135607	▲K080785HD	Belt - Fan	AR93013	②TR24619
610B			Belt - Alt.	R55084	TR22350
John Deere 4-Cyl. 241			Belt - A.C.	T60985	▲9420HD
Belt - Fan & Alt.	AR54592	②▲9625HD	Hose - Upper		21042
610C			Hose - By Pass		≈20338
John Deere 4-Cyl. 276 Diesel			644C Wheel Loader		
Belt - Fan	AR54592	②▲9625HD	John Deere 6-Cyl. 466 Diesel		
Belt - A.C.	T38174	TR22405	Belt - Fan	AR92182	②TR22625
Hose - By Pass		28439	Belt - Fan & Hyd. Brake Boost Pump	AR91135	BX65
624E			Belt - Alt.	T52753	▲9380HD
John Deere 6068T Powertech Diesel			Belt - A.C.	T54060	▲9420HD
Belt - Fan & Alt.; W/65A. Alt.	AR43219	②▲9600HD	Hose - Upper		26523
Belt - Fan & Alt.; W/78A., 105A., 130A. Alt.; W/63" Belt O.C.	AR54592	②▲9625HD	644EH		
Belt - Fan & Alt.; W/130A. Alt.; W/63 1/2" Belt O.C.	AR57266	②▲9630HD	John Deere 6076A Diesel		
Belt - A.C.	H63772	▲9540HD	Belt - Fan & Alt.	AR87671	②▲9700HD
624G; 624GH			644J		
John Deere 6068T Powertech Diesel			John Deere 6081 Powertech Diesel		
Belt - Fan & Alt.; W/95A. Alt.	AR54592	②▲9625HD	Belt - Fan; W/A.C.	T178419	▲K080755HD
Belt - Fan & Alt.; W/135A. Alt.	AR69141	②▲9635HD	Belt - Fan; W/O A.C.	T178418	K080480HD
Belt - A.C.; W/R134 Coolant	T149108	▲9530HD	Tensioner Assy.	RE518097	38507
			645C		
			John Deere 6-Cyl. 466 Diesel		
			Hose - Upper		26523

▲Standard Belt Available.
≈Cut to Fit.

②Two Required.

Belts and Coolant Hose for Road & Construction Equipment

Application	Mfr. Part No.	Our No.	Application	Mfr. Part No.	Our No.
John Deere - Continued			John Deere - Continued		
650D LC			710C		
Isuzu 6-Cyl. 957 Diesel			John Deere 6059T Diesel		
Belt - A.C.	4612763	BX55	Belt - Fan & Alt.	AR54592	②♣9625HD
655 Crawler Loader; 655B			Belt - Hyd. Pump	R82437	♣9395HD
John Deere 6-Cyl. 415 Diesel			Hose - Upper		26509
Belt - Fan	AR96396	②BX60	710D		
Belt - Alt.	T68320	♣9430HD	John Deere 6068T Powertech Diesel		
Belt - A.C.	R69955	♣9451HD	Belt - Fan; W/A.C.; Ser. No. 872328 & Before		
670 Grader				R135198	♣K080986HD
John Deere 6-Cyl. 414 Diesel			Belt - Fan; W/A.C.; Ser. No. 872329 & After		
Belt - Fan & Alt.	AT24833	②♣9570HD		R135612	K080994HD
670A			Belt - Fan; W/O A.C.; Ser. No. 872328 & Before		
John Deere 6-Cyl. 414 Diesel				R135200	♣K080680HD
Belt - Fan & Alt.; W/42A. Alt.	AR72036	②♣9590HD	Belt - Charge Pump; W/O A.C.		
Belt - Fan & Alt.; W/50A. Alt.	AT58166	②♣9610HD		R82437	♣9395HD
670G LC			Belt - Charge Pump; W/A.C.		
Isuzu 6-Cyl. 957 Diesel				T148207	♣9510HD
Belt - A.C.	4612763	BX55	Tensioner Assy. - Fan & Alt.		
672B				RE70535	38507
John Deere 6068T Powertech Diesel			Tensioner Pulley - Fan & Alt.		
Belt - Fan & Alt.; W/42A. Alt.	AR72036	②♣9590HD		RE70535	36091
Belt - Fan & Alt.; W/50A. Alt.	AR57266	②♣9630HD	710J		
Belt - Fan & Alt.; W/Bosch Alt.	AT58166	②♣9610HD	John Deere 6-Cyl. 415 Diesel		
Belt - Fan & Alt.; W/Delco Alt.	RE44538	②♣9580HD	Belt - Fan; W/O A.C.; W/Ambient Air Pkg. ...		
675				R505186	K080655
Yanmar 4-Cyl. 111 Diesel			Belt - Fan; W/A.C.; W/Ambient Air Pkg.		
1989 - 1987				R500173	♣K080893HD
Belt - Fan & Alt.	M801821	♣9390HD	710K		
675B			John Deere 6-Cyl. 415 Diesel		
Yanmar 4-Cyl. 111 Diesel			Tensioner Assy.		
1994 - 1987				RE518097	38507
Belt - Fan & Alt.		♣9390HD	724J		
690; 690A			John Deere 6081 Powertech Diesel		
John Deere 6-Cyl. 404 Diesel			Belt - Fan; W/A.C.		
Belt - Fan; Ser. No. 280000 & Before	AR43648	②♣9550HD		T178419	♣K080755HD
Belt - Fan & Alt.; Ser. No. 280001 & After ...	AR43219	②♣9600HD	Belt - Fan; W/O A.C.		
Belt - Alt.; Ser. No. 280000 & Before	U46257	♣9309HD		T178418	K080480HD
Hose - Upper		≧<20523	Tensioner Assy.		
	or	26515		RE518097	38507
Hose - By Pass; Molded Hose		≧<20802	740		
Hose - By Pass; Strt. Hose		28443	John Deere 6-Cyl. 404 Diesel		
690B			Belt - Alt.		
John Deere 6-Cyl. 404 Diesel				T37416	♣9350HD
Belt - Fan & Alt.	AR53099	②♣9650HD	744E		
690DLC			John Deere 6101AT Diesel		
John Deere 6-Cyl. 414 Diesel			Belt - Fan		
Belt - Fan & Alt.	RE22470	②♣9580HD		AR93012	②TR24578
690E			Belt - Fan & Alt.		
John Deere 6-Cyl. 414 Diesel				T37416	♣9350HD
Belt - Fan; Ser. No. 704568 & Before	R108842	♣K080745HD	Hose - By Pass		
Belt - Fan; Ser. No. 704569 & After	R123432	♣K080615HD			≧<20065
710B			750LC		
John Deere 6-Cyl. 359 Diesel			Cummins N14 Diesel		
Belt - Fan & Alt.	AR69141	♣9635HD	Belt - W.P.		
				4S00293	♣K060435HD
			755D		
			John Deere 6-Cyl. 414 Diesel		
			Tensioner Assy.		
				RE518097	38507
			760		
			John Deere 6-Cyl. 531 Diesel		
			Belt - Fan & Alt.		
				AR56638	②7612
			Hose - Upper		
					24232
			Hose - Lower		
					20967
			or		
					26535
			Hose - By Pass - Front Eng.		
					24222
			Hose - By Pass - Rear Eng.		
					≧<21942
			760A		
			John Deere 4-141T Diesel		
			Belt - Fan		
				AR56638	②7612
			John Deere 6-Cyl. 531 Diesel		
			Belt - Fan		
				AR56638	②7612

②Two Required.
≧<Cut to Fit.

♣Standard Belt Available.

Road & Construction Equipment

Belts and Coolant Hose for Road & Construction Equipment

Application	Mfr. Part No.	Our No.	Application	Mfr. Part No.	Our No.
John Deere - Continued			John Deere - Continued		
760A - Continued			790E LC		
John Deere 6-Cyl. 531 Diesel - Continued			John Deere 6-Cyl. 414 Diesel		
Hose - Upper		24232	Belt - Fan	R108842	♣K080745HD
Hose - Lower		20967	844		
		26535	John Deere 8955 Diesel		
Hose - By Pass - Front Eng.		24222	Belt - Fan	AT51740	③TR22635
Hose - By Pass - Rear Eng.		≈<21942	Belt - Alt.	N113642	♣9440HD
762 Scaper			Belt - A.C.; Ser. No. 512747 & Before	T58740	♣9605HD
John Deere 6619T Diesel			Belt - A.C.; Ser. No. 512748 & After	H79236	♣9635HD
Belt - Fan & Hyd. Pump	AR93011	②TR22607	Hose - Upper; Ser. No. 512748 & After		26533
Belt - Alt.; W/42A. Alt.	R55084	TR22350	Hose - Lower		≈<20530
Belt - Alt.; W/70A. Alt.	T38174	TR22405	850B Crawler Tractor		
Hose - By Pass		≈<20504	John Deere 6-Cyl. 466 Diesel		
762A			1994 - 1985		
John Deere 6466A Diesel			Belt - Fan	AT31010	③♣9620HD
Belt - Fan	AR91135	②BX65	Belt - Fan To Alt.	T37416	♣9350HD
Belt - Alt.	R69955	♣9451HD	Belt - A.C.	R73189	♣9430HD
764HSD Dozer			850D LC		
John Deere 6-Cyl. 414 Diesel			Isuzu 6-Cyl. 957 Diesel		
2015 - 2008			Belt - A.C.	4612763	BX55
Belt - Alt.	T210568	♣K080780HD	850K Crawler Dozer		
Tensioner Assy.	RE518097	38507	John Deere 6-Cyl. 414 Diesel		
770 Grader			2015 - 2011		
John Deere 6-Cyl. 531 Diesel			Tensioner Assy.	RE518097	38507
Belt - Fan & Alt.	AR69141	②♣9640HD	860; 860A		
Hose - Upper		≈<21378	Detroit Diesel 6-71N Diesel		
		26510	Belt - Fan	AT36805	②TR22455
Hose - By Pass		≈<20573	Belt - Alt.	T38174	TR22405
770B			Hose - Upper		≈<20420
John Deere 6059T Diesel; John Deere 6466T Diesel					26507
Belt - Fan & Alt.; W/42A. Alt.	AT76490	②♣9660HD	Hose - Lower		26509
Belt - Fan & Alt.; W/45A. Alt.	RE12086	②♣9690HD	862		
Belt - Fan & Alt.; W/50A. Alt.	AR87671	②♣9700HD	John Deere 6619A Diesel		
Belt - Compr.	R73189	♣9430HD	Belt - Alt.	AR91680	②♣9610HD
770BH			Belt - A.C.	H80897	♣9500HD
John Deere 6076A Diesel; John Deere 6466AT Diesel			870G LC		
Belt - Fan & Alt.; W/42A. Alt.	AT76490	②♣9660HD	Isuzu 6-Cyl. 957 Diesel		
Belt - Fan & Alt.; W/45A. Alt.	RE12086	②♣9690HD	Belt - A.C.	4612763	BX55
Belt - Fan & Alt.; W/50A. Alt.	AR87671	②♣9700HD	890		
Belt - Compr.	R73189	♣9430HD	John Deere 6-Cyl. 619 Diesel		
772A			Belt - Fan	AR93009	②TR24597
John Deere 6-Cyl. 466 Diesel			890A		
Belt - Fan & Alt.; W/42A. Alt.	AR69141	②♣9640HD	John Deere 6-Cyl. 619 Diesel		
Belt - Fan & Alt.; W/50A. Alt.	AR86496	②♣9670HD	Belt - Fan	AR93009	②TR24597
Hose - By Pass		≈<20065	Belt - Alt.	R77776	♣9700HD
772AH			892D LC		
John Deere 6466AT Diesel			John Deere 6-Cyl. 466 Diesel		
Belt - Fan & Alt.; W/50A. Alt.	AR87671	②♣9700HD	Belt - Fan	AT31820	②♣9560HD
Belt - Fan & Alt.; W/42A. Alt.	AT76490	②♣9660HD	892E LC		
790 Excavator			John Deere 6-Cyl. 466 Diesel		
John Deere 6-Cyl. 466 Diesel			Belt - Fan	RE45465	②♣9530HD
Belt - Fan	AT31820	②♣9560HD	Belt - Alt.	R108621	♣9435HD
Belt - Compr.	R71459	♣9580HD			
790D					
John Deere 6466A Diesel					
Belt - Fan & Alt.	AT31820	②♣9560HD			

≈<Cut to Fit.
♣Standard Belt Available.

②Two Required.
③Three Required.

Belts and Coolant Hose for Road & Construction Equipment

Application	Mfr. Part No.	Our No.	Application	Mfr. Part No.	Our No.
John Deere - Continued			John Deere - Continued		
950J Crawler Dozer			6675 - Continued		
Liebherr 6-Cyl. 641 Diesel 2015 - 2006 Belt - Fan; W/A.C. LW11005218 ♣K080690HD			John Deere 4-Cyl. 122 Diesel - Continued 1998 - 1994 - Continued Belt - Fan; W/40" Belt O.C. M802627 ♣9412HD		
990 Excavator			7775		
John Deere V-8 955 Diesel Belt - Fan AT75425 ③TR22607 Belt - Alt T60985 ♣9420HD Belt - Fan To A.C. ♣9625HD			John Deere 4-Cyl. 134 Diesel 1998 - 1994 Belt - Fan; W/41" Belt O.C. M806512 ♣9420HD Belt - Fan; W/40" Belt O.C. M802627 ♣9412HD		
992D LC			8875		
John Deere 6-Cyl. 619 Diesel Belt - Fan AR93009 ②TR24597			John Deere 3-Cyl. 179 Diesel 1998 - 1994 Belt - Fan R73784 TR22525		
992E; 992E LC			CT315		
John Deere 6-Cyl. 619 Diesel Belt - Fan RE50059 ②BX50			John Deere 4-Cyl. 149 Diesel 2011 - 2009 Belt - Fan R505810 ♣K060923HD		
1010C			JD646		
John Deere 4-Cyl. 115 Belt - Fan & Gen.; Ser. No. 21900 & Before T12530T 7440 Belt - Fan & Gen.; Ser. No. 21091 & After .. T626T 7480			John Deere 6-Cyl. 531 Diesel Belt - Fan & Alt AT30181 ②TR22607 Belt - A.C. T60985 ♣9420HD Hose - Upper - Cooler To Rad. 26522 Hose - Lower 26532		
John Deere 4-Cyl. 145 Diesel Belt - Fan & Gen.; Ser. No. 21900 & Before T11961T 7435 Belt - Fan & Gen.; Ser. No. 21901 & After .. T626T 7480			JD646B		
1050J Crawler Dozer			John Deere 6-Cyl. 531 Diesel Belt - Fan & Alt AR63876 ②TR20619		
Liebherr 6-Cyl. 732 Diesel 2015 - 2006 Belt - Fan; W/A.C. LW11005218 ♣K080690HD			TC44H		
2010 Crawler			John Deere 4045T Powertech Diesel Belt - Alt.; W/55A. Alt.; W/O A.C. R135595 ♣K080708HD Belt - Alt.; W/80A. Alt.; W/O A.C. T178413 ♣K080716HD Belt - Alt.; W/100A. Alt.; W/O A.C. R135600 ♣K080726HD Tensioner Assy.; W/O A.C. RE70536 38654		
John Deere 4-Cyl. 145; John Deere 4-Cyl. 165 Diesel Belt - Fan & Gen. T17918T TR22514			TC54H		
3375			John Deere 6068T Powertech Diesel Belt - Alt.; W/55A. Alt.; W/A.C. T178465 K081065HD Belt - Alt.; W/55A. Alt.; W/O A.C. T178537 ♣K080730HD Belt - Alt.; W/80A. Alt.; W/A.C. T178548 ♣K081088HD Belt - Alt.; W/80A. Alt.; W/O A.C. T178536 ♣K080734HD Belt - Alt.; W/100A. Alt.; W/O A.C. R199163 ♣K080745HD Belt - Alt.; W/100A. Alt.; W/A.C. T190810 K081099HD Tensioner Assy.; W/O A.C. RE70536 38654		
John Deere 3-Cyl. 42 Diesel 1999 - 1994 Belt - W.P. M800048 7340 Belt - Hyd. Pump M125661 3VX425			TC62H		
4475			John Deere 6068T Powertech Diesel Belt - Fan, Alt. & A.C.; W/55A., 80A. Alt. T178416 ♣K081005HD Belt - Fan & Alt.; W/55A. Alt.; W/O A.C. T178415 ♣K080626HD Belt - Fan & Alt.; W/80A. Alt.; W/O A.C. T178417 ♣K080645HD Belt - Fan & Alt.; W/100A. Alt.; W/O A.C. T184594 ♣K080653HD Belt - Fan, Alt. & A.C.; W/100A. Alt. R130899 K081015HD Tensioner Assy. - Fan & Alt.; W/O A.C. RE70536 38654		
John Deere 3-Cyl. 91 Diesel 1998 - 1994 Belt - Fan M801821 ♣9390HD			Joy		
5010 Scraper			RP125G51		
John Deere 6-Cyl. 531 Diesel Belt - Fan; W/O A.C. AR56638 ②7612 Belt - Fan; W/A.C. AR46970 ②7665 Hose - Upper 24232 Hose - Lower 20967 or 26535			Continental FA162 Belt - Fan F401K204 TR24414		
5575			RP250D31		
John Deere 3-Cyl. 100 Diesel 1998 - 1995 Belt - Fan M806512 ♣9420HD			Hercules D3400 Diesel Belt - Fan 270632A ②♣9425HD		
6675					
John Deere 4-Cyl. 122 Diesel 1998 - 1994 Belt - Fan; W/41" Belt O.C. M806512 ♣9420HD					

③Three Required.
②Two Required.

♣Standard Belt Available.

Road & Construction
Equipment

Belts and Coolant Hose for Road & Construction Equipment

Road & Construction Equipment

Application	Mfr. Part No.	Our No.	Application	Mfr. Part No.	Our No.
Joy - Continued			Kobelco		
RP250G31			K907LC Mark II		
Hercules G3400			Mitsubishi 6D31T Diesel		
Belt - Fan	270632A	②▲9425HD	Belt - Fan & Alt.		▲9476HD
RPS185			K909LC Mark II		
IH			Mitsubishi 6D22T Diesel		
Belt - Fan & Alt.	275301C2	▲9470HD	Belt - Fan & Alt.		②TR22416
Hose - Upper - Eng. To Pipe		24232	Hose - Upper		26510
Hose - Upper - Pipe To Rad.		24224	Hose - Lower - Eng. To Pipe		③<21115
Hose - Lower - Eng. To Pipe		24228	Hose - Lower - Pipe To Rad.		③<21115
Hose - Lower - Pipe To Rad.		25482	LK350 Mark II		
RPS750			Isuzu 4BD1-T Diesel		
Caterpillar D333 Diesel			Belt - Fan & Alt.		②TR22495
Hose - Upper - Eng. To Pipe		③<20369	Hose - Upper		26511
Hose - Upper - Pipe To Rad.		24436	LK700A		
Hose - Lower - Eng. To Pipe		24444	Nissan PE604 Diesel		
Hose - Lower - Pipe To Rad.		24444	Hose - Upper - Eng. To Pipe		24234
RPS900DB30			Hose - Upper - Pipe To Rad.		24234
Detroit Diesel 8V-71 Diesel			Hose - Lower - Eng. To Pipe		24238
Belt - Fan	5133764	▲9560HD	Hose - Lower - Pipe To Rad.		24238
RPS1050			Koehring		
Detroit Diesel 8V-71 Diesel			166		
Belt - Fan	5133764	③▲9560HD	Detroit Diesel 4-53T Diesel		
Belt - Gen.		▲9380HD	Belt - Fan & Alt.		▲9440HD
Hose - Upper - Eng. To Pipe		②24236	Hose - Upper		③<20957
Hose - Upper - Pipe To Rad.		②24236	255A		
Hose - Lower - Eng. To Pipe		24244	Detroit Diesel 4-53 Diesel		
Hose - Lower - Pipe To Rad.		24244	Belt - Fan		②▲9480HD
RPS1200; RPS1300			Belt - W.P. & Alt.		②▲9430HD
Caterpillar D343 Diesel			Hose - Upper		③<21794
Belt - Fan	6L9903	③TR24578	Hose - Lower		②24432
Belt - Alt.	6L3408	▲9476HD	304		
Hose - Upper - Eng. To Pipe		24448	Caterpillar D318 Diesel		
Hose - Upper - Pipe To Rad.		②24442	Belt - Gov.	4B2544	▲9425HD
Hose - Lower - Eng. To Pipe		24448	Detroit Diesel 3-71 Diesel		
Hose - Lower - Pipe To Rad.		24448	Belt - Fan	3224368	TR34545
RPV100GA20			305		
Continental			Detroit Diesel 4-71 Diesel		
Belt - Fan	X27019454	▲9451HD	Hose - Upper		26510
RPV160DA23			Hose - Lower		26508
Continental			Detroit Diesel 6-71 Diesel		
Belt - Fan	206373A	▲9480HD	Belt - Fan & Compr.	5136265	②▲9690HD
RPV160GA20			Belt - Alt.	5133515	▲9370HD
Continental			405-2A		
Belt - Fan		▲9476HD	Buda LO525		
RSP750			Belt - Fan	DP1597	TR28666
Caterpillar D333 Diesel			Belt - Gen.	K40285	TR28583
Belt - Fan & Alt.		③▲9540HD	Caterpillar D318 Diesel		
Kawasaki			Belt - Gen.	4B2544	▲9425HD
115ZIII			Detroit Diesel 4-71 Diesel		
Cummins KT19C Diesel			Belt - Fan	3224368	TR34545
Belt - W.P. & Alt.	206996	K050370	428		
Belt - A.C.		TR22692	Caterpillar 3208 Diesel		
Hose - Lower		24456	Belt - W.P. & Alt.	3N1490	②▲9510HD
			Belt - Fan, Hyd. Pump & Air Brake Compr.		②▲9670HD

▲Standard Belt Available.
③Three Required.

③Cut to Fit.
②Two Required.

Belts and Coolant Hose for Road & Construction Equipment

Application	Mfr. Part No.	Our No.	Application	Mfr. Part No.	Our No.
Koehring - Continued			Komatsu - Continued		
428 - Continued			D20A3; D20P3; D20PL3		
Caterpillar 3208 Diesel - Continued			Komatsu 4D91-1A Diesel		
Hose - Upper		26511	1983 - 1973		
Hose - Lower		26510	Belt - Fan & Alt.; W/Cold Weather Start;		
600WD			Ser. No. 33517 & After	0412001723	TR22455
Detroit Diesel 4-71 Diesel			D20Q3; D20S3		
Belt - Fan	3224368	TR34545	Komatsu 4D91-1A Diesel		
Belt - Gen.	3224367	TR28390	Belt - Fan & Alt.; W/Cold Weather Start;		
666D			Ser. No. 33517 & After	0412001723	TR22455
Detroit Diesel 8V-71N Diesel			D21A3; D21P3		
Belt - Fan		③♣9550HD	Komatsu 4D92-1B Diesel		
Belt - Alt.		②7280	1985 - 1973		
6620			Belt - Fan & Alt.; W/Cold Weather Start;		
Isuzu 6BG1T Diesel			Ser. No. 11008 & After	0412001723	TR22455
Belt - Fan & Alt.		②♣9480HD	D21Q3; D21S3		
Hose - Upper		26511	Komatsu 4D92-1B Diesel		
LRT18U			Belt - Fan & Alt.; W/Cold Weather Start;		
Detroit Diesel 4-53N Diesel			Ser. No. 11008 & After	0412001723	TR22455
Belt - Fan & Hyd. Pump		②♣9451HD	D30A15; D30P15		
Belt - Alt.		②7425	Komatsu 4D105-1C Diesel		
Hose - Upper		24428	1976 - 1973		
LRT180			Belt - Fan & Alt.; W/500W. Cold Weather		
Detroit Diesel 6V-53 Diesel			Start; Ser. No. 19669 & After	0412032250	TR28498
Belt - Fan		♣9375HD	D30Q15; D30S15		
Belt - W.P.		②7370	Komatsu 4D105-1C Diesel		
Belt - Alt.		②7370	Belt - Fan & Alt.; W/500W. Cold Weather		
Belt - A.C.		♣9370HD	Start; Ser. No. 19669 & After	0412032250	TR28498
LRT275			D31A		
Cummins 6-Cyl. 5.9 L Diesel			Komatsu 4D105-3 Diesel		
Belt - Fan & Alt.	3903091	♣K080560HD	1990 - 1977		
Hose - Upper		24932	Belt - Fan & Alt.		TR22508
Hose - Lower		26525	Hose - Upper		♣20957
LRT1600				or	26501
Detroit Diesel 6V-53 Diesel			Hose - Lower		26510
Belt - Fan		♣9375HD	D37E2		
Belt - W.P.		②7370	Komatsu 6D95L-1 Diesel		
Belt - Alt.		②7370	2001 - 1987		
Belt - A.C.		♣9370HD	Belt - Fan		TR22525
Hose - Upper		②25482	Belt - Fan To Alt.		TR22322
Hose - Lower		26510	D40P1; D45P1		
MPH-1			Komatsu S4D105 Diesel		
Detroit Diesel 8V-71 Diesel			Belt - Fan & Alt.; W/350W. Starter; Ser.		
Belt - Fan	5143493	③♣9740HD	No. 18273 & After	0412102239	②TR28570
Belt - Gen.		♣9415HD	Belt - Fan & Alt.; W/350W. Starter; Ser.		
Hose - Lower		26537	No. 19078 & After	0412102239	②TR28570
Komatsu			D50A15; D50P15; D50S15		
CK35-1			Komatsu 4D120-11A Diesel; Komatsu 4D120-11S Diesel		
Komatsu S4D98E Diesel			Belt - Fan & Gen.; W/Cold Weather Start;		
2007			Ser. No. 85343 & After	0412032266	TR28657
Belt - Fan & A.C.	AVX13X1145LA	♣9451HD	Belt - Fan & Gen.; W/Std. Start; Ser. No.		
Belt - A.C. To Alt.	AVX13X930LA	♣9365HD	85343 & After	0412032266	TR28657
D10A			Belt - Alt.; W/800W. Cold Weather Start;		
Komatsu 2D92-1B Diesel			Ser. No. 85343 & After	0412032235	TR28346
1975 - 1973			D53A1; D53S1		
Belt - Fan & Gen.; Ser. No. 11225 & After ..	6140812622	7455	Komatsu S4D120-11 Diesel		
			Belt - Fan & Alt.; W/800W. Cold Weather		
			Start; Ser. No. 87351 & After	0412132266	②TR28657

♣Standard Belt Available.
②Two Required.

③Three Required.
♣Cut to Fit.

Road & Construction Equipment

Belts and Coolant Hose for Road & Construction Equipment

Application	Mfr. Part No.	Our No.	Application	Mfr. Part No.	Our No.
Komatsu - Continued			Komatsu - Continued		
D53A1; D53S1 - Continued			D65P		
Komatsu S4D120-11 Diesel - Continued			Cummins NH220CI Diesel		
Belt - Fan & Gen.; W/Cold Weather Start; Ser. No. 87351 & After	0412132266	②TR28657	Hose - Upper		26521
Belt - Fan & Gen.; W/Std. Start; Ser. No. 87351 & After	0412122266	②TR28657	Hose - Lower		26520
D55S			D65S		
Komatsu S4D120 Diesel			Cummins NH220CI Diesel		
Belt - Fan & Gen.		②TR30672	Belt - Fan & Gen.		②TR28616
Hose - Upper		≈<20611	Hose - Upper		26522
		or	Hose - Lower		24236
Hose - Lower - Eng. To Pipe		26509	D65S6		
Hose - Lower - Pipe To Rad.		24232	Cummins NH220CI Diesel		
D55S3			Belt - Fan & Gen.; W/Std. Start; Ser. No. 40447 & After		
Komatsu S4D120-11S Diesel				0412102238	②TR28565
Belt - Alt.; W/800W. Cold Weather Start; Ser. No. 85513 & After	0412132235	②TR28346	D66S1		
D60A6			Komatsu SA6D110-1 Diesel		
Cummins NH220CI Diesel			Belt - Fan & Alt.		
Belt - Fan; W/Cold Weather Start; Ser. No. 18542 & After	0412112260	②TR28733	Hose - Upper		
Belt - W.P. & Gen.; W/Std. Start; Ser. No. 18542 & After	6676836160	TR24500	Hose - By Pass		
D60P			②TR2625		
Cummins NH220CI Diesel			②TR2942		
Hose - Upper		26523	D75S		
Hose - Lower		26520	Cummins NH220CI Diesel		
D60P6; D60PL6			Belt - Fan & Gen.		
Cummins NH220CI Diesel			②TR24709		
Belt - Fan; W/Cold Weather Start; Ser. No. 18542 & After	0412112260	②TR28733	Belt - W.P.; Ser. No. 15598 & After; W/Cold Weather Start		
Belt - W.P. & Gen.; W/Std. Start; Ser. No. 18542 & After	6676836160	TR24500		0412011914	TR24400
D65A6			Hose - Upper		
Cummins NH220CI Diesel			26524		
Belt - Fan; W/Cold Weather Start; Ser. No. 18542 & After	0412112260	②TR28733	D80A; D85A12		
Belt - W.P. & Gen.; W/Std. Start; Ser. No. 18542 & After	6676836160	TR24500	Cummins NH220CI Diesel		
D65A6			Belt - Fan; Ser. No. 118539 & After		
Cummins NH220CI Diesel			0412102261		
Belt - Fan; W/Cold Weather Start; Ser. No. 18542 & After	0412112260	②TR28733	Belt - W.P. & Gen.; Ser. No. 118539 & After		
Belt - W.P. & Gen.; W/Std. Start; Ser. No. 18542 & After	6676836160	TR24500	6682836170		
D65A6			TR24500		
Cummins NH220CI Diesel			D85E		
Belt - Fan; W/Cold Weather Start; Ser. No. 18542 & After	0412112260	②TR28733	Cummins NT855 Diesel		
Belt - W.P. & Gen.; W/Std. Start; Ser. No. 18542 & After	6676836160	TR24500	Belt - Alt.		
Belt - W.P. & Alt.; W/500W. Starter; Ser. No. 18542 & After	0412011926	TR24489	Hose - Upper		
D65E			TR24476		
Cummins NH22CI Diesel			24438		
Belt - Fan		②TR28693	D95S1		
Belt - W.P. & Gen.		TR24500	Komatsu S4D155-4 Diesel		
D65E6			Belt - Alt.; W/Cold Weather Start; Ser. No. 50061 & After		
Cummins NH220CI Diesel				0412001921	TR24449
Hose - Upper		≈<20731	D135A		
		or	Komatsu SA6D125 Diesel		
		26523	1995 - 1988		
D65E6			Belt - Fan		
Cummins NH220CI Diesel			②TR28786		
Belt - Fan & Gen.; W/Std. Start; Ser. No. 40447 & After	0412102238	②TR28565	D135A2		
D65EX			Komatsu S6D140 Diesel		
Komatsu SD125E2 Diesel			1994 - 1990		
Hose - Upper		26533	Belt - Fan		
				0412022276	②C72
			D155A		
			Komatsu S6D155-4 Diesel		
			1999 - 1987		
			Belt - Alt.		
			♣9309HD		
			D155A1		
			Komatsu S6D155-4 Diesel		
			1991 - 1980		
			Belt - Alt.		
			♣9309HD		

②Two Required.
♣Standard Belt Available.

≈<Cut to Fit.

Belts and Coolant Hose for Road & Construction Equipment

Application	Mfr. Part No.	Our No.	Application	Mfr. Part No.	Our No.
Komatsu - Continued			Komatsu - Continued		
D355A			HD180-4		
Komatsu S6D155-4 Diesel 1993 - 1977 Belt - Alt.		♣9309HD	Cummins NTO6B Diesel Belt - W.P.; W/Std. Start; Ser. No. 119381 & After	6610816111	TR24400
D355A1			HD320-2		
Komatsu S6D155-4 Diesel 1993 - 1973 Belt - Alt.		♣9309HD	Cummins NTA855 Diesel Belt - Gen.; W/Std. Start; Ser. No. 112754 & After	0412001923	TR24461
D355A3			HD680		
Komatsu SA6D155-4A Diesel 1993 - 1977 Belt - Alt.; W/Cold Weather Start; Ser. No. 20338 & After	0412031950	TR24500	Cummins VTA1710C Diesel Belt - W.P.; W/Std. Start	178665	TR28390
Belt - Alt.; W/Std. Start; Ser. No. 20338 & After	0412031950	TR24500	Belt - Alt.; W/Std. Start	178558	♣9341HD
D375A			PC05-5		
Komatsu SA6D170 Diesel 2006 - 1985 Belt - Fan	0412022577	②TR30770	Komatsu 3D72-2B Diesel Belt - Fan & Alt.	YM1196442290	7360
Belt - W.P. To Alt.		TR24379	Hose - Upper		25150
Belt - A.C.	0412021740	TR22397	PC120		
Hose - Upper		24448	Komatsu 6D95L-1 Diesel Belt - Fan & Alt.	0412021746	②TR22461
GD22H-1			PC180LC		
Komatsu 4D105-1C Diesel Belt - Fan & Alt.; W/800W. Cold Weather Start	0412002236	TR28557	Komatsu S6D95L Diesel Belt - Fan & Alt.		②TR22461
Belt - Fan & Gen.; W/350W. Starter		TR28522	PC200LC		
GD30-5M			Komatsu S6D105 Diesel Belt - Fan & Alt.	0412021748	TR22485
Komatsu 4D120-11G Diesel Belt - Fan & Alt.; W/800W. Cold Weather Start; Ser. No. 85343 & After	0412032266	②TR28657	Komatsu SA6D95L-1 Diesel Belt - Serpentine		♣K060735HD
GD31-5H			PC220LC		
Komatsu S4D120-11G Diesel Belt - Fan & Alt.; W/800W. Cold Weather Start; Ser. No. 84832 & After	0412132266	②TR28657	Komatsu S6D105 Diesel Belt - Fan & Alt.	0412021748	TR22485
Belt - Fan & Gen.; W/Cold Weather Start; Ser. No. 84832 & After	0412132266	②TR28657	Komatsu SA6D95L-1 Diesel Belt - Serpentine		♣K060735HD
Belt - Fan & Gen.; W/Std. Start	0412122266	②TR28657	Hose - Upper		≡21378
GD37-5H			PC300LC		
Komatsu S4D120-11F Diesel Belt - Fan & Gen.; Ser. No. 85044 & After ..	0412122266	②TR28657	Komatsu SA6D108 Diesel Hose - Upper		26525
GD615A			Hose - By Pass		24220
Komatsu S6D110 Diesel Belt - Fan & Alt.		②TR22607	PC360LC		
Hose - Upper		26524	Komatsu S6D125 Diesel Belt - Fan & Alt.		②TR30624
Hose - Lower		26532	PC400LC3		
GD655-3			Komatsu S6D125 Diesel Belt - Fan & Alt.	0412022262	②TR28616
Komatsu SAA6D114E Diesel Belt - Alt.	3289536	♣K080734HD	Hose - Upper		26525
Belt - A.C.	0412021748	TR22485	Hose - By Pass		24228
GD705A			PC650		
Cummins NTO6B Diesel Belt - Fan & Alt.		②TR28628	Komatsu SA6D140-1 Diesel Belt - Alt.		TR22299
Belt - W.P.	0412021949	TR24489	Belt - A.C.	0412021735	TR22344
Hose - Upper		24838	Hose - Upper		24440
Hose - Lower		24838			

♣Standard Belt Available.
≡Cut to Fit.

②Two Required.

Road & Construction
Equipment

Belts and Coolant Hose for Road & Construction Equipment

Application	Mfr. Part No.	Our No.	Application	Mfr. Part No.	Our No.
Komatsu - Continued			Komatsu - Continued		
SK815-5			WA250 - Continued		
Komatsu S4D84E Diesel			Komatsu S6D105 Diesel - Continued		
2007 - 2003			Hose - Upper ②24432		
Belt - Alt. A37			Hose - Lower ②24436		
SK820-5			WA250-5		
Komatsu S4D84E Diesel			Komatsu SAA6D102E Diesel		
2007 - 2004			Belt - Fan & Alt. 3288889 ▲K080600HD		
Belt - Alt. A37			Belt - Fan To A.C. 0412021744 TR22443		
SK1020-5			WA320		
Komatsu 4SD98E Diesel			Komatsu S6D105 Diesel		
2007 - 2004			Belt - Fan & Alt. 0412121760 ②B57		
Belt - Alt. ▲9405HD			Hose - Upper ②24432		
SK1026-5			Hose - Lower ②24436		
Komatsu 4SD98E Diesel			Hose - By Pass ≡<21942		
2007 - 2005			WA320-5		
Belt - Fan & A.C. AVX13X1145LA ▲9451HD			Komatsu SAA6D102E Diesel		
Belt - A.C. To Alt. AVX13X930LA ▲9365HD			Belt - Fan & Alt. 3288889 ▲K080600HD		
WA30			Belt - Fan To A.C. 0412021744 TR22443		
Komatsu 3D84 Diesel			WA350		
Belt - Fan & Alt. 7380			Komatsu S6D110 Diesel		
WA40			Belt - Fan & Alt. 0412021763 ②TR22625		
Komatsu 4D105-5 Diesel			Hose - Upper - Eng. To Pipe 24438		
Belt - Fan & Alt. TR22485			Hose - Upper - Pipe To Rad. 24442		
WA70			Hose - Lower ②24442		
Komatsu 4D95L Diesel			Hose - By Pass ≡<20065		
Belt - Fan & Alt. 0412040118 7470			WA380		
Komatsu 4D95L-W1 Diesel			Komatsu SA6D110 Diesel		
Hose - Upper 25305			Belt - Fan & Alt. 0412021758 ②TR22578		
Hose - Lower 25484			Hose - Upper ②24438		
WA100			Hose - Lower ②24438		
Komatsu 6D95L Diesel			Hose - By Pass ≡<20065		
Belt - Fan & Alt. ②TR22508			WA380-6		
WA120			Komatsu SAA6D107E Diesel		
Komatsu 6D95L Diesel			Belt - Alt. 3289078 ▲K080653HD		
Belt - Fan & Alt.; W/50 1/8" Belt O.C. ②TR22495			Belt - A.C. 0412021746 TR22461		
Belt - Fan & Alt.; W/58 1/4" Belt O.C. 0412021758 ②TR22578			Tensioner Assy. - Alt. 3976834 38516		
Hose - Lower - Eng. To Pipe ≡<20065			WA600		
or			Komatsu S6D170 Diesel		
Hose - Lower - Pipe To Rad. 24226			Belt - Fan ③TR30672		
WA150			Belt - W.P. To Alt. TR26341		
Komatsu 6D105 Diesel			Hose - Upper ②24448		
Belt - Fan & Alt. ②TR22508			Hose - Lower 24948		
WA180			WB140-2N		
Komatsu S6D95L Diesel			Komatsu S4D106-2XFH Diesel		
Belt - Fan & Alt.; W/50 1/8" Belt O.C. 0412021750 ②TR22495			Belt - Fan & Alt. 12390042480 TR22495		
Belt - Fan & Alt.; W/58 1/4" Belt O.C. 0412021758 ②TR22578			WB146PS; WB156PS		
Hose - Lower - Eng. To Pipe 20904			Komatsu S4D102LE-2 Diesel		
Hose - Lower - Pipe To Rad. 24226			Belt - Fan To A.C. AVX13X1125LA ▲9440HD		
WA250			Kubota		
Komatsu 610T Diesel			K400		
Hose - Upper - Eng. To Pipe ≡<21379			Kubota Diesel		
Hose - Upper - Pipe To Rad. 24432			Belt - Fan & Alt.; W/1/2" Belt T.W. A41 ▲9420HD		
Komatsu S6D105 Diesel			Belt - Fan & Alt.; W/21/32" Belt T.W. TR22416		
Belt - Fan & Alt. 0412021761 ②TR22607					

▲Standard Belt Available.
≡<Cut to Fit.

②Two Required.
③Three Required.

Belts and Coolant Hose for Road & Construction Equipment

Application	Mfr. Part No.	Our No.	Application	Mfr. Part No.	Our No.
Kubota - Continued			Kubota - Continued		
KH007			KX101; KX151		
Kubota Z430K1 Diesel			Kubota V1902 Diesel		
Belt - Fan & Alt.	FM32	7320	Belt - Fan & Alt.		♣9420HD
Hose - Upper		≅20782	Hose - Upper		≅21660
Hose - Lower		≅20782		or	25473
KH10D			Hose - By Pass		28441
Kubota S2600D Diesel			L35 Backhoe		
Belt - Fan & Alt.	FM41	7420	Kubota D1703 Diesel		
KH18L; KH28L			Belt - Fan & Alt.	REMF6415	♣9425HD
Kubota S2600D Diesel			Hose - Upper		≅21660
Belt - Fan & Alt.	A43	♣9440HD		or	25476
KH35			Hose - Lower		≅21794
Kubota D850BHW1 Diesel			R310		
Belt - Fan & Alt.	FM355	7355	Kubota V1305 Diesel		
KH41			Belt - Fan & Alt.	2350	7365
Kubota D950BH1 Diesel			R410		
Belt - Fan & Alt.	FM355	7355	Kubota V1902 Diesel		
KH60			Belt - Fan & Alt.; W/11/16" Belt T.W.; W/42 1/4" Belt O.C. .		TR22416
Kubota D1302BH2 Diesel			Belt - Fan & Alt.; W/1/2" Belt T.W.; W/42		
Belt - Fan & Alt.	FM415	7417	3/8" Belt O.C.	REMF6410	♣9420HD
Hose - Upper		26603	R510		
KH90			Kubota V2203 Diesel		
Kubota V1702BH Diesel			Belt - Fan & Alt.; W/39 7/8" Belt O.C.	RPF3410	♣9395HD
Belt - Fan & Alt.; W/1/2" Belt T.W.	A41	♣9420HD	Belt - Fan & Alt.; W/41 7/8" Belt O.C.		♣9415HD
Belt - Fan & Alt.; W/21/32" Belt T.W.		TR22416	Hose - Lower		25251
Hose - Upper		≅20661	Hose - By Pass		26240
	or	25251	Le Roi		
KH91			170RD2		
Kubota D1402BH5 Diesel			Detroit Diesel 3-53 Diesel		
Hose - Upper		≅21660	Belt - Fan	5119188	②♣9390HD
	or	25473	Belt - W.P. & Gen.		7420
Hose - By Pass		28441	Hose - Upper		≅20957
KH170L				or	26501
Kubota S2600D Diesel			A219-89		
Belt - Fan & Alt.		♣9435HD	Perkins 4-Cyl. Diesel		
Hose - Upper		≅20661	Belt - Fan & Alt.		♣9530HD
	or	25251	Hose - Upper - Pipe To Rad.		24436
KH191			Hose - Lower		25482
Kubota S2800D Diesel			HDR12EH		
Belt - Fan & Alt.; W/1/2" Belt T.W.	A41	♣9420HD	Deutz F4L912 Diesel		
Belt - Fan & Alt.; W/21/32" Belt T.W.		TR22416	Belt - Fan		♣9440HD
KH191L			Q125DJE		
Kubota S2800D Diesel			John Deere 3179D Diesel		
Hose - Upper		≅20137	Belt - Fan & Alt.	T20334	TR22474
	or	25251	Le Tourneau		
KX41			666		
Kubota D1105BH Diesel			Cummins H135 Diesel		
Belt - Fan & Alt.	2375	7375	Belt - Fan	178489	②TR22461
Hose - Upper		25251	Belt - Gen.	134816	TR22495
KX71			B70		
Kubota V1505BH Diesel			Detroit Diesel 12V-71 Diesel		
Belt - Fan & Alt.	2375	7375	Belt - Fan	721421	②TR22525
Hose - Upper		25251			

≅Cut to Fit.
②Two Required.

♣Standard Belt Available.

Road & Construction
Equipment

Belts and Coolant Hose for Road & Construction Equipment

Road & Construction Equipment

Application	Mfr. Part No.	Our No.	Application	Mfr. Part No.	Our No.
Le Tourneau - Continued			Le Tourneau - Continued		
CR			Tournapull C - Continued		
Detroit Diesel 6-71 Diesel			Detroit Diesel 6-71 Diesel - Continued		
Belt - Fan		②TR30672	Belt - Compr.	HC2387	TR28545
Belt - Compr.		TR28545	Tournapull D		
F602B			Cummins NCBI400 Diesel		
Detroit Diesel 6V-71 Diesel			Belt - Fan	S3115	②TR28492
Hose - Upper		24236	Belt - W.P.	S3163	TR22434
Hose - Lower		24244	Detroit Diesel 4055 Diesel		
F802A; F804A			Hose - Upper; W/15" Hose		
Cummins NT855 Diesel			Hose - Lower; W/15" Hose		
Hose - Upper		24232	26509		
Hose - Lower		24236	Detroit Diesel 4055C Diesel		
Detroit Diesel 8V-71 Diesel			Belt - Fan	3224368	TR34545
Belt - Fan		③▲9440HD	Belt - Compr.		TR24461
Hose - Upper		24236	Detroit Diesel 4055D Diesel		
Hose - Lower		24244	Belt - Fan & Compr.	3224451	TR34700
F1204			Tournatractor B		
Detroit Diesel 12V-71 Diesel			Cummins NRT6BI Diesel		
Belt - Fan		③▲9570HD	Belt - Fan	S3115	②TR28492
Hose - Upper		24240	Belt - W.P.	S3163	TR22434
Hose - Lower		24256	Detroit Diesel 6-71 Diesel		
Roadster C			Belt - Fan		
Detroit Diesel 6055C Diesel			Belt - Compr.		
Belt - Fan	DD82781	②TR28596	②TR30672		
Belt - Compr.	DD8278	TR28545	TR28545		
Roadster D			Tournatractor C		
Detroit Diesel 4-71 Diesel			Cummins HBIS Diesel		
Belt - Fan	3224368	TR34545	Belt - Fan	S1792	②TR22405
Belt - Compr.		TR28483	Belt - Compr.	HC2387	TR28545
Super C			Liebherr		
Cummins HBIS Diesel			R911LC		
Belt - Fan & W.P.	S1792	②TR22405	Deutz F4L912 Diesel		
Belt - P.S.	S3130	②TR22485	Belt - Blower & Idler		
Super C Tornadozer			Belt - Gen.		
Buda 6-Cyl. Diesel			Belt - Compr.		
Belt - Fan	HC1712	②TR28628	7508		
Belt - Compr.	HC1146	TR28616	▲9415HD		
Detroit Diesel 6055C Diesel			7425		
Belt - Compr.	HD8004	TR30537	R925		
Tornadozer			Deutz F6L912 Diesel		
Cummins NTO262 Diesel			Belt - Alt.		
Belt - Fan		②TR30506	Belt - Compr.		
Belt - W.P.	178570	TR24400	7480		
Tournapull			7425		
Cummins HBID Diesel			R961LC		
Belt - Fan	70524	②TR22405	Deutz F6L413FW Diesel		
Belt - Compr.	HC2387	TR28545	Belt - Alt.		
Tournapull B			Belt - Compr.		
Cummins NHRBIS600 Diesel; Cummins NRT6BI Diesel			7380		
Belt - Fan	S3115	②TR28492	②▲9400HD		
Belt - W.P.	S3163	TR22434	Link-Belt		
Tournapull C			HC18		
Detroit Diesel 6-71 Diesel			Detroit Diesel 8V-71 Diesel		
Belt - Fan		TR28680	Belt - Fan		③▲9540HD
			Belt - Alt.		②9279
			Hose - Upper		③<21115
			Hose - Lower		②24436
			HC78B		
			Caterpillar D330C Diesel		
			Belt - Fan & Alt.		③▲9530HD
			Belt - Hyd. Pump		②B38
			Hose - Lower - Eng. To Pipe		②24440
			Detroit Diesel 6V-53N Diesel		
			Belt - Fan		②▲9400HD

▲Standard Belt Available.
②Two Required.

③Three Required.
③<Cut to Fit.

Belts and Coolant Hose for Road & Construction Equipment

Application	Mfr. Part No.	Our No.	Application	Mfr. Part No.	Our No.
Link-Belt - Continued			Link-Belt - Continued		
HC78B - Continued			LS108B - Continued		
Detroit Diesel 6V-53N Diesel - Continued			Detroit Diesel 4-71 Diesel - Continued		
Belt - Alt		②7370	Belt - Hyd. Pump		♣9425HD
Hose - Upper		②26501	LS128DLC		
Hose - Lower		26501	Detroit Diesel 6-71N Diesel		
HC108C			Belt - Fan		
Detroit Diesel 4-71 Diesel			③♣9420HD		
Belt - Fan - Upper Structure	5139026	②♣9420HD	LS2700		
Belt - Alt. - Upper Structure	5145150	♣9430HD	Isuzu 4BD1-T Diesel		
Belt - Hyd. Pump		♣9425HD	Belt - Fan & Alt.		
Detroit Diesel 6-71 Diesel			5136710430		
Belt - Fan - Lower Structure		②♣9550HD	TR22448		
Belt - Alt. - Lower Structure		♣9390HD	Hose - By Pass		
HC218			≈20802		
Detroit Diesel 6-71 Diesel			LS2800CII		
Belt - Fan - Upper Structure	5139026	②♣9420HD	Isuzu 6BD1T Diesel		
Belt - Alt. - Upper Structure	5145150	♣9430HD	Belt - Fan & Alt.		
Belt - Hyd. Pump	1J2041	♣9425HD	2TR22485		
Hose - Upper		26511	LS4000		
Hose - Lower		②24432	Caterpillar D330 Diesel		
Detroit Diesel 8V-71 Diesel			Belt - Fan & Alt.		
Belt - Fan - Lower Structure	5133762	③♣9540HD	3S6272		
Belt - Alt. - Lower Structure	5135298	②♣9313HD	③♣9540HD		
HSP8018			Belt - Hyd. Pump		
Detroit Diesel 4-53 Diesel			TR22578		
Belt - W.P. & Alt.		②7417	LS4300CII		
HSP8028S			Isuzu 6SD1T Diesel		
Detroit Diesel V-8 8.2 L Diesel			Belt - Fan & Alt.		
Belt - Hyd. Pump		AX42	②TR22495		
HSP8040			LS5800		
Detroit Diesel 6V-53 Diesel			Detroit Diesel 8V-71 Diesel		
Belt - Fan	5148223	②♣9463HD	Belt - Fan		
Belt - Alt	5133177	7370	③♣9447HD		
HT450			Hose - Upper		
Detroit Diesel 6-71N Diesel			≈21115		
Belt - Fan	5135942	②♣9550HD	24444		
Belt - Gen.	5133517	♣9390HD	Hose - Lower - Eng. To Pipe		
LS78			24444		
Detroit Diesel 3-71N Diesel			Hose - Lower - Pipe To Rad.		
Belt - Fan		②♣9420HD	24444		
Belt - Alt		♣9430HD	LS5800CII		
Belt - Hyd. Pump		♣9405HD	Isuzu 6RB1T Diesel		
LS98			Hose - Upper		
Caterpillar D333 Diesel			26512		
Belt - Fan & Alt.	3S6272	③♣9540HD	LS7400		
Belt - Hyd. Pump		②TR22508	Detroit Diesel 12V-71 Diesel		
Belt - Fan & Idler	3L9717	②TR24489	Belt - Fan		
Belt - Fan To Alt.	4B2544	♣9430HD	5133769		
LS98H			③♣9650HD		
Caterpillar D333 Diesel			YC38		
Belt - Fan & Alt.	3S6217	③♣9540HD	Detroit Diesel 4-53N Diesel		
LS108B			Belt - Fan		
Detroit Diesel 4-71 Diesel			②♣9390HD		
Belt - Fan	5139026	②♣9420HD	Belt - W.P. & Alt.		
Belt - Alt		♣9430HD	7448		
Little Giant			Belt - V.P.		
C48			②7320		
Detroit Diesel 3-71 Diesel			Long		
Belt - Fan		②♣9420HD	5N1		
Belt - Alt		♣9370HD	Leyland 38TD Diesel		
Long			Belt - Fan & Alt.		
5N1			♣K060525HD		
Leyland 38TD Diesel			Hose - Upper		
Belt - Fan & Alt.			25473		
Hose - Upper			Hose - Lower		
Hose - Lower			25480		
Lorain			LC790		
Detroit Diesel 4-71 Diesel			Detroit Diesel 6-71 Diesel		
Belt - Fan	5139026	②♣9420HD	Belt - Fan - Upper Structure		
Belt - Alt		♣9430HD	5136269		
Two Required.			②♣9600HD		
Three Required.					
			♣Standard Belt Available.		
			≈Cut to Fit.		

Road & Construction Equipment

Belts and Coolant Hose for Road & Construction Equipment

Application	Mfr. Part No.	Our No.	Application	Mfr. Part No.	Our No.
Lorain - Continued			Massey Ferguson - Continued		
LC790 - Continued			MF66 - Continued		
Detroit Diesel 6-71 Diesel - Continued			Detroit Diesel 6V-53N Diesel - Continued		
Belt - Alt. - Upper Structure	5140928	▲9400HD	Hose - Lower - Eng. To Pipe		24238
Belt - Hyd. Pump - Upper Structure		7535	MF70		
Detroit Diesel 8V-71 Diesel			Perkins 4-Cyl. 318 Diesel		
Belt - Fan - Lower Structure	5116779	③▲9600HD	Belt - Fan & Alt./Gen.	726015M91	②7530
Belt - Alt. - Lower Structure		K080370	MF77C		
MC30H			Cummins N855 Diesel		
Detroit Diesel 4-71N Diesel			Belt - Fan		③▲9463HD
Belt - Fan - Upper Structure	5128579	②▲9500HD	Belt - W.P. & Alt.		▲9425HD
Belt - Alt. - Upper Structure		▲9415HD	Belt - Air Brake Compr.		②▲9476HD
Detroit Diesel 6-71N Diesel			MF80		
Belt - Fan - Lower Structure		②▲9550HD	Perkins 6-Cyl. 354 Diesel		
Belt - Alt. - Lower Structure		▲9375HD	Belt - Fan & Alt./Gen.	726323M91	②▲9520HD
MC320			MF202		
Ford V-8 391			Continental Z134		
Belt - W.P. & Alt.; W/Drive Eng.	C2TZ 8620 Z	▲9451HD	Belt - Fan & Gen.	181523M1	▲9430HD
Hose - Lower; W/Drive Eng.		≈21379	Hose - Upper		24224
MC540A			Hose - Lower		≈20416
Cummins 6-Cyl. Diesel				or	25473
Belt - Fan - Upper Structure	178530	②TR24365	MF203		
Belt - W.P. - Upper Structure	178658	TR22329	Perkins 3-Cyl. 152 Diesel		
Belt - Alt. - Upper Structure	178470	TR22474	Belt - Fan & Gen.	186976M1	▲9490HD
Massey Ferguson			Hose - Upper		24224
777			Hose - By Pass		24218
Cummins N855 Diesel			MF204		
Hose - Upper - Eng. To Pipe		24428	Continental Z134		
Hose - Upper - Pipe To Rad.		23520	Belt - Fan & Gen.	181523M1	▲9430HD
Hose - Lower - Eng. To Pipe		24438	Hose - Upper		24224
Hose - Lower - Pipe To Rad.		24434	Hose - Lower		≈20416
MF11				or	25473
Perkins 4-Cyl. 248 Diesel			MF205		
Belt - Fan & Alt.; Ser. No. J1399 & Before ..	1446201M1	▲9505HD	Perkins 3-Cyl. 152 Diesel		
Belt - Fan & Alt.; Ser. No. J1400 & After	2614087RF	②7512	Belt - Fan & Gen.	186976M1	▲9490HD
Hose - Lower		25476	Hose - Upper		24224
Hose - By Pass		25249	Hose - By Pass		24218
MF20C; MF30B			MF220		
Perkins 3-Cyl. 152 Diesel			Perkins 4-Cyl. 248		
Belt - Fan & Alt.	531371M1	▲9525HD	1972 - 1970		
MF44B			Belt - Fan & Alt.; Ser. No. 248UA6333 &		
Perkins 6-Cyl. 354 Diesel			Before		
Belt - Fan & Alt.		②▲9590HD		186976M1	▲9490HD
Hose - Upper		≈20611	Belt - Fan & Alt.; Ser. No. 248UA6334 &		
		or	After	1840685M91	②7500
		26509	MF300 Backhoe		
Hose - Lower		26511	Perkins 4-Cyl. 248 Diesel		
Hose - By Pass		≈20685	Belt - Fan & Alt.; Ser. No. 248UA14402L & Before		▲9470HD
MF50A			Belt - Fan & Alt.; Ser. No. 248UA17092		
Perkins 4-Cyl. 203 Diesel			Thru 248UA88561		
Belt - Fan & Alt.	843198M1	▲9525HD		1446046M1	②7470
MF66			Belt - Fan & Alt.; Ser. No. 248UA88561 & After		
Detroit Diesel 6V-53N Diesel			Hose - Upper		
Belt - Fan		③▲9490HD	26504		
Belt - W.P. & Air Brake Compr.		②▲9490HD	Hose - Lower		
Belt - Alt.		▲9380HD	≈20957		
Hose - Upper - Eng. To Pipe		24238	or		
Hose - Upper - Pipe To Rad.		24238	26603		
MF320			MF320		
Perkins 6-Cyl. 354 Diesel			Perkins 6-Cyl. 354 Diesel		
1977 - 1976			1977 - 1976		
Belt - Fan & Alt.		②7530	Belt - Fan & Alt.	726015M91	②7530

▲Standard Belt Available.
②Two Required.

③Three Required.
≈Cut to Fit.

Belts and Coolant Hose for Road & Construction Equipment

Application	Mfr. Part No.	Our No.	Application	Mfr. Part No.	Our No.
Massey Ferguson - Continued			Multiquip		
MF450; MF450S			DPS-90SS		
Perkins 6-Cyl. 354 Diesel			Isuzu 3-Cyl. Diesel		
Belt - Fan & Alt.	2614668	②▲9605HD	Belt - Fan & Gen.		7355
Hose - Upper		≧20206	DPS-180SST		
Hose - Lower - Eng. To Pipe		24434	Isuzu C240 Diesel		
Hose - Lower - Pipe To Rad.		24434	Belt - Fan & Alt.	5136710400	▲9400HD
MF470			Mustang		
Perkins 4-Cyl. 193			545		
Belt - Fan & Gen.		②7490	Perkins 4-Cyl. 154 Diesel		
Perkins 4-Cyl. 193 Diesel			1985 - 1982		
Belt - Fan & Gen.	1030166M1	▲9480HD	Belt - Fan & Alt.		▲9510HD
MF811			Hose - Upper		
Perkins 4-Cyl. 108 Diesel			26501		
1976 - 1974			New Holland		
Belt - Fan & Alt.		7405	C175		
Hose - Upper		≧21794	New Holland N844 Diesel		
		or	2007		
Hose - Lower		25476	Belt - Fan & Alt.		▲9370HD
		25476	L35		
MDI/Yutani			Wisconsin VG4D		
MD140			1984 - 1971		
Mitsubishi 4D31T Diesel			Belt - Alt.	72440	6719
Belt - Fan & Alt.; W/46 5/8" Belt O.C.		TR22461	L175		
Belt - Fan & Alt.; W/48" Belt O.C.		TR22474	New Holland NH844LT Diesel		
Hose - Upper		26511	2007		
Hose - Lower		26512	Belt - Fan & Alt.		▲9370HD
MD200			L185		
Mitsubishi 6D31T Diesel			New Holland 344TM2 Diesel		
Belt - Fan & Alt.		②▲9476HD	2007		
Hose - Upper		26511	Belt - Fan & Alt.	J925953	▲K080590HD
Hose - Lower		26512	L225		
MD240			Wisconsin TJD		
Mitsubishi 6D15T Diesel			1977 - 1975		
Belt - Fan & Alt.		TR22425	Belt - Alt.		7360
Hose - Upper		26511	L553		
Hose - Lower		26512	Kubota V1902 Diesel		
MD320			1996 - 1985		
Mitsubishi 6D22T Diesel			Belt - Fan & Alt.	783511	7435
Belt - Fan & W.P.		②TR28570	L555		
Belt - Alt.		TR20426	Kubota V1902 Diesel		
M-R-S			1995 - 1981		
I105S; I110S			Belt - Fan & Alt.; W/46 7/8" Belt O.C.		
Detroit Diesel 12V-71 Diesel				9807449	▲9465HD
Belt - Fan		③▲9740HD	Belt - Fan & Alt.; W/45 5/8" Belt O.C.	9612805	7450
Hose - Upper		②24940	Hose - Upper		≧20065
Hose - Lower		24956	Hose - Lower		≧20065
Multihoe					or
MDA			Hose - By Pass		25251
Detroit Diesel 3-53 Diesel					28439
Belt - Fan		②▲9350HD	L565		
Belt - W.P.		②7360	New Holland N844 Diesel		
Belt - Alt.		7312	1999 - 1989		
Hose - Upper		25472	Belt - Fan & Alt.		▲9355HD
Hose - Lower - Eng. To Water Manifold		24228	L775		
Hose - Lower - Water Manifold To Rad.		26507	Deutz F3L912 Diesel		
			1984 - 1977		
			Belt - Blower & Alt.	259347	7417

≧Cut to Fit.
▲Standard Belt Available.

②Two Required.
③Three Required.

Belts and Coolant Hose for Road & Construction Equipment

Application	Mfr. Part No.	Our No.	Application	Mfr. Part No.	Our No.
New Holland - Continued			Owatonna - Continued		
L781			1200		
Deutz F3L912 Diesel			Wisconsin VH4D		
1995 - 1984			1980 - 1978		
Belt - Blower	2235775	7512	Belt - Alt.		▲9319HD
Belt - Alt.		7430	1700		
L785			Ford V-4 104 Diesel		
Perkins 4-Cyl. 203 Diesel			1980 - 1978		
1994 - 1983			Belt - Fan & Alt.		
Belt - Fan & Alt.	632880	▲9451HD			7430
Hose - Upper		26501	Belt - Fan, Alt. & W.P.		7410
LB90			Belt - Fan & Gov.		
New Holland BSD 450T			Hose - Upper		
Belt - Serpentine	85826230	▲K080570HD	Hose - Lower		26602
LS190			P & H		
New Holland 4-Cyl. 304 Diesel			20-20		
2004 - 2000			Detroit Diesel 4-53 Diesel		
Tensioner Assy.	87801689	38672	Belt - Fan		
LX665			Belt - W.P. & Alt.		
New Holland N844 Diesel			Hose - Upper		
1999 - 1993			26501		
Belt - Fan & Alt.	AX365	▲9375HD	150; 150TC		
LX985			Buda 6DT278 Diesel; Buda 6DT317 Diesel		
Genesis 4-Cyl. 304 Diesel			Belt - Fan		
1999 - 1998			22128		
Belt - Fan & Alt.		▲9470HD	TR28501		
Tensioner Assy.	87801689	38672	215		
T330			Chrysler 6-Cyl. 225		
Wisconsin TJD			Belt - Fan & Gen. - Upper Structure		
Belt - Alt.	235084	7280	TR24489		
T550			Belt - Gov. - Upper Structure		
Wisconsin VG4D			1070295		
Belt - Alt.	72440	6819	Hose - Upper - Upper Structure		
Belt - Hyd. Pump	234653	7360	24236		
Owatonna			Hose - Lower - Rad. To Pipe (Upper Structure)		
445			24224		
Ford 4-Cyl. 98			Hose - Lower - Pipe To W.P. (Upper Structure)		
1987 - 1979			24224		
Belt - Fan & Alt.	02032167	3VX315	IH RD450 Diesel		
Belt - Gov.		7380	Belt - Fan & Alt. - Lower Structure		
Perkins 4-Cyl. 108 Diesel			97820R2		
1987 - 1979			TR22517		
Belt - Fan & Alt.	2612019	7410	Belt - Fan To P.S. - Lower Structure		
545			TR22336		
Perkins 4-Cyl. 154 Diesel			Hose - Upper - Lower Structure		
1987 - 1982			26515		
Belt - Fan & Alt.		▲9510HD	Hose - Lower - Lower Structure		
Hose - Upper		26501	26510		
880			255A; 255ATC		
Ford 4-Cyl. 256 Diesel			Buda 6DT468 Diesel		
1987 - 1982			Belt - Fan		
Belt - Fan & Alt.		▲9550HD	7Z1D2		
Hose - Upper		26504	TR28522		
Hose - Lower		24924	Belt - Gen.		
			TR28423		
			455A		
			Chrysler Ind. 12-69		
			Belt - Fan		
			928408		
			②TR24476		
			655A; 655B		
			Caterpillar D13000 Diesel		
			Belt - Belt; W/Leece Neville Alt.		
			CX68		
			855		
			Caterpillar D17000 Diesel		
			Belt - Starter		
			TR28628		
			955A		
			Waukesha 6WAKD Diesel		
			Belt - Gen.		
			②TR22350		
			1055		
			Caterpillar D343 Diesel		
			Belt - Fan		
			②TR24500		
			Belt - Gen.		
			TR28583		

▲Standard Belt Available.
③Three Required.

②Two Required.

Belts and Coolant Hose for Road & Construction Equipment

Application	Mfr. Part No.	Our No.	Application	Mfr. Part No.	Our No.
P & H - Continued			Parsons - Continued		
9125TC			T750		
Cummins V903 Diesel			John Deere 4039D Diesel		
Belt - Fan & W.P. - Upper Structure	178543	③▲9680HD	Belt - Fan & Alt.	T24473	TR24465
Belt - Alt. - Upper Structure; Front Mount		②7555	UH119		
Belt - Alt. - Upper Structure; Rear Mount	178472	②▲9390HD	Detroit Diesel 3-53 Diesel		
Belt - Hyd. Pump - Upper Structure		7555	Belt - Fan	5135884	②▲9440HD
Hose - Upper - Pipe To Rad. (Upper Structure)		≧21194	Belt - W.P., Alt. & Hyd. Pump		②7420
Hose - Upper - Eng. To Pipe (Upper Structure)		24436	Hose - Upper		≧20957
9254				or	26501
Cummins NTF365 Diesel			Hose - Lower		26507
Belt - Fan - Lower Structure		②TR28429	Pettibone		
Belt - Alt. - Lower Structure		②▲9470HD	29		
Belt - W.P. & Idler - Lower Structure	215356	②6596	Detroit Diesel 4-53 Diesel		
Belt - Hyd. Pump - Lower Structure		②TR22495	Belt - Fan		②▲9455HD
Hose - Upper - Eng. To Pipe (Lower Structure)		26521	Belt - W.P. & Alt.		②7405
Hose - Lower - Eng. To Pipe (Lower Structure)		24440	Belt - V.P.		7280
H312			36		
Detroit Diesel 4-53N Diesel			Detroit Diesel 6V-53 Diesel		
Belt - Fan	5131395	②▲9412HD	Belt - Fan		②▲9400HD
Belt - W.P. & Gen.	5133174	7405	Belt - Alt.		②▲9375HD
Hose - Upper		20065	Belt - W.P.		②▲9375HD
	or	25473	40		
H418			Detroit Diesel 6V-53 Diesel		
Detroit Diesel 6V-53N Diesel			Belt - Fan		②▲9400HD
Belt - Fan	5126763	②▲9400HD	Belt - Alt.		②▲9375HD
Belt - Alt.		7375	Belt - W.P.		②▲9375HD
Belt - W.P. & Idler	5139228	②7370	Hose - Upper - Left Side		26502
Hose - Upper		26611	Hose - Upper - Right Side		26502
Hose - Lower		26522	Hose - Lower		26523
K935			402; 402C; 403; 404; 502; 502C		
Detroit Diesel 6-71 Diesel			Detroit Diesel 3082 Diesel; Detroit Diesel 4082 Diesel		
Belt - Fan	512676	③▲9470HD	Belt - Fan	5170972	②TR22455
Belt - Alt.		TR22405	Belt - Gen.	3224367	TR28390
WN300			C200		
Continental F186			Detroit Diesel 3-53 Diesel		
Belt - Fan		TR28483	Belt - Fan	5131395	②▲9412HD
Parsons			Belt - W.P. & Gen.		7430
75			Belt - Hyd. Pump		▲9341HD
Ford 4-Cyl.			Hose - Upper		≧21794
Belt - Fan & Alt.		▲9463HD		or	25474
Belt - Fan & Idler		▲9430HD	Hose - Lower - Eng. To Pipe		24432
Hose - Upper		25473	Hose - Lower - Pipe To Rad.		24432
Hose - Lower		26612	SB68		
166-15			John Deere 4276D Diesel		
Perkins 4-Cyl. 236 Diesel			Belt - Fan & Alt.	T24473	TR22514
Belt - Fan & Alt.		▲9330HD	Belt - Hyd. Pump		▲9380HD
Hose - Upper		≧20957	Hose - Upper		26502
	or	26501	Hose - Lower - Eng. To Pipe		24232
Hose - Lower		25480	Hose - Lower - Pipe To Rad.		24932
255L			SM710		
Detroit Diesel 4-53 Diesel			Detroit Diesel 4-53 Diesel		
Belt - Fan	5131395	②▲9412HD	Hose - Upper		26504
Belt - W.P. & Gen.	5133174	②7405	Hose - Lower		26510
Belt - Hyd. Pump		7312			
Hose - Upper		≧20065			
	or	25473			
Hose - Lower - Eng. To Pipe		24232			
Hose - Lower - Pipe To Rad.		24232			

②Two Required.
≧Cut to Fit.

▲Standard Belt Available.
③Three Required.

Road & Construction Equipment

Belts and Coolant Hose for Road & Construction Equipment

Application	Mfr. Part No.	Our No.	Application	Mfr. Part No.	Our No.
Poclair			Poclair - Continued		
160; 200			HC		
Deutz F11L413 Diesel			Detroit Diesel 8V-71 Diesel; Deutz F12L413 Diesel		
Belt - Alt.		②7380	Belt - Fan - Rear Eng.; W/Hyd. Cooler	U0138708	♣9650HD
220			Belt - Fan; W/Optional 4th Hyd. Cooler	U0138708	♣9650HD
Deutz F6L912 Diesel			Belt - A.C.	N0138725	②♣9580HD
Belt - Alt.		7385	HC300		
FC			Detroit Diesel 8V-71 Diesel		
Deutz F3L912 Diesel			Belt - Fan		③♣9560HD
Belt - Fan & Gen.	P0138728	7580	Belt - Alt.	5109794	♣9375HD
Belt - Hyd. Pump; GV30	M0038743	②TR28628	LC; LY		
Deutz F4L812 Diesel			Agrom		
Belt - Fan		♣9530HD	Belt - Fan & Gen.	M0138701	③♣9620HD
Belt - Fan & Gen.	H0038739	♣9610HD	Deutz F6L812 Diesel		
Belt - Gen.	Z0038731	♣9451HD	Belt - Fan; W/Hyd. Cooler	E0038713	♣9470HD
Belt - Hyd. Pump; GV30	M0038743	②TR28628	Belt - Fan; W/O Hyd. Cooler	N0138702	♣9540HD
FY			Belt - Gen.; Ser. No. 4746212 & Before	J0138721	7430
Deutz F3L912 Diesel			Belt - Gen.; Ser. No. 4746213 & After	N0138748	7450
Belt - Fan & Gen.	P0138726	7580	Belt - Hyd. Pump; TGV 115	P0038745	⑤TR28706
Belt - Fan; 1st Mounting; W/Almnm. Rad. ...	U0038727	TR22485	M		
Belt - Air Brake Compr.; 2nd Mounting	W0038729	TR22508	Deutz F6L514 Diesel		
Belt - Hyd. Pump - Front	N0038744	②TR28680	Belt - Fan; W/51 5/8" Belt O.C.	P0138749	7516
Belt - Hyd. Pump - Rear	M0038743	②TR28628	Belt - Fan; W/55 1/8" Belt O.C.	V0138755	7550
Deutz F4L812 Diesel			Belt - Oil Pump	B0138760	♣9530HD
Belt - Fan; 1st Mounting	S0038725	♣9520HD	RC		
Belt - Fan; 2nd Mounting		♣9530HD	Deutz F6L413FW Diesel		
Belt - Fan & Gen.	H0038739	♣9610HD	Belt - Hyd. Pump	C0138761	④TR22792
Belt - Gen.	Z0038731	♣9451HD	RC200		
Belt - A.C.; 1st Mounting	U0038727	TR22485	Deutz F6L413FW Diesel		
Belt - A.C.; 2nd Mounting	W0038729	TR22508	Belt - Alt.		7390
Belt - Hyd. Pump - Front	N0038744	②TR28680	SC		
Belt - Hyd. Pump - Rear	M0038743	②TR28628	Deutz F6L413FW Diesel		
GC			Belt - Fan; W/55 1/8" Belt O.C.	V0138755	7550
Deutz F6L514 Diesel			Belt - Fan; W/59 1/8" Belt O.C.	W0138756	7590
Belt - Fan; W/Hyd. Cooler; Ser. No. 485 & After; W/56 1/4" Belt O.C.	G0038715	TR22578	Belt - Oil Pump	A0138759	7490
Belt - Fan; W/Hyd. Cooler; Ser. No. 500 & After; W/79" Belt O.C.	W0038706	④BX77	TC		
Belt - Blower; Ser. No. 4.524.029 & Before .	F0038737	③TR22648	Agrom		
Belt - Blower; Ser. No. 4.524.030 & After	S0138706	②7660	Belt - Fan & Gen.; W/57 1/4" Belt O.C.	K0038718	②♣9570HD
Belt - Gen.	G0038738	♣9360HD	Belt - Fan & Gen.; W/58 1/4" Belt O.C.	R0138705	②♣9580HD
GC120			Deutz F4L712 Diesel		
Deutz F6L514 Diesel			Belt - Fan	S0038725	♣9520HD
Belt - Blower		②7640	Belt - Gen.		♣9425HD
Belt - Alt.		♣9380HD	Deutz F4L812 Diesel		
GY			Belt - Fan	T0038726	♣9530HD
Deutz F6L514 Diesel			Belt - Gen.	Z0038731	♣9451HD
Belt - Fan; W/Hyd. Cooler; Ser. No. 485 & After; W/56 1/4" Belt O.C.	G0038715	TR22578	Deutz F4L912 Diesel		
Belt - Fan; W/Hyd. Cooler; Ser. No. 500 & After; W/79" Belt O.C.	W0038706	④BX77	Belt - Fan	M0138724	7500
Belt - Blower; Ser. No. 4.524.029 & Before .	F0038737	③TR22648	Belt - Gen.	L0138723	7417
Belt - Blower; Ser. No. 4.524.030 & After	S0138706	②7660	TCB		
Belt - Gen.	G0038738	♣9360HD	Deutz F3L912 Diesel		
Belt - Air Brake Compr.; W/51 1/4" Belt O.C.	W0038729	TR22508	Belt - Gen.	P0138726	7580
Belt - Air Brake Compr.; W/54 3/4" Belt O.C.	P0138703	TR22553	Belt - Hyd. Pump; W/H.POC 23X23 2X23P Hyd. Pump	K0138722	③TR28706
GC			TCS		
Deutz F6L514 Diesel			Agrom		
Belt - Fan & Gen.; W/57 1/4" Belt O.C.			Belt - Fan & Gen.; W/57 1/4" Belt O.C.	K0038718	②♣9570HD

②Two Required.
④Four Required.
⑤Five Required.

♣Standard Belt Available.
③Three Required.

Belts and Coolant Hose for Road & Construction Equipment

Application	Mfr. Part No.	Our No.	Application	Mfr. Part No.	Our No.
Poclair - Continued			Poclair - Continued		
TCS - Continued			TYS		
Agrom - Continued			Agrom		
Belt - Fan & Gen.; W/58 1/4" Belt O.C.	R0138705	②▲9580HD	Belt - Fan & Gen.; W/57 1/4" Belt O.C.	K0038718	②▲9570HD
Deutz F4L712 Diesel			Belt - Fan & Gen.; W/58 1/4" Belt O.C.	R0138705	②▲9580HD
Belt - Fan	S0038725	▲9520HD	Belt - Air Brake Compr.	H0038716	TR22425
Belt - Gen.		▲9425HD	Belt - Hyd. Pump; W/H.POC 18X18 2X3P Hyd. Pump	K0138722	②TR28706
Deutz F4L812 Diesel			Belt - Hyd. Pump; W/H.POC 32 1X3P Hyd. Pump	R0138728	③TR28786
Belt - Fan	T0038726	▲9530HD	Deutz F4L912 Diesel		
Belt - Gen.	Z0038731	▲9451HD	Belt - Fan	M0138724	7500
Deutz F4L912 Diesel			Belt - Gen.	L0138723	7417
Belt - Fan	M0138724	7500	Belt - Air Brake Compr.	H0038716	TR22425
Belt - Gen.	L0138723	7417	Belt - Hyd. Pump; W/H.POC 18X18 2X3P Hyd. Pump	K0138722	③TR28706
TCS-M1			Belt - Hyd. Pump; W/32 1XP Hyd. Pump	R0138728	③TR28786
Deutz F4L912 Diesel			Pumpmaster		
Belt - Fan	M0138724	7500	4000		
Belt - Gen.	L0138723	7417	Detroit Diesel 2-53 Diesel		
Belt - Hyd. Pump; GV15, GV30	L0038742	②TR28706	Belt - Fan	5119188	▲9390HD
TCS-M2			Belt - Gen. & W.P.	5133172	②6596
Deutz F4L912 Diesel			Hose - Upper		24228
Belt - Fan	M0138724	7500	Hose - Lower - Eng. To Pipe		24232
Belt - Gen.	L0138723	7417	Hose - Lower - Pipe To Rad.		24232
Belt - Hyd. Pump; W/H.POC 32 1X32 Hyd. Pump	R0138728	③TR28786	Ford 4-Cyl. 172 Diesel		
Belt - Hyd. Pump; W/H.POC 18X18 2X3P Hyd. Pump	K0138722	③TR28706	Belt - Fan & Gen.		▲9420HD
TX			Hose - Upper		24220
Deutz F3L912 Diesel			Hose - Lower - Eng. To Pipe		24228
Belt - Gen.	P0138726	7580	Hose - Lower - Pipe To Rad.		≈<20957
Belt - Air Brake Compr.	J0038717	TR22461	Raygo		
Belt - Hyd. Pump; W/H.POC 23 1X3P Hyd. Pump	L0038742	②TR28706	2-36 Romper		
TY			Deutz F2L410 Diesel		
Agrom			Belt - Blower		②7355
Belt - Fan & Gen.; W/57 1/4" Belt O.C.	K0038718	②▲9570HD	2-66 Ranger		
Belt - Fan & Gen.; W/58 1/4" Belt O.C.	R0138705	②▲9580HD	Detroit Diesel 4-53 Diesel		
Deutz F4L712 Diesel			Belt - Fan		②▲9415HD
Belt - Fan	S0038725	▲9520HD	Belt - Alt. & W.P.		②7425
Belt - Gen.		▲9425HD	Belt - Hyd. Pump		7330
Deutz F4L812 Diesel			Hose - Upper		≈<21794
Belt - Fan	T0038726	▲9530HD		or	25476
Belt - Gen.	Z0038731	▲9451HD	Hose - Lower - Eng. To Pipe		24232
Deutz F4L912 Diesel			Hose - Lower - Pipe To Rad.		24232
Belt - Fan	M0138724	7500	300A; 320A		
Belt - Gen.	L0138723	7417	John Deere 4219D Diesel		
TY45			Belt - Fan & Alt.		TR22517
Agrom			Belt - Hyd. Pump		▲9395HD
Belt - Air Brake Compr.; W/42 7/8" Belt O.C.	H0038716	TR22425	GATOR		
Belt - Air Brake Compr.; W/46 5/8" Belt O.C.	J0038717	TR22461	Detroit Diesel 8V-71 Diesel		
Belt - Hyd. Pump	K0038741	②TR28786	Belt - Fan		③▲9630HD
Deutz F4L912 Diesel			Belt - Gen.		▲9380HD
Belt - Air Brake Compr.	J0038717	TR22461	Hose - Upper - Eng. To Pipe		②24236
Belt - Hyd. Pump	K0038741	②TR28786	Hose - Upper - Rad. To Pipe		②24236
Ford			Hose - Lower - Eng. To Pipe		24244
Belt - Air Brake Compr.	C0038734	TR22416	Hose - Lower - Rad. To Pipe		24244
Belt - Hyd. Pump		②TR28786	Ram 30		
			Cummins V504 Diesel		
			Belt - Fan & W.P.	178628	②TR22448
			Belt - Alt.	554876	②7450
			Hose - Upper - Eng. To Pipe		24232

▲Standard Belt Available.
③Three Required.

②Two Required.
≈<Cut to Fit.

Belts and Coolant Hose for Road & Construction Equipment

Road & Construction Equipment

Application	Mfr. Part No.	Our No.	Application	Mfr. Part No.	Our No.
Raygo - Continued			Raygo - Continued		
Ram 30 - Continued			Rustler 404B - Continued		
Cummins V504 Diesel - Continued			Detroit Diesel 3-53 Diesel - Continued		
Hose - Upper - Pipe To Rad		24232	Belt - Gen. & W.P.		7410
Hose - Lower		26509	Belt - Hyd. Pump		7320
Rascal 220B			Hose - Upper		②<21794
John Deere 4219D Diesel				or	25474
Hose - Upper		25528	Hose - Lower		26507
Hose - Lower		26501	Rex		
Rascal 300A			HM250		
Ford 4-Cyl. 256 Diesel			Detroit Diesel 8V-71 Diesel		
Belt - Fan & Alt.		♣9560HD	Belt - Fan	5133770	③♣9660HD
Belt - Hyd. Pump		♣9412HD	Belt - Alt.		♣9380HD
John Deere 4219D Diesel			Belt - Hyd. Pump		TR22416
Belt - Fan & Alt.		TR22517	Hose - Upper		②26525
Belt - Hyd. Pump		♣9395HD	Hose - Lower		26536
Rascal 320A			Pactor		
Ford 4-Cyl. 256 Diesel			Detroit Diesel 8V-71 Diesel		
Belt - Fan & Alt.		♣9560HD	Belt - Fan		③♣9570HD
Belt - Hyd. Pump		♣9412HD	SP600; SP700		
Rascal 400A			John Deere 4219D Diesel		
Detroit Diesel 3-53 Diesel			Belt - Fan & Alt.	120334T	TR22474
Belt - Fan		②♣9412HD	Belt - Hyd. Pump		②7400
Belt - Gen. & W.P.	5133174	7405	Hose - Upper		24224
Belt - Hyd. Pump		7320	Hose - Lower; Strt. Hose		24228
Hose - Upper		②<20957	Hose - Lower; Molded Hose		②<20685
Rascal 420B				or	25474
Detroit Diesel 4-53 Diesel			Samsung		
Belt - Fan	5131395	②♣9412HD	SL150-2		
Belt - Alt. & W.P.	5133173	7420	Cummins 6-Cyl. 5.9 L Diesel		
Hose - Upper		②<21794	Belt - Fan & Alt.	3911577	♣K080653HD
	or	25476	Belt - A.C.		A42
Hose - Lower		②24432	SL180-2		
Rascal 600A			Cummins 6-Cyl. 8.3 L Diesel		
Detroit Diesel 4-53 Diesel			Belt - Fan & Alt.	3911620	♣K080680HD
Belt - Fan		②♣9405HD	Belt - W.P.	3034349	♣K080525HD
Belt - Gen. & W.P.		②7400	Belt - A.C.		A42
Hose - Upper		②<21794	Smith Co.		
	or	25474	125		
Hose - Lower		②<20685	Hercules RCX21		
Razor 350; Roadster 120			Belt - Gov.		TR22517
Deutz F2L511 Diesel			Hose - Upper - Eng. To Pipe		26509
Belt - Blower		②7355	Hose - Upper - Pipe To Rad.		26509
Rustler 304A			Hose - Lower - Eng. To W.P.		24228
Ford 4-Cyl. 256 Diesel			Hose - Lower - W.P. To Pipe		24228
Belt - Fan & Alt.		♣9560HD	Hose - Lower - Pipe To Rad.		②<20357
Belt - Hyd. Pump		♣9412HD	300		
Hose - Upper		25478	John Deere 4239D Diesel		
Hose - Lower		24928	Belt - Fan & Alt.	T24473	TR22514
John Deere 4219D Diesel			Hose - Upper		25477
Belt - Fan & Alt.		TR22517	Hose - Lower		26504
Belt - Hyd. Pump		♣9395HD	Sullair		
Hose - Upper		25473	85		
Hose - Lower		26501	Volkswagen 4-Cyl.		
Rustler 404B			Belt - Gen.		7355
Detroit Diesel 3-53 Diesel					
Belt - Fan		②♣9412HD			

♣Standard Belt Available.
②Cut to Fit.

②Two Required.
③Three Required.

Belts and Coolant Hose for Road & Construction Equipment

Application	Mfr. Part No.	Our No.	Application	Mfr. Part No.	Our No.
Sullair - Continued			Tampo - Continued		
150			RS16A - Continued		
Ford 4-Cyl. 172			Detroit Diesel 3-53 Diesel - Continued		
Belt - Fan & Gen.		▲9420HD	Hose - Lower - Eng. To Pipe		24232
Hose - Upper		25250	Hose - Lower - Pipe To Rad.		24232
Hose - Lower		25484	RS28		
Ford 4-Cyl. 172 Diesel			Detroit Diesel 4-53 Diesel		
Belt - Fan & Gen.		▲9420HD	Belt - Fan	②▲9440HD	
Hose - Upper		25251	Belt - Gen. & W.P.	5133174	7405
185			Hose - Upper		20065
John Deere 4219D Diesel				or	③<20433
Belt - Fan & Alt.	T20334T	TR22474		or	25473
Hose - Upper		25474	Hose - Lower - Eng. To Pipe		24232
900			Hose - Lower - Pipe To Rad.		24232
Detroit Diesel 12V-71 Diesel			Tamrock		
Belt - Fan	5115053	③▲9680HD	Ranger 500		
RC8			Caterpillar Diesel		
Caterpillar 3304 Diesel			Belt - Fan & Alt.	2S5218	▲9585HD
Belt - Fan & Alt.		③▲9570HD	TA341		
Takeuchi			Kubota K4E		
TB025			Belt - Fan		7360
Yanmar 3TN84L Diesel			TCI		
Hose - Upper		③<20137	747		
	or	25250	Isuzu QD60 Diesel		
TB68S			Belt - Fan & Alt.	5136710400	②▲9400HD
Nissan SD33 Diesel			Belt - Hyd. Pump		②▲9330HD
Belt - Fan & Alt.		②▲9440HD	Hose - Upper		25806
Hose - Upper		25474	Terex		
TB650S			35		
Yanmar 3T72LTBS Diesel			Detroit Diesel 16V-71 Diesel		
Belt - Fan & Alt.		▲9325HD	Belt - Fan	5133761	③▲9530HD
TB800			Belt - Alt.	5133735	③7405
Yanmar 3T72LTB Diesel			35E		
Belt - Fan & Gen.		▲9345HD	Detroit Diesel 12V-71 Diesel		
TL26			Belt - Fan		③▲9480HD
Isuzu 4JB1 Diesel			72-20		
1998 - 1992			Detroit Diesel 4-71 Diesel		
Belt - Fan & Alt.	8942568000	TR24407	Belt - Fan & Alt./Gen.	5127669	②▲9530HD
Hose - Upper		25300	72-21		
Tampo			Detroit Diesel 3-71N Diesel		
RP16D			Belt - Fan & Alt.; W/62 1/4" Belt O.C.	5138055	②▲9620HD
Detroit Diesel 3-53 Diesel			Belt - Fan & Alt.; W/63 1/4" Belt O.C.	5135883	②▲9630HD
Belt - Fan	5131395	②▲9412HD	Hose - Upper		24932
Belt - W.P. & Alt.	5133601	7410	Hose - Lower		24432
Belt - Hyd. Pump		7300	72-31		
Hose - Upper		③<20046	Detroit Diesel 4-71N Diesel		
	or	26501	Belt - Fan & Alt.; W/59 1/4" Belt O.C.		③▲9590HD
Hose - Lower		24232	Belt - Fan & Alt.; W/62 1/4" Belt O.C.	5138055	②▲9620HD
RS16A			Hose - Upper		24932
Detroit Diesel 3-53 Diesel			Hose - Lower		24432
Belt - Fan	5131395	②▲9412HD	72-31B		
Belt - W.P. & Alt.	5133601	7410	Detroit Diesel 4-71T Diesel		
Belt - Hyd. Pump		7300	Belt - Fan & Alt.		▲9690HD
Hose - Upper		③<21794	Hose - Upper		24932
	or	25474	Hose - Lower		24432

▲Standard Belt Available.
③<Cut to Fit.

③Three Required.
②Two Required.

Belts and Coolant Hose for Road & Construction Equipment

Road & Construction Equipment

Application	Mfr. Part No.	Our No.	Application	Mfr. Part No.	Our No.
Terex - Continued			Terex - Continued		
72-40			3305 - Continued		
Detroit Diesel 6V-53N Diesel			Detroit Diesel 8V-71 Diesel - Continued		
Belt - Fan & Air Brake Compr.		②▲9540HD	Belt - A.C.		7420
Belt - W.P.	5116451	②7370	Hose - Upper - Eng. To Pipe		24436
Belt - Gen.	5124708	▲9360HD	Hose - Upper - Pipe To Rad.		24436
72-41			Hose - Lower - Eng. To Pipe		24444
Detroit Diesel 4-71N Diesel			Hose - Lower - Pipe To Rad.		24444
Belt - Fan & Alt.; W/60 1/4" Belt O.C.	9249167	②▲9600HD	Detroit Diesel 8V-71T Diesel		
Belt - Fan & Alt.; W/61 1/4" Belt O.C.	5136268	②▲9610HD	Belt - Fan	5133765	③▲9570HD
Hose - Upper		24932	Belt - Alt.		②7440
Hose - Lower		24432	Hose - Upper - Eng. To Pipe		24436
72-51			Hose - Upper - Pipe To Rad.		24436
Detroit Diesel 6-71N Diesel			Hose - Lower - Eng. To Pipe		24444
Belt - Fan & Alt./Gen.	5127669	②▲9530HD	Hose - Lower - Pipe To Rad.		24444
Belt - Fan & Alt.; W/58 3/4" Belt O.C.	9249166	②▲9585HD	3307		
Belt - Fan & Alt.; W/60 1/4" Belt O.C.	5136269	②▲9600HD	Detroit Diesel 12V-71 Diesel		
Hose - Upper		24932	Belt - Fan	5140787	③▲9580HD
Hose - Lower		24432	Belt - Alt.		②7445
72-51B			Hose - Upper - Eng. To Pipe		24440
Detroit Diesel 6V-71T Diesel			Hose - Upper - Pipe To Rad.		24440
Belt - Fan		③▲9650HD	Hose - Lower - Eng. To Pipe		24456
Belt - Alt.	5133172	②7430	Hose - Lower - Pipe To Rad.		24456
Hose - Upper - Eng. To Pipe		24936	3309		
Hose - Upper - Pipe To Rad.		24936	Detroit Diesel 16V-71 Diesel		
Hose - Lower - Eng. To Pipe		24444	Belt - Fan	5133761	③▲9530HD
Hose - Lower - Pipe To Rad.		24444	Belt - Alt.	5133735	③7405
72-61			Hose - Lower - Eng. To Pipe		24464
Detroit Diesel 8V-71T Diesel			Hose - Lower - Pipe To Rad.		24464
Belt - Fan		②▲9580HD	3315		
Belt - Alt.		②7445	Detroit Diesel 16V-149 Diesel		
Hose - Upper - Eng. To Pipe		24236	Belt - Alt.	5138935	K080370
Hose - Upper - Pipe To Rad.		24236	4066		
Hose - Lower - Eng. To Pipe		24244	Deutz B10L513 Diesel		
Hose - Lower - Pipe To Rad.		24244	Belt - Alt.		②7395
72-71			Belt - A.C.		▲9451HD
Detroit Diesel 8V-71T Diesel			S7		
Belt - Fan	5133769	③▲9650HD	Detroit Diesel 4-71 Diesel		
Belt - Alt.	5137635	②7440	Belt - Fan	5170972	②TR22455
Hose - Upper - Eng. To Pipe		24236	Belt - Gen.	3224367	TR28390
Hose - Upper - Pipe To Rad.		24236	S11E		
Hose - Lower - Eng. To Pipe		24244	Detroit Diesel 4-71N Diesel		
Hose - Lower - Pipe To Rad.		24244	Belt - Fan & Air Brake Compr.		②▲9690HD
72-81			Belt - Alt.		7435
Detroit Diesel 12V-71T Diesel			Hose - Upper		26510
Belt - Fan	5133760	③▲9480HD	Hose - Lower		26504
Belt - Alt.	9003154	▲9330HD	S12		
Hose - Upper		24240	Detroit Diesel 3-53 Diesel		
Hose - Lower		24256	Hose - Upper - Rear Eng.		24230
82-30			Hose - Lower - Eng. To Pipe (Rear Eng.)		24232
Detroit Diesel 6-71 Diesel			Hose - Lower - Pipe To Rad. (Rear)		24232
Belt - Fan & Alt.	9249814	②BX77	Detroit Diesel 6-71 Diesel		
82-40			Hose - Upper - Front Eng.		24932
Detroit Diesel 8V-71N Diesel				or	26509
Belt - Fan & Gen.	9177465	②BX77	Hose - Lower - Front Eng.		24932
3305				or	26509
Detroit Diesel 8V-71 Diesel					
Belt - Fan		②▲9550HD			
Belt - Alt.		②▲9447HD			

②Two Required.
③Three Required.

▲Standard Belt Available.

Belts and Coolant Hose for Road & Construction Equipment

Application	Mfr. Part No.	Our No.	Application	Mfr. Part No.	Our No.
Terex - Continued			Terex - Continued		
S18			TS14B		
Detroit Diesel 6-110 Diesel			Detroit Diesel 4-53 Diesel		
Belt - Fan & Air Brake Compr.; W/61 1/4" Belt O.C.	5115056	③♣9610HD	Belt - Fan		③♣9451HD
Belt - Fan & Air Brake Compr.; W/61 5/8" Belt O.C.	5122849	④7612	Belt - Alt.		②7425
Belt - Fan & Air Brake Compr.; W/62 3/4" Belt O.C.	5111546	③♣9625HD	Detroit Diesel 4-71N Twin Diesel		
Belt - Gen.	3222608	TR28429	Belt - Fan	5134215	③♣9451HD
S23E			Belt - Gen.	5133173	②7420
Detroit Diesel 8V-71T Diesel			Belt - Alt.		7425
Belt - Fan; W/48 1/4" Belt O.C.	5133760	③♣9480HD	Hose - Upper		24932
Belt - Fan; W/57 1/4" Belt O.C.	5133765	②♣9570HD		or	26511
Belt - Alt.; W/44 1/4" Belt O.C.		②7440	Hose - Lower		24932
Belt - Alt.; W/47 3/4" Belt O.C.	5132591	②7470		or	26511
Hose - Upper - Eng. To Pipe		24436	TS18		
Hose - Upper - Pipe To Rad.		24436	Detroit Diesel 6V-71N Diesel		
Hose - Lower - Eng. To Pipe		24444	Belt - Fan	5133760	③♣9480HD
Hose - Lower - Pipe To Rad.		24444	Hose - Upper		24936
S24			Hose - Lower		24944
Detroit Diesel 12V-71T Diesel			Detroit Diesel 8V-71N Diesel		
Belt - Fan; W/44 3/4" Belt O.C.	9189718	②TR22443	Belt - Fan	5133760	③♣9480HD
Belt - Fan; W/48 1/4" Belt O.C.	9201651	③♣9480HD	Belt - Alt.	5132591	②7470
Belt - Gen.	5125811	♣9380HD	Hose - Upper		24936
Belt - Air Brake Compr.	5126405	TR28473	Hose - Lower		24944
S28			TS18 (29LOT)		
Detroit Diesel 12V-71N Diesel			Detroit Diesel 6-110 Diesel		
Belt - Fan; W/44 3/4" Belt O.C.	9189718	②TR22443	Belt - Gen.	2068846	TR22336
Belt - Fan; W/48 1/4" Belt O.C.	9201651	③♣9480HD	TS24		
Belt - Gen.	5125811	♣9380HD	Cummins NRTO6BI Diesel		
Belt - Air Brake Compr.	5126405	TR28473	Belt - Fan; Ser. No. 23474 Thru 26773	9021068	②TR28545
S32			Belt - W.P.; Ser. No. 23474 Thru 26773	9026236	TR22434
Detroit Diesel 12V-71T Diesel			Detroit Diesel 6-71 Diesel		
Belt - Fan	5133760	③♣9480HD	Belt - Fan	9189718	②TR22443
Belt - Alt.	5137635	②7440	Hose - Upper		24932
S35E			Detroit Diesel 6-110 Diesel		
Detroit Diesel 12V-71T Diesel			Belt - Fan & Air Brake Compr.; W/1/2" Belt T.W.; W/61 1/4" Belt O.C.	5115056	③♣9610HD
Belt - Fan	5133760	③♣9480HD	Belt - Fan & Air Brake Compr.; W/7/16" Belt T.W.; W/61 5/8" Belt O.C.	5111546	④7612
Belt - Alt.	5137635	②7440	Belt - Fan & Air Brake Compr.; W/1/2" Belt T.W.; W/62 1/4" Belt O.C.	5122849	③♣9620HD
Hose - Lower		24956	Belt - Gen.	3222608	TR28429
SS24 (33LOT)			Detroit Diesel 12V-71 Diesel		
Cummins NRTO6BI Diesel			Belt - Fan	5133760	③♣9480HD
Belt - Fan; Ser. No. 23474 Thru 26773	9021068	②TR28545	Belt - Alt.	5133516	♣9380HD
Belt - W.P.; Ser. No. 23474 Thru 26773	9026236	TR22434	Belt - Air Brake Compr.	5137905	TR28473
SS40 (49LDT)			Hose - Upper		24940
Detroit Diesel 12V-71N Diesel			Hose - Lower		24956
Belt - Fan	5133765	③♣9570HD	TS32		
Belt - Gen.	5133516	♣9380HD	Detroit Diesel 8V-71T Diesel		
TS14			Belt - Fan		③♣9570HD
Detroit Diesel 4-71 Twin Diesel			Belt - Alt.	5143240	②♣9341HD
Belt - Fan	9191558	②TR22434	Hose - Upper		24236
Belt - Gen.; W/11/16" Belt T.W.; W/40 3/8" Belt O.C.	9230092	TR22397	Hose - Lower		24244
Belt - Gen.; W/3/4" Belt T.W.; W/40 3/4" Belt O.C.		TR24400	Detroit Diesel 12V-71T Diesel		
Hose - Upper		24932	Belt - Fan	5133760	③♣9480HD
	or	26511	Belt - Alt.	5137635	②7440
Hose - Lower		24932	Hose - Upper		24940
	or	26511	Hose - Lower		24956

④Four Required.
③Three Required.

♣Standard Belt Available.
②Two Required.

Belts and Coolant Hose for Road & Construction Equipment

Application	Mfr. Part No.	Our No.	Application	Mfr. Part No.	Our No.
Thew Shovel			Thew Shovel - Continued		
15T-MC			L501		
Waukesha SRKR			Caterpillar D318 Diesel		
Belt - Fan	7169	@TR32491	Belt - Gov.	4B2544	♣9425HD
50J; 50K			Belt - Starter	6B2746	TR22485
Caterpillar D318 Diesel			MC2; MC3; MC4		
Belt - Gov.	4B2544	♣9425HD	Hercules DRXC		
Belt - Starter	6B2746	TR22485	Belt - Fan	22077	TR28473
414MC			Hercules HXC		
Waukesha SRKR			Belt - Fan	22274	TR24476
Belt - Fan & Compr.	C30741	@TR32491	Waukesha 145GK		
820KS; 820MC			Belt - Fan & Compr.	A25515	@TR34545
Waukesha WAKD			Waukesha SRKR		
Belt - Gen.; W/Truck Eng.	140703	TR34604	Belt - Fan & Compr.	C26573	@TR32491
L27			MC107		
Waukesha 6BL			Cummins J4BI Diesel		
Belt - Fan	9393	TR34435	Belt - Fan & W.P.	70018	@♣9425HD
L30; L37			Belt - Hyd. Pump; W/Wickers Hyd. Pump	101638	6932
Waukesha 6BK; Waukesha 6BKH			MC430		
Belt - Fan	31003B	TR30467	Cummins JT6BI Diesel		
Waukesha VBKH			Belt - Fan	107547	@♣9395HD
Belt - Fan	31003	TR30448	Belt - W.P.	111724	TR22336
L40			Belt - Hyd. Pump	S1792	@TR22405
Waukesha VBKH			MC504; MC504W		
Belt - Fan	31003	TR30448	Waukesha 145GKB		
L41; L41MC			Belt - Gen.	A25515	TR34545
Waukesha SRKR			MC520		
Belt - Fan & Compr.	C30741	@TR32491	Cummins JIS6TC Diesel		
L45			Belt - Fan	106258	@♣9365HD
Waukesha 6SRL			Belt - Gen.	101426	TR22443
Belt - Fan	7169	@TR32491	Cummins NT6BI Diesel		
L50			Belt - Fan & W.P.	70524	@TR22405
Cummins JS6IP Diesel			MC524		
Belt - Fan	106258	@♣9365HD	Cummins NT6B Diesel		
L56			Belt - Fan & W.P.	70524	@TR22405
Cummins JIS6TC Diesel			Waukesha 140GK		
Belt - Fan	106258	@♣9365HD	Belt - Fan; W/Power Units	140003	TR32491
Belt - Gen.	101426	TR22443	Belt - Gen.; W/Truck Eng.	A31856	TR32491
Cummins JS6IP Diesel			MC530W		
Belt - Fan	106258	@♣9365HD	Cummins JIS6TC Diesel		
L66			Belt - Fan	106258	@♣9365HD
Cummins NH6IP Diesel			Belt - Gen.	101426	TR22443
Belt - Fan	S3161	@TR30506	Cummins NT6BI Diesel		
Belt - W.P.	S3095	TR24400	Belt - Fan & W.P.	70524	@TR22405
Belt - Belt; W/Barnes Pump	S3212	2440	MC660		
L85A			Cummins NTO6BI Diesel		
Cummins NTO6IP Diesel			Belt - Fan & W.P.	70524	@TR22405
Belt - Fan	S3161	@TR30506	MC794		
L87; L95			Waukesha 145GKB		
Waukesha EKH			Belt - Gen.	A25515	TR34545
Belt - Fan	63210	@3780	MC875		
			Cummins NRT6BI Diesel		
			Belt - Fan	S3209	TR28473

♣Standard Belt Available.

@Two Required.

Belts and Coolant Hose for Road & Construction Equipment

Application	Mfr. Part No.	Our No.	Application	Mfr. Part No.	Our No.
Thew Shovel - Continued			Trojan-Yale - Continued		
MC875 - Continued			1700; 1900 - Continued		
Cummins NRT6BI Diesel - Continued			Detroit Diesel 4-53 Diesel - Continued		
Belt - Gen.	69489	♣9309HD	Belt - W.P. & Alt.; W/40 5/8" Belt O.C.		②7405
Belt - Belt; W/Vickers P.S. Pump	S3149	②TR22495	Belt - W.P. & Alt.; W/42 5/8" Belt O.C.		②7425
ML153			Belt - Alt.; W/V-Belt Drive		②♣9425HD
Cummins JF6BI Diesel			Belt - Alt.; W/V-Ribbed Belt Drive	5143319	K080360
Belt - Fan & V.P.	106070	②TR22474	Hose - Upper		26510
SP107			Hose - Lower		26508
Cummins J4BI Diesel			2000		
Belt - Fan & W.P.	70018	②♣9425HD	Cummins V555C Diesel		
Belt - Hyd. Pump; W/Vickers Hyd. Pump	101638	6932	Hose - Upper		26512
SP524			Hose - Lower		③<20401
Cummins NT6B Diesel				or	26522
Belt - Fan & W.P.	70524	②TR22405	Detroit Diesel 4-71 Diesel		
Waukesha 140GK			Hose - Upper		
Belt - Fan; W/Power Units	140003	TR32491	Hose - Lower		
Belt - Gen.; W/Truck Eng.	A31856	TR32491	Detroit Diesel 4-71N Diesel		
SP530			Hose - Upper		
Cummins JIS6BI Diesel			Hose - Lower		
Belt - Fan	106258	②♣9365HD	2500		
Belt - Gen.	101426	TR22443	Detroit Diesel 6V-71N Diesel		
TL25K; TL254W			Hose - Upper - Left Side		
Caterpillar D315 Diesel			Hose - Upper - Right Side		
Belt - Gov.	5B7168	♣9385HD	Cummins V903 Diesel		
Belt - Starter	6B5653	TR22416	Hose - Upper - Eng. To Pipe; W/19" Hose		
Detroit Diesel 2-71 Diesel			Hose - Upper - Eng. To Pipe; W/24" Hose		
Belt - Fan & Gen.	5166844	②TR22625	Hose - Upper - Pipe To Rad.; W/19" Hose		
Thomas			Hose - Upper - Pipe To Rad.; W/24" Hose		
T183HD			Hose - Lower		
Kubota V2203 Diesel			Detroit Diesel 6V-71N Diesel		
1997 - 1988			Hose - Upper - Eng. To Pipe		
Belt - Fan & Alt.		♣9430HD	Hose - Upper - Pipe To Rad.		
Hose - Upper		③<20137	Hose - Lower - Eng. To Pipe		
Hose - Lower - Eng. To Pipe		③<20065	Hose - Lower - Pipe To Rad.		
Hose - Lower - Pipe To Rad.		24224	Cummins V-8 265 Diesel		
Toyota			Belt - Fan		
2SDK7; 2SDK8			Belt - W.P.		
Toyota 2J			Belt - Alt.		
1992 - 1986			Hose - Upper		
Belt - Fan & Alt.		TR22448	Hose - Lower - Eng. To Pipe		
3SDK5			Hose - Lower - Pipe To Rad.		
Yanmar 3TN82 Diesel			Detroit Diesel 8V-71 Diesel		
1995 - 1986			Belt - Fan		
Belt - Fan & Alt.		♣9412HD	Belt - Fan & Air Brake Compr.		
Trojan-Yale			Belt - W.P.		
1700; 1900			Belt - Alt.		
Cummins V378 Diesel			Detroit Diesel 8V-71N Diesel		
Belt - Fan		②7355	Hose - Upper - Eng. To Pipe		
Belt - Alt.		♣9360HD	Hose - Upper - Pipe To Rad.		
Hose - Upper		26511	Hose - Lower		
Hose - Lower		24236	6000		
Detroit Diesel 4-53 Diesel			Cummins NT855 Diesel		
Belt - Fan & Air Brake Compr.		②♣9510HD	Belt - Fan		
Belt - Fan & Hyd. Pump		♣9510HD	Belt - W.P.		

②Two Required.
③<Cut to Fit.

♣Standard Belt Available.
③Three Required.

Road & Construction Equipment

Belts and Coolant Hose for Road & Construction Equipment

Road & Construction Equipment

Application	Mfr. Part No.	Our No.	Application	Mfr. Part No.	Our No.
Trojan-Yale - Continued			Vibro-Plus		
7500			CA20		
Cummins KT1150C Diesel			Ford		
Hose - Upper		26532	Belt - Fan		7395
Hose - Lower		26532	Belt - Gen.		7360
Unimog			Belt - P.S.		TR22448
406			Hose - Upper - Rad. To Pipe		24224
Mercedes-Benz OM352 Diesel			Hose - Upper - Pipe To Eng.		24224
Belt - Fan	0049976992	♣9440HD	Hose - Lower		26504
Belt - Fan To Hyd. Pump	0059976892	♣9390HD	CA25		
Belt - W.P. & Alt.	0049976992	♣9440HD	Caterpillar 3145 Diesel		
Hose - Upper		25478	Belt - Fan & Alt.	3N1490	②♣9520HD
Hose - Lower - Pipe To Rad.		♣20433	Hose - Upper		26511
U1200			Hose - Lower		26511
Mercedes-Benz OM352 Diesel			Cummins V352BI Diesel		
Belt - Fan - Eng. To Idler	0049976192	♣9640HD	Belt - Fan	178678	②TR22448
Belt - Fan - Idler To Fan	0049976992	♣9440HD	Belt - Alt.	178630	②♣9390HD
Belt - Alt.	0049971292	♣9505HD	Hose - Lower		24248
Belt - P.S.	0049970592	♣9375HD	VME		
Belt - Hyd. Pump		♣9375HD	L20		
Hose - Lower		25474	Detroit Diesel 4-71 Diesel		
Unit Crane & Shovel			Belt - Fan & Gen.		
H202C				5127669	②♣9530HD
Detroit Diesel 4-71N Diesel			L30		
Belt - Fan		②♣9500HD	Detroit Diesel 6V-53 Diesel		
Belt - Alt.		♣9365HD	Belt - Fan & Gen.	5127669	②♣9530HD
Hose - Upper		♣20206	Volvo		
Hose - Lower - Eng. To Pipe		24232	180 I; 180 II		
Hose - Lower - Pipe To Rad.		24232	Detroit Diesel 6V-53 Diesel		
Vermeer			Belt - Fan	5109052	②♣9600HD
BH700			Belt - W.P.	5116451	②7370
Ford 4-Cyl.			Belt - Gen.	5124814	7375
Belt - Fan & Gen.		♣9415HD	Hose - Upper; Ser. No. 4MG101 Thru 8MG999		②24236
Belt - Hyd. Pump		②TR22363	Hose - Lower; Ser. No. 5LG101 & After		②24232
Hose - Upper		25473	Hose - Lower; Ser. No. 4MG101 Thru 8MG999		②24244
Hose - Lower		20065	280		
	or	♣20433	Cummins NT855 Diesel		
	or	25474	Belt - Fan; W/51 7/8" Belt O.C.	S3094	②TR28514
Versa			Belt - Fan; W/55 1/8" Belt O.C.	178725	③TR28545
6300			Belt - Fan; W/58 1/4" Belt O.C.	178626	③TR24578
Ford 4-Cyl. Diesel			Belt - Fan; W/61 1/8" Belt O.C.	178526	③TR24607
Belt - Fan & Alt.		♣9412HD	Belt - W.P.	200328	TR24438
Hose - Upper		24220	Belt - Alt.	200549	②♣9465HD
Hose - Lower		♣21749	Belt - Gen.; W/36 3/8" Belt O.C.	70350	TR22358
Vibromax			Belt - Gen.; W/40 1/8" Belt O.C.	178573	TR22397
253			Belt - Gen.; W/41 1/2" Belt O.C.	178599	TR22410
Kubota D1403B Diesel			Hose - Lower; Ser. No. 32123 Thru 32999		②24236
Belt - Fan & Alt.	REMF6400	♣9412HD	Hose - Lower; Ser. No. 1MC156 Thru 3MC999		②24236
602			280 Articulated		
Cummins 4-Cyl. 3.9 L Diesel			Detroit Diesel 8V-71N Diesel		
Belt - Serpentine		♣K080560HD	Belt - Fan		③♣9610HD
1103			Belt - Alt.		7380
Cummins 6-Cyl. 5.9 L Diesel			Belt - Hyd. Pump		TR28463
Belt - Serpentine		♣K080560HD	Hose - Upper; Ser. No. 8AMG101 Thru 9AMG999		②24236
			Hose - Lower; Ser. No. 8AMG101 Thru 9AMG999		②24244
			280 I		
			Detroit Diesel 8V-71N Diesel		
			Hose - Upper; Ser. No. 1MG1 Thru 3MG999		②24236

♣Standard Belt Available.
②Two Required.

♣Cut to Fit.
③Three Required.

Belts and Coolant Hose for Road & Construction Equipment

Application	Mfr. Part No.	Our No.	Application	Mfr. Part No.	Our No.
Volvo - Continued			Volvo - Continued		
280 II; 280 III			480 I - Continued		
Detroit Diesel 8V-71N Diesel			Cummins VT12635 Diesel - Continued		
Belt - Fan	③▲9610HD		Hose - Lower - Pipe To Rad.; Ser. No. 4SG101 Thru 4SG999		②24240
Belt - Alt.	7380		A25C		
Belt - Hyd. Pump	TR28463		Volvo TD73KCE Diesel		
Hose - Upper; Ser. No. 8AMG101 Thru 9AMG999	②24236		Belt - W.P.	967119	▲9570HD
Hose - Lower; Ser. No. 8AMG101 Thru 9AMG999	②24244		Belt - Alt.	966695	②7445
280B			Belt - A.C.	978793	▲9555HD
Cummins NT855 Diesel			Hose - Upper - Eng. To Pipe		≅<20206
Belt - Fan; W/51 7/8" Belt O.C.	S3094	②TR28514	Hose - Upper - Pipe To Pipe		24432
Belt - Fan; W/55 1/8" Belt O.C.	178725	③TR28545	Hose - Lower - Eng. To Pipe		≅<20206
Belt - Fan; W/58 1/4" Belt O.C.	178626	③TR24578	L30		
Belt - Fan; W/61 1/8" Belt O.C.	178526	③TR24607	Perkins 4-Cyl. 236 Diesel		
Belt - W.P.	200328	TR24438	Belt - Fan & Alt.		▲9510HD
Belt - Alt.	200549	②▲9465HD	Hose - Upper		26502
Belt - Gen.; W/36 3/8" Belt O.C.	70350	TR22358	L50		
Belt - Gen.; W/40 1/8" Belt O.C.	178573	TR22397	Volvo D45B Diesel		
Belt - Gen.; W/41 1/2" Belt O.C.	178599	TR22410	Belt - Fan & Alt.	966933	②7560
Hose - Lower; Ser. No. 32123 Thru 32999	②24236		Belt - A.C.	958496	▲9455HD
Hose - Lower; Ser. No. 1MC156 Thru 3MC999	②24236		L50B		
280C			Volvo TD40GA Diesel		
Cummins NTA855 Diesel			Belt - Fan & Alt.	967133	②▲9530HD
Belt - Fan; W/51 7/8" Belt O.C.	S3094	②TR28514	Belt - Fan To A.C.	978756	▲9480HD
Belt - Fan; W/55 1/8" Belt O.C.	178725	③TR28545	Hose - Lower - Eng. To Pipe		24432
Belt - Fan; W/58 1/4" Belt O.C.	178626	③TR24578	L70		
Belt - Fan; W/61 1/8" Belt O.C.	178526	③TR24607	Volvo TD45B Diesel		
Belt - W.P.	200328	TR24438	Belt - Fan & Alt.	966933	②7560
Belt - Alt.	200549	②▲9465HD	Belt - A.C.	958496	▲9455HD
Belt - Gen.; W/36 3/8" Belt O.C.	70350	TR22358	L70B		
Belt - Gen.; W/40 1/8" Belt O.C.	178573	TR22397	Volvo TD61GD Diesel		
Belt - Gen.; W/41 1/2" Belt O.C.	178599	TR22410	Belt - Fan & Alt.		②7453
Hose - Lower; Ser. No. 32123 Thru 32999	②24236		Belt - A.C.		②▲9465HD
Hose - Lower; Ser. No. 1MC156 Thru 3MC999	②24236		L90		
380 I			Volvo TD61GL Diesel		
Cummins NFT6CL Diesel			Belt - Fan	967122	②▲9465HD
Belt - Fan	532778	③▲9640HD	Belt - Alt.	958316	7450
Belt - W.P.	S3163	TR22434	Belt - A.C.	958767	▲9430HD
Belt - Gen.	70350	TR22358	Hose - Upper - Eng. To Pipe		≅<20206
Hose - Lower; Ser. No. 42123 & After		②24236	Hose - Lower - Pipe To Cooler		26508
380 II			Hose - Lower - Cooler To Pipe		24432
Cummins 12V-71 Diesel			L90B		
Belt - Fan	S3094	②TR28514	Volvo TD61GB Diesel		
Belt - Gen.	70350	TR22358	Hose - Upper		26507
Hose - Lower - Pipe To Rad.; Ser. No. 2RC1 Thru 2RC999		②24240	Hose - Lower - Pipe To Cooler		24432
380 III			L120		
Cummins 72V-71 Diesel			Volvo TD71G Diesel		
Hose - Lower - Pipe To Rad.; Ser. No. 2RC1 Thru 2RC999		②24240	Belt - Fan	967122	②▲9465HD
480 I			Belt - Alt.	958316	②7450
Cummins VT12635 Diesel			Belt - A.C.	958494	▲9435HD
Belt - Fan	522125	③▲9610HD	Hose - Upper - Eng. To Pipe		24432
Belt - W.P.	125367	TR28376	Hose - Upper - Pipe To Pipe		≅<20206
Belt - Gen.; W/34 3/4" Belt O.C.	134813	TR22344	Hose - Lower - Cooler To Pipe		24432
Belt - Gen.; W/36 3/8" Belt O.C.	70350	TR22358	L150		
Hose - Upper - Pipe To Rad.; Ser. No. 3SC101 Thru 4SC999		②24240	Volvo TD102 Diesel		
Hose - Lower - Pipe To Rad.; Ser. No. 43123 Thru 43999		②24240	Belt - Fan & Idler		②▲9560HD
Hose - Lower - Pipe To Rad.; Ser. No. 2SC1 Thru 2SC999		②24240	Belt - Alt.	966385	②7490

②Two Required.
▲Standard Belt Available.

③Three Required.
≅<Cut to Fit.

Belts and Coolant Hose for Road & Construction Equipment

Application	Mfr. Part No.	Our No.	Application	Mfr. Part No.	Our No.
Volvo - Continued			Wabco - Continued		
L150 - Continued			330H - Continued		
Volvo TD102 Diesel - Continued			IH UD9A Diesel; IH UD350 Diesel - Continued		
Belt - A.C.		②▲9430HD	Belt - Gen.	466856	9300
Hose - Upper - Eng. To Pipe		≈21891	400		
Wabco			Detroit Diesel 6V-71 Diesel		
35; 35C			Hose - Upper - Eng. To Pipe		
Cummins KT1150C Diesel			Hose - Upper - Pipe To Rad.		
Hose - Upper - Pipe To Rad.		24440	Hose - Lower		
Hose - Lower - Eng. To Pipe		24456	440		
Cummins NTA855 Diesel			Cummins JF6BI Diesel		
Hose - Upper - Eng. To Pipe		26529	Belt - Fan; Ser. No. 1500 & After	109179	②▲9385HD
Hose - Upper - Pipe To Rad.		24440	Belt - W.P.; Ser. No. 1500 & After	110896	TR22329
Hose - Lower - Pipe To Rad.		24956	Belt - Gen.; Ser. No. 1500 & After	101426	TR22443
Detroit Diesel 12V-71 Diesel			Detroit Diesel 4-71 Diesel		
Hose - Upper - Eng. To Pipe		23550	Belt - Fan; W/45 7/8" Belt O.C.	5170972	②TR22455
Hose - Upper - Pipe To Rad.		23550	Belt - Fan; W/55" Belt O.C.	3224368	TR34545
101F			Belt - Fan; W/70 1/4" Belt O.C.	3224451	TR34700
Cummins V504 Diesel			Belt - Gen.; W/39 1/2" Belt O.C.	3224367	TR28390
Hose - Upper		≈20611	Belt - Gen.; W/40 3/8" Belt O.C.	5155911	TR24400
	or	26511	IH UD14A Diesel		
Hose - Lower		≈20731	Belt - Fan & W.P.	30982DB	TR32571
	or	26521	Belt - Gen.	426856	9279
150RG1			500		
IH JC200			Detroit Diesel 8V-71 Diesel		
Hose - Lower - Eng. To Pipe		24232	Hose - Upper - Eng. To Pipe		
Hose - Lower - Pipe To Rad.		24224	Hose - Upper - Pipe To Rad.		
170RD2			Hose - Lower - Eng. To Pipe		
Ford 6-Cyl. 254 Diesel			Hose - Lower - Pipe To Rad.		
Hose - Upper		25527	555		
Hose - Lower - Eng. To Pipe		24232	Cummins H743C Diesel		
Hose - Lower - Pipe To Pipe		24228	Belt - Fan	172856	②TR24457
Hose - Lower - Pipe To Rad.		24228	Belt - Alt.	178727	▲9420HD
222G; 229G			Cummins N855 Diesel		
Detroit Diesel 8V-71T Diesel			Belt - Fan		
Hose - Upper - Eng. To Pipe		24236	Belt - Alt.		
Hose - Upper - Pipe To Rad.		24236	②TR24457		
Hose - Lower - Eng. To Pipe		24244	▲9405HD		
Hose - Lower - Pipe To Rad.		24244	Detroit Diesel 6-71 Diesel		
300			Belt - Fan		
Detroit Diesel 6V-53 Diesel			Belt - Alt.		
Hose - Upper - Eng. To Pipe		26611	②▲9550HD		
Hose - Upper - Pipe To Rad.		26611	▲9570HD		
Hose - Lower		26510	Hose - Upper		
330H			Hose - Lower		
Cummins JBSI Diesel			26515		
Belt - Fan	109179	②▲9385HD	666		
Belt - W.P.	111726	TR22329	Cummins H743C Diesel		
Belt - Gen.	101426	TR22443	Belt - Fan	172856	②TR24457
Detroit Diesel 3-71 Diesel			Belt - Alt.	178727	▲9420HD
Belt - Fan; W/45 7/8" Belt O.C.	5170972	②TR22455	Hose - Upper	26511	
Belt - Fan; W/55" Belt O.C.	3224368	TR34545	Hose - Lower	26523	
Belt - Fan; W/70 1/4" Belt O.C.	3224451	TR34700	Cummins N855 Diesel		
Belt - Gen.; W/39 1/2" Belt O.C.	3224367	TR28390	Belt - Fan		②TR24457
Belt - Gen.; W/40 3/8" Belt O.C.	5155911	TR24400	Belt - Alt.		▲9405HD
Belt - Compr.	3224451	TR34700	Detroit Diesel 4-71 Diesel		
IH UD9A Diesel; IH UD350 Diesel			Belt - Fan; W/Dual Belts		
Belt - Fan & W.P.	48042D	TR30484	Belt - Gen.; W/39 1/2" Belt O.C.	3224367	TR28390
			Belt - Gen.; W/40 3/8" Belt O.C.	5155911	TR24400
			Belt - Compr.	3224451	TR34700
			Detroit Diesel 6-71 Diesel		
			Belt - Fan		②▲9550HD
			Belt - Alt.		▲9570HD

≈Cut to Fit.
②Two Required.

▲Standard Belt Available.

Belts and Coolant Hose for Road & Construction Equipment

Application	Mfr. Part No.	Our No.	Application	Mfr. Part No.	Our No.
Wabco - Continued			Wabco - Continued		
666 Power Flow			AFE6 - Continued		
Detroit Diesel 4-71 Diesel			Detroit Diesel 16V-149 Diesel - Continued		
Belt - Fan; W/Dual Belts	5170972	TR22455	Hose - Lower - Eng. To Pipe		24272
Belt - Gen.; W/39 1/2" Belt O.C.	3224367	TR28390	Hose - Lower - Pipe To Rad.		24272
Belt - Gen.; W/40 3/8" Belt O.C.	5155911	TR24400	BF43		
Belt - Compr.	3224451	TR34700	Detroit Diesel 16V-71 Diesel		
666B			Hose - Upper - Water Manifold To Pipe		
Detroit Diesel 4-71 Diesel			Hose - Upper - Pipe To Rad.		
Belt - Fan	5136270	②▲9560HD	Hose - Lower - Eng. To Pipe (Upper)		
Belt - Alt.		▲9570HD	Hose - Lower - Eng. To Pipe (Lower)		
Hose - Upper		26510	Hose - Lower - Pipe To Rad.		
Hose - Lower		26510	BFA6		
666C			Cummins VT1710 Diesel		
Cummins H135C Diesel			Hose - Upper - Eng. To Pipe		
Belt - Fan		②TR24457	Hose - Upper - Pipe To Rad.		
Belt - Fan To Alt.		▲9420HD	Hose - Lower		
Hose - Upper		26517	BFA9		
Hose - Lower		26523	Cummins VT1710 Diesel		
Hose - By Pass		24224	Hose - Upper - Eng. To Pipe		
777			Hose - Upper - Pipe To Rad.		
Cummins H743C Diesel			Hose - Lower - Eng. To Pipe		
Belt - Fan	172856	②TR24457	C		
Belt - Alt.	178727	▲9420HD	Detroit Diesel 8V-71 Diesel		
Detroit Diesel 6-71 Diesel			Hose - Upper - Eng. To Pipe		
Belt - Fan		②▲9550HD	Hose - Upper - Pipe To Rad.		
Belt - Alt.		▲9570HD	Hose - Lower - Eng. To Pipe		
777 Power Flow			Hose - Lower - Pipe To Rad.		
Detroit Diesel 6-71 Diesel			CFA19; CFA20B		
Belt - Fan; W/Dual Belts	5170972	TR22455	Detroit Diesel 12V-71 Diesel		
Belt - Gen.; W/39 1/2" Belt O.C.	3224367	TR28390	Hose - Upper - Eng. To Pipe		
Belt - Gen.; W/40 3/8" Belt O.C.	5155911	TR24400	Hose - Upper - Pipe To Rad.		
Belt - Compr.	3224451	TR34700	Hose - Lower - Eng. To Pipe		
777B			Hose - Lower - Pipe To Rad.		
Cummins N855 Diesel			F		
Belt - Fan		②TR24457	Cummins HRF6 Diesel		
Belt - Alt.		▲9405HD	Belt - Fan		
Detroit Diesel 6-71N Diesel			Belt - Fan To Alt.		
Belt - Fan		②▲9550HD	Hose - Upper		
Belt - Alt.		▲9570HD	Hose - Lower - Eng. To Cooler		
Hose - Upper		26509	Hose - Lower - Cooler To Rad.		
Hose - Lower		26511	Hose - By Pass		
AFE1			Waldon		
Detroit Diesel 16V-149 Diesel			100H		
Belt - Gen.		▲9400HD	Continental 3-Cyl. Diesel		
Belt - Hyd. Pump		TR28473	Belt - Fan & Alt.		
AFE5			Hose - Upper		
Detroit Diesel 16V-149 Diesel			4100		
Belt - Fan		③▲9650HD	Continental TM27		
Belt - Gen.		▲9400HD	Belt - Fan & Alt.		
Belt - Hyd. Pump		TR28473	Hose - Upper		
Hose - Upper - Eng. To Pipe		24456	5000		
Hose - Upper - Pipe To Rad.		24456	Ford 4-Cyl. Diesel		
Hose - Lower - Eng. To Pipe		24272	Belt - Fan & Alt.		
Hose - Lower - Pipe To Rad.		24272	5100		
AFE6			Continental TM27		
Detroit Diesel 16V-149 Diesel			Belt - Fan		
Hose - Upper - Eng. To Pipe		24456	▲9465HD		
Hose - Upper - Pipe To Rad.		24456			

▲Standard Belt Available.
③Three Required.

②Two Required.

Belts and Coolant Hose for Road & Construction Equipment

Application	Mfr. Part No.	Our No.	Application	Mfr. Part No.	Our No.
Waldon - Continued			Warner & Swasey - Continued		
5100 - Continued			H550 - Continued		
Continental TM27 - Continued			Detroit Diesel 4-71N Diesel - Continued		
Hose - Upper		26501	Belt - Alt.		♣9600HD
6000			Hose - Upper		26509
Ford 4-Cyl. 172			Hose - Lower		26508
Belt - Fan & Alt.		♣9415HD	H900A		
Hose - Upper		25250	Detroit Diesel 8V-71N Diesel		
8500			Belt - Fan		③♣9451HD
Perkins 6-Cyl. 354 Diesel			Belt - Alt.		K080370
Belt - Fan & Alt.		♣9510HD	Hose - Upper		②♣20731
Hose - Upper		26501		or	②26522
Hose - Lower - Eng. To Pipe		♣21660	Hose - Lower		24940
Hose - Lower - Pipe To Rad.		♣21794	HT4418		
Hose - By Pass		♣20065	Detroit Diesel 4-53 Diesel		
Warner & Swasey			Belt - Fan		②♣9405HD
300 Hydro-Cruiser			Belt - W.P. & Alt.		②7405
Detroit Diesel 3-53N Diesel			Hose - Lower		26507
Belt - Fan		②♣9390HD	Hose - By Pass		28443
Belt - W.P. & Alt.		7417	Weldon		
Hose - Upper		26603	Sweepmaster		
Hose - Lower		26507	Cummins 4-Cyl. 3.9 L Diesel		
300 Hydro-Scopic			Belt - Fan & Alt.	3903090	♣K080550HD
Chrysler V-8 318			Zettlemeyer		
Belt - Fan & Alt. - Lower Structure		♣9540HD	ZL602		
Belt - Fan & P.S. - Lower Structure		7530	Deutz BF4L1011T Diesel		
Belt - Air Brake Compr. & Idler		♣9660HD	Belt - Blower & Idler		7445
Hose - Upper - Lower Structure		26506			
Hose - Lower - Lower Structure		26506			
Hose - By Pass - Lower Structure		20693			
Detroit Diesel 3-53N Diesel					
Belt - Fan - Upper Structure		②♣9390HD			
Belt - W.P. & Alt. - Upper Structure		7410			
Hose - Upper - Upper Structure		♣20957			
	or	26603			
Hose - Lower - Upper Structure		26507			
300TM-C					
Chrysler V-8 361					
Belt - Fan & Alt. - Upper Structure		②♣9550HD			
Hose - Upper - Upper Structure		25527			
Hose - Lower - Upper Structure		②24224			
Continental M6363					
Belt - Compr. - Lower Structure		TR22508			
Hose - Upper - Lower Structure		26603			
Hose - Lower - Lower Structure		26603			
G660					
Chrysler V-8 413					
Belt - Fan & Alt. - Lower Structure	1855867	②♣9610HD			
Belt - Compr. & Idler - Lower Structure	2946719	♣9740HD			
Hose - Upper - Lower Structure		26510			
Detroit Diesel 4-53 Diesel					
Belt - Fan - Upper Structure		②♣9412HD			
Belt - W.P. & Alt. - Upper Structure	186671076	②7417			
Hose - Upper - Upper Structure		26504			
Hose - Lower - Upper Structure		26522			
H550					
Detroit Diesel 4-71N Diesel					
Belt - Fan		②♣9500HD			

♣Standard Belt Available.
②Two Required.

♣Cut to Fit.
③Three Required.

Belts and Coolant Hose for Power Units

Order Belts and Hose by Our Number. Manufacturers' Part Number is shown for reference only.

Application	Mfr. Part No.	Our No.	Application	Mfr. Part No.	Our No.
Aggreko			Allis-Chalmers - Continued		
8031.05			6DH691		
Hose - Upper		②24226	Belt - Fan	DP745	③TR28666
Hose - Lower		②24224	Belt - Gen.	H12145	TR28454
8061.25R			6DH909		
Belt - Fan & Alt.		②7450	Belt - Fan	DP773	③TR28628
Allis-Chalmers			6DT389; 6DT488		
4B153; 4B182			Belt - Fan	DE41321	②TR28570
Belt - Fan & W.P.; Auto.	DE51295	TR28463	Belt - Fan & Compr.	M60312	②TR28657
Belt - Fan; Ind.	H12094	TR28473	6DTS468		
4BD153; 4BD182			Belt - Fan & Compr.	M60312	②TR28657
Belt - Fan & W.P.; Auto.	DE51295	TR28463	Belt - Supercharger	DE45068	③TR22392
Belt - Fan & Gen.; Ind.	4612234	TR28437	6MO672; 6MO779; 6MO893; 6MO970		
Belt - Fan; W/O Gen.; Ind.	H12094	TR28473	Belt - Fan	K40285	②TR28583
4DA153; 4DA182			Belt - Fan & Compr.; W/66 1/8" Belt O.C. ...	4660312	②TR28657
Belt - Fan; W/49 7/8" Belt O.C.	4351190	TR28492	Belt - Fan & Compr.; W/77 1/8" Belt O.C.		②TR30770
Belt - Fan & Gen.	4351295	TR28463	Belt - Compr.	4363346	TR28733
Belt - Fan; W/O Gen.	4612234	TR28437	Belt - Starter	4662778	②TR30448
4DC645; 4MO645			8DA1125		
Belt - Fan	4660312	②TR28657	Belt - Fan	DE63593	③TR28616
6B230; 6B273			8DA1290		
Belt - Fan; Auto.	DE51295	TR28463	Belt - Fan	DE63869	③TR28743
Belt - Fan; Ind.	H12094	TR28473	8DAS1125		
6BD230; 6BD273			Belt - Fan	DE63593	③TR28616
Belt - Fan; Auto.	DE51295	TR28463	8DAS1290		
Belt - Fan & Gen.; Ind.	H12234	TR28437	Belt - Fan	DE63869	③TR28743
Belt - Fan; W/O Gen.; Ind.	H12094	TR28473	8DC1125; 8DC1290; 8DCS1125; 8DCS1290		
6DA230; 6DA273			Belt - Fan; Auto.; W/68 5/8" Belt O.C.	DE64787	②TR28680
Belt - Fan & Gen.; Ser. No. 104665 & Before	4351295	TR28463	Belt - Fan; Auto.; W/79 1/8" Belt O.C.		③TR28786
Belt - Fan; W/O Gen.; Ser. No. 104665 & Before	4612234	TR28437	Belt - Fan & Compr.; Auto.	DE41456	②C78
Belt - Fan & Gen.; Ser. No. 104666 & After.	4641213	TR28483	Belt - Fan; Ind.	DE63592	③TR28733
Belt - Fan; W/O Gen.; Ser. No. 104666 & After	4612145	TR28454	8DCS2505		
Belt - Fan; W/8 1/4" C.S. Pulley	4351190	TR28492	Belt - Gen.	AP4631	TR24400
6DA779; 6DA844; 6DA970			8MO1290; 8MOS1290		
Belt - Fan & Compr.; W/8-Blade Fan	M60312	②TR28657	Belt - Fan; W/Blower Type Fan	4356965	TR28583
Belt - Fan; W/O Compr.		②TR22474	Belt - Starter	4662778	②TR30448
6DAS510; 6DAS516; 6DAS844			Belt - Compr.	4368110	TR22373
Belt - Fan; Auto.	DE46764	②TR22578	8PC2505		
Belt - Gen.; Auto.	DE46762	TR24315	Belt - Gen.	AP4631	TR24400
Belt - Compr.; Auto.	DE46763	TR28583	10000; 11000		
Belt - Blower; Auto.	DE46765	②TR28514	Belt - Fan	4335452	②TR28649
Belt - Fan; Ind.; W/8-Blade Fan	M60312	②TR28657	Belt - Gen.; W/43 1/4" Belt O.C.	4707730	▲9430HD
6DC844; 6DC970			Belt - Gen.; W/45 3/8" Belt O.C.	4613571	▲9451HD
Belt - Fan	K40285	②TR28583	Belt - Compr.	4349109	TR28473
6DCB879			16000		
Belt - Fan; W/67" Belt O.C.; W/2-Belt Drive .	4031597	②TR28666	Belt - Fan; W/63 3/4" Belt O.C.	4348694	②TR28628
Belt - Fan; W/67 1/8" Belt O.C.; W/3-Belt Drive	4034031	③TR28666	Belt - Fan; W/62 1/2" Belt O.C.	4366448	②TR28616
Belt - Fan; W/85 5/8" Belt O.C.	4331717	③CX81	Belt - Fan; W/Air Actuated Fan; W/63 3/4" Belt O.C.	4348694	②TR28628
6DCS844			Belt - Fan; W/Air Actuated Fan; W/65 1/2" Belt O.C.	4335452	②TR28649
Belt - Fan & Compr.; Auto.	DE65732	②TR28693	Belt - W.P.; W/50" Belt O.C.	4386813	TR22495
Belt - Fan; W/O Compr.; Auto.		②TR22474	Belt - W.P.; W/56 1/2" Belt O.C.	4338380	TR28557
Belt - Fan; Ind.	K40285	②TR28583	Belt - Gen.; W/24V. 10A., 18A., 32V. 10A. Std. Gen.	4616583	▲9430HD
6DCS1879			Belt - Gen.; W/12V. 50A., 24V. 10A. Dust Proof Gen.	4707726	▲9440HD
Belt - Fan; W/67" Belt O.C.; W/2-Belt Drive .	4031597	②TR28666	Belt - Gen.; W/24V. 10A., 18A. Std. Gen.; W/O Crank Pulley Drive	4613099	TR28565
Belt - Fan; W/67 1/8" Belt O.C.; W/3-Belt Drive	4034031	③TR28666	Belt - Gen.; W/24V. 10A., 18A. Std. Gen.; W/Crank Pulley Drive	4346763	TR28570
Belt - Fan; W/85 5/8" Belt O.C.	4331717	③CX81	Belt - Gen.; W/36 3/4" Belt O.C.	4379880	▲9365HD

②Two Required.
▲Standard Belt Available.

③Three Required.

Belts and Coolant Hose for Power Units

Application	Mfr. Part No.	Our No.	Application	Mfr. Part No.	Our No.
Allis-Chalmers - Continued			Allis-Chalmers - Continued		
16000 - Continued			21000H; 25000 - Continued		
Belt - Gen.; W/39 1/4" Belt O.C.	4707728	♣9390HD	Belt - Gen.; W/24V. 10A., 18A., 32V. 10A. Std. Gen.	4616583	♣9430HD
Belt - Gen.; W/40 3/4" Belt O.C.	4707731	♣9405HD	Belt - Gen.; W/12V. 50A., 24V. 10A. Dust Proof Gen.	4707726	♣9440HD
Belt - Gen.; W/41 3/4" Belt O.C.	4378806	♣9415HD	Belt - Gen.; W/24V. 10A., 18A. Std. Gen.; W/O Crank Pulley Drive	4613099	TR28565
Belt - Gen.; W/48 1/4" Belt O.C.	4512419	♣9480HD	Belt - Gen.; W/24V. 10A., 18A. Std. Gen.; W/Crank Pulley Drive	4346763	TR28570
Belt - Gen.; W/59" Belt O.C.	4339458	TR28583	Belt - Gen.; W/36 3/4" Belt O.C.	4379880	♣9365HD
Belt - P.S.	4368110	③TR22373	Belt - Gen.; W/39 1/4" Belt O.C.	4707728	♣9390HD
Belt - Compr.; W/7 1/4, 12 Cu. Ft. Compr.; W/32" Fan	4612058	TR28514	Belt - Gen.; W/40 3/4" Belt O.C.	4707731	♣9405HD
Belt - Compr.; W/24 Cu. Ft. Compr.	4347818	TR30543	Belt - Gen.; W/41 3/4" Belt O.C.	4378806	♣9415HD
16000H			Belt - Gen.; W/48 1/4" Belt O.C.	4512419	♣9480HD
Belt - Fan; W/62 1/2" Belt O.C.	4366448	②TR28616	Belt - Gen.; W/59" Belt O.C.	4339458	TR28583
Belt - Fan; W/Air Actuated Fan; W/63 3/4" Belt O.C.	4348694	②TR28628	Belt - P.S.	4368110	③TR22373
Belt - Fan; W/Air Actuated Fan; W/65 1/2" Belt O.C.	4335452	②TR28649	Belt - Compr.; W/7 1/4, 12 Cu. Ft. Compr.; W/32" Fan	4612058	TR28514
Belt - W.P.; W/50" Belt O.C.	4386813	TR22495	25000 Mark II		
Belt - W.P.; W/56 1/2" Belt O.C.	4338380	TR28557	Belt - Fan	4392613	②TR24647
Belt - Gen.; W/24V. 10A., 18A., 32V. 10A. Std. Gen.	4616583	♣9430HD	Belt - Fan To Alt.	4392614	♣9463HD
Belt - Gen.; W/12V. 50A., 24V. 10A. Dust Proof Gen.	4707726	♣9440HD	Belt - Fan To Compr.	4612058	TR28514
Belt - Gen.; W/24V. 10A., 18A. Std. Gen.; W/O Crank Pulley Drive	4613099	TR28565	Belt - W.P. To Idler	4391351	7495
Belt - Gen.; W/24V. 10A., 18A. Std. Gen.; W/Crank Pulley Drive	4346763	TR28570	B125		
Belt - Gen.; W/36 3/4" Belt O.C.	4379880	♣9365HD	Belt - Fan & Gen.	207003	TR22322
Belt - Gen.; W/39 1/4" Belt O.C.	4707728	♣9390HD	Belt - Fan; W/O Gen.	209656	TR22363
Belt - Gen.; W/40 3/4" Belt O.C.	4707731	♣9405HD	D153		
Belt - Gen.; W/41 3/4" Belt O.C.	4378806	♣9415HD	Belt - Fan	4351295	TR28463
Belt - Gen.; W/48 1/4" Belt O.C.	4512419	♣9480HD	D175		
Belt - Gen.; W/59" Belt O.C.	4339458	TR28583	Belt - Fan & Gen.; W/41 3/4" Belt O.C.	4378806	♣9415HD
Belt - P.S.	4368110	③TR22373	Belt - Fan & Gen.; W/44 7/8" Belt O.C.	4514232	♣9447HD
Belt - Compr.; W/7 1/4, 12 Cu. Ft. Compr.; W/32" Fan	4612058	TR28514	Belt - Fan & Gen.; W/45 3/8" Belt O.C.	4511434	♣9451HD
21000			D230		
Belt - Fan; W/62 1/2" Belt O.C.	4366448	②TR28616	Belt - Fan	4351295	TR28463
Belt - Fan; W/Air Actuated Fan; W/63 3/4" Belt O.C.	4348694	②TR28628	D262		
Belt - Fan; W/Air Actuated Fan; W/65 1/2" Belt O.C.	4335452	②TR28649	Belt - Fan & Gen.; W/46" Belt O.C.	4612145	TR28454
Belt - Fan; W/66 1/8" Belt O.C.	4616522	②TR28657	Belt - Fan & Gen.; W/47" Belt O.C.	4351295	TR28463
Belt - W.P.; W/50" Belt O.C.	4386813	TR22495	Belt - Fan & Gen.; W/50" Belt O.C.	4351190	TR28492
Belt - W.P.; W/56 1/2" Belt O.C.	4338380	TR28557	Belt - Fan & Gen.; W/44 3/8" Belt O.C.	4612234	TR28437
Belt - Gen.; W/24V. 10A., 18A., 32V. 10A. Std. Gen.	4616583	♣9430HD	D344; D516		
Belt - Gen.; W/12V. 50A., 24V. 10A. Dust Proof Gen.	4707726	♣9440HD	Belt - Fan	4335864	②TR28583
Belt - Gen.; W/24V. 10A., 18A. Std. Gen.; W/O Crank Pulley Drive	4613099	TR28565	Belt - Gen. & W.P.; W/52 1/4" Belt O.C.	4348851	TR28514
Belt - Gen.; W/24V. 10A., 18A. Std. Gen.; W/Crank Pulley Drive	4346763	TR28570	Belt - Gen. & W.P.; W/53" Belt O.C.	4348408	TR28522
Belt - Gen.; W/36 3/4" Belt O.C.	4379880	♣9365HD	Belt - Gen. & Compr.	4335242	TR28423
Belt - Gen.; W/39 1/4" Belt O.C.	4707728	♣9390HD	Belt - Compr.	4335864	TR28583
Belt - Gen.; W/40 3/4" Belt O.C.	4707731	♣9405HD	D779; D844; DS844		
Belt - Gen.; W/41 3/4" Belt O.C.	4378806	♣9415HD	Belt - Fan	4660312	②TR28657
Belt - Gen.; W/48 1/4" Belt O.C.	4512419	♣9480HD	G138; G149		
Belt - Gen.; W/59" Belt O.C.	4339458	TR28583	Belt - Fan & Gen.	209656	TR22363
Belt - P.S.	4368110	③TR22373	Belt - Fan; W/O Gen.	207003	TR22322
Belt - Compr.; W/7 1/4, 12 Cu. Ft. Compr.; W/32" Fan	4612058	TR28514	G226		
Belt - Compr.; W/24 Cu. Ft. Compr.	4612058	TR28514	Belt - Fan & Gen.	229211	♣9463HD
21000H; 25000			G262		
Belt - Fan; W/62 1/2" Belt O.C.	4366448	②TR28616	Belt - Fan & Gen.	4514232	♣9447HD
Belt - Fan; W/Air Actuated Fan; W/63 3/4" Belt O.C.	4348694	②TR28628	H173; H199; H205; H217		
Belt - Fan; W/Air Actuated Fan; W/65 1/2" Belt O.C.	4335452	②TR28649	Belt - Fan; Auto.; Ser. No. 239680 & Before	H12145	TR28454
Belt - W.P.; W/50" Belt O.C.	4386813	TR22495	Belt - Fan; Auto.; Ser. No. 239681 & After ..	H12094	TR28473
Belt - W.P.; W/56 1/2" Belt O.C.	4338380	TR28557	Belt - Fan; Ind.; Ser. No. 239681 & Before		TR28514
			Belt - Fan; Ind.; Ser. No. 239682 & After	H12094	TR28473
			H260; H298; H326		
			Belt - Fan; Auto.; Ser. No. 239762 & Before	H12145	TR28454

♣Standard Belt Available.
②Two Required.

③Three Required.

Belts and Coolant Hose for Power Units

Application	Mfr. Part No.	Our No.	Application	Mfr. Part No.	Our No.
Allis-Chalmers - Continued			Caterpillar - Continued		
H260; H298; H326 - Continued			1673 (70B)		
Belt - Fan; Auto.; Ser. No. 239763 & After ..	H12094	TR28473	Belt - Fan; W/32 1/8" Belt O.C.		②♣9319HD
Belt - Fan; Ind.; Ser. No. 239762 & Before ..	DE55926	TR28514	Belt - Fan; W/41 3/4" Belt O.C.	4M6291	♣9415HD
Belt - Fan; Ind.; Ser. No. 239763 & After ..		TR28473	Belt - Fan; W/45 3/8" Belt O.C.	9L1740	②♣9451HD
HD344			Belt - Fan; W/1/2" Belt T.W.; W/52 1/4" Belt O.C.	9L894	②♣9520HD
Belt - Fan	4349777	②TR28483	Belt - Fan; W/3/4" Belt T.W.; W/52 1/4" Belt O.C.	3H9862	②TR24515
Belt - Gen.	4349729	TR22485	Belt - Fan; W/58 1/4" Belt O.C.	7L5001	♣9580HD
HD516			Belt - Fan; W/58 3/4" Belt O.C.	9L304	②TR24578
Belt - Fan	4349778	②TR28522	Belt - W.P.; W/54 1/4" Belt O.C.	9L1731	②♣9540HD
Belt - Gen.	4349728	TR22514	Belt - W.P.; W/60 1/4" Belt O.C.	9L1105	②♣9600HD
HP205; HP217; HP234			Belt - Alt.; W/57 1/4" Belt O.C.	9L1128	②♣9570HD
Belt - Fan & Gen.; Auto.	DE55926	TR28514	Belt - Alt.; W/62 1/4" Belt O.C.	9L1183	②♣9620HD
Belt - Fan; W/O Gen.	H12094	TR28473	Belt - Alt.; W/64 1/4" Belt O.C.	9L1213	②♣9640HD
Belt - Fan & Gen.; Ind.	H12095	TR28522	Belt - Alt.; W/67 1/4" Belt O.C.	9L1130	②♣9670HD
HP260; HP298; HP326; HP351			Belt - Alt. & Compr.; W/52 1/4" Belt O.C.	9L894	②♣9520HD
Belt - Fan & Gen.; Auto.	DE55926	TR28514	Belt - Alt. & Compr.; W/55 1/4" Belt O.C.	9L1553	②♣9550HD
Belt - Fan; W/O Gen.	H12094	TR28473	Belt - Gen.; W/39 1/4" Belt O.C.	5B7168	♣9390HD
K428			Belt - Gen.; W/40 1/4" Belt O.C.	3L6309	♣9400HD
Belt - Fan	DE41321	②TR28570	Belt - Gen.; W/41 3/4" Belt O.C.	4M6291	♣9415HD
LO525			Belt - Compr.; W/O Kenworth Compr.	9L1502	♣9319HD
Belt - Fan; Auto.	KE567	TR28483	Belt - Compr.; W/Kenworth Compr.	9L2266	②♣9313HD
Belt - Fan; Ind.	DP1597	②TR28666	1673B (1L)		
W201; W226			Belt - Fan; W/52 1/4" Belt O.C.	5B8473	②TR24515
Belt - Fan & Gen.	209824	TR22461	Belt - Fan; W/58 3/4" Belt O.C.	9L304	TR24578
Belt - Fan; W/O Gen.	203073	TR22416	Belt - P.S.	9L2248	②♣9480HD
Amita			1673B (69D)		
G25			Belt - Fan; W/52 1/4" Belt O.C.	9L894	②♣9520HD
Belt - Alt.; W/Isuzu Eng.	8942568000	TR24407	Belt - Fan; W/58 1/4" Belt O.C.	7L5001	②♣9580HD
Bedford			Belt - Alt.; W/41 3/4" Belt O.C.	4M6291	②♣9415HD
220FF			Belt - Alt.; W/57 1/4" Belt O.C.	9L1128	②♣9570HD
Belt - Fan & Alt.; W/4-Cyl. Diesel Eng.		②7500	Belt - Alt.; W/64 1/4" Belt O.C.	9L1213	②♣9640HD
330FF			Belt - Fan; W/78 1/8" Belt O.C.	9L4265	③9775
Belt - Fan & Gen.; W/6-Cyl. Diesel Eng.		②7490	Belt - Compr. & Alt.	9L1553	②♣9550HD
Caterpillar			1673B (70B)		
348 (36J); 348 (38J)			Belt - Fan; W/32 1/8" Belt O.C.		②♣9319HD
Belt - Alt.; W/49 1/4" Belt O.C.	7L5090	②7490	Belt - Fan; W/41 3/4" Belt O.C.	4M6291	♣9415HD
Belt - Alt.; W/50 1/4" Belt O.C.	1N9310	②7500	Belt - Fan; W/45 3/8" Belt O.C.	9L1740	②♣9451HD
1170			Belt - Fan; W/1/2" Belt T.W.; W/52 1/4" Belt O.C.	9L894	②♣9520HD
Belt - Fan	9L894	②♣9520HD	Belt - Fan; W/3/4" Belt T.W.; W/52 1/4" Belt O.C.	3H9862	②TR24515
Belt - W.P. & Idler	9L894	②♣9520HD	Belt - Fan; W/58 1/4" Belt O.C.	7L5001	♣9580HD
Belt - W.P. To Compr. & Alt.	6L3294	②♣9650HD	Belt - Fan; W/58 3/4" Belt O.C.	9L304	②TR24578
1670			Belt - W.P.; W/54 1/4" Belt O.C.	9L1731	②♣9540HD
Belt - Fan	9L894	②♣9520HD	Belt - W.P.; W/60 1/4" Belt O.C.	9L1105	②♣9600HD
Belt - Alt.	4M6291	♣9425HD	Belt - Alt.; W/57 1/4" Belt O.C.	9L1128	②♣9570HD
Belt - Compr.	9L2266	②♣9313HD	Belt - Alt.; W/62 1/4" Belt O.C.	9L1183	②♣9620HD
1673 (1L)			Belt - Alt.; W/64 1/4" Belt O.C.	9L1213	②♣9640HD
Belt - Fan; W/52 1/4" Belt O.C.	5B8473	②TR24515	Belt - Alt.; W/67 1/4" Belt O.C.	9L1130	②♣9670HD
Belt - Fan; W/58 3/4" Belt O.C.	9L304	TR24578	Belt - Alt. & Compr.; W/52 1/4" Belt O.C.	9L894	②♣9520HD
Belt - P.S.	9L2248	②♣9480HD	Belt - Alt. & Compr.; W/55 1/4" Belt O.C.	9L1553	②♣9550HD
1673 (69D)			Belt - Gen.; W/39 1/4" Belt O.C.	5B7168	♣9390HD
Belt - Fan; W/52 1/4" Belt O.C.	9L894	②♣9520HD	Belt - Gen.; W/40 1/4" Belt O.C.	3L6309	♣9400HD
Belt - Fan; W/58 1/4" Belt O.C.	7L5001	②♣9580HD	Belt - Gen.; W/41 3/4" Belt O.C.	4M6291	♣9415HD
Belt - Alt.; W/41 3/4" Belt O.C.	4M6291	②♣9415HD	Belt - Compr.; W/O Kenworth Compr.	9L1502	♣9319HD
Belt - Alt.; W/57 1/4" Belt O.C.	9L1128	②♣9570HD	Belt - Compr.; W/Kenworth Compr.	9L2266	②♣9313HD
Belt - Alt.; W/64 1/4" Belt O.C.	9L1213	②♣9640HD	1673C (1L)		
Belt - Fan; W/78 1/8" Belt O.C.	9L4265	③9775	Belt - Fan; W/52 1/4" Belt O.C.	5B8473	②TR24515
Belt - Compr. & Alt.	9L1553	②♣9550HD	Belt - Fan; W/58 3/4" Belt O.C.	9L304	TR24578
			Belt - P.S.	9L2248	②♣9480HD
			1673C (69D)		
			Belt - Fan; W/52 1/4" Belt O.C.	9L894	②♣9520HD
			Belt - Fan; W/58 1/4" Belt O.C.	7L5001	②♣9580HD
			Belt - Alt.; W/41 3/4" Belt O.C.	4M6291	②♣9415HD
			Belt - Alt.; W/57 1/4" Belt O.C.	9L1128	②♣9570HD

②Two Required.
③Three Required.

♣Standard Belt Available.

Belts and Coolant Hose for Power Units

Application	Mfr. Part No.	Our No.	Application	Mfr. Part No.	Our No.
Caterpillar - Continued			Caterpillar - Continued		
1673C (69D) - Continued			3406 (90V)		
Belt - Alt.; W/64 1/4" Belt O.C.	9L1213	②♣9640HD	Belt - Alt.		②TR22570
Belt - Fan; W/78 1/8" Belt O.C.	9L4265	③9775	Hose - Upper - Eng. To Pipe		24440
Belt - Compr. & Alt.	9L1553	②♣9550HD	Hose - Upper - Pipe To Rad.		24440
1673C (70B)			Hose - Lower - Eng. To Pipe		24448
Belt - Fan; W/32 1/8" Belt O.C.		②♣9319HD	Hose - Lower - Pipe To Rad.		24456
Belt - Fan; W/41 3/4" Belt O.C.	4M6291	♣9415HD	3408 (67U)		
Belt - Fan; W/45 3/8" Belt O.C.	9L1740	②♣9451HD	Belt - Fan		③TR22648
Belt - Fan; W/1/2" Belt T.W.; W/52 1/4" Belt O.C.	9L894	②♣9520HD	Hose - Upper		26529
Belt - Fan; W/3/4" Belt T.W.; W/52 1/4" Belt O.C.	3H9862		Hose - Lower - Eng. To Pipe		24456
Belt - Fan; W/58 1/4" Belt O.C.	7L5001	②TR24515	Hose - Lower - Pipe To Rad.		24456
Belt - Fan; W/58 3/4" Belt O.C.	9L304	♣9580HD	3412 (38S)		
Belt - W.P.; W/54 1/4" Belt O.C.	9L1731	②TR24578	Hose - Upper		26529
Belt - W.P.; W/60 1/4" Belt O.C.	9L1105	②♣9540HD	Hose - Lower		24264
Belt - Alt.; W/57 1/4" Belt O.C.	9L1128	②♣9600HD		or	24460
Belt - Alt.; W/62 1/4" Belt O.C.	9L1183	②♣9570HD	3412 Generator		
Belt - Alt.; W/64 1/4" Belt O.C.	9L1213	②♣9620HD	Hose - Upper		≈<20760
Belt - Alt.; W/67 1/4" Belt O.C.	9L1130	②♣9640HD	D311		
Belt - Alt. & Compr.; W/52 1/4" Belt O.C.	9L894	②♣9670HD	Hose - Upper; Ser. No. 4H3269 To 4H4000; W/4L6512 Rad.		26532
Belt - Alt. & Compr.; W/55 1/4" Belt O.C.	9L1553	②♣9520HD	Hose - Lower; Ser. No. 4H3269 To 4H4000; W/3L3877 Rad.		24432
Belt - Gen.; W/39 1/4" Belt O.C.	5B7168	②♣9550HD	Hose - Lower; Ser. No. 4H3269 To 4H4000; W/4L6512 Rad.		24432
Belt - Gen.; W/40 1/4" Belt O.C.	3L6309	♣9390HD	D311 (4V)		
Belt - Gen.; W/41 3/4" Belt O.C.	4M6291	♣9400HD	Belt - W.P.; W/49" Belt O.C.	5F7676	TR30484
Belt - Compr.; W/O Kenworth Compr.	9L1502	♣9415HD	Belt - W.P.; W/64" Belt O.C.	8B4881	TR24638
Belt - Compr.; W/Kenworth Compr.	9L2266	②♣9313HD	Belt - Alt.	5B7168	♣9390HD
1676			Belt - Gen.; W/44 1/4" Belt O.C.	3H3897	②♣9440HD
Belt - Fan	9L1128	③♣9570HD	Belt - Gen.; W/50 1/4" Belt O.C.	6F1992	②♣9500HD
Belt - Alt.; W/36 1/4" Belt O.C.	7B7973	♣9360HD	Belt - Gen.; W/60 1/4" Belt O.C.		②♣9600HD
Belt - Alt.; W/46 1/2" Belt O.C.	9M1091	♣9463HD	Belt - Starter	6B5653	TR24438
Belt - Alt.; W/47 7/8" Belt O.C.	6L3408	②♣9476HD	D311 (7S)		
Belt - Gen.; W/50 1/4" Belt O.C.	9L2057	♣9500HD	Belt - W.P.	5F7676	TR30484
Belt - A.C.	9L2248	♣9480HD	Belt - Alt.	5B7168	♣9390HD
1693			Belt - Starter	6B5653	TR24438
Belt - Fan; W/70 1/2" Belt O.C.	9L2215	③♣9700HD	D311 (51B)		
Belt - Fan; W/74 1/4" Belt O.C.	9L1629	③♣9740HD	Belt - Fan	3L9717	②TR24489
Belt - Gen.	9L1582	♣9463HD	Belt - Fan & Alt.	5L4660	TR24489
3145 (65P)			Belt - W.P.	3L5751	TR24500
Belt - W.P. & Alt.	3N1491	②♣9510HD	Belt - Alt.	5L3834	②♣9440HD
Belt - Alt.	2N1434	②♣9510HD	Belt - Gen.; W/39 1/4" Belt O.C.	5B7168	♣9390HD
Belt - Compr. & Idler; W/54 1/4" Belt O.C.	9L1732	②♣9540HD	Belt - Gen.; W/40 1/4" Belt O.C.	3L6309	♣9400HD
Belt - Compr. & Idler; W/55 1/4" Belt O.C.	9L1557	②♣9550HD	Belt - Gen.; W/41 3/4" Belt O.C.	4M6291	♣9415HD
3150 (97M)			Belt - Gen.; W/43" Belt O.C.	5L3337	TR24424
Belt - Fan & Alt.; W/51 1/4" Belt O.C.	3N1491	②♣9510HD	Belt - Gen.; W/44 1/4" Belt O.C.	5L3834	②♣9440HD
Belt - Fan & Alt.; W/52 1/4" Belt O.C.	3S8447	②♣9520HD	Belt - Gen.; W/57 1/4" Belt O.C.	2L5345	②♣9570HD
Belt - Alt.	2N1434	②♣9510HD	Belt - Gen.; W/60 1/4" Belt O.C.	2L4855	②♣9600HD
Belt - Compr.; W/Low Mount Fan	9L1732	②♣9540HD	Belt - Compr.	5L1584	TR24449
Belt - Compr.; W/High Mount Fan	9L1557	②♣9550HD	Belt - Starter	4B5738	TR24400
3208 (79V)			D315 (4V)		
Belt - Fan & Alt.	2P5617	②♣9700HD	Belt - W.P.	4F7956	TR34506
Belt - W.P. & Idler	3P130	②♣9500HD	Belt - Alt.	5B7168	♣9390HD
Belt - W.P., Air Brake Compr. & Idler	4N2745	♣9600HD	Belt - Gen.	2L5730	②♣9580HD
3304 (2B)			Belt - Starter	6B5653	TR24438
Belt - Fan & Alt.; W/54 1/4" Belt O.C.		③♣9540HD	D315 (9S)		
Hose - Lower - Eng. To Pipe		24440	Belt - W.P.	4F7956	TR34506
Hose - Lower - Pipe To Rad.		24440	Belt - Alt.	5B7168	♣9390HD
3304 (66D); 3306 (2B)			Belt - Gen.; W/Centrifugal W.P.	1H9348	③♣9480HD
Hose - Lower - Eng. To Pipe		24440	Belt - Gen.; W/O Centrifugal W.P.	2L5730	②♣9580HD
Hose - Lower - Pipe To Rad.		24440	Belt - Starter	6B5653	TR24438
3306 (66D)			D315 (48B); D315 (52B)		
Belt - Fan		③♣9540HD	Belt - W.P.; W/51" Belt O.C.	4F7956	TR34506
Hose - Lower - Eng. To Pipe		24440	Belt - W.P.; W/67" Belt O.C.		TR24664
Hose - Lower - Pipe To Rad.		24440			

③Three Required.
②Two Required.

♣Standard Belt Available.
≈<Cut to Fit.

Belts and Coolant Hose for Power Units

Application	Mfr. Part No.	Our No.	Application	Mfr. Part No.	Our No.
Caterpillar - Continued			Caterpillar - Continued		
D315 (48B); D315 (52B) - Continued			D326 (39B)		
Belt - Gen.; W/67 1/8" Belt O.C.		②TR24664	Belt - Gen.; W/36" Belt O.C.	1L6557	TR24355
Belt - Gen.; Conversion	2L5730	②▲9580HD	Belt - Gen.; W/66 1/4" Belt O.C.	2L6332	②▲9660HD
Belt - Starter	6B5653	TR24438	Belt - Gen.; W/82 1/2" Belt O.C.	3L9489	②C78
Belt - Compr.	8F2434	TR24500	D326F (25B)		
D315C (4V)			Belt - Fan; W/58 3/4" Belt O.C.		
Belt - W.P.	4F7956	TR34506		8F5164	②TR30589
Belt - Alt.	5B7168	▲9390HD	D326F (39B)		
Belt - Gen.	2L5730	②▲9580HD	Belt - Gen.; W/36" Belt O.C.		
Belt - Starter	6B5653	TR24438		1L6557	TR24355
D315C (9S)			Belt - Gen.; W/66 1/4" Belt O.C.		
Belt - W.P.	4F7956	TR34506		2L6332	②▲9660HD
Belt - Alt.	5B7168	▲9390HD	Belt - Gen.; W/82 1/2" Belt O.C.		
Belt - Gen.; W/Centrifugal W.P.	1H9348	③▲9480HD		3L9489	②C78
Belt - Gen.; W/O Centrifugal W.P.	2L5730	②▲9580HD	D330 (2B); D330 (4B); D330 (5B)		
Belt - Starter	6B5653	TR24438	Belt - Fan; W/52 1/4" Belt O.C.		
D315C (48B); D315C (52B)				9L894	③▲9520HD
Belt - W.P.; W/51" Belt O.C.	4F7956	TR34506	Belt - Fan; W/54 1/4" Belt O.C.		
Belt - W.P.; W/67" Belt O.C.		TR24664		5L8312	③▲9540HD
Belt - Gen.; W/67 1/8" Belt O.C.		②TR24664	Belt - Alt.; W/37 3/4" Belt O.C.		
Belt - Gen.; Conversion	2L5730	②▲9580HD		5L3979	②▲9375HD
Belt - Starter	6B5653	TR24438	Belt - Alt.; W/39 1/4" Belt O.C.		
Belt - Compr.	8F2434	TR24500		5B7168	▲9390HD
D318			Belt - Alt.; W/44 1/4" Belt O.C.		
Hose - Upper; Ser. No. 5V5001 & After		24432		7L2449	▲9440HD
D318 (3V); D318 (5V); D318 (6V)			Belt - Alt.; W/44 7/8" Belt O.C.		
Belt - Alt.	5B7168	▲9390HD		9L677	②▲9447HD
Belt - Gen.; W/48 15/32" Belt O.C.	1H9348	③▲9480HD	Belt - Alt.; W/47 7/8" Belt O.C.		
Belt - Gen.; W/58 3/8" Belt O.C.	2L5730	②▲9580HD		8L8982	②▲9476HD
Belt - Gov.	4B2544	▲9425HD	Belt - Alt.; W/49 1/4" Belt O.C.		
Belt - Starter	6B2746	TR24489		9L4091	②▲9490HD
D318 (45B)			Belt - Gen.; W/50 1/4" Belt O.C.		
Belt - Gen.; Conversion	2L5730	②▲9580HD		5M8137	▲9500HD
Belt - Compr.	8F2434	TR24500	Belt - Gen.; W/56 1/4" Belt O.C.		
D318 (53B)				3S3964	▲9560HD
Belt - Gen.		②TR24664	D330 (56B)		
D318G (3V); D318G (5V); D318G (6V)			Belt - Fan; W/41 3/4" Belt O.C.		
Belt - Alt.	5B7168	▲9390HD		4M6291	▲9415HD
Belt - Gen.; W/48 15/32" Belt O.C.	1H9348	③▲9480HD	Belt - Fan; W/49 5/8" Belt O.C.		
Belt - Gen.; W/58 3/8" Belt O.C.	2L5730	②▲9580HD		3L9717	②TR24489
Belt - Gov.	4B2544	▲9425HD	Belt - Fan; W/52 1/4" Belt O.C.		
Belt - Starter	6B2746	TR24489		9L894	②▲9520HD
D319G (45B)			Belt - Gen.; W/39 1/4" Belt O.C.		
Belt - Gen.; Conversion	2L5730	②▲9580HD		5B7168	▲9390HD
Belt - Compr.	8F2434	TR24500	Belt - Alt.; W/44 1/4" Belt O.C.		
D319G (53B)				7L2449	▲9440HD
Belt - Gen.		②TR24664	Belt - Alt.; W/44 7/8" Belt O.C.		
D320 (63B)				9L677	②▲9447HD
Belt - Fan	3L9717	②TR24489	Belt - Alt.; W/47 7/8" Belt O.C.		
Belt - W.P.; W/50 3/4" Belt O.C.	3L5751	TR24500		8L8982	②▲9476HD
Belt - Alt.; W/44 1/4" Belt O.C.	5L3834	②▲9440HD	Belt - Alt.; W/49 1/4" Belt O.C.		
Belt - Alt.; W/57 1/4" Belt O.C.	9L1128	②▲9570HD		9L4091	②▲9490HD
Belt - Gen.; W/39 1/4" Belt O.C.	5B7168	▲9390HD	Belt - Gen.; W/50 1/4" Belt O.C.		
Belt - Gen.; W/40 1/4" Belt O.C.	3L6309	▲9400HD		5M8137	▲9500HD
Belt - Gen.; W/41 3/4" Belt O.C.	4M6291	▲9415HD	Belt - Gen.; W/56 1/4" Belt O.C.		
Belt - Gen.; W/44 1/4" Belt O.C.	5L3834	②▲9440HD		3S3964	▲9560HD
Belt - Gen.; W/45 3/8" Belt O.C.	9L1739	②▲9451HD	D330A (2B); D330A (4B); D330A (5B)		
Belt - Gen.; Conversion	2L5730	②▲9580HD	Belt - Fan; W/52 1/4" Belt O.C.		
Belt - Compr.	5L1584	TR24449		9L894	③▲9520HD
D326 (25B)			Belt - Fan; W/54 1/4" Belt O.C.		
Belt - Fan; W/58 3/4" Belt O.C.	8F5164	②TR30589		5L8312	③▲9540HD

▲Standard Belt Available.
③Three Required.

②Two Required.

Belts and Coolant Hose for Power Units

Application	Mfr. Part No.	Our No.	Application	Mfr. Part No.	Our No.
Caterpillar - Continued			Caterpillar - Continued		
D330A (85B) - Continued			D333A (58B) - Continued		
Belt - Gen.; W/O Expansion Tank	4B2544	♣9425HD	Belt - Gen.; W/41 3/4" Belt O.C.	4M6291	♣9415HD
D333 (23C)			D333A (59B)		
Belt - Fan; W/52 1/4" Belt O.C.	9L894	♣9520HD	Belt - Gen.; W/40 1/4" Belt O.C.	3L6309	♣9400HD
Belt - Fan; W/53 1/4" Belt O.C.	3S6272	♣9530HD	Belt - Gen.; W/41 3/4" Belt O.C.	4M6291	♣9415HD
Belt - Fan; W/54 1/4" Belt O.C.	5L8312	♣9540HD	Belt - Gen.; W/43" Belt O.C.	5L3337	TR24424
Belt - Alt.; W/37 1/4" Belt O.C.	5L3979	♣9375HD	Belt - Gen.; W/44 1/4" Belt O.C.	5L3834	♣9440HD
Belt - Alt.; W/39 1/4" Belt O.C.	5B7168	♣9390HD	Belt - Gen.; W/53 1/4" Belt O.C.	5L3307	♣9530HD
Belt - Alt.; W/44 1/4" Belt O.C.	7L2449	♣9440HD	D333A (66D); D333A (67D)		
Belt - Alt.; W/44 7/8" Belt O.C.	9L677	♣9447HD	Belt - Fan; W/52 1/4" Belt O.C.	9L894	♣9520HD
Belt - Alt.; W/47 7/8" Belt O.C.	8L8982	♣9476HD	Belt - Fan; W/53 1/4" Belt O.C.	3S6272	♣9530HD
Belt - Alt.; W/49 1/4" Belt O.C.	9L4091	♣9490HD	Belt - Fan; W/54 1/4" Belt O.C.	5L8312	♣9540HD
Belt - Alt.; W/51 1/4" Belt O.C.	5M8137	♣9510HD	Belt - Alt.; W/37 1/4" Belt O.C.	5L3979	♣9375HD
Belt - Gen.	3S3964	♣9560HD	Belt - Alt.; W/39 1/4" Belt O.C.	5B7168	♣9390HD
D333 (58B)			Belt - Alt.; W/44 1/4" Belt O.C.	7L2449	♣9440HD
Belt - Fan		♣TR24489	Belt - Alt.; W/44 7/8" Belt O.C.	9L677	♣9447HD
Belt - Gen.; W/39 1/4" Belt O.C.	5B7168	♣9390HD	Belt - Alt.; W/47 7/8" Belt O.C.	8L8982	♣9476HD
Belt - Gen.; W/41 3/4" Belt O.C.	4M6291	♣9415HD	Belt - Alt.; W/49 1/4" Belt O.C.	9L4091	♣9490HD
D333 (59B)			Belt - Alt.; W/51 1/4" Belt O.C.	5M8137	♣9510HD
Belt - Gen.; W/40 1/4" Belt O.C.	3L6309	♣9400HD	Belt - Gen.	3S3964	♣9560HD
Belt - Gen.; W/41 3/4" Belt O.C.	4M6291	♣9415HD	D333A (79B)		
Belt - Gen.; W/43" Belt O.C.	5L3337	TR24424	Belt - Alt./Gen.; W/Expansion Tank	5B7168	♣9390HD
Belt - Gen.; W/44 1/4" Belt O.C.	5L3834	♣9440HD	Belt - Alt./Gen.; W/O Expansion Tank	4B2544	♣9425HD
Belt - Gen.; W/53 1/4" Belt O.C.	5L3307	♣9530HD	D333A (79C)		
D333 (66D); D333 (67D)			Belt - Fan & W.P.	5F7676	TR30484
Belt - Fan; W/52 1/4" Belt O.C.	9L894	♣9520HD	D333A (80B)		
Belt - Fan; W/53 1/4" Belt O.C.	3S6272	♣9530HD	Belt - Alt.	5L3826	♣9440HD
Belt - Fan; W/54 1/4" Belt O.C.	5L8312	♣9540HD	Belt - Gen.	5L3337	TR24424
Belt - Alt.; W/37 1/4" Belt O.C.	5L3979	♣9375HD	D333A (87B)		
Belt - Alt.; W/39 1/4" Belt O.C.	5B7168	♣9390HD	Belt - Fan & Idler	5L4660	♣TR24489
Belt - Alt.; W/44 1/4" Belt O.C.	7L2449	♣9440HD	Belt - Alt.	7L4528	♣7400
Belt - Alt.; W/44 7/8" Belt O.C.	9L677	♣9447HD	Belt - Gen.; W/Expansion Tank	5B7168	♣9390HD
Belt - Alt.; W/47 7/8" Belt O.C.	8L8982	♣9476HD	Belt - Gen.; W/O Expansion Tank	4B2544	♣9425HD
Belt - Alt.; W/49 1/4" Belt O.C.	9L4091	♣9490HD	D334 (92B)		
Belt - Alt.; W/51 1/4" Belt O.C.	5M8137	♣9510HD	Belt - Fan	6L3294	♣9650HD
Belt - Gen.	3S3964	♣9560HD	Belt - W.P.	9L1731	♣9540HD
D333 (79B)			Belt - Alt.	5L3337	TR24424
Belt - Alt./Gen.; W/Expansion Tank	5B7168	♣9390HD	D334 (93B)		
Belt - Alt./Gen.; W/O Expansion Tank	4B2544	♣9425HD	Belt - Alt.; W/47 7/8" Belt O.C.	6L3408	♣9476HD
D333 (79C)			Belt - Alt.; W/49 1/4" Belt O.C.	9L4091	♣9490HD
Belt - Fan & W.P.	5F7676	TR30484	D337F (37B)		
D333 (80B)			Belt - Gen.; W/36" Belt O.C.	1L6557	TR24355
Belt - Alt.	5L3826	♣9440HD	D339 (34B)		
Belt - Gen.	5L3337	TR24424	Belt - Fan	1L5681	♣TR30652
D333 (87B)			Belt - Gen.	1L6557	♣TR24355
Belt - Fan & Idler	5L4660	♣TR24489	D342 (5A)		
Belt - Alt.	7L4528	♣7400	Belt - Fan; Ser. No. 5A8403 To 5A8462	5L5015	♣TR30672
Belt - Gen.; W/Expansion Tank	5B7168	♣9390HD	Belt - Alt.; Ser. No. 5A8403 To 5A8462	1N8405	♣7365
Belt - Gen.; W/O Expansion Tank	4B2544	♣9425HD	D342 (31B); D342 (49B)		
D333A (23C)			Belt - Fan; W/63 3/4" Belt O.C.	6B8536	TR28628
Belt - Fan; W/52 1/4" Belt O.C.	9L894	♣9520HD	Belt - Fan; W/65 1/2" Belt O.C.	1L5681	♣TR30652
Belt - Fan; W/53 1/4" Belt O.C.	3S6272	♣9530HD	Belt - Fan; W/77 1/8" Belt O.C.	1H6929	♣TR30770
Belt - Fan; W/54 1/4" Belt O.C.	5L8312	♣9540HD	Belt - Alt.		♣7365
Belt - Alt.; W/37 1/4" Belt O.C.	5L3979	♣9375HD	Belt - Gen.	1L6557	TR24355
Belt - Alt.; W/39 1/4" Belt O.C.	5B7168	♣9390HD	D342 (71B)		
Belt - Alt.; W/44 1/4" Belt O.C.	7L2449	♣9440HD	Belt - Fan	2M8183	♣TR30672
Belt - Alt.; W/44 7/8" Belt O.C.	9L677	♣9447HD	D342C (5A)		
Belt - Alt.; W/47 7/8" Belt O.C.	8L8982	♣9476HD	Belt - Fan; Ser. No. 5A8403 To 5A8462	5L5015	♣TR30672
Belt - Alt.; W/49 1/4" Belt O.C.	9L4091	♣9490HD	Belt - Alt.; Ser. No. 5A8403 To 5A8462	1N8405	♣7365
Belt - Alt.; W/51 1/4" Belt O.C.	5M8137	♣9510HD	D342C (31B); D342C (49B)		
Belt - Gen.	3S3964	♣9560HD	Belt - Fan; W/63 3/4" Belt O.C.	6B8536	TR28628
D333A (58B)					
Belt - Fan		♣TR24489			
Belt - Gen.; W/39 1/4" Belt O.C.	5B7168	♣9390HD			

♣Standard Belt Available.
 ♣Two Required.

♣Three Required.

Power Units

Belts and Coolant Hose for Power Units

Application	Mfr. Part No.	Our No.	Application	Mfr. Part No.	Our No.
Caterpillar - Continued			Caterpillar - Continued		
D342C (31B); D342C (49B) - Continued			D398 (66B) - Continued		
Belt - Fan; W/65 1/2" Belt O.C.	1L5681	②TR30652	Belt - Gen.; W/40 1/4" Belt O.C.	3L6309	♣9400HD
Belt - Fan; W/77 1/8" Belt O.C.	1H6929	②TR30770	Belt - Gen.; W/43" Belt O.C.	5L3337	TR24424
Belt - Alt.		②7365	D398 (75B)		
Belt - Gen.	1L6557	TR24355	Belt - Gen.; W/40 1/4" Belt O.C.	3L6309	♣9400HD
D342C (71B)			Belt - Gen.; W/43" Belt O.C.	5L3337	TR24424
Belt - Fan	2M8183	②TR30672	D399 (91B)		
D343 (33B)			Belt - Alt.	5L3979	②♣9375HD
Belt - Alt.; W/47 7/8" Belt O.C.	6L3408	♣9476HD	D1402		
Belt - Alt.; W/50 3/4" Belt O.C.	5L4996	②♣9505HD	Belt - Fan & Alt.	REMF1420	7420
Belt - Alt.; W/55 1/4" Belt O.C.	6L4394	②♣9550HD	D3400 (1T)		
Belt - Gen.; W/44 1/4" Belt O.C.	5L3834	♣9440HD	Belt - W.P.	5B8473	③TR24515
Belt - Gen.; W/48 1/4" Belt O.C.	9L2248	♣9480HD	Belt - Alt.	5B7168	♣9390HD
D343 (62B)			Belt - Starter	6B5653	③TR24438
Belt - Fan; W/56 1/2" Belt O.C.	4L4648	②TR24562	D3400 (3R)		
Belt - Fan; W/58 3/4" Belt O.C.	6L9903	③TR24578	Belt - Fan; W/71 1/2" Belt O.C.	5L5656	TR30710
Belt - Alt.	6L3408	♣9476HD	Belt - Fan; W/72 5/8" Belt O.C.	7B344	②CX68
D346 (39J)			Belt - W.P.; W/52 1/4" Belt O.C.	5B8473	③TR24515
Belt - Alt.	1N9310	②7500	Belt - Alt.	5B7168	♣9390HD
D346 (40J)			Belt - Starter; Ser. No. 3R6001 Thru 3R7000	6B5653	TR24438
Belt - Alt.	7L5091	②7490	Belt - Starter; Ser. No. 3R7001 Thru 3R7532	6B2746	TR24489
D346 (77F)			D3400 (3S)		
Belt - Fan; Ser. No. 77F1 Thru 77F246	2H1383	③TR30672	Belt - Fan; W/72 5/8" Belt O.C.	7B344	②CX68
Belt - W.P.	4M6292	TR24619	Belt - Fan; W/77 1/8" Belt O.C.	7H9806	②TR30770
D353 (46B); D353 (77B); D353C (46B); D353C (77B)			Belt - W.P.; W/52 1/4" Belt O.C.	5B8473	③TR24515
Belt - Fan; W/75 1/2" Belt O.C.	2M8255	②TR30754	Belt - W.P.; W/85 5/8" Belt O.C.	8B9947	CX81
Belt - Fan; W/81 1/8" Belt O.C.	3L6052	②TR30808	Belt - Alt.	5B7168	♣9390HD
Belt - Fan; W/85 5/8" Belt O.C.	5H7371	②CX81	Belt - Gen.; W/63 3/4" Belt O.C.	6B8536	TR28628
Belt - Alt.	8M1715	TR24664	D3400 (9J)		
D364 (19B); D364 (21B)			Belt - Gen.	6B8536	TR28628
Belt - Gov.	3L3853	♣9341HD	D4400 (1S); D4400 (3R); D4400 (5S); D4400 (6S); D4600 (1S); D4600 (3R); D4600 (5S); D4600 (6S)		
Belt - Starter	5B8473	③TR24515	Belt - W.P.; W/49 3/4" Belt O.C.	7B4032	TR34495
D375			Belt - W.P.; W/58 3/4" Belt O.C.	4B8598	TR24578
Hose - Lower; Ser. No. 16B238 & After		24464	Belt - W.P.; W/64 1/8" Belt O.C.	8B4881	TR24638
D375 (16B); D375 (18B)			Belt - Alt.; W/39 1/2" Belt O.C.	5B7168	♣9390HD
Belt - Starter	5B8473	③TR24515	Belt - Alt.; W/71 1/2" Belt O.C.	5L5656	TR30710
D375 (43B)			Belt - Gen. & V.P.	8B5457	②♣9313HD
Belt - Gov.	3L3853	♣9341HD	Belt - Starter; W/43 7/8" Belt O.C.	6B5653	TR24438
D375D (16B); D375D (18B)			Belt - Starter; W/49 5/8" Belt O.C.	6B2746	TR24489
Belt - Starter	5B8473	③TR24515	D8800 (3V)		
D375D (43B)			Belt - Fan & W.P.	4F7956	TR34506
Belt - Gov.	3L3853	♣9341HD	D13000		
D379 (68B); D379 (76B)			Hose - Upper; Ser. No. 1N9001 To 1N9999		24432
Belt - Gen.; W/40 1/4" Belt O.C.	3L6309	♣9400HD	Hose - Upper; Ser. No. 3R7001 To 3R9999		24432
Belt - Gen.; W/43" Belt O.C.	5L3337	TR24424	Hose - Upper; Ser. No. 3S2001 To 3S7000		24432
Belt - Fan	4M5413	TR30710	Hose - Lower; Ser. No. 1N9001 To 1N9999		24226
D386 (10B); D386 (12B); D386 (15B)			Hose - Lower; Ser. No. 3R7001 To 3R9999		24226
Belt - Fan; W/71 1/2" Belt O.C.	4M5413	TR30710	Hose - Lower; Ser. No. 3S2001 To 3S7000		24226
Belt - Gov.	3L3853	♣9341HD	D13000 (1N)		
Belt - Starter	5B8473	TR24515	Belt - Fan; W/71 1/2" Belt O.C.	7M4709	TR30710
D397			Belt - Fan; W/72 5/8" Belt O.C.	7B344	②CX68
Hose - Lower; Ser. No. 12B221 To 12B399		24464	D13000 (2V)		
D397 (10B); D397 (12B); D397 (15B); D397D (10B); D397D (12B); D397D (15B)			Belt - Fan; W/71 1/2" Belt O.C.	7M4709	TR30710
Belt - Fan; W/71 1/2" Belt O.C.	4M5413	TR30710	D13000 (3R); D13000 (3S); D13000 (4S)		
Belt - Gov.	3L3853	♣9341HD	Belt - Fan; W/71 1/2" Belt O.C.	7M4709	TR30710
Belt - Starter	5B8473	TR24515	Belt - Fan; W/72 5/8" Belt O.C.	7B344	②CX68
D398 (66B)			Belt - Fan; W/77 1/8" Belt O.C.	7H9806	②TR30770
Belt - Alt.	5L3979	♣9375HD	Belt - Starter	6B2746	TR24489

②Two Required.
③Three Required.

♣Standard Belt Available.

Power Units

Belts and Coolant Hose for Power Units

Application	Mfr. Part No.	Our No.	Application	Mfr. Part No.	Our No.
Caterpillar - Continued			Cummins - Continued		
D17000			C-160-B - Continued		
Hose - Upper; Ser. No. 9J5214 To 9J6000; W/4F6354 Rad.		24440	Belt - Alt.; W/2500 R.P.M.	178685	TR22485
Hose - Upper; Ser. No. 3S1 To 3S2000; W/4F6354 Rad. .		24440	Belt - Alt.; Auto.; W/2800 R.P.M.	178601	TR22534
D17000 (2V); D17000 (3S); D17000 (8S)			C-160-BI; C-160-CI		
Belt - Fan; W/71 1/2" Belt O.C.	7M4709	TR30710	Belt - Fan; Auto.; W/O 2800 R.P.M.	124466	②TR24365
Belt - W.P.; W/Aux. W.P.	8B9947	CX81	Belt - Fan; Auto.; W/2800 R.P.M.	178539	②TR22363
Belt - Gen.; W/63 3/4" Belt O.C.	6B8536	TR28628	Belt - W.P.; Auto.	178455	TR22299
Belt - Starter	6B2746	TR24489	Belt - Gen.	70885	TR22495
S135 (4V)			Belt - Alt.; W/2500 R.P.M.	178685	TR22485
Belt - W.P.	4F7956	TR34506	C-160-IP		
Belt - Alt.	5B7168	♣9390HD	Belt - Fan	178530	②TR22358
Belt - Gen.	2L5730	②♣9580HD	Belt - W.P.	178490	TR22329
Belt - Starter	6B5653	TR24438	Belt - Alt.	178470	TR22474
S318 (3V)			C-175-B; C-175-BI; C-175-CI		
Belt - Fan & W.P.	4F7956	TR34506	Belt - Fan	178530	②TR22358
Belt - Gen.	2L5730	②♣9580HD	Belt - W.P.; W/30 3/4" Belt O.C.	178455	TR22299
Belt - Gov.	4B2544	♣9425HD	Belt - W.P.; W/34 1/4" Belt O.C.	178488	TR22336
Cummins			Belt - W.P.; W/35 5/8" Belt O.C.	178567	TR22350
6CTA 8.3 L GST			Belt - Alt.; Auto.	178685	TR22485
Hose - Upper - Eng. To Pipe		24436	C-175-IP		
Hose - Upper - Pipe To Rad.		24436	Belt - Fan	178530	②TR22358
Hose - Lower - Eng. To Pipe		24432	Belt - W.P.; W/30 3/4" Belt O.C.	178455	TR22299
Hose - Lower - Pipe To Rad.		24432	Belt - W.P.; W/34 1/4" Belt O.C.	178488	TR22336
65BT61; 80BT61; 85BT61; 100BT62			Belt - W.P.; W/35 5/8" Belt O.C.	178567	TR22350
Belt - Fan & Alt.	3911560	♣K080550HD	Belt - Alt.	178490	TR22329
150CTA61; 175CTA62			C-180		
Belt - Fan & Alt.	3911573	♣K080615HD	Belt - Fan	178530	②TR22358
Belt - Alt.	3911560	♣K080550HD	Belt - Alt.	178470	TR22474
Hose - Lower; W/Cummins 6Cla8.3G Eng.		21901	C-180-B; C-180-BI		
220NT5; 250NT5; 275NTA2; 300NTA2; 310NTA3; 350NTA3			Belt - Fan	178530	②TR22358
Belt - Fan	5110160	②TR28412	Belt - Gen.; Auto.	70885	TR22495
Belt - Alt.; W/35A. Alt.	5110084	♣9470HD	Belt - Alt.	178470	TR22474
Belt - Alt.; W/75A. Alt.	5110156	②♣9463HD	C-180-CI		
620KTA31; 660KTA32; 750KTA31; 800KTA32; 800KTA33; 900KTA33			Belt - Fan	178530	②TR22358
Belt - Alt.; W/35A. Alt.	511016102	♣K050345HD	Belt - Gen.	70184	2270
C-90-B; C-90-BI			Belt - Alt.	178470	TR22474
Belt - Fan & Gen.	132013	②TR22434	C-180-IP		
C-90-I; C-90-IP			Belt - Fan	178530	②TR22358
Belt - Fan & Gen.	124927	②TR22588	Belt - Alt.	178470	TR22474
C-105-B; C-105-BI			C-190		
Belt - Fan & Gen.	132013	②TR22434	Belt - Fan	124426	②TR24400
C-105-I; C-105-IP			Belt - W.P.; W/30 3/4" Belt O.C.	178455	TR22299
Belt - Fan & Gen.	124927	②TR22588	Belt - W.P.; W/34 1/4" Belt O.C.	178488	TR22336
C-140-B			Belt - W.P.; W/35 5/8" Belt O.C.	178567	TR22350
Belt - Fan & Gen.	132013	②TR22434	Belt - Alt.	178571	TR22434
C-145			C-464-B160		
Belt - W.P.	172856	②TR24457	Belt - Fan; Auto.; W/O 2800 R.P.M.	124466	②TR24365
Belt - Alt.	178387	TR22392	Belt - Fan; Auto.; W/2800 R.P.M.	178539	②TR22363
C-160			Belt - W.P.; Auto.	178455	TR22299
Belt - Fan; Auto.; W/2800 R.P.M.	178539	②TR24379	Belt - Gen.; Auto.	134778	TR22517
C-160-B			Belt - Alt.; Auto.; W/2500 R.P.M.	178470	TR22474
Belt - Fan; Auto.; W/O 2800 R.P.M.	124466	②TR24365	Belt - Alt.; W/2500 R.P.M.	178685	TR22485
Belt - Fan; Auto.; W/2800 R.P.M.	178539	②TR22363	Belt - Alt.; Auto.; W/2800 R.P.M.	178601	TR22534
Belt - W.P.; Auto.	178455	TR22299	C-464-C160		
Belt - Gen.; Auto.	134778	TR22517	Belt - Fan; Auto.; W/O 2800 R.P.M.	124466	②TR24365
Belt - Alt.; Auto.; W/2500 R.P.M.	178470	TR22474	Belt - Fan; Auto.; W/2800 R.P.M.	178539	②TR22363
C-160-BI			Belt - W.P.; Auto.	178455	TR22299
Belt - Fan; Auto.; W/O 2800 R.P.M.	124466	②TR24365	Belt - Alt.; W/2500 R.P.M.	178685	TR22485
Belt - Fan; Auto.; W/2800 R.P.M.	178539	②TR22363	Belt - Alt.; Auto.; W/2800 R.P.M.	178601	TR22534
Belt - W.P.; Auto.	178455	TR22299	C-464-P160		
Belt - Gen.; Auto.	134778	TR22517	Belt - Fan	178530	②TR22358
Belt - Alt.; Auto.; W/2500 R.P.M.	178470	TR22474	Belt - W.P.	178490	TR22329
C-160-BI			Belt - Alt.	178470	TR22474
Belt - Fan; Auto.; W/O 2800 R.P.M.	124466	②TR24365			
Belt - Fan; Auto.; W/2800 R.P.M.	178539	②TR22363			
Belt - W.P.; Auto.	178455	TR22299			
Belt - Gen.; Auto.	134778	TR22517			
Belt - Alt.; Auto.; W/2500 R.P.M.	178470	TR22474			

♣Standard Belt Available.

②Two Required.

Belts and Coolant Hose for Power Units

Application	Mfr. Part No.	Our No.	Application	Mfr. Part No.	Our No.
Cummins - Continued			Cummins - Continued		
CF-160			H-6-B - Continued		
Belt - Fan; Auto.; W/2800 R.P.M.	178539	②TR22363	Belt - Fan & W.P.; W/46 3/8" Belt O.C.	172856	②TR24457
CF-160-B			Belt - Gen.	70350	TR22358
Belt - Fan; Auto.; W/O 2800 R.P.M.	124466	②TR24365	Belt - V.P.; W/27" Belt O.C.	S2465	2270
Belt - Fan; Auto.; W/2800 R.P.M.	178539	②TR22363	Belt - V.P.; W/32 1/8" Belt O.C.	69311	♣9319HD
Belt - W.P.; Auto.	178455	TR22299	H-6-BI; H-6-CI		
Belt - Gen.; Auto.	134778	TR22517	Belt - Fan & W.P.; W/41 1/8" Belt O.C.	134773	②TR22405
Belt - Alt.; Auto.; W/2500 R.P.M.	178470	TR22474	Belt - Fan & W.P.; W/46 3/8" Belt O.C.	172856	②TR24457
Belt - Alt.; W/2500 R.P.M.	178685	TR22485	Belt - Gen.	70350	TR22358
Belt - Alt.; Auto.; W/2800 R.P.M.	178601	TR22534	Belt - Alt.	178556	TR22363
CR-160-CI			Belt - V.P.; W/27" Belt O.C.	S2465	2270
Belt - Fan	178530	②TR22358	Belt - V.P.; W/32 1/8" Belt O.C.	69311	♣9319HD
Belt - Gen.; Auto.	70885	TR22495	H-6-G		
Belt - Alt.	178470	TR22474	Belt - Fan & W.P.	70524	②TR22405
CS-195			Belt - Gen.	70350	TR22358
Belt - Fan	178530	②TR22358	H-6-I		
Belt - Alt.	178470	TR22474	Belt - Fan	178617	②TR30506
CS-195-B			Belt - Fan & W.P.; W/41 1/8" Belt O.C.	134773	②TR22405
Belt - Fan	178530	②TR22358	Belt - Fan & W.P.; W/46 3/8" Belt O.C.	172856	②TR24457
Belt - Gen.; Auto.	70885	TR22495	Belt - Gen.	70350	TR22358
Belt - Alt.	178470	TR22474	Belt - V.P.; W/27" Belt O.C.	S2465	2270
CS-195-CI			Belt - V.P.; W/32 1/8" Belt O.C.	69311	♣9319HD
Belt - Fan	178530	②TR22358	H-6-IF		
Belt - Alt.	178470	TR22474	Belt - Fan & W.P.; W/41 1/8" Belt O.C.	134773	②TR22405
CS-464-B180			Belt - Fan & W.P.; W/46 3/8" Belt O.C.	172856	②TR24457
Belt - Fan	178530	②TR22358	Belt - Gen.	134797	TR22410
Belt - Gen.; Auto.	70885	TR22495	H-6-IP; H-6-P		
Belt - Alt.	178470	TR22474	Belt - Fan & W.P.	70524	②TR22405
CS-464-C160			Belt - Gen.	70350	TR22358
Belt - Fan	178530	②TR22358	H-135-CI		
Belt - Alt.	178470	TR22474	Belt - W.P.	172856	TR24457
CS-464-C180			Belt - Alt.	178556	TR22363
Belt - Fan	178530	②TR22358	H-743-C		
Belt - Gen.; Auto.	70885	TR22495	Belt - Fan		②TR30506
Belt - Alt.	178470	TR22474	Belt - W.P.	178570	TR24400
CS-464-C195; CS-464-P180			Belt - Gen.	178567	TR22350
Belt - Fan	178530	②TR22358	H-743-L		
Belt - Alt.	178470	TR22474	Belt - Fan		②TR24457
CT-464-B175			Belt - Gen.	178436	TR22358
Belt - Fan	178530	②TR22358	HR-4-B; HR-4-BI		
Belt - W.P.; W/30 3/4" Belt O.C.	178455	TR22299	Belt - Fan & W.P.; W/41 1/8" Belt O.C.	134773	②TR22405
Belt - W.P.; W/34 1/4" Belt O.C.	178488	TR22336	Belt - Fan & W.P.; W/46 3/8" Belt O.C.	172856	②TR24457
Belt - W.P.; W/35 5/8" Belt O.C.	178567	TR22350	Belt - Gen.	70350	TR22358
Belt - Alt.; Auto.	178685	TR22485	Belt - V.P.; W/27" Belt O.C.	S2465	2270
CT-464-C175			Belt - V.P.; W/32 1/8" Belt O.C.	69311	♣9319HD
Belt - Fan	178530	②TR22358	HR-4-G		
Belt - W.P.; W/30 3/4" Belt O.C.	178455	TR22299	Belt - Fan	134817	②TR30506
Belt - W.P.; W/34 1/4" Belt O.C.	178488	TR22336	Belt - W.P.	132012	TR24400
Belt - W.P.; W/35 5/8" Belt O.C.	178567	TR22350	Belt - Gen.	178567	TR22350
Belt - Gen.	70885	TR22495	HR-4-I		
CT-464-P175			Belt - Fan & W.P.; W/41 1/8" Belt O.C.	134773	②TR22405
Belt - Fan	178530	②TR22358	Belt - Fan & W.P.; W/46 3/8" Belt O.C.	172856	②TR24457
Belt - W.P.; W/30 3/4" Belt O.C.	178455	TR22299	Belt - Gen.	70350	TR22358
Belt - W.P.; W/34 1/4" Belt O.C.	178488	TR22336	Belt - V.P.; W/27" Belt O.C.	S2465	2270
Belt - W.P.; W/35 5/8" Belt O.C.	178567	TR22350	Belt - V.P.; W/32 1/8" Belt O.C.	69311	♣9319HD
Belt - Alt.	178490	TR22329	HR-4-IP; HR-4-P		
CTA61; CTA62			Belt - Fan	134817	②TR30506
Belt - Fan & Alt.	3911573	♣K080615HD	Belt - W.P.	132012	TR24400
Belt - Alt.	3911560	♣K080550HD	Belt - Gen.	178567	TR22350
Hose - Lower; W/Cummins 6Cta8.3G Eng.		21901	HR-6-B; HR-6-BI; HR-6-CI		
H-6-B			Belt - Fan & W.P.; W/41 1/8" Belt O.C.	134773	②TR22405
Belt - Fan & W.P.; W/41 1/8" Belt O.C.	134773	②TR22405	Belt - Fan & W.P.; W/46 3/8" Belt O.C.	172856	②TR24457

②Two Required.

♣Standard Belt Available.

Power Units

Belts and Coolant Hose for Power Units

Application	Mfr. Part No.	Our No.	Application	Mfr. Part No.	Our No.
Cummins - Continued			Cummins - Continued		
HR-6-B; HR-6-BI; HR-6-CI - Continued			HRS-6-I		
Belt - Gen.	70350	TR22358	Belt - Fan & W.P.; W/41 1/8" Belt O.C.	134773	②TR22405
Belt - V.P.; W/27" Belt O.C.	S2465	2270	Belt - Fan & W.P.; W/46 3/8" Belt O.C.	172856	②TR24457
Belt - V.P.; W/32 1/8" Belt O.C.	69311	♣9319HD	Belt - Gen.	134797	TR22410
HR-6-G			HRS-6-IP; HRS-6-P		
Belt - Fan & W.P.	70524	②TR22405	Belt - Fan	134817	②TR30506
Belt - Gen.	70350	TR22358	Belt - W.P.	132012	TR24400
HR-6-I			Belt - Gen.	134797	TR22410
Belt - Fan & W.P.; W/41 1/8" Belt O.C.	134773	②TR22405	HS-6-B; HS-6-BI; HS-6-CI		
Belt - Fan & W.P.; W/46 3/8" Belt O.C.	172856	②TR24457	Belt - Fan & W.P.; W/41 1/8" Belt O.C.	134773	②TR22405
Belt - Gen.	70350	TR22358	Belt - Fan & W.P.; W/46 3/8" Belt O.C.	172856	②TR24457
Belt - V.P.; W/27" Belt O.C.	S2465	2270	Belt - Gen.	134797	TR22410
Belt - V.P.; W/32 1/8" Belt O.C.	69311	♣9319HD	HS-6-G		
HR-6-IP; HR-6-P			Belt - Fan	134817	②TR30506
Belt - Fan & W.P.	70524	②TR22405	Belt - W.P.	132012	TR24400
Belt - Gen.	70350	TR22358	Belt - Gen.	134797	TR22410
HRC-4-B; HRC-4-BI			HS-6-I		
Belt - Fan & W.P.; W/41 1/8" Belt O.C.	134773	②TR22405	Belt - Fan & W.P.; W/41 1/8" Belt O.C.	134773	②TR22405
Belt - Fan & W.P.; W/46 3/8" Belt O.C.	172856	②TR24457	Belt - Fan & W.P.; W/46 3/8" Belt O.C.	172856	②TR24457
Belt - Gen.	70350	TR22358	Belt - Gen.	134797	TR22410
Belt - V.P.; W/27" Belt O.C.	S2465	2270	HS-6-IP; HS-6-P		
Belt - V.P.; W/32 1/8" Belt O.C.	69311	♣9319HD	Belt - Fan	134817	②TR30506
HRC-4-G			Belt - W.P.	132012	TR24400
Belt - Fan	134817	②TR30506	Belt - Gen.	134797	TR22410
Belt - W.P.	132012	TR24400	J-4		
Belt - Gen.	178567	TR22350	Belt - Fan & Gen.; W/39 3/4" Belt O.C.	124928	②TR22392
HRC-4-I			Belt - Fan & Gen.; W/44 1/4" Belt O.C.	118637	②♣9440HD
Belt - Fan & W.P.; W/41 1/8" Belt O.C.	134773	②TR22405	Belt - Gen.	129592	②TR22344
Belt - Fan & W.P.; W/46 3/8" Belt O.C.	172856	②TR24457	Belt - Gen. & V.P.	106070	TR22474
Belt - Gen.	70350	TR22358	Belt - Compr. & Hyd. Pump	124929	6932
Belt - V.P.; W/27" Belt O.C.	S2465	2270	J-6		
Belt - V.P.; W/32 1/8" Belt O.C.	69311	♣9319HD	Belt - Gen.; W/45" Belt O.C.	101426	TR22443
HRC-4-IP; HRC-4-P			Belt - Gen.; W/48" Belt O.C.	178470	TR22474
Belt - Fan	134817	②TR30506	Belt - Gen.; W/50" Belt O.C.	70885	TR22495
Belt - W.P.	132012	TR24400	J-6-BI; J-6-CI		
Belt - Gen.	178567	TR22350	Belt - Fan; Auto.; W/O 130 H.P.; W/O 2800 R.P.M.	124466	②TR24365
HRF-6-B; HRF-6-BI; HRF-6-CI			Belt - Fan; Auto.; W/130 H.P.; W/2800 R.P.M.	178539	②TR22363
Belt - Fan & W.P.; W/41 1/8" Belt O.C.	134773	②TR22405	Belt - W.P.; Auto.	178455	TR22299
Belt - Fan & W.P.; W/46 3/8" Belt O.C.	172856	②TR24457	Belt - Gen.; W/45" Belt O.C.	101426	TR22443
Belt - Gen.	70350	TR22358	Belt - Gen.; W/48" Belt O.C.	178470	TR22474
Belt - V.P.; W/27" Belt O.C.	S2465	2270	Belt - Gen.; W/50" Belt O.C.	70885	TR22495
Belt - V.P.; W/32 1/8" Belt O.C.	69311	♣9319HD	Belt - Alt.; Auto.; W/130 H.P.; W/2800 R.P.M.	178470	TR22474
HRF-6-G			Belt - Alt.; Auto.; W/Turbo, Super Turbo	178685	TR22485
Belt - Fan & W.P.	70524	②TR22405	J-6-I		
Belt - Gen.	70350	TR22358	Belt - Fan	124421	TR24365
HRF-6-I			Belt - W.P.; W/33 1/2" Belt O.C.	178490	TR22329
Belt - Fan & W.P.; W/41 1/8" Belt O.C.	134773	②TR22405	Belt - W.P.; W/36 5/8" Belt O.C.	178530	②TR22358
Belt - Fan & W.P.; W/46 3/8" Belt O.C.	172856	②TR24457	Belt - Gen.; W/45" Belt O.C.	101426	TR22443
Belt - Gen.	70350	TR22358	Belt - Gen.; W/48" Belt O.C.	178470	TR22474
Belt - V.P.; W/27" Belt O.C.	S2465	2270	Belt - Gen.; W/50" Belt O.C.	70885	TR22495
Belt - V.P.; W/32 1/8" Belt O.C.	69311	♣9319HD	J-6-IP		
HRF-6-IP; HRF-6-P			Belt - Fan	124421	TR24365
Belt - Fan & W.P.	70524	②TR22405	Belt - W.P.; W/33 1/2" Belt O.C.	178490	TR22329
Belt - Gen.	70350	TR22358	Belt - W.P.; W/36 5/8" Belt O.C.	178530	②TR22358
HRS-6-B; HRS-6-BI; HRS-6-CI			Belt - Gen.; W/45" Belt O.C.	101426	TR22443
Belt - Fan & W.P.; W/41 1/8" Belt O.C.	134773	②TR22405	Belt - Gen.; W/48" Belt O.C.	178470	TR22474
Belt - Fan & W.P.; W/46 3/8" Belt O.C.	172856	②TR24457	Belt - Gen.; W/50" Belt O.C.	70885	TR22495
Belt - Gen.	134797	TR22410	Belt - Alt.; Auto.; W/Turbo, Super Turbo	178685	TR22485
HRS-6-G			J-6-P		
Belt - Fan	134817	②TR30506	Belt - Fan	124421	TR24365
Belt - W.P.	132012	TR24400	Belt - W.P.; W/33 1/2" Belt O.C.	178490	TR22329
Belt - Gen.	134797	TR22410			

♣Standard Belt Available.

②Two Required.

Belts and Coolant Hose for Power Units

Application	Mfr. Part No.	Our No.	Application	Mfr. Part No.	Our No.
Cummins - Continued			Cummins - Continued		
J-6-P - Continued			JN-6-IP		
Belt - W.P.; W/36 5/8" Belt O.C.	178530	②TR22358	Belt - Fan	124421	TR24365
Belt - Gen.; W/45" Belt O.C.	101426	TR22443	Belt - W.P.; W/33 1/2" Belt O.C.	178490	TR22329
Belt - Gen.; W/48" Belt O.C.	178470	TR22474	Belt - W.P.; W/36 5/8" Belt O.C.	178530	②TR22358
Belt - Gen.; W/50" Belt O.C.	70885	TR22495	Belt - Gen.; W/45" Belt O.C.	101426	TR22443
J-70-B; J-70-BI			Belt - Gen.; W/48" Belt O.C.	178470	TR22474
Belt - Fan & Gen.	132013	②TR22434	Belt - Gen.; W/50" Belt O.C.	70885	TR22495
J-70-I; J-70-IP			Belt - Alt.; Auto.; W/Turbo, Super Turbo	178685	TR22485
Belt - Fan & Gen.	124927	②TR22588	JN-6-P		
J-80-B; J-80-BI			Belt - Fan	124421	TR24365
Belt - Fan & Gen.	132013	②TR22434	Belt - W.P.; W/33 1/2" Belt O.C.	178490	TR22329
J-80-I; J-80-IP			Belt - W.P.; W/36 5/8" Belt O.C.	178530	②TR22358
Belt - Fan & Gen.	124927	②TR22588	Belt - Gen.; W/45" Belt O.C.	101426	TR22443
J-120-B			Belt - Gen.; W/48" Belt O.C.	178470	TR22474
Belt - Fan & Gen.	132013	②TR22434	Belt - Gen.; W/50" Belt O.C.	70885	TR22495
JF-6-B; JF-6-BI; JF-6-CI			JN-130; JNF-130		
Belt - Fan; Auto.; W/37 1/8" Belt O.C.	124466	②TR24365	Belt - Gen.; W/45" Belt O.C.	101426	TR22443
Belt - Fan; Auto.; W/36 7/8" Belt O.C.	178539	②TR22363	Belt - Gen.; W/48" Belt O.C.	178470	TR22474
Belt - W.P.; Auto.	178455	TR22299	Belt - Gen.; W/50" Belt O.C.	70885	TR22495
Belt - Gen.; W/45" Belt O.C.	101426	TR22443	JNR-6-BI		
Belt - Gen.; W/48" Belt O.C.	178470	TR22474	Belt - Fan; Auto.; W/37 1/8" Belt O.C.	124466	②TR24365
Belt - Gen.; W/50" Belt O.C.	70885	TR22495	Belt - Fan; Auto.; W/36 7/8" Belt O.C.	178539	②TR22363
Belt - Alt.; Auto.; W/O Turbo, Super Turbo ..	178470	TR22474	Belt - W.P.; Auto.	178455	TR22299
Belt - Alt.; Auto.; W/Turbo, Super Turbo	178685	TR22485	Belt - Gen.; W/45" Belt O.C.	101426	TR22443
JF-6-I			Belt - Gen.; W/48" Belt O.C.	178470	TR22474
Belt - Fan	124421	TR24365	Belt - Gen.; W/50" Belt O.C.	70885	TR22495
Belt - W.P.; W/33 1/2" Belt O.C.	178490	TR22329	Belt - Alt.; Auto.; W/O Turbo, Super Turbo ..	178470	TR22474
Belt - W.P.; W/36 5/8" Belt O.C.	178530	②TR22358	Belt - Alt.; Auto.; W/Turbo, Super Turbo	178685	TR22485
Belt - Gen.; W/45" Belt O.C.	101426	TR22443	JNR-100		
Belt - Gen.; W/48" Belt O.C.	178470	TR22474	Belt - Gen.; W/45" Belt O.C.	101426	TR22443
Belt - Gen.; W/50" Belt O.C.	70885	TR22495	Belt - Gen.; W/48" Belt O.C.	178470	TR22474
JF-6-IP			Belt - Gen.; W/50" Belt O.C.	70885	TR22495
Belt - Fan	124421	TR24365	JNS-6-B; JNS-6-BI; JNS-6-CI		
Belt - W.P.; W/33 1/2" Belt O.C.	178490	TR22329	Belt - Fan; Auto.; W/37 1/8" Belt O.C.	124466	②TR24365
Belt - W.P.; W/36 5/8" Belt O.C.	178530	②TR22358	Belt - Fan; Auto.; W/36 7/8" Belt O.C.	178539	②TR22363
Belt - Gen.; W/45" Belt O.C.	101426	TR22443	Belt - W.P.; Auto.	178455	TR22299
Belt - Gen.; W/48" Belt O.C.	178470	TR22474	Belt - Gen.; W/45" Belt O.C.	101426	TR22443
Belt - Gen.; W/50" Belt O.C.	70885	TR22495	Belt - Gen.; W/48" Belt O.C.	178470	TR22474
Belt - Alt.; Auto.; W/Turbo, Super Turbo	178685	TR22485	Belt - Gen.; W/50" Belt O.C.	70885	TR22495
JF-6-P			Belt - Alt.; Auto.; W/O Turbo, Super Turbo ..	178470	TR22474
Belt - Fan	124421	TR24365	Belt - Alt.; Auto.; W/Turbo, Super Turbo	178685	TR22485
Belt - W.P.; W/33 1/2" Belt O.C.	178490	TR22329	JNS-6-IP		
Belt - W.P.; W/36 5/8" Belt O.C.	178530	②TR22358	Belt - Fan	124421	TR24365
Belt - Gen.; W/45" Belt O.C.	101426	TR22443	Belt - W.P.; W/33 1/2" Belt O.C.	178490	TR22329
Belt - Gen.; W/48" Belt O.C.	178470	TR22474	Belt - W.P.; W/36 5/8" Belt O.C.	178530	②TR22358
Belt - Gen.; W/50" Belt O.C.	70885	TR22495	Belt - Gen.; W/45" Belt O.C.	101426	TR22443
JN-6-B; JN-6-BI; JN-6-CI			Belt - Gen.; W/48" Belt O.C.	178470	TR22474
Belt - Fan; Auto.; W/37 1/8" Belt O.C.	124466	②TR24365	Belt - Gen.; W/50" Belt O.C.	70885	TR22495
Belt - Fan; Auto.; W/36 7/8" Belt O.C.	178539	②TR22363	Belt - Alt.; Auto.; W/O Turbo, Super Turbo ..	178470	TR22474
Belt - W.P.; Auto.	178455	TR22299	Belt - Alt.; Auto.; W/Turbo, Super Turbo	178685	TR22485
Belt - Gen.; W/45" Belt O.C.	101426	TR22443	JNS-6-P		
Belt - Gen.; W/48" Belt O.C.	178470	TR22474	Belt - Fan	124421	TR24365
Belt - Gen.; W/50" Belt O.C.	70885	TR22495	Belt - W.P.; W/33 1/2" Belt O.C.	178490	TR22329
Belt - Alt.; Auto.; W/O Turbo, Super Turbo ..	178470	TR22474	Belt - W.P.; W/36 5/8" Belt O.C.	178530	②TR22358
Belt - Alt.; Auto.; W/Turbo, Super Turbo	178685	TR22485	Belt - Gen.; W/45" Belt O.C.	101426	TR22443
JN-6-I			Belt - Gen.; W/48" Belt O.C.	178470	TR22474
Belt - Fan	124421	TR24365	Belt - Gen.; W/50" Belt O.C.	70885	TR22495
Belt - W.P.; W/33 1/2" Belt O.C.	178490	TR22329	JS-6-B; JS-6-BI; JS-6-CI		
Belt - W.P.; W/36 5/8" Belt O.C.	178530	②TR22358	Belt - Fan; Auto.; W/37 1/8" Belt O.C.	124466	②TR24365
Belt - Gen.; W/45" Belt O.C.	101426	TR22443	Belt - Fan; Auto.; W/36 7/8" Belt O.C.	178539	②TR22363
Belt - Gen.; W/48" Belt O.C.	178470	TR22474	Belt - W.P.; Auto.	178455	TR22299
Belt - Gen.; W/50" Belt O.C.	70885	TR22495	Belt - Gen.; W/45" Belt O.C.	101426	TR22443
JN-6-I			Belt - Gen.; W/48" Belt O.C.	178470	TR22474
Belt - Fan	124421	TR24365	Belt - Gen.; W/50" Belt O.C.	70885	TR22495
Belt - W.P.; W/33 1/2" Belt O.C.	178490	TR22329	Belt - Alt.; Auto.; W/O Turbo, Super Turbo ..	178470	TR22474
Belt - W.P.; W/36 5/8" Belt O.C.	178530	②TR22358	Belt - Alt.; Auto.; W/Turbo, Super Turbo	178685	TR22485
Belt - Gen.; W/45" Belt O.C.	101426	TR22443	Power Units		
Belt - Gen.; W/48" Belt O.C.	178470	TR22474			
Belt - Gen.; W/50" Belt O.C.	70885	TR22495			

②Two Required.

Belts and Coolant Hose for Power Units

Application	Mfr. Part No.	Our No.	Application	Mfr. Part No.	Our No.
Cummins - Continued			Cummins - Continued		
JS-6-IP			KTA19 - Continued		
Belt - Fan	124421	TR24365	Belt - Alt.; W/45A. Alt.	511016105	K050355
Belt - W.P.; W/33 1/2" Belt O.C.	178490	TR22329	Belt - Alt.; W/75A. Alt.	5110161	K050370
Belt - W.P.; W/36 5/8" Belt O.C.	178530	②TR22358	KTA19G		
Belt - Gen.; W/45" Belt O.C.	101426	TR22443	Belt - Alt.	5110161	K050370
Belt - Gen.; W/48" Belt O.C.	178470	TR22474	KTA38		
Belt - Gen.; W/50" Belt O.C.	70885	TR22495	Belt - Alt.; W/38A. Alt.	5110163	♣9330HD
Belt - Alt.; Auto.; W/Turbo, Super Turbo	178685	TR22485	KTA38G1		
JS-6-P			Belt - Alt.; W/35A. Alt.	511016102	♣K050345HD
Belt - Fan	124421	TR24365	KTA50		
Belt - W.P.; W/33 1/2" Belt O.C.	178490	TR22329	Belt - Alt.	5110163	②♣9330HD
Belt - W.P.; W/36 5/8" Belt O.C.	178530	②TR22358	KTA52		
Belt - Gen.; W/45" Belt O.C.	101426	TR22443	Belt - Alt.; W/35A., 75A. Alt.; W/Cummins	511016102	♣K050345HD
Belt - Gen.; W/48" Belt O.C.	178470	TR22474	KTA53		
Belt - Gen.; W/50" Belt O.C.	70885	TR22495	Belt - Alt.; W/75A. Alt.; W/Cummins	511016102	♣K050345HD
JT-6-B; JT-6-BI; JT-6-CI			KTA53		
Belt - Fan; Auto.; W/37 1/8" Belt O.C.	124466	②TR24365	Belt - Alt.; W/75A. Alt.; W/Cummins	511016102	♣K050345HD
Belt - Fan; Auto.; W/36 7/8" Belt O.C.	178539	②TR22363	KTT11		
Belt - W.P.; Auto.	178455	TR22299	Belt - Alt.; W/35A. Alt.	5110119	K050290
Belt - Gen.; W/45" Belt O.C.	101426	TR22443	Belt - Alt.; W/45A. Alt.	511016105	K050355
Belt - Gen.; W/48" Belt O.C.	178470	TR22474	Belt - Alt.; W/75A. Alt.	5110161	K050370
Belt - Gen.; W/50" Belt O.C.	70885	TR22495	Hose - Upper - Eng. To Pipe	24440	
Belt - Alt.; Auto.; W/O Turbo, Super Turbo ..	178470	TR22474	Hose - Upper - Pipe To Rad.	24440	
Belt - Alt.; Auto.; W/Turbo, Super Turbo	178685	TR22485	Hose - Lower - Eng. To Pipe	24456	
JT-6-I			Hose - Lower - Pipe To Rad.	24456	
Belt - Fan	124421	TR24365	KTT12		
Belt - W.P.; W/33 1/2" Belt O.C.	178490	TR22329	Hose - Upper - Eng. To Pipe	24440	
Belt - W.P.; W/36 5/8" Belt O.C.	178530	②TR22358	Hose - Upper - Pipe To Rad.	24440	
Belt - Gen.; W/45" Belt O.C.	101426	TR22443	Hose - Lower - Eng. To Pipe	24456	
Belt - Gen.; W/48" Belt O.C.	178470	TR22474	Hose - Lower - Pipe To Rad.	24456	
Belt - Gen.; W/50" Belt O.C.	70885	TR22495	KTTA19		
JT-6-IP			Belt - Alt.; W/35A. Alt.	5110119	K050290
Belt - Fan	124421	TR24365	Belt - Alt.; W/45A. Alt.	511016105	K050355
Belt - W.P.; W/33 1/2" Belt O.C.	178490	TR22329	Belt - Alt.; W/75A. Alt.	5110161	K050370
Belt - W.P.; W/36 5/8" Belt O.C.	178530	②TR22358	KTTA19G		
Belt - Gen.; W/45" Belt O.C.	101426	TR22443	Belt - Alt.	5110161	K050370
Belt - Gen.; W/48" Belt O.C.	178470	TR22474	KTTA38		
Belt - Gen.; W/50" Belt O.C.	70885	TR22495	Belt - Alt.; W/38A. Alt.	5110163	♣9330HD
Belt - Alt.; Auto.; W/Turbo, Super Turbo	178685	TR22485	KTTA50		
JT-6-P			Belt - Alt.	5110163	②♣9330HD
Belt - Fan	124421	TR24365	KTTT12		
Belt - W.P.; W/33 1/2" Belt O.C.	178490	TR22329	Belt - Alt.; W/35A. Alt.	5110119	K050290
Belt - W.P.; W/36 5/8" Belt O.C.	178530	②TR22358	Belt - Alt.; W/45A. Alt.	511016105	K050355
Belt - Gen.; W/45" Belt O.C.	101426	TR22443	Belt - Alt.; W/75A. Alt.	5110161	K050370
Belt - Gen.; W/48" Belt O.C.	178470	TR22474	L; LM; LR; LRM; LRT; LRTM		
Belt - Gen.; W/50" Belt O.C.	70885	TR22495	Belt - Fan; 900 R.P.M. & Under	S1898	②TR28786
K-6			Belt - Fan; Over 900 R.P.M.	S2362	②TR28733
Belt - Alt.; W/36" Belt O.C.	205913	♣K050360HD	Belt - W.P.; W/Centrifugal W.P.	S2877	TR22553
Belt - Alt.; W/37" Belt O.C.	206996	K050370	Belt - W.P.; W/Gear Drive	S2878	③♣9530HD
Belt - Alt.; W/44" Belt O.C.	214701	K050440	Belt - Gen.	②TR30770	
KT19G			Belt - Compr.	69307	②♣9570HD
Belt - Alt.	5110161	K050370	N-495-B130; N-495-C130		
KT38			Belt - Fan & W.P.	172856	②TR24457
Belt - Alt.; W/38A. Alt.	5110163	♣9330HD	Belt - Alt.	172856	TR24457
KTA12			N-495-P130		
Belt - Alt.; W/35A. Alt.	5110119	K050290	Belt - Fan & W.P.	172856	②TR24457
Belt - Alt.; W/45A. Alt.	511016105	K050355	Belt - Alt.	178436	TR22358
Belt - Alt.; W/75A. Alt.	5110161	K050370	N-927		
Hose - Upper - Eng. To Pipe	24440		Belt - Fan	134809	TR28492
Hose - Upper - Pipe To Rad.	24440		Belt - W.P. & Idler	215356	②6596
Hose - Lower - Eng. To Pipe	24456				
Hose - Lower - Pipe To Rad.	24456				
KTA19					
Belt - Alt.; W/35A. Alt.	5110119	K050290			

②Two Required.
③Three Required.

♣Standard Belt Available.

Belts and Coolant Hose for Power Units

Application	Mfr. Part No.	Our No.	Application	Mfr. Part No.	Our No.
Cummins - Continued			Cummins - Continued		
NHC-4-I			NHS-6-B; NHS-6-BI; NHS-6-CI		
Belt - Fan; W/40 5/8" Belt O.C.	178657	②TR28400	Belt - Fan	134809	②TR28492
Belt - Fan; W/50" Belt O.C.	134809	②TR28492	Belt - W.P.; W/44" Belt O.C.	132013	TR22434
Belt - Fan & W.P.; W/41 1/8" Belt O.C.	134773	②TR22405	Belt - W.P.; W/44 3/8" Belt O.C.	178628	TR24438
Belt - Fan & W.P.; W/46 3/8" Belt O.C.	172856	②TR24457	NHS-6-I; NHS-6-IP; NHS-6-P		
Belt - W.P.; W/40 3/4" Belt O.C.	178570	TR24400	Belt - Fan	134810	②TR28545
Belt - W.P.; W/44" Belt O.C.	132013	TR22434	Belt - W.P.	178628	TR24438
Belt - W.P.; W/44 3/8" Belt O.C.	200328	TR24438	NRT-6-B; NRT-6-BI; NRT-6-CI		
Belt - Gen.	70350	TR22358	Belt - Fan; W/44 3/8" Belt O.C.	178707	②TR28437
NHC-4-IP; NHC-4-P			Belt - Fan; W/50" Belt O.C.	134809	②TR28492
Belt - Fan & W.P.; W/41 1/8" Belt O.C.	70524	②TR22405	Belt - Fan; W/51 1/8" Belt O.C.	178597	②TR28501
Belt - Fan & W.P.; W/46 3/8" Belt O.C.	172856	②TR24457	Belt - W.P.; W/41 1/8" Belt O.C.	134773	TR22405
Belt - Alt./Gen.	70350	TR22358	Belt - W.P.; W/44" Belt O.C.; W/Dual Belts .	215356	②6596
NHC-250			Belt - W.P.; W/44" Belt O.C.; W/Single Belt .	132013	TR22434
Belt - Fan; W/40 5/8" Belt O.C.	178657	②TR28400	Belt - W.P.; W/44 3/8" Belt O.C.	178628	TR24438
Belt - Fan; W/50" Belt O.C.	134809	②TR28492	Belt - W.P.; W/46 3/8" Belt O.C.	172856	TR24457
Belt - Fan & W.P.; W/41 1/8" Belt O.C.	134773	②TR22405	Belt - Gen.	132010	TR22363
Belt - Fan & W.P.; W/46 3/8" Belt O.C.	172856	②TR24457	Belt - Alt.; W/36 1/2" Belt O.C.	178436	TR22358
Belt - W.P.; W/40 3/4" Belt O.C.	178570	TR24400	Belt - Alt.; W/38 3/8" Belt O.C.		TR22380
Belt - W.P.; W/44" Belt O.C.	132013	TR22434	Belt - Alt.; W/45 3/8" Belt O.C.		♣9451HD
Belt - W.P.; W/44 3/8" Belt O.C.	200328	TR24438	NRT-6-I; NRT-6-IP; NRT-6-P		
Belt - Gen.	70350	TR22358	Belt - Fan	134817	②TR30506
NHCT-270-B			Belt - W.P.	178628	TR24438
Belt - W.P.	172856	②TR24457	Belt - Gen.	132010	TR22363
Belt - Alt.	172856	TR24457	NRTO-6-B; NRTO-6-BI; NRTO-6-CI		
NHD-180-B			Belt - Fan; W/44 3/8" Belt O.C.	178707	②TR28437
Belt - W.P.	172856	②TR24457	Belt - Fan; W/50" Belt O.C.	134809	②TR28492
Belt - Alt.	178556	TR22363	Belt - Fan; W/51 1/8" Belt O.C.	178597	②TR28501
NHE-180-B; NHE-180-CI; NHE-180-I; NHE-195-B; NHE-220-B			Belt - W.P.; W/41 1/8" Belt O.C.	134773	TR22405
Belt - Fan; W/40 5/8" Belt O.C.	178657	②TR28400	Belt - W.P.; W/44" Belt O.C.; W/Dual Belts .	215356	②6596
Belt - Fan; W/50" Belt O.C.	134809	②TR28492	Belt - W.P.; W/44" Belt O.C.; W/Single Belt .	132013	TR22434
Belt - Fan & W.P.; W/41 1/8" Belt O.C.	134773	②TR22405	Belt - W.P.; W/44 3/8" Belt O.C.	178628	TR24438
Belt - Fan & W.P.; W/46 3/8" Belt O.C.	172856	②TR24457	Belt - W.P.; W/46 3/8" Belt O.C.	172856	TR24457
Belt - W.P.; W/40 3/4" Belt O.C.	178570	TR24400	Belt - Gen.	132010	TR22363
Belt - W.P.; W/44" Belt O.C.	132013	TR22434	Belt - Alt.; W/36 1/2" Belt O.C.	178436	TR22358
Belt - W.P.; W/44 3/8" Belt O.C.	200328	TR24438	Belt - Alt.; W/38 3/8" Belt O.C.		TR22380
Belt - Gen.	70350	TR22358	Belt - Alt.; W/45 3/8" Belt O.C.		♣9451HD
NHE-225			NRTO-6-I; NRTO-6-IP		
Belt - W.P.	172856	②TR24457	Belt - Fan	134810	②TR28545
Belt - Alt.; Auto.		②♣9451HD	Belt - W.P.	178628	TR24438
NHE-225-B			Belt - Gen.; W/40 3/4" Belt O.C.	132012	TR24400
Belt - W.P.	172856	②TR24457	Belt - Gen.; W/41 5/8" Belt O.C.	134797	TR22410
Belt - Alt.	178556	TR22363	NT-6-B; NT-6-BI; NT-6-CI		
NHR-195-CI			Belt - Fan; W/40 5/8" Belt O.C.	178657	②TR28400
Belt - Fan; W/40 5/8" Belt O.C.	178657	②TR28400	Belt - Fan; W/50" Belt O.C.	134809	②TR28492
Belt - Fan; W/50" Belt O.C.	134809	②TR28492	Belt - Fan & W.P.; W/41 1/8" Belt O.C.	134773	②TR22405
Belt - Fan & W.P.; W/41 1/8" Belt O.C.	134773	②TR22405	Belt - Fan & W.P.; W/46 3/8" Belt O.C.	172856	②TR24457
Belt - Fan & W.P.; W/46 3/8" Belt O.C.	172856	②TR24457	Belt - W.P.; W/40 3/4" Belt O.C.	178570	TR24400
Belt - W.P.; W/40 3/4" Belt O.C.	178570	TR24400	Belt - W.P.; W/44" Belt O.C.	132013	TR22434
Belt - W.P.; W/44" Belt O.C.	132013	TR22434	Belt - W.P.; W/44 3/8" Belt O.C.	200328	TR24438
Belt - W.P.; W/44 3/8" Belt O.C.	200328	TR24438	Belt - Gen.	70350	TR22358
Belt - Gen.	70350	TR22358	NT-6-I; NT-6-IP; NT-6-P		
NHRS-6-B; NHRS-6-BI; NHRS-6-CI			Belt - Fan	134817	②TR30506
Belt - Fan	134809	②TR28492	Belt - W.P.	132012	TR24400
Belt - W.P.; W/44" Belt O.C.	132013	TR22434	Belt - Gen.	178567	TR22350
Belt - W.P.; W/44 3/8" Belt O.C.	178628	TR24438	NT-165-BI; NT-180-B; NT-180-BI; NT-200-B; NT-200-BI		
NHRS-6-G			Belt - Fan; W/40 5/8" Belt O.C.	178657	②TR28400
Belt - Fan	134817	②TR30506	Belt - Fan; W/50" Belt O.C.	134809	②TR28492
Belt - W.P.	132012	TR24400	Belt - Fan & W.P.; W/41 1/8" Belt O.C.	134773	②TR22405
NHRS-6-I; NHRS-6-IP; NHRS-6-P			Belt - Fan & W.P.; W/46 3/8" Belt O.C.	172856	②TR24457
Belt - Fan	134810	②TR28545	Belt - W.P.; W/40 3/4" Belt O.C.	178570	TR24400
Belt - W.P.	178628	TR24438	Belt - W.P.; W/44" Belt O.C.	132013	TR22434
			Belt - W.P.; W/44 3/8" Belt O.C.	200328	TR24438
			Belt - Gen.	70350	TR22358

②Two Required.

♣Standard Belt Available.

Power Units

Belts and Coolant Hose for Power Units

Application	Mfr. Part No.	Our No.	Application	Mfr. Part No.	Our No.
Cummins - Continued			Cummins - Continued		
NT-270-CT			NTA-370; NTA-370-B		
Belt - Fan; W/48" Belt O.C.	178624	②TR28473	Belt - Fan	134809	②TR28492
Belt - Fan; W/48 3/4" Belt O.C.	178620	②TR28480	Belt - W.P.; W/62 1/4" Belt O.C.		②♣9620HD
Belt - Fan; W/50" Belt O.C.	134809	②TR28492	Belt - W.P.; W/62 3/4" Belt O.C.	204481	②♣9625HD
Belt - W.P.; W/43 3/4" Belt O.C.	215356	7430	Belt - Alt.; W/44 1/4" Belt O.C.	201450	②♣9440HD
Belt - W.P.; W/44 3/8" Belt O.C.	178628	TR24438	Belt - Alt.; W/46" Belt O.C.	212589	②♣9451HD
Belt - Gen.; W/36 7/8" Belt O.C.	132010	TR22363	NTA-380		
Belt - Gen.; W/41 5/8" Belt O.C.	134797	TR22410	Belt - Fan; W/48" Belt O.C.	178624	②TR28473
Belt - Alt.; W/36 1/2" Belt O.C.	178436	TR22358	Belt - Fan; W/48 3/4" Belt O.C.	178620	②TR28480
Belt - Alt.; W/45 3/8" Belt O.C.		♣9451HD	Belt - Fan; W/50" Belt O.C.	134809	②TR28492
Belt - Alt.; W/46 1/2" Belt O.C.	178623	♣9463HD	Belt - W.P.; W/43 3/4" Belt O.C.	215356	7430
NT-280; NT-280-B; NT-280-BI; NT-280-CI			Belt - W.P.; W/44 3/8" Belt O.C.	178628	TR24438
Belt - Fan; W/44 3/8" Belt O.C.	178707	②TR28437	Belt - Gen.; W/36 7/8" Belt O.C.	132010	TR22363
Belt - Fan; W/50" Belt O.C.	134809	②TR28492	Belt - Gen.; W/41 5/8" Belt O.C.	134797	TR22410
Belt - Fan; W/51 1/8" Belt O.C.	178597	②TR28501	Belt - Alt.; W/36 1/2" Belt O.C.	178436	TR22358
Belt - W.P.; W/41 1/8" Belt O.C.	134773	TR22405	Belt - Alt.; W/45 3/8" Belt O.C.		♣9451HD
Belt - W.P.; W/44" Belt O.C.; W/Dual Belts .	215356	②6596	Belt - Alt.; W/46 1/2" Belt O.C.	178623	♣9463HD
Belt - W.P.; W/44" Belt O.C.; W/Single Belt .	132013	TR22434	NTA-400; NTA-420; NTA-420-C		
Belt - W.P.; W/44 3/8" Belt O.C.	178628	TR24438	Belt - Fan	134809	②TR28492
Belt - W.P.; W/46 3/8" Belt O.C.	172856	TR24457	Belt - W.P.; W/62 1/4" Belt O.C.		②♣9620HD
Belt - Gen.	132010	TR22363	Belt - W.P.; W/62 3/4" Belt O.C.	204481	②♣9625HD
Belt - Alt.; W/36 1/2" Belt O.C.	178436	TR22358	Belt - Alt.; W/44 1/4" Belt O.C.	201450	②♣9440HD
Belt - Alt.; W/38 3/8" Belt O.C.		TR22380	Belt - Alt.; W/46" Belt O.C.	212589	②♣9451HD
Belt - Alt.; W/45 3/8" Belt O.C.		♣9451HD	NTC-290		
NT-300-B; NT-300-BI; NT-300-CI; NT-310; NT-310-CI; NT-335; NT-335-B; NT-335-BI; NT-335-CI; NT-335-G; NT-380-B; NT-380-BI			Belt - Fan; W/44 3/8" Belt O.C.	178707	②TR28437
Belt - Fan; W/48" Belt O.C.	178624	②TR28473	Belt - Fan; W/50" Belt O.C.	134809	②TR28492
Belt - Fan; W/48 3/4" Belt O.C.	178620	②TR28480	Belt - Fan; W/51 1/8" Belt O.C.	178597	②TR28501
Belt - Fan; W/50" Belt O.C.	134809	②TR28492	Belt - W.P.; W/41 1/8" Belt O.C.	134773	TR22405
Belt - W.P.; W/43 3/4" Belt O.C.	215356	7430	Belt - W.P.; W/44" Belt O.C.; W/Dual Belts .	215356	②6596
Belt - W.P.; W/44 3/8" Belt O.C.	178628	TR24438	Belt - W.P.; W/44" Belt O.C.; W/Single Belt .	132013	TR22434
Belt - W.P.; W/44 3/8" Belt O.C.	178628	TR24438	Belt - W.P.; W/44 3/8" Belt O.C.	178628	TR24438
Belt - Gen.; W/36 7/8" Belt O.C.	132010	TR22363	Belt - W.P.; W/46 3/8" Belt O.C.	172856	TR24457
Belt - Gen.; W/41 5/8" Belt O.C.	134797	TR22410	Belt - Gen.	132010	TR22363
Belt - Alt.; W/36 1/2" Belt O.C.	178436	TR22358	Belt - Alt.; W/36 1/2" Belt O.C.	178436	TR22358
Belt - Alt.; W/45 3/8" Belt O.C.		♣9451HD	Belt - Alt.; W/38 3/8" Belt O.C.		TR22380
Belt - Alt.; W/46 1/2" Belt O.C.	178623	♣9463HD	Belt - Alt.; W/45 3/8" Belt O.C.		♣9451HD
NT-380-G			Belt - Alt.; W/46 3/8" Belt O.C.	178623	②♣9463HD
Belt - Fan	134822	②TR30543	NTC-335; NTC-335-B; NTC-350		
Belt - W.P.	178628	TR24438	Belt - Fan; W/48" Belt O.C.	178624	②TR28473
Belt - Gen.	132010	TR22363	Belt - Fan; W/48 3/4" Belt O.C.	178620	②TR28480
NT-380-I			Belt - Fan; W/50" Belt O.C.	134809	②TR28492
Belt - Fan	178611	②TR28545	Belt - W.P.; W/43 3/4" Belt O.C.	215356	7430
Belt - W.P.	200328	TR24438	Belt - W.P.; W/44 3/8" Belt O.C.	178628	TR24438
Belt - Alt.	178593	TR22461	Belt - Gen.; W/36 7/8" Belt O.C.	132010	TR22363
NT-380-IP			Belt - Gen.; W/41 5/8" Belt O.C.	134797	TR22410
Belt - Fan	134810	②TR28545	Belt - Alt.; W/36 1/2" Belt O.C.	178436	TR22358
Belt - W.P.	178628	TR24438	Belt - Alt.; W/45 3/8" Belt O.C.		♣9451HD
Belt - Gen.; W/40 3/4" Belt O.C.	132012	TR24400	Belt - Alt.; W/46 1/2" Belt O.C.	178623	♣9463HD
Belt - Gen.; W/41 5/8" Belt O.C.	134797	TR22410	NTE-235-B; NTE-235-BI		
NT-855-B335; NT-855-B380; NT-855-C310; NT-855-C335; NT-855-C380			Belt - Fan	134809	②TR28492
Belt - Fan	134809	②TR28492	Belt - W.P.	172856	②TR24457
Belt - W.P.	200328	TR24438	Belt - Alt.	70350	TR22358
Belt - Alt.	278436	TR22358	NTO-6-B; NTO-6-BI; NTO-6-CI		
NT-855-G5			Belt - Fan; W/40 5/8" Belt O.C.	178657	②TR28400
Belt - Fan	5110160	②TR28412	Belt - Fan; W/50" Belt O.C.	134809	②TR28492
Belt - Alt.; W/35A. Alt.	5110084	♣9470HD	Belt - Fan & W.P.; W/41 1/8" Belt O.C.	134773	②TR22405
Belt - Alt.; W/75A. Alt.	5110156	②♣9463HD	Belt - Fan & W.P.; W/46 3/8" Belt O.C.	172856	②TR24457
NT-855-P280; NT-855-P335; NT-855-P380			Belt - W.P.; W/40 3/4" Belt O.C.	178570	TR24400
Belt - Fan	178611	②TR28545	Belt - W.P.; W/44" Belt O.C.	132013	TR22434
Belt - W.P.	200328	TR24438	Belt - W.P.; W/44 3/8" Belt O.C.	200328	TR24438
Belt - Gen.		TR22410	Belt - Gen.	70350	TR22358
			NTO-6-I; NTO-6-IP; NTO-6-P		
			Belt - Fan	134817	②TR30506
			Belt - W.P.	132012	TR24400
			Belt - Gen.	178567	TR22350

②Two Required.

♣Standard Belt Available.

Power Units

Belts and Coolant Hose for Power Units

Application	Mfr. Part No.	Our No.	Application	Mfr. Part No.	Our No.
Cummins - Continued			Cummins - Continued		
NTO-262			Super 250/270 - Continued		
Belt - Fan; W/44 3/8" Belt O.C.	178707	②TR28437	Belt - Alt.	178623	②▲9463HD
Belt - Fan; W/50" Belt O.C.	134809	②TR28492	V6-140		
Belt - Fan; W/51 1/8" Belt O.C.	178597	②TR28501	Belt - Fan; W/High Mount Fan	178678	②TR22448
Belt - W.P.; W/41 1/8" Belt O.C.	134773	TR22405	Belt - W.P.; W/Low Mount W.P.	70885	TR22495
Belt - W.P.; W/44" Belt O.C.; W/Dual Belts .	215356	②6596	Belt - Gen.; W/Low Mount Gen.	70885	TR22495
Belt - W.P.; W/44" Belt O.C.; W/Single Belt .	132013	TR22434	V6-155		
Belt - W.P.; W/44 3/8" Belt O.C.	178628	TR24438	Belt - Alt.	178471	▲9365HD
Belt - W.P.; W/46 3/8" Belt O.C.	172856	TR24457	V6-200-B		
Belt - Gen.	132010	TR22363	Belt - Fan; W/49 5/8" Belt O.C.	141712	②TR24489
Belt - Alt.; W/36 1/2" Belt O.C.	178436	TR22358	Belt - Fan; W/61 3/8" Belt O.C.	178526	②TR24607
Belt - Alt.; W/38 3/8" Belt O.C.		TR22380	Belt - Fan; W/High Mount Fan	141712	②TR24489
Belt - Alt.; W/45 3/8" Belt O.C.		▲9451HD	Belt - Fan & W.P.; W/Low Mount Fan	122868	②TR24619
NTO-262-B; NTO-262-BI; NTO-262-CI			Belt - Gen.; W/Low Mount Gen.	122868	TR24619
Belt - Fan; W/40 5/8" Belt O.C.	178657	②TR28400	Belt - Gen.; W/High Mount Gen.	149265	TR24647
Belt - Fan; W/50" Belt O.C.	134809	②TR28492	Belt - Alt.	178488	TR22336
Belt - Fan & W.P.; W/41 1/8" Belt O.C.	134773	②TR22405	V6-200-CI		
Belt - Fan & W.P.; W/46 3/8" Belt O.C.	172856	②TR24457	Belt - Fan; W/High Mount Fan	141712	②TR24489
Belt - W.P.; W/40 3/4" Belt O.C.	178570	TR24400	Belt - Fan; W/Low Mount Fan	178691	②TR22517
Belt - W.P.; W/44" Belt O.C.	132013	TR22434	Belt - W.P.	178530	②TR22358
Belt - W.P.; W/44 3/8" Belt O.C.	200328	TR24438	Belt - Gen.; W/Low Mount Gen.	122868	TR24619
Belt - Gen.	70350	TR22358	Belt - Gen.; W/High Mount Gen.	178685	TR22485
NTO-262-I; NTO-262-IP; NTO-262-P			V6-378		
Belt - Fan	134817	②TR30506	Belt - Alt.	178471	▲9365HD
Belt - W.P.	132012	TR24400	V6-B		
Belt - Gen.	178567	TR22350	Belt - Fan; W/High Mount Fan	178678	②TR22448
NTO-280-B; NTO-280-CI			Belt - Fan; W/Low Mount Fan	178685	②TR22485
Belt - Fan; W/44 3/8" Belt O.C.	178707	②TR28437	Belt - W.P.; W/Low Mount W.P.	70885	TR22495
Belt - Fan; W/50" Belt O.C.	134809	②TR28492	Belt - W.P. To Alt.	178660	②▲9490HD
Belt - Fan; W/51 1/8" Belt O.C.	178597	②TR28501	Belt - Gen.; W/Low Mount Gen.	70885	TR22495
Belt - W.P.; W/41 1/8" Belt O.C.	134773	TR22405	V6-CI		
Belt - W.P.; W/44" Belt O.C.; W/Dual Belts .	215356	②6596	Belt - Fan; W/High Mount Fan	178678	②TR22448
Belt - W.P.; W/44" Belt O.C.; W/Single Belt .	132013	TR22434	Belt - Fan; W/Low Mount Fan	178685	②TR22485
Belt - W.P.; W/44 3/8" Belt O.C.	178628	TR24438	Belt - W.P.; W/Low Mount W.P.	70885	TR22495
Belt - W.P.; W/46 3/8" Belt O.C.	172856	TR24457	Belt - W.P. To Alt.	178471	▲9365HD
Belt - Gen.	132010	TR22363	Belt - Gen.; W/Low Mount Gen.	70885	TR22495
Belt - Alt.; W/36 1/2" Belt O.C.	178436	TR22358	V6E-195-B		
Belt - Alt.; W/38 3/8" Belt O.C.		TR22380	Belt - Fan; W/49 5/8" Belt O.C.	141712	②TR24489
Belt - Alt.; W/45 3/8" Belt O.C.		▲9451HD	Belt - Fan; W/61 3/8" Belt O.C.	178526	②TR24607
NTRO-6-P			Belt - Fan; W/High Mount Fan	141712	②TR24489
Belt - Fan	134810	②TR28545	Belt - Fan & W.P.; W/Low Mount Fan	122868	②TR24619
Belt - W.P.	178628	TR24438	Belt - Gen.; W/Low Mount Gen.	122868	TR24619
Belt - Gen.; W/40 3/4" Belt O.C.	132012	TR24400	Belt - Gen.; W/High Mount Gen.	149265	TR24647
Belt - Gen.; W/41 5/8" Belt O.C.	134797	TR22410	Belt - Alt.	178488	TR22336
NVH-12			V6E-195-BI		
Belt - Fan	S3175	②TR22711	Belt - Fan; W/61 3/8" Belt O.C.	178526	②TR24607
Belt - W.P.	125367	TR28376	Belt - Fan; W/High Mount Fan	141712	②TR24489
Belt - Gen.; W/High Mount Std. Gen.	134813	②TR22344	Belt - Gen.; W/Low Mount Gen.	122868	TR24619
Belt - Gen.; W/High Mount Optional Gen. ...	70350	②TR22358	Belt - Alt.	178488	TR22336
Belt - Alt.	70362	②6929	V6R-180-CI		
Belt - Belt; W/Barnes Pump	129949	②▲9309HD	Belt - Fan; W/High Mount Fan	141712	②TR24489
NVH12-450			Belt - Fan; W/Low Mount Fan	178691	②TR22517
Belt - Fan	134821	②TR22711	Belt - W.P.	178530	②TR22358
Belt - W.P.	125367	TR28376	Belt - Gen.; W/Low Mount Gen.	122868	TR24619
Belt - Gen.	134813	②TR22344	Belt - Gen.; W/High Mount Gen.	178685	TR22485
Belt - Alt.	70362	②6929	V6-SVC-B		
Belt - P.S.; W/Vickers P.S. Pump; Under 1800 R.P.M.	S2698	②TR22363	Belt - Fan; W/Low Mount Fan	154377	②TR24619
Belt - P.S.; W/Vickers P.S. Pump; 1800 R.P.M. & Over	126597	②TR22380	Belt - Fan; W/High Mount Fan	141712	②TR24489
OSK45; OSK50			Belt - W.P.	154593	②TR22358
Belt - Alt.	3626788	▲K050380HD	Belt - Gen.; W/Low Mount Gen.	122868	TR24619
Super 250/270			Belt - Gen.; W/High Mount Gen.	123818	TR24607
Belt - Fan	134809	TR28492	V6-SVC-CI		
Belt - W.P. & Idler	215356	②6596	Belt - Fan; W/Low Mount Fan	157857	②TR22517

②Two Required.

▲Standard Belt Available.

Belts and Coolant Hose for Power Units

Application	Mfr. Part No.	Our No.	Application	Mfr. Part No.	Our No.
Cummins - Continued			Cummins - Continued		
V6-SVC-CI - Continued			V8R-220-C - Continued		
Belt - Fan; W/High Mount Fan	141712	②TR24489	Belt - Fan; W/Low Mount Fan	178691	③TR22517
Belt - W.P.	154593	②TR22358	Belt - Fan & W.P.; W/Low Mount Fan	141713	②TR24530
Belt - Gen.; W/Low Mount Gen.	122868	TR24619	Belt - W.P.	178530	TR22358
Belt - Gen.; W/High Mount Gen.	123818	TR24607	Belt - Gen.; W/Low Mount Gen.	141713	TR24530
V8-185			V12-525		
Belt - Fan; W/High Mount Fan	154805	②TR22448	Belt - W.P.	125367	TR28376
Belt - Fan; Auto.	178685	TR22485	Belt - Gen.	134813	②TR22344
Belt - Gen.	11725	TR22461	Belt - Alt.	70362	②6929
Belt - Alt.; Auto.; W/35 3/8" Belt O.C.	178473	♣9350HD	Belt - P.S.; W/Vickers P.S. Pump; Under 1800 R.P.M.	S2698	②TR22363
Belt - Alt.; W/36 7/8" Belt O.C.	178471	♣9365HD	Belt - P.S.; W/Vickers P.S. Pump; 1800 R.P.M. & Over	126597	②TR22380
V8-210			V-155		
Belt - Fan	178685	②TR22485	Belt - Fan	178685	②TR22485
Belt - Alt.; Auto.; W/35 3/8" Belt O.C.	178473	♣9350HD	Belt - Alt.; Auto.	178473	♣9350HD
Belt - Alt.; W/36 7/8" Belt O.C.	178471	♣9365HD	V-352-C140		
V8-265			Belt - Fan; W/High Mount Fan	178678	②TR22448
Belt - Fan; W/High Mount Fan; Auto.	141712	②TR24489	Belt - W.P.; W/Low Mount W.P.	70885	TR22495
Belt - Fan & W.P.; W/Low Mount Fan	141713	②TR24530	Belt - Gen.; W/Low Mount Gen.	70885	TR22495
Belt - Gen.; W/Low Mount Gen.	141713	TR24530	V-378		
V8-265-B			Belt - Fan	178685	②TR22485
Belt - Fan; W/High Mount Fan; Auto.	141712	②TR24489	Belt - Alt.; Auto.	178473	♣9350HD
Belt - Fan; W/20" Fan Center	154377	②TR24619	V-470		
Belt - Fan & W.P.; W/Low Mount Fan	141713	②TR24530	Belt - Fan; W/High Mount Fan	154805	②TR22448
Belt - Gen.; W/Low Mount Gen.	141713	TR24530	Belt - Fan; Auto.	178685	TR22485
V8-265-C			Belt - Gen.	11725	TR22461
Belt - Fan; W/High Mount Fan; Auto.	141712	②TR24489	Belt - Alt.; Auto.; W/35 3/8" Belt O.C.	178473	♣9350HD
Belt - Fan; W/Low Mount Fan	178691	③TR22517	Belt - Alt.; W/36 7/8" Belt O.C.	178471	♣9365HD
Belt - Fan & W.P.; W/Low Mount Fan	141713	②TR24530	V-504		
Belt - W.P.	178530	TR22358	Belt - Fan	178685	②TR22485
Belt - Gen.; W/Low Mount Gen.	141713	TR24530	Belt - Alt.; Auto.; W/35 3/8" Belt O.C.	178473	♣9350HD
Belt - Alt.	178685	TR22485	Belt - Alt.; W/36 7/8" Belt O.C.	178471	♣9365HD
V8-265-P			V-555C		
Belt - Fan; W/High Mount Fan; Auto.	141712	②TR24489	Belt - Fan; Auto.	189917	②♣9490HD
Belt - Fan; W/Low Mount Fan	178691	③TR22517	Belt - Alt.; Auto.	7530	
Belt - Fan & W.P.; W/Low Mount Fan	141713	②TR24530	V-588-B195; V-588-B200		
Belt - Gen.; W/Low Mount Gen.	141713	TR24530	Belt - Fan; W/49 5/8" Belt O.C.	141712	②TR24489
Belt - Alt.	178587	TR22405	Belt - Fan; W/61 3/8" Belt O.C.	178526	②TR24607
V8-350-B; V8-350-BI; V8-350-CI			Belt - Fan; W/High Mount Fan	141712	②TR24489
Belt - Fan	132237	②TR28743	Belt - Fan & W.P.; W/Low Mount Fan	122868	②TR24619
Belt - W.P.	132010	TR22363	Belt - Gen.; W/Low Mount Gen.	122868	TR24619
Belt - Gen.	111724	TR22336	Belt - Gen.; W/High Mount Gen.	149265	TR24647
V8-350-IP			Belt - Alt.	178488	TR22336
Belt - Fan	133089	②CX68	V-588-C180; V-588-C200		
Belt - W.P.	132012	TR24400	Belt - Fan; W/High Mount Fan	141712	②TR24489
Belt - Gen.	111724	TR22336	Belt - Gen.; W/Low Mount Fan	122868	TR24619
V8E-170			V785-B235; V785-B265		
Belt - Fan; W/High Mount Fan	154805	②TR22448	Belt - Fan; W/High Mount Fan; Auto.	141712	②TR24489
Belt - Fan; Auto.	178685	TR22485	Belt - Fan; Auto.	178526	②TR24607
Belt - Gen.	11725	TR22461	Belt - Fan & W.P.; W/Low Mount Fan	141713	②TR24530
Belt - Alt.; Auto.; W/35 3/8" Belt O.C.	178473	♣9350HD	Belt - Gen.; W/Low Mount Fan	141713	TR24530
Belt - Alt.; W/36 7/8" Belt O.C.	178471	♣9365HD	Belt - Alt.; Auto.	178488	TR22336
V8E-235			V785-C220; V785-C265		
Belt - Fan; W/High Mount Fan; Auto.	141712	②TR24489	Belt - Fan; W/High Mount Fan; Auto.	141712	②TR24489
Belt - Fan & W.P.; W/Low Mount Fan	141713	②TR24530	Belt - Fan; W/Low Mount Fan	178691	③TR22517
Belt - Gen.; W/Low Mount Gen.	141713	TR24530	Belt - Fan & W.P.; W/Low Mount Fan	141713	②TR24530
V8E-235-B			Belt - W.P.	178530	TR22358
Belt - Fan; W/High Mount Fan; Auto.	141712	②TR24489	Belt - Gen.; W/Low Mount Gen.	141713	TR24530
Belt - Fan; Auto.	178526	②TR24607	Belt - Alt.	178685	TR22485
Belt - Fan & W.P.; W/Low Mount Fan	141713	②TR24530	V785-P265		
Belt - Gen.; W/Low Mount Fan	141713	TR24530	Belt - Fan; W/High Mount Fan; Auto.	141712	②TR24489
Belt - Alt.; Auto.	178488	TR22336			
V8R-220-C					
Belt - Fan; W/High Mount Fan; Auto.	141712	②TR24489			

②Two Required.
③Three Required.

♣Standard Belt Available.

Power Units

Belts and Coolant Hose for Power Units

Application	Mfr. Part No.	Our No.	Application	Mfr. Part No.	Our No.
Cummins - Continued			Cummins - Continued		
V785-P265 - Continued			VT-903 - Continued		
Belt - Fan; W/Low Mount Fan	178691	③TR22517	Belt - Alt.; Auto.; W/46 1/2" Belt O.C.	200549	②♣9463HD
Belt - Fan & W.P.; W/Low Mount Fan	141713	②TR24530	VT1710-C635		
Belt - Gen.; W/Low Mount Gen.	141713	TR24530	Belt - Fan	178424	②♣9740HD
Belt - Alt.	178587	TR22405	Belt - W.P.	178665	②TR28390
V-903			Belt - Gen.	178613	②TR22344
Belt - Fan; Auto.	202051	③♣9670HD	VT-1710-P635		
Belt - W.P.; Auto.; W/36 1/4" Belt O.C.		②♣9360HD	Belt - W.P.	178665	②TR28390
Belt - W.P.; Auto.; W/67 1/8" Belt O.C.	189586	②TR28666	Belt - Gen.	178613	②TR22344
Belt - Alt.; Auto.; W/36 1/4" Belt O.C.		②♣9360HD	VTA28		
Belt - Alt.; Auto.; W/33 1/2" Belt O.C.	178658	②TR22329	Belt - Alt.	5110163	②♣9330HD
Belt - Alt.; Auto.; W/46 1/2" Belt O.C.	200549	②♣9463HD	VTA-1710-B700; VTA-1710-C700		
V-903-C			Belt - Fan	178424	②♣9740HD
Belt - Fan; Auto.	202051	③♣9670HD	Belt - W.P.	178665	②TR28390
Belt - Fan; W/58 1/4" Belt O.C.	178499	③♣9580HD	Belt - Gen.	178613	②TR22344
Belt - Fan; W/62 1/2" Belt O.C.	178629	③TR28616	VTA-1710-C800		
Belt - W.P.; Auto.; W/36 1/4" Belt O.C.		②♣9360HD	Belt - Fan	178578	③TR28706
Belt - W.P.; Auto.; W/39 3/4" Belt O.C.	197583	TR22392	Belt - W.P.	178665	②TR28390
Belt - W.P.; Auto.; W/67 1/8" Belt O.C.	189586	②TR28666	Belt - Gen.	178613	②TR22344
Belt - Alt.; Auto.; W/36 1/4" Belt O.C.		②♣9360HD	VTA-1710-P700; VTA-1710-P800		
Belt - Alt.; Auto.; W/33 1/2" Belt O.C.	178658	②TR22329	Belt - W.P.	178665	②TR28390
Belt - Alt.; Auto.; W/46 1/2" Belt O.C.	200549	②♣9463HD	Belt - Gen.	178613	②TR22344
Belt - Alt.; W/38 3/4" Belt O.C.	178479	②♣9385HD	Deutz-Allis		
Belt - Alt.; W/52 1/4" Belt O.C.	197171	②♣9520HD	BF12L 714		
V-1710-B500; V-1710-C500			Belt - Alt./Gen.; W/41 3/8" Belt O.C.		♣9412HD
Belt - Fan	178621	②TR22711	Belt - Alt./Gen.; W/42 1/4" Belt O.C.		♣9420HD
Belt - W.P.	178665	②TR28390	Belt - Alt./Gen.; W/44 3/8" Belt O.C.		♣9440HD
Belt - Gen.	178613	②TR22344	Belt - Alt./Gen.; W/49 3/8" Belt O.C.		♣9490HD
V-1710-P500			Belt - Compr.		②♣9430HD
Belt - W.P.	178665	②TR28390	F1L 310		
Belt - Gen.	178613	②TR22344	Belt - Gen. & Blower		7350
VT8-430-B; VT8-430-BI; VT8-430-CI			F1L 410		
Belt - Fan	117230	②TR30754	Belt - Alt./Gen. & Blower; W/34 1/8" Belt O.C.		7340
Belt - W.P.	129643	TR22363	Belt - Alt./Gen. & Blower; W/35 1/4" Belt O.C.		7350
Belt - Gen.	111724	TR22336	Belt - Alt./Gen. & Blower; W/36 1/4" Belt O.C.		7360
VT8-460-BI			Belt - Alt./Gen. & Blower; W/37 5/8" Belt O.C.		7375
Belt - Fan	132237	②TR28743	F1L 712		
Belt - W.P.	132010	TR22363	Belt - Gen.		7312
Belt - Gen. & Aux. Pump	132611	②TR24438	F1L 714		
VT-12			Belt - Alt./Gen.; W/41 3/8" Belt O.C.		♣9412HD
Belt - Fan	69995	②♣9740HD	Belt - Alt./Gen.; W/42 1/4" Belt O.C.		♣9420HD
Belt - W.P.	125367	TR28376	Belt - Alt./Gen.; W/44 3/8" Belt O.C.		♣9440HD
Belt - Gen.; W/High Mount Std. Gen.	134813	②TR22344	Belt - Alt./Gen.; W/49 3/8" Belt O.C.		♣9490HD
Belt - Gen.; W/High Mount Optional Gen. ...	70350	②TR22358	Belt - Compr.		②♣9430HD
Belt - Alt.	70362	②6929	F1L 812		
Belt - Belt; W/Barnes Pump	129949	②♣9309HD	Belt - Alt./Gen.; W/28 1/8" Belt O.C.		7280
VT12-600; VT12-700			Belt - Alt./Gen.; W/29 5/8" Belt O.C.		7295
Belt - Fan; W/71 5/8" Belt O.C.	134821	②TR22711	Belt - Alt./Gen.; W/32 1/4" Belt O.C.		7320
Belt - Fan; W/74 3/8" Belt O.C.	69995	②♣9740HD	F2L 310		
Belt - W.P.	125367	TR28376	Belt - Gen. & Blower		7350
Belt - Gen.	134813	②TR22344	F2L 410		
Belt - Alt.	70362	②6929	Belt - Alt./Gen. & Blower; W/34 1/8" Belt O.C.		7340
Belt - P.S.; W/Vickers P.S. Pump; Under 1800 R.P.M.	S2698	②TR22363	Belt - Alt./Gen. & Blower; W/35 1/4" Belt O.C.		7350
Belt - P.S.; W/Vickers P.S. Pump; 1800 R.P.M. & Over	126597	②TR22380	Belt - Alt./Gen. & Blower; W/36 1/4" Belt O.C.		7360
VT28			Belt - Alt./Gen. & Blower; W/37 5/8" Belt O.C.		7375
Belt - Alt.	5110163	②♣9330HD	F2L 514		
VT-903			Belt - Alt./Gen. & Blower		TR22625
Belt - Fan; Auto.	202051	③♣9670HD	F2L 712		
Belt - W.P.; Auto.; W/36 1/4" Belt O.C.		②♣9360HD	Belt - Gen.		7295
Belt - W.P.; Auto.; W/67 1/8" Belt O.C.	189586	②TR28666			
Belt - Alt.; Auto.; W/36 1/4" Belt O.C.		②♣9360HD			
Belt - Alt.; Auto.; W/33 1/2" Belt O.C.	178658	②TR22329			

②Two Required.
③Three Required.

♣Standard Belt Available.

Belts and Coolant Hose for Power Units

Application	Mfr. Part No.	Our No.	Application	Mfr. Part No.	Our No.
Deutz-Allis - Continued			Deutz-Allis - Continued		
F2L 812			F4L 912 - Continued		
Belt - Alt./Gen.; W/28 1/8" Belt O.C.		7280	Belt - Blower; W/43 1/8" Belt O.C.		7430
Belt - Alt./Gen.; W/29 5/8" Belt O.C.		7295	Belt - Blower; W/49 3/8" Belt O.C.		7490
Belt - Alt./Gen.; W/32 1/4" Belt O.C.		7320	Belt - Blower; W/50 1/8" Belt O.C.		7500
F2L 812S			Belt - Blower; W/50 7/8" Belt O.C.		7508
Belt - Gen. & Blower; W/44 1/4" Belt O.C.		7440	Belt - Blower; W/52 1/8" Belt O.C.		7520
Belt - Gen. & Blower; W/45 1/8" Belt O.C.		7450	Belt - Blower; W/53 3/8" Belt O.C.		7530
F2L 912			Belt - Blower; W/57 1/4" Belt O.C.		7570
Belt - Alt./Gen. & Blower; W/44 1/4" Belt O.C.		7440	Belt - Blower; W/58 1/8" Belt O.C.		7580
Belt - Alt./Gen. & Blower; W/45 1/8" Belt O.C.		7450	Belt - Blower; W/59 1/8" Belt O.C.		7590
Belt - Alt./Gen. & Blower; W/54 1/2" Belt O.C.		7541	Belt - Alt./Gen.; W/42 3/4" Belt O.C.		7425
F3L 514			Belt - Alt./Gen.; W/43 1/8" Belt O.C.		7430
Belt - Alt./Gen. & Blower		7660	Belt - Alt./Gen.; W/44 1/4" Belt O.C.		7440
F3L 712			Belt - Alt./Gen.; W/3/8" Belt T.W.; W/45 1/8" Belt O.C.		7450
Belt - Alt./Gen.; W/42 1/4" Belt O.C.		▲9420HD	Belt - Alt./Gen.; W/1/2" Belt T.W.; W/45 3/8" Belt O.C.		▲9451HD
Belt - Alt./Gen.; W/43 3/4" Belt O.C.		▲9435HD	Belt - Alt./Gen.; W/46 1/4" Belt O.C.		7460
Belt - Blower		▲9510HD	Belt - Alt./Gen.; W/57 1/4" Belt O.C.		7570
Belt - Compr.		▲9420HD	Belt - Alt./Gen.; W/59 1/8" Belt O.C.		7590
F3L 812			Belt - Alt./Gen.; W/59 3/4" Belt O.C.		7597
Belt - Blower; W/52 1/4" Belt O.C.		▲9520HD	Belt - Alt./Gen.; W/60 7/8" Belt O.C.		7612
Belt - Blower; W/53 1/4" Belt O.C.		▲9530HD	Belt - Compr.; W/39 1/4" Belt O.C.		▲9390HD
Belt - Blower; W/59 1/4" Belt O.C.		▲9590HD	Belt - Compr.; W/42 1/4" Belt O.C.		▲9420HD
Belt - Blower; W/60 1/4" Belt O.C.		▲9600HD	Belt - Compr.; W/43 1/4" Belt O.C.		▲9430HD
Belt - Compr.		▲9420HD	F4M 716		
F3L 911; F3L 912			Belt - Fan; W/51 1/4" Belt O.C.		▲9510HD
Belt - Blower; W/42 3/4" Belt O.C.		7425	Belt - Fan; W/53 1/4" Belt O.C.		▲9530HD
Belt - Blower; W/43 1/8" Belt O.C.		7430	Belt - Fan; W/54 1/4" Belt O.C.		▲9540HD
Belt - Blower; W/49 3/8" Belt O.C.		7490	Belt - Fan; W/55 1/4" Belt O.C.		▲9550HD
Belt - Blower; W/50 1/8" Belt O.C.		7500	F6L 413		
Belt - Blower; W/50 7/8" Belt O.C.		7508	Belt - Alt./Gen.; W/38 1/8" Belt O.C.; W/Single Belt		7380
Belt - Blower; W/52 1/8" Belt O.C.		7520	Belt - Alt./Gen.; W/38 1/8" Belt O.C.; W/Dual Belts		②7380
Belt - Blower; W/53 3/8" Belt O.C.		7530	Belt - Alt./Gen.; W/39 1/8" Belt O.C.		7390
Belt - Blower; W/57 1/4" Belt O.C.		7570	Belt - Alt./Gen.; W/43 1/8" Belt O.C.		7430
Belt - Blower; W/58 1/8" Belt O.C.		7580	Belt - Alt./Gen.; W/44 1/4" Belt O.C.		7440
Belt - Blower; W/59 1/8" Belt O.C.		7590	Belt - Alt./Gen.; W/45 1/8" Belt O.C.; W/Single Belt		7450
Belt - Alt./Gen.; W/42 3/4" Belt O.C.		7425	Belt - Alt./Gen.; W/45 1/8" Belt O.C.; W/Dual Belts		②7450
Belt - Alt./Gen.; W/43 1/8" Belt O.C.		7430	Belt - Compr.; W/37 1/4" Belt O.C.		②▲9370HD
Belt - Alt./Gen.; W/44 1/4" Belt O.C.		7440	Belt - Compr.; W/38 1/4" Belt O.C.		②▲9380HD
Belt - Alt./Gen.; W/3/8" Belt T.W.; W/45 1/8" Belt O.C.		7450	Belt - Compr.; W/40 1/4" Belt O.C.; W/Single Belt		▲9400HD
Belt - Alt./Gen.; W/1/2" Belt T.W.; W/45 3/8" Belt O.C.		▲9451HD	Belt - Compr.; W/40 1/4" Belt O.C.; W/Dual Belts		②▲9400HD
Belt - Alt./Gen.; W/46 1/4" Belt O.C.		7460	F6L 514		
Belt - Alt./Gen.; W/57 1/4" Belt O.C.		7570	Belt - Alt.		▲9350HD
Belt - Alt./Gen.; W/59 1/8" Belt O.C.		7590	Belt - Blower		7640
Belt - Alt./Gen.; W/59 3/4" Belt O.C.		7597	F6L 712		
Belt - Alt./Gen.; W/60 7/8" Belt O.C.		7612	Belt - Alt./Gen.; W/42 1/4" Belt O.C.		▲9420HD
Belt - Compr.; W/39 1/4" Belt O.C.		▲9390HD	Belt - Alt./Gen.; W/43 3/4" Belt O.C.		▲9435HD
Belt - Compr.; W/42 1/4" Belt O.C.		▲9420HD	Belt - Blower		▲9510HD
Belt - Compr.; W/43 1/4" Belt O.C.		▲9430HD	Belt - Compr.		▲9420HD
F4L 514			F6L 714		
Belt - Alt.		▲9350HD	Belt - Alt./Gen.; W/40 3/8" Belt O.C.		TR22397
Belt - Blower		7640	Belt - Alt./Gen.; W/41 5/8" Belt O.C.		TR22410
F4L 712			Belt - Alt./Gen.; W/42 1/4" Belt O.C.		▲9420HD
Belt - Alt./Gen.; W/42 1/4" Belt O.C.		▲9420HD	Belt - Alt./Gen.; W/49 1/4" Belt O.C.		▲9490HD
Belt - Alt./Gen.; W/43 3/4" Belt O.C.		▲9435HD	Belt - Compr.		②▲9430HD
Belt - Blower		▲9510HD	F6L 812		
Belt - Compr.		▲9420HD	Belt - Blower; W/52 1/4" Belt O.C.		▲9520HD
F4L 812			Belt - Blower; W/53 1/4" Belt O.C.		▲9530HD
Belt - Blower; W/52 1/4" Belt O.C.		▲9520HD	Belt - Blower; W/59 1/4" Belt O.C.		▲9590HD
Belt - Blower; W/53 1/4" Belt O.C.		▲9530HD	Belt - Blower; W/60 1/4" Belt O.C.		▲9600HD
Belt - Blower; W/59 1/4" Belt O.C.		▲9590HD	Belt - Compr.		▲9420HD
Belt - Blower; W/60 1/4" Belt O.C.		▲9600HD	F6L 911; F6L 912		
Belt - Compr.		▲9420HD	Belt - Blower; W/42 3/4" Belt O.C.		7425
F4L 912			Belt - Blower; W/43 1/8" Belt O.C.		7430
Belt - Blower; W/42 3/4" Belt O.C.		7425	Belt - Blower; W/49 3/8" Belt O.C.		7490
			Belt - Blower; W/50 1/8" Belt O.C.		7500

▲Standard Belt Available.

②Two Required.

Power Units

Belts and Coolant Hose for Power Units

Application	Mfr. Part No.	Our No.	Application	Mfr. Part No.	Our No.
Deutz-Allis - Continued			International - Continued		
F6L 911; F6L 912 - Continued			R372; R406; R450		
Belt - Blower; W/50 7/8" Belt O.C.		7508	Belt - Fan	35974HA	ⓉTR22517
Belt - Blower; W/52 1/8" Belt O.C.		7520	S220; S240		
Belt - Blower; W/53 3/8" Belt O.C.		7530	Belt - Fan & Gen.	78910R1	TR28445
Belt - Blower; W/57 1/4" Belt O.C.		7570	U1		
Belt - Blower; W/58 1/8" Belt O.C.		7580	Belt - Fan	60712D	TR26353
Belt - Blower; W/59 1/8" Belt O.C.		7590	U2; U2A		
Belt - Alt./Gen.; W/42 3/4" Belt O.C.		7425	Belt - Fan	46869D	TR28346
Belt - Alt./Gen.; W/43 1/8" Belt O.C.		7430	Belt - Fan & W.P.	60712D	TR26353
Belt - Alt./Gen.; W/44 1/4" Belt O.C.		7440	Belt - Gen.; W/Delco Gen.	49291D	6826
Belt - Alt./Gen.; W/3/8" Belt T.W.; W/45 1/8" Belt O.C.		7450	U4		
Belt - Alt./Gen.; W/1/2" Belt T.W.; W/45 3/8" Belt O.C.	♣9451HD		Belt - Fan	48032D	TR28386
Belt - Alt./Gen.; W/46 1/4" Belt O.C.		7460	U6		
Belt - Alt./Gen.; W/57 1/4" Belt O.C.		7570	Belt - Fan	69490DA	TR30467
Belt - Alt./Gen.; W/59 1/8" Belt O.C.		7590	Belt - Gen.; W/Delco Gen.	49341D	♣9335HD
Belt - Alt./Gen.; W/59 3/4" Belt O.C.		7597	Belt - Gen.; W/Bosch Gen.	54857DB	9300
Belt - Alt./Gen.; W/60 7/8" Belt O.C.		7612	U9		
Belt - Compr.; W/39 1/4" Belt O.C.	♣9390HD		Belt - Fan	48042D	TR30484
Belt - Compr.; W/42 1/4" Belt O.C.	♣9420HD		Belt - Gen.	54867D	♣9355HD
Belt - Compr.; W/43 1/4" Belt O.C.	♣9430HD		U14		
F6M 716			Belt - Fan	30982D	TR32571
Belt - Fan; W/51 1/4" Belt O.C.	♣9510HD		U21		
Belt - Fan; W/53 1/4" Belt O.C.	♣9530HD		Belt - Fan	22705D	TR32491
Belt - Fan; W/54 1/4" Belt O.C.	♣9540HD		U123		
Belt - Fan; W/55 1/4" Belt O.C.	♣9550HD		Belt - Fan	46869D	TR28346
F8L 413			Belt - Fan & W.P.	60712D	TR26353
Belt - Alt./Gen.; W/38 1/8" Belt O.C.; W/Single Belt		7380	Belt - Gen.	52318DA	9279
Belt - Alt./Gen.; W/38 1/8" Belt O.C.; W/Dual Belts	Ⓣ7380		U164; U169; U175		
Belt - Alt./Gen.; W/39 1/8" Belt O.C.		7390	Belt - Fan	48032DA	TR28386
Belt - Alt./Gen.; W/43 1/8" Belt O.C.		7430	Belt - Gen.	48878D	♣9309HD
Belt - Alt./Gen.; W/44 1/4" Belt O.C.		7440	U220; U240		
Belt - Alt./Gen.; W/45 1/8" Belt O.C.; W/Single Belt		7450	Belt - Fan & Gen.	20594VA	TR24449
Belt - Alt./Gen.; W/45 1/8" Belt O.C.; W/Dual Belts	Ⓣ7450		U264		
Belt - Compr.; W/37 1/4" Belt O.C.	Ⓣ♣9370HD		Belt - Fan; W/4-Cyl. Eng.	69490DA	TR30467
Belt - Compr.; W/38 1/4" Belt O.C.	Ⓣ♣9380HD		Belt - Fan & Gen.; W/6-Cyl. Eng.	274521R1	TR24438
Belt - Compr.; W/40 1/4" Belt O.C.; W/Single Belt	♣9400HD		Belt - Gen.; W/4-Cyl. Eng.	49341D	♣9335HD
Belt - Compr.; W/40 1/4" Belt O.C.; W/Dual Belts	Ⓣ♣9400HD		U281		
F8L 714			Belt - Fan	16131DA	TR30467
Belt - Alt./Gen.; W/40 3/8" Belt O.C.		TR22397	Belt - Gen.	49341D	♣9335HD
Belt - Alt./Gen.; W/41 5/8" Belt O.C.		TR22410	U350		
Belt - Alt./Gen.; W/42 1/4" Belt O.C.	♣9420HD		Belt - Fan	48042DA	TR30484
Belt - Alt./Gen.; W/49 1/4" Belt O.C.	♣9490HD		Belt - Gen.	54857DB	9300
Belt - Compr.	Ⓣ♣9430HD		U372; U406; U450; U501		
F8M 716			Belt - Fan & Gen.	35974HA	ⓉTR22517
Belt - Fan; W/51 1/4" Belt O.C.	♣9510HD		U1091		
Belt - Fan; W/53 1/4" Belt O.C.	♣9530HD		Belt - Fan & Gen.	250678R41	ⓉCX68
Belt - Fan; W/54 1/4" Belt O.C.	♣9540HD		UB220; UB240; UB264		
Belt - Fan; W/55 1/4" Belt O.C.	♣9550HD		Belt - Fan & Gen.	274705R1	TR24438
F10L 714			Belt - Gov.	312017R1	7380
Belt - Compr.	♣9400HD		UC60		
F12M 716			Belt - Fan	60712D	TR26353
Belt - Fan; W/43 1/4" Belt O.C.	♣9430HD		Belt - Gen.	351321R1	6821
Belt - Fan; W/44 1/4" Belt O.C.	♣9440HD		UC135		
Belt - Fan; W/45 3/8" Belt O.C.	♣9451HD		Belt - Fan & Gen.	367697R1	7417
Belt - Fan; W/46 1/2" Belt O.C.	♣9463HD		UC221; UC263		
Belt - Fan; W/47 1/4" Belt O.C.	♣9470HD		Belt - Fan & Gen.; W/46 1/2" Belt O.C.	305177R1	♣9463HD
Belt - Fan; W/48 1/4" Belt O.C.	♣9480HD		Belt - Fan & Gen.; W/49 1/4" Belt O.C.	190502R1	♣9490HD
Belt - W.P. (Raw); W/59 1/4" Belt O.C.	♣9590HD		Belt - Fan & Gen.; W/52 1/4" Belt O.C.	312515R1	♣9525HD
Belt - W.P. (Raw); W/61 1/4" Belt O.C.	♣9610HD				
International					
EUBH					
Belt - Fan	48032D	TR28386			
Belt - Gen.	48878D	♣9313HD			

♣Standard Belt Available.

ⓉTwo Required.

Belts and Coolant Hose for Power Units

Application	Mfr. Part No.	Our No.	Application	Mfr. Part No.	Our No.
International - Continued			International - Continued		
UD6; UD6A			UV345		
Belt - Fan & W.P.	69490DA	TR30467	Belt - Fan & Gen.	151534R1	7680
Belt - Gen.	54857DB	9300	UV401; UV461; UV549		
Belt - Fuel Pump	48878D	♣9309HD	Belt - Fan	133500R11	②TR22434
UD9			Belt - Gen.	133732R1	♣9360HD
Belt - Fan	48042D	TR30484	Isuzu		
Belt - Gen.	54857DB	9300	2AB		
UD9A			Belt - Fan & Alt.	13671809	♣9385HD
Belt - Fan	48042D	TR30484	C201; C221; C240		
Belt - Gen.	54867D	♣9355HD	Belt - Fan & Alt.; W/40 1/4" Belt O.C.	13671215	♣9400HD
UD14; UD14A			Belt - Fan & Alt.; W/40 3/4" Belt O.C.	13671801	♣9405HD
Belt - Fan	30982D	TR32571	DA120; DA220; DA640		
Belt - Gen.	54857DB	9300	Belt - Fan & Alt.; W/54" Belt O.C.	13671125	TR22534
Belt - Fuel Pump	48878D	♣9309HD	Belt - Fan & Alt.; W/55" Belt O.C.	13671198	②TR22545
UD16			DH100		
Belt - Fan & Gen.; W/3 7/8" Pulley	251753R11	②TR28616	Belt - W.P. & Alt.	13671156	②TR30672
UD18; UD18A			John Deere		
Belt - Fan; W/8 7/8" C.S. Pulley	251180R2	②TR28628	4039D		
Belt - Fan; W/9 1/2" C.S. Pulley	258275R11	②TR30652	Belt - Fan & Alt.; W/3.9 L Eng.	R73784	TR22525
Belt - Fuel Pump	49341D	♣9335HD	6619A		
UD24			Belt - Fan & Alt.; W/10.1 L Eng.	RE12086	②♣9690HD
Belt - Fan	250678R31	②CX68	Lister		
UD236			HR3		
Belt - Fan & Gen.; W/50 3/4" Belt O.C.	304436R1	♣9505HD	Belt - Alt.; W/33.5 H.P. Eng.		♣9400HD
Belt - Fan & Gen.; W/52 1/4" Belt O.C.	312515R1	♣9525HD	Quicksilver QS-5.0G; Quicksilver QS-7.5G 0.9 L		
UD264			Belt - Alt. & W.P. (Raw); W/4-Cyl. Eng.	15310	7312
Belt - Fan	69490DA	TR30467	Quicksilver QS-8.0D 1.0 L		
Belt - Gen.	52318DA	9279	Belt - Alt., W.P. & W.P. (Raw); W/3-Cyl. Diesel Eng.		7365
Belt - Fuel Pump	48878D	♣9309HD	Quicksilver QS-8.0G 0.9 L		
UD281			Belt - Alt. & W.P. (Raw); W/4-Cyl. Eng.	15310	7312
Belt - Fan	48042DA	TR30484	Quicksilver QS-10.G 1.2 L		
Belt - Gen.	52318DA	9279	Belt - Alt. & W.P. (Raw); W/4-Cyl. 75 Eng.		7312
Belt - Fuel Pump	48878D	♣9309HD	SR4		
UD282			Belt - Alt. & Blower; W/24 H.P. Eng.		7435
Belt - Fan & Gen.; W/50 3/4" Belt O.C.	304436R1	♣9505HD	Mkt Mfg. Inc.		
Belt - Fan & Gen.; W/52 1/4" Belt O.C.	312515R1	♣9525HD	HP175		
UD350; UD370			Belt - Fan & Alt.; W/John Deere 6068 Turbodiesel Eng.	RE44538	②♣9580HD
Belt - Fan	48042DA	TR30484	Hose - Upper; W/John Deere 6068 Turbodiesel Eng.		26511
Belt - Gen.	54857DB	9300	Hose - Lower; W/John Deere 6068 Turbodiesel Eng.		26512
Belt - Fuel Pump	48878D	♣9309HD	Northern Lights		
UD525; UD554			M643		
Belt - Fan & Gen.	251753R21	②TR28616	Belt - W.P. & Alt.; W/3-Cyl. Diesel Eng.	REMF1280	7280
UD691			M753		
Belt - Fan & Gen.	251180R41	②TR28628	Belt - W.P. & Alt.; W/3-Cyl. Diesel Eng.	REMF1310	7312
UD817			M843N		
Belt - Gen.; W/48 1/4" Belt O.C.	310081R2	♣9480HD	Belt - W.P. & Alt.; W/3-Cyl. Diesel Eng.		♣9385HD
Belt - Gen.; W/52 1/2" Belt O.C.	304312R1	TR22517	M964		
UD1091			Belt - W.P. & Alt.; W/4-Cyl. Diesel Eng.		TR22474
Belt - Fan; Ser. No. 1960 & Before	250678R51	②CX68	M4276T		
Belt - Fan; Ser. No. 1691 To 10143	275475R11	②TR28733	Belt - W.P. & Alt.; W/4-Cyl. Diesel Eng.	T26755	♣9570HD
Belt - Fan; Ser. No. 10144 & After	310357R11	②TR30754	Onan		
UDT817			5GO		
Belt - Gen.; W/48 1/4" Belt O.C.	310081R2	♣9480HD	Belt - Fan	5117	TR22336
Belt - Gen.; W/52 1/2" Belt O.C.	304312R1	TR22517			
UDT1091					
Belt - Fan; Ser. No. 1960 & Before	250678R51	②CX68			
Belt - Fan; Ser. No. 1691 To 10143	275475R11	②TR28733			
Belt - Fan; Ser. No. 10144 & After	310357R11	②TR30754			

♣Standard Belt Available.

②Two Required.

Power Units

Belts and Coolant Hose for Power Units

Application	Mfr. Part No.	Our No.	Application	Mfr. Part No.	Our No.
Onan - Continued			Onan - Continued		
6GO			DZB - Continued		
Belt - Fan	5118	TR22386	Belt - Gen.; W/47 1/4" Belt O.C.	511P60	♣9470HD
150DGFA			DZC; DZD		
Hose - Lower; W/Cummins 6Cta8.3C Eng.		21901	Belt - Gen.	511P60	♣9470HD
175DFBD			EC		
Belt - Fan; W/Cummins NT855G4, NT855G5 Eng.	5110160	ⓉTR28412	Belt - Fan	51138	7390
Belt - Alt.; W/35A. Alt.; W/Cummins NT855G4, NT855G5 Eng.	5110084	♣9470HD	Belt - Gen.	51139	7435
Belt - Alt.; W/75A. Alt.; W/Cummins NT855G4, NT855G5 Eng.	5110156	♣9463HD	ED		
175DGFA			Belt - Fan	511P40	TR24489
Hose - Lower; W/Cummins 6Cta8.3C Eng.		21901	Belt - Gov.	511P41	7400
200DFBD; 220DFBE; 230DFBD; 250DFB6; 275DFCB; 300DFCB; 310DFCC; 350DFCC			EF		
Belt - Fan; W/Cummins NT855G4, NT855G5 Eng.	5110160	ⓉTR28412	Belt - Fan	511P40	TR24489
Belt - Alt.; W/35A. Alt.; W/Cummins NT855G4, NT855G5 Eng.	5110084	♣9470HD	HK; HN		
Belt - Alt.; W/75A. Alt.; W/Cummins NT855G4, NT855G5 Eng.	5110156	♣9463HD	Belt - Fan	5119	3460
620.750DFJA; 660DFJB; 800DFJB; 800DFJC; 900DFJC			JC		
Belt - Alt.; W/35A. Alt.; W/Cummins KTA38GI Eng.	511016102	♣K050345HD	Belt - Gen.	511P67	7350
A61			KB; KR		
Belt - Alt.; W/6A3.4 Eng.	511014713	Ⓣ7490	Belt - Fan; W/44" Belt O.C.	511P59	TR22434
AJ			Belt - Fan; W/48 1/4" Belt O.C.	51118	♣9480HD
Belt - Gen.	511P53	7320	Belt - Gen.	511P58	♣9360HD
CCK			L423		
Belt - Gen.	511P51	7380	Belt - W.P. & Alt.; W/High Mount Alt.		7495
DFEB; DFFA; DFFB			Belt - W.P. & Alt.; W/Low Mount Alt.		7512
Belt - Alt.; W/35A. Alt.; W/Cummins KTA19, KTTA19G Eng.	5110119	K050290	L634		
Belt - Alt.; W/45A. Alt.; W/Cummins KTA19, KTTA19G Eng.	511016105	K050355	Belt - W.P. & Alt.; W/Low Mount Alt.		7525
Belt - Alt.; W/75A. Alt.; W/Cummins KTA19, KTTA19G Eng.	5110161	K050370	LK		
Hose - Upper - Eng. To Pipe; W/Cummins KTA19, KTTA19 Eng.		24440	Belt - Gen.	511P55	7410
Hose - Upper - Pipe To Rad.; W/Cummins KTA19, KTTA19 Eng.		24440	RDJC		
Hose - Lower - Eng. To Pipe; W/Cummins KTA19, KTTA19 Eng.		24456	Belt - Gen.	511P66	7450
Hose - Lower - Pipe To Rad.; W/Cummins KTA19, KTTA19 Eng.		24456	RJC		
DFLB			Belt - Pump	511P66	7450
Belt - Alt.; W/35A. Alt.; W/Cummins KTA50-G2 Eng.	511016102	♣K050345HD	P & H		
Belt - Alt.; W/75A. Alt.; W/Cummins KTA50-G2 Eng.	511016102	Ⓣ♣K050345HD	187C; 287C		
DFLC			Belt - Gen.; W/Keel Cooled Eng.	T20773	TR28616
Belt - Alt.; W/35A. Alt.; W/Cummins KTA50-G2 Eng.	511016102	♣K050345HD	Belt - Fan, Gen. & Gov.; W/Keel Cooled Eng.		TR24638
Belt - Alt.; W/75A. Alt.; W/Cummins KTA50-G2 Eng.	511016102	Ⓣ♣K050345HD	387A		
DFLD			Belt - Fan & Gen.		TR28596
Belt - Alt.; W/35A. Alt.; W/Cummins KTA50-G2 Eng.	511016102	♣K050345HD	387B		
Belt - Alt.; W/75A. Alt.; W/Cummins KTA50-G2 Eng.	511016102	Ⓣ♣K050345HD	Belt - Fan & Gen.	T11343	TR28616
DRP			387C		
Belt - Fan	511P42	TR22373	Belt - Fan; W/261, 348, 522 Diesel Eng.	T18821	TR28483
DZB			Belt - Fan; Auto.; W/261, 348, 522 Diesel Eng.	T28782	Ⓣ♣9490HD
Belt - Gen.; W/44 1/4" Belt O.C.	511P56	7440	Belt - Gen.; W/261, 348, 522 Diesel Eng. ...	T15054	TR28437
			Belt - Gen. & Compr.; Auto.; W/261, 348, 522 Diesel Eng.		Ⓣ7541
			Belt - Fan & Gen.; W/261, 348, 522 Diesel Eng.	T13058	ⓉTR28570
			387H		
			Belt - Fan; W/261, 348, 522 Diesel Eng.	T18821	TR28483
			Belt - Fan; Auto.; W/261, 348, 522 Diesel Eng.	T28782	Ⓣ♣9490HD
			Belt - Gen.; W/261, 348, 522 Diesel Eng. ...	T15054	TR28437
			Belt - Gen. & Compr.; Auto.; W/261, 348, 522 Diesel Eng.		Ⓣ7541
			487C		
			Belt - Fan; W/261, 348, 522 Diesel Eng.	T18821	TR28483
			Belt - Fan; Auto.; W/261, 348, 522 Diesel Eng.	T28782	Ⓣ♣9490HD

ⓉTwo Required.

♣Standard Belt Available.

Belts and Coolant Hose for Power Units

Application	Mfr. Part No.	Our No.	Application	Mfr. Part No.	Our No.
P & H - Continued			Perkins - Continued		
487C - Continued			6.354 - Continued		
Belt - Gen.; W/261, 348, 522 Diesel Eng. ...	T15054	TR28437	Belt - Fan & Gen.; Ser. No. 8000251 & After; List 207, 208, 216; W/Vehicle Eng.	2612432	♣9550HD
Belt - Gen. & Compr.; Auto.; W/261, 348, 522 Diesel Eng.		②7541	L4		
Belt - Fan & Gen.; W/261, 348, 522 Diesel Eng.	T13058	②TR28570	Belt - Fan & Gen.	0070052	TR22517
487H			P3		
Belt - Fan; W/261, 348, 522 Diesel Eng.	T18821	TR28483	Belt - Fan & Gen.; W/46 3/4" Belt O.C.	0070063	TR24461
Belt - Fan; Auto.; W/261, 348, 522 Diesel Eng.	T28782	②♣9490HD	Belt - Fan & Gen.; W/51 1/8" Belt O.C.	0070053	TR28501
Belt - Gen.; W/261, 348, 522 Diesel Eng. ...	T15054	TR28437	P4		
Belt - Gen. & Compr.; Auto.; W/261, 348, 522 Diesel Eng.		②7541	Belt - Fan & Gen.; Ser. No. 2101013 & After	0070087	♣9415HD
687B			P6		
Belt - Fan & Gen.		②TR28616	Belt - Fan & Gen.; Ser. No. 3024802 & After; W/Vehicle Eng.	0070001	TR28501
687C			R6		
Belt - Fan; W/261, 348, 522 Diesel Eng.	T18821	TR28483	Belt - Fan & Gen.	0070052	TR22517
Belt - Fan; Auto.; W/261, 348, 522 Diesel Eng.	T28782	②♣9490HD	Sheppard		
Belt - Gen.; W/261, 348, 522 Diesel Eng. ...	T15054	TR28437	6C; 6D; 6E; 6F		
Belt - Gen. & Compr.; Auto.; W/261, 348, 522 Diesel Eng.		②7541	Belt - Fan & Gen.	0400251	TR22570
Belt - Fan & Gen.; W/261, 348, 522 Diesel Eng.	T13058	②TR28570	7D; 7E		
687H			Belt - Fan & Gen.	0400180	TR22625
Belt - Fan; W/261, 348, 522 Diesel Eng.	T18821	TR28483	8; 9		
Belt - Fan; Auto.; W/261, 348, 522 Diesel Eng.	T28782	②♣9490HD	Belt - Fan	0400140	♣9425HD
Belt - Gen.; W/261, 348, 522 Diesel Eng. ...	T15054	TR28437	Belt - Gen.	0400220	TR22322
Belt - Gen. & Compr.; Auto.; W/261, 348, 522 Diesel Eng.		②7541	13C; 13D; 13E; 13F		
Perkins			Belt - Fan & Gen.		TR22570
3.152			14; 14C		
Belt - W.P. & Gen.; W/48 1/4" Belt O.C.; W/Diesel Eng.	2612419	♣9480HD	Belt - Gen.	0400220	TR22322
Belt - W.P. & Gen.; W/50 1/4" Belt O.C.; W/Diesel Eng.	2612422	♣9500HD	16		
Belt - W.P. & Gen.; W/53 1/4" Belt O.C.; W/Diesel Eng.	2612429	♣9530HD	Belt - Fan & Gen.	0400050	7575
Belt - W.P. & Gen.; W/54 1/4" Belt O.C.; W/Diesel Eng. ...		♣9540HD	17		
4.99			Belt - Fan, Gen. & W.P.	0400130	TR22495
Belt - Fan & Gen.; Ser. No. 7004038 & Before; W/Agricultural, Vehicle Eng.	0070168	♣9385HD	Belt - Cooler	0400130	7495
Belt - Fan & Gen.; Ser. No. 7004039 & After; W/Agricultural, Vehicle Eng.	0070077	♣9390HD	17A; 19		
4.192			Belt - Fan, Gen. & W.P.	0400301	7405
Belt - Fan & Gen.; W/Vehicle Eng.	0070113	♣9550HD	Universal		
4.203			5 KW		
Belt - Fan & Gen.; Ser. No. 2600251 & After; List 156, 163; W/Vehicle Eng.	0070113	♣9550HD	Belt - W.P. & Alt.		7325
Belt - Fan & Gen.; Ser. No. 2600251 & After; List 165, 166; W/Vehicle Eng.	0070167	♣9440HD	Wisconsin		
4.270D			WPI430		
Belt - Fan & Gen.; Ser. No. 6200251 & After; W/Agricultural, Industrial Eng.	0070052	TR22517	Belt - W.P.		♣9380HD
6.305					
Belt - Fan & Gen.; Ser. No. 3500251 & After; List 162, 171; W/Vehicle Eng.	2612430	♣9540HD			
Belt - Fan & Gen.; Ser. No. 3500251 & After; List 172, 174; W/Vehicle Eng.	2612419	♣9480HD			
6.354					
Belt - Fan & Gen.; W/Industrial Eng.	2612432	♣9550HD			
Belt - Fan & Gen.; Ser. No. 8000251 & After; List 199, 206, 217; W/Vehicle Eng.	2612422	♣9500HD			

②Two Required.

♣Standard Belt Available.

Power Units

Belts and Coolant Hose for Lift & Industrial Trucks

Order Belts and Hose by Our Number. Manufacturers' Part Number is shown for reference only.

Application	Mfr. Part No.	Our No.	Application	Mfr. Part No.	Our No.
Allis-Chalmers			Allis-Chalmers - Continued		
510; 512			705D		
Allis-Chalmers 4-Cyl. 160			Allis-Chalmers 4-Cyl. 200 Diesel		
Belt - Fan & Alt.	233432	7380	Belt - Fan & Alt.; W/42A. Alt.	1011335	♣9525HD
Belt - W.P.	254075	♣9520HD	Hose - Upper		≈<21944
Hose - Upper		≈<20661		or	26504
		25251	706; 706B		
Hose - Lower		25252	Ford 4-Cyl.		
Allis-Chalmers 4-Cyl. 175 Diesel; Allis-Chalmers 4-Cyl. 200 Diesel			Belt - Fan		
Belt - Fan & Alt.	233489	②♣9420HD	Belt - Fan & Alt.	1017907	♣9313HD
Belt - W.P.	254075	♣9520HD	Hose - Upper	1016309	♣9525HD
Hose - Upper - Eng. To Pipe		24224			25253
Hose - Upper - Pipe To Rad.		24224	Perkins 4-Cyl. 203; Perkins 4-Cyl. 203 Diesel		
Hose - Lower - Eng. To Pipe		20267	Hose - Upper		
Hose - Lower - Pipe To Rad.		24224	25476		
600			706C		
Allis-Chalmers 4-Cyl. 160			Perkins 4-Cyl. 203		
Belt - Fan & Alt.	233432	7380	Hose - Upper		≈<20226
Belt - W.P.	254075	♣9520HD		or	25474
Hose - Upper		≈<20661	Perkins 4-Cyl. 203 Diesel		
		25251	Belt - Fan; Ser. No. 2618 & Before, Exc.		
Hose - Lower		25252	Ser. No. 2615 & 2617	1011991	♣9480HD
Allis-Chalmers 4-Cyl. 175 Diesel; Allis-Chalmers 4-Cyl. 200 Diesel			Belt - Fan; Ser. No. 2615, 2617, 2619 & After	1013057	♣9465HD
Belt - Fan & Alt.	233489	②♣9420HD	Belt - Fan & Alt.	255200	♣9510HD
Belt - W.P.	254075	♣9520HD	706D		
Hose - Upper - Eng. To Pipe		24224	Allis-Chalmers 4-Cyl. 200 Diesel		
Hose - Upper - Pipe To Rad.		24224	Belt - Fan & Alt.; W/42A. Alt.		
Hose - Lower - Eng. To Pipe		20267	Belt - Fan & Alt.; W/42A. Alt.	1011335	♣9525HD
Hose - Lower - Pipe To Rad.		24224	Hose - Upper		≈<21944
Allis-Chalmers 4-Cyl. Diesel				or	26504
Hose - Upper - Eng. To Pipe		24224	708C		
Hose - Upper - Pipe To Rad.		24224	Perkins 4-Cyl. 203		
Hose - Lower - Eng. To Pipe		20267	Hose - Upper		
Hose - Lower - Pipe To Rad.		24224		or	≈<20226
614; 621			≈<25474		
Allis-Chalmers 4-Cyl. 160			Perkins 4-Cyl. 203 Diesel		
Belt - Fan & Alt.	233432	7380	Belt - Fan; Ser. No. 2618 & Before, Exc.		
Belt - W.P.	254075	♣9520HD	Ser. No. 2615 & 2617	1011991	♣9480HD
Hose - Upper		≈<20661	Belt - Fan; Ser. No. 2615, 2617, 2619 & After	1013057	♣9465HD
		25251	Belt - Fan & Alt.	255200	♣9510HD
Hose - Lower		25252	Perkins 4-Cyl. 236 Diesel		
Allis-Chalmers 4-Cyl. 175 Diesel; Allis-Chalmers 4-Cyl. 200 Diesel			Belt - Fan & Alt.; W/55A. Alt.		
Belt - Fan & Alt.	233489	②♣9420HD	Hose - Upper		♣9520HD
Belt - W.P.	254075	♣9520HD			26519
Hose - Upper - Eng. To Pipe		24224	708D		
Hose - Upper - Pipe To Rad.		24224	Allis-Chalmers 4-Cyl. 200 Diesel		
Hose - Lower - Eng. To Pipe		20267	Belt - Fan & Alt.; W/42A. Alt.		
Hose - Lower - Pipe To Rad.		24224	Belt - Fan & Alt.; W/42A. Alt.	1011335	♣9525HD
705C			Hose - Upper		≈<21944
Perkins 4-Cyl. 203				or	26504
Hose - Upper		≈<20226	ACP100		
		25474	Allis-Chalmers 4-Cyl. 153		
Perkins 4-Cyl. 203 Diesel			Hose - Upper		
Belt - Fan; Ser. No. 2618 & Before, Exc. Ser. No. 2615 & 2617	1011991	♣9480HD	25530		
Belt - Fan; Ser. No. 2615, 2617, 2619 & After	1013057	♣9465HD	Allis-Chalmers 6-Cyl. 230		
Belt - Fan & Alt.	255200	♣9510HD	Hose - Upper		
			24228		
			Allis-Chalmers 6-Cyl. 262 Diesel		
			Belt - Fan & Alt.		
			4791039		
			♣9470HD		
			Hose - Upper		
			24228		
			Continental 4-Cyl. 135; Continental 4-Cyl. 163		
			Hose - Upper		
			≈<21794		
			or		
			25476		

♣Standard Belt Available.
②Two Required.

≈<Cut to Fit.

Belts and Coolant Hose for Lift & Industrial Trucks

Application	Mfr. Part No.	Our No.	Application	Mfr. Part No.	Our No.
Allis-Chalmers - Continued			Allis-Chalmers - Continued		
ACP100 - Continued			F40; F50; F60 - Continued		
Continental D262 Diesel			IH U4 - Continued		
Hose - Upper		26611	Belt - Gen.	48878D	♣9309HD
Hose - Lower		24228	FC; FD; FDS		
Continental F163			Allis-Chalmers 4-Cyl. 153; Allis-Chalmers 4-Cyl. 175 Diesel		
Hose - Upper		25478	Hose - Upper; Early		24228
Hose - Lower		25476	Hose - Upper; Late		24224
Continental F245			Hose - Lower; Early		24228
Hose - Upper		25478		or	26602
Waukesha FC133			Allis-Chalmers 6-Cyl. 230; Allis-Chalmers 6-Cyl. 230 Diesel; Allis-Chalmers 6-Cyl. 262 Diesel		
Hose - Upper		♣20573	Belt - Fan & Alt.	4791039	♣9470HD
	or	25473	Belt - Fan & Gen.	4707727	♣9451HD
Hose - Lower		24224	Hose - Upper		24228
AT			Hose - Lower; Early		24228
Allis-Chalmers 4-Cyl. 153; Allis-Chalmers 4-Cyl. 175 Diesel; Allis-Chalmers 6-Cyl. 230; Allis-Chalmers 6-Cyl. 230 Diesel; Allis-Chalmers 6-Cyl. 262 Diesel; Waukesha FC				or	26602
Belt - Fan & Alt.	4791039	♣9470HD	Waukesha FC		
Belt - Fan & Gen.	4707727	♣9451HD	Hose - Upper		♣21256
ATD; ATM; ATMD				or	26503
Allis-Chalmers 6-Cyl. 230; Allis-Chalmers 6-Cyl. 230 Diesel; Allis-Chalmers 6-Cyl. 262 Diesel			FDX; FL		
Belt - Fan & Alt.	4791039	♣9470HD	Allis-Chalmers 4-Cyl. 153; Allis-Chalmers 4-Cyl. 175 Diesel		
Belt - Fan & Gen.	4707727	♣9451HD	Belt - Fan & Alt.	4791039	♣9470HD
C40E			Belt - Fan & Gen.	4707727	♣9451HD
Continental F163			Hose - Upper; Early		24228
Belt - Fan & Alt.	4895398	♣9451HD	Hose - Upper; Late		24224
Hose - Upper		♣20957	Hose - Lower; Early		24228
	or	26501		or	26602
C40X			Allis-Chalmers 6-Cyl. 230; Allis-Chalmers 6-Cyl. 230 Diesel; Allis-Chalmers 6-Cyl. 262 Diesel		
Mitsubishi G420			Belt - Fan & Alt.	4791039	♣9470HD
Hose - Upper		26601	Belt - Fan & Gen.	4707727	♣9451HD
F			Hose - Upper		24228
Allis-Chalmers 4-Cyl. 153; Allis-Chalmers 4-Cyl. 175 Diesel			Hose - Lower; Early		24228
Belt - Fan & Alt.	4791039	♣9470HD		or	26602
Belt - Fan & Gen.	4707727	♣9451HD	Allis-Chalmers 6-Cyl. 230; Allis-Chalmers 6-Cyl. 230 Diesel; Allis-Chalmers 6-Cyl. 262 Diesel		
Hose - Upper; Early		24228	Belt - Fan & Alt.	4791039	♣9470HD
Hose - Upper; Late		24224	Belt - Fan & Gen.	4707727	♣9451HD
Hose - Lower; Early		24228	Hose - Upper		♣21256
	or	26602		or	26503
Allis-Chalmers 6-Cyl. 230; Allis-Chalmers 6-Cyl. 230 Diesel; Allis-Chalmers 6-Cyl. 262 Diesel			FL120		
Belt - Fan & Alt.	4791039	♣9470HD	Allis-Chalmers 6-Cyl. 230; Allis-Chalmers 6-Cyl. 230 Diesel; Allis-Chalmers 6-Cyl. 262 Diesel		
Belt - Fan & Gen.	4707727	♣9451HD	Belt - Fan & Alt.	4791039	♣9470HD
Hose - Upper		24228	Belt - Fan & Gen.	4707727	♣9451HD
Hose - Lower; Early		24228	FLS		
	or	26602	Allis-Chalmers 4-Cyl. 153; Allis-Chalmers 4-Cyl. 175 Diesel		
Waukesha FC			Hose - Upper; Early		24228
Belt - Fan & Alt.	4791039	♣9470HD	Hose - Upper; Late		24224
Belt - Fan & Gen.	4707727	♣9451HD	Hose - Lower; Early		24228
Hose - Upper		♣21256		or	26602
	or	26503	Allis-Chalmers 6-Cyl. 230; Allis-Chalmers 6-Cyl. 230 Diesel; Allis-Chalmers 6-Cyl. 262 Diesel		
F40; F50; F60			Belt - Fan & Alt.	4791039	♣9470HD
Allis-Chalmers 4-Cyl. 153; Allis-Chalmers 6-Cyl. 230			Belt - Fan & Gen.	4707727	♣9451HD
Belt - Fan & Alt.		♣9470HD	Hose - Upper		24228
IH U4			Hose - Lower; Early		24228
Belt - Fan	48032D	TR28386		or	26602

♣=Cut to Fit.

♣Standard Belt Available.

Lift & Industrial Trucks

Belts and Coolant Hose for Lift & Industrial Trucks

Application	Mfr. Part No.	Our No.	Application	Mfr. Part No.	Our No.
Allis-Chalmers - Continued			Allis-Chalmers - Continued		
FLS - Continued			FPDX60; FPDX70; FPDX80 - Continued		
Waukesha FC			Allis-Chalmers 4-Cyl. 153; Allis-Chalmers 4-Cyl. 175 Diesel - Continued		
Hose - Upper		≈<21256	Belt - Fan & Gen.		♣9451HD
		or	4707727		
		26503	Allis-Chalmers 6-Cyl. 230; Allis-Chalmers 6-Cyl. 230 Diesel; Allis-Chalmers 6-Cyl. 262 Diesel		
FP; FPD			Belt - Fan & Alt.		
Allis-Chalmers 4-Cyl. 153; Allis-Chalmers 4-Cyl. 175 Diesel			4791039		
Belt - Fan & Alt.		♣9470HD	Belt - Fan & Gen.		♣9451HD
4707727			4707727		
Hose - Upper; Early		24228	Belt - Hyd. Pump		♣9335HD
Hose - Upper; Late		24224	Waukesha FC		
Hose - Lower; Early		24228	Belt - Fan & Alt.		♣9470HD
		or	4707727		♣9451HD
		26602	Allis-Chalmers 4-Cyl. 153; Allis-Chalmers 4-Cyl. 175 Diesel		
Allis-Chalmers 6-Cyl. 230; Allis-Chalmers 6-Cyl. 230 Diesel; Allis-Chalmers 6-Cyl. 262 Diesel			Belt - Fan & Alt.		
Belt - Fan & Alt.		♣9470HD	4791039		♣9470HD
Belt - Fan & Gen.		♣9451HD	4707727		♣9451HD
Hose - Upper		24228	Hose - Upper; Early		24228
Hose - Lower; Early		24228	Hose - Upper; Late		24224
		or	Hose - Lower; Early		24228
		26602			or
					26602
Waukesha FC			Allis-Chalmers 6-Cyl. 230; Allis-Chalmers 6-Cyl. 230 Diesel; Allis-Chalmers 6-Cyl. 262 Diesel		
Belt - Fan & Alt.		♣9470HD	Belt - Fan & Alt.		♣9470HD
4791039			4791039		♣9451HD
Belt - Fan & Gen.		♣9451HD	Belt - Fan & Gen.		♣9451HD
4707727			4707727		
Hose - Upper		≈<21256	Hose - Upper		24228
		or	Hose - Lower; Early		24228
		26503			or
					26602
FPD60; FPD70; FPD80			Waukesha FC		
Allis-Chalmers 4-Cyl. 153; Allis-Chalmers 4-Cyl. 175 Diesel			Belt - Fan & Alt.		♣9470HD
Belt - Fan & Alt.		♣9470HD	4791039		
Belt - Fan & Gen.		♣9451HD	4707727		♣9451HD
Allis-Chalmers 6-Cyl. 230; Allis-Chalmers 6-Cyl. 230 Diesel; Allis-Chalmers 6-Cyl. 262 Diesel			Hose - Upper		24228
Belt - Fan & Alt.		♣9470HD	Hose - Lower; Early		24228
Belt - Fan & Gen.		♣9451HD			or
Belt - Hyd. Pump		♣9335HD			26602
Waukesha FC			Allis-Chalmers 4-Cyl. 153; Allis-Chalmers 4-Cyl. 175 Diesel; Waukesha FC		
Belt - Fan & Alt.		♣9470HD	Belt - Fan & Alt.		♣9470HD
4791039			4791039		♣9451HD
Belt - Fan & Gen.		♣9451HD	Belt - Fan & Gen.		♣9451HD
4707727			4707727		
Hose - Upper		≈<21256	Hose - Upper		≈<21256
		or	Hose - Upper		or
		26503			26503
FPDX			FPL20; FPL25; FPL50		
Allis-Chalmers 4-Cyl. 153; Allis-Chalmers 4-Cyl. 175 Diesel			Allis-Chalmers 4-Cyl. 153; Allis-Chalmers 4-Cyl. 175 Diesel; Waukesha FC		
Belt - Fan & Alt.		♣9470HD	Belt - Fan & Alt.		♣9470HD
4791039			4791039		♣9451HD
Belt - Fan & Gen.		♣9451HD	Belt - Fan & Gen.		♣9451HD
4707727			4707727		
Hose - Upper; Early		24228	Hose - Upper		24228
Hose - Upper; Late		24224	Hose - Lower; Early		24228
Hose - Lower; Early		24228			or
		or			26602
		26602	Allis-Chalmers 6-Cyl. 230; Allis-Chalmers 6-Cyl. 230 Diesel; Allis-Chalmers 6-Cyl. 262 Diesel		
Allis-Chalmers 6-Cyl. 230; Allis-Chalmers 6-Cyl. 230 Diesel; Allis-Chalmers 6-Cyl. 262 Diesel			Belt - Fan & Alt.		♣9470HD
Belt - Fan & Alt.		♣9470HD	4791039		♣9470HD
Belt - Fan & Gen.		♣9451HD	4707727		♣9451HD
Hose - Upper		24228	Hose - Upper		24228
Hose - Lower; Early		24228	Hose - Lower; Early		24228
		or			or
		26602			26602
Waukesha FC			Waukesha FC		
Belt - Fan & Alt.		♣9470HD	Hose - Upper		≈<21256
4791039					or
Belt - Fan & Gen.		♣9451HD			26503
4707727			FSL		
Hose - Upper		≈<21256	Allis-Chalmers 6-Cyl. 230; Allis-Chalmers 6-Cyl. 230 Diesel; Allis-Chalmers 6-Cyl. 262 Diesel		
		or	Belt - Fan & Alt.		♣9470HD
		26503	4791039		♣9451HD
FPDX60; FPDX70; FPDX80			Belt - Fan & Gen.		♣9451HD
Allis-Chalmers 4-Cyl. 153; Allis-Chalmers 4-Cyl. 175 Diesel			4707727		
Belt - Fan & Alt.		♣9470HD			

♣Standard Belt Available.

≈<Cut to Fit.

Belts and Coolant Hose for Lift & Industrial Trucks

Application	Mfr. Part No.	Our No.	Application	Mfr. Part No.	Our No.
Allis-Chalmers - Continued			Allis-Chalmers - Continued		
FSL20 Thru 120 Series			FT50		
Allis-Chalmers 4-Cyl. 153; Allis-Chalmers 4-Cyl. 175 Diesel			Allis-Chalmers 4-Cyl. 153; Allis-Chalmers 4-Cyl. 153 Diesel		
Hose - Upper; Early		24228	Hose - Upper; W/L.S. Safety Equip.		24224
Hose - Upper; Late		24224	Hose - Upper; W/O L.S. Safety Equip.		24228
Hose - Lower; Early		24228	Hose - Lower		24228
	or	26602		or	26602
Allis-Chalmers 6-Cyl. 230; Allis-Chalmers 6-Cyl. 230 Diesel; Allis-Chalmers 6-Cyl. 262 Diesel			FT100		
Hose - Upper		24228	Allis-Chalmers 4-Cyl. 182; Allis-Chalmers 4-Cyl. 182 Diesel; Allis-Chalmers 6-Cyl. 230; Allis-Chalmers 6-Cyl. 230 Diesel		
Hose - Lower; Early		24228	Belt - Fan	4707729	♣9425HD
	or	26602	Belt - Fan & Gen.	4707727	♣9451HD
Waukesha FC			FTB		
Hose - Upper		♣21256	Allis-Chalmers 4-Cyl. 153		
	or	26503	Belt - Fan & Alt.	4791039	♣9470HD
FT			Belt - Fan & Gen.	4707727	♣9451HD
Allis-Chalmers 4-Cyl. 153; Allis-Chalmers 4-Cyl. 175 Diesel			Allis-Chalmers 4-Cyl. 153 Diesel		
Belt - Fan & Alt.	4791039	♣9470HD	Belt - Fan & Gen.	4707726	♣9440HD
Belt - Fan & Gen.; W/44 3/8" Belt O.C.	4707726	♣9440HD	Allis-Chalmers 4-Cyl. 175 Diesel; Waukesha FC		
Belt - Fan & Gen.; W/45 3/8" Belt O.C.	4707727	♣9451HD	Belt - Fan & Alt.	4791039	♣9470HD
Allis-Chalmers 4-Cyl. 182; Allis-Chalmers 4-Cyl. 182 Diesel			Belt - Fan & Gen.	4707727	♣9451HD
Belt - Fan	4707729	♣9425HD	FTB30		
Belt - Fan & Gen.	4707727	♣9451HD	Waukesha FC		
Allis-Chalmers 6-Cyl. 230; Allis-Chalmers 6-Cyl. 230 Diesel; Allis-Chalmers 6-Cyl. 262 Diesel			Hose - Upper		♣21256
Belt - Fan & Alt.	4791039	♣9470HD		or	26503
Belt - Fan & Gen.	4707727	♣9451HD	Hose - Lower; Early		24220
Hose - Upper		24228	Hose - Lower; Late		24232
Hose - Lower		24228	FTB50		
	or	26602	Allis-Chalmers 4-Cyl. 153; Allis-Chalmers 4-Cyl. 153 Diesel		
Waukesha FC			Hose - Upper; W/L.S. Safety Equip.		
Belt - Fan & Alt.	4791039	♣9470HD			24224
Belt - Fan & Gen.; W/44 3/8" Belt O.C.	4707726	♣9440HD	Hose - Upper; W/O L.S. Safety Equip.		24224
Belt - Fan & Gen.; W/45 3/8" Belt O.C.	4707727	♣9451HD	Hose - Lower; W/L.S. Safety Equip.		24228
FT PL40			Hose - Lower; W/O L.S. Safety Equip.		24228
Allis-Chalmers 4-Cyl. 153; Allis-Chalmers 4-Cyl. 153 Diesel				or	26602
Hose - Upper; W/L.S. Safety Equip.		24224	FTBL		
Hose - Upper; W/O L.S. Safety Equip.		24224	Allis-Chalmers 4-Cyl. 153; Allis-Chalmers 4-Cyl. 175 Diesel; Waukesha FC		
Hose - Lower; W/L.S. Safety Equip.		24228	Belt - Fan & Alt.	4791039	♣9470HD
Hose - Lower; W/O L.S. Safety Equip.		24228	Belt - Fan & Gen.	4707727	♣9451HD
	or	26602	FTBL30		
FT20; FT25			Waukesha FC		
Waukesha FC			Hose - Lower; Early		24220
Hose - Upper		♣21256	Hose - Lower; Late		24232
	or	26503	FTBL50		
Hose - Lower; Early		24220	Allis-Chalmers 4-Cyl. 153; Allis-Chalmers 4-Cyl. 153 Diesel		
Hose - Lower; Late		24232	Hose - Upper; W/L.S. Safety Equip.		24224
FT30-15			Hose - Lower; W/L.S. Safety Equip.		24228
Allis-Chalmers 4-Cyl. 153; Allis-Chalmers 4-Cyl. 153 Diesel			Hose - Lower; W/O L.S. Safety Equip.		24228
Hose - Upper; W/L.S. Safety Equip.		24224		or	26602
Hose - Upper; W/O L.S. Safety Equip.		24228	FTD		
Hose - Lower		24228	Allis-Chalmers 4-Cyl. 153; Allis-Chalmers 4-Cyl. 153 Diesel		
	or	26602	Belt - Fan & Gen.	4707726	♣9440HD
FT30-24; FT40			Allis-Chalmers 4-Cyl. 182; Allis-Chalmers 4-Cyl. 182 Diesel		
Allis-Chalmers 4-Cyl. 153; Allis-Chalmers 4-Cyl. 153 Diesel			Belt - Fan	4707729	♣9425HD
Hose - Upper; W/L.S. Safety Equip.		24224	Belt - Fan & Gen.	4707727	♣9451HD
Hose - Upper; W/O L.S. Safety Equip.		24224			
Hose - Lower; W/L.S. Safety Equip.		24228			
Hose - Lower; W/O L.S. Safety Equip.		24228			
	or	26602			

♣=Cut to Fit.

♣Standard Belt Available.

Lift & Industrial Trucks

Belts and Coolant Hose for Lift & Industrial Trucks

Application	Mfr. Part No.	Our No.	Application	Mfr. Part No.	Our No.
Allis-Chalmers - Continued			Allis-Chalmers - Continued		
FTD - Continued			FTDX		
Allis-Chalmers 6-Cyl. 230; Allis-Chalmers 6-Cyl. 230 Diesel; Allis-Chalmers 6-Cyl. 262 Diesel			Allis-Chalmers 4-Cyl. 153; Allis-Chalmers 4-Cyl. 153 Diesel		
Belt - Fan & Alt.	4791039	♣9470HD	Belt - Fan & Gen.	4707726	♣9440HD
Belt - Fan & Gen.	4707727	♣9451HD	Allis-Chalmers 6-Cyl. 230; Allis-Chalmers 6-Cyl. 230 Diesel; Allis-Chalmers 6-Cyl. 262 Diesel		
Hose - Upper	24228		Belt - Fan & Alt.	4791039	♣9470HD
Hose - Lower	24228		Belt - Fan & Gen.	4707727	♣9451HD
	or	26602	Hose - Upper		24228
			Hose - Lower		24228
				or	26602
FTD30-15			FTDX30-15		
Allis-Chalmers 4-Cyl. 153; Allis-Chalmers 4-Cyl. 153 Diesel			Allis-Chalmers 4-Cyl. 153; Allis-Chalmers 4-Cyl. 153 Diesel		
Hose - Upper; W/L.S. Safety Equip.		24224	Hose - Upper; W/L.S. Safety Equip.		24224
Hose - Upper; W/O L.S. Safety Equip.		24228	Hose - Upper; W/O L.S. Safety Equip.		24228
Hose - Lower		24228	Hose - Lower		24228
	or	26602		or	26602
FTD30-24; FTD40			FTDX30-24; FTDX40		
Allis-Chalmers 4-Cyl. 153; Allis-Chalmers 4-Cyl. 153 Diesel			Allis-Chalmers 4-Cyl. 153; Allis-Chalmers 4-Cyl. 153 Diesel		
Hose - Upper; W/L.S. Safety Equip.		24224	Hose - Upper; W/L.S. Safety Equip.		24224
Hose - Upper; W/O L.S. Safety Equip.		24224	Hose - Upper; W/O L.S. Safety Equip.		24224
Hose - Lower; W/L.S. Safety Equip.		24228	Hose - Lower; W/L.S. Safety Equip.		24228
Hose - Lower; W/O L.S. Safety Equip.		24228	Hose - Lower; W/O L.S. Safety Equip.		24228
	or	26602		or	26602
FTD50			FTDXB		
Allis-Chalmers 4-Cyl. 153; Allis-Chalmers 4-Cyl. 153 Diesel			Allis-Chalmers 4-Cyl. 153; Allis-Chalmers 4-Cyl. 153 Diesel		
Hose - Upper; W/L.S. Safety Equip.		24224	Belt - Fan & Gen.	4707726	♣9440HD
Hose - Upper; W/O L.S. Safety Equip.		24228	FTDXB50		
Hose - Lower		24228	Allis-Chalmers 4-Cyl. 153; Allis-Chalmers 4-Cyl. 153 Diesel		
	or	26602	Hose - Upper; W/L.S. Safety Equip.		24224
Allis-Chalmers 4-Cyl. 182; Allis-Chalmers 4-Cyl. 182 Diesel; Allis-Chalmers 6-Cyl. 230; Allis-Chalmers 6-Cyl. 230 Diesel			Hose - Lower; W/L.S. Safety Equip.		24228
Belt - Fan	4707729	♣9425HD	Hose - Lower; W/O L.S. Safety Equip.		24228
Belt - Fan & Gen.	4707727	♣9451HD		or	26602
FTD70			FTL		
Allis-Chalmers 4-Cyl. 182; Allis-Chalmers 4-Cyl. 182 Diesel; Allis-Chalmers 6-Cyl. 230; Allis-Chalmers 6-Cyl. 230 Diesel			Allis-Chalmers 4-Cyl. 153		
Belt - Fan	4707729	♣9425HD	Belt - Fan & Alt.	4791039	♣9470HD
Belt - Fan & Gen.	4707727	♣9451HD	Belt - Fan & Gen.	4707727	♣9451HD
FTDB			Allis-Chalmers 4-Cyl. 153 Diesel		
Allis-Chalmers 4-Cyl. 153; Allis-Chalmers 4-Cyl. 153 Diesel			Belt - Fan & Gen.	4707726	♣9440HD
Belt - Fan & Gen.	4707726	♣9440HD	Allis-Chalmers 4-Cyl. 175 Diesel; Allis-Chalmers 6-Cyl. 230; Allis-Chalmers 6-Cyl. 230 Diesel; Allis-Chalmers 6-Cyl. 262 Diesel; Waukesha FC		
FTDB50			Belt - Fan & Alt.	4791039	♣9470HD
Allis-Chalmers 4-Cyl. 153; Allis-Chalmers 4-Cyl. 153 Diesel			Belt - Fan & Gen.	4707727	♣9451HD
Hose - Upper; W/L.S. Safety Equip.		24224	FTL20; FTL25		
Hose - Lower; W/L.S. Safety Equip.		24228	Waukesha FC		
Hose - Lower; W/O L.S. Safety Equip.		24228	Hose - Lower; Early		24220
	or	26602	Hose - Lower; Late		24232
FTDOA			FTL30-15		
Allis-Chalmers 6-Cyl. 230; Allis-Chalmers 6-Cyl. 230 Diesel; Allis-Chalmers 6-Cyl. 262 Diesel			Allis-Chalmers 4-Cyl. 153; Allis-Chalmers 4-Cyl. 153 Diesel		
Belt - Fan & Alt.	4791039	♣9470HD	Hose - Upper; W/L.S. Safety Equip.		24224
Belt - Fan & Gen.	4707727	♣9451HD	Hose - Upper; W/O L.S. Safety Equip.		24228
FTDOH			Hose - Lower		24228
Allis-Chalmers 4-Cyl. 182; Allis-Chalmers 4-Cyl. 182 Diesel; Allis-Chalmers 6-Cyl. 230; Allis-Chalmers 6-Cyl. 230 Diesel				or	26602
Belt - Fan	4707729	♣9425HD	FTL30-24; FTL40		
Belt - Fan & Gen.	4707727	♣9451HD	Allis-Chalmers 4-Cyl. 153; Allis-Chalmers 4-Cyl. 153 Diesel		
			Hose - Upper; W/L.S. Safety Equip.		24224
			Hose - Upper; W/O L.S. Safety Equip.		24224

♣Standard Belt Available.

Belts and Coolant Hose for Lift & Industrial Trucks

Application	Mfr. Part No.	Our No.	Application	Mfr. Part No.	Our No.
Allis-Chalmers - Continued			Allis-Chalmers - Continued		
FTL30-24; FTL40 - Continued			FTP - Continued		
Allis-Chalmers 4-Cyl. 153; Allis-Chalmers 4-Cyl. 153 Diesel - Continued			Allis-Chalmers 6-Cyl. 230; Allis-Chalmers 6-Cyl. 230 Diesel; Allis-Chalmers 6-Cyl. 262 Diesel		
Hose - Lower; W/L.S. Safety Equip.		24228	Belt - Fan & Alt.	4791039	♣9470HD
Hose - Lower; W/O L.S. Safety Equip.		24228	Belt - Fan & Gen.	4707727	♣9451HD
	or	26602	Hose - Upper		24228
			Hose - Lower		24228
				or	26602
FTL50			Waukesha FC		
Allis-Chalmers 4-Cyl. 153; Allis-Chalmers 4-Cyl. 153 Diesel			Belt - Fan & Alt.		
Hose - Upper; W/L.S. Safety Equip.		24224		4791039	♣9470HD
Hose - Upper; W/O L.S. Safety Equip.		24228	Belt - Fan & Gen.	4707727	♣9451HD
Hose - Lower		24228	FTP20		
	or	26602	Waukesha FC		
FTL60 Thru 100			Hose - Lower; Early		
Allis-Chalmers 6-Cyl. 230; Allis-Chalmers 6-Cyl. 230 Diesel; Allis-Chalmers 6-Cyl. 262 Diesel					24220
Hose - Upper		24228	Hose - Lower; Late		
Hose - Lower		24228			24232
	or	26602	FTP30; FTP40		
FTL70			Allis-Chalmers 4-Cyl. 153; Allis-Chalmers 4-Cyl. 153 Diesel		
Allis-Chalmers 6-Cyl. 230; Allis-Chalmers 6-Cyl. 230 Diesel; Allis-Chalmers 6-Cyl. 262 Diesel			Hose - Upper; W/L.S. Safety Equip.		
Belt - Fan & Alt.	4791039	♣9470HD			24224
Belt - Fan & Gen.	4707727	♣9451HD	Hose - Upper; W/O L.S. Safety Equip.		
FTL75					
Allis-Chalmers 4-Cyl. 182; Allis-Chalmers 4-Cyl. 182 Diesel; Allis-Chalmers 6-Cyl. 230; Allis-Chalmers 6-Cyl. 230 Diesel			Hose - Lower; W/L.S. Safety Equip.		
Belt - Fan	4707729	♣9425HD	Hose - Lower; W/O L.S. Safety Equip.		
Belt - Fan & Gen.	4707727	♣9451HD			24228
FTL80; FTL100					
Allis-Chalmers 6-Cyl. 230; Allis-Chalmers 6-Cyl. 230 Diesel; Allis-Chalmers 6-Cyl. 262 Diesel			FTPDP		
Belt - Fan & Alt.	4791039	♣9470HD	Allis-Chalmers 4-Cyl. 153; Allis-Chalmers 4-Cyl. 153 Diesel		
Belt - Fan & Gen.	4707727	♣9451HD	Belt - Fan & Gen.		
FTLB50					
Allis-Chalmers 4-Cyl. 153; Allis-Chalmers 4-Cyl. 153 Diesel			Belt - Fan & Gen.		
Belt - Fan & Gen.	4707726	♣9440HD	Allis-Chalmers 4-Cyl. 182; Allis-Chalmers 4-Cyl. 182 Diesel		
FTOH; FTOHL			Belt - Fan		
Allis-Chalmers 6-Cyl. 230; Allis-Chalmers 6-Cyl. 230 Diesel; Allis-Chalmers 6-Cyl. 262 Diesel			4707729		
Belt - Fan & Alt.	4791039	♣9470HD	Belt - Fan & Gen.		
Belt - Fan & Gen.	4707727	♣9451HD	4707727		
Hose - Upper		24228	Allis-Chalmers 6-Cyl. 230; Allis-Chalmers 6-Cyl. 230 Diesel; Allis-Chalmers 6-Cyl. 262 Diesel		
Hose - Lower		24228	Belt - Fan & Alt.		
	or	26602	4791039		
FTP			Belt - Fan & Gen.		
Allis-Chalmers 4-Cyl. 153			4707727		
Belt - Fan & Alt.	4791039	♣9470HD	Hose - Upper		
Belt - Fan & Gen.	4707727	♣9451HD	Hose - Upper; W/O L.S. Safety Equip.		
Allis-Chalmers 4-Cyl. 153 Diesel			Hose - Lower; W/L.S. Safety Equip.		
Belt - Fan & Gen.	4707726	♣9440HD	Hose - Lower; W/O L.S. Safety Equip.		
Allis-Chalmers 4-Cyl. 175 Diesel			24228		
Belt - Fan & Alt.	4791039	♣9470HD	24228		
Belt - Fan & Gen.	4707727	♣9451HD	or		
Allis-Chalmers 4-Cyl. 182; Allis-Chalmers 4-Cyl. 182 Diesel			26602		
Belt - Fan	4707729	♣9425HD	FTPDP30		
Belt - Fan & Gen.	4707727	♣9451HD	Allis-Chalmers 4-Cyl. 153; Allis-Chalmers 4-Cyl. 153 Diesel		
FTPDP30			Hose - Upper; W/L.S. Safety Equip.		
Allis-Chalmers 6-Cyl. 230; Allis-Chalmers 6-Cyl. 230 Diesel; Allis-Chalmers 6-Cyl. 262 Diesel			24224		
Belt - Fan & Alt.	4791039	♣9470HD	Hose - Upper; W/O L.S. Safety Equip.		
Belt - Fan & Gen.	4707727	♣9451HD	24224		
Hose - Upper		24228	Hose - Lower; W/L.S. Safety Equip.		
Hose - Lower		24228	Hose - Lower; W/O L.S. Safety Equip.		
	or	26602	24228		
FTPDP40			26602		
Allis-Chalmers 4-Cyl. 153; Allis-Chalmers 4-Cyl. 153 Diesel			FTPDP40		
Hose - Upper; W/L.S. Safety Equip.		24224	Allis-Chalmers 4-Cyl. 153; Allis-Chalmers 4-Cyl. 153 Diesel		
Hose - Upper; W/O L.S. Safety Equip.		24224	Hose - Upper; W/L.S. Safety Equip.		
Hose - Lower; W/L.S. Safety Equip.		24228	24224		
Hose - Lower; W/O L.S. Safety Equip.		24228	Hose - Upper; W/O L.S. Safety Equip.		
	or	26602	24228		
FTPDX			26602		
Allis-Chalmers 6-Cyl. 230; Allis-Chalmers 6-Cyl. 230 Diesel; Allis-Chalmers 6-Cyl. 262 Diesel			FTPDX		
Belt - Fan & Alt.	4791039	♣9470HD	Allis-Chalmers 6-Cyl. 230; Allis-Chalmers 6-Cyl. 230 Diesel; Allis-Chalmers 6-Cyl. 262 Diesel		
Belt - Fan & Gen.	4707727	♣9451HD	Belt - Fan & Alt.		
Hose - Upper		24228	4791039		
FTPDP40			4707727		
Allis-Chalmers 4-Cyl. 153; Allis-Chalmers 4-Cyl. 153 Diesel			♣9470HD		
Hose - Upper; W/L.S. Safety Equip.		24224	♣9451HD		
Hose - Upper; W/O L.S. Safety Equip.		24224	Hose - Upper		
Hose - Lower; W/L.S. Safety Equip.		24228	24228		
Hose - Lower; W/O L.S. Safety Equip.		24228	24228		
	or	26602	or		
FTPDX			26602		
Allis-Chalmers 6-Cyl. 230; Allis-Chalmers 6-Cyl. 230 Diesel; Allis-Chalmers 6-Cyl. 262 Diesel			FTPDP40		
Belt - Fan & Alt.	4791039	♣9470HD	Allis-Chalmers 4-Cyl. 153; Allis-Chalmers 4-Cyl. 153 Diesel		
Belt - Fan & Gen.	4707727	♣9451HD	Hose - Upper; W/L.S. Safety Equip.		
Hose - Upper		24228	24224		
FTPDP40			24228		
Allis-Chalmers 4-Cyl. 153; Allis-Chalmers 4-Cyl. 153 Diesel			Hose - Lower; W/O L.S. Safety Equip.		
Hose - Upper; W/L.S. Safety Equip.		24224	24228		
Hose - Upper; W/O L.S. Safety Equip.		24224	or		
Hose - Lower; W/L.S. Safety Equip.		24228	26602		
Hose - Lower; W/O L.S. Safety Equip.		24228			
	or	26602			

♣Standard Belt Available.

Lift & Industrial Trucks

Belts and Coolant Hose for Lift & Industrial Trucks

Application	Mfr. Part No.	Our No.	Application	Mfr. Part No.	Our No.	
Allis-Chalmers - Continued			Allis-Chalmers - Continued			
FTPDX - Continued			FTS; FTSD; FTSL60			
Allis-Chalmers 6-Cyl. 230; Allis-Chalmers 6-Cyl. 230 Diesel; Allis-Chalmers 6-Cyl. 262 Diesel - Continued			Allis-Chalmers 6-Cyl. 230; Allis-Chalmers 6-Cyl. 230 Diesel; Allis-Chalmers 6-Cyl. 262 Diesel			
Hose - Lower		24228	Belt - Fan & Alt.		4791039	♣9470HD
		or	Belt - Fan & Gen.		4707727	♣9451HD
		26602	FTXB50			
FTPL			Allis-Chalmers 4-Cyl. 153; Allis-Chalmers 4-Cyl. 153 Diesel			
Allis-Chalmers 6-Cyl. 230; Allis-Chalmers 6-Cyl. 230 Diesel; Allis-Chalmers 6-Cyl. 262 Diesel			Hose - Upper; W/L.S. Safety Equip.			24224
Belt - Fan & Alt.		4791039	Hose - Upper; W/O L.S. Safety Equip.		24224	
Belt - Fan & Gen.		4707727	Hose - Lower; W/L.S. Safety Equip.		24228	
		♣9470HD	Hose - Lower; W/O L.S. Safety Equip.		24228	
		♣9451HD			or	
					26602	
FTPL20			FU40			
Waukesha FC			Allis-Chalmers 4-Cyl. 153; Allis-Chalmers 4-Cyl. 175 Diesel; Waukesha FC			
Hose - Lower; Early		24220	Belt - Fan & Alt.		4791039	♣9470HD
Hose - Lower; Late		24232	Belt - Fan & Gen.		4707727	♣9451HD
FTPL30			P50			
Allis-Chalmers 4-Cyl. 153			Nissan H20 Diesel			
Belt - Fan & Alt.		4791039	Belt - Fan		21067K7320	6723
Belt - Fan & Gen.		4707727	Belt - W.P. & Alt.			7410
Hose - Upper; W/L.S. Safety Equip.		24224	Belt - Hyd. Pump			TR22588
Hose - Upper; W/O L.S. Safety Equip.		24224	RT; RTD; RTL40			
Hose - Lower; W/L.S. Safety Equip.		24228	Allis-Chalmers 4-Cyl. 149; Allis-Chalmers 4-Cyl. 175 Diesel			
Hose - Lower; W/O L.S. Safety Equip.		24228	Belt - Fan & Gen.		233432	7380
		or	Hose - Upper			≈20661
		26602			or	25251
Allis-Chalmers 4-Cyl. 153 Diesel			Automatic Transportation			
Belt - Fan & Gen.		4707726	GLF30; GLF40; GLF50; GLF60; GLF70; GLF80;			
Hose - Upper; W/L.S. Safety Equip.		24224	GLF100; GLFP30; GLFP40; GLFP50; GLFP60;			
Hose - Upper; W/O L.S. Safety Equip.		24224	GLFP70; GLFP80; GMF150; GMF160; GMF180;			
Hose - Lower; W/L.S. Safety Equip.		24228	GMF200			
Hose - Lower; W/O L.S. Safety Equip.		24228	Continental F162			
		or	Belt - Fan & Gen.; Early			♣9440HD
		26602	Belt - Fan & Gen.; Late			♣9490HD
Allis-Chalmers 4-Cyl. 175 Diesel			Baker			
Belt - Fan & Alt.		4791039	B80PD			
Belt - Fan & Gen.		4707727	Deutz 4-Cyl. Diesel			
		♣9470HD	Belt - Fan & Alt.			7570
		♣9451HD	B140PC			
Waukesha FC			Volkswagen 4-Cyl.			
Belt - Fan & Alt.		4791039	Belt - Trans.			④TR22711
Belt - Fan & Gen.		4707727	FD30; FD40; FD60; FG30			
Hose - Lower; Early		24220	Hercules QXD3			
Hose - Lower; Late		24232	Belt - Fan & Gen.		6Y9031	TR28423
FTPL40			FG60			
Allis-Chalmers 4-Cyl. 153; Allis-Chalmers 4-Cyl. 153 Diesel			Hercules QXD3			
Belt - Fan & Gen.		4707726	Belt - Fan & Gen.		14Y9031	TR30428
FTPL60			FGA030			
Allis-Chalmers 4-Cyl. 182; Allis-Chalmers 4-Cyl. 182 Diesel			Hercules IXA3			
Belt - Fan		4707729	Belt - Fan; W/42 1/4" Belt O.C.		717AF1	♣9420HD
Belt - Fan & Gen.		4707727	Belt - Fan; W/43 1/4" Belt O.C.		717AP1	♣9430HD
		♣9425HD	Belt - Fan & Gen.		717D1	TR24414
		♣9451HD	Hose - Upper			25474
Allis-Chalmers 6-Cyl. 230; Allis-Chalmers 6-Cyl. 230 Diesel						
Belt - Fan		4707729				
Belt - Fan & Gen.		4707727				
Hose - Upper		24228				
Hose - Lower		24228				
		or				
		26602				
Allis-Chalmers 6-Cyl. 262 Diesel						
Hose - Upper		24228				
Hose - Lower		24228				
		or				
		26602				

♣Standard Belt Available.
④Four Required.

≈Cut to Fit.

Belts and Coolant Hose for Lift & Industrial Trucks

Application	Mfr. Part No.	Our No.	Application	Mfr. Part No.	Our No.
Baker - Continued			Baker - Continued		
FGA050			FGD020; FGD025 - Continued		
Continental F162			Hercules IXA3 - Continued		
Belt - Fan	717AE1	▲9319HD	Belt - Fan & Gen.	717D1	TR24414
Belt - Fan & Gen.; W/43" Belt O.C.	7Y9031	TR20426	Hose - Upper		25474
Belt - Fan & Gen.; W/44 5/8" Belt O.C.	717AB1	7445	FGD030; FGD040; FGD050		
Belt - Alt.	717AD1	7250	Continental F162		
Hose - Upper		≈<20416	Belt - Fan	717AE1	▲9319HD
or		25474	Belt - Fan & Gen.; W/43" Belt O.C.	7Y9031	TR20426
Hose - Lower		25477	Belt - Fan & Gen.; W/44 5/8" Belt O.C.	717AB1	7445
Continental F162 LPG			Belt - Alt.	717AD1	7250
Hose - Upper		25804	Hose - Upper		≈<20416
Hose - Lower		25477	or		25474
Continental F163			Hose - Lower		25477
Belt - Alt.		7280	Continental F162 LPG		
Hose - Upper		≈<20416	Hose - Upper		25804
or		25474	Hose - Lower		25477
Hose - Lower		25477	Continental F163		
Continental F163 LPG			Belt - Alt.		7280
Hose - Upper		25804	Hose - Upper		≈<20416
Hose - Lower		25477	or		25474
Continental F227; Continental F245			Hose - Lower		25477
Belt - Fan	717AT1	▲9350HD	Continental F163 LPG		
Belt - Fan & Gen.		②7460	Hose - Upper		25804
Belt - Alt.		7280	Hose - Lower		25477
Hercules IXLB3			Continental F227; Continental F245		
Belt - Fan & Gen.	717C1	TR28423	Belt - Fan	717AT1	▲9350HD
Hose - Upper		≈<20416	Belt - Fan & Gen.		②7460
or		25482	Belt - Alt.		7280
Hercules QXD3			Hercules IXLB3		
Belt - Fan & Gen.	14Y9031	TR30428	Belt - Fan & Gen.	717C1	TR28423
Hose - Upper		24224	Hose - Upper		≈<20416
FGA070			or		25482
Continental F162			Hercules QXD3		
Belt - Fan	717AE1	▲9319HD	Belt - Fan & Gen.	14Y9031	TR30428
Belt - Fan & Gen.; W/43" Belt O.C.	7Y9031	TR20426	Hose - Upper		24224
Belt - Fan & Gen.; W/44 5/8" Belt O.C.	717AB1	7445	FGD060; FGD070; FGD080		
Belt - Alt.	717AD1	7250	Continental F162		
Continental F163			Belt - Fan	717AE1	▲9319HD
Belt - Alt.		7280	Belt - Fan & Gen.; W/43" Belt O.C.	7Y9031	TR20426
Continental F227			Belt - Fan & Gen.; W/44 5/8" Belt O.C.	717AB1	7445
Belt - Fan	717AT1	▲9350HD	Belt - Alt.	717AD1	7250
Belt - Fan & Gen.		②7460	Continental F163		
Belt - Alt.		7280	Belt - Alt.		7280
Continental F245			Continental F227		
Belt - Fan	717AT1	▲9350HD	Belt - Fan	717AT1	▲9350HD
Belt - Fan & Gen.		②7460	Belt - Fan & Gen.		②7460
Belt - Alt.		7280	Belt - Alt.		7280
Hose - Upper; 1860, 1883 Series		25804	Continental F245		
Hose - Lower; 1849 Series		25477	Belt - Fan	717AT1	▲9350HD
Hose - Lower; 1860, 1883 Series		25804	Belt - Fan & Gen.		②7460
Hercules IXLB3			Belt - Alt.		7280
Belt - Fan & Gen.	717C1	TR28423	Hose - Upper; 1860, 1883 Series		25804
Hercules QXD3			Hose - Lower; 1849 Series		25477
Belt - Fan & Gen.	14Y9031	TR30428	Hose - Lower; 1860, 1883 Series		25804
Hose - Upper		24224	Hercules IXLB3		
FGD020; FGD025			Belt - Fan & Gen.	717C1	TR28423
Hercules IXA3			Hercules QXD3		
Belt - Fan; W/42 1/4" Belt O.C.	717AF1	▲9420HD	Belt - Fan & Gen.	14Y9031	TR30428
Belt - Fan; W/43 1/4" Belt O.C.	717AP1	▲9430HD	Hose - Upper		24224

≈<Cut to Fit.
②Two Required.

▲Standard Belt Available.

Lift & Industrial Trucks

Belts and Coolant Hose for Lift & Industrial Trucks

Application	Mfr. Part No.	Our No.	Application	Mfr. Part No.	Our No.
Baker - Continued			Baker - Continued		
FGF020; FGF025			FIA050		
Hercules IXA3			Continental F162		
Belt - Fan; W/42 1/4" Belt O.C.	717AF1	♣9420HD	Belt - Fan	717AE1	♣9319HD
Belt - Fan; W/43 1/4" Belt O.C.	717AP1	♣9430HD	Belt - Fan & Gen.; W/43" Belt O.C.	7Y9031	TR20426
Belt - Fan & Gen.	717D1	TR24414	Belt - Fan & Gen.; W/44 5/8" Belt O.C.	717AB1	7445
Hose - Upper		25474	Belt - Alt.	717AD1	7250
FGF030; FGF040; FGF050			Hose - Upper		
Continental F162			or		
Belt - Fan	717AE1	♣9319HD	Hose - Lower		
Belt - Fan & Gen.; W/43" Belt O.C.	7Y9031	TR20426	or		
Belt - Fan & Gen.; W/44 5/8" Belt O.C.	717AB1	7445	Continental F162 LPG		
Belt - Alt.	717AD1	7250	Hose - Upper		
Hose - Upper; W/Man. Trans.		♣20416	Hose - Lower		
		25482	Continental F163		
Hose - Upper; W/Auto. Trans.; Early		♣20416	Belt - Alt.		
Hose - Upper; W/Auto. Trans.; Late		♣21794	Hose - Upper		
		25472	or		
Hose - Lower		25477	Hose - Lower		
Continental F163			Continental F163 LPG		
Belt - Alt.			Hose - Upper		
7280			Hose - Lower		
Continental F227; Continental F245			Continental F227; Continental F245		
Belt - Fan			Belt - Fan		
717AT1			♣9350HD		
Belt - Fan & Gen.			②7460		
Belt - Alt.			7280		
Hercules IXLB3			Hercules IXLB3		
Belt - Fan & Gen.			Belt - Fan & Gen.		
717C1			717C1		
TR28423			TR28423		
Hercules QXD3			Hercules QXD3		
Belt - Fan & Gen.			Belt - Fan & Gen.		
14Y9031			14Y9031		
TR30428			TR30428		
FGU40; FGU60			Hercules QXD3		
Continental F162			Hose - Upper		
Belt - Fan			or		
717AE1			TR30428		
Belt - Fan & Gen.; W/43" Belt O.C.			24224		
7Y9031			FIA070		
Belt - Fan & Gen.; W/44 5/8" Belt O.C.			Continental F162		
717AB1			Belt - Fan		
Belt - Alt.			717AE1		
717AD1			♣9319HD		
Continental F163			Belt - Fan & Gen.; W/43" Belt O.C.		
Belt - Alt.			7Y9031		
7280			TR20426		
Continental F227			Belt - Fan & Gen.; W/44 5/8" Belt O.C.		
Belt - Fan			717AB1		
717AT1			Belt - Alt.		
♣9350HD			717AD1		
②7460			Continental F163		
7280			Belt - Alt.		
Continental F245			7280		
Belt - Fan			Continental F227		
717AT1			Belt - Fan		
♣9350HD			717AT1		
②7460			♣9350HD		
7280			②7460		
Belt - Fan & Gen.			7280		
Belt - Alt.			Continental F245		
Hose - Upper			Belt - Fan		
or			717AT1		
26501			♣9350HD		
25474			②7460		
Hercules IXLB3			7280		
Belt - Fan & Gen.			Hose - Upper; 1860, 1883 Series		
717C1			25804		
TR28423			Hose - Lower; 1849 Series		
Hercules QXD3			25477		
Belt - Fan & Gen.			Hose - Lower; 1860, 1883 Series		
14Y9031			25804		
TR30428			Hercules IXLB3		
FIA030			Belt - Fan & Gen.		
Hercules IXA3			717C1		
Belt - Fan; W/42 1/4" Belt O.C.			TR28423		
717AF1			Hercules QXD3		
Belt - Fan; W/43 1/4" Belt O.C.			Belt - Fan & Gen.		
717AP1			14Y9031		
Belt - Fan & Gen.			TR30428		
717D1			24224		
Hose - Upper			FID020; FID025		
25474			Hercules IXA3		
FIA030			Belt - Fan; W/42 1/4" Belt O.C.		
Hercules IXA3			717AF1		
Belt - Fan; W/42 1/4" Belt O.C.			♣9420HD		
717AF1			Belt - Fan; W/43 1/4" Belt O.C.		
♣9430HD			717AP1		
TR24414			♣9430HD		
Hose - Upper					
25474					

♣Standard Belt Available.
②Two Required.

♣Cut to Fit.

Belts and Coolant Hose for Lift & Industrial Trucks

Application	Mfr. Part No.	Our No.	Application	Mfr. Part No.	Our No.
Baker - Continued			Baker - Continued		
FID020; FID025 - Continued			FIF020; FIF025		
Hercules IXA3 - Continued			Hercules IXA3		
Belt - Fan & Gen.	717D1	TR24414	Belt - Fan; W/42 1/4" Belt O.C.	717AF1	▲9420HD
FID030; FID040; FID050			Belt - Fan; W/43 1/4" Belt O.C.	717AP1	▲9430HD
Continental F162			Belt - Fan & Gen.	717D1	TR24414
Belt - Fan	717AE1	▲9319HD	Hose - Upper		25474
Belt - Fan & Gen.; W/43" Belt O.C.	7Y9031	TR20426	FIF030; FIF040; FIF050		
Belt - Fan & Gen.; W/44 5/8" Belt O.C.	717AB1	7445	Continental F162		
Belt - Alt.	717AD1	7250	Belt - Fan	717AE1	▲9319HD
Hose - Upper		≧20416	Belt - Fan & Gen.; W/43" Belt O.C.	7Y9031	TR20426
or		25474	Belt - Fan & Gen.; W/44 5/8" Belt O.C.	717AB1	7445
Hose - Lower		25477	Belt - Alt.	717AD1	7250
Continental F162 LPG			Hose - Upper; W/Man. Trans.		≧20416
Hose - Upper		25804	or		25482
Hose - Lower		25477	Hose - Upper; W/Auto. Trans.; Early		≧20416
Continental F163			Hose - Upper; W/Auto. Trans.; Late		≧21794
Belt - Alt.		7280	or		25472
Hose - Upper		≧20416	Hose - Lower		25477
or		25474	Continental F163		
Hose - Lower		25477	Belt - Alt.		7280
Continental F163 LPG			Continental F227; Continental F245		
Hose - Upper		25804	Belt - Fan	717AT1	▲9350HD
Hose - Lower		25477	Belt - Fan & Gen.		②7460
Continental F227; Continental F245			Belt - Alt.		7280
Belt - Fan	717AT1	▲9350HD	Hercules IXLB3		
Belt - Fan & Gen.		②7460	Belt - Fan & Gen.	717C1	TR28423
Belt - Alt.		7280	Hercules QXD3		
Hercules IXLB3			Belt - Fan & Gen.	14Y9031	TR30428
Belt - Fan & Gen.	717C1	TR28423	FJA020; FJA025; FJA030		
Hose - Upper		≧20416	Continental F226; Continental Y112		
or		25482	Belt - Fan & Alt.		②7417
Hercules QXD3			Hose - Upper		≧21660
Belt - Fan & Gen.	14Y9031	TR30428	or		25473
Hose - Upper		24224	Hose - Lower		≧21794
FID060; FID070; FID080			or		25480
Continental F162			FJA050		
Belt - Fan	717AE1	▲9319HD	Continental F162		
Belt - Fan & Gen.; W/43" Belt O.C.	7Y9031	TR20426	Belt - Fan	717AE1	▲9319HD
Belt - Fan & Gen.; W/44 5/8" Belt O.C.	717AB1	7445	Belt - Fan & Gen.; W/43" Belt O.C.	7Y9031	TR20426
Belt - Alt.	717AD1	7250	Belt - Fan & Gen.; W/44 5/8" Belt O.C.	717AB1	7445
Continental F163			Belt - Alt.	717AD1	7250
Belt - Alt.		7280	Hose - Upper		≧20416
Continental F227			or		25474
Belt - Fan	717AT1	▲9350HD	Hose - Lower		25477
Belt - Fan & Gen.		②7460	Continental F162 LPG		
Belt - Alt.		7280	Hose - Upper		25804
Continental F245			Hose - Lower		25477
Belt - Fan	717AT1	▲9350HD	Continental F163		
Belt - Fan & Gen.		②7460	Belt - Alt.		7280
Belt - Alt.		7280	Hose - Upper		≧20416
Hose - Upper; 1860, 1883 Series		25804	or		25474
Hose - Lower; 1849 Series		25477	Hose - Lower		25477
Hose - Lower; 1860, 1883 Series		25804	Continental F163 LPG		
Hercules IXLB3			Hose - Upper		25804
Belt - Fan & Gen.	717C1	TR28423	Hose - Lower		25477
Hercules QXD3			Continental F227; Continental F245		
Belt - Fan & Gen.	14Y9031	TR30428	Belt - Fan	717AT1	▲9350HD
Hose - Upper		24224	Belt - Fan & Gen.		②7460
			Belt - Alt.		7280

▲Standard Belt Available.
②Two Required.

≧Cut to Fit.

Lift & Industrial Trucks

Belts and Coolant Hose for Lift & Industrial Trucks

Application	Mfr. Part No.	Our No.	Application	Mfr. Part No.	Our No.
Baker - Continued			Baker - Continued		
FJA050 - Continued			FJD030 - Continued		
Hercules IXLB3			Continental F226		
Belt - Fan & Gen.	717C1	TR28423	Belt - Fan & Alt.		Ⓢ7417
Hose - Upper		≧20416	Hose - Upper		≧21660
	or	25482			25473
Hercules QXD3			Hose - Lower		≧21794
Belt - Fan & Gen.	14Y9031	TR30428			25480
Hose - Upper		24224	Continental F227; Continental F245		
FJA070			Belt - Fan	717AT1	♣9350HD
Continental F162			Belt - Fan & Gen.		Ⓢ7460
Belt - Fan	717AE1	♣9319HD	Belt - Alt.		7280
Belt - Fan & Gen.; W/43" Belt O.C.	7Y9031	TR20426	Continental Y112		
Belt - Fan & Gen.; W/44 5/8" Belt O.C.	717AB1	7445	Belt - Fan & Alt.		Ⓢ7417
Belt - Alt.	717AD1	7250	Hose - Upper		≧21660
Continental F163					25473
Belt - Alt.		7280	Hose - Lower		≧21794
Continental F227					25480
Belt - Fan	717AT1	♣9350HD	Hercules IXLB3		
Belt - Fan & Gen.		Ⓢ7460	Belt - Fan & Gen.	717C1	TR28423
Belt - Alt.		7280	Hose - Upper		≧20416
Continental F245					25482
Belt - Fan	717AT1	♣9350HD	Hercules QXD3		
Belt - Fan & Gen.		Ⓢ7460	Belt - Fan & Gen.	14Y9031	TR30428
Belt - Alt.		7280	Hose - Upper		24224
Hose - Upper; 1860, 1883 Series		25804	FJD040; FJD050		
Hose - Lower; 1849 Series		25477	Continental F162		
Hose - Lower; 1860, 1883 Series		25804	Belt - Fan	717AE1	♣9319HD
Hercules IXLB3			Belt - Fan & Gen.; W/43" Belt O.C.	7Y9031	TR20426
Belt - Fan & Gen.	717C1	TR28423	Belt - Fan & Gen.; W/44 5/8" Belt O.C.	717AB1	7445
Hercules QXD3			Belt - Alt.	717AD1	7250
Belt - Fan & Gen.	14Y9031	TR30428	Hose - Upper		≧20416
Hose - Upper		24224			25474
FJC030; FJD020; FJD025					25477
Continental F226; Continental Y112			Continental F162 LPG		
Belt - Fan & Alt.		Ⓢ7417	Hose - Upper		25804
Hose - Upper		≧21660	Hose - Lower		25477
	or	25473	Continental F163		
Hose - Lower		≧21794	Belt - Alt.		7280
	or	25480	Hose - Upper		≧20416
FJD030					25474
Continental F162					25477
Belt - Fan	717AE1	♣9319HD	Continental F163 LPG		
Belt - Fan & Gen.; W/43" Belt O.C.	7Y9031	TR20426	Hose - Upper		25804
Belt - Fan & Gen.; W/44 5/8" Belt O.C.	717AB1	7445	Hose - Lower		25477
Belt - Alt.	717AD1	7250	Continental F227; Continental F245		
Hose - Upper		≧20416	Belt - Fan	717AT1	♣9350HD
	or	25474	Belt - Fan & Gen.		Ⓢ7460
Hose - Lower		25477	Belt - Alt.		7280
Continental F162 LPG			Hercules IXLB3		
Hose - Upper		25804	Belt - Fan & Gen.	717C1	TR28423
Hose - Lower		25477	Hose - Upper		≧20416
Continental F163					25482
Belt - Alt.		7280	Hercules QXD3		
Hose - Upper		≧20416	Belt - Fan & Gen.	14Y9031	TR30428
	or	25474	Hose - Upper		24224
Hose - Lower		25477	FJD060; FJD070; FJD080		
Continental F163 LPG			Continental F162		
Hose - Upper		25804	Belt - Fan	717AE1	♣9319HD
Hose - Lower		25477	Belt - Fan & Gen.; W/43" Belt O.C.	7Y9031	TR20426
Continental F163			Belt - Fan & Gen.; W/44 5/8" Belt O.C.	717AB1	7445
Belt - Alt.		7280			
Hose - Upper		≧20416			
	or	25474			
Hose - Lower		25477			

≧Cut to Fit.
ⓈTwo Required.

♣Standard Belt Available.

Belts and Coolant Hose for Lift & Industrial Trucks

Application	Mfr. Part No.	Our No.	Application	Mfr. Part No.	Our No.
Baker - Continued			Baker - Continued		
FJD060; FJD070; FJD080 - Continued			FMA030		
Continental F162 - Continued			Continental F226; Continental Y112		
Belt - Alt	717AD1	7250	Belt - Fan & Alt		②7417
Continental F163			Hose - Upper		≧<21660
Belt - Alt		7280		or	25473
Continental F227			Hose - Lower		≧<21794
Belt - Fan	717AT1	♣9350HD		or	25480
Belt - Fan & Gen.		②7460	FMA050		
Belt - Alt		7280	Continental F162		
Continental F245			Belt - Fan	717AE1	♣9319HD
Belt - Fan	717AT1	♣9350HD	Belt - Fan & Gen.; W/43" Belt O.C.	7Y9031	TR20426
Belt - Fan & Gen.		②7460	Belt - Fan & Gen.; W/44 5/8" Belt O.C.	717AB1	7445
Belt - Alt		7280	Belt - Alt	717AD1	7250
Hose - Upper; 1860, 1883 Series		25804	Hose - Upper		≧<20416
Hose - Lower; 1849 Series		25477		or	25474
Hose - Lower; 1860, 1883 Series		25804	Hose - Lower		25477
Hercules IXLB3			Continental F162 LPG		
Belt - Fan & Gen.	717C1	TR28423	Hose - Upper		25804
Hercules QXD3			Hose - Lower		25477
Belt - Fan & Gen.	14Y9031	TR30428	Continental F163		
Hose - Upper		24224	Belt - Alt		7280
FJF020; FJF025			Hose - Upper		≧<20416
Continental F226; Continental Y112				or	25474
Belt - Fan & Alt		②7417	Hose - Lower		25477
Hose - Upper		≧<21660	Continental F163 LPG		
	or	25473	Hose - Upper		25804
Hose - Lower		≧<21794	Hose - Lower		25477
	or	25480	Continental F227; Continental F245		
FJF030; FJF040; FJF050			Belt - Fan	717AT1	♣9350HD
Continental F162			Belt - Fan & Gen.		②7460
Belt - Fan	717AE1	♣9319HD	Belt - Alt		7280
Belt - Fan & Gen.; W/43" Belt O.C.	7Y9031	TR20426	Hercules IXLB3		
Belt - Fan & Gen.; W/44 5/8" Belt O.C.	717AB1	7445	Belt - Fan & Gen.	717C1	TR28423
Belt - Alt	717AD1	7250	Hose - Upper		≧<20416
Hose - Upper; W/Man. Trans.		≧<20416		or	25482
	or	25482	Hercules QXD3		
Hose - Upper; W/Auto. Trans.; Early		≧<20416	Belt - Fan & Gen.	14Y9031	TR30428
Hose - Upper; W/Auto. Trans.; Late		≧<21794	Hose - Upper		24224
	or	25472	FMA070		
Hose - Lower		25477	Continental F162		
Continental F163			Belt - Fan	717AE1	♣9319HD
Belt - Alt		7280	Belt - Fan & Gen.; W/43" Belt O.C.	7Y9031	TR20426
Continental F227			Belt - Fan & Gen.; W/44 5/8" Belt O.C.	717AB1	7445
Belt - Fan	717AT1	♣9350HD	Belt - Alt	717AD1	7250
Belt - Fan & Gen.		②7460	Continental F163		
Belt - Alt		7280	Belt - Alt		7280
Continental F245			Continental F227		
Belt - Fan	717AT1	♣9350HD	Belt - Fan	717AT1	♣9350HD
Belt - Fan & Gen.		②7460	Belt - Fan & Gen.		②7460
Belt - Alt		7280	Belt - Alt		7280
Hose - Upper; 1860, 1883 Series		25804	Continental F245		
Hose - Lower; 1849 Series		25477	Belt - Fan	717AT1	♣9350HD
Hose - Lower; 1860, 1883 Series		25804	Belt - Fan & Gen.		②7460
Hercules IXLB3			Belt - Alt		7280
Belt - Fan & Gen.	717C1	TR28423	Hose - Upper; 1860, 1883 Series		25804
Hercules QXD3			Hose - Lower; 1849 Series		25477
Belt - Fan & Gen.	14Y9031	TR30428	Hose - Lower; 1860, 1883 Series		25804
Hose - Upper		24224	Hercules IXLB3		
FMA030			Belt - Fan & Gen.	717C1	TR28423
Continental F226; Continental Y112					
Belt - Fan & Alt		②7417			
Hose - Upper		≧<21660			
	or	25473			
Hose - Lower		≧<21794			
	or	25480			

♣Standard Belt Available.
≧<Cut to Fit.

②Two Required.

Lift & Industrial Trucks

Belts and Coolant Hose for Lift & Industrial Trucks

Application	Mfr. Part No.	Our No.	Application	Mfr. Part No.	Our No.
Baker - Continued			Baker - Continued		
FMA070 - Continued			FMD040; FMD050 - Continued		
Hercules QXD3			Continental F162 - Continued		
Belt - Fan & Gen.	14Y9031	TR30428	Hose - Upper		≈<20416
Hose - Upper		24224		or	25474
FMC030; FMD020; FMD025			Hose - Lower		25477
Continental F226; Continental Y112			Continental F162 LPG		
Belt - Fan & Alt.		②7417	Hose - Upper		25804
Hose - Upper		≈<21660	Hose - Lower		25477
		or			
Hose - Lower		≈<21794	Continental F163		
		or	Belt - Alt.		7280
		25480	Hose - Upper		≈<20416
FMD030				or	25474
Continental F162			Hose - Lower		25477
Belt - Fan	717AE1	♣9319HD	Continental F163 LPG		
Belt - Fan & Gen.; W/43" Belt O.C.	7Y9031	TR20426	Hose - Upper		25804
Belt - Fan & Gen.; W/44 5/8" Belt O.C.	717AB1	7445	Hose - Lower		25477
Belt - Alt.	717AD1	7250	Continental F227; Continental F245		
Hose - Upper		≈<20416	Belt - Fan	717AT1	♣9350HD
		or	Belt - Fan & Gen.		②7460
Hose - Lower		25474	Belt - Alt.		7280
		25477	Hercules IXLB3		
Continental F162 LPG			Belt - Fan & Gen.	717C1	TR28423
Hose - Upper		25804	Hose - Upper		≈<20416
Hose - Lower		25477		or	25482
Continental F163			Hercules QXD3		
Belt - Alt.		7280	Belt - Fan & Gen.	14Y9031	TR30428
Hose - Upper		≈<20416	Hose - Upper		24224
		or	FMD060; FMD070; FMD080		
Hose - Lower		25474	Continental F162		
		25477	Belt - Fan	717AE1	♣9319HD
Continental F163 LPG			Belt - Fan & Gen.; W/43" Belt O.C.	7Y9031	TR20426
Hose - Upper		25804	Belt - Fan & Gen.; W/44 5/8" Belt O.C.	717AB1	7445
Hose - Lower		25477	Belt - Alt.	717AD1	7250
Continental F226			Continental F163		
Belt - Fan & Alt.		②7417	Belt - Alt.		7280
Hose - Upper		≈<21660	Continental F227		
		or	Belt - Fan	717AT1	♣9350HD
Hose - Lower		≈<21794	Belt - Fan & Gen.		②7460
		or	Belt - Alt.		7280
		25480	Continental F245		
Continental F227; Continental F245			Belt - Fan	717AT1	♣9350HD
Belt - Fan	717AT1	♣9350HD	Belt - Fan & Gen.		②7460
Belt - Fan & Gen.		②7460	Belt - Alt.		7280
Belt - Alt.		7280	Continental F245		
Continental Y112			Belt - Fan	717AT1	♣9350HD
Belt - Fan & Alt.		②7417	Belt - Fan & Gen.		②7460
Hose - Upper		≈<21660	Belt - Alt.		7280
		or	Hose - Upper; 1860, 1883 Series		25804
Hose - Lower		≈<21794	Hose - Lower; 1849 Series		25477
		or	Hose - Lower; 1860, 1883 Series		25804
		25480	Hercules IXLB3		
Hercules IXLB3			Belt - Fan & Gen.	717C1	TR28423
Belt - Fan & Gen.	717C1	TR28423	Hercules QXD3		
Hose - Upper		≈<20416	Belt - Fan & Gen.	14Y9031	TR30428
		or	Hose - Upper		24224
		25482	FMF020; FMF025		
Hercules QXD3			Continental F226; Continental Y112		
Belt - Fan & Gen.	14Y9031	TR30428	Belt - Fan & Alt.		②7417
Hose - Upper		24224			≈<21660
FMD040; FMD050			Hose - Upper		or
Continental F162					25473
Belt - Fan	717AE1	♣9319HD	Hose - Lower		≈<21794
Belt - Fan & Gen.; W/43" Belt O.C.	7Y9031	TR20426		or	25480
Belt - Fan & Gen.; W/44 5/8" Belt O.C.	717AB1	7445			
Belt - Alt.	717AD1	7250			

②Two Required.
♣Standard Belt Available.

≈<Cut to Fit.

Belts and Coolant Hose for Lift & Industrial Trucks

Application	Mfr. Part No.	Our No.	Application	Mfr. Part No.	Our No.
Baker - Continued			Case		
FMF030; FMF040; FMF050			580B		
Continental F162			Case 4-Cyl. 188; Case 4-Cyl. 188 Diesel		
Belt - Fan	717AE1	♣9319HD	Belt - Fan & Alt.	A38824	♣9490HD
Belt - Fan & Gen.; W/43" Belt O.C.	7Y9031	TR20426	580CK Forklift		
Belt - Fan & Gen.; W/44 5/8" Belt O.C.	717AB1	7445	Case 4-Cyl. 159		
Belt - Alt.	717AD1	7250	Belt - Fan & Alt.	A38824	♣9490HD
Hose - Upper; W/Man. Trans.		≧20416	Hose - Upper		24432
or		25482	Hose - Lower		20957
Hose - Upper; W/Auto. Trans.; Early		≧20416	Case 4-Cyl. 188; Case 4-Cyl. 188 Diesel		
Hose - Upper; W/Auto. Trans.; Late		≧21794	Belt - Fan & Alt.	A38824	♣9490HD
or		25472	Hose - Upper - Eng. To W.P.		24432
Hose - Lower		25477	Hose - Upper - Eng. To Rad.		24432
Continental F163			Hose - Lower - Eng. To Rad.		24428
Belt - Alt.		7280	584		
Continental F227			Case 4-Cyl. 188; Case 4-Cyl. 188 Diesel		
Belt - Fan	717AT1	♣9350HD	Belt - Fan & Alt.	A38824	♣9490HD
Belt - Fan & Gen.		②7460	584C		
Belt - Alt.		7280	Case 4-Cyl. 207 Diesel		
Continental F245			Belt - Fan & Alt.	D73446	♣9520HD
Belt - Fan	717AT1	♣9350HD	Hose - Upper		20206
Belt - Fan & Gen.		②7460	584D		
Belt - Alt.		7280	Case 4-Cyl. 188 Diesel		
Hose - Upper; 1860, 1883 Series		25804	Belt - Fan & Alt.	D73446	♣9520HD
Hose - Lower; 1849 Series		25477	Hose - Upper		21379
Hose - Lower; 1860, 1883 Series		25804	584E		
Hercules IXLB3			Case 4-Cyl. 390 Diesel		
Belt - Fan & Gen.	717C1	TR28423	Belt - Fan & Alt.	J911559	♣K080620HD
Hercules QXD3			585		
Belt - Fan & Gen.	14Y9031	TR30428	Case 4-Cyl. 188; Case 4-Cyl. 188 Diesel		
Hose - Upper		24224	Belt - Fan & Alt.	A38824	♣9490HD
FRH20			585C		
Hercules QXD3			Case 4-Cyl. 207 Diesel		
Belt - Fan & Gen.	4Y9031	3340	Belt - Fan & Alt.	D73446	♣9520HD
FRT80			Hose - Upper		20206
Continental F245			585D		
Belt - Fan & Gen.		②7460	Case 4-Cyl. 188 Diesel		
Hose - Upper		≧20046	Belt - Fan & Alt.	D73446	♣9520HD
or		26501	Hose - Upper		21379
Hose - Lower		25474	585E		
FTD020; FTD025			Case 4-Cyl. 390 Diesel		
Hercules IXA3			Belt - Fan & Alt.	J903099	♣K080620HD
Hose - Upper		25474	585G		
UT40			Case 4-Cyl. 239 Diesel		
Continental F245			Belt - Alt.	86982450	♣K080590HD
Belt - Fan & Gen.		②7460	586		
Hose - Upper		≧20046	Case 4-Cyl. 188; Case 4-Cyl. 188 Diesel		
or		26501	Belt - Fan & Alt.	A38824	♣9490HD
Hose - Lower		25474	586C		
Bobcat			Case 4-Cyl. 207 Diesel		
V417			Belt - Fan & Alt.	D73446	♣9520HD
Kubota 4-Cyl. 3.3 L Diesel			Hose - Upper		20206
Belt - A.C.	6730819	♣9365HD			
Belt - Alt.	6686655	7516			

≧Cut to Fit.
②Two Required.

♣Standard Belt Available.

Lift & Industrial Trucks

Belts and Coolant Hose for Lift & Industrial Trucks

Application	Mfr. Part No.	Our No.	Application	Mfr. Part No.	Our No.
Case - Continued			Caterpillar - Continued		
586D			T30C - Continued		
Case 4-Cyl. 188 Diesel			Caterpillar 1404 - Continued		
Belt - Fan & Alt.	D73446	▲9520HD	Belt - Fan & Alt.; W/49 5/8" Belt O.C.		7495
Hose - Upper		21379	Belt - Fan & Alt.; W/50 1/4" Belt O.C.	3P130	▲9500HD
586E			Belt - P.S. & W.P.	7N510	7380
Case 4-Cyl. 390 Diesel			T30D		
Belt - Fan & Alt.	J911559	▲K080620HD	Peugeot XN1P		
Belt - Fan, Alt. & W.P.	J911559	▲K080620HD	Belt - W.P. & Alt.	617117	7400
Hose - Upper		26505	T35B		
Hose - Lower		26519	Continental F163		
586G; 588G			Belt - Fan & Alt.; W/36 1/4" Belt O.C.	372448	▲9360HD
Case 4-Cyl. 239 Diesel			Belt - Fan & Alt.; W/37 1/4" Belt O.C.	303291	▲9370HD
Belt - Alt.	86982450	▲K080590HD	Belt - Fan & Alt.; W/50 1/4" Belt O.C.	3P130	▲9500HD
M4K			Belt - P.S.	303288	9279
Cummins 4-Cyl. 3.9 L Diesel; Cummins 6-Cyl. 5.9 L Diesel			Hose - Upper		25474
Belt - Fan & Alt.	J911557	▲K080560HD	Hose - Lower		≈<21660
Caterpillar					or
HT4			T35D		
Caterpillar D311 Diesel			Peugeot XN1P		
Belt - Fan	4F7956	TR34495	Belt - W.P. & Alt.	617117	7400
Belt - Gov.	5B7168	▲9390HD	T40		
Belt - Starter	6B5653	TR24438	Continental F163		
R40; R80; RC60			Belt - Fan & Alt.; W/36 1/4" Belt O.C.	372448	▲9360HD
Perkins 4-Cyl. 236 Diesel			Belt - Fan & Alt.; W/37 1/4" Belt O.C.	303291	▲9370HD
Belt - Fan & Alt.		▲9500HD	Belt - P.S.	303288	9279
T25			Perkins 3-Cyl. 145		
Continental F163			Belt - Fan & Alt.	314850	▲9550HD
Belt - Fan & Alt.; W/36 1/4" Belt O.C.	372448	▲9360HD	T40B		
Belt - Fan & Alt.; W/37 1/4" Belt O.C.	303291	▲9370HD	Continental F163		
Belt - Fan & Alt.; W/50 1/4" Belt O.C.	3P130	▲9500HD	Belt - Fan & Alt.; W/36 1/4" Belt O.C.	372448	▲9360HD
Belt - P.S.	303288	9279	Belt - Fan & Alt.; W/37 1/4" Belt O.C.	303291	▲9370HD
Hose - Lower		≈<21660	Belt - Fan & Alt.; W/50 1/4" Belt O.C.	3P130	▲9500HD
		or	Belt - P.S.	303288	9279
			Hose - Upper		25474
T25D			Hose - Lower		≈<21660
Peugeot XN1P					or
Belt - W.P. & Alt.	617117	7400	T40C		
T30			Caterpillar 1404		
Continental F163			Belt - Fan & Alt.; W/47 5/8" Belt O.C.	57931	7475
Belt - Fan & Alt.; W/36 1/4" Belt O.C.	372448	▲9360HD	Belt - Fan & Alt.; W/49 5/8" Belt O.C.		7495
Belt - Fan & Alt.; W/37 1/4" Belt O.C.	303291	▲9370HD	Belt - Fan & Alt.; W/50 1/4" Belt O.C.	3P130	▲9500HD
Belt - Fan & Alt.; W/50 1/4" Belt O.C.	3P130	▲9500HD	Belt - P.S. & W.P.	7N510	7380
Belt - P.S.	303288	9279	T40D		
Hose - Lower		≈<21660	Peugeot XN1P		
		or	Belt - W.P. & Alt.; Ser. No. 2YB1 & After	2W2531	7440
			Belt - W.P. & Alt.; Ser. No. 8EB1 & After	7W0717	7375
T30B			Hose - Upper; Ser. No. 2YB1 & After		26611
Continental F163			Hose - Lower; Ser. No. 8EB1 & After		25476
Belt - Fan & Alt.; W/36 1/4" Belt O.C.	372448	▲9360HD	T40DSA		
Belt - Fan & Alt.; W/37 1/4" Belt O.C.	303291	▲9370HD	Peugeot XN1P		
Belt - Fan & Alt.; W/50 1/4" Belt O.C.	3P130	▲9500HD	Belt - W.P. & Alt.	5M8137	▲9500HD
Belt - P.S.	303288	9279	Hose - Upper		20573
Hose - Upper		25474			or
Hose - Lower		≈<21660			25527
		or	T45B		
			Continental F163		
T30C			Belt - Fan & Alt.; W/36 1/4" Belt O.C.	372448	▲9360HD
Caterpillar 1404			Belt - Fan & Alt.; W/37 1/4" Belt O.C.	303291	▲9370HD
Belt - Fan & Alt.; W/47 5/8" Belt O.C.	57931	7475			

▲Standard Belt Available.

≈<Cut to Fit.

Belts and Coolant Hose for Lift & Industrial Trucks

Application	Mfr. Part No.	Our No.	Application	Mfr. Part No.	Our No.
Caterpillar - Continued			Caterpillar - Continued		
T45B - Continued			T60 - Continued		
Continental F163 - Continued			Continental F163 - Continued		
Belt - Fan & Alt.; W/50 1/4" Belt O.C.	3P130	♣9500HD	Belt - P.S.	303288	9279
Belt - P.S.	303288	9279	Hose - Lower		≈<21660
Hose - Upper		25474		or	25473
Hose - Lower		≈<21660			
	or	25473			
T50			Perkins 3-Cyl. 145		
Continental F163			T60B		
Belt - Fan & Alt.; W/36 1/4" Belt O.C.	372448	♣9360HD	Caterpillar 1404		
Belt - Fan & Alt.; W/37 1/4" Belt O.C.	303291	♣9370HD	Belt - Fan & Alt.; W/47 5/8" Belt O.C.	57931	7475
Belt - P.S.	303288	9279	Belt - Fan & Alt.; W/49 5/8" Belt O.C.		7495
Hose - Lower		≈<21660	Belt - Fan & Alt.; W/50 1/4" Belt O.C.	3P130	♣9500HD
	or	25473			
Perkins 3-Cyl. 145			Continental F163		
Belt - Fan & Alt.	314850	♣9550HD	Belt - Fan & Alt.; W/36 1/4" Belt O.C.	372448	♣9360HD
			Belt - Fan & Alt.; W/37 1/4" Belt O.C.	303291	♣9370HD
			Belt - P.S.	303288	9279
			Hose - Upper		25474
			Hose - Lower		≈<21660
				or	25473
T50B			T60C; T80C; T100C; T110C; T120C		
Caterpillar 1404			Caterpillar 1404		
Belt - Fan & Alt.; W/47 5/8" Belt O.C.	57931	7475	Belt - Fan & Alt.; W/49 5/8" Belt O.C.		7495
Belt - Fan & Alt.; W/49 5/8" Belt O.C.		7495	Belt - Fan & Alt.; W/50 1/4" Belt O.C.	3P130	♣9500HD
Belt - Fan & Alt.; W/50 1/4" Belt O.C.	3P130	♣9500HD	Belt - P.S. & W.P.	7N510	7380
Continental F163			Continental F227		
Belt - Fan & Alt.; W/36 1/4" Belt O.C.	372448	♣9360HD	Belt - Fan & Alt.; Ser. No. 33L1221 & Before	303291	♣9370HD
Belt - Fan & Alt.; W/37 1/4" Belt O.C.	303291	♣9370HD	Belt - Fan & Alt.; Ser. No. 33L1222 & After	8N3504	♣9395HD
Belt - P.S.	303288	9279	Belt - Fan & P.S.; Ser. No. 33L1222 & After	303291	♣9370HD
Hose - Upper		25474			
Hose - Lower		≈<21660			
	or	25473			
T50C			T165; T180; T200; T300; T400		
Caterpillar 1404			IH UV345; IH UV392		
Belt - Fan & Alt.; W/47 5/8" Belt O.C.	57931	7475	Belt - Fan & Alt.	1N3010	7640
Belt - Fan & Alt.; W/49 5/8" Belt O.C.		7495	Belt - Fan & Air Brake Compr.	1N9310	7500
Belt - Fan & Alt.; W/50 1/4" Belt O.C.	3P130	♣9500HD	Hose - Lower		26523
Belt - P.S. & W.P.	7N510	7380			
T50D			TC30		
Peugeot XN1P			Continental F163		
Belt - W.P. & Alt.; Ser. No. 2YB1 & After	2W2531	7440	Hose - Lower		≈<21660
Belt - W.P. & Alt.; Ser. No. 8EB1 & After	7W0717	7375		or	25473
Hose - Upper; Ser. No. 2YB1 & After		26611			
Hose - Lower; Ser. No. 8EB1 & After		25476			
T50DSA			TC30C; TC40C; TC50C		
Peugeot XN1P			Continental F163		
Belt - W.P. & Alt.	5M8137	♣9500HD	Belt - Fan & Alt.; W/36 1/4" Belt O.C.	372448	♣9360HD
Hose - Upper		20573	Belt - Fan & Alt.; W/37 1/4" Belt O.C.	303291	♣9370HD
	or	25527	Belt - Fan & Alt.; W/50 1/4" Belt O.C.	3P130	♣9500HD
			Belt - P.S.	303288	9279
			Hose - Lower		24224
T55B			TC60C		
Caterpillar 1404			Continental F163		
Belt - Fan & Alt.; W/47 5/8" Belt O.C.	57931	7475	Belt - Fan & Alt.; W/36 1/4" Belt O.C.	372448	♣9360HD
Belt - Fan & Alt.; W/49 5/8" Belt O.C.		7495	Belt - Fan & Alt.; W/37 1/4" Belt O.C.	303291	♣9370HD
Belt - Fan & Alt.; W/50 1/4" Belt O.C.	3P130	♣9500HD	Belt - Fan & Alt.; W/50 1/4" Belt O.C.	3P130	♣9500HD
Continental F163			Belt - P.S.	303288	9279
Belt - Fan & Alt.; W/36 1/4" Belt O.C.	372448	♣9360HD	Hose - Lower		24224
Belt - Fan & Alt.; W/37 1/4" Belt O.C.	303291	♣9370HD			
Belt - P.S.	303288	9279	Continental F227		
T60			Hose - Upper; Ser. No. 33L1221 & Before		
Continental F163				or	≈<20416
Belt - Fan & Alt.; W/36 1/4" Belt O.C.	372448	♣9360HD			25482
Belt - Fan & Alt.; W/37 1/4" Belt O.C.	303291	♣9370HD			

≈<Cut to Fit.

♣Standard Belt Available.

Lift & Industrial Trucks

Belts and Coolant Hose for Lift & Industrial Trucks

Application	Mfr. Part No.	Our No.	Application	Mfr. Part No.	Our No.
Caterpillar - Continued			Caterpillar - Continued		
TC60D			V35C - Continued		
Peugeot XN1P			Caterpillar 1404 - Continued		
Belt - W.P. & Alt.; Ser. No. 2YB1 & After	2W2531	7440	Hose - Lower - Eng. To Pipe		≈<20661
Belt - W.P. & Alt.; Ser. No. 8EB1 & After	7W0717	7375		or	25251
Hose - Upper; Ser. No. 2YB1 & After		26611	Hose - Lower - Pipe To Rad.		≈<20791
Hose - Lower; Ser. No. 8EB1 & After		25476	Continental F163		
TC60DSA			Belt - Fan & Alt.		
Peugeot XN1P				62923	7495
Belt - W.P. & Alt.	5M8137	♣9500HD	V35D		
Hose - Upper		20573	Peugeot XN1P		
	or	25527	Belt - Fan & Alt.		
TC80C; TC100C; TC110C; TC120C				617117	7400
Continental F227			V40		
Hose - Upper; Ser. No. 33L1221 & Before		≈<20416	Continental F163		
	or	25482	Belt - Fan & Alt.		
V25D				303291	♣9370HD
Peugeot XN1P			Belt - P.S.		
Belt - Fan & Alt.	617117	7400		303291	♣9370HD
V30			Perkins 3-Cyl. 145		
Continental F163			Belt - Fan & Alt.		
Belt - Fan & Alt.	303291	♣9370HD		314850	♣9550HD
Belt - P.S.	303291	♣9370HD	V40B		
Perkins 3-Cyl. 145			Continental F163		
Belt - Fan & Alt.	314850	♣9550HD	Belt - Fan & Alt.		
V30B				303291	♣9370HD
Continental F163			Belt - P.S.		
Belt - Fan & Alt.	303291	♣9370HD		303291	♣9370HD
Belt - P.S.	303291	♣9370HD	Hose - Lower		
Hose - Lower		≈<21660	Perkins 3-Cyl. 145		
Perkins 3-Cyl. 145			Belt - Fan & Alt.		
Belt - Fan & Alt.	314850	♣9550HD		314850	♣9550HD
V30C			V40C		
Caterpillar 1404			Caterpillar 1404		
Belt - Fan & Alt.	62923	7495	Belt - Fan & Alt.		
Belt - W.P.	7N510	7380	Belt - W.P.		
Hose - Lower - Eng. To Pipe		≈<20661	Hose - Lower - Eng. To Pipe		
	or	25251			
Hose - Lower - Pipe To Rad.		≈<20791	Hose - Lower - Pipe To Rad.		
Continental F163			Continental F163		
Belt - Fan & Alt.	62923	7495	Belt - Fan & Alt.		
V30D			V40D		
Peugeot XN1P			Perkins		
Belt - Fan & Alt.	617117	7400	Belt - Fan & Alt.; W/44 1/8" Belt O.C.		
V35B				2W2531	7440
Continental F163			Belt - Fan & Alt.; W/45 1/8" Belt O.C.		
Belt - Fan & Alt.	303291	♣9370HD		053536	7450
Belt - P.S.	303291	♣9370HD	Peugeot XN1P		
Hose - Lower		≈<21660	Belt - Fan & Alt.		
Perkins 3-Cyl. 145				7W0717	7375
Belt - Fan & Alt.	314850	♣9550HD	V40DSA		
V35C			Peugeot XN1P		
Caterpillar 1404			Belt - Fan & Alt.		
Belt - Fan & Alt.	62923	7495		5M8137	♣9500HD
Belt - W.P.	7N510	7380	Hose - Upper		
Continental F163			Hose - Lower - Eng. To Pipe		
Belt - Fan & Alt.	6A3858	♣9500HD	Hose - Lower - Pipe To Rad.		
Hose - Upper		≈<20611	≈<20065		
Perkins 4-Cyl. 236			V41		
Belt - Fan & Alt.	302191	♣9510HD	Continental F163		
V41B			Continental F163		
Continental F163			Belt - Fan & Alt.		
Belt - Fan & Alt.	6A3858	♣9500HD	Belt - Fan & Alt.		
Hose - Upper		≈<20611	Hose - Upper		

♣Standard Belt Available.

≈<Cut to Fit.

Belts and Coolant Hose for Lift & Industrial Trucks

Application	Mfr. Part No.	Our No.	Application	Mfr. Part No.	Our No.
Caterpillar - Continued			Caterpillar - Continued		
V41B - Continued			V50DSA - Continued		
Continental F227			Peugeot XN1P - Continued		
Hose - Upper		≈20814	Hose - Lower - Eng. To Pipe		24224
Hose - Lower		20450	Hose - Lower - Pipe To Rad.		≈20065
	or	25474	V51		
Perkins 4-Cyl. 236			Continental F163		
Belt - Fan & Alt.	302191	♣9510HD	Belt - Fan & Alt.	6A3858	♣9500HD
V45B			Hose - Upper		≈20611
Continental F163			Perkins 4-Cyl. 236		
Belt - Fan & Alt.	303291	♣9370HD	Belt - Fan & Alt.	302191	♣9510HD
Belt - P.S.	303291	♣9370HD	V51B; V55B		
Hose - Lower		≈21660	Continental F227		
Perkins 3-Cyl. 145			Belt - Fan & Alt.		
Belt - Fan & Alt.	314850	♣9550HD		303291	♣9370HD
V45C			Hose - Upper		≈20814
Caterpillar 1404			Hose - Lower		20450
Belt - Fan & Alt.	62923	7495		or	25474
Belt - W.P.	7N510	7380	Perkins 4-Cyl. 236		
Hose - Lower - Eng. To Pipe		≈20661	Belt - Fan & Alt.	302191	♣9510HD
	or	25251	V60		
Hose - Lower - Pipe To Rad.		≈20791	Continental F163		
Continental F163			Belt - Fan & Alt.		
Belt - Fan & Alt.	62923	7495		6A3858	♣9500HD
V50			Hose - Upper		≈20611
Continental F163			Perkins 4-Cyl. 236		
Belt - Fan & Alt.	303291	♣9370HD	Belt - Fan & Alt.	302191	♣9510HD
Belt - P.S.	303291	♣9370HD	V60B		
Perkins 3-Cyl. 145			Continental F163		
Belt - Fan & Alt.	314850	♣9550HD	Belt - Fan & Alt.		
V50B				6A3858	♣9500HD
Continental F163			Hose - Upper		
Belt - Fan & Alt.	303291	♣9370HD			≈20611
Belt - P.S.	303291	♣9370HD	Continental F227		
Hose - Lower		≈21660	Hose - Upper		
Perkins 3-Cyl. 145					≈20814
Belt - Fan & Alt.	314850	♣9550HD	Hose - Lower		
V50C					20450
Caterpillar 1404				or	25474
Belt - Fan & Alt.	62923	7495	Perkins 4-Cyl. 236		
Belt - W.P.	7N510	7380	Belt - Fan & Alt.	302191	♣9510HD
Hose - Lower - Eng. To Pipe		≈20661	V60C		
	or	25251	Perkins 4-Cyl. 236		
Hose - Lower - Pipe To Rad.		≈20791	Belt - Fan & Alt.		
Continental F163					♣9625HD
Belt - Fan & Alt.	62923	7495	Belt - W.P.		
V50D					♣9505HD
Perkins			Hose - Lower		
Belt - Fan & Alt.; W/44 1/8" Belt O.C.	2W2531	7440			25477
Belt - Fan & Alt.; W/45 1/8" Belt O.C.	053536	7450	V60D		
Peugeot XN1P			Perkins 4-Cyl. 236		
Belt - Fan & Alt.	7W0717	7375	Belt - Fan & Alt.; W/61 1/4" Belt O.C.		
V50DSA				3C4970	♣9610HD
Peugeot XN1P			Belt - Fan & Alt.; W/62 1/4" Belt O.C.		
Belt - Fan & Alt.	5M8137	♣9500HD		9L1183	♣9620HD
Hose - Upper		25526	Belt - W.P.		
				2P6212	♣9505HD
			Hose - Lower		
					25477
			V60DSA		
			Peugeot XN1P		
			Belt - Fan & Alt.		
				5M8137	♣9500HD
			V60E		
			Perkins 4-Cyl. 236		
			Belt - Fan		
				8M8336	♣9620HD
			Belt - W.P.		
				2P6212	♣9505HD
			Belt - Alt.		
				9L1183	♣9620HD
			Hose - Lower		
					25477

♣Standard Belt Available.

≈Cut to Fit.

Lift & Industrial Trucks

Belts and Coolant Hose for Lift & Industrial Trucks

Application	Mfr. Part No.	Our No.	Application	Mfr. Part No.	Our No.
Caterpillar - Continued			Caterpillar - Continued		
V70C			V120 - Continued		
Perkins 4-Cyl. 236			Perkins 4-Cyl. 236		
Belt - Fan & Alt.		♣9625HD	Belt - Fan & Alt.	7L5001	♣9580HD
Belt - W.P.	2P6212	♣9505HD	Belt - P.S.; W/36 1/8" Belt O.C.	617108	7360
Hose - Lower		25477	Belt - P.S.; W/53 1/4" Belt O.C.	680610	♣9530HD
V70D			Hose - Upper 26611		
Perkins 4-Cyl. 236			Hose - Lower 26506		
Belt - Fan & Alt.; W/61 1/4" Belt O.C.	3C4970	♣9610HD	V130		
Belt - Fan & Alt.; W/62 1/4" Belt O.C.	9L1183	♣9620HD	Perkins 4-Cyl. 236 Diesel		
Belt - W.P.	2P6212	♣9505HD	Belt - Fan & Alt. 680610 ♣9530HD		
Hose - Lower		25477	V140		
V70E			Caterpillar 3208 Diesel		
Perkins 4-Cyl. 236			Hose - Upper ≍21379		
Belt - Fan 8M8336		♣9620HD	Hose - Lower 26510		
Belt - W.P. 2P6212		♣9505HD	Ford 6-Cyl. 240		
Belt - Alt. 9L1183		♣9620HD	Belt - Fan & Alt. 3P0130 ♣9500HD		
Hose - Lower 25477			Perkins 4-Cyl. 236		
V80C			Belt - Fan & Alt. 7L5001 ♣9580HD		
Perkins 4-Cyl. 236			Belt - P.S.; W/36 1/8" Belt O.C. 617108 7360		
Belt - Fan & Alt. ♣9625HD			Belt - P.S.; W/53 1/4" Belt O.C. 680610 ♣9530HD		
Belt - W.P. 2P6212		♣9505HD	Hose - Upper 26611		
Hose - Lower 25477			Hose - Lower 26506		
V80D			Perkins 4-Cyl. 236 Diesel		
Perkins 4-Cyl. 236			Belt - Fan & Alt. 680610 ♣9530HD		
Belt - Fan & Alt.; W/61 1/4" Belt O.C.	3C4970	♣9610HD	V150		
Belt - Fan & Alt.; W/62 1/4" Belt O.C.	9L1183	♣9620HD	Perkins 4-Cyl. 236 Diesel		
Belt - W.P. 2P6212		♣9505HD	Belt - Fan & Alt. ♣9540HD		
Hose - Lower 25477			V160		
V80E			Caterpillar 3208 Diesel		
Perkins 4-Cyl. 236			Belt - Fan & Alt.; W/Single Belt 4S6209 ♣9650HD		
Belt - Fan 8M8336		♣9620HD	Belt - Fan & Alt.; W/61 5/8" Belt O.C. ♣9610HD		
Belt - W.P. 2P6212		♣9505HD	Belt - Fan & Alt.; W/Dual Belts 8S5154 ②♣9650HD		
Belt - Alt. 9L1183		♣9620HD	Belt - P.S. 5M8137 ♣9500HD		
Hose - Lower 25477			Hose - Upper ≍21379		
V100			Hose - Lower 26510		
Caterpillar 3208 Diesel			Continental 235; Perkins 6-Cyl. 354		
Hose - Upper ≍21379			Belt - Fan & Alt. 6A9558 ♣9610HD		
Hose - Lower 26510			Hose - Upper 26509		
Ford 6-Cyl. 240			Hose - Lower 26511		
Belt - Fan & Alt. 3P0130 ♣9500HD			V160B		
Perkins 4-Cyl. 236			Caterpillar 3208 Diesel		
Belt - Fan & Alt. 7L5001		♣9580HD	Belt - Fan & Alt.; W/Single Belt 4S6209 ♣9650HD		
Belt - P.S.; W/36 1/8" Belt O.C.	617108	7360	Belt - Fan & Alt.; W/Dual Belts 8S5154 ②♣9650HD		
Belt - P.S.; W/53 1/4" Belt O.C.	680610	♣9530HD	Belt - Fan & Alt.; W/61 5/8" Belt O.C. ♣9610HD		
Hose - Upper 26611			Belt - Belt; W/O Aux. Rad. ♣9500HD		
Hose - Lower 26506			Hose - Upper ≍21379		
V110			Hose - Lower 26510		
Perkins 4-Cyl. 236 Diesel			Continental 235; Perkins 6-Cyl. 354		
Belt - Fan & Alt. 680610 ♣9530HD			Hose - Upper 26509		
V120			Hose - Lower 26511		
Caterpillar 3208 Diesel			V160D		
Hose - Upper ≍21379			Ford V-8 351		
Hose - Lower 26510			Belt - Fan 7565		
Ford 6-Cyl. 240			Belt - Alt. 7430		
Belt - Fan & Alt. 3P0130 ♣9500HD			V160E		
V120			Caterpillar 3208 Diesel		
Caterpillar 3208 Diesel			Belt - Fan & Alt. 8S5154 ②♣9650HD		
Hose - Upper ≍21379					
Hose - Lower 26510					
Ford 6-Cyl. 240					
Belt - Fan & Alt. 3P0130 ♣9500HD					

♣Standard Belt Available.
②Two Required.

≍Cut to Fit.

Belts and Coolant Hose for Lift & Industrial Trucks

Application	Mfr. Part No.	Our No.	Application	Mfr. Part No.	Our No.
Caterpillar - Continued			Caterpillar - Continued		
V160E - Continued			V200 - Continued		
Caterpillar 3208 Diesel - Continued			Perkins 6-Cyl. 354 - Continued		
Belt - W.P.	5M8137	▲9500HD	Hose - Lower		26511
Belt - P.S.	8N3504	▲9395HD	V200B		
V160HF			Caterpillar 3208 Diesel		
Caterpillar 3145 Diesel			Hose - Upper		≈21379
Belt - Fan & Alt.	688546	②▲9630HD	Hose - Lower		26510
V180			Continental 235; Perkins 6-Cyl. 354		
Caterpillar 3208 Diesel			Hose - Upper		26509
Belt - Fan & Alt.; W/Single Belt	4S6209	▲9650HD	Hose - Lower		26511
Belt - Fan & Alt.; W/61 5/8" Belt O.C.		▲9610HD	V200ES		
Belt - Fan & Alt.; W/Dual Belts	8S5154	②▲9650HD	Caterpillar 3208 Diesel		
Belt - P.S.	5M8137	▲9500HD	Belt - Fan & Alt.	8S5154	②▲9650HD
Hose - Upper		≈21379	Belt - W.P.	5M8137	▲9500HD
Hose - Lower		26510	Belt - P.S.	8N3504	▲9395HD
Continental 235; Perkins 6-Cyl. 354			V200HF		
Belt - Fan & Alt.	6A9558	▲9610HD	Caterpillar 3145 Diesel		
Hose - Upper		26509	Belt - Fan & Alt.	688546	②▲9630HD
Hose - Lower		26511	V225		
V180B			Caterpillar 3145 Diesel		
Caterpillar 3208 Diesel			Belt - Fan & Alt.	688546	②▲9630HD
Belt - Fan & Alt.; W/Single Belt	4S6209	▲9650HD	Ford V-8 351		
Belt - Fan & Alt.; W/Dual Belts	8S5154	②▲9650HD	Belt - Fan & Alt.	617140	②▲9540HD
Belt - Fan & Alt.; W/61 5/8" Belt O.C.		▲9610HD	V225B		
Belt - Belt; W/O Aux. Rad.		▲9500HD	Caterpillar 3208 Diesel		
Hose - Upper		≈21379	Hose - Upper		≈21379
Hose - Lower		26510	Hose - Lower		26510
Continental 235; Perkins 6-Cyl. 354			V225HF		
Hose - Upper		26509	Caterpillar 3145 Diesel		
Hose - Lower		26511	Belt - Fan & Alt.	688546	②▲9630HD
V180E			V250B		
Caterpillar 3208 Diesel			Caterpillar 3208 Diesel		
Belt - Fan & Alt.	8S5154	②▲9650HD	Hose - Upper		≈21379
Belt - W.P.	5M8137	▲9500HD	Hose - Lower		26510
Belt - P.S.	8N3504	▲9395HD	V300		
V180HF			Caterpillar 3208 Diesel		
Caterpillar 3145 Diesel			Belt - Fan & Alt.; W/Single Belt	4S6209	▲9650HD
Belt - Fan & Alt.	688546	②▲9630HD	Belt - Fan & Alt.; W/61 5/8" Belt O.C.		▲9610HD
V200			Belt - Fan & Alt.; W/Dual Belts	8S5154	②▲9650HD
Caterpillar 3145 Diesel			Belt - P.S.	5M8137	▲9500HD
Belt - Fan & Alt.	688546	②▲9630HD	Hose - Upper		≈21379
Caterpillar 3208 Diesel			Hose - Lower		26510
Belt - Fan & Alt.; W/Single Belt	4S6209	▲9650HD	Continental 235; Perkins 6-Cyl. 354		
Belt - Fan & Alt.; W/61 5/8" Belt O.C.		▲9610HD	Belt - Fan & Alt.	6A9558	▲9610HD
Belt - Fan & Alt.; W/Dual Belts	8S5154	②▲9650HD	Hose - Upper		26509
Belt - P.S.	5M8137	▲9500HD	Hose - Lower		26511
Hose - Upper		≈21379	V300B		
Hose - Lower		26510	Caterpillar 3208 Diesel		
Continental 235			Hose - Upper		≈21379
Belt - Fan & Alt.	6A9558	▲9610HD	Hose - Lower		26510
Hose - Upper		26509	Continental 235; Perkins 6-Cyl. 354		
Hose - Lower		26511	Hose - Upper		26509
Ford V-8 351			Hose - Lower		26511
Belt - Fan & Alt.	617140	②▲9540HD	V300B		
Perkins 6-Cyl. 354			Caterpillar 3208 Diesel		
Belt - Fan & Alt.	6A9558	▲9610HD	Hose - Upper		≈21379
Hose - Upper		26509	Hose - Lower		26510

▲Standard Belt Available.
≈Cut to Fit.

②Two Required.

Belts and Coolant Hose for Lift & Industrial Trucks

Application	Mfr. Part No.	Our No.	Application	Mfr. Part No.	Our No.
Caterpillar - Continued			Champ - Continued		
V330B			300		
Caterpillar 3208 Diesel			Chrysler 6-Cyl. 230		
Hose - Upper		≈21379	Belt - Fan & Gen.	1092505	TR24476
Hose - Lower		26510	Belt - C.S. & P.S.		7330
VC40D			350		
Peugeot XN1P			Chrysler 6-Cyl. 225		
Belt - Fan & Alt.	617117	7400	Hose - Upper		25480
VC60D			Chrysler 6-Cyl. 230		
Perkins			Belt - Fan & Gen.		
Belt - Fan & Alt.; W/44 1/8" Belt O.C.	2W2531	7440	Belt - P.S.; W/32 3/4" Belt O.C.	1092505	TR24476
Belt - Fan & Alt.; W/45 1/8" Belt O.C.	053536	7450	Belt - P.S.; W/38" Belt O.C.		TR22322
Peugeot XN1P			Belt - P.S.; W/38" Belt O.C.		
Belt - Fan & Alt.	7W0717	7375			TR22373
VC60DSA			600		
Peugeot XN1P			Chrysler 6-Cyl. 230		
Hose - Upper		25526	Belt - Fan & Gen.	1092505	TR24476
Hose - Lower - Eng. To Pipe		24224	Belt - C.S. & P.S.		7330
Hose - Lower - Pipe To Rad.		≈20065	700		
Champ			IH BD269 Diesel		
44HL			Belt - Fan & Gen.		
Chrysler 6-Cyl. 230					
Belt - Fan & Gen.	1092505	TR24476	C40		
Belt - P.S.; W/32 3/4" Belt O.C.		TR22322	Continental F163		
Belt - P.S.; W/38" Belt O.C.		TR22373	Hose - Lower		
Hose - Upper		26601			
Hose - Lower		25478	25478		
100			CB40		
Chrysler 6-Cyl. 230			Continental F163		
Belt - Fan & Gen.	1092505	TR24476	Belt - Fan & Alt.		
Belt - C.S. & P.S.		7330	Belt - P.S.		
135HLD			Hose - Upper		
Chrysler 6-Cyl. 230			Hose - Lower		
Belt - Fan & Gen.	1092505	TR24476	25478		
Belt - P.S.; W/32 3/4" Belt O.C.		TR22322	CB50		
Belt - P.S.; W/38" Belt O.C.		TR22373	Chrysler 6-Cyl. 230		
200			Belt - P.S.		
Chrysler 6-Cyl. 230			Hose - Lower		
Belt - Fan & Gen.	1092505	TR24476	25478		
Belt - C.S. & P.S.		7330	Challenger		
Hose - Upper		26601	Chrysler 6-Cyl. 230		
Hose - Lower		25478	Belt - Fan & Gen.		
200HL			Belt - P.S.		
Chrysler 6-Cyl. 230			1092505		
Belt - Fan & Gen.	1092505	TR24476	TR24476		
Belt - P.S.; W/32 3/4" Belt O.C.		TR22322	TR22322		
Belt - P.S.; W/38" Belt O.C.		TR22373	26601		
Hose - Upper		26601	25478		
Hose - Lower		25478	SK60		
200HLD			Chrysler 6-Cyl. 230		
Chrysler 6-Cyl. 230			Belt - Fan & Gen.		
Belt - Fan & Gen.	1092505	TR24476	1092505		
Belt - P.S.; W/32 3/4" Belt O.C.		TR22322	TR24476		
Belt - P.S.; W/38" Belt O.C.		TR22373	TR22322		
Hose - Upper		26601	26601		
Hose - Lower		25478	25478		
200HLD			Continental F163		
Chrysler 6-Cyl. 230			Hose - Lower		
Belt - Fan & Gen.	1092505	TR24476	25478		
Belt - P.S.; W/32 3/4" Belt O.C.		TR22322	SK70; SK80; SK100		
Belt - P.S.; W/38" Belt O.C.		TR22373	Chrysler 6-Cyl. 230		
Hose - Upper		26601	Belt - Fan & Gen.		
Hose - Lower		25478	1092505		
200HLD			Belt - P.S.		
Chrysler 6-Cyl. 230			Hose - Upper		
Belt - Fan & Gen.	1092505	TR24476	Hose - Lower		
Belt - P.S.; W/32 3/4" Belt O.C.		TR22322	25478		
Belt - P.S.; W/38" Belt O.C.		TR22373	TL40		
Hose - Upper		26601	Chrysler 6-Cyl. 230		
Hose - Lower		25478	Belt - Fan & Gen.		
200HLD			Belt - P.S.		
Chrysler 6-Cyl. 230			1092505		
Belt - Fan & Gen.	1092505	TR24476	TR24476		
Belt - P.S.; W/32 3/4" Belt O.C.		TR22322	TR22322		
Belt - P.S.; W/38" Belt O.C.		TR22373	26601		
Hose - Upper		26601	25478		
Hose - Lower		25478			

≈Cut to Fit.

♣Standard Belt Available.

Belts and Coolant Hose for Lift & Industrial Trucks

Application	Mfr. Part No.	Our No.	Application	Mfr. Part No.	Our No.
Champ - Continued			Clark - Continued		
TL40 - Continued			Clarklift CFY20B; Clarklift CFY25B - Continued		
Continental F163			Continental F162 LPG		
Hose - Lower		25478	Hose - Upper		≈<20145
TL40C			Hose - Lower		≈<20900
Continental			F235		
Belt - Fan		TR24476	Clark D155G Diesel		
Hose - Upper		26603	Belt - Fan & Gen.		1318618 @7440
Hose - Lower		25478	FY235		
TL50			Clark D155G Diesel		
Chrysler 6-Cyl. 230			Belt - Fan & Alt./Gen.		668774 @7480
Belt - Fan & Gen.		1092505 TR24476	GCS20		
Belt - P.S.		TR22322	Mitsubishi 4G54; Waukesha D176 Diesel		
Continental F163			Belt - Fan & Alt.		2740163 7555
Hose - Lower		25478	GPS15		
Clark			Mitsubishi 4-Cyl. Diesel		
235			Belt - W.P. & Alt.		REMF6365 ♣9375HD
Clark D155G Diesel			Belt - Fan		7325
Belt - Fan & Gen.		1318618 @7440	GPS30		
355			Mitsubishi 4G54; Waukesha D176 Diesel		
Continental F162; Waukesha Diesel			Belt - Fan & Alt.		2740163 7555
Belt - Fan & Gen.; W/56 1/8" Belt O.C.		1307965 @7560	H30; H50		
Belt - Fan & Gen.; W/56 5/8" Belt O.C.		670199 @7565	Clark D155G Diesel; Continental F162		
355PD			Belt - Fan & Gen.; W/55 5/8" Belt O.C.		1311815 @7555
Perkins; Perkins Diesel			Belt - Fan & Gen.; W/56 5/8" Belt O.C.		670199 @7565
Belt - Fan		660056 ♣9520HD	H355		
356			Continental F162; Waukesha Diesel		
Continental; Continental Diesel			Belt - Fan & Gen.; W/56 1/8" Belt O.C.		1307965 @7560
Belt - Fan		668774 @7480	Belt - Fan & Gen.; W/56 5/8" Belt O.C.		670199 @7565
Hose - Upper		20747	H355PD		
Hose - Lower		25472	Perkins; Perkins Diesel		
685			Belt - Fan		660056 ♣9520HD
Perkins			H685		
Belt - Fan & Alt./Gen.; W/55 1/8" Belt O.C. .		742934 @7545	Perkins		
Belt - Fan & Alt./Gen.; W/56 5/8" Belt O.C. .		670199 @7565	Belt - Fan & Alt./Gen.; W/55 1/8" Belt O.C. .		742934 @7545
Perkins Diesel			Belt - Fan & Alt./Gen.; W/56 5/8" Belt O.C. .		670199 @7565
Belt - Fan & Alt./Gen.; W/52 1/4" Belt O.C. .		660056 ♣9520HD	Perkins Diesel		
Belt - Fan & Alt./Gen.; W/56 5/8" Belt O.C. .		670199 @7565	Belt - Fan & Alt./Gen.; W/52 1/4" Belt O.C. .		660056 ♣9520HD
Hose - Upper		≈<20364	Belt - Fan & Alt./Gen.; W/56 5/8" Belt O.C. .		670199 @7565
Hose - Lower		≈<21794	Hose - Upper		≈<20364
or		25476	Hose - Lower		≈<21794
915			or		25476
Perkins			H915		
Belt - Fan & Alt./Gen.; W/63 1/8" Belt O.C. .		1308322 @7630	Perkins		
Perkins Diesel			Belt - Fan & Alt./Gen.; W/63 1/8" Belt O.C. .		1308322 @7630
Belt - Fan & Alt.		1316173 ♣9600HD	Perkins Diesel		
Clarklift C20B; Clarklift C25B			Belt - Fan & Alt.		1316173 ♣9600HD
Continental Y112			HY40; HY50		
Hose - Lower		≈<20121	Continental; Continental Diesel		
or		25476	Hose - Upper		≈<20276
Clarklift CFY20B; Clarklift CFY25B			HY355PD		
Continental F162			Perkins; Perkins Diesel		
Hose - Lower		≈<20900	Belt - Fan		660056 ♣9520HD

②Two Required.
≈<Cut to Fit.

♣Standard Belt Available.

Lift & Industrial Trucks

Belts and Coolant Hose for Lift & Industrial Trucks

Application	Mfr. Part No.	Our No.	Application	Mfr. Part No.	Our No.
Clark - Continued			Clark - Continued		
HY685			IT581 - Continued		
Perkins			Perkins Diesel - Continued		
Belt - Fan & Alt./Gen.; W/61 1/8" Belt O.C.	1320801	②7612	Hose - Lower		25476
Belt - Fan & Alt./Gen.; W/63 1/8" Belt O.C.	1308322	②7630	Y30		
Hose - Lower		≈<20230	Continental; Continental Diesel		
	or	25478	Belt - Fan & Gen.; W/55 3/4" Belt O.C.	1311815	②7555
Perkins Diesel			Belt - Fan & Gen.; W/56 5/8" Belt O.C.		②7565
Belt - Fan & Alt./Gen.	1316173	♣9600HD	Y40; Y50		
Hose - Upper		≈<20364	Continental; Continental Diesel		
Hose - Lower		≈<21794	Belt - Fan & Gen.; W/55 3/4" Belt O.C.	1311815	②7555
	or	25476	Belt - Fan & Gen.; W/56 5/8" Belt O.C.		②7565
HY1425			Y40; Y50		
Continental			Continental; Continental Diesel		
Belt - Fan	791338	②♣9500HD	Belt - Fan & Gen.; W/55 3/4" Belt O.C.	1311815	②7555
Belt - Gen.	791339	♣9530HD	Belt - Fan & Gen.; W/56 5/8" Belt O.C.		②7565
Hose - Upper		26612	Hose - Upper		≈<20276
Hose - Lower		26511	Y235		
Continental Diesel			Clark D155G Diesel		
Belt - Fan	791338	②♣9500HD	Belt - Fan & Alt./Gen.	668774	②7480
Belt - Gen.	791339	♣9530HD	Y355		
Hose - Upper		26501	Waukesha; Waukesha Diesel		
Hose - Lower		26507	Belt - Fan & Gen.; W/56 1/8" Belt O.C.		②7560
HY1625			Belt - Fan & Gen.; W/56 5/8" Belt O.C.	670199	②7565
GM			Y355PD		
Belt - Fan; W/59 1/4" Belt O.C.	1323090	②♣9590HD	Perkins; Perkins Diesel		
Belt - Fan; W/60 1/4" Belt O.C.	1318622	②♣9600HD	Belt - Fan	660056	♣9520HD
Perkins Diesel			Y685		
Belt - Fan & Gen.	1321653	♣9590HD	Perkins		
HY1830			Belt - Fan & Alt./Gen.; W/61 1/8" Belt O.C.		
Continental			Belt - Fan & Alt./Gen.; W/63 1/8" Belt O.C.	1308322	②7630
Belt - Fan	791338	②♣9500HD	Hose - Lower		≈<20230
Belt - Gen.	791339	♣9530HD		or	25478
Hose - Upper		26612	Perkins Diesel		
Hose - Lower		26511	Belt - Fan & Alt./Gen.	1316173	♣9600HD
Continental Diesel			Hose - Upper		≈<20364
Belt - Fan	791338	②♣9500HD	Hose - Lower		≈<21794
Belt - Gen.	791339	♣9530HD		or	25476
Hose - Upper		26501	Y1425		
Hose - Lower		26507	Continental		
HY2030			Belt - Fan		
GM			Belt - Gen.	791339	②♣9500HD
Belt - Fan; W/59 1/4" Belt O.C.	1323090	②♣9590HD	Hose - Upper		26612
Belt - Fan; W/60 1/4" Belt O.C.	1318622	②♣9600HD	Hose - Lower		26511
Perkins Diesel			Continental Diesel		
Belt - Fan & Gen.	1321653	♣9590HD	Belt - Fan	791338	②♣9500HD
IT355			Belt - Gen.	791339	♣9530HD
Continental; Continental Diesel			Hose - Upper		26501
Belt - Fan	668774	②7480	Hose - Lower		26507
Hose - Upper		20747	Y1625		
Hose - Lower		25472	Perkins		
IT581			Belt - Fan; W/49 1/4" Belt O.C.		
Perkins			Belt - Fan; W/50 1/4" Belt O.C.	657250	②♣9500HD
Hose - Upper		≈<20065	Belt - Fan & Gen.	1323090	②♣9590HD
Hose - Lower		25476	Belt - Gen.	666481	②♣9490HD
Perkins Diesel			Perkins Diesel		
Belt - Fan	1317818	♣9540HD	Belt - Fan & Gen.	1321653	♣9590HD
Hose - Upper		25480	Y1830		
Continental			Continental		
Belt - Fan	791338	②♣9500HD	Belt - Fan	791338	②♣9500HD
Belt - Gen.	791339	♣9530HD	Belt - Gen.	791339	♣9530HD

②Two Required.
♣Standard Belt Available.

≈<Cut to Fit.

Belts and Coolant Hose for Lift & Industrial Trucks

Application	Mfr. Part No.	Our No.	Application	Mfr. Part No.	Our No.
Clark - Continued			Fabtek		
Y1830 - Continued			T40		
Continental - Continued			Wisconsin 4-Cyl.		
Hose - Upper		26612	Belt - Gen.		A51
Hose - Lower		26511	Belt - Hyd. Pump		②B50
Continental Diesel			Genie		
Belt - Fan	791338	②▲9500HD	GS-3384 RT; GS-3390 RT; GS-4390 RT; GS-5390 RT		
Belt - Gen.	791339	▲9530HD	Deutz D2011L03i Diesel		
Hose - Upper		26501	Belt - Fan	32698	7445
Hose - Lower		26507	Ford DSG423		
Y2030			Belt - Fan		
Perkins			Belt - Fan	119138	K060725
Belt - Fan; W/49 1/4" Belt O.C.	666481	②▲9490HD	S40		
Belt - Fan; W/50 1/4" Belt O.C.	657250	②▲9500HD	Ford LRG423		
Belt - Fan & Gen.	1323090	②▲9590HD	Belt - Fan; Ser. No. 0830 & Before	28652	7435
Belt - Gen.	666481	②▲9490HD	Belt - Fan; Ser. No. 0831 to 11066	52580	▲K060420HD
Perkins Diesel			Belt - Fan; Ser. No. 11067 to 17231	119138	K060725
Belt - Fan & Gen.	1321653	▲9590HD	Belt - Cam. Belt; Ser. No. 0831 to 11066	65770	T276
Condor			Belt - Timing Component Kit; Ser. No. 0831 to 11066		TCK276
RT48A			Belt - Cam. Tensioner Assy.; Ser. No. 0831 to 11066		T41005
Nissan 4-Cyl.			S45		
Belt - Fan & Alt.		7405	Ford DSG423		
Dresser-Dressta			Belt - Fan; Ser. No. 0830 & Before	28652	7435
4000			Belt - Fan; Ser. No. 0831 to 11066	52580	▲K060420HD
IH C153			Belt - Fan; Ser. No. 11067 to 17231	119138	K060725
Belt - Fan & Gen.	403580R1	7430	Belt - Cam. Belt; Ser. No. 0831 to 11066	65770	T276
4500A			Belt - Timing Component Kit; Ser. No. 0831 to 11066		TCK276
IH C157			Belt - Cam. Tensioner Assy.; Ser. No. 0831 to 11066		T41005
Belt - Fan & Gen.	532030R2	7516	S60		
4500B			Ford LRG423		
IH D179 Diesel			Belt - Fan; Ser. No. 00652 & Before	28652	7435
Belt - Fan & Gen.	534310R1	▲9630HD	Belt - Fan; Ser. No. 03090 to 14053	52580	▲K060420HD
Hose - Lower		≧21660	Belt - Fan; Ser. No. 14054 & After	119138	K060725
		or	S65		
		25474	Ford LRG423		
7000			Belt - Fan; Ser. No. 03090 to 14053	52580	▲K060420HD
IH BD154 Diesel			Belt - Fan; Ser. No. 14054 & After	119138	K060725
Belt - Fan	401691R1	▲9341HD	S80; S85		
Hose - By Pass		28439	Ford LRG423		
Economobile			Belt - Fan; Ser. No. 0965 & Before	28652	7435
620; 620B; 640			Belt - Fan; Ser. No. 0966 & After	52580	▲K060420HD
Continental F226			Belt - Cam. Belt; Ser. No. 3082 & After	65770	T276
Belt - Fan & Gen.	F140K215	TR28483	Belt - Timing Component Kit; Ser. No. 3082 & After		TCK276
IH BD220			Belt - Cam. Tensioner Assy.; Ser. No. 3082 & After		T41005
Belt - Fan	150560R1	▲9451HD	S105		
Belt - W.P. & Gen.	150560R1	▲9451HD	Deutz 4-Cyl. 3.6 L Diesel		
IH UB220; IH UB240; IH UB264			Belt - Fan; Ser. No. 596 & After	58630	7470
Belt - Fan; W/44 3/8" Belt O.C.		TR28445	S120; S125		
Belt - Fan; W/45 1/8" Belt O.C.		▲9451HD	Deutz 4-Cyl. 3.6 L Diesel		
Belt - W.P. & Alt.		▲9440HD	Belt - Fan; Ser. No. 2239 & After	58630	7470
Hose - Upper		26511	Z45/25JRT; Z45/25RT		
Hose - Lower		26509	Deutz 3-Cyl. 2.3 L Diesel		
			Belt - Fan	32698	7445
			Ford 4-Cyl. 2.5 L		
			Belt - Fan; Ser. No. 30141 & Before	52580	▲K060420HD
			Belt - Fan; Ser. No. 30142 & After	119138	K060725

▲Standard Belt Available.
≧Cut to Fit.

②Two Required.

Lift & Industrial Trucks

Belts and Coolant Hose for Lift & Industrial Trucks

Application	Mfr. Part No.	Our No.	Application	Mfr. Part No.	Our No.
Genie - Continued			Gerlinger - Continued		
Z60/34			30R; 30RH; 30S; 30SH; 40R; 40RH; 40S; 40SH - Continued		
Deutz 3-Cyl. 2.3 L Diesel			Ford V-8 - Continued		
Belt - Fan	32698	7445	Belt - Gen.; W/45 1/8" Belt O.C.; W/L-Head Eng.	C629027C6	7450
Ford 4-Cyl. 2.3 L			Hercules DD298 Diesel; Hercules DD339 Diesel; Hercules GO298; Hercules GO339		
Belt - Fan; Ser. No. 1089 & Before	28652	7435	Belt - Fan & Gen.; W/46 1/2" Belt O.C.	C629028C18	▲9463HD
Belt - Fan; Ser. No. 1090 to 6315	52580	▲K060420HD	Belt - Fan & Gen.; W/48 1/4" Belt O.C.	C629028C7	▲9480HD
Belt - Fan; Ser. No. 6316 to 11788	119138	K060725	60AS		
Belt - Cam. Belt; Ser. No. 4546 to 6315	65770	T276	Continental B427		
Belt - Timing Component Kit; Ser. No. 4546 to 6315		TCK276	Belt - Fan & Alt./Gen.	C629027C10	②7550
Belt - Cam. Tensioner Assy.; Ser. No. 4546 to 6315		T41005	Belt - Fan & Gen.	C629028C15	②▲9570HD
Z80/60			60AV		
Deutz 4-Cyl. 3.6 L Diesel			Continental F244		
Belt - Fan; Ser. No. 2178 & After	58630	7470	Belt - Fan & Gen.		▲9360HD
Z135/70			Belt - Fan & Alt.	C629027C17	7400
Deutz 4-Cyl. 3.6 L Diesel			Belt - P.S.	C629027C17	7400
Belt - Fan	58630	7470	Belt - Hyd. Pump	C629028C6	②▲9451HD
Gerlinger			A4D		
4L			Continental M330		
Ford V-8			Belt - Fan & Gen.	C629027C10	②7550
Hose - Upper		②24228	Belt - Fan & Alt.; W/Power Shift Trans.	C629027C13	7550
4MH			Belt - Fan & Alt./Gen.; W/Man. Trans.	C629028C22	②▲9463HD
Ford V-8			Belt - Alt./Gen.; W/Power Shift Trans.	C629029C43	▲9360HD
Belt - Fan; W/39 3/4" Belt O.C.	EAT 8577 A	TR28400	Hercules D3000 Diesel		
Belt - Fan; W/41 3/8" Belt O.C.	8EQ 8577 A	TR28406	Belt - Fan & Alt./Gen.		▲9570HD
Belt - Fan; W/44 1/4" Belt O.C.	C629029C14	TR28437	Hercules D3400 Diesel		
Belt - Gen.; W/43 7/8" Belt O.C.	C629027C5	7435	Belt - Fan & Gen.	C629028C27	▲9550HD
Belt - Gen.; W/44 7/8" Belt O.C.	C629028C4	▲9447HD	A10; A12		
Belt - Gen.; W/50 1/4" Belt O.C.	C629028C9	▲9500HD	Continental F244		
Belt - Gen.; W/56" Belt O.C.	8RT 8620 AA	TR24562	Belt - Fan & Gen.	A36902	▲9360HD
Hose - Upper		②24228	Belt - Fan & Alt.	C629027C17	7400
Hercules DD298 Diesel; Hercules DD339 Diesel; Hercules GO298; Hercules GO339			Belt - Compr.	C629028C30	▲9520HD
Belt - Fan & Gen.; W/46 1/2" Belt O.C.	C629028C18	▲9463HD	Belt - P.S.	C629027C17	7400
Belt - Fan & Gen.; W/48 1/4" Belt O.C.	C629028C7	▲9480HD	Belt - Hyd. Pump	C629028C6	②▲9451HD
4N			Hose - Upper		25480
Ford V-8			Hose - Lower		25473
Hose - Upper		②24228	Hercules D2300 Diesel		
12RH; 15RH			Belt - Fan & Gen.	C629028C30	②▲9520HD
Continental F244			Belt - Fan & Alt.	C629028C26	▲9540HD
Belt - Fan & Gen.		▲9360HD	Belt - V.P.	C629028C23	2420
Belt - Fan & Alt.	C629027C17	7400	A15; A16; A18; A20; A22; A24		
Belt - P.S.	C629027C17	7400	Continental M330		
Belt - Hyd. Pump	C629028C6	②▲9451HD	Belt - Fan & Gen.	C629027C10	②7550
Ford F223			Belt - Fan & Alt.; W/Power Shift Trans.	C629027C13	7550
Belt - Fan & Gen.; W/36 1/4" Belt O.C.	C629027C2	7360	Belt - Fan & Alt./Gen.; W/Man. Trans.	C629027C22	②▲9463HD
Belt - Fan & Gen.; W/37 1/8" Belt O.C.	C629027C3	7370	Belt - Alt./Gen.; W/Power Shift Trans.	C629029C43	▲9360HD
Belt - Fan & Alt.	C629028C21	▲9430HD	Belt - Fan & Alt./Gen.; W/Clutch Pump	C629028C18	▲9463HD
Belt - Hyd. Pump	C629028C6	②▲9451HD	Hose - Upper		26611
Hose - Upper		25473	Hose - Lower		26501
30R; 30RH; 30S; 30SH; 40R; 40RH; 40S; 40SH			Hercules D3000 Diesel		
Ford V-8			Belt - Fan & Alt./Gen.		▲9570HD
Belt - Fan; W/42 1/2" Belt O.C.; W/L-Head Eng.	EAM 8577 A	TR28423	Hercules D3400 Diesel		
Belt - Fan; W/44 1/4" Belt O.C.; W/L-Head Eng.	C629029C14	TR28437	Belt - Fan & Gen.	C629028C27	▲9550HD
Belt - Gen.; W/43 7/8" Belt O.C.; W/L-Head Eng.	C629027C5	7435			

▲Standard Belt Available.

②Two Required.

Belts and Coolant Hose for Lift & Industrial Trucks

Application	Mfr. Part No.	Our No.	Application	Mfr. Part No.	Our No.
Gerlinger - Continued			Gerlinger - Continued		
AM			H32; H36; H40 - Continued		
Continental B427			Continental B427 - Continued		
Belt - Fan & Alt./Gen.	C629027C10	②7550	Belt - Fan & Gen.	C629028C15	②▲9570HD
Belt - Fan & Gen.	C629028C15	②▲9570HD	Hercules JXD; Hercules JXLD		
Belt - Compr.	C629028C31	▲9380HD	Belt - Fan & Gen.	22176	TR30408
AMP			HF		
Continental M363			Continental M330		
Belt - Fan	C629029C43	▲9360HD	Belt - Fan & Gen.	C629027C10	②7550
Belt - W.P.	C629027C13	7550	Belt - Fan & Alt.; W/Power Shift Trans.	C629027C13	7550
B15; B16; B17; B18; B19; B20; B21; B22; B23; B24			Belt - Fan & Alt./Gen.; W/Man. Trans.	C629028C22	②▲9463HD
Continental M330			Belt - Alt./Gen.; W/Power Shift Trans.	C629029C43	▲9360HD
Hose - Upper		26611	Hercules D3000 Diesel		
Hose - Lower		26603	Belt - Fan & Alt./Gen.		▲9570HD
Detroit Diesel 2-53 Diesel; Detroit Diesel 3-53 Diesel; Detroit Diesel 4-53 Diesel			Hercules D3400 Diesel		
Belt - Gen. & W.P.	5114440	②7430	Belt - Fan & Gen.	C629028C27	▲9550HD
Belt - Fan; W/35 1/4" Belt O.C.	5126447	▲9350HD	L12; L15; L16; L18; L20		
Belt - Fan; W/39 1/4" Belt O.C.	5119186	②▲9425HD	Ford V-8		
Belt - Fan; W/40 1/4" Belt O.C.	5126763	②▲9400HD	Belt - Fan; W/39 3/4" Belt O.C.	EAT 8577 A	TR28400
Belt - Fan; W/42 3/4" Belt O.C.	5119186	②▲9425HD	Belt - Fan; W/41 3/8" Belt O.C.	8EQ 8577 A	TR28412
Belt - Fan; W/44 1/4" Belt O.C.	5126761	▲9440HD	Belt - Gen.; W/43 7/8" Belt O.C.	C629027C5	7435
Belt - Fan; W/44 7/8" Belt O.C.	5126764	②▲9447HD	Belt - Gen.; W/56" Belt O.C.	8RT 8620 AA	TR24562
Belt - Fan; W/46 1/4" Belt O.C.	5123089	②7460	Hose - Lower		26602
Belt - Fan; W/47 1/4" Belt O.C.		▲9470HD	L22		
Belt - Fan; W/48 1/4" Belt O.C.	5126765	▲9480HD	Ford V-8		
Belt - Fan; W/50 3/4" Belt O.C.	5126768	▲9505HD	Hose - Lower		26602
Belt - Fan; W/52 1/4" Belt O.C.	5126253	▲9520HD	M24; M26; M28; M30		
Belt - Fan & W.P.; W/Clutch Pump	C629029C50	▲9470HD	Continental M363		
BT			Belt - Fan	C629029C43	▲9360HD
Continental M330			Belt - W.P.	C629027C13	7550
Belt - Fan & Gen.	C629027C10	②7550	Ford V-8		
Belt - Fan & Alt.; W/Power Shift Trans.	C629027C13	7550	Belt - Fan; W/42 1/2" Belt O.C.	EAM 8577 A	TR28423
Belt - Fan & Alt./Gen.; W/Man. Trans.	C629028C22	②▲9463HD	Belt - Fan; W/44 1/4" Belt O.C.	C629029C14	TR28437
Belt - Alt./Gen.; W/Power Shift Trans.	C629029C43	▲9360HD	Belt - Gen.; W/43 7/8" Belt O.C.	C629027C5	7435
G12; G15; G16; G18; G20; G22			Belt - Gen.; W/45 1/8" Belt O.C.	C629027C6	7450
Continental M330			Hercules DD298 Diesel; Hercules DD339 Diesel; Hercules GO298; Hercules GO339		
Belt - Fan & Gen.	C629027C10	②7550	Belt - Fan & Gen.; W/46 1/2" Belt O.C.	C629028C18	▲9463HD
Belt - Fan & Alt.; W/Power Shift Trans.	C629027C13	7550	Belt - Fan & Gen.; W/48 1/4" Belt O.C.	C629028C7	▲9480HD
Belt - Fan & Alt./Gen.; W/Man. Trans.	C629028C22	②▲9463HD	PC		
Belt - Alt./Gen.; W/Power Shift Trans.	C629029C43	▲9360HD	Ford V-8		
Ford F223			Belt - Fan; W/39 3/4" Belt O.C.	EAT 8577 A	TR28400
Belt - Fan & Gen.; W/36 1/4" Belt O.C.	C629027C2	7360	Belt - Fan; W/41 3/8" Belt O.C.	8EQ 8577 A	TR28406
Belt - Fan & Gen.; W/37 1/8" Belt O.C.	C629027C3	7370	Belt - Fan; W/44 1/4" Belt O.C.	C629029C14	TR28437
Belt - Fan & Alt.	C629028C21	▲9430HD	Belt - Gen.; W/43 7/8" Belt O.C.	C629027C5	7435
Belt - Hyd. Pump	C629028C6	②▲9451HD	Belt - Gen.; W/44 7/8" Belt O.C.	C629028C4	▲9447HD
Ford V-8			Belt - Gen.; W/50 1/4" Belt O.C.	C629028C9	▲9500HD
Belt - Fan; W/39 3/4" Belt O.C.	EAT 8577 A	TR28400	Belt - P.S.	C629028C2	▲9390HD
Belt - Fan; W/44 1/4" Belt O.C.	C629029C14	TR28437	Hercules DD298 Diesel; Hercules DD339 Diesel; Hercules GO298; Hercules GO339		
Belt - Gen.; W/43 7/8" Belt O.C.	C629027C5	7435	Belt - Fan & Gen.; W/46 1/2" Belt O.C.	C629028C18	▲9463HD
Belt - Gen.; W/45 3/8" Belt O.C.	C629028C5	▲9451HD	Belt - Fan & Gen.; W/48 1/4" Belt O.C.	C629028C7	▲9480HD
Belt - Gen.; W/50 1/4" Belt O.C.	C629028C9	▲9500HD	PF30; PFH30		
Belt - P.S.	C629028C2	▲9390HD	Ford V-8		
Hose - Lower		26502	Belt - Fan; W/42 1/2" Belt O.C.	EAM 8577 A	TR28423
Hercules DD298 Diesel; Hercules DD339 Diesel; Hercules GO298; Hercules GO339			Belt - Fan; W/44 1/4" Belt O.C.	C629029C14	TR28437
Belt - Fan & Gen.; W/46 1/2" Belt O.C.	C629028C18	▲9463HD	Belt - Gen.; W/43 7/8" Belt O.C.	C629027C5	7435
Belt - Fan & Gen.; W/48 1/4" Belt O.C.	C629028C7	▲9480HD	Belt - Gen.; W/45 1/8" Belt O.C.	C629027C6	7450
H32; H36; H40			Continental B427		
Continental B427			Belt - Fan & Alt./Gen.	C629027C10	②7550
Belt - Fan & Alt./Gen.	C629027C10	②7550			

▲Standard Belt Available.

②Two Required.

Lift & Industrial Trucks

Belts and Coolant Hose for Lift & Industrial Trucks

Application	Mfr. Part No.	Our No.	Application	Mfr. Part No.	Our No.
Gerlinger - Continued			Gerlinger - Continued		
PF30; PFH30 - Continued			S8; S8N; S10; S10N; S12; S15; S16; S18 - Continued		
Hercules DD298 Diesel; Hercules DD339 Diesel; Hercules GO298; Hercules GO339			Ford V-8 - Continued		
Belt - Fan & Gen.; W/46 1/2" Belt O.C.	C629028C18	♣9463HD	Belt - Gen.; W/56" Belt O.C.	8RT 8620 A	TR24562
Belt - Fan & Gen.; W/48 1/4" Belt O.C.	C629028C7	♣9480HD	Belt - P.S.	C629028C2	♣9390HD
PH462; PH562; PH662; PH862			Hercules DD298 Diesel; Hercules DD339 Diesel; Hercules GO298; Hercules GO339		
Ford V-8			Hercules JXD; Hercules JXLD		
Belt - Fan; W/37" Belt O.C.	21A 8577 A	TR26366	Belt - Fan & Gen.; W/46 1/2" Belt O.C.	C629028C18	♣9463HD
Belt - Fan; W/39 3/4" Belt O.C.	EAT 8577 A	TR28400	Belt - Fan & Gen.; W/48 1/4" Belt O.C.	C629028C7	♣9480HD
Belt - Fan; W/41 3/8" Belt O.C.	8EQ 8577 A	TR28412	SC60		
Belt - Gen.; W/43 7/8" Belt O.C.	C629027C5	7435	Continental B427		
Belt - Gen.; W/53 1/2" Belt O.C.		TR24530	Belt - Fan & Alt./Gen.	C629027C10	②7550
Belt - Gen.; W/56" Belt O.C.	8RT 8620 AA	TR24562	Belt - Fan & Gen.	C629028C15	②♣9570HD
PH962			SM20; SM30		
Ford V-8			Ford V-8		
Belt - Fan; W/37" Belt O.C.	21A 8577 A	TR26366	Belt - Fan; W/39 3/4" Belt O.C.	EAT 8577 A	TR28400
Belt - Fan; W/39 3/4" Belt O.C.	EAT 8577 A	TR28400	Belt - Fan; W/41 3/8" Belt O.C.	8EQ 8577 A	TR28412
Belt - Fan; W/41 3/8" Belt O.C.	8EQ 8577 A	TR28412	Belt - Fan; W/44 1/4" Belt O.C.	C629029C14	TR28437
Belt - Gen.; W/43 7/8" Belt O.C.	C629027C5	7435	Belt - Gen.; W/43 7/8" Belt O.C.	C629027C5	7435
Belt - Gen.; W/53 1/2" Belt O.C.		TR24530	Belt - Gen.; W/44 7/8" Belt O.C.	C629028C4	♣9447HD
Belt - Gen.; W/56" Belt O.C.	8RT 8620 AA	TR24562	Belt - Gen.; W/50 1/4" Belt O.C.	C629028C9	♣9500HD
Hose - Upper		②24228	Belt - Gen.; W/56" Belt O.C.	8RT 8620 AA	TR24562
PW			Hercules DD298 Diesel; Hercules DD339 Diesel; Hercules GO298; Hercules GO339		
Continental M330			Hercules JXLD		
Belt - Fan & Gen.	C629027C10	②7550	Belt - Gen.		TR24400
Belt - Fan & Alt.; W/Power Shift Trans.	C629027C13	7550	U8		
Belt - Fan & Alt./Gen.; W/Man. Trans.	C629028C22	②♣9463HD	Continental F244		
Belt - Alt./Gen.; W/Power Shift Trans.	C629029C43	♣9360HD	Hose - Upper		25480
Hercules D3000 Diesel			Hose - Lower		
Belt - Fan & Alt./Gen.		♣9570HD	W/12; W15; W16; W18; W20; W22		
Hercules D3400 Diesel			Continental M330		
Belt - Fan & Gen.	C629028C27	♣9550HD	Belt - Fan & Gen.	C629027C10	②7550
RC60			Belt - Fan & Alt.; W/Power Shift Trans.	C629027C13	7550
Continental B427			Belt - Fan & Alt./Gen.; W/Man. Trans.	C629028C22	②♣9463HD
Belt - Fan & Alt./Gen.	C629027C10	②7550	Belt - Alt./Gen.; W/Power Shift Trans.	C629029C43	♣9360HD
Belt - Fan & Gen.	C629028C15	②♣9570HD	Ford F223		
S8; S8N; S10; S10N; S12; S15; S16; S18			Belt - Fan & Gen.; W/36 1/4" Belt O.C.		
Continental F244			Belt - Fan & Gen.; W/37 1/8" Belt O.C.		
Belt - Fan & Gen.		♣9360HD	Belt - Fan & Alt.		
Belt - Fan & Alt.	C629027C17	7400	Belt - Hyd. Pump		
Belt - P.S.	C629027C17	7400	C629028C6		
Belt - Hyd. Pump	C629028C6	②♣9451HD	Continental M330		
Continental M330			Belt - Fan & Gen.		
Belt - Fan & Gen.	C629027C10	②7550	Belt - Fan & Alt.; W/Power Shift Trans.		
Belt - Fan & Alt.; W/Power Shift Trans.	C629027C13	7550	Belt - Fan & Alt./Gen.; W/Man. Trans.		
Belt - Fan & Alt./Gen.; W/Man. Trans.	C629028C22	②♣9463HD	Belt - Alt./Gen.		
Belt - Alt./Gen.; W/Power Shift Trans.	C629029C43	♣9360HD	Ford F223		
Ford F223			Belt - Fan & Gen.; W/36 1/4" Belt O.C.		
Belt - Fan & Gen.; W/36 1/4" Belt O.C.	C629027C2	7360	Belt - Fan & Gen.; W/37 1/8" Belt O.C.		
Belt - Fan & Gen.; W/37 1/8" Belt O.C.	C629027C3	7370	C629027C3		
Belt - Fan & Alt.	C629028C21	♣9430HD	Continental F244		
Belt - Hyd. Pump	C629028C6	②♣9451HD	Hose - Upper		
Ford V-8			Hose - Lower		
Belt - Fan; W/39 3/4" Belt O.C.	EAT 8577 A	TR28400	W/12; W15; W16; W18; W20; W22		
Belt - Fan; W/41 3/8" Belt O.C.	8EQ 8577 A	TR28412	Continental M330		
Belt - Fan; W/44 1/4" Belt O.C.	C629029C14	TR28437	Belt - Fan & Gen.	C629027C10	②7550
Belt - Gen.; W/43 7/8" Belt O.C.	C629027C5	7435	Belt - Fan & Alt.; W/Power Shift Trans.	C629027C13	7550
Belt - Gen.; W/44 7/8" Belt O.C.	C629028C4	♣9447HD	Belt - Fan & Alt./Gen.; W/Man. Trans.	C629028C22	②♣9463HD
Belt - Gen.; W/50 1/4" Belt O.C.	C629028C9	♣9500HD	Belt - Alt./Gen.	C629029C43	♣9360HD
Belt - Gen.; W/56" Belt O.C.	8RT 8620 AA	TR24562	Ford F223		
Hose - Upper		②24228	Belt - Fan & Gen.; W/36 1/4" Belt O.C.		
Hercules DD298 Diesel; Hercules DD339 Diesel; Hercules GO298; Hercules GO339			Belt - Fan & Gen.; W/37 1/8" Belt O.C.		
Belt - Fan & Gen.; W/46 1/2" Belt O.C.	C629028C18	♣9463HD	C629027C3		
Belt - Fan & Gen.; W/48 1/4" Belt O.C.	C629028C7	♣9480HD	Continental F244		
SMH			Hose - Upper		
Ford V-8			Hose - Lower		
Belt - Fan; W/39 3/4" Belt O.C.	EAT 8577 A	TR28400	W/12; W15; W16; W18; W20; W22		
Belt - Fan; W/41 3/8" Belt O.C.	8EQ 8577 A	TR28412	Continental M330		
Belt - Fan; W/44 1/4" Belt O.C.	C629029C14	TR28437	Belt - Fan & Gen.	C629027C10	②7550
Belt - Gen.; W/43 7/8" Belt O.C.	C629027C5	7435	Belt - Fan & Alt.; W/Power Shift Trans.	C629027C13	7550
Belt - Gen.; W/44 7/8" Belt O.C.	C629028C4	♣9447HD	Belt - Fan & Alt./Gen.; W/Man. Trans.	C629028C22	②♣9463HD
Belt - Gen.; W/50 1/4" Belt O.C.	C629028C9	♣9500HD	Belt - Alt./Gen.	C629029C43	♣9360HD
Belt - Gen.; W/56" Belt O.C.	8RT 8620 AA	TR24562	Ford F223		
Hose - Upper		②24228	Belt - Fan & Gen.; W/36 1/4" Belt O.C.		
Hercules DD298 Diesel; Hercules DD339 Diesel; Hercules GO298; Hercules GO339			Belt - Fan & Gen.; W/37 1/8" Belt O.C.		
Belt - Fan & Gen.; W/46 1/2" Belt O.C.	C629028C18	♣9463HD	C629027C3		
Belt - Fan & Gen.; W/48 1/4" Belt O.C.	C629028C7	♣9480HD	Continental F244		
SRH (4H Series)			Hose - Upper		
Hercules JXLD			Hose - Lower		
Belt - Gen.		TR24400	W/12; W15; W16; W18; W20; W22		
U8			Continental M330		
Continental F244			Belt - Fan & Gen.	C629027C10	②7550
Hose - Upper		25480	Belt - Fan & Alt.; W/Power Shift Trans.	C629027C13	7550
Hose - Lower		25473	Belt - Fan & Alt./Gen.; W/Man. Trans.	C629028C22	②♣9463HD
W12; W15; W16; W18; W20; W22			Belt - Alt./Gen.	C629029C43	♣9360HD
Continental M330			Ford F223		
Belt - Fan & Gen.	C629027C10	②7550	Belt - Fan & Gen.; W/36 1/4" Belt O.C.		
Belt - Fan & Alt.; W/Power Shift Trans.	C629027C13	7550	Belt - Fan & Gen.; W/37 1/8" Belt O.C.		
Belt - Fan & Alt./Gen.; W/Man. Trans.	C629028C22	②♣9463HD	C629027C3		
Belt - Alt./Gen.	C629029C43	♣9360HD	Continental F244		
Ford F223			Hose - Upper		
Belt - Fan & Gen.; W/36 1/4" Belt O.C.	C629027C2	7360	Hose - Lower		
Belt - Fan & Gen.; W/37 1/8" Belt O.C.	C629027C3	7370	W/12; W15; W16; W18; W20; W22		

♣Standard Belt Available.

②Two Required.

Belts and Coolant Hose for Lift & Industrial Trucks

Application	Mfr. Part No.	Our No.	Application	Mfr. Part No.	Our No.
Gerlinger - Continued			Grove - Continued		
W12; W15; W16; W18; W20; W22 - Continued			MZ66		
Ford F223 - Continued			Deutz 2-Cyl. 115 Diesel		
Belt - Fan & Alt.	C629028C21	▲9430HD	Belt - Alt.		AX33
Belt - Hyd. Pump	C629028C6	②▲9451HD	MZ116D		
Ford V-8			Cummins 4-Cyl. 3.9 L Diesel		
Belt - Fan; W/39 3/4" Belt O.C.	EAT 8577 A	TR28400	Belt - Fan & Alt.		▲K080575HD
Belt - Fan; W/44 1/4" Belt O.C.	C629029C14	TR28437	SM4688XT		
Belt - Gen.; W/44 7/8" Belt O.C.	C629028C4	▲9447HD	Mitsubishi M20F		
Belt - Gen.; W/50 1/4" Belt O.C.	C629028C9	▲9500HD	Belt - Fan & Alt.		7345
Belt - P.S.	C629028C2	▲9390HD	Herculift		
Hose - Lower		26602	H4M32G		
Hercules DD298 Diesel; Hercules DD339 Diesel; Hercules GO298; Hercules GO339			Ford 4-Cyl. 172; Ford 4-Cyl. 192		
Belt - Fan & Gen.; W/46 1/2" Belt O.C.	C629028C18	▲9463HD	Belt - Fan; W/35A. Alt.		▲9420HD
Belt - Fan & Gen.; W/48 1/4" Belt O.C.	C629028C7	▲9480HD	Belt - Hyd. Pump		TR20451
Hercules JXD			Hose - Upper		24220
Belt - Fan & Gen.	22176	TR30408	Hose - Lower		25478
Gradall			Hyster		
534B			50		
Perkins 4-Cyl. 236 Diesel; Waukesha 4-Cyl. 220 Diesel			Isuzu 4-Cyl. 207 Diesel		
Belt - Fan & Alt.		▲9520HD	Belt - Fan & Alt.	5136710550	▲9476HD
Hose - Upper		26509	Hose - Upper		25252
Hose - Lower - Eng. To Pipe		24224	60		
Hose - Lower - Pipe To Rad.		21660	Isuzu 4-Cyl. 92		
Hose - By Pass		≧20065	Belt - Fan & Alt.		▲9451HD
Gradall-Loed			80		
534			Continental 6-Cyl. 245		
Cummins V378 Diesel			Belt - Fan & Alt.	111107	▲9470HD
Belt - Fan	178593	②TR22461	Hose - Upper		25474
Belt - Fan & Alt.	178447	②7380	Hose - Lower		25478
542			A66A		
Perkins 4-Cyl. 236 Diesel			GM V-6 4.3 L		
Belt - Fan & Alt.		②7450	Belt - Fan & Hyd. Pump	172883	②7525
Hose - Upper		≧21379	Belt - W.P. & Alt.		7375
		or	Hose - Upper		25474
Hose - Lower		26512	A150E Thru A225E		
Hose - By Pass		≧21942	GM V-6 305		
552; 554			Belt - Fan		
Chrysler V-8 318				127034	▲9590HD
Belt - Fan & Alt.		▲9520HD	H20E		
Grove			Continental F112		
AMZ40			Belt - Fan, Alt. & W.P.		
Kubota 3-Cyl.					▲9490HD
Belt - Fan & Alt.		7345	Hose - Upper		20433
Hose - Upper		≧21942		or	25526
AMZ50; AMZ56; AMZ66			Hose - Lower		25474
Nissan 4-Cyl.			Continental Y112		
Belt - Fan & Alt.	1172077702	7385	Belt - Fan & Gen.; W/45 3/8" Belt O.C.	118671	7450
AMZ66XT			Belt - Fan & Gen.; W/46 1/8" Belt O.C.	123577	7460
Ford 4-Cyl.			Belt - Fan & Gen.; W/48 1/8" Belt O.C.	97908	7440
Belt - Fan & Alt.		▲K060415HD	Hose - Upper		25472
MZ48B			Hose - Lower		20065
Nissan 4-Cyl.				or	25473
Belt - Fan & Alt.		7385	Hose - By Pass; Ser. No. BID2889 & After		24224
			Hose - By Pass; Ser. No. BIE1911 & After		24224
			Perkins 4-Cyl. 107 Diesel		
			Hose - Upper - Eng. To Pipe		
					25472

▲Standard Belt Available.
≧Cut to Fit.

②Two Required.

Belts and Coolant Hose for Lift & Industrial Trucks

Application	Mfr. Part No.	Our No.	Application	Mfr. Part No.	Our No.
Hyster - Continued			Hyster - Continued		
H20E - Continued			H30E - Continued		
Perkins 4-Cyl. 107 Diesel - Continued			Perkins 4-Cyl. 107 Diesel - Continued		
Hose - Lower - Pipe To Rad		20065	Hose - Upper - Eng. To Pipe		25473
	or	25473	Hose - Lower - Pipe To Rad.		20065
				or	25473
H25E			H30F		
Continental F112			Continental G193		
Belt - Fan, Alt. & W.P.		♣9490HD	Belt - Fan & Alt.	118135	♣9463HD
Hose - Upper		20433	Hose - Upper		25473
	or	25526	Hose - Lower		♣20573
Hose - Lower		25474	Perkins 4-Cyl. 203 Diesel		
Continental Y112			Belt - Fan & Alt.		
Belt - Fan & Gen.; W/45 3/8" Belt O.C.	118671	7450	Hose - Upper	142526	♣9490HD
Belt - Fan & Gen.; W/46 1/8" Belt O.C.	123577	7460	Hose - Lower		25473
Belt - Fan & Gen.; W/48 1/8" Belt O.C.	97908	7440		or	20355
Hose - Upper		25473			25477
Hose - Lower		20065	H30H		
	or	25473	Ford 4-Cyl. 172		
Hose - By Pass; Ser. No. BID2889 & After		24224	Belt - Fan & Alt.	145313	♣9505HD
Hose - By Pass; Ser. No. BIE1911 & After		24224	Hose - Lower		♣21794
Perkins 4-Cyl. 107 Diesel				or	25480
Hose - Upper - Eng. To Pipe		25473	Perkins 4-Cyl. 203 Diesel		
Hose - Lower - Pipe To Rad.		20065	Belt - Fan & Alt.	104728	♣9480HD
	or	25473	Hose - Lower		20355
H30E				or	25477
Continental F112			H35XL		
Belt - Fan, Alt. & W.P.		♣9490HD	GM 4-Cyl.		
Hose - Upper		20433	Hose - Upper		
	or	25526			
Hose - Lower		25474	25252		
Continental F135			Mazda M4-121G		
Belt - Fan & Gen.; Ser. No. BID2888 & Before	118671	7450	Belt - Alt.		
Belt - Fan & Gen.; Ser. No. BIE1585 & Before	118671	7450	326873		
Belt - Fan & Gen.; Ser. No. BIE1586 Thru BIE1910	97908	7440	♣9420HD		
Belt - Fan & Gen.; Ser. No. BID2889 & After	981885	♣9510HD	H40F		
Belt - Fan & Gen.; Ser. No. BIE1911 & After	981885	♣9510HD	Continental G193		
Hose - Upper - Eng. To Tank; Ser. No. BID2888 & Before		25472	Belt - Fan & Alt.	118135	♣9463HD
Hose - Upper - Eng. To Tank; Ser. No. BIE1910 & Before		25472	Hose - Upper		25473
Hose - Upper - Eng. To Tank; Ser. No. BID2889 & After ..		25472	Hose - Lower		♣20573
Hose - Upper - Eng. To Tank; Ser. No. BID1911 & After ..		25472	Perkins 4-Cyl. 203 Diesel		
Hose - Upper - Rad. To Tank; Ser. No. BID2889 & After ..		25472	Belt - Fan & Alt.	142526	♣9490HD
Hose - Upper - Rad. To Tank; Ser. No. BID1911 & After ..		25472	Hose - Upper		25473
Hose - Lower	♣20065		Hose - Lower		20355
	or	25526		or	25477
Hose - By Pass; Ser. No. BID2889 & After		24224	H40H		
Hose - By Pass; Ser. No. BIE1911 & After		24224	Ford 4-Cyl. 172		
Continental Y112			Belt - Fan & Alt.		
Belt - Fan & Gen.; W/45 3/8" Belt O.C.	118671	7450	145313		
Belt - Fan & Gen.; W/46 1/8" Belt O.C.	123577	7460	♣9505HD		
Belt - Fan & Gen.; W/48 1/8" Belt O.C.	97908	7440	Hose - Lower		
Hose - Upper		25473	♣21794		
Hose - Lower		20065	or		
	or	25473	25480		
Hose - By Pass; Ser. No. BID2889 & After		24224	Perkins 4-Cyl. 203 Diesel		
Hose - By Pass; Ser. No. BIE1911 & After		24224	Belt - Fan & Alt.	104728	♣9480HD
Perkins 4-Cyl. 107 Diesel			Hose - Lower		20355
Belt - Fan & Gen.; W/32 3/4" Belt O.C.	148370	7325		or	25477
Belt - Fan & Gen.; W/48 1/8" Belt O.C.	100754	7480	H40XL		
H30E			Continental F244		
Continental F112			Belt - Fan, Gov. & Idler		
Belt - Fan, Alt. & W.P.		♣9490HD	502105903		
Hose - Upper		20433	♣9470HD		
	or	25526	Belt - W.P. & Alt.		
Hose - Lower		25474	900293812		
	or	25473	Hose - Upper		
Hose - By Pass; Ser. No. BID2889 & After		24224	25251		
Hose - By Pass; Ser. No. BIE1911 & After		24224	H50F		
Perkins 4-Cyl. 107 Diesel			Continental G193		
Belt - Fan & Gen.; W/32 3/4" Belt O.C.	148370	7325	Belt - Fan & Alt.		
Belt - Fan & Gen.; W/48 1/8" Belt O.C.	100754	7480	118135		
H30E			♣9463HD		
Continental F112			Hose - Upper		
Belt - Fan, Alt. & W.P.		♣9490HD	25473		
Hose - Upper		20433			
	or	25526			
Hose - Lower		25474			

♣Standard Belt Available.

♣Cut to Fit.

Belts and Coolant Hose for Lift & Industrial Trucks

Application	Mfr. Part No.	Our No.	Application	Mfr. Part No.	Our No.
Hyster - Continued			Hyster - Continued		
H50F - Continued			H60F - Continued		
Continental G193 - Continued			Perkins 4-Cyl. 203 Diesel - Continued		
Hose - Lower		≈20573	Hose - Lower		20355 or 25477
Perkins 4-Cyl. 203 Diesel			H60H		
Belt - Fan & Alt.	142526	♣9490HD	Ford 4-Cyl. 172		
Hose - Upper		25473	Belt - Fan & Alt.		
Hose - Lower		20355	145313		
	or	25477	♣9505HD		
H50H			Hose - Lower		
Detroit Diesel 4-53 Diesel			≈21794		
Hose - Lower			or		
26521			25480		
Ford 4-Cyl.			Perkins 4-Cyl. 203 Diesel		
Hose - Upper; W/O.H.V. Eng.			Belt - Fan & Alt.		
25305			104728		
Hose - Lower; W/O.H.V. Eng.			♣9480HD		
≈21794			20355		
or			or		
25473			25477		
Ford 4-Cyl. 172			H70B		
Belt - Fan & Alt.			Continental F226		
145313			Belt - Fan & Gen.		
♣9505HD			111107		
Belt - W.P.			♣9470HD		
♣9313HD			Belt - P.S.		
Hose - Lower			♣9319HD		
≈21794			25473		
or			Hose - Lower		
25480			25473		
Perkins 4-Cyl. 203 Diesel			H70C		
Belt - Fan & Alt.			Continental F226		
104728			Belt - Fan & Gen.		
♣9480HD			111107		
Hose - Lower			♣9470HD		
or			Belt - P.S.		
20355			♣9309HD		
25477			25473		
Perkins 6-Cyl. 354 Diesel			Hose - Lower		
Hose - Lower			25473		
23562			Perkins 4-Cyl. 203 Diesel		
H50XL			Belt - Fan & Gen.; W/50 3/4" Belt O.C.		
GM 4-Cyl. 181			145313		
Belt - Fan			♣9505HD		
324368			♣9520HD		
Belt - Alt.			Belt - Fan & Gen.; W/52 1/4" Belt O.C.		
326873			79853		
♣9420HD			Belt - Fan & Gen.; W/53 1/4" Belt O.C.		
H60B			985420		
Continental F226			♣9530HD		
Belt - Fan & Gen.			25472		
111107			Hose - Upper		
♣9470HD			20230		
Belt - P.S.			or		
♣9319HD			25478		
25473			H80B		
Hose - Upper			Continental F226		
25473			Belt - Fan & Gen.		
Hose - Lower			111107		
25473			♣9470HD		
H60C			Belt - P.S.		
Continental F226			♣9319HD		
Belt - Fan & Gen.			25473		
111107			Hose - Lower		
♣9470HD			25473		
Belt - P.S.			H80C		
121185			Continental F226		
♣9309HD			Belt - Fan & Gen.		
25473			111107		
Hose - Upper			♣9470HD		
25473			Belt - P.S.		
Hose - Lower			♣9309HD		
25473			25473		
Perkins 4-Cyl. 203 Diesel			Hose - Lower		
Belt - Fan & Gen.; W/50 3/4" Belt O.C.			25473		
145313			♣9470HD		
♣9505HD			Belt - P.S.		
Belt - Fan & Gen.; W/52 1/4" Belt O.C.			♣9309HD		
79853			25473		
♣9520HD			Hose - Upper		
Belt - Fan & Gen.; W/53 1/4" Belt O.C.			25472		
985420			20230		
♣9530HD			or		
Hose - Upper			25478		
25472			H80XL		
20230			GM V-6 4.3 L		
Hose - Lower			Belt - Fan & Alt.		
or			374011		
25478			7500		
H60F			Belt - Fan & W.P.		
Continental G193			374011		
Belt - Fan & Alt.			7500		
118135					
♣9463HD					
Hose - Upper					
25473					
Hose - Lower					
≈20573					
Perkins 4-Cyl. 203 Diesel					
Belt - Fan & Alt.					
142526					
♣9490HD					
Hose - Upper					
25473					

♣Standard Belt Available.

≈Cut to Fit.

Belts and Coolant Hose for Lift & Industrial Trucks

Application	Mfr. Part No.	Our No.	Application	Mfr. Part No.	Our No.
Hyster - Continued			Hyster - Continued		
H100B; H100C			H140C; H150C - Continued		
Continental F244			Continental F244 - Continued		
Belt - Fan & Gen.	111107	♣9470HD	Hose - Lower		25478
Hose - Upper		⊗21794	Perkins 4-Cyl. 235 Diesel		
	or	25473	Belt - Fan & Gen.	104728	♣9480HD
Hose - Lower		25478	Hose - Lower - Eng. To Pipe		⊗20121
Perkins 4-Cyl. 235 Diesel				or	25480
Belt - Fan & Gen.	104728	♣9480HD	Hose - Lower - Pipe To Rad.		⊗20065
Hose - Lower - Eng. To Pipe		⊗20121	Perkins 6-Cyl. 305 Diesel		
	or	25480	Belt - Fan & Gen.	104728	♣9480HD
Hose - Lower - Pipe To Rad.		⊗20065	Hose - Upper		⊗20957
Perkins 6-Cyl. 305 Diesel			H150E		
Belt - Fan & Gen.	104728	♣9480HD	Caterpillar 3204 Diesel		
Hose - Upper		⊗20957	Belt - Fan; W/57 1/2" Belt O.C.	133323	TR28570
H100XL			Belt - Fan & Alt.; Ser. No. B7P-2010 & Before	97897	♣9560HD
GM V-6 4.3 L			Belt - Fan & Alt.; Ser. No. B7P-2011 & After	113221	♣9550HD
Belt - Fan & Alt.	374011	7500	Hose - Lower		24244
Belt - Fan & W.P.	374011	7500	GM V-6 305		
H110F			Belt - Fan & Alt.; Ser. No. B7P-2010	127034	♣9590HD
Chevrolet 6-Cyl. 250			Belt - Fan & Alt.; Ser. No. B7P-2011	135417	♣9580HD
Belt - Fan & Gen.; W/37 5/8" Belt O.C.	172895	7375	Perkins 6-Cyl. 354 Diesel		
Belt - Fan & Gen.; W/52 7/8" Belt O.C.	172883	⊗7525	Belt - Fan; W/57 1/2" Belt O.C.	133323	TR28570
Belt - W.P.	155442	7380	Belt - Fan & Alt.; Ser. No. B7P-2010 & Before	97897	♣9560HD
Hose - Lower		26502	Belt - Fan & Alt.; Ser. No. B7P-2011 & After	113221	♣9550HD
Perkins 4-Cyl. 236 Diesel			Hose - Upper		⊗20611
Belt - Fan & Gen.	104728	♣9480HD	Hose - Lower; Molded Hose		⊗20611
Hose - Lower - Eng. To Pipe		⊗20121		or	26508
	or	25480	Hose - Lower; Sirt. Hose		24236
Hose - Lower - Pipe To Rad.		⊗20065	H150F		
H120B; H120C			Chevrolet 6-Cyl. 250		
Continental F244			Belt - Fan & Gen.; W/37 5/8" Belt O.C.	172895	7375
Belt - Fan & Gen.	111107	♣9470HD	Belt - Fan & Gen.; W/52 7/8" Belt O.C.	172883	⊗7525
Hose - Upper		⊗21794	Belt - W.P.	155442	7380
	or	25473	Hose - Lower		26502
Hose - Lower		25478	Perkins 4-Cyl. 236 Diesel		
Perkins 4-Cyl. 235 Diesel			Belt - Fan & Gen.	104728	♣9480HD
Belt - Fan & Gen.	104728	♣9480HD	Hose - Lower - Eng. To Pipe		⊗20121
Hose - Lower - Eng. To Pipe		⊗20121		or	25480
	or	25480	Hose - Lower - Pipe To Rad.		⊗20065
Hose - Lower - Pipe To Rad.		⊗20065	H165E; H180E; H200E		
Perkins 6-Cyl. 305 Diesel			Caterpillar 3204 Diesel		
Belt - Fan & Gen.	104728	♣9480HD	Belt - Fan; W/57 1/2" Belt O.C.	133323	TR28570
Hose - Upper		⊗20957	Belt - Fan & Alt.; Ser. No. B7P-2010 & Before	97897	♣9560HD
H130F			Belt - Fan & Alt.; Ser. No. B7P-2011 & After	113221	♣9550HD
Chevrolet 6-Cyl. 250			Hose - Lower		24244
Belt - Fan & Gen.; W/37 5/8" Belt O.C.	172895	7375	GM V-6 305		
Belt - Fan & Gen.; W/52 7/8" Belt O.C.	172883	⊗7525	Belt - Fan & Alt.; Ser. No. B7P-2010	127034	♣9590HD
Belt - W.P.	155442	7380	Belt - Fan & Alt.; Ser. No. B7P-2011	135417	♣9580HD
Hose - Lower		26502	Perkins 6-Cyl. 354 Diesel		
Perkins 4-Cyl. 236 Diesel			Belt - Fan; W/57 1/2" Belt O.C.	133323	TR28570
Belt - Fan & Gen.	104728	♣9480HD	Belt - Fan & Alt.; Ser. No. B7P-2010 & Before	97897	♣9560HD
Hose - Lower - Eng. To Pipe		⊗20121	Belt - Fan & Alt.; Ser. No. B7P-2011 & After	113221	♣9550HD
	or	25480	Hose - Upper		⊗20611
Hose - Lower - Pipe To Rad.		⊗20065	H140C; H150C		
H140C; H150C			Continental F244		
Continental F244			Belt - Fan & Gen.	111107	♣9470HD
Belt - Fan & Gen.	111107	♣9470HD	Hose - Upper		⊗21794
Hose - Upper		⊗21794		or	25473
	or	25473			

⊗Cut to Fit.
⊗Two Required.

♣Standard Belt Available.

Belts and Coolant Hose for Lift & Industrial Trucks

Application	Mfr. Part No.	Our No.	Application	Mfr. Part No.	Our No.
Hyster - Continued			Hyster - Continued		
H165E; H180E; H200E - Continued			H250E - Continued		
Perkins 6-Cyl. 354 Diesel - Continued			Caterpillar 3204 Diesel - Continued		
Hose - Lower; Molded Hose		≈<20611	Belt - Fan & Alt.; Ser. No. B7P-2011 & After	113221	♣9550HD
	or	26508	Hose - Lower		24244
Hose - Lower; Strt. Hose		24236	GM V-6 305		
H200ES			Belt - Fan & Alt.; Ser. No. B7P-2010		
Caterpillar 3204 Diesel			127034		♣9590HD
Belt - Fan; W/57 1/2" Belt O.C.	133323	TR28570	Belt - Fan & Alt.; Ser. No. B7P-2011	135417	♣9580HD
Belt - Fan & Alt.; Ser. No. B7P-2010 & Before	97897	♣9560HD	Perkins 6-Cyl. 354 Diesel		
Belt - Fan & Alt.; Ser. No. B7P-2011 & After	113221	♣9550HD	Belt - Fan; W/57 1/2" Belt O.C.		
GM V-6 305			133323		TR28570
Belt - Fan & Alt.; Ser. No. B7P-2010	127034	♣9590HD	Belt - Fan & Alt.; Ser. No. B7P-2010 & Before	97897	♣9560HD
Belt - Fan & Alt.; Ser. No. B7P-2011	135417	♣9580HD	Belt - Fan & Alt.; Ser. No. B7P-2011 & After	113221	♣9550HD
Perkins 6-Cyl. 354 Diesel			Hose - Upper		
Belt - Fan; W/57 1/2" Belt O.C.	133323	TR28570			≈<20611
Belt - Fan & Alt.; Ser. No. B7P-2010 & Before	97897	♣9560HD	Hose - Lower; Molded Hose		≈<20611
Belt - Fan & Alt.; Ser. No. B7P-2011 & After	113221	♣9550HD		or	26508
H225E			Hose - Lower; Strt. Hose		24236
Caterpillar 3204 Diesel			H275H		
Belt - Fan; W/57 1/2" Belt O.C.	133323	TR28570	Detroit Diesel 4-53 Diesel		
Belt - Fan & Alt.; Ser. No. B7P-2010 & Before	97897	♣9560HD	Hose - Lower		
Belt - Fan & Alt.; Ser. No. B7P-2011 & After	113221	♣9550HD			26521
Hose - Lower		24244	Ford 4-Cyl. 172		
GM V-6 305			Hose - Lower		
Belt - Fan & Alt.; Ser. No. B7P-2010	127034	♣9590HD			≈<21794
Belt - Fan & Alt.; Ser. No. B7P-2011	135417	♣9580HD		or	25473
Perkins 6-Cyl. 354 Diesel			Perkins 6-Cyl. 354 Diesel		
Belt - Fan; W/57 1/2" Belt O.C.	133323	TR28570	Hose - Lower		
Belt - Fan & Alt.; Ser. No. B7P-2010 & Before	97897	♣9560HD			23562
Belt - Fan & Alt.; Ser. No. B7P-2011 & After	113221	♣9550HD	H300		
Hose - Upper		≈<20611	Perkins 6-Cyl. 354 Diesel		
Hose - Lower; Molded Hose		≈<20611	Hose - Upper		
	or	26508			26521
Hose - Lower; Strt. Hose		24236	H300A		
H225ES			Detroit Diesel 4-53 Diesel		
Caterpillar 3204 Diesel			Hose - Lower		
Hose - Lower		24244			26514
Perkins 6-Cyl. 354 Diesel			GM V-6 305		
Hose - Upper		≈<20611	Hose - Upper		
Hose - Lower; Molded Hose		≈<20611			26512
	or	26508	Perkins 6-Cyl. 354		
Hose - Lower; Strt. Hose		24236	Hose - Upper		
H250A					26510
GM V-6 305			H330; H350B		
Hose - Upper		26512	Perkins 6-Cyl. 354 Diesel		
Perkins 6-Cyl. 354 Diesel			Hose - Upper		
Hose - Upper		26510			26521
H250E			H360A; H400A; H460A		
Caterpillar 3204 Diesel			Caterpillar D330 Diesel; Continental TD427 Diesel; Continental T427		
Belt - Fan; W/57 1/2" Belt O.C.	133323	TR28570	Hose - Upper		26611
Belt - Fan & Alt.; Ser. No. B7P-2010 & Before	97897	♣9560HD	Hose - Lower		26502
Perkins 6-Cyl. 354 Diesel			HE50		
Hose - Upper		≈<20611	Continental F162		
Hose - Lower; Molded Hose		≈<20611	Belt - Fan & Gen.; W/55 1/4" Belt O.C.		
	or	26508	113221		♣9550HD
Hose - Lower; Strt. Hose		24236	Belt - Fan & Gen.; W/58 1/4" Belt O.C.	107195	♣9580HD
H250A			Perkins 4-Cyl. 203 Diesel		
GM V-6 305			Belt - Fan		
Hose - Upper		26512			107195
Perkins 6-Cyl. 354 Diesel			P40A; P50A		
Hose - Upper		26510	Perkins 4-Cyl. 153 Diesel		
H250E			Hose - Upper		
Caterpillar 3204 Diesel					26611
Belt - Fan; W/57 1/2" Belt O.C.	133323	TR28570	Perkins 4-Cyl. 154 Diesel		
Belt - Fan & Alt.; Ser. No. B7P-2010 & Before	97897	♣9560HD	Hose - Upper		
Perkins 6-Cyl. 354 Diesel					26611

♣Standard Belt Available.

≈<Cut to Fit.

Lift & Industrial Trucks

Belts and Coolant Hose for Lift & Industrial Trucks

Application	Mfr. Part No.	Our No.	Application	Mfr. Part No.	Our No.
Hyster - Continued			Hyster - Continued		
P40A; P50A - Continued			Z90A		
Perkins 4-Cyl. 154 Diesel - Continued			Continental 4-Cyl. Diesel		
Hose - Lower		25526	Belt - Fan & Alt.; W/O.H.V. Eng.	104728	♣9480HD
P60A; P80A			Hose - Upper; W/O.H.V. Eng.		20357
Continental F226			or		26602
Hose - Upper		25473	Hose - Lower - Eng. To Pipe; W/O.H.V. Eng.		♣<20065
Hose - Lower		25478	Hose - Lower - Pipe To Rad.; W/O.H.V. Eng.		♣<20065
Continental F227			Ingersoll-Rand		
Hose - Upper		25473	VR642		
Perkins 4-Cyl. 236 Diesel			Cummins 4-Cyl. 3.9 L Diesel		
Hose - Upper		25472	Belt - Fan & Alt.	3911587	♣K080537HD
Hose - Lower - Pipe To Rad.		24224	International		
P125A; P150A			9000		
Caterpillar 3204 Diesel			IH C291		
Hose - Lower		24244	Belt - Fan	406097R1	♣9570HD
GM V-6 305			Belt - W.P. & Alt.	403617R1	♣9470HD
Hose - Upper		26512	Hose - By Pass		20338
Perkins 6-Cyl. 354 Diesel			IH D310 Diesel		
Hose - Upper		♣<20611	Belt - Fan	406097R1	♣9570HD
or		26508	Hose - By Pass		20338
Hose - Lower; Molded Hose		♣<20611	JLG		
or		26508	30F		
Hose - Lower; Strt. Hose		24236	Wisconsin VH4D		
P150B			Belt - Alt.		1190
Detroit Diesel 4-53 Diesel			40-0		
Hose - Lower		26521	Wisconsin VH4D		
P165A; P180A			Belt - Alt.		1190
Caterpillar 3204 Diesel			Belt - Gen.		♣9430HD
Hose - Lower		24244	40-45		
GM V-6 305			Wisconsin V-4 4.0 L		
Hose - Upper		26512	Belt - Alt.		2200
Perkins 6-Cyl. 354 Diesel			Belt - Gen.		♣9415HD
Hose - Upper		♣<20611	40F		
or		26508	Wisconsin VH4D		
Hose - Lower; Molded Hose		♣<20611	Belt - Gen.		TR22425
Hose - Lower; Strt. Hose		24236	60BR		
P200B			Wisconsin VH4D		
Detroit Diesel 4-53 Diesel			Belt - Fan & Alt.		♣9435HD
Hose - Lower		26521	Belt - Gen.		♣9490HD
S60E; S70E; S80E; S100E			John Deere		
Chevrolet 6-Cyl. 250			380		
Hose - Upper - Eng. To Pipe		25532	John Deere 3-Cyl. 135		
Hose - Upper - Pipe To Rad.		26501	Belt - Fan & Alt.	R97758	TR22485
Perkins 4-Cyl. 236 Diesel			John Deere 3-Cyl. 152 Diesel		
Hose - Upper - Pipe To Rad.		20492	Belt - Fan & Alt.	R97758	TR22485
or		25478	Hose - Upper		21794
Hose - Lower - Eng. To Pipe		25532	Hose - Lower		21182
S125A; S150A			Hose - By Pass		28441
Continental F245			480		
Belt - Fan & W.P.	111107	♣9470HD	John Deere 4-Cyl. 180		
Perkins 4-Cyl. 236 Diesel			Belt - Fan & Alt.	R97758	TR22485
Belt - Fan & W.P.	141319	♣9510HD	John Deere 4039D Diesel		
			Belt - Fan & Alt.	R97758	TR22485

♣<Cut to Fit.

♣Standard Belt Available.

Belts and Coolant Hose for Lift & Industrial Trucks

Application	Mfr. Part No.	Our No.	Application	Mfr. Part No.	Our No.
John Deere - Continued			Kalmar - Continued		
480 - Continued			ACC20 - Continued		
John Deere 4039D Diesel - Continued			Continental D262 Diesel		
Hose - Lower		21182	Hose - Upper		26611
480A; 480B			Hose - Lower		24228
John Deere 4-Cyl. 219			Continental F163		
Belt - Fan & Alt. T24757		TR22508	Hose - Upper		25478
Hose - By Pass		28439	Hose - Lower		25476
John Deere 4-Cyl. 219 Diesel			Continental F245		
Belt - Fan & Alt. T24757		TR22508	Hose - Upper		25478
Hose - Lower		21182	Waukesha FC133		
Hose - By Pass		28441	Hose - Upper		≈20573
480C				or	25473
John Deere 4-Cyl. 219 Diesel			Hose - Lower		24224
Belt - Fan	T24757	TR22508	Waukesha FC173		
Hose - Upper		21794	Belt - Fan & Alt. 4822011		♣9430HD
Hose - Lower		21182	ACC20L		
480G			Continental 4-Cyl. 135; Continental 4-Cyl. 163		
John Deere 4-Cyl. 219; John Deere 4-Cyl. 219 Diesel			Belt - Fan & Alt.		♣9451HD
Belt - Fan & Alt. T24757		TR22508	Waukesha FC173		
482C			Belt - Fan & Alt. 4822011		♣9430HD
John Deere 4039D Diesel			ACC25		
Belt - Fan & Alt.; Ser. No. 309201 & Before . T24757		TR22508	Allis-Chalmers 4-Cyl. 153		
Belt - Fan & Alt.; Ser. No. 309202 thru 310648	T24473	TR22514	Hose - Upper		25530
Belt - Fan & Alt.; Ser. No. 310649 & After ... R82602		TR22517	Allis-Chalmers 6-Cyl. 230; Allis-Chalmers 6-Cyl. 262 Diesel		
485E; 486E; 488E			Hose - Upper		24228
John Deere 4045D Diesel			Continental 4-Cyl. 135; Continental 4-Cyl. 163		
Belt - Fan	R135195	♣K080645HD	Belt - Fan & Alt.		♣9451HD
Kalamazoo			Hose - Upper		≈21794
2500A				or	25476
Wisconsin TH; Wisconsin THD Diesel			Continental D262 Diesel		
Belt - Drive	21168	♣9290HD	Hose - Upper		26611
2500B			Hose - Lower		24228
Wisconsin THD Diesel			Continental F163		
Belt - Alt. Z2562		♣9370HD	Hose - Upper		25478
3600A			Hose - Lower		25476
Wisconsin TH; Wisconsin THD Diesel			Continental F245		
Belt - Drive	21168	♣9290HD	Hose - Upper		25478
K45A			Waukesha FC133		
Continental F4162			Hose - Upper		≈20573
Belt - Fan & Gen. F140K239		TR24461		or	25473
Hose - Upper		25473	Hose - Lower		24224
Hose - Lower		25476	Waukesha FC173		
Kalmar			Belt - Fan & Alt. 4822011		♣9430HD
ACC20			ACC25L		
Allis-Chalmers 4-Cyl. 153			Continental 4-Cyl. 135; Continental 4-Cyl. 163		
Hose - Upper		25530	Belt - Fan & Alt.		♣9451HD
Allis-Chalmers 6-Cyl. 230; Allis-Chalmers 6-Cyl. 262 Diesel			Waukesha FC173		
Hose - Upper		24228	Belt - Fan & Alt. 4822011		♣9430HD
Continental 4-Cyl. 135; Continental 4-Cyl. 163			ACC30		
Belt - Fan & Alt.		♣9451HD	Allis-Chalmers 4-Cyl. 153		
Hose - Upper		≈21794	Hose - Upper		25530
	or	25476	Allis-Chalmers 6-Cyl. 230; Allis-Chalmers 6-Cyl. 262 Diesel		
			Hose - Upper		24228

♣Standard Belt Available.

≈Cut to Fit.

Lift & Industrial Trucks

Belts and Coolant Hose for Lift & Industrial Trucks

Application	Mfr. Part No.	Our No.	Application	Mfr. Part No.	Our No.
Kalmar - Continued			Kalmar - Continued		
ACC30 - Continued			ACC60C		
Continental 4-Cyl. 135; Continental 4-Cyl. 163			Allis-Chalmers 4-Cyl. 153		
Belt - Fan & Alt.		♣9451HD	Hose - Upper		25530
Hose - Upper		♣21794	Allis-Chalmers 6-Cyl. 230; Allis-Chalmers 6-Cyl. 262 Diesel		
	or	25476	Hose - Upper		24228
Continental D262 Diesel			Continental 4-Cyl. 135; Continental 4-Cyl. 163		
Hose - Upper		26611	Hose - Upper		♣21794
Hose - Lower		24228		or	25476
Continental F163			Continental D262 Diesel		
Hose - Upper		25478	Hose - Upper		26611
Hose - Lower		25476	Hose - Lower		24228
Continental F245			Continental F163		
Hose - Upper		25478	Hose - Upper		25478
Waukesha FC133			Hose - Lower		25476
Hose - Upper		♣20573	Continental F245		
	or	25473	Hose - Upper		25478
Hose - Lower		24224	Waukesha FC133		
Waukesha FC173			Hose - Upper		♣20573
Belt - Fan & Alt.	4822011	♣9430HD		or	25473
ACC30L			Hose - Lower		24224
Continental 4-Cyl. 135; Continental 4-Cyl. 163			ACC70		
Belt - Fan & Alt.		♣9451HD	Allis-Chalmers 4-Cyl. 153		
Waukesha FC173			Belt - Fan & Alt.	4791039	♣9470HD
Belt - Fan & Alt.	4822011	♣9430HD	Hose - Upper		25530
ACC35; ACC40; ACC45; ACC50; ACC55; ACC60			Allis-Chalmers 6-Cyl. 230; Allis-Chalmers 6-Cyl. 262 Diesel		
Allis-Chalmers 4-Cyl. 153			Belt - Fan & Alt.	4791039	♣9470HD
Belt - Fan & Alt.	4791039	♣9470HD	Hose - Upper		24228
Hose - Upper		25530	Continental 4-Cyl. 135		
Allis-Chalmers 6-Cyl. 230; Allis-Chalmers 6-Cyl. 262 Diesel			Hose - Upper		♣21794
Belt - Fan & Alt.	4791039	♣9470HD		or	25476
Hose - Upper		24228	Continental 4-Cyl. 153		
Continental 4-Cyl. 135			Belt - Fan & Alt.	4856615	♣9360HD
Hose - Upper		♣21794	Continental 4-Cyl. 163		
	or	25476	Belt - Fan & Alt.	4856615	♣9360HD
Continental 4-Cyl. 153			Hose - Upper		♣21794
Belt - Fan & Alt.	4856615	♣9360HD		or	25476
Continental 4-Cyl. 163			Continental D262 Diesel		
Belt - Fan & Alt.	4856615	♣9360HD	Hose - Upper		26611
Hose - Upper		♣21794	Hose - Lower		24228
	or	25476	Continental F163		
Continental D262 Diesel			Belt - Fan & Alt.	4856615	♣9360HD
Hose - Upper		26611	Hose - Upper		25478
Hose - Lower		24228	Hose - Lower		25476
Continental F163			Continental F245		
Belt - Fan & Alt.	4856615	♣9360HD	Belt - Fan & Alt.	4856615	♣9360HD
Hose - Upper		25478	Hose - Upper		25478
Hose - Lower		25476	Hose - Lower		25478
Continental F245			Perkins 4-Cyl. 203		
Belt - Fan & Alt.	4856615	♣9360HD	Belt - Fan & Alt.	4848883	♣9451HD
Hose - Upper		25478	Waukesha FC133		
Hose - Lower		25476	Hose - Upper		♣20573
Continental F245				or	25473
Belt - Fan & Alt.	4856615	♣9360HD	Hose - Lower		24224
Hose - Upper		25478	ACC80		
Hose - Lower		25476	Allis-Chalmers 4-Cyl. 153		
Perkins 4-Cyl. 203			Belt - Fan & Alt.	4791039	♣9470HD
Belt - Fan & Alt.	4848883	♣9451HD			
Waukesha FC133					
Hose - Upper		♣20573			
	or	25473			
Hose - Lower		24224			

♣Cut to Fit.

♣Standard Belt Available.

Belts and Coolant Hose for Lift & Industrial Trucks

Application	Mfr. Part No.	Our No.	Application	Mfr. Part No.	Our No.
Kalmar - Continued			Kalmar - Continued		
ACC80 - Continued			ACC100 - Continued		
Allis-Chalmers 4-Cyl. 153 - Continued			Continental F245 - Continued		
Hose - Upper		25530	Hose - Lower		25478
Allis-Chalmers 6-Cyl. 230; Allis-Chalmers 6-Cyl. 262 Diesel			Perkins 4-Cyl. 203		
Belt - Fan & Alt.	4791039	▲9470HD	Belt - Fan & Alt.	4848883	▲9451HD
Hose - Upper		24228	Waukesha FC133		
Continental 4-Cyl. 135			Hose - Upper		
Hose - Upper		≈21794			≈20573
	or	25476		or	25473
Continental 4-Cyl. 153			Hose - Lower		
Belt - Fan & Alt.	4856615	▲9360HD			24224
Continental 4-Cyl. 163			ACP20		
Belt - Fan & Alt.	4856615	▲9360HD	Allis-Chalmers 4-Cyl. 153		
Hose - Upper		≈21794	Hose - Upper		
	or	25476			
Continental D262 Diesel			Allis-Chalmers 6-Cyl. 230; Allis-Chalmers 6-Cyl. 262 Diesel		
Hose - Upper		26611	Hose - Upper		
Hose - Lower		24228			
Continental F163			Continental 4-Cyl. 135; Continental 4-Cyl. 163		
Belt - Fan & Alt.	4856615	▲9360HD	Belt - Fan & Alt.		
Hose - Upper		25478			▲9451HD
Hose - Lower		25476	Hose - Upper		
Continental F245			Hose - Upper		
Belt - Fan & Alt.	4856615	▲9360HD			≈21794
Hose - Upper		25478		or	25476
Perkins 4-Cyl. 203			Continental D262 Diesel		
Belt - Fan & Alt.	4848883	▲9451HD	Hose - Upper		
Waukesha FC133			Hose - Lower		
Hose - Upper		≈20573			26611
	or	25473	Hose - Lower		
Hose - Lower		24224			24228
ACC100			Continental F163		
Allis-Chalmers 4-Cyl. 153			Hose - Upper		
Belt - Fan & Alt.	4791039	▲9470HD	Hose - Lower		
Hose - Upper		25530	Continental F245		
Allis-Chalmers 6-Cyl. 230; Allis-Chalmers 6-Cyl. 262 Diesel			Hose - Upper		
Belt - Fan & Alt.	4791039	▲9470HD	Hose - Lower		
Hose - Upper		24228	Continental F245		
Continental 4-Cyl. 135			Hose - Upper		
Hose - Upper		≈21794	Hose - Lower		
	or	25476	Continental F245		
Continental 4-Cyl. 153			Hose - Upper		
Belt - Fan & Alt.	4856615	▲9360HD	Hose - Lower		
Continental 4-Cyl. 163			Continental F163		
Belt - Fan & Alt.	4856615	▲9360HD	Hose - Upper		
Hose - Upper		≈21794	Hose - Lower		
	or	25476	Continental F245		
Continental D262 Diesel			Hose - Upper		
Hose - Upper		26611	Hose - Lower		
Hose - Lower		24228	Continental F245		
Continental F163			Hose - Upper		
Belt - Fan & Alt.	4856615	▲9360HD	Hose - Lower		
Hose - Upper		25478	Continental F245		
Hose - Lower		25476	Hose - Upper		
Continental F245			Hose - Lower		
Belt - Fan & Alt.	4856615	▲9360HD	Hose - Upper		
Hose - Upper		25478	Hose - Lower		

▲Standard Belt Available.

≈Cut to Fit.

Lift & Industrial Trucks

Belts and Coolant Hose for Lift & Industrial Trucks

Application	Mfr. Part No.	Our No.	Application	Mfr. Part No.	Our No.
Kalmar - Continued			Kalmar - Continued		
ACP25 - Continued			ACP35 - Continued		
Waukesha FC133			Continental 4-Cyl. 163		
Hose - Upper		≈<20573	Belt - Fan & Alt.	4856615	♣9360HD
		or	Hose - Upper		≈<21794
Hose - Lower		24224			25476
Waukesha FC173			Hose - Lower		25476
Belt - Fan & Alt.	4822011	♣9430HD	Continental D262 Diesel		
ACP25L			Hose - Upper		26611
Continental 4-Cyl. 135; Continental 4-Cyl. 163			Hose - Lower		24228
Belt - Fan & Alt.		♣9451HD	Continental F163		
Waukesha FC173			Belt - Fan & Alt.	4856615	♣9360HD
Belt - Fan & Alt.	4822011	♣9430HD	Hose - Upper		25478
ACP30			Hose - Lower		25476
Allis-Chalmers 4-Cyl. 153			Continental F245		
Hose - Upper		25530	Belt - Fan & Alt.	4856615	♣9360HD
Allis-Chalmers 6-Cyl. 230; Allis-Chalmers 6-Cyl. 262 Diesel			Hose - Upper		25478
Hose - Upper		24228	Perkins 4-Cyl. 203		
Continental 4-Cyl. 135; Continental 4-Cyl. 163			Belt - Fan & Alt.	4848883	♣9451HD
Belt - Fan & Alt.		♣9451HD	Waukesha FC133		
Hose - Upper		≈<21794	Hose - Upper		≈<20573
		or			25473
		25476	Hose - Lower		24224
Continental D262 Diesel			ACP40		
Hose - Upper		26611	Allis-Chalmers 4-Cyl. 153		
Hose - Lower		24228	Belt - Fan & Alt.	4791039	♣9470HD
Continental F163			Hose - Upper		25530
Hose - Upper		25478	Allis-Chalmers 6-Cyl. 230; Allis-Chalmers 6-Cyl. 262 Diesel		
Hose - Lower		25476	Belt - Fan & Alt.	4791039	♣9470HD
Continental F245			Hose - Upper		24228
Hose - Upper		25478	Continental 4-Cyl. 135		
Waukesha FC133			Hose - Upper		≈<21794
Hose - Upper		≈<20573			25476
		or	Continental 4-Cyl. 153		
Hose - Lower		24224	Belt - Fan & Alt.	4856615	♣9360HD
Waukesha FC173			Continental 4-Cyl. 163		
Belt - Fan & Alt.	4822011	♣9430HD	Belt - Fan & Alt.	4856615	♣9360HD
ACP30L; ACP30PS			Hose - Upper		≈<21794
Continental 4-Cyl. 135; Continental 4-Cyl. 163					25476
Belt - Fan & Alt.		♣9451HD	Continental D262 Diesel		
Waukesha FC173			Hose - Upper		26611
Belt - Fan & Alt.	4822011	♣9430HD	Hose - Lower		24228
ACP35			Continental F163		
Allis-Chalmers 4-Cyl. 153			Belt - Fan & Alt.	4856615	♣9360HD
Belt - Fan & Alt.	4791039	♣9470HD	Hose - Upper		25478
Hose - Upper		25530	Hose - Lower		25476
Allis-Chalmers 6-Cyl. 230; Allis-Chalmers 6-Cyl. 262 Diesel			Continental F245		
Belt - Fan & Alt.	4791039	♣9470HD	Belt - Fan & Alt.	4856615	♣9360HD
Hose - Upper		24228	Hose - Upper		25478
Continental 4-Cyl. 135			Perkins 4-Cyl. 203		
Hose - Upper		≈<21794	Belt - Fan & Alt.	4848883	♣9451HD
		or	Waukesha FC133		
		25476	Hose - Upper		≈<20573
Hose - Lower		25476			25473
Continental 4-Cyl. 153			Hose - Lower		24224
Belt - Fan & Alt.	4856615	♣9360HD	ACP45		
ACP35L; ACP35PS			Allis-Chalmers 4-Cyl. 153		
Continental 4-Cyl. 135; Continental 4-Cyl. 163			Belt - Fan & Alt.	4791039	♣9470HD
Belt - Fan & Alt.		♣9451HD			
Waukesha FC173					
Belt - Fan & Alt.	4822011	♣9430HD			

♣Standard Belt Available.

≈<Cut to Fit.

Belts and Coolant Hose for Lift & Industrial Trucks

Application	Mfr. Part No.	Our No.	Application	Mfr. Part No.	Our No.
Kalmar - Continued			Kalmar - Continued		
ACP45 - Continued			ACP50 - Continued		
Allis-Chalmers 4-Cyl. 153 - Continued			Continental F245		
Hose - Upper		25530	Belt - Fan & Alt	4856615	♣9360HD
Allis-Chalmers 6-Cyl. 230; Allis-Chalmers 6-Cyl. 262 Diesel			Hose - Upper		25478
Belt - Fan & Alt	4791039	♣9470HD	Perkins 4-Cyl. 203		
Hose - Upper		24228	Belt - Fan & Alt	4848883	♣9451HD
Continental 4-Cyl. 135			Waukesha FC133		
Hose - Upper		♣21794	Hose - Upper		♣20573
	or	25476			25473
Hose - Lower		25476	Hose - Lower		24224
Continental 4-Cyl. 153			ACP55		
Belt - Fan & Alt	4856615	♣9360HD	Allis-Chalmers 4-Cyl. 153		
Continental 4-Cyl. 163			Belt - Fan & Alt	4791039	♣9470HD
Belt - Fan & Alt	4856615	♣9360HD	Hose - Upper		25530
Hose - Upper		♣21794	Allis-Chalmers 6-Cyl. 230; Allis-Chalmers 6-Cyl. 262 Diesel		
	or	25476	Belt - Fan & Alt	4791039	♣9470HD
Hose - Lower		25476	Hose - Upper		24228
Continental D262 Diesel			Continental 4-Cyl. 135		
Hose - Upper		26611	Hose - Upper		♣21794
Hose - Lower		24228			25476
Continental F163					25476
Belt - Fan & Alt	4856615	♣9360HD	Hose - Lower		
Hose - Upper		25478	Continental 4-Cyl. 153		
Hose - Lower		25476	Belt - Fan & Alt	4856615	♣9360HD
Continental F245			Continental 4-Cyl. 163		
Belt - Fan & Alt	4856615	♣9360HD	Belt - Fan & Alt	4856615	♣9360HD
Hose - Upper		25478	Hose - Upper		♣21794
Hose - Lower		25476			25476
Continental F245			Hose - Lower		25476
Belt - Fan & Alt	4856615	♣9360HD	Continental D262 Diesel		
Hose - Upper		25478	Hose - Upper		26611
Hose - Lower		25476	Hose - Lower		24228
Continental F245			Continental F163		
Belt - Fan & Alt	4856615	♣9360HD	Belt - Fan & Alt	4856615	♣9360HD
Hose - Upper		25478	Hose - Upper		25478
Hose - Lower		25476	Hose - Lower		25476
Continental F245			Continental F245		
Belt - Fan & Alt	4856615	♣9360HD	Belt - Fan & Alt	4856615	♣9360HD
Hose - Upper		25478	Hose - Upper		25478
Hose - Lower		25476	Hose - Lower		25478
Continental F245			Perkins 4-Cyl. 203		
Belt - Fan & Alt	4856615	♣9360HD	Belt - Fan & Alt	4848883	♣9451HD
Hose - Upper		25478	Waukesha FC133		
Hose - Lower		25476	Hose - Upper		♣20573
Continental D262 Diesel					25473
Hose - Upper		26611	Hose - Lower		24224
Hose - Lower		24228	ACP60		
Continental F163			Allis-Chalmers 4-Cyl. 153		
Belt - Fan & Alt	4856615	♣9360HD	Belt - Fan & Alt	4791039	♣9470HD
Hose - Upper		25478	Hose - Upper		25530
Hose - Lower		25476	Allis-Chalmers 6-Cyl. 230; Allis-Chalmers 6-Cyl. 262 Diesel		
Continental 4-Cyl. 153			Belt - Fan & Alt	4791039	♣9470HD
Belt - Fan & Alt	4856615	♣9360HD	Hose - Upper		24228
Hose - Upper		♣21794	Continental 4-Cyl. 135		
	or	25476	Hose - Upper		♣21794
Hose - Lower		25476			25476
Continental 4-Cyl. 153			Continental 4-Cyl. 153		
Belt - Fan & Alt	4856615	♣9360HD	Belt - Fan & Alt	4856615	♣9360HD
Hose - Upper		25478			
Hose - Lower		25476			

♣Standard Belt Available.

♣Cut to Fit.

Belts and Coolant Hose for Lift & Industrial Trucks

Application	Mfr. Part No.	Our No.	Application	Mfr. Part No.	Our No.
Kalmar - Continued			Kalmar - Continued		
ACP60 - Continued			ACP70D; ACP70L		
Continental 4-Cyl. 163			Allis-Chalmers 4-Cyl. 153; Allis-Chalmers 6-Cyl. 230; Allis-Chalmers 6-Cyl. 262 Diesel		
Belt - Fan & Alt.	4856615	♣9360HD	Belt - Fan & Alt.	4791039	♣9470HD
Hose - Upper		≈<21794	Continental F163; Continental F245; Continental 4-Cyl. 153; Continental 4-Cyl. 163		
	or	25476	Belt - Fan & Alt.	4856615	♣9360HD
Continental D262 Diesel			Perkins 4-Cyl. 203		
Hose - Upper		26611	Belt - Fan & Alt.	4848883	♣9451HD
Hose - Lower		24228	ACP80		
Continental F163; Continental F245			Allis-Chalmers 4-Cyl. 153		
Belt - Fan & Alt.	4856615	♣9360HD	Belt - Fan & Alt.	4791039	♣9470HD
Hose - Upper		25478	Hose - Upper		25530
Hose - Lower		25476	Allis-Chalmers 6-Cyl. 230; Allis-Chalmers 6-Cyl. 262 Diesel		
Perkins 4-Cyl. 203			Belt - Fan & Alt.		
Belt - Fan & Alt.	4848883	♣9451HD		4791039	♣9470HD
Waukesha FC133			Hose - Upper		
Hose - Upper		≈<20573			24228
	or	25473	Continental 4-Cyl. 135		
Hose - Lower		24224	Hose - Upper		
ACP60D; ACP60DX; ACP60L					≈<21794
Allis-Chalmers 4-Cyl. 153; Allis-Chalmers 6-Cyl. 230; Allis-Chalmers 6-Cyl. 262 Diesel					or
Belt - Fan & Alt.	4791039	♣9470HD	25476		
Continental F163; Continental F245; Continental 4-Cyl. 153; Continental 4-Cyl. 163			Continental 4-Cyl. 153		
Belt - Fan & Alt.	4856615	♣9360HD	Belt - Fan & Alt.		
Perkins 4-Cyl. 203			4856615		
Belt - Fan & Alt.	4848883	♣9451HD	♣9360HD		
ACP70			Hose - Upper		
Allis-Chalmers 4-Cyl. 153			≈<21794		
Belt - Fan & Alt.	4791039	♣9470HD	or		
Hose - Upper		25530	25476		
Allis-Chalmers 6-Cyl. 230; Allis-Chalmers 6-Cyl. 262 Diesel			Continental 4-Cyl. 163		
Belt - Fan & Alt.	4791039	♣9470HD	Belt - Fan & Alt.		
Hose - Upper		24228	4856615		
Continental 4-Cyl. 135			♣9360HD		
Hose - Upper		≈<21794	Hose - Upper		
	or	25476	≈<21794		
Continental 4-Cyl. 153			25476		
Belt - Fan & Alt.	4856615	♣9360HD	Continental D262 Diesel		
Continental 4-Cyl. 163			Hose - Upper		
Belt - Fan & Alt.	4856615	♣9360HD	26611		
Hose - Upper		≈<21794	Hose - Lower		
	or	25476	24228		
Continental D262 Diesel			Continental F163		
Hose - Upper		26611	Belt - Fan & Alt.		
Hose - Lower		24228	4856615		
Continental F163; Continental F245			♣9360HD		
Belt - Fan & Alt.	4856615	♣9360HD	Hose - Upper		
Hose - Upper		25478	25478		
Hose - Lower		25476	Hose - Lower		
Perkins 4-Cyl. 203			25482		
Belt - Fan & Alt.	4848883	♣9451HD	Continental F245		
Waukesha FC133			Belt - Fan & Alt.		
Hose - Upper		≈<20573	4856615		
	or	25473	♣9360HD		
Hose - Lower		24224	Hose - Upper		
ACP70D; ACP70L			25478		
Allis-Chalmers 4-Cyl. 153; Allis-Chalmers 6-Cyl. 230; Allis-Chalmers 6-Cyl. 262 Diesel			25482		
Belt - Fan & Alt.	4791039	♣9470HD	Perkins 4-Cyl. 203		
Continental F163; Continental F245; Continental 4-Cyl. 153; Continental 4-Cyl. 163			Belt - Fan & Alt.		
Belt - Fan & Alt.	4856615	♣9360HD	4848883		
Hose - Upper		25478	♣9451HD		
Hose - Lower		25476	ACP80D; ACP80DX		
Perkins 4-Cyl. 203			Allis-Chalmers 4-Cyl. 153; Allis-Chalmers 6-Cyl. 230; Allis-Chalmers 6-Cyl. 262 Diesel		
Belt - Fan & Alt.	4848883	♣9451HD	Belt - Fan & Alt.		
Waukesha FC133			4791039		
Hose - Upper		≈<20573	♣9470HD		
	or	25473	Continental F163; Continental F245; Continental 4-Cyl. 153; Continental 4-Cyl. 163		
Hose - Lower		24224	Belt - Fan & Alt.		
ACP80			4856615		
Allis-Chalmers 4-Cyl. 153			♣9360HD		
Belt - Fan & Alt.	4791039	♣9470HD	Hose - Upper		
Hose - Upper		25530	≈<21794		
Allis-Chalmers 6-Cyl. 230; Allis-Chalmers 6-Cyl. 262 Diesel			25476		
Belt - Fan & Alt.	4791039	♣9470HD	Continental D262 Diesel		
Hose - Upper		24228	Hose - Upper		
Continental 4-Cyl. 135			26611		
Hose - Upper		≈<21794	Hose - Lower		
	or	25476	24228		
Continental 4-Cyl. 153			Continental F163		
Belt - Fan & Alt.	4856615	♣9360HD	Belt - Fan & Alt.		
Continental 4-Cyl. 163			4856615		
Belt - Fan & Alt.	4856615	♣9360HD	♣9360HD		
Hose - Upper		≈<21794	Hose - Upper		
	or	25476	25478		
Continental D262 Diesel			25482		
Hose - Upper		26611	Continental F245		
Hose - Lower		24228	Belt - Fan & Alt.		
Continental F163; Continental F245			4856615		
Belt - Fan & Alt.	4856615	♣9360HD	♣9360HD		
Hose - Upper		25478	Hose - Upper		
Hose - Lower		25476	25478		
Perkins 4-Cyl. 203			25482		
Belt - Fan & Alt.	4848883	♣9451HD	Perkins 4-Cyl. 203		
Waukesha FC133			Belt - Fan & Alt.		
Hose - Upper		≈<20573	4848883		
	or	25473	♣9451HD		
Hose - Lower		24224	ACP100; ACP100C		
ACP70D; ACP70L			Allis-Chalmers 4-Cyl. 153		
Allis-Chalmers 4-Cyl. 153; Allis-Chalmers 6-Cyl. 230; Allis-Chalmers 6-Cyl. 262 Diesel			Hose - Upper		
Belt - Fan & Alt.	4791039	♣9470HD	25530		
Continental F163; Continental F245; Continental 4-Cyl. 153; Continental 4-Cyl. 163					
Belt - Fan & Alt.	4856615	♣9360HD			
Hose - Upper		25478			
Hose - Lower		25476			
Perkins 4-Cyl. 203					
Belt - Fan & Alt.	4848883	♣9451HD			
ACP100; ACP100C					
Allis-Chalmers 4-Cyl. 153					
Hose - Upper		25530			

≈<Cut to Fit.

♣Standard Belt Available.

Belts and Coolant Hose for Lift & Industrial Trucks

Application	Mfr. Part No.	Our No.	Application	Mfr. Part No.	Our No.
Kalmar - Continued			K-D Manitou		
ACP100; ACP100C - Continued			352; 355; 452		
Allis-Chalmers 6-Cyl. 230; Allis-Chalmers 6-Cyl. 262 Diesel			Ford 3-Cyl.		
Hose - Upper		24228	Belt - Fan & Alt./Gen.		▲9550HD
Continental 4-Cyl. 135; Continental 4-Cyl. 163			Hose - Upper		25480
Hose - Upper	≅21794		Hose - Lower		26502
or		25476	Ford 3-Cyl. Diesel		
Continental D262 Diesel			Belt - Fan & Alt./Gen.		▲9550HD
Hose - Upper		26611	Komatsu		
Hose - Lower		24228	FG15		
Continental F163			Nissan 4P Diesel		
Hose - Upper		25478	Belt - Fan & Alt.	9931201035	▲9400HD
Hose - Lower		25476	Hose - Upper		25253
Continental F245			FG20		
Hose - Upper		25478	Nissan H20141DA Diesel		
Waukesha FC133			Belt - Fan	19104K7206	▲9395HD
Hose - Upper	≅20573		Belt - W.P. & Alt.	11720K7201	7370
or		25473	Belt - P.S.	3046024860	B56
Hose - Lower		24224	FG25		
ACP110			Nissan H20141DA Diesel		
Allis-Chalmers 4-Cyl. 153			Belt - Fan	21067K7320	6723
Belt - Fan & Alt.	4791039	▲9470HD	Belt - W.P. & Alt.		7410
Hose - Upper		25530	Belt - Hyd. Pump		TR22588
Allis-Chalmers 6-Cyl. 230; Allis-Chalmers 6-Cyl. 262 Diesel			Hose - Upper		25253
Belt - Fan & Alt.	4791039	▲9470HD	FG40		
Hose - Upper		24228	Nissan 6-Cyl. Diesel		
Continental 4-Cyl. 135			Belt - Fan & Gov.		TR22588
Hose - Upper	≅21794		Belt - W.P. & Alt.		TR24465
or		25476	Lift All		
Continental 4-Cyl. 153			80D		
Belt - Fan & Alt.	4856615	▲9360HD	John Deere 4276D Diesel		
Continental 4-Cyl. 163			Belt - Fan & Alt.	T24473	TR22514
Belt - Fan & Alt.	4856615	▲9360HD	Hose - Upper		26531
Hose - Upper	≅21794		Hose - Lower		26510
or		25476	H80; H100; H120; H150; HT80; HT100; HT120; HT150		
Continental D262 Diesel			IH UC263		
Hose - Upper		26611	Belt - Fan & Alt.; W/47 7/8" Belt O.C.	358320C91	▲9476HD
Hose - Lower		24228	Belt - Fan & Alt.; W/49 1/4" Belt O.C.	385674R1	▲9490HD
Continental F163			Belt - Oil Clutch Pump; W/33" Belt O.C.		▲9330HD
Belt - Fan & Alt.	4856615	▲9360HD	Belt - Oil Clutch Pump; W/36 1/4" Belt O.C.		▲9360HD
Hose - Upper		25478	Hose - Upper; 1972 & Older		≅20427
Hose - Lower		25476	Hose - Lower; 1972 & Newer		26510
Continental F245			L40; L50; L60		
Belt - Fan & Alt.	4856615	▲9360HD	IH UC153		
Hose - Upper		25478	Belt - Fan & Alt.	678200C1	7450
Perkins 4-Cyl. 203			Belt - Fan & Gen.	349175R1	7440
Belt - Fan & Alt.	4848883	▲9451HD	Belt - P.S.		▲9525HD
Waukesha FC133			Hose - Lower		25255
Hose - Upper	≅20573		John Deere 4219D Diesel		
or		25473	Belt - Fan & Alt.	T20334T	TR22474
Hose - Lower		24224	Hose - Upper		25480
C50			Hose - Lower		26603
Nissan H20 Diesel			M60; M70; M80; M100; MT60; MT70; MT80; MT100		
Belt - Fan	21067K7320	6723	IH UC263		
Belt - W.P. & Alt.		7410	Belt - Fan & Alt.; W/47 7/8" Belt O.C.	358320C91	▲9476HD
Belt - Hyd. Pump		TR22588	Belt - Fan & Alt.; W/49 1/4" Belt O.C.	385674R1	▲9490HD
			Belt - Oil Clutch Pump; W/33" Belt O.C.		▲9330HD

≅Cut to Fit.

▲Standard Belt Available.

Lift & Industrial Trucks

Belts and Coolant Hose for Lift & Industrial Trucks

Application	Mfr. Part No.	Our No.	Application	Mfr. Part No.	Our No.
Lift All - Continued			Mercury - Continued		
M60; M70; M80; M100; MT60; MT70; MT80; MT100 - Continued			A930; A940 - Continued		
IH UC263 - Continued			Chrysler Ind. 30-1027		
Belt - Oil Clutch Pump; W/36 1/4" Belt O.C.		♣9360HD	Belt - Fan & Gen.	1191449	TR24476
Hose - Upper; 1972 & Older		≈<20427	Hose - Upper		≈<20046
Hose - Lower; 1972 & Newer		26510	Hose - Lower		≈<21794
Lull			A950		
844 Highlander			Chrysler Ind. 30-128		
Chrysler V-8			Belt - Fan & Gen.		
Belt - Fan & Alt.		②♣9476HD	Belt - Fan & Gen.	1116202	TR24489
Hose - Upper		≈<21378	Chrysler Ind. 30-1027		
Hose - Lower		25530	Belt - Fan & Gen.		
Deutz F5L912 Diesel			Belt - Fan & Gen.		
Belt - Alt.		7453	A960		
Massey Ferguson			Chrysler Ind. 30-1027		
MF202 Forklift; MF204 Forklift			Hose - Upper		
Continental Z134			Hose - Lower		
Belt - Fan & Gen.	181523M1	♣9430HD	Mitsubishi		
Hose - Upper		24224	FGC20; FGC25		
Hose - Lower		≈<20416	Mitsubishi 4-Cyl. Diesel		
	or	25473	Belt - W.P. & Alt.; W/36 1/4" Belt O.C.		
MF2500			Belt - W.P. & Alt.; W/37 3/4" Belt O.C.		
Perkins 3-Cyl. 152 Diesel			Belt - W.P. & Alt.; W/38 1/4" Belt O.C.		
Belt - Fan & Gen.	671870M1	♣9570HD	Mobilift		
Hose - Upper		25473	B; B224		
MF4500			Continental		
Perkins 3-Cyl. 152			Belt - Fan & Gen.		
Belt - Fan & Gen.	509572M1	♣9425HD	Belt - Hyd. Pump		
MF6500			D		
Perkins 4-Cyl. 236 Diesel			Chrysler Ind. 30; Chrysler 6-Cyl. 230		
Belt - Fan & Alt.		♣9525HD	Belt - Fan & Gen.		
Hose - Upper		26504	Belt - Hyd. Pump		
S4AG9A; S5H9A			D424		
Perkins 4-Cyl. Diesel			Chrysler Ind. 30; Chrysler 6-Cyl. 230		
Belt - Fan & Alt.		♣9525HD	Belt - Fan & Gen.		
Mercury			Belt - Hyd. Pump		
A440			Hose - Upper		
Waukesha FC98			Hose - Lower		
Belt - Fan & Gen.		TR20426	E; ER; EW		
Hose - Upper		24232	Minneapolis-Moline		
Hose - Lower		24232	Belt - Gen. & Gov.		
A452			F		
Chrysler 8A-114			Minneapolis-Moline		
Belt - Fan & Gen.	1263790	TR24500	Belt - Belt		
A460			H; HR; HW		
Waukesha FC98			Minneapolis-Moline		
Belt - Fan & Gen.	5315	TR20451	Belt - Gen. & Gov.		
Hose - Lower		24232	K; KW		
A930; A940			Minneapolis-Moline		
Chrysler Ind. 30-128			Belt - Gen.		
Belt - Fan & Gen.	1116202	TR24489	L		
			Chrysler Ind. 30; Chrysler 6-Cyl. 230		
			Belt - Fan & Gen.		
			Belt - Hyd. Pump		

≈<Cut to Fit.
②Two Required.

♣Standard Belt Available.

Belts and Coolant Hose for Lift & Industrial Trucks

Application	Mfr. Part No.	Our No.	Application	Mfr. Part No.	Our No.
Mobilift - Continued			Mobilift - Continued		
L524			MY40		
Chrysler Ind. 30; Chrysler 6-Cyl. 230			Minneapolis-Moline		
Belt - Fan & Gen.	D715	TR24489	Belt - Fan & Alt.	10A16423	7470
Belt - Hyd. Pump.	D716	TR22397	MY40B		
Hose - Upper.		24234	Chrysler 6-Cyl. 225; Chrysler 6-Cyl. 225 LPG		
Hose - Lower.		24224	Belt - Fan.	203003566	7490
M			Belt - Alt.	203003565	7430
Hercules IXB3			Belt - P.S.	203007009	②7400
Belt - Fan & Gen.	M715	TR24449	Belt - Hyd. Pump.	203007009	②7400
Belt - Hyd. Pump; Early.	M716A	TR24414	Perkins 4-Cyl. 236 Diesel		
Belt - Hyd. Pump; Late.	M716B	②♣9440HD	Belt - Fan & Alt.	203005083	♣9520HD
MA0; M50			Belt - P.S.	203007009	②7400
Chrysler Ind. 30; Chrysler 6-Cyl. 230			Hose - Upper - Eng. To Pipe.		25477
Belt - Fan & Gen.	D715	TR24489	Hose - Upper - Pipe To Rad.		24224
Belt - Hyd. Pump.	D716	TR22397	MY50		
Hose - Upper.		24234	Minneapolis-Moline		
Hose - Lower.		24224	Belt - Fan & Alt.	10A16423	7470
M324			MY50B		
Hercules IXB			Chrysler 6-Cyl. 225; Chrysler 6-Cyl. 225 LPG		
Hose - Upper.		24228	Belt - Fan.	203003566	7490
Hose - Lower.		24228	Belt - Alt.	203003565	7430
Hercules IXB3			Belt - P.S.	203007009	②7400
Belt - Fan & Gen.	M715	TR24449	Belt - Hyd. Pump.	203007009	②7400
Belt - Hyd. Pump; Early.	M716A	TR24414	Perkins 4-Cyl. 236 Diesel		
Belt - Hyd. Pump; Late.	M716B	②♣9440HD	Belt - Fan & Alt.	203005083	♣9520HD
MA20; MA25			Belt - P.S.	203007009	②7400
Waukesha FC			Hose - Upper - Eng. To Pipe.		25477
Belt - Fan & Gen.	35A10020	♣9440HD	Hose - Upper - Pipe To Rad.		24224
MA30; MA30 II			MY60		
Minneapolis-Moline			Minneapolis-Moline		
Belt - Fan & Gen.	35A6148	♣9470HD	Belt - Fan & Alt.	10A16423	7470
Belt - Alt.	35A8786	♣9480HD	Hose - Lower.		25474
MA30S			MY60B		
Waukesha FC			Chrysler 6-Cyl. 225; Chrysler 6-Cyl. 225 LPG		
Belt - Fan & Gen.	35A10020	♣9440HD	Belt - Fan.	203003566	7490
MA35; MA40; MA40 II; MA45; MA50; MA50 II; MA55			Belt - Alt.	203003565	7430
Minneapolis-Moline			Belt - P.S.	203007009	②7400
Belt - Fan & Gen.	35A6148	♣9470HD	Belt - Hyd. Pump.	203007009	②7400
Belt - Alt.	35A8786	♣9480HD	Perkins 4-Cyl. 236 Diesel		
MA60; MA60 II			Belt - Fan & Alt.	203005083	♣9520HD
Minneapolis-Moline			Belt - P.S.	203007009	②7400
Belt - Fan.	10A12727	♣9490HD	Hose - Upper - Eng. To Pipe.		25477
Belt - Fan & Gen.	35A6148	♣9470HD	Hose - Upper - Pipe To Rad.		24224
Belt - Alt.	35A8786	♣9480HD	MY70		
MS20; MS25; MS30; MS35			Minneapolis-Moline		
Minneapolis-Moline			Belt - Fan & Alt.	10A16423	7470
Belt - Gen. & Gov.		♣9290HD	MY70B; MY80B		
MSB20; MSB25; MSB30; MSB35			Chrysler 6-Cyl. 225; Chrysler 6-Cyl. 225 LPG		
Ford V-4 104			Belt - Fan.	203003566	7490
Belt - Fan & Alt.	35A9943	7590	Belt - Alt.	203003565	7430
MTS20; MTS25; MTS30; MTS35			Belt - P.S.	203007009	②7400
Minneapolis-Moline			Belt - Hyd. Pump.	203007009	②7400
Belt - Gen. & Gov.		♣9290HD	Perkins 4-Cyl. 236 Diesel		
			Belt - Fan & Alt.	203005083	♣9520HD
			Belt - P.S.	203007009	②7400
			Hose - Upper - Eng. To Pipe.		25477
			Hose - Upper - Pipe To Rad.		24224

♣Standard Belt Available.

②Two Required.

Lift & Industrial Trucks

Belts and Coolant Hose for Lift & Industrial Trucks

Application	Mfr. Part No.	Our No.	Application	Mfr. Part No.	Our No.
Mobilift - Continued			Nissan - Continued		
WC20; WC25			FG101; FG102; FG103		
Waukesha FC			Nissan D11 Diesel		
Belt - Fan & Alt.	35A10020	♣9440HD	Belt - Fan & Alt.; W/Cushion Tires; Mar. 31, 1976 & Older	2106748300	♣9463HD
WC30			Belt - Fan & Alt.; W/Pneumatic Tires; Mar. 31, 1976 & Older		♣9370HD
Continental F163			Belt - Fan & Alt.; Apr. 1, 1976 & Newer	2106747605	♣9455HD
Belt - Fan	10A12727	♣9490HD	Belt - Fan, Alt. & Gov.; W/Cushion Tires	1172047600	♣9451HD
Belt - Fan & Gen.; W/47 1/4" Belt O.C.	35A6148	♣9470HD	Belt - P.S.	48752L0410	TR22416
Belt - Hyd. Pump	35A10015	♣9313HD	Hose - Upper; W/Cushion Tires		20781
Waukesha FC			Nissan SD22 Diesel		
Belt - Fan & Alt.	35A10020	♣9440HD	Hose - Upper; W/Pneumatic Tires		♣21103
WC35; WC40; WC45; WC50; WC55; WC60			FG104; FG105		
Continental F163			Nissan H20 Diesel		
Belt - Fan	10A12727	♣9490HD	Belt - Fan & Alt.; W/Cushion Tires		♣9370HD
Belt - Fan & Gen.; W/47 1/4" Belt O.C.	35A6148	♣9470HD	Belt - Fan; W/Pneumatic Tires	01904K7206	♣9375HD
Belt - Hyd. Pump	35A10015	♣9313HD	Belt - W.P. & Alt.; W/Cushion Tires	2106766000	7360
Namco			Hose - Upper; W/Pneumatic Tires		♣21103
15-15; 20-15			Nissan SD22 Diesel		
Onan CCK Diesel			Belt - Fan	0197810944	♣9375HD
Belt - Alt./Gen.; W/37 5/8" Belt O.C.		7375	Belt - W.P. & Alt.	5835748571	♣9580HD
Belt - Gen.; W/38 1/8" Belt O.C.		7380	FG106; FG107		
Nissan			Nissan H30 Diesel		
3.5; 3.25; 4.0			Belt - Fan & Alt.	2106749100	♣9370HD
Nissan P40			Belt - Gov.	1914574200	♣9412HD
Belt - W.P. & Alt.	11720C6000	TR24465	Nissan SD33 Diesel		
Belt - W.P. & Gov.	21067L6200	♣9375HD	Belt - Fan & Alt.	2106786000	②♣9385HD
Nissan SD33 Diesel			P3		
Belt - W.P. & Alt.	0197810984	♣9390HD	Nissan D11 Diesel		
2700; 3000; 3500			Belt - Fan & Alt.	2106748300	♣9463HD
Nissan J15			Belt - Hyd. Pump	5833648600	②TR22474
Belt - Fan & Alt.	11720U0105	7355	P5		
Hose - Upper		♣20883	Nissan 6-Cyl.		
Hose - Lower; W/Cushion Tires		♣20783	Belt - Fan & Alt.	2106749100	♣9370HD
4000; 5000; 6000			Belt - Gov.	1914574200	♣9405HD
Nissan H20 Diesel			Nissan H20 Diesel		
Belt - Fan & Alt.	11720L1102	7410	Belt - Fan & Alt.; W/36 1/8" Belt O.C.	2106766000	7360
Hose - Upper		♣21201	Belt - Fan & Alt.; W/39 1/4" Belt O.C.	191044800	♣9360HD
Nissan SD22 Diesel			Belt - Hyd. Pump	2114048285	♣9550HD
Belt - Fan & Alt.; Dec. 31, 1979 & Older	0197811104	♣9435HD	Hose - Upper		♣21103
Belt - Fan & Alt.; Jan. 1, 1980 & Newer	0197811134	♣9430HD	P8		
Hose - Lower - Eng. To Pipe		♣20776	Nissan 6-Cyl.		
Hose - Lower - Pipe To Rad.		24222	Belt - Fan & Alt.	2106749100	♣9370HD
F03			Belt - Gov.	1914574200	♣9405HD
Nissan TB42			Nissan H20 Diesel		
Belt - Fan	1172052H05	TR24489	Belt - Fan & Alt.; W/36 1/8" Belt O.C.	2106766000	7360
Belt - Alt.	1172052H01	7480	Belt - Fan & Alt.; W/39 1/4" Belt O.C.	191044800	♣9360HD
Belt - Gov.	1172077702	7385	Belt - Hyd. Pump	2114048285	♣9550HD
FG005			Ottawa		
Nissan H20 Diesel			1-Step-30; Commando 30; Commando 30A; Commando 50		
Belt - Fan & Alt.; W/Cushion Tires		♣9370HD	Cummins V-8 210 Diesel		
Belt - Fan; W/Pneumatic Tires	01904K7206	♣9375HD	Belt - Fan	178685	②TR22485
Belt - W.P. & Alt.; W/Cushion Tires	2106766000	7360	Belt - Alt.	178473	♣9350HD
Hose - Upper; W/Pneumatic Tires		♣21103			
Nissan SD22 Diesel					
Belt - Fan	0197810944	♣9375HD			
Belt - W.P. & Alt.	5835748571	♣9580HD			

♣Standard Belt Available.
②Two Required.

♣Cut to Fit.
◆PowerBand Belt May Work, Use Template to Check.

Belts and Coolant Hose for Lift & Industrial Trucks

Application	Mfr. Part No.	Our No.	Application	Mfr. Part No.	Our No.
Ottawa - Continued			Pettibone - Continued		
Commando 60T			100FLW		
Caterpillar 1160 Diesel			Waukesha ICK		
Belt - Fan, Alt. & Air Brake Compr.	②◆◆9640HD		Belt - Fan & Gen.	4154	TR22336
Belt - Fan & P.S.	②◆◆9540HD		200		
Hose - Upper	26510		Aerojet		
Hose - Lower	26511		Belt - Fan & Gen.	4132	TR22299
Cummins V555 Diesel			200FLW; 200W		
Belt - Fan	189917	②◆◆9490HD	Waukesha ICK		
Belt - Alt.		7430	Belt - Fan & Gen.	4154	TR22336
YT30			250		
Cummins B Series 5.9 L Diesel			Aerojet		
Belt - Fan & Alt.	3911562	◆K080575HD	Belt - Fan & Gen.	4132	TR22299
Hose - Upper		26612	250FLW; 250W		
Hose - Lower		26521	Waukesha ICK		
YT50			Belt - Fan & Gen.		
Caterpillar 3208 Diesel			Belt - Fan & Gen.	4154	TR22336
Belt - Fan	②◆◆9430HD		300		
Belt - W.P., Alt. & Air Brake Compr.	②◆◆9640HD		Aerojet		
Belt - P.S.	②◆◆9530HD		Belt - Fan & Gen.	4132	TR22299
Hose - Upper		26509	300FLW		
Hose - Lower		26510	Waukesha ICK		
Detroit Diesel V-8 8.2 L Diesel			Belt - Fan & Gen.	4154	TR22336
Belt - Fan & Alt.	②◆◆9690HD		300G; 300GT; 300P		
Belt - Fan & Air Brake Compr.	◆9710HD		Continental F162		
Belt - P.S.	②◆◆9430HD		Hose - Upper		26502
Pettibone			Hose - Lower		25478
6-33			Continental F6226		
Chrysler 6-Cyl. 225			Belt - Fan & Gen.	F226K286	◆9480HD
Belt - Fan & Alt.		7525	300W		
Belt - W.P.		7395	Waukesha ICK		
Hose - Upper		26512	Belt - Fan & Gen.	4154	TR22336
Hose - Lower - Eng. To Pipe		26509	400		
Hose - Lower - Pipe To Rad.		26512	Waukesha 4-Cyl.		
8-33			Belt - Fan & P.S.	4590	TR22461
Detroit Diesel 4-53 Diesel			Belt - Gen.	4625	9300
Belt - Fan	②7360		400G; 400GT; 400P		
Belt - W.P. & Alt.	②7430		Continental F162		
Hose - Upper	≅21378		Hose - Upper		26502
	or		Hose - Lower		25478
Hose - Lower - Eng. To Pipe		26602	Continental F6226		
Hose - Lower - Pipe To Rad.		24232	Belt - Fan & Gen.	F226K286	◆9480HD
		24232	500		
20GS4; 25GS4			Waukesha 4-Cyl.		
Continental Y112			Belt - Fan & P.S.	4590	TR22461
Belt - Fan & Alt.	Y91K00235	②7430	Belt - Gen.	4625	9300
30GA; 30GS			500G; 500GT; 500P		
Continental F162			Continental F162		
Belt - Fan; 1966 & Newer		②7603	Hose - Upper		26502
30GS4			Hose - Lower		25478
Continental Y112			Continental F6226		
Belt - Fan & Alt.	Y91K00235	②7430	Belt - Fan & Gen.	F226K286	◆9480HD
40GA; 40GS; 50GA; 50GS			500		
Continental F162			Waukesha 4-Cyl.		
Belt - Fan; 1966 & Newer		②7603	Belt - Fan & P.S.	4590	TR22461
100			Belt - Gen.	4625	9300
Aerojet			500G; 500GT; 500P		
Belt - Fan & Gen.	4132	TR22299	Continental F162		
			Hose - Upper		26502
			Hose - Lower		25478
			Continental F6226		
			Belt - Fan & Gen.	F226K286	◆9480HD

◆Standard Belt Available.
②Two Required.

◆PowerBand Belt May Work, Use Template to Check.
≅Cut to Fit.

Lift & Industrial Trucks

Belts and Coolant Hose for Lift & Industrial Trucks

Application	Mfr. Part No.	Our No.	Application	Mfr. Part No.	Our No.
Pettibone - Continued			Pettibone - Continued		
600GTC			Cary-Lift Super 5		
Continental F226			Ford 4-Cyl. 256 Diesel		
Hose - Upper		26502	Hose - Upper	⊖20065	
Hose - Lower		25473		or	25474
Continental F6226			Ford 6-Cyl. 256 Diesel		
Belt - Fan & Gen. F226K286		♣9480HD	Belt - Fan & Alt.		♣9550HD
600GTF			Belt - Hyd. Pump		♣9395HD
Ford 4-Cyl. 172 Diesel			John Deere 4219D Diesel		
Hose - Upper		25252	Belt - Fan & Alt. T24473		TR22514
Hose - Lower		25476	Belt - Hyd. Pump		♣9380HD
700GTC			Hose - Upper		⊖21794
Continental F226				or	25474
Hose - Upper		26502	Hose - Lower - Eng. To Pipe		⊖20046
Hose - Lower		25473	Hose - Lower - Pipe To Rad.		⊖20974
Continental F6226			Cary-Lift Super 6		
Belt - Fan & Gen. F226K286		♣9480HD	IH 6-Cyl.		
Cary-All Super 8			Belt - Fan & Alt. 274705R1		TR24438
Continental F226; Continental F244			Cary-Lift Super 7		
Belt - Fan & Gen. F600K267		TR24465	Continental F226		
Cary-Lift 6			Belt - Fan	F226K286	♣9480HD
IH 6-Cyl.			Cary-Lift Super 8		
Hose - Upper		26508	Continental F226; Continental F244		
Hose - Lower - Eng. To Pipe		24232	Belt - Fan & Gen. F600K267		TR24465
Hose - Lower - Pipe To Rad.		24232	Cary-Lift Super 10; Cary-Lift Super 15		
Cary-Lift 8			Chrysler Ind. 32		
Continental F226			Belt - Fan & Gen. 1116202		TR24489
Belt - Fan & Gen. F600K267		TR24465	Continental M363		
Continental F244			Belt - Fan	M330K342	7520
Belt - Fan & Gen. F600K267		TR24465	Detroit Diesel 3-71 Diesel		
Hose - Upper		⊖20416	Belt - Fan	5170972	⊗TR22455
	or	25474	Belt - Gen. 3224367		TR28390
Cary-Lift 54H			Cary-Lift Super 20		
Hercules GO339			Cummins JN6BI Diesel		
Belt - Fan & Gen.		♣9490HD	Belt - Fan	124466	⊗TR24365
Hose - Upper		26510	Belt - W.P. 101427		TR22299
Hose - Lower		⊗26508	Belt - Gen. 70885		TR22461
Cary-Lift 150			Hose - Upper		26509
Chrysler Ind. 32			Hose - Lower		26508
Belt - Fan & Gen. 1116202		TR24489	Detroit Diesel 4-71 Diesel		
Cary-Lift 204D			Belt - Fan	5170972	⊗TR22455
Detroit Diesel 6V-53 Diesel			Belt - Gen. 3224367		TR28390
Belt - Fan		⊗♣9350HD	Cary-Lift Super 25		
Belt - Alt.		⊗7390	Detroit Diesel 4055C Diesel		
Belt - W.P.		⊗♣9375HD	Belt - Fan	3224368	TR34545
Hose - Upper - Left Side		26502	Belt - Fan & Air Brake Compr.	3224451	TR34700
Hose - Upper - Right Side		26502	Belt - Gen. 3224367		TR28390
Hose - Lower		26523	Cary-Lift Super 30		
Cary-Lift Super 4			Detroit Diesel 4-71 Diesel		
Ford 6-Cyl. 240			Belt - Fan	5176420	⊗TR22588
Belt - Fan		♣9405HD	Belt - Fan & Air Brake Compr.	5175105	⊗BX71
Belt - W.P. & Alt.		7417	Belt - Gen. 3224367		TR28390
Belt - Gov. C7JZ 8620 P		7260	Detroit Diesel 6055C Diesel		
Hose - Upper		26502	Belt - Fan	5170972	⊗TR22455
Hose - Lower		26502	Belt - Gen. 3224367		TR28390

♣Standard Belt Available.
⊗Two Required.

⊖Cut to Fit.

Belts and Coolant Hose for Lift & Industrial Trucks

Application	Mfr. Part No.	Our No.	Application	Mfr. Part No.	Our No.
Skytrak - Continued			TCI - Continued		
5028; 5028HT; 6036; 10042			H4M50; H4M60; H4M80 - Continued		
Cummins 4-Cyl. 3.9 L Diesel			Ford 4-Cyl. 172 Diesel - Continued		
Belt - Fan & Alt.	3911560	▲K080550HD	Hose - Upper - Eng. To Pipe		24220
Snorkel Lift			Hose - Lower - Eng. To Pipe		24224
A42			Waukesha VPD220A Diesel		
Ford 4-Cyl.			Belt - Fan		7470
Belt - Fan & Alt.		7350	Belt - W.P. & Alt.	166226	7445
A60			Hose - Lower - Eng. To Pipe		26515
Ford 4-Cyl.			Herculift 40		
Belt - Fan & Alt.		▲K060415HD	Waukesha VRG155A		
ATB46N			Belt - Fan & Alt.	166226	7445
Ford LS9423			Hose - Upper		20355
Belt - Fan & Alt.		7375	Hose - Lower		20357
PRO126			TCM-Toyo		
Continental TM27			FCG25		
Belt - Fan & Alt.		▲K080560HD	Nissan H20 Diesel		
Hose - Upper		20046	Belt - Fan & Alt.	11720L1102	7410
Hose - Lower		21194	Hose - Upper		25476
SLH3280HG			Hose - Lower		25476
Kubota 3-Cyl.			FD35		
Belt - Fan & Alt.		7375	Isuzu DA220 Diesel		
SLH3284HD			Belt - Fan	13671198	ⓂTR22545
Kubota 3-Cyl.			Hose - By Pass - W.P. To Pipe		24216
Belt - Fan & Alt.	REMF1345	7345	Hose - By Pass - Pipe To Thermostat		24216
TB37			FG10 II; FG14 II		
Ford 4-Cyl.			Nissan D11 Diesel		
Belt - Fan & Alt.	11A0890	7350	Belt - Fan	2106748300	▲9463HD
Taylor			FG15		
Y20WO			Nissan J15		
Detroit Diesel 4-53 Diesel			Belt - Fan & Alt.	11720K7201	7370
Belt - Fan		②▲9412HD	Hose - Upper		25253
Belt - W.P. & Alt.		7417	Hose - Lower		Ⓜ<20137
Hose - Upper		26506		or	25253
Hose - Upper - Eng. To Pipe		24232	FG20		
Hose - Upper - Pipe To Rad.		24232	Nissan		
TCI			Belt - Fan & Alt.		
D4P60			11720L1102		
Detroit Diesel 4-53 Diesel			7410		
Belt - Fan		②▲9313HD	Nissan H20 Diesel		
Belt - W.P. & Alt.		②▲9430HD	Hose - Upper		
Hose - Upper		24224	Hose - Lower		
D4P80			25253		
John Deere 4239D Diesel			25477		
Belt - Fan & Alt.		②▲9590HD	FG20 III; FG25N3		
Hose - Upper - Eng. To Pipe		Ⓜ<21194	Nissan H20 Diesel		
D4P100			Belt - Fan		
John Deere 4239D Diesel			▲9390HD		
Belt - Fan & Alt.		②▲9590HD	Belt - W.P.		
H4M50; H4M60; H4M80			2106766000		
Ford 4-Cyl. 172 Diesel			7360		
Belt - Fan & Alt.		▲9412HD	FG30M		
Belt - P.S.		TR22474	Isuzu G201		

▲Standard Belt Available.
ⓂCut to Fit.

ⓂTwo Required.

Belts and Coolant Hose for Lift & Industrial Trucks

Application	Mfr. Part No.	Our No.	Application	Mfr. Part No.	Our No.
Teco-Crab			Towmotor - Continued		
8000-42			460		
Detroit Diesel 3-53 Diesel			Continental F140; Continental Y112		
Belt - Fan	5119188	②▲9390HD	Belt - Fan & Gen.; W/33 1/4" Belt O.C.	A40909	▲9330HD
Belt - W.P. & Alt.	5133601	②7410	Belt - Fan & Gen.; W/39 1/4" Belt O.C.	A29001	▲9390HD
Hose - Upper		24232	Belt - Fan & Gen.; W/40 3/4" Belt O.C.	A15645	▲9405HD
	or	25473			
Towmotor			461		
350			Continental F140; Continental F162		
Continental N62			Belt - Fan & Gen.		
Belt - Fan & Gen.	B19469	TR22373	Belt - Fan; W/P.S.	66694C2	▲9350HD
Hose - Upper		26502	Belt - P.S.	47563	▲9415HD
Hose - Lower		≈<21794			
	or	25476			
351S			462S		
Continental Y112			Continental F140		
Belt - Fan	B99481	7417	Belt - Fan & Gen.	A40909	▲9330HD
390; 391; 391S; 392S; 400P			Belt - Fan; W/P.S.		
Continental F140; Continental Y112			Belt - P.S.	47563	▲9415HD
Belt - Fan & Gen.; W/33 1/4" Belt O.C.	A40909	▲9330HD	Hose - Lower		≈<21794
Belt - Fan & Gen.; W/39 1/4" Belt O.C.	A29001	▲9390HD		or	25473
Belt - Fan & Gen.; W/40 3/4" Belt O.C.	A15645	▲9405HD			
410; 411			480P		
Continental Y112			Continental F140; Continental Y112		
Belt - Fan	A53536	7450	Belt - Fan & Gen.; W/33 1/4" Belt O.C.	A40909	▲9330HD
Belt - Gen.	A53537	7350	Belt - Fan & Gen.; W/39 1/4" Belt O.C.	A29001	▲9390HD
420			Belt - Fan & Gen.; W/40 3/4" Belt O.C.		
Continental F140; Continental Y112				A15645	▲9405HD
Belt - Fan & Gen.; W/33 1/4" Belt O.C.	A40909	▲9330HD	500; 500P; 501; 501P		
Belt - Fan & Gen.; W/39 1/4" Belt O.C.	A29001	▲9390HD	Continental F140; Continental F162		
Belt - Fan & Gen.; W/40 3/4" Belt O.C.	A15645	▲9405HD	Belt - Fan & Gen.		
421			Belt - Fan; W/P.S.		
Continental F140; Continental F162			Belt - P.S.	47563	▲9415HD
Belt - Fan & Gen.	A40909	▲9330HD	502P; 502S		
Belt - Fan; W/P.S.	66694C2	▲9350HD	Continental F140		
422S			Belt - Fan & Gen.		
Continental F140			Belt - Fan; W/P.S.		
Belt - Fan & Gen.	A40909	▲9330HD	Belt - P.S.	47563	▲9415HD
Belt - Fan; W/P.S.	66694C2	▲9350HD	Continental F162		
Continental F162			Belt - Fan & Gen.		
Belt - Fan & Gen.	A40909	▲9330HD	Belt - Fan; W/P.S.	66694C2	▲9350HD
Belt - Fan; W/P.S.	66694C2	▲9350HD	Belt - P.S.	47563	▲9415HD
Hose - Lower		≈<21794	Hose - Lower		≈<21794
	or	25473		or	25473
440			510P		
Continental Y112			Continental F140; Continental F162		
Belt - Fan	A53536	7450	Belt - Fan & Gen.		
Belt - Gen.	A53537	7350	Belt - Fan; W/P.S.		
441			Belt - P.S.		
Continental F140			47563		
Belt - Fan & Gen.	A40909	▲9330HD	Continental F209; Continental F226; Continental F244		
Belt - Fan; W/P.S.	66694C2	▲9350HD	Belt - Fan & Gen.		
Continental Y112			Belt - P.S.; W/28 1/4" Belt O.C.		
Belt - Fan	A53536	7450	Belt - P.S.; W/41 3/4" Belt O.C.	47563	▲9415HD
Belt - Gen.	A53537	7350	Hose - Upper		25476
441			Hose - Lower		
Continental F140			25473		
Belt - Fan & Gen.	A40909	▲9330HD	590		
Belt - Fan; W/P.S.	66694C2	▲9350HD	Continental F209; Continental F226		
Continental Y112			Belt - Fan & Gen.		
Belt - Fan	A53536	7450	Belt - P.S.	47563	▲9415HD
Belt - Gen.	A53537	7350			

②Two Required.
▲Standard Belt Available.

≈<Cut to Fit.

Lift & Industrial Trucks

Belts and Coolant Hose for Lift & Industrial Trucks

Application	Mfr. Part No.	Our No.	Application	Mfr. Part No.	Our No.
Towmotor - Continued			Towmotor - Continued		
590 - Continued			A15; A16; A18; A20; A22; A24 - Continued		
Continental Y112			Detroit Diesel 4-53 Diesel - Continued		
Belt - Fan	57931	7480	Hose - Upper		26507
Belt - Gen.	A57932	7417	B10; B12		
590S			Continental F244		
Continental F209; Continental F226			Belt - Fan & W.P. 36902		
Belt - Fan & Gen.	A40909	♣9330HD	Hose - Upper		♣9360HD
Belt - P.S.	47563	♣9415HD	Hose - Lower		25480
600			Hose - Lower		
Continental F209; Continental F226; Continental F244			Hose - Lower		
Belt - Fan & Gen.	A36902	♣9360HD	B15; B16; B18; B20; B22; B24		
Belt - P.S.; W/28 1/4" Belt O.C.	66694C1	9279	Continental M330		
Belt - P.S.; W/41 3/4" Belt O.C.	47563	♣9415HD	Belt - Fan, W.P. & Gen. 629029C50		
Hose - Upper		25476	Hose - Upper		
Hose - Lower		25473	Hose - Lower		
601P			Hose - Lower		
Continental F140			Detroit Diesel 4-53 Diesel		
Belt - Fan & Gen.	A40909	♣9330HD	Belt - Fan		
Belt - Fan; W/P.S.	66694C2	♣9350HD	Belt - W.P. & Gen.; W/34 1/4" Belt O.C. 5121847		
Continental F162			Belt - W.P. & Gen.; W/41 3/4" Belt O.C. 5120937		
Belt - Fan & Gen.	A40909	♣9330HD	Belt - W.P. & Gen.; W/43 1/8" Belt O.C. 5114440		
Belt - Fan; W/P.S.	66694C2	♣9350HD	Belt - W.P. & Gen.; W/44 1/4" Belt O.C. 5125514		
Hose - Lower		♣21794	Hose - Lower		
	or	25473	Hercules Diesel		
670; 680P			Hose - Upper		
Continental F209; Continental F226; Continental F244			Hose - Lower		
Belt - Fan & Gen.	A36902	♣9360HD	B25		
Belt - P.S.; W/28 1/4" Belt O.C.	66694C1	9279	Continental M330		
Belt - P.S.; W/41 3/4" Belt O.C.	47563	♣9415HD	Belt - Fan, W.P. & Gen. 629029C50		
Hose - Upper		25476	Hose - Upper		
Hose - Lower		25473	Hose - Lower		
750S			Detroit Diesel 4-53 Diesel		
Continental F209; Continental F266			Belt - Fan		
Belt - Fan & Alt.	B66694C6	♣9350HD	Belt - W.P. & Gen.; W/34 1/4" Belt O.C. 5121847		
Belt - Fan & Gen.	A36902	♣9360HD	Belt - W.P. & Gen.; W/41 3/4" Belt O.C. 5120937		
900			Belt - W.P. & Gen.; W/43 1/8" Belt O.C. 5114440		
Continental F209; Continental F266			Belt - W.P. & Gen.; W/44 1/4" Belt O.C. 5125514		
Belt - Fan & Gen.	A40909	♣9330HD	K5-30; K5-33		
Belt - P.S.	47563	♣9415HD	Continental F162		
A10; A12			Belt - Fan & Gen.; W/21/32" Belt T.W.;		
Continental F244			W/39 5/8" Belt O.C. B11724		
Belt - Fan & W.P.	36902	♣9360HD	Belt - Fan & Gen.; W/1/2" Belt T.W.; W/39		
Hose - Upper		25480	1/4" Belt O.C. A29001		
Hose - Lower		25473	Hose - Upper; Ser. No. K5305336 & After		
A15; A16; A18; A20; A22; A24			Hose - Lower; Ser. No. K5305336 & After		
Continental M330			K5-36		
Belt - Fan, W.P. & Gen.; Ser. No. 610040	629027C10	②7550	Continental F162		
& Before			Belt - Fan & Gen.; W/21/32" Belt T.W.;		
Belt - Fan, W.P. & Gen.; Ser. No. 610041	629028C22	②♣9463HD	W/39 5/8" Belt O.C. B11724		
& Newer			Belt - Fan & Gen.; W/1/2" Belt T.W.; W/39		
Hose - Upper		26611	1/4" Belt O.C. A29001		
Hose - Lower		26501	Hose - Upper; Ser. No. K536543 & After		
Detroit Diesel 4-53 Diesel			Hose - Lower; Ser. No. K536543 & After		
Belt - Fan	C629027C8	7490	K5-40		
Belt - W.P. & Gen.; W/34 1/4" Belt O.C.	5121847	7340	Continental F162		
Belt - W.P. & Gen.; W/41 3/4" Belt O.C.	5120937	②7417	Belt - Fan & Gen.; W/21/32" Belt T.W.;		
Belt - W.P. & Gen.; W/43 1/8" Belt O.C.	5114440	②7430	W/39 5/8" Belt O.C. B11724		
Belt - W.P. & Gen.; W/44 1/4" Belt O.C.	5125514	②7440	Belt - Fan & Gen.; W/1/2" Belt T.W.; W/39		
			1/4" Belt O.C. A29001		
			Hose - Upper; Ser. No. K5305311 & After		
			Hose - Lower; Ser. No. K5405311 & After		
			T30B; T35B; T40B; T45B; T50B; T60B		
			Continental F163; Continental F227		
			Belt - Fan & Alt. 303291		
			♣9370HD		

♣Standard Belt Available.
②Two Required.

♣Cut to Fit.

Belts and Coolant Hose for Lift & Industrial Trucks

Application	Mfr. Part No.	Our No.	Application	Mfr. Part No.	Our No.
Towmotor - Continued			Toyota - Continued		
T30B; T35B; T40B; T45B; T50B; T60B - Continued			3FG35		
Continental F163; Continental F227 - Continued			Toyota 2F		
Belt - Fan & P.S.	303291	▲9370HD	Belt - Fan & Alt.		TR22588
Belt - P.S.	303288	9279	Hose - Upper		≈<20702
Hose - Lower		25472		or	25478
T60C; T70C; T80C; T90C; T100C; T120C			3FGC20; 3FGC25		
Continental F227			Toyota 5R		
Belt - Fan & Alt.	303291	▲9370HD	Belt - Fan & Alt.; W/38 3/4" Belt O.C.	163711018071	▲9385HD
Hose - Upper		≈<20416	Belt - Fan & Alt.; W/39 3/4" Belt O.C.	502FG1516371	▲9395HD
	or	25476	Belt - Fan & Alt.; W/40 1/4" Belt O.C.	163742010071	▲9400HD
			Belt - Fan & Alt.; W/41 3/4" Belt O.C.		▲9415HD
			Belt - Fan & Alt.; W/42 1/4" Belt O.C.	9951211068	▲9420HD
			Belt - Fan & Alt.; W/42 3/4" Belt O.C.	163712010071	▲9425HD
U6; U8			4FGC20		
Continental F244			Toyota 5P		
Belt - Fan & Alt.	C629027C17	7400	Hose - Upper		≈<20661
Belt - Fan & Gen.	A36902	▲9360HD		or	25251
Belt - P.S.	C629027C17	7400			
Belt - Air Brake Compr.	C629028C17	▲9520HD			
Belt - Hyd. Pump	C629028C6	②▲9451HD			
Hose - Upper		25480			
Hose - Lower		25473			
V30B; V35B; V40B; V45B; V50B; V55B; V60B			Toyota 5R		
Continental F163			Belt - Fan & Alt.	9901121599	TR22416
Belt - Fan & Alt.		▲9370HD	Hose - Upper		≈<20661
Belt - P.S.		9279		or	25251
Hose - Lower		≈<20450			
	or	25472			
Continental F227			815T		
Belt - Fan & Alt.		▲9370HD	Toyota 5R		
Belt - P.S.		9279	Belt - Fan & Alt.	9934301215	TR22485
Hose - Lower		≈<20450			
	or	25472			
Continental F227			FG15; FG20; FG25		
Belt - Fan & Alt.		▲9370HD	Toyota 5R		
Belt - P.S.		9279	Belt - Fan & Alt.; W/38 3/4" Belt O.C.	163711018071	▲9385HD
			Belt - Fan & Alt.; W/39 3/4" Belt O.C.	502FG1516371	▲9395HD
			Belt - Fan & Alt.; W/40 1/4" Belt O.C.	163742010071	▲9400HD
			Belt - Fan & Alt.; W/41 3/4" Belt O.C.		▲9415HD
			Belt - Fan & Alt.; W/42 1/4" Belt O.C.	9951211068	▲9420HD
			Belt - Fan & Alt.; W/42 3/4" Belt O.C.	163712010071	▲9425HD
V60C; V70C; V80C			FG28		
Continental F227; Detroit Diesel 4-53 Diesel; Ford 6-Cyl. 240			Toyota 5P		
Belt - Fan & Alt.	2P6212	▲9505HD	Belt - Fan & Alt.	9934301125	TR24489
Belt - W.P.	1P4313	▲9625HD	Hose - Upper		≈<20661
				or	25251
V100; V120; V140			Toyota 5R		
Ford 6-Cyl. 240			Hose - Upper		≈<20661
Belt - Fan & Alt.	3P130	▲9500HD		or	25251
Perkins 4-Cyl. 236 Diesel					
Belt - Fan & Alt.	680610	▲9530HD			
V160; V180; V200; V225			FG30; FG35; FG40		
Caterpillar 3145 Diesel			Toyota 6-Cyl. 3.9 L		
Belt - Fan & Alt.	688546	▲9630HD	Belt - Fan & Alt.	9952311152	TR20451
Ford V-8 351			FGC10; FGC15; FGC20; FGC25		
Belt - Fan & Alt.	617140	▲9540HD	Toyota 5R		
Toyota			Belt - Fan & Alt.; W/38 3/4" Belt O.C.	163711018071	▲9385HD
2FG15			Belt - Fan & Alt.; W/39 3/4" Belt O.C.	502FG1516371	▲9395HD
Toyota 5R			Belt - Fan & Alt.; W/40 1/4" Belt O.C.	163742010071	▲9400HD
Belt - Fan & Alt.	163722010071	▲9440HD	Belt - Fan & Alt.; W/41 3/4" Belt O.C.		▲9415HD
2FG20; 2FG25			Belt - Fan & Alt.; W/42 1/4" Belt O.C.	9951211068	▲9420HD
Toyota 5R			Belt - Fan & Alt.; W/42 3/4" Belt O.C.	163712010071	▲9425HD
Belt - Fan & Alt.; W/38 3/4" Belt O.C.	163711018071	▲9385HD	United Tractor		
Belt - Fan & Alt.; W/39 3/4" Belt O.C.	502FG1516371	▲9395HD	CB3 Chore Boy		
Belt - Fan & Alt.; W/40 1/4" Belt O.C.	163742010071	▲9400HD	Continental NA62		
Belt - Fan & Alt.; W/41 3/4" Belt O.C.		▲9415HD	Belt - Fan & Gen.	33229	▲9330HD
Belt - Fan & Alt.; W/42 1/4" Belt O.C.	9951211068	▲9420HD	Hose - Upper		25476
Belt - Fan & Alt.; W/42 3/4" Belt O.C.	163712010071	▲9425HD	Hose - Lower		25472

▲Standard Belt Available.
②Two Required.

≈<Cut to Fit.

Lift & Industrial Trucks

Belts and Coolant Hose for Lift & Industrial Trucks

Application	Mfr. Part No.	Our No.	Application	Mfr. Part No.	Our No.
United Tractor - Continued			White		
CB50 Chore Boy			2-78 Forklift; 4-78 Forklift		
Wisconsin VG4D			White 6-Cyl. 265		
Belt - Gen.	30375	2240	Belt - Fan & Alt.	158679A	7450
SM26 Shop Mule; SM30 Shop Mule			Belt - P.S.	157176AA	7290
Continental Y112			Belt - A.C.	167897A	7480
Belt - Fan & Gen.	35009	7405	White 6-Cyl. 283 Diesel		
Belt - Fan & Alt.	37351	7400	Belt - Fan & Alt.	162071A	Ⓣ7460
Hose - Upper		24228	Belt - P.S.	157177AA	7375
Hose - Lower		25476	Belt - A.C.	167897A	7480
SM40 Shop Mule; SM50 Shop Mule			1680		
Continental			Chrysler 6-Cyl. 225		
Belt - Fan & Gen.	34799	TR24476	Belt - Fan & Alt.		♣9540HD
Belt - Fan & Alt.	37399	TR24500	Belt - W.P.		♣9390HD
Hose - Upper		26603	Belt - Hyd. Pump		♣9520HD
Hose - Lower		25477	Hose - Upper		25530
SM80 Shop Mule			Hose - Lower		26504
Continental			Yale		
Belt - Fan & Gen.	36252	♣9480HD	AT20; AT30X		
Belt - Fan & Alt.	34294	♣9510HD	IH U2A		
Continental F244			Belt - Fan	607K410	TR26341
Hose - Upper		25474	Belt - Gen.	607K411	6826
Hose - Lower		25474	G3 Series		
SM160 Shop Mule			Chrysler Ind. 52		
Continental M363			Hose - Upper		≈<20957
Belt - Fan & P.S.	33231	Ⓣ♣9463HD		or	26502
Belt - Gen. & W.P.	33230	7555	Hose - Lower		25480
Hose - Upper		≈<20957	Chrysler Ind. 54		
		or	Belt - Fan		Ⓣ♣9463HD
Hose - Lower		26502	Hose - Upper		≈<20957
		26603		or	26502
Walden			Hose - Lower		25480
4100			Ford V-8 272		
Continental 4-Cyl.			Belt - Fan; W/40 1/4" Belt O.C.	800908	TR28400
Belt - Fan & Alt.		♣9470HD	Belt - Fan; W/41" Belt O.C.	803740	TR28406
Hose - Upper		26501	Belt - W.P. & Gen.	800911	♣9451HD
5000			Hose - Upper; Early		≈<20957
Ford 4-Cyl. 172; Ford 4-Cyl. 172 Diesel				or	26502
Hose - Upper		25251	Hose - Upper; Late		25530
Hose - Lower - Eng. To Pipe		24224	Hose - Lower; Early		25480
Hose - Lower - Pipe To Rad.		≈<20121	Hose - Lower; Late		≈<20046
Hose - By Pass		≈<20338		or	26602
Ford 4-Cyl. Diesel			G5 Series		
Belt - Fan & Alt.		♣9415HD	Ford V-8 272		
5100			Belt - Fan	800908	TR28400
Continental 4-Cyl.			Belt - W.P. & Gen.	800911	♣9451HD
Belt - Fan		♣9465HD	Hose - Upper		25530
Hose - Upper		26501	Hose - Lower		26501
6000			Ford V-8 292		
Ford 4-Cyl.			Belt - Fan		TR28437
Belt - Fan & Alt.		♣9650HD	Belt - W.P. & Gen.	800911	♣9451HD
Ford 4-Cyl. 172; Ford 4-Cyl. 172 Diesel			Hose - Upper		25530
Hose - Upper		25251	Hose - Lower		26501
Hose - Lower - Eng. To Pipe		24224	G10P		
Hose - Lower - Pipe To Rad.		≈<20121	Chrysler 6-Cyl. 225		
Hose - By Pass		≈<20338	Belt - Fan & Alt.		7417
			Hose - By Pass		28441

♣Standard Belt Available.
≈<Cut to Fit.

ⓉTwo Required.

Belts and Coolant Hose for Lift & Industrial Trucks

Application	Mfr. Part No.	Our No.	Application	Mfr. Part No.	Our No.
Yale - Continued			Yale - Continued		
G51C			G54C Series - Continued		
Continental F163			Continental F162 - Continued		
Hose - Upper		26612	Hose - Lower	≈21660	
Hose - Lower		25476	or	25476	
G51C Series			G54P Series		
Chrysler Ind. 30			Chrysler Ind. 31		
Belt - Alt.	570440	②7516	Belt - Fan	605273	TR24489
Belt - P.S.	665606	♣9463HD	Belt - Hyd. Pump	605267	TR24379
Belt - Hyd. Pump; W/40,000 To 50,000 Lb. Hyd. Pump	568119	②♣9400HD	Hose - Upper		25476
Belt - Hyd. Pump; W/60,000 To 80,000 Lb. Hyd. Pump	670481	③7400	Hose - Lower		24224
Belt - Hyd. Pump; W/100,000 Lb. Hyd. Pump	583009	③♣9415HD	G81; G83C; G83P; G86		
Continental F162			Chrysler 6-Cyl. 225		
Belt - Fan & Alt.	650199	②7480	Hose - Upper		25476
Belt - P.S.	650145	♣9341HD	Hose - Lower		25473
Continental F163			G357A		
Belt - Fan & Alt.	065019900	②7480	Mazda 4-Cyl.		
Belt - Hyd. Pump		♣9451HD	Belt - Fan & Alt.		♣9451HD
G51CN Series			GC Series		
Continental F163			Continental F163		
Belt - Fan & Alt.	065019900	②7480	Belt - Fan & Alt.	065019900	②7480
Belt - Aux. Pump	065014500	♣9341HD	GC100; GC150		
G51NC			Chrysler 6-Cyl. 225		
Continental F163			GLC Series		
Hose - Lower		25476	Continental F163		
G51P Series			Belt - Fan & Alt.		
Chrysler Ind. 30			065019900		
Belt - Alt.	570440	②7516	②7480		
Belt - P.S.	665606	♣9463HD	GLC050		
Belt - Hyd. Pump; W/40,000 To 50,000 Lb. Hyd. Pump	568119	②♣9400HD	Mazda VA		
Belt - Hyd. Pump; W/60,000 To 80,000 Lb. Hyd. Pump	670481	③7400	Belt - Fan & Alt.		♣9420HD
Belt - Hyd. Pump; W/100,000 Lb. Hyd. Pump	583009	③♣9415HD	Hose - Upper		20661
Continental F162			or		
Belt - Fan & Alt.	650199	②7480	25251		
Belt - P.S.	650145	♣9341HD	≈21942		
G52 Series			GP040; GP050R		
Continental F124			Mazda VA		
Belt - Fan	607K410	TR26341	Belt - Fan & Alt.		♣9480HD
Belt - Fan & Gen.		TR28437	Hose - Lower		25476
Belt - Gen.	607K411	9260	GP52 Series		
Hose - Upper		≈21794	Continental F124		
or		25472	Belt - Fan	607K410	TR26341
Hose - Lower		24224	Belt - Fan & Gen.		TR28437
IH U2A			Belt - Gen.	607K411	9260
Belt - Fan	251428R1	TR24315	Hose - Upper		≈21794
Belt - Gen.; W/21" Belt O.C.	351321R1	6821	or		25472
Belt - Gen.; W/28" Belt O.C.	6070G4018	9279	24224		
Hose - Upper		25473	IH U2A		
Hose - Lower		≈21794	Belt - Fan	251428R1	TR24315
or		25480	Belt - Gen.; W/21" Belt O.C.	351321R1	6821
G54C Series			Belt - Gen.; W/28" Belt O.C.	6070G4018	9279
Continental F162			Hose - Upper		25473
Belt - Fan	631938	♣9365HD	Hose - Lower		≈21794
Belt - Hyd. Pump	631940	♣9400HD	or		25480
G54C Series			GP060L; GP080L		
Continental F162			Ford 4-Cyl. 192; Ford 4-Cyl. 292 Diesel		
Belt - Fan	631938	♣9365HD	Belt - Fan & Alt.		♣9530HD
Belt - Hyd. Pump	631940	♣9400HD	Belt - W.P.		♣9313HD

②Two Required.
③Three Required.

♣Standard Belt Available.
≈Cut to Fit.

Lift & Industrial Trucks

Belts and Coolant Hose for Lift & Industrial Trucks

Application	Mfr. Part No.	Our No.	Application	Mfr. Part No.	Our No.
Yale - Continued			Yale - Continued		
GP100; GP150			KG51 Series 40; KG51 Series 50; KG51 Series 60; KG51 Series 70; KG51 Series 80; KG51 Series 100 - Continued		
Chrysler 6-Cyl. 225			Chrysler 6-Cyl. 215 Diesel		
Hose - Upper		25480	Hose - Upper		≈<20046
GPR52 Series; GR52 Series			Chrysler Ind. 30-273; Chrysler Ind. 30-275		
Continental F124			Belt - Fan & Gen. 607K43		
Belt - Fan	607K410	TR26341	Hose - Upper		≈<20046
Belt - Fan & Gen.		TR28437	KGA51 Series		
Belt - Gen.	607K411	9260	Chrysler Ind. 30; Chrysler Ind. 30-273		
Hose - Upper		≈<21794	Belt - Fan & Gen.; W/P.S.	570440	②7516
	or	25472	Belt - Fan & Gen.; W/O P.S.	607K43	TR24489
Hose - Lower		24224	Belt - P.S.	570165	7300
IH U2A			Belt - Hyd. Pump; W/P.S.	568119	②♣9400HD
Belt - Fan	251428R1	TR24315	Belt - Hyd. Pump; W/O P.S.	612006	②♣9425HD
Belt - Gen.; W/21" Belt O.C.	351321R1	6821	Hose - Upper		≈<20046
Belt - Gen.; W/28" Belt O.C.	6070G4018	9279		or	26501
Hose - Upper		25473	Hose - By Pass		≈<20568
Hose - Lower		≈<21794	KGP Series		
	or	25480	Chrysler Ind. 30; Chrysler Ind. 30-273		
GTC Series			Belt - Fan & Gen.; W/P.S.	570440	②7516
Continental F163			Belt - Fan & Gen.; W/O P.S.	607K43	TR24489
Belt - Fan & Alt.	065019900	②7480	Belt - P.S.	570165	7300
GTP50R			Belt - Hyd. Pump; W/P.S.	568119	②♣9400HD
Mazda 4-Cyl.			Belt - Hyd. Pump; W/O P.S.	612006	②♣9425HD
Belt - Fan, Gov. & Idler		♣9463HD	KGP51 Series		
Belt - W.P. & Alt.		♣9412HD	Chrysler Ind. 30; Chrysler Ind. 30-273		
Hose - Upper		25476	Hose - Upper		≈<20046
KG51 Series 10; KG51 Series 15				or	26501
IH U1			Hose - By Pass		≈<20568
Belt - Fan; W/Std. Fan	60712D	TR26353	KGPA51 Series		
Belt - Fan; W/High Speed Fan		TR28333	Chrysler Ind. 30; Chrysler Ind. 30-273		
Belt - Gen.; W/H.O. Eng.		2230	Belt - Fan & Gen.; W/P.S.	570440	②7516
Belt - Gen.; W/O H.O. Eng.	607K411	9260	Belt - Fan & Gen.; W/O P.S.	607K43	TR24489
IH U2A			Belt - P.S.	570165	7300
Belt - Fan	607K41	TR26341	Belt - Hyd. Pump; W/P.S.	568119	②♣9400HD
Belt - Gen.; W/26" Belt O.C.	607K411	9260	Belt - Hyd. Pump; W/O P.S.	612006	②♣9425HD
Belt - Gen.; W/28" Belt O.C.	6070G4018	9279	Hose - Upper		≈<20046
KG51 Series 20H				or	26501
IH U2A			Hose - By Pass		≈<20568
Hose - Upper		23562	L51 Series 30; L51 Series 40; L51 Series 50; L51 Series 60; L51 Series 70; L51 Series 80; L51 Series 100		
Hose - Lower		24232	Chrysler 6-Cyl. 215		
KG51 Series 30			Belt - Fan & Gen. 607K43		
Chrysler 6-Cyl. 215			Hose - Upper		
Belt - Fan & Gen.	607K43	TR24489	≈<20046		
Chrysler 6-Cyl. 215 Diesel			Chrysler 6-Cyl. 215 Diesel		
Hose - Upper		≈<20046	Hose - Upper		
Chrysler Ind. 30-273; Chrysler Ind. 30-275			≈<20046		
Belt - Fan & Gen.	607K43	TR24489	Chrysler Ind. 30-273; Chrysler Ind. 30-275		
Hose - Upper		≈<20046	Belt - Fan & Gen. 607K43		
KG51 Series 30X			Hose - Upper		
IH U2A			≈<20046		
Hose - Upper		23562	L52 Series		
Hose - Lower		24232	Continental F124		
KG51 Series 40; KG51 Series 50; KG51 Series 60; KG51 Series 70; KG51 Series 80; KG51 Series 100			Belt - Fan		
Chrysler 6-Cyl. 215			Belt - Fan & Gen.		
Belt - Fan & Gen.	607K43	TR24489	607K410		
			Belt - Fan & Gen.		
			607K411		
			Belt - Gen.		
			9260		
			IH U2A		
			Belt - Fan		
			251428R1		
			TR24315		

≈<Cut to Fit.
♣Standard Belt Available.

②Two Required.

Belts and Coolant Hose for Lift & Industrial Trucks

Application	Mfr. Part No.	Our No.
Yale - Continued		
L52 Series - Continued		
IH U2A - Continued		
Belt - Gen.; W/21" Belt O.C.	351321R1	6821
Belt - Gen.; W/28" Belt O.C.	6070G4018	9279
L83C; L83P		
Chrysler 6-Cyl. 225		
Hose - Upper		25476
Hose - Lower		25473
Zetor		
ND9031		
Zetor 4-Cyl.		
Belt - Fan & Alt.		TR22474

Lift & Industrial Trucks

Straight Hose Size List

Emission DEF Tank Fill, Heater & Coolant Hose Numbers

Emission Control Hose						
I.D./Length	6 ft.	25 ft.	50 ft.	100 ft.	250 ft.	300 ft.
Diesel Emissions Fluid Tank Fill Hose						
3/4	-	DEF750025	-	-	-	DEF750300
1	-	DEF100025	-	-	-	DEF100300

Heater Hose						
I.D./Length	6 ft.	25 ft.	50 ft.	100 ft.	250 ft.	300 ft.
Charter® Heater Hose						
1/2	-	-	28400	-	28403	-
5/8	-	-	28401	-	28404	-
3/4	-	-	28402	-	28405	-
Safety Stripe® Heater Hose						
1/4	-	-	28407	-	-	-
5/16	-	-	28408	-	-	-
3/8	28489	-	28409	-	-	-
1/2	28490	-	28410	-	-	-
5/8	28491	-	28411	-	28417	-
3/4	28492	-	28412	-	28418	-
1	-	28420	28413	-	-	-
Firewall® Heater Hose						
1/2	-	-	28430	-	-	-
5/8	-	-	28431	-	28433	-
3/4	-	-	28432	-	28434	-
Silicone Heater Hose						
3/8	-	26239	-	-	-	-
1/2	-	26240	-	-	-	-
5/8	-	26241	-	-	-	-
3/4	-	26242	-	-	-	-
1	-	26244	-	-	-	-
Green Stripe® Heater Hose						
1/2	-	-	28439	-	-	28440
5/8	-	-	28441	-	-	28447
3/4	-	-	28442	-	-	28448
7/8	-	-	28443	-	-	-
1	-	-	28444	-	-	28449
1 1/4	-	-	28445	-	-	-

Coolant Hose						
I.D./Length	3 ft.	I.D./Length	3 ft.	I.D./Length	3 ft.	3 ft.
500°F Severe Service Silicone Coolant Hose						
1	28225	2	28229	3	28233	-
1 1/4	28226	2 1/4	28230	-	-	-
1 1/2	28227	2 1/2	28231	-	-	-
1 3/4	28228	2 3/4	28232	-	-	-
FleetRunner® Hi-Temp Straight Radiator Hose						
7/8	24614	1 1/2	24624	2 1/4	24636	-
1	24616	1 5/8	24626	2 3/8	24638	-
1 1/8	24618	1 3/4	24628	2 1/2	24640	-
1 1/4	24620	1 7/8	24630	2 3/4	24644	-
1 3/8	24622	2	24632	3	24648	-

Straight Hose Size List

Coolant Hose						
I.D./Length	3 ft.	I.D./Length	3 ft.	I.D./Length	3 ft.	
Vulco® Straight Coolant Hose						
1/2	24008	1 5/8	24026	2 5/8	24042	-
3/4	24012	1 3/4	24028	2 3/4	24044	-
7/8	24014	1 7/8	24030	2 7/8	24046	-
1	24016	2	24032	3	24048	-
1 1/8	24018	2 1/8	24034	3 1/4	24052	-
1 1/4	24020	2 1/4	24036	3 1/2	24056	-
1 3/8	24022	2 3/8	24038	4	24064	-
1 1/2	24024	2 1/2	24040	-	-	-
Silicone Coolant Hose						
1/2	24808	1 1/2	24824	3	24848	-
5/8	24810	1 5/8	24826	3 1/8	24850	-
3/4	24812	1 3/4	24828	3 1/4	24852	-
7/8	24814	2	24832	3 1/2	24856	-
1	24816	2 1/4	24836	3 3/4	24860	-
1 1/8	24818	2 3/8	24838	4	24864	-
1 1/4	24820	2 1/2	24840	4 1/2	24872	-
1 3/8	24822	2 3/4	24844	-	-	-
Green Stripe® 2-Ply Straight Coolant Hose						
3/4	24212	1 7/8	24230	3	24248	-
7/8	24214	2	24232	3 1/8	24250	-
1	24216	2 1/8	24234	3 1/4	24252	-
1 1/8	24218	2 1/4	24236	3 1/2	24256	-
1 1/4	24220	2 3/8	24238	3 3/4	24260	-
1 3/8	24222	2 1/2	24240	4	24264	-
1 1/2	24224	2 5/8	24242	4 1/2	24272	-
1 5/8	24226	2 3/4	24244	-	-	-
1 3/4	24228	2 7/8	24246	-	-	-
Green Stripe® 4-Ply Straight Coolant Hose						
1 3/4	24428	2 1/2	24440	3 1/4	24452	-
1 7/8	24430	2 5/8	24442	3 1/2	24456	-
2	24432	2 3/4	24444	3 5/8	24458	-
2 1/8	24434	2 7/8	24446	3 3/4	24460	-
2 1/4	24436	3	24448	4	24464	-
2 3/8	24438	3 1/8	24450	5	24480	-
Green Stripe® Wire Inserted Coolant Hose						
I.D./Length	5	10	I.D./Length	5	10	
1	24916	28316	2 1/4	24936	28336	-
1 1/8	24918	-	2 3/8	24938	-	-
1 1/4	24920	28320	2 1/2	24940	28340	-
1 3/8	24922	-	2 5/8	24942	-	-
1 1/2	24924	28324	2 3/4	24944	28344	-
1 5/8	24926	28326	2 7/8	24946	-	-
1 3/4	24928	28328	3	24948	28348	-
1 7/8	24930	28330	3 1/2	24956	28356	-
2	24932	28332	4	24964	-	-
2 1/8	24934	-	5	24980	-	-
	-	-	6	24996	-	-

Showing Belt Numbers with Corresponding Nominal Outside Lengths and Top Widths

IMPORTANT: Lengths shown (O.C. is Outside Circumference) are obtained by measuring around the outside of the belt. These lengths will not agree exactly with the size significant belt numbering system which is based on the effective length of the belt. Effective length ("engineered" length) cannot be measured in the field because special tools are required.

Automotive Top Widths are the standard sizes defined by the automotive belt industry (SAE J636). Due to manufacturing processes that create "Vertical Flats", the top width of XL and Truck/Bus series V-Belts will not agree with the printed top width dimensions. Top width on this page and on the belt sleeve refers to the pulley groove width and not the actual top width of these belts. A picture of a V-Belt with "Vertical Flats" is shown below. Actual top width of like belt sizes will also vary slightly depending on the manufacturer and belt style.



Competitive V-Belt

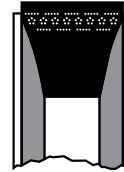

Our V-Belts with "Vertical Flats"

Belt No.	Length (in)	Length (mm)	Top Width (in)	Top Width (mm)	Belt No.	Length (in)	Length (mm)	Top Width (in)	Top Width (mm)
TR20412	41 5/8	1057	19/32	15	TR22664	67	1703	19/32	15
TR20426	43	1092	19/32	15	TR22676	68	1728	19/32	15
TR20451	45 1/2	1155	19/32	15	TR22692	69 3/4	1773	19/32	15
TR20544	54 3/4	1390	19/32	15	TR22711	71 5/8	1819	19/32	15
TR20619	62 3/8	1585	19/32	15	TR22720	72 5/8	1844	19/32	15
TR22299	30 1/2	774	19/32	15	TR22752	75 3/4	1924	19/32	15
TR22322	32 3/4	833	19/32	15	TR22770	77 5/8	1971	19/32	15
TR22329	33 1/2	850	19/32	15	TR22792	79 5/8	2021	19/32	15
TR22336	34 1/8	868	19/32	15	TR24281	28 5/8	728	21/32	17
TR22344	34 7/8	886	19/32	15	TR24308	31 1/2	799	21/32	17
TR22350	35 5/8	906	19/32	15	TR24315	32	812	21/32	17
TR22358	36 1/2	926	19/32	15	TR24355	36 1/8	918	21/32	17
TR22363	36 7/8	937	19/32	15	TR24365	37 1/8	943	21/32	17
TR22373	38	964	19/32	15	TR24379	38 1/2	978	21/32	17
TR22380	38 5/8	980	19/32	15	TR24400	40 5/8	1032	21/32	17
TR22386	39 1/8	993	19/32	15	TR24403	40 3/4	1036	21/32	17
TR22392	39 3/4	1010	19/32	15	TR24407	41 1/4	1047	3/4	19
TR22397	40 1/4	1022	19/32	15	TR24414	42	1067	21/32	17
TR22401	40 5/8	1031	19/32	15	TR24424	42 7/8	1090	21/32	17
TR22405	41 1/8	1045	19/32	15	TR24438	44 3/8	1126	21/32	17
TR22410	41 5/8	1056	19/32	15	TR24449	45 5/8	1158	21/32	17
TR22416	42 1/4	1073	19/32	15	TR24457	46 1/4	1174	21/32	17
TR22425	43 1/8	1095	19/32	15	TR24461	46 5/8	1183	3/4	19
TR22434	44	1117	19/32	15	TR24465	47	1195	21/32	17
TR22443	44 7/8	1139	19/32	15	TR24476	48 1/4	1225	21/32	17
TR22448	45 3/8	1151	19/32	15	TR24489	49 3/8	1255	21/32	17
TR22455	46 1/8	1171	19/32	15	TR24500	50 5/8	1285	21/32	17
TR22461	46 5/8	1185	19/32	15	TR24515	52	1320	21/32	17
TR22474	47 7/8	1218	19/32	15	TR24530	53 5/8	1362	21/32	17
TR22485	49 1/8	1247	19/32	15	TR24538	54 3/8	1380	21/32	17
TR22495	50 1/8	1273	19/32	15	TR24562	56 5/8	1438	21/32	17
TR22508	51 3/8	1306	19/32	15	TR24578	58 1/4	1480	21/32	17
TR22514	52	1320	19/32	15	TR24597	60 1/4	1530	21/32	17
TR22517	52 1/2	1334	19/32	15	TR24607	61 3/8	1560	21/32	17
TR22525	53 1/8	1349	19/32	15	TR24619	62 1/2	1589	21/32	17
TR22534	53 7/8	1369	19/32	15	TR24638	64 1/4	1631	21/32	17
TR22545	55 1/8	1399	19/32	15	TR24647	65 1/4	1658	21/32	17
TR22553	55 7/8	1420	19/32	15	TR24664	67	1702	21/32	17
TR22570	57 5/8	1462	19/32	15	TR24688	69 1/4	1759	21/32	17
TR22578	58 1/4	1479	19/32	15	TR24709	71 1/4	1810	21/32	17
TR22588	59 3/8	1509	19/32	15	TR26341	34 5/8	879	23/32	18
TR22607	61 1/4	1556	19/32	15	TR26353	36	913	23/32	18
TR22625	63 1/8	1602	19/32	15	TR26366	37 1/8	945	25/32	20
TR22635	64 1/8	1627	19/32	15	TR28333	33 7/8	859	25/32	20
TR22648	65 1/4	1658	19/32	15	TR28346	35 1/8	892	25/32	20
TR22657	66 1/4	1682	19/32	15	TR28376	38 1/4	971	25/32	20

All Green Stripe® Truck and Bus V-Belts are Notched.

Green Stripe® Truck and Bus V-Belts - Listed by Number

Belt No.	Length (in)	Length (mm)	Top Width (in)	Top Width (mm)	Belt No.	Length (in)	Length (mm)	Top Width (in)	Top Width (mm)
TR28386	39 1/4	996	25/32	20	TR28706	71 1/8	1807	25/32	20
TR28390	39 5/8	1007	25/32	20	TR28733	73 7/8	1875	25/32	20
TR28400	40 5/8	1032	25/32	20	TR28743	75	1905	25/32	20
TR28406	41 1/8	1046	25/32	20	TR28786	79 1/8	2009	25/32	20
TR28412	41 7/8	1062	25/32	20	TR30408	41 1/2	1054	7/8	22
TR28423	42 7/8	1088	25/32	20	TR30428	43 1/2	1104	7/8	22
TR28429	43 1/2	1105	25/32	20	TR30448	45 3/8	1152	7/8	22
TR28437	44 1/4	1125	25/32	20	TR30467	47 1/4	1201	7/8	22
TR28445	45 1/8	1145	25/32	20	TR30484	49	1244	7/8	22
TR28454	45 7/8	1166	25/32	20	TR30506	51 1/8	1299	7/8	22
TR28463	46 7/8	1190	25/32	20	TR30537	54 1/8	1375	7/8	22
TR28473	47 7/8	1216	25/32	20	TR30543	54 7/8	1393	7/8	22
TR28480	48 5/8	1235	25/32	20	TR30589	59 1/2	1510	7/8	22
TR28483	48 7/8	1240	25/32	20	TR30624	62 7/8	1599	7/8	22
TR28492	49 7/8	1267	25/32	20	TR30652	65 3/4	1671	7/8	22
TR28498	50 1/4	1277	25/32	20	TR30672	67 3/4	1721	7/8	22
TR28501	50 7/8	1291	25/32	20	TR30698	70 3/8	1788	7/8	22
TR28510	51 5/8	1311	25/32	20	TR30710	71 5/8	1818	7/8	22
TR28514	52	1320	25/32	20	TR30722	72 3/4	1849	7/8	22
TR28522	52 7/8	1342	25/32	20	TR30754	75 3/4	1925	7/8	22
TR28545	55 1/8	1401	25/32	20	TR30770	77	1955	7/8	22
TR28550	55 5/8	1413	25/32	20	TR30808	81 1/4	2065	7/8	22
TR28557	56 1/4	1430	25/32	20	TR32491	49 3/4	1265	29/32	23
TR28565	57 1/8	1451	25/32	20	TR32513	51 7/8	1317	29/32	23
TR28570	57 5/8	1464	25/32	20	TR32571	57 5/8	1465	29/32	23
TR28575	58 1/8	1477	25/32	20	TR34435	43 7/8	1115	1	25
TR28583	58 7/8	1495	25/32	20	TR34456	46 1/8	1172	1	25
TR28596	60 1/4	1530	25/32	20	TR34467	47 1/4	1199	1	25
TR28616	62 1/4	1580	25/32	20	TR34495	49 7/8	1265	1	25
TR28628	63 3/8	1609	25/32	20	TR34506	51 1/8	1300	1	25
TR28649	65 1/2	1663	25/32	20	TR34545	55	1395	1	25
TR28657	66 1/4	1684	25/32	20	TR34604	61 1/8	1553	1	25
TR28666	67 1/4	1710	25/32	20	TR34700	70 5/8	1793	1	25
TR28680	68 5/8	1744	25/32	20	TR34711	71 5/8	1820	1	25
TR28693	69 7/8	1775	25/32	20	TR34771	77 3/4	1975	1	25

All Green Stripe® Truck and Bus V-Belts are Notched.

Showing Nominal Belt Top Widths and Outside Lengths with Our Corresponding Belt Numbers

IMPORTANT: Lengths shown (O.C. is Outside Circumference) are obtained by measuring around the outside of the belt. These lengths will not agree exactly with the size significant belt numbering system which is based on the effective length of the belt. Effective length ("engineered" length) cannot be measured in the field because special tools are required.

Automotive Top Widths are the standard sizes defined by the automotive belt industry (SAE J636). Due to manufacturing processes that create "Vertical Flats", the top width of XL and Truck/Bus series V-Belts will not agree with the printed top width dimensions. Top width on this page and on the belt sleeve refers to the pulley groove width and not the actual top width of these belts. A picture of a V-Belt with "Vertical Flats" is shown below. Actual top width of like belt sizes will also vary slightly depending on the manufacturer and belt style.



Competitive V-Belt

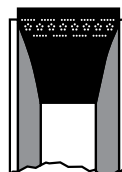

Our V-Belts with "Vertical Flats"

Length (in)	Length (mm)	Belt No.	Length (in)	Length (mm)	Belt No.	Length (in)	Length (mm)	Belt No.
19/32" (15mm) Top Width			19/32" (15mm) Top Width			3/4" (19mm) Top Width		
30 1/2	774	TR22299	- Continued			41 1/4	1047	TR24407
32 3/4	833	TR22322	69 3/4	1773	TR22692	46 5/8	1183	TR24461
33 1/2	850	TR22329	71 5/8	1819	TR22711	25/32" (20mm) Top Width		
34 1/8	868	TR22336	72 5/8	1844	TR22720	33 7/8	859	TR28333
34 7/8	886	TR22344	75 3/4	1924	TR22752	35 1/8	892	TR28346
35 5/8	906	TR22350	77 5/8	1971	TR22770	37 1/8	945	TR26366
36 1/2	926	TR22358	79 5/8	2021	TR22792	38 1/4	971	TR28376
36 7/8	937	TR22363	21/32" (17mm) Top Width			39 1/4	996	TR28386
38	964	TR22373	28 5/8	728	TR24281	39 5/8	1007	TR28390
38 5/8	980	TR22380	31 1/2	799	TR24308	40 5/8	1032	TR28400
39 1/8	993	TR22386	32	812	TR24315	41 1/8	1046	TR28406
39 3/4	1010	TR22392	36 1/8	918	TR24355	41 7/8	1062	TR28412
40 1/4	1022	TR22397	37 1/8	943	TR24365	42 7/8	1088	TR28423
40 5/8	1031	TR22401	38 1/2	978	TR24379	43 1/2	1105	TR28429
41 1/8	1045	TR22405	40 5/8	1032	TR24400	44 1/4	1125	TR28437
41 5/8	1056	TR22410	40 3/4	1036	TR24403	45 1/8	1145	TR28445
41 5/8	1057	TR20412	42	1067	TR24414	45 7/8	1166	TR28454
42 1/4	1073	TR22416	42 7/8	1090	TR24424	46 7/8	1190	TR28463
43	1092	TR20426	44 3/8	1126	TR24438	47 7/8	1216	TR28473
43 1/8	1095	TR22425	45 5/8	1158	TR24449	48 5/8	1235	TR28480
44	1117	TR22434	46 1/4	1174	TR24457	48 7/8	1240	TR28483
44 7/8	1139	TR22443	47	1195	TR24465	49 7/8	1267	TR28492
45 3/8	1151	TR22448	48 1/4	1225	TR24476	50 1/4	1277	TR28498
45 1/2	1155	TR20451	49 3/8	1255	TR24489	50 7/8	1291	TR28501
46 1/8	1171	TR22455	50 5/8	1285	TR24500	51 5/8	1311	TR28510
46 5/8	1185	TR22461	52	1320	TR24515	52	1320	TR28514
47 7/8	1218	TR22474	53 5/8	1362	TR24530	52 7/8	1342	TR28522
49 1/8	1247	TR22485	54 3/8	1380	TR24538	55 1/8	1401	TR28545
50 1/8	1273	TR22495	56 5/8	1438	TR24562	55 5/8	1413	TR28550
51 3/8	1306	TR22508	58 1/4	1480	TR24578	56 1/4	1430	TR28557
52	1320	TR22514	60 1/4	1530	TR24597	57 1/8	1451	TR28565
52 1/2	1334	TR22517	61 3/8	1560	TR24607	57 5/8	1464	TR28570
53 1/8	1349	TR22525	62 1/2	1589	TR24619	58 1/8	1477	TR28575
53 7/8	1369	TR22534	64 1/4	1631	TR24638	58 7/8	1495	TR28583
54 3/4	1390	TR20544	65 1/4	1658	TR24647	60 1/4	1530	TR28596
55 1/8	1399	TR22545	67	1702	TR24664	62 1/4	1580	TR28616
55 7/8	1420	TR22553	69 1/4	1759	TR24688	63 3/8	1609	TR28628
57 5/8	1462	TR22570	71 1/4	1810	TR24709	65 1/2	1663	TR28649
58 1/4	1479	TR22578	23/32" (18mm) Top Width			66 1/4	1684	TR28657
59 3/8	1509	TR22588	34 5/8	879	TR26341	67 1/4	1710	TR28666
61 1/4	1556	TR22607	36	913	TR26353	68 5/8	1744	TR28680
62 3/8	1585	TR20619				69 7/8	1775	TR28693
63 1/8	1602	TR22625				71 1/8	1807	TR28706
64 1/8	1627	TR22635				73 7/8	1875	TR28733
65 1/4	1658	TR22648				75	1905	TR28743
66 1/4	1682	TR22657				79 1/8	2009	TR28786
67	1703	TR22664						
68	1728	TR22676						

All Green Stripe® Truck and Bus V-Belts are Notched.

Showing Belt Numbers with Corresponding Nominal Outside Lengths & Top Widths Per Strand

IMPORTANT: Lengths shown (O.C. is Outside Circumference) are obtained by measuring around the outside of the belt. These lengths will not agree exactly with the size significant belt numbering system which is based on the effective length of the belt. Effective length ("engineered" length) cannot be measured in the field because special tools are required.

Automotive Top Widths are the standard sizes defined by the automotive belt industry (SAE J636). Due to manufacturing processes that create "Vertical Flats", the top width of XL and Truck/Bus series V-Belts will not agree with the printed top width dimensions. Top width on this page and on the belt sleeve refers to the pulley groove width and not the actual top width of these belts. A picture of a V-Belt with "Vertical Flats" is shown below. Actual top width of like belt sizes will also vary slightly depending on the manufacturer and belt style.

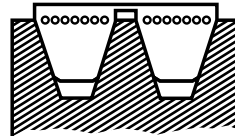

Belt No.	Length (in)	Length (mm)	Top Width Per Strand (in)	Top Width Per Strand (mm)	Template Color	Belt No.	Length (in)	Length (mm)	Top Width Per Strand (in)	Top Width Per Strand (mm)	Template Color
2/9305PB.....	31 1/2	799	1/2	13	Yellow	2/9650PB.....	65 7/8	1673	1/2	13	Yellow
2/9313PB.....	32 1/8	817	1/2	13	Yellow	2/9660PB.....	66 7/8	1698	1/2	13	Yellow
2/9325PB.....	33 1/2	852	1/2	13	Yellow	2/9670PB.....	67 3/8	1710	1/2	13	Yellow
2/9430PB.....	43 7/8	1116	1/2	13	Yellow	2/9690PB.....	70	1778	1/2	13	Yellow
2/9435PB.....	44 3/8	1128	1/2	13	Yellow	2/9700PB.....	70 7/8	1800	1/2	13	Yellow
2/9447PB.....	45 3/8	1154	1/2	13	Yellow	2/9710PB.....	71 7/8	1825	1/2	13	Yellow
2/9451PB.....	45 7/8	1164	1/2	13	Yellow	2/9720PB.....	72 7/8	1850	1/2	13	Yellow
2/9463PB.....	47	1195	1/2	13	Yellow	2/9730PB.....	74	1879	1/2	13	Yellow
2/9470PB.....	47 7/8	1217	1/2	13	Yellow	2/TR22517PB.....	52 1/2	1330	11/16	13	Green
2/9476PB.....	48 3/8	1230	1/2	13	Yellow	2/TR22553PB.....	56 1/4	1430	11/16	13	Green
2/9485FPB.....	49 5/8	1259	1/2	13	Pink	2/TR22570PB.....	58	1472	11/16	13	Green
2/9490PB.....	50	1270	1/2	13	Yellow	2/TR28400PB.....	41	1041	7/8	22	Red
2/9500PB.....	50 3/4	1290	1/2	13	Yellow	2/TR28411PB.....	41 3/4	1061	7/8	22	Red
2/9510PB.....	52	1321	1/2	13	Yellow	2/TR28429PB.....	44 1/8	1120	7/8	22	Red
2/9520PB.....	53	1346	1/2	13	Yellow	2/TR28437PB.....	44 1/4	1125	7/8	22	Red
2/9530PB.....	54	1373	1/2	13	Yellow	2/TR28466PB.....	47 1/8	1198	7/8	22	Red
2/9540PB.....	54 3/4	1390	1/2	13	Yellow	2/TR28473PB.....	48 1/4	1226	7/8	22	Red
2/9545PB.....	55 3/8	1405	1/2	13	Yellow	2/TR28480PB.....	49	1244	7/8	22	Red
2/9550PB.....	56	1424	1/2	13	Yellow	2/TR28483PB.....	49 1/8	1248	7/8	22	Red
2/9555PB.....	56 1/2	1435	1/2	13	Yellow	2/TR28492PB.....	50 3/8	1279	7/8	22	Red
2/9570PB.....	58	1474	1/2	13	Yellow	2/TR28501PB.....	51 1/8	1299	7/8	22	Red
2/9580PB.....	58	1473	1/2	13	Yellow	2/TR28510PB.....	51 5/8	1310	7/8	22	Red
2/9590PB.....	59 7/8	1521	1/2	13	Yellow	3/9470PB.....	47 7/8	1217	1/2	13	N/A
2/9600PB.....	60 5/8	1540	1/2	13	Yellow	3/9500PB.....	50 5/8	1286	1/2	13	N/A
2/9610PB.....	61 7/8	1571	1/2	13	Yellow	3/9525PB.....	53 1/4	1354	1/2	13	N/A
2/9640PB.....	64 3/8	1635	1/2	13	Yellow	3/9530PB.....	54	1372	1/2	13	N/A

Showing Nominal Belt Top Widths Per Strand & Outside Lengths with Our Corresponding Belt Numbers

IMPORTANT: Lengths shown (O.C. is Outside Circumference) are obtained by measuring around the outside of the belt. These lengths will not agree exactly with the size significant belt numbering system which is based on the effective length of the belt. Effective length ("engineered" length) cannot be measured in the field because special tools are required.

Automotive Top Widths are the standard sizes defined by the automotive belt industry (SAE J636). Due to manufacturing processes that create "Vertical Flats", the top width of XL and Truck/Bus series V-Belts will not agree with the printed top width dimensions. Top width on this page and on the belt sleeve refers to the pulley groove width and not the actual top width of these belts. A picture of a V-Belt with "Vertical Flats" is shown below. Actual top width of like belt sizes will also vary slightly depending on the manufacturer and belt style.

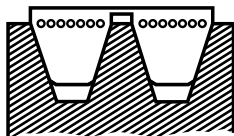

Length (in)	Length (mm)	Template Color	Belt No.	Length (in)	Length (mm)	Template Color	Belt No.	Length (in)	Length (mm)	Template Color	Belt No.
1/2" (13mm) Top Width Per Strand				1/2" (13mm) Top Width Per Strand				11/16" (17mm) Top Width Per Strand			
31 1/2	799	Yellow	2/9325PB	- Continued				52 1/2	1330	Green	2/TR22517PB
32 1/8	817	Yellow	2/9325PB	54 3/4	1390	Yellow	2/9325PB	56 1/4	1430	Green	2/TR22553PB
33 1/2	852	Yellow	2/9325PB	55 3/8	1405	Yellow	2/9325PB	58	1472	Green	2/TR22570PB
43 7/8	1116	Yellow	2/9325PB	56	1424	Yellow	2/9325PB	7/8" (22mm) Top Width Per Strand			
44 3/8	1128	Yellow	2/9325PB	56 1/2	1435	Yellow	2/9325PB	41	1041	Red	2/TR28400PB
45 3/8	1154	Yellow	2/9325PB	58	1474	Yellow	2/9325PB	41 3/4	1061	Red	2/TR28411PB
45 7/8	1164	Yellow	2/9325PB	58	1473	Yellow	2/9325PB	44 1/8	1120	Red	2/TR28429PB
47	1195	Yellow	2/9325PB	59 7/8	1521	Yellow	2/9325PB	44 1/4	1125	Red	2/TR28437PB
47 7/8	1217	Yellow	2/9325PB	60 5/8	1540	Yellow	2/9325PB	47 1/8	1198	Red	2/TR28466PB
47 7/8	1217	N/A	3/9470PB	61 7/8	1571	Yellow	2/9325PB	48 1/4	1226	Red	2/TR28473PB
48 3/8	1230	Yellow	2/9325PB	64 3/8	1635	Yellow	2/9325PB	49	1244	Red	2/TR28480PB
49 5/8	1259	Pink	2/9325PB	65 7/8	1673	Yellow	2/9325PB	49 1/8	1248	Red	2/TR28483PB
50	1270	Yellow	2/9325PB	66 7/8	1698	Yellow	2/9325PB	50 3/8	1279	Red	2/TR28492PB
50 5/8	1286	N/A	3/9500PB	67 3/8	1710	Yellow	2/9325PB	51 1/8	1299	Red	2/TR28501PB
50 3/4	1290	Yellow	2/9325PB	70	1778	Yellow	2/9325PB	51 5/8	1310	Red	2/TR28510PB
52	1321	Yellow	2/9325PB	70 7/8	1800	Yellow	2/9325PB				
53	1346	Yellow	2/9325PB	71 7/8	1825	Yellow	2/9325PB				
53 1/4	1354	N/A	3/9525PB	72 7/8	1850	Yellow	2/9325PB				
54	1373	Yellow	2/9325PB	74	1879	Yellow	2/9325PB				
54	1372	N/A	3/9530PB								

Showing Belt Numbers with Corresponding Nominal Outside Lengths and Top Widths

Belt No.	Length (in)	Length (mm)	Top Width (in)	Top Width (mm)	Belt No.	Length (in)	Length (mm)	Top Width (in)	Top Width (mm)
9290HD	29 3/8	746	1/2	13	9490HD	49 3/8	1254	1/2	13
9305HD	30 7/8	784	1/2	13	9495HD	49 29/32	1268	1/2	13
9309HD	31 1/3	795	1/2	13	9500HD	50 7/16	1281	1/2	13
9313HD	31 7/8	810	1/2	13	9505HD	50 7/8	1292	1/2	13
9319HD	32 5/8	830	1/2	13	9510HD	51 3/8	1305	1/2	13
9325HD	32 7/8	835	1/2	13	9520HD	52 7/16	1332	1/2	13
9330HD	33 3/8	848	1/2	13	9525HD	52 7/8	1343	1/2	13
9335HD	33 29/32	862	1/2	13	9530HD	53 7/16	1357	1/2	13
9341HD	34 3/8	873	1/2	13	9540HD	54 3/8	1382	1/2	13
9345HD	34 7/8	886	1/2	13	9545HD	54 27/32	1393	1/2	13
9350HD	35 15/32	901	1/2	13	9550HD	55 13/32	1408	1/2	13
9355HD	35 31/32	914	1/2	13	9555HD	55 27/32	1418	1/2	13
9360HD	36 3/8	924	1/2	13	9560HD	56 13/32	1433	1/2	13
9365HD	36 7/8	936	1/2	13	9565HD	56 27/32	1443	1/2	13
9370HD	37 3/8	950	1/2	13	9570HD	57 13/32	1458	1/2	13
9375HD	37 15/16	963	1/2	13	9580HD	58 3/8	1483	1/2	13
9380HD	38 3/8	975	1/2	13	9585HD	58 7/8	1496	1/2	13
9385HD	38 29/32	989	1/2	13	9590HD	59 13/32	1509	1/2	13
9390HD	39 3/8	1000	1/2	13	9600HD	60 13/32	1534	1/2	13
9395HD	39 29/32	1013	1/2	13	9605HD	60 31/32	1549	1/2	13
9400HD	40 3/8	1026	1/2	13	9610HD	61 7/16	1561	1/2	13
9403HD	40 5/8	1032	1/2	13	9620HD	62 3/8	1584	1/2	13
9405HD	40 27/32	1038	1/2	13	9625HD	62 7/8	1597	1/2	13
9412HD	41 3/8	1051	1/2	13	9630HD	63 13/32	1610	1/2	13
9415HD	41 29/32	1065	1/2	13	9635HD	63 29/32	1623	1/2	13
9420HD	42 11/32	1075	1/2	13	9640HD	64 3/8	1635	1/2	13
9425HD	42 27/32	1088	1/2	13	9650HD	65 3/8	1661	1/2	13
9430HD	43 7/16	1103	1/2	13	9660HD	66 3/8	1686	1/2	13
9435HD	43 7/8	1115	1/2	13	9670HD	67 3/8	1712	1/2	13
9440HD	44 3/8	1127	1/2	13	9680HD	68 3/8	1737	1/2	13
9447HD	44 27/32	1139	1/2	13	9690HD	69 3/8	1762	1/2	13
9451HD	45 7/16	1154	1/2	13	9700HD	70 3/8	1788	1/2	13
9455HD	45 27/32	1165	1/2	13	9710HD	71 3/8	1813	1/2	13
9463HD	46 3/8	1178	1/2	13	9720HD	72 3/8	1838	1/2	13
9465HD	46 27/32	1190	1/2	13	9730HD	73 11/32	1863	1/2	13
9470HD	47 3/8	1203	1/2	13	9740HD	74 7/8	1901	1/2	13
9476HD	47 15/16	1218	1/2	13	9745HD	74 7/8	1900	1/2	13
9480HD	48 15/32	1231	1/2	13	9755HD	75 15/16	1929	1/2	13
9485HD	48 27/32	1240	1/2	13					

All FleetRunner® Heavy-Duty V-Belts are Notched.

Showing Nominal Belt Top Widths and Outside Lengths
with Our Corresponding Belt Numbers

Length (in)	Length (mm)	Belt No.	Length (in)	Length (mm)	Belt No.	Length (in)	Length (mm)	Belt No.
1/2" (13mm) Top Width			1/2" (13mm) Top Width			1/2" (13mm) Top Width		
29 3/8	746	9290HD	- Continued			- Continued		
30 7/8	784	9305HD	43 7/16	1103	9430HD	56 27/32	1443	9565HD
31 5/16	795	9309HD	43 7/8	1115	9435HD	57 13/32	1458	9570HD
31 7/8	810	9313HD	44 3/8	1127	9440HD	58 3/8	1483	9580HD
32 5/8	830	9319HD	44 27/32	1139	9447HD	58 7/8	1496	9585HD
32 7/8	835	9325HD	45 7/16	1154	9451HD	59 13/32	1509	9590HD
33 3/8	848	9330HD	45 27/32	1165	9455HD	60 13/32	1534	9600HD
33 29/32	862	9335HD	46 3/8	1178	9463HD	60 31/32	1549	9605HD
34 3/8	873	9341HD	46 27/32	1190	9465HD	61 7/16	1561	9610HD
34 7/8	886	9345HD	47 3/8	1203	9470HD	62 3/8	1584	9620HD
35 15/32	901	9350HD	47 15/16	1218	9476HD	62 7/8	1597	9625HD
35 31/32	914	9355HD	48 15/32	1231	9480HD	63 13/32	1610	9630HD
36 3/8	924	9360HD	48 27/32	1240	9485HD	63 29/32	1623	9635HD
36 7/8	936	9365HD	49 3/8	1254	9490HD	64 3/8	1635	9640HD
37 3/8	950	9370HD	49 29/32	1268	9495HD	65 3/8	1661	9650HD
37 15/16	963	9375HD	50 7/16	1281	9500HD	66 3/8	1686	9660HD
38 3/8	975	9380HD	50 7/8	1292	9505HD	67 3/8	1712	9670HD
38 29/32	989	9385HD	51 3/8	1305	9510HD	68 3/8	1737	9680HD
39 3/8	1000	9390HD	52 7/16	1332	9520HD	69 3/8	1762	9690HD
39 29/32	1013	9395HD	52 7/8	1343	9525HD	70 3/8	1788	9700HD
40 3/8	1026	9400HD	53 7/16	1357	9530HD	71 3/8	1813	9710HD
40 5/8	1032	9403HD	54 3/8	1382	9540HD	72 3/8	1838	9720HD
40 27/32	1038	9405HD	54 27/32	1393	9545HD	73 11/32	1863	9730HD
41 3/8	1051	9412HD	55 13/32	1408	9550HD	74 7/8	1901	9740HD
41 29/32	1065	9415HD	55 27/32	1418	9555HD	74 7/8	1900	9745HD
42 11/32	1075	9420HD	56 13/32	1433	9560HD	75 15/16	1929	9755HD
42 27/32	1088	9425HD						

All FleetRunner® Heavy-Duty V-Belts are Notched.

Showing Belt Numbers with Corresponding Nominal Outside Lengths and Top Widths

IMPORTANT: Lengths shown (O.C. is Outside Circumference) are obtained by measuring around the outside of the belt. These lengths will not agree exactly with the size significant belt numbering system which is based on the effective length of the belt. Effective length ("engineered" length) cannot be measured in the field because special tools are required.

Automotive Top Widths are the standard sizes defined by the automotive belt industry (SAE J636). Due to manufacturing processes that create "Vertical Flats", the top width of XL and Truck/Bus series V-Belts will not agree with the printed top width dimensions. Top width on this page and on the belt sleeve refers to the pulley groove width and not the actual top width of these belts. A picture of a V-Belt with "Vertical Flats" is shown below. Actual top width of like belt sizes will also vary slightly depending on the manufacturer and belt style.

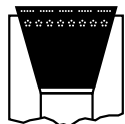

Competitive V-Belt

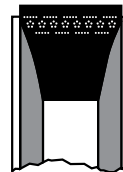

Our V-Belts with "Vertical Flats"

Belt No.	Section	Length (in)	Length (mm)	Top Width (in)	Top Width (mm)	Belt No.	Section	Length (in)	Length (mm)	Top Width (in)	Top Width (mm)
7208	▼ HC41	21 1/4	540	13/32	10	7374	HC31	37 3/4	960	5/16	8
7215	▼ HC41	22 1/8	561	13/32	10	7375	▼ HC41	38 1/8	967	13/32	10
7228	HC31	23	585	5/16	8	7379	HC31	38 1/4	970	5/16	8
7234	HC31	23 7/8	605	5/16	8	7380	▼ HC41	38 5/8	980	13/32	10
7240	▼ HC41	24 5/8	624	13/32	10	7381	HC25	38 1/4	970	1/4	6
7250	▼ HC41	25 5/8	650	13/32	10	7384	HC31	38 3/4	985	5/16	8
7255	▼ HC41	26 1/8	663	13/32	10	7385	▼ HC41	39 1/8	993	13/32	10
7260	▼ HC41	26 5/8	675	13/32	10	7388	HC25	39 1/4	995	1/4	6
7261	HC25	26 1/4	665	1/4	6	7389	HC31	39 1/4	995	5/16	8
7265	▼ HC41	27 1/8	688	13/32	10	7390	▼ HC41	39 5/8	1005	13/32	10
7270	▼ HC41	27 5/8	701	13/32	10	7395	▼ HC41	40 1/8	1018	13/32	10
7274	HC31	27 3/8	690	5/16	8	7400	▼ HC41	40 5/8	1031	13/32	10
7279	HC25	28 3/8	720	1/4	6	7404	HC31	40 3/4	1035	5/16	8
7280	▼ HC41	28 5/8	726	13/32	10	7405	▼ HC41	41 1/8	1044	13/32	10
7290	▼ HC41	29 5/8	751	13/32	10	7409	HC25	41 1/4	1050	1/4	6
7292	▼ HC41	29 7/8	758	13/32	10	7410	▼ HC41	41 5/8	1056	13/32	10
7295	▼ HC41	30 1/8	764	13/32	10	7417	▼ HC41	42 1/8	1069	13/32	10
7298	HC25	30 1/4	770	1/4	6	7419	HC31	42 1/4	1075	5/16	8
7300	▼ HC41	30 5/8	777	13/32	10	7420	▼ HC41	42 5/8	1082	13/32	10
7304	HC31	30 3/4	780	5/16	8	7425	▼ HC41	43 1/8	1095	13/32	10
7305	▼ HC41	31 1/8	792	13/32	10	7430	▼ HC41	43 5/8	1107	13/32	10
7309	HC25	31 1/4	795	1/4	6	7435	▼ HC41	44 1/8	1120	13/32	10
7312	▼ HC41	31 5/8	802	13/32	10	7440	▼ HC41	44 5/8	1132	13/32	10
7315	▼ HC41	32 1/8	815	13/32	10	7444	HC31	44 3/4	1135	5/16	8
7318	HC25	32 1/4	820	1/4	6	7445	▼ HC41	45 1/8	1145	13/32	10
7320	▼ HC41	32 5/8	828	13/32	10	7447M	⊗ HC38 Modified	45 1/4	1149	13/32	10
7324	HC31	32 5/8	830	5/16	8	7448	▼ HC41	45 3/8	1151	13/32	10
7325	▼ HC41	33 1/8	840	13/32	10	7449	HC31	45 1/4	1150	5/16	8
7328	▼ HC41	33 3/8	847	13/32	10	7450	▼ HC41	45 5/8	1158	13/32	10
7329	HC25	33 1/4	845	1/4	6	7453	▼ HC41	45 7/8	1164	13/32	10
7330	▼ HC41	33 5/8	853	13/32	10	7455	▼ HC41	46 1/8	1171	13/32	10
7333	HC25	34 1/4	870	1/4	6	7459	HC31	46 1/4	1175	5/16	8
7334	HC31	33 3/4	855	5/16	8	7460	▼ HC41	46 5/8	1183	13/32	10
7335	▼ HC41	34 1/8	866	13/32	10	7465	▼ HC41	47 1/8	1196	13/32	10
7340	▼ HC41	34 5/8	878	13/32	10	7470	▼ HC41	47 5/8	1209	13/32	10
7343	HC31	34 1/4	870	5/16	8	7473	▼ HC41	47 7/8	1215	13/32	10
7345	▼ HC41	35 1/8	891	13/32	10	7475	▼ HC41	48 1/8	1221	13/32	10
7348	HC25	35 1/4	895	1/4	6	7480	▼ HC41	48 5/8	1234	13/32	10
7350	▼ HC41	35 5/8	904	13/32	10	7483	▼ HC41	48 7/8	1242	13/32	10
7355	▼ HC41	36 1/8	919	13/32	10	7485	▼ HC41	49 1/8	1247	13/32	10
7359	HC25	36 1/4	920	1/4	6	7490	▼ HC41	49 5/8	1260	13/32	10
7360	▼ HC41	36 5/8	929	13/32	10	7495	▼ HC41	50 1/8	1272	13/32	10
7362	HC31	36 3/8	925	5/16	8	7496	HC31	49 5/8	1265	5/16	8
7363	HC25	36 3/4	935	1/4	6	7500	▼ HC41	50 5/8	1285	13/32	10
7365	▼ HC41	37 1/8	942	13/32	10	7508	▼ HC41	51 1/8	1297	13/32	10
7369	HC31	37 1/4	945	5/16	8	7512	▼ HC41	51 5/8	1310	13/32	10
7370	▼ HC41	37 5/8	954	13/32	10	7516	▼ HC41	52 1/8	1323	13/32	10

▼ Indicates Notched Belt. ⊗ Set of 2 Belts.

XL® Belts - Listed by Number

Belt No.	Section	Length (in)	Length (mm)	Top Width (in)	Top Width (mm)	Belt No.	Section	Length (in)	Length (mm)	Top Width (in)	Top Width (mm)
7520.....	▼ HC41	52 5/8	1336	13/32	10	9405.....	▼ HC50	40 7/8	1038	15/32	12
7525.....	▼ HC41	53 1/8	1348	13/32	10	9412.....	▼ HC50	41 3/8	1051	15/32	12
7530.....	▼ HC41	53 5/8	1361	13/32	10	9415.....	▼ HC50	41 7/8	1064	15/32	12
7535.....	▼ HC41	54 1/8	1374	13/32	10	9420.....	▼ HC50	42 3/8	1076	15/32	12
7541.....	▼ HC41	54 5/8	1386	13/32	10	9425.....	▼ HC50	42 7/8	1089	15/32	12
7545.....	▼ HC41	55 1/8	1399	13/32	10	9430.....	▼ HC50	43 3/8	1102	15/32	12
7550.....	▼ HC41	55 5/8	1412	13/32	10	9435.....	▼ HC50	43 7/8	1114	15/32	12
7555.....	▼ HC41	56 1/8	1425	13/32	10	9440.....	▼ HC50	44 3/8	1127	15/32	12
7560.....	▼ HC41	56 5/8	1437	13/32	10	9447.....	▼ HC50	44 7/8	1140	15/32	12
7565.....	▼ HC41	57 1/8	1450	13/32	10	9451.....	▼ HC50	45 3/8	1153	15/32	12
7570.....	▼ HC41	57 5/8	1464	13/32	10	9452M.....	▼ HC50 Modified	45 5/8	1158	17/32	13
7575.....	▼ HC41	58 1/8	1476	13/32	10	9453M.....	▼ HC50 Modified	45 3/4	1161	17/32	13
7580.....	▼ HC41	58 5/8	1488	13/32	10	9455.....	▼ HC50	45 7/8	1165	15/32	12
7585.....	▼ HC41	59 1/8	1501	13/32	10	9463.....	▼ HC50	46 3/8	1178	15/32	12
7590.....	▼ HC41	59 5/8	1513	13/32	10	9465.....	▼ HC50	46 7/8	1191	15/32	12
7597.....	▼ HC41	60 1/8	1526	13/32	10	9470.....	▼ HC50	47 3/8	1203	15/32	12
7603.....	▼ HC41	60 5/8	1539	13/32	10	9476.....	▼ HC50	47 7/8	1216	15/32	12
7612.....	▼ HC41	61 5/8	1564	13/32	10	9480.....	▼ HC50	48 3/8	1229	15/32	12
7619.....	▼ HC41	62 5/8	1590	13/32	10	9485.....	▼ HC50	48 7/8	1241	15/32	12
7625.....	▼ HC41	63 1/8	1602	13/32	10	9490.....	▼ HC50	49 3/8	1254	15/32	12
7630.....	▼ HC41	63 5/8	1615	13/32	10	9492M.....	▼ HC50 Modified	49 5/8	1259	19/32	15
7640.....	▼ HC41	64 5/8	1640	13/32	10	9495.....	▼ HC50	49 7/8	1267	15/32	12
7650.....	▼ HC41	65 5/8	1666	13/32	10	9500.....	▼ HC50	50 3/8	1280	15/32	12
7660.....	▼ HC41	66 5/8	1691	13/32	10	9505.....	▼ HC50	50 7/8	1292	15/32	12
7665.....	▼ HC41	67 1/8	1704	13/32	10	9510.....	▼ HC50	51 3/8	1305	15/32	12
7673.....	▼ HC41	67 5/8	1717	13/32	10	9520.....	▼ HC50	52 3/8	1330	15/32	12
7680.....	▼ HC41	68 5/8	1742	13/32	10	9525.....	▼ HC50	52 7/8	1343	15/32	12
7695.....	▼ HC41	70 1/8	1780	13/32	10	9530.....	▼ HC50	53 3/8	1356	15/32	12
7715.....	▼ HC41	72 1/8	1831	13/32	10	9540.....	▼ HC50	54 3/8	1381	15/32	12
7730.....	▼ HC41	73 5/8	1869	13/32	10	9545.....	▼ HC50	54 7/8	1394	15/32	12
7743.....	▼ HC41	74 5/8	1894	13/32	10	9550.....	▼ HC50	55 3/8	1407	15/32	12
7760.....	▼ HC41	76 5/8	1945	13/32	10	9551M.....	▼ HC50 Modified	55 1/2	1411	17/32	13
7775.....	▼ HC41	78 1/8	1983	13/32	10	9555.....	▼ HC50	55 7/8	1418	15/32	12
9245.....	▼ HC50	24 7/8	632	15/32	12	9560.....	▼ HC50	56 3/8	1432	15/32	12
9255.....	▼ HC50	25 7/8	657	15/32	12	9565.....	▼ HC50	56 7/8	1445	15/32	12
9260.....	▼ HC50	26 3/8	670	15/32	12	9570.....	▼ HC50	57 3/8	1457	15/32	12
9265.....	▼ HC50	26 7/8	683	15/32	12	9580.....	▼ HC50	58 3/8	1483	15/32	12
9270.....	▼ HC50	27 3/8	695	15/32	12	9585.....	▼ HC50	58 7/8	1495	15/32	12
9279.....	▼ HC50	28 1/4	718	15/32	12	9590.....	▼ HC50	59 3/8	1508	15/32	12
9290.....	▼ HC50	29 3/8	746	15/32	12	9600.....	▼ HC50	60 3/8	1534	15/32	12
9295.....	▼ HC50	29 7/8	759	15/32	12	9605.....	▼ HC50	60 7/8	1546	15/32	12
9300.....	▼ HC50	30 3/8	772	15/32	12	9610.....	▼ HC50	61 3/8	1559	15/32	12
9305.....	▼ HC50	30 7/8	784	15/32	12	9620.....	▼ HC50	62 3/8	1584	15/32	12
9309.....	▼ HC50	31 3/8	797	15/32	12	9625.....	▼ HC50	62 7/8	1597	15/32	12
9313.....	▼ HC50	31 7/8	809	15/32	12	9630.....	▼ HC50	63 3/8	1610	15/32	12
9319.....	▼ HC50	32 3/8	822	15/32	12	9635.....	▼ HC50	63 7/8	1622	15/32	12
9325.....	▼ HC50	32 7/8	835	15/32	12	9640.....	▼ HC50	64 3/8	1635	15/32	12
9330.....	▼ HC50	33 3/8	848	15/32	12	9650.....	▼ HC50	65 3/8	1661	15/32	12
9335.....	▼ HC50	33 7/8	860	15/32	12	9660.....	▼ HC50	66 3/8	1686	15/32	12
9341.....	▼ HC50	34 3/8	873	15/32	12	9670.....	▼ HC50	67 3/8	1711	15/32	12
9345.....	▼ HC50	34 7/8	886	15/32	12	9680.....	▼ HC50	68 3/8	1737	15/32	12
9348M.....	▼ HC50 Modified	35 1/4	895	17/32	13	9690.....	▼ HC50	69 3/8	1762	15/32	12
9350.....	▼ HC50	35 3/8	899	15/32	12	9700.....	▼ HC50	70 3/8	1788	15/32	12
9355.....	▼ HC50	35 7/8	911	15/32	12	9710.....	▼ HC50	71 3/8	1813	15/32	12
9360.....	▼ HC50	36 3/8	924	15/32	12	9720.....	▼ HC50	72 3/8	1838	15/32	12
9361M.....	▼ HC50 Modified	36 1/2	928	19/32	15	9730.....	▼ HC50	73 3/8	1864	15/32	12
9362M.....	▼ HC50 Modified	36 5/8	930	17/32	13	9740.....	▼ HC50	74 3/8	1889	15/32	12
9365.....	▼ HC50	36 7/8	937	15/32	12	9745.....	▼ HC50	74 7/8	1902	15/32	12
9370.....	▼ HC50	37 3/8	949	15/32	12	9755.....	▼ HC50	75 7/8	1927	15/32	12
9375.....	▼ HC50	37 7/8	962	15/32	12	9765.....	▼ HC50	76 7/8	1953	15/32	12
9378.....	▼ HC50	38 1/8	968	15/32	12	9770.....	▼ HC50	77 3/8	1965	15/32	12
9380.....	▼ HC50	38 3/8	975	15/32	12	9775.....	▼ HC50	77 7/8	1978	15/32	12
9385.....	▼ HC50	38 7/8	987	15/32	12	9810.....	▼ HC50	81 3/8	2067	15/32	12
9390.....	▼ HC50	39 3/8	1000	15/32	12	9820.....	▼ HC50	82 3/8	2092	15/32	12
9395.....	▼ HC50	39 7/8	1013	15/32	12	9830.....	▼ HC50	83 3/8	2118	15/32	12
9400.....	▼ HC50	40 3/8	1026	15/32	12	9840.....	▼ HC50	84 3/8	2143	15/32	12
9403.....	▼ HC50	40 5/8	1032	15/32	12	9850.....	▼ HC50	85 3/8	2169	15/32	12

▼ Indicates Notched Belt.

Showing Nominal Belt Top Widths and Outside Lengths with Our Corresponding Belt Numbers

IMPORTANT: Lengths shown (O.C. is Outside Circumference) are obtained by measuring around the outside of the belt. These lengths will not agree exactly with the size significant belt numbering system which is based on the effective length of the belt. Effective length ("engineered" length) cannot be measured in the field because special tools are required.

Automotive Top Widths are the standard sizes defined by the automotive belt industry (SAE J636). Due to manufacturing processes that create "Vertical Flats", the top width of XL and Truck/Bus series V-Belts will not agree with the printed top width dimensions. Top width on this page and on the belt sleeve refers to the pulley groove width and not the actual top width of these belts. A picture of a V-Belt with "Vertical Flats" is shown below. Actual top width of like belt sizes will also vary slightly depending on the manufacturer and belt style.



Competitive V-Belt

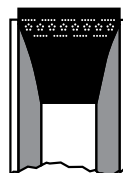

Our V-Belts with "Vertical Flats"

Length (in)	Length (mm)	Belt No.	Length (in)	Length (mm)	Belt No.	Length (in)	Length (mm)	Belt No.
1/4" (6mm) Top Width (HC25)			13/32" (10mm) Top Width (HC41)			13/32" (10mm) Top Width (HC41)		
			- Continued			- Continued		
26 1/4	665	7261	27 1/8	688	▼ 7265	47 7/8	1215	▼ 7473
28 3/8	720	7279	27 5/8	701	▼ 7270	48 1/8	1221	▼ 7475
30 1/4	770	7298	28 5/8	726	▼ 7280	48 5/8	1234	▼ 7480
31 1/4	795	7309	29 5/8	751	▼ 7290	48 7/8	1242	▼ 7483
32 1/4	820	7318	29 7/8	758	▼ 7292	49 1/8	1247	▼ 7485
33 1/4	845	7329	30 1/8	764	▼ 7295	49 5/8	1260	▼ 7490
34 1/4	870	7333	30 5/8	777	▼ 7300	50 1/8	1272	▼ 7495
35 1/4	895	7348	31 1/8	792	▼ 7305	50 5/8	1285	▼ 7500
36 1/4	920	7359	31 5/8	802	▼ 7312	51 1/8	1297	▼ 7508
36 3/4	935	7363	32 1/8	815	▼ 7315	51 5/8	1310	▼ 7512
38 1/4	970	7381	32 5/8	828	▼ 7320	52 1/8	1323	▼ 7516
39 1/4	995	7388	33 1/8	840	▼ 7325	52 5/8	1336	▼ 7520
41 1/4	1050	7409	33 3/8	847	▼ 7328	53 1/8	1348	▼ 7525
5/16" (8mm) Top Width (HC31)			33 5/8	853	▼ 7330	53 5/8	1361	▼ 7530
23	585	7228	34 1/8	866	▼ 7335	54 1/8	1374	▼ 7535
23 7/8	605	7234	34 5/8	878	▼ 7340	54 5/8	1386	▼ 7541
27 3/8	690	7274	35 1/8	891	▼ 7345	55 1/8	1399	▼ 7545
30 3/4	780	7304	35 5/8	904	▼ 7350	55 5/8	1412	▼ 7550
32 5/8	830	7324	36 1/8	919	▼ 7355	56 1/8	1425	▼ 7555
33 3/4	855	7334	36 5/8	929	▼ 7360	56 5/8	1437	▼ 7560
34 1/4	870	7343	37 1/8	942	▼ 7365	57 1/8	1450	▼ 7565
36 3/8	925	7362	37 5/8	954	▼ 7370	57 5/8	1464	▼ 7570
37 1/4	945	7369	38 1/8	967	▼ 7375	58 1/8	1476	▼ 7575
37 3/4	960	7374	38 5/8	980	▼ 7380	58 5/8	1488	▼ 7580
38 1/4	970	7379	39 1/8	993	▼ 7385	59 1/8	1501	▼ 7585
38 3/4	985	7384	39 5/8	1005	▼ 7390	59 5/8	1513	▼ 7590
39 1/4	995	7389	40 1/8	1018	▼ 7395	60 1/8	1526	▼ 7597
40 3/4	1035	7404	40 5/8	1031	▼ 7400	60 5/8	1539	▼ 7603
42 1/4	1075	7419	41 1/8	1044	▼ 7405	61 5/8	1564	▼ 7612
44 3/4	1135	7444	41 5/8	1056	▼ 7410	62 5/8	1590	▼ 7619
45 1/4	1150	7449	42 1/8	1069	▼ 7417	63 1/8	1602	▼ 7625
46 1/4	1175	7459	42 5/8	1082	▼ 7420	63 5/8	1615	▼ 7630
49 5/8	1260	7496	43 1/8	1095	▼ 7425	64 5/8	1640	▼ 7640
13/32" (10mm) Top Width (HC38 Mod)			43 5/8	1107	▼ 7430	65 5/8	1666	▼ 7650
45 1/4	1149	⊗ 7447M	44 1/8	1120	▼ 7435	66 5/8	1691	▼ 7660
13/32" (10mm) Top Width (HC41)			44 5/8	1132	▼ 7440	67 1/8	1704	▼ 7665
21 1/4	540	▼ 7208	45 1/8	1145	▼ 7445	67 5/8	1717	▼ 7673
22 1/8	561	▼ 7215	45 3/8	1151	▼ 7448	68 5/8	1742	▼ 7680
24 5/8	624	▼ 7240	45 5/8	1158	▼ 7450	70 1/8	1780	▼ 7695
25 5/8	650	▼ 7250	45 7/8	1164	▼ 7453	72 1/8	1831	▼ 7715
26 1/8	663	▼ 7255	46 1/8	1171	▼ 7455	73 5/8	1869	▼ 7730
26 5/8	675	▼ 7260	46 5/8	1183	▼ 7460	74 5/8	1894	▼ 7743
			47 1/8	1196	▼ 7465	76 5/8	1945	▼ 7760
			47 5/8	1209	▼ 7470	78 1/8	1983	▼ 7775

▼ Indicates Notched Belt. ⊗ Set of 2 Belts.

XL® Belts - Listed by Size

Length (in)	Length (mm)	Belt No.	Length (in)	Length (mm)	Belt No.	Length (in)	Length (mm)	Belt No.
15/32" (12mm) Top Width (HC50)			15/32" (12mm) Top Width (HC50)			15/32" (12mm) Top Width (HC50)		
			- Continued			- Continued		
24 7/8	632	▼ 9245	43 7/8	1114	▼ 9435	63 7/8	1622	▼ 9635
25 7/8	657	▼ 9255	44 3/8	1127	▼ 9440	64 3/8	1635	▼ 9640
26 3/8	670	▼ 9260	44 7/8	1140	▼ 9447	65 3/8	1661	▼ 9650
26 7/8	683	▼ 9265	45 3/8	1153	▼ 9451	66 3/8	1686	▼ 9660
27 3/8	695	▼ 9270	45 7/8	1165	▼ 9455	67 3/8	1711	▼ 9670
28 1/4	718	▼ 9279	46 3/8	1178	▼ 9463	68 3/8	1737	▼ 9680
29 3/8	746	▼ 9290	46 7/8	1191	▼ 9465	69 3/8	1762	▼ 9690
29 7/8	759	▼ 9295	47 3/8	1203	▼ 9470	70 3/8	1788	▼ 9700
30 3/8	772	▼ 9300	47 7/8	1216	▼ 9476	71 3/8	1813	▼ 9710
30 7/8	784	▼ 9305	48 3/8	1229	▼ 9480	72 3/8	1838	▼ 9720
31 3/8	797	▼ 9309	48 7/8	1241	▼ 9485	73 3/8	1864	▼ 9730
31 7/8	809	▼ 9313	49 3/8	1254	▼ 9490	74 3/8	1889	▼ 9740
32 3/8	822	▼ 9319	49 7/8	1267	▼ 9495	74 7/8	1902	▼ 9745
32 7/8	835	▼ 9325	50 3/8	1280	▼ 9500	75 7/8	1927	▼ 9755
33 3/8	848	▼ 9330	50 7/8	1292	▼ 9505	76 7/8	1953	▼ 9765
33 7/8	860	▼ 9335	51 3/8	1305	▼ 9510	77 3/8	1965	▼ 9770
34 3/8	873	▼ 9341	52 3/8	1330	▼ 9520	77 7/8	1978	▼ 9775
34 7/8	886	▼ 9345	52 7/8	1343	▼ 9525	81 3/8	2067	▼ 9810
35 3/8	899	▼ 9350	53 3/8	1356	▼ 9530	82 3/8	2092	▼ 9820
35 7/8	911	▼ 9355	54 3/8	1381	▼ 9540	83 3/8	2118	▼ 9830
36 3/8	924	▼ 9360	54 7/8	1394	▼ 9545	84 3/8	2143	▼ 9840
36 7/8	937	▼ 9365	55 3/8	1407	▼ 9550	85 3/8	2169	▼ 9850
37 3/8	949	▼ 9370	55 7/8	1418	▼ 9555	17/32" (13mm) Top Width (HC50 Mod)		
37 7/8	962	▼ 9375	56 3/8	1432	▼ 9560	35 1/4	895	▼ 9348M
38 1/8	968	▼ 9378	56 7/8	1445	▼ 9565	36 5/8	930	▼ 9362M
38 3/8	975	▼ 9380	57 3/8	1457	▼ 9570	45 5/8	1158	▼ 9452M
38 7/8	987	▼ 9385	58 3/8	1483	▼ 9580	45 3/4	1161	▼ 9453M
39 3/8	1000	▼ 9390	58 7/8	1495	▼ 9585	55 1/2	1411	▼ 9551M
39 7/8	1013	▼ 9395	59 3/8	1508	▼ 9590	19/32" (15mm) Top Width (HC50 Mod)		
40 3/8	1026	▼ 9400	60 3/8	1534	▼ 9600	36 1/2	928	▼ 9361M
40 5/8	1032	▼ 9403	60 7/8	1546	▼ 9605	49 5/8	1259	▼ 9492M
40 7/8	1038	▼ 9405	61 3/8	1559	▼ 9610			
41 3/8	1051	▼ 9412	62 3/8	1584	▼ 9620			
41 7/8	1064	▼ 9415	62 7/8	1597	▼ 9625			
42 3/8	1076	▼ 9420	63 3/8	1610	▼ 9630			
42 7/8	1089	▼ 9425						
43 3/8	1102	▼ 9430						

▼ Indicates Notched Belt

Showing Belt Numbers with Corresponding Nominal Outside Lengths and Top Widths

Belt No.	Length (in)	Length (mm)	Top Width (in)	Top Width (mm)	Belt No.	Length (in)	Length (mm)	Top Width (in)	Top Width (mm)
K040378HD	38 1/2	978	9/16	14	K060723HD	72 7/8	1851	13/16	20
K040388HD	39 3/8	999	9/16	14	K060735HD	74 1/8	1881	13/16	20
K040425HD	43 1/8	1095	9/16	14	K060736HD	74 1/8	1882	13/16	20
K040430HD	43 3/4	1111	9/16	14	K060739HD	74 1/2	1893	13/16	20
K040445HD	45 1/4	1148	9/16	14	K060747HD	75 3/8	1914	13/16	20
K040745HD	75 1/8	1907	9/16	14	K060772HD	77 3/4	1975	13/16	20
K040762HD	76 3/4	1950	9/16	14	K060795HD	80 1/8	2034	13/16	20
K050323HD	33	837	21/32	17	K060806HD	81 1/8	2061	13/16	20
K050336HD	34 1/4	871	21/32	17	K060812HD	81 3/4	2076	13/16	20
K050340HD	34 5/8	881	21/32	17	K060828HD	83 3/8	2118	13/16	20
K050345HD	35 1/4	894	21/32	17	K060832HD	83 3/4	2127	13/16	20
K050350HD	35 5/8	905	21/32	17	K060846HD	85 1/4	2164	13/16	20
K050360HD	36 3/4	932	21/32	17	K060849HD	85 1/2	2171	13/16	20
K050375HD	38 1/4	971	21/32	17	K060858HD	86 3/8	2193	13/16	20
K050380HD	38 3/4	983	21/32	17	K060860HD	86 5/8	2201	13/16	20
K050420HD	42 5/8	1084	21/32	17	K060870HD	87 5/8	2225	13/16	20
K060337HD	34 1/4	871	13/16	20	K060875HD	88 1/8	2238	13/16	20
K060340HD	34 3/4	881	13/16	20	K060883HD	89	2261	13/16	20
K060374HD	37 7/8	962	13/16	20	K060905HD	90 7/8	2308	13/16	20
K060390HD	39 3/4	1008	13/16	20	K060908HD	91 1/4	2319	13/16	20
K060393HD	39 7/8	1012	13/16	20	K060910HD	91 5/8	2329	13/16	20
K060400HD	40 3/4	1034	13/16	20	K060923HD	92 7/8	2360	13/16	20
K060408HD	41 1/2	1054	13/16	20	K060930HD	93 5/8	2377	13/16	20
K060415HD	42 1/8	1069	13/16	20	K060935HD	94	2387	13/16	20
K060420HD	42 1/2	1080	13/16	20	K060960HD	96 1/2	2453	13/16	20
K060425HD	43 1/8	1095	13/16	20	K060970HD	97 5/8	2480	13/16	20
K060435HD	44 1/8	1122	13/16	20	K060988HD	99 1/2	2526	13/16	20
K060439HD	44 1/2	1129	13/16	20	K060990HD	99 5/8	2531	13/16	20
K060455HD	46	1170	13/16	20	K060994HD	99 7/8	2537	13/16	20
K060458HD	46 3/8	1179	13/16	20	K060997HD	100 1/4	2546	13/16	20
K060470HD	47 5/8	1211	13/16	20	K061000HD	100 5/8	2555	13/16	20
K060478HD	48 1/4	1227	13/16	20	K061005HD	101 1/8	2568	13/16	20
K060480HD	48 5/8	1237	13/16	20	K061010HD	101 5/8	2581	13/16	20
K060483HD	48 7/8	1241	13/16	20	K061015HD	102 1/8	2593	13/16	20
K060490HD	49 1/2	1258	13/16	20	K061020HD	102 5/8	2605	13/16	20
K060495HD	50 1/8	1274	13/16	20	K061058HD	106 3/8	2701	13/16	20
K060500HD	50 3/4	1288	13/16	20	K061080HD	108 3/4	2761	13/16	20
K060505HD	51	1295	13/16	20	K061140HD	114 1/2	2910	13/16	20
K060509HD	51 1/2	1309	13/16	20	K061177HD	118 1/4	3004	13/16	20
K060516HD	52 1/8	1325	13/16	20	K061187HD	119 1/4	3030	13/16	20
K060520HD	52 3/4	1339	13/16	20	K061195HD	120 1/8	3051	13/16	20
K060523HD	52 7/8	1343	13/16	20	K061203HD	120 7/8	3070	13/16	20
K060525HD	53 3/8	1355	13/16	20	K061223HD	122 7/8	3121	13/16	20
K060529HD	53 1/2	1359	13/16	20	K061265HD	127 1/8	3229	13/16	20
K060532HD	53 7/8	1367	13/16	20	K061360HD	136 1/2	3467	13/16	20
K060539HD	54 1/2	1385	13/16	20	K061369HD	137 1/2	3493	13/16	20
K060547HD	55 1/4	1404	13/16	20	K070404HD	41	1042	15/16	24
K060555HD	56	1423	13/16	20	K070529HD	53	1359	15/16	24
K060557HD	56 1/4	1429	13/16	20	K070553HD	55 7/8	1418	15/16	24
K060559HD	56 1/2	1436	13/16	20	K070640HD	64 5/8	1642	15/16	24
K060560HD	56 5/8	1439	13/16	20	K070673HD	67 3/4	1722	15/16	24
K060568HD	57 3/8	1459	13/16	20	K070677HD	68 1/4	1734	15/16	24
K060569HD	57 1/2	1462	13/16	20	K070705HD	71 1/8	1807	15/16	24
K060575HD	58	1473	13/16	20	K070709HD	71 1/2	1816	15/16	24
K060578HD	58 3/8	1483	13/16	20	K070733HD	73 3/4	1874	15/16	24
K060586HD	59 1/4	1504	13/16	20	K070735HD	74 1/8	1883	15/16	24
K060588HD	59 3/8	1508	13/16	20	K070762HD	76 3/4	1949	15/16	24
K060594HD	60	1523	13/16	20	K070786HD	79 1/8	2011	15/16	24
K060598HD	60 3/8	1534	13/16	20	K070801HD	80 3/4	2051	15/16	24
K060605HD	61 1/8	1553	13/16	20	K070805HD	81 1/8	2061	15/16	24
K060615HD	62 1/8	1577	13/16	20	K070825HD	83 1/8	2112	15/16	24
K060625HD	63 1/8	1603	13/16	20	K070835HD	84	2134	15/16	24
K060628HD	63 3/8	1610	13/16	20	K071056HD	106 1/4	2699	15/16	24
K060631HD	63 3/4	1619	13/16	20	K071247HD	125 3/8	3183	15/16	24
K060635HD	64 1/8	1627	13/16	20	K080330HD	33 3/4	856	1 3/32	28
K060637HD	64 3/8	1634	13/16	20	K080375HD	38 1/8	968	1 3/32	28
K060653HD	65 7/8	1674	13/16	20	K080382HD	38 3/4	983	1 3/32	28
K060658HD	66 3/8	1687	13/16	20	K080384HD	39	990	1 3/32	28
K060660HD	66 3/4	1696	13/16	20	K080385HD	39 1/8	992	1 3/32	28
K060670HD	67 1/2	1716	13/16	20	K080400HD	40 3/4	1034	1 3/32	28
K060672HD	67 3/4	1722	13/16	20	K080415HD	42 1/8	1069	1 3/32	28
K060675HD	68	1728	13/16	20	K080427HD	43 1/2	1103	1 3/32	28
K060680HD	68 5/8	1742	13/16	20	K080433HD	43 7/8	1115	1 3/32	28
K060685HD	69 1/8	1756	13/16	20	K080435HD	44 1/8	1122	1 3/32	28
K060690HD	69 5/8	1767	13/16	20	K080450HD	45 5/8	1160	1 3/32	28
K060696HD	70 1/8	1781	13/16	20	K080465HD	47	1195	1 3/32	28
K060716HD	72	1830	13/16	20	K080468HD	47 3/8	1203	1 3/32	28

FleetRunner® Micro-V® Belts - Listed by Number

Belt No.	Length (in)	Length (mm)	Top Width (in)	Top Width (mm)	Belt No.	Length (in)	Length (mm)	Top Width (in)	Top Width (mm)
K080471HD	47 3/4	1211	1 3/32	28	K080839HD	84 3/8	2144	1 3/32	28
K080480HD	48 5/8	1237	1 3/32	28	K080842HD	84 3/4	2154	1 3/32	28
K080485HD	49 1/8	1249	1 3/32	28	K080845HD	85 1/8	2161	1 3/32	28
K080496HD	50 1/8	1274	1 3/32	28	K080850HD	85 3/8	2175	1 3/32	28
K080505HD	51	1297	1 3/32	28	K080852HD	85 3/4	2178	1 3/32	28
K080510HD	51 1/2	1309	1 3/32	28	K080855HD	86 1/8	2187	1 3/32	28
K080514HD	52	1320	1 3/32	28	K080859HD	86 3/8	2195	1 3/32	28
K080525HD	53 1/8	1351	1 3/32	28	K080860HD	86 5/8	2200	1 3/32	28
K080530HD	53 1/2	1359	1 3/32	28	K080865HD	87 1/8	2212	1 3/32	28
K080537HD	54 1/4	1379	1 3/32	28	K080868HD	87 3/8	2219	1 3/32	28
K080539HD	54 1/2	1384	1 3/32	28	K080872HD	87 3/4	2230	1 3/32	28
K080545HD	55 1/8	1399	1 3/32	28	K080876HD	88 1/8	2240	1 3/32	28
K080550HD	55 3/4	1415	1 3/32	28	K080878HD	88 3/8	2245	1 3/32	28
K080553HD	55 7/8	1419	1 3/32	28	K080885HD	89 1/8	2263	1 3/32	28
K080560HD	56 5/8	1439	1 3/32	28	K080889HD	89 1/2	2272	1 3/32	28
K080565HD	57	1448	1 3/32	28	K080893HD	89 7/8	2282	1 3/32	28
K080566HD	57 1/8	1452	1 3/32	28	K080897HD	90 3/8	2295	1 3/32	28
K080570HD	57 1/2	1462	1 3/32	28	K080903HD	90 7/8	2308	1 3/32	28
K080575HD	58 1/8	1475	1 3/32	28	K080910HD	91 5/8	2326	1 3/32	28
K080580HD	58 5/8	1490	1 3/32	28	K080913HD	91 7/8	2334	1 3/32	28
K080585HD	59	1499	1 3/32	28	K080915HD	92 1/8	2340	1 3/32	28
K080590HD	59 1/2	1512	1 3/32	28	K080922HD	92 3/4	2355	1 3/32	28
K080594HD	60	1523	1 3/32	28	K080926HD	93 1/8	2367	1 3/32	28
K080600HD	60 5/8	1538	1 3/32	28	K080931HD	93 5/8	2379	1 3/32	28
K080605HD	61 1/8	1553	1 3/32	28	K080934HD	93 7/8	2384	1 3/32	28
K080610HD	61 3/4	1569	1 3/32	28	K080939HD	94 1/2	2400	1 3/32	28
K080615HD	62 1/8	1577	1 3/32	28	K080944HD	95	2412	1 3/32	28
K080620HD	62 5/8	1591	1 3/32	28	K080948HD	95 3/8	2423	1 3/32	28
K080623HD	62 7/8	1598	1 3/32	28	K080952HD	95 3/4	2432	1 3/32	28
K080626HD	63 1/8	1603	1 3/32	28	K080956HD	96 1/4	2444	1 3/32	28
K080630HD	63 5/8	1616	1 3/32	28	K080962HD	96 3/4	2457	1 3/32	28
K080638HD	64 3/8	1634	1 3/32	28	K080964HD	97	2465	1 3/32	28
K080645HD	65 1/4	1657	1 3/32	28	K080968HD	97 1/2	2475	1 3/32	28
K080649HD	65 1/2	1665	1 3/32	28	K080986HD	99 1/8	2519	1 3/32	28
K080653HD	65 7/8	1674	1 3/32	28	K080991HD	99 5/8	2531	1 3/32	28
K080660HD	66 1/2	1691	1 3/32	28	K080994HD	100	2540	1 3/32	28
K080665HD	67 1/8	1705	1 3/32	28	K081000HD	100 5/8	2555	1 3/32	28
K080670HD	67 1/2	1716	1 3/32	28	K081005HD	101 1/8	2568	1 3/32	28
K080672HD	67 3/4	1722	1 3/32	28	K081015HD	102 1/8	2594	1 3/32	28
K080675HD	68	1728	1 3/32	28	K081020HD	102 5/8	2605	1 3/32	28
K080677HD	68 1/4	1734	1 3/32	28	K081023HD	102 7/8	2613	1 3/32	28
K080680HD	68 5/8	1742	1 3/32	28	K081025HD	103 1/8	2619	1 3/32	28
K080683HD	68 7/8	1750	1 3/32	28	K081032HD	103 3/4	2635	1 3/32	28
K080685HD	69 1/8	1756	1 3/32	28	K081035HD	104	2642	1 3/32	28
K080690HD	69 5/8	1767	1 3/32	28	K081044HD	105	2666	1 3/32	28
K080694HD	70	1777	1 3/32	28	K081047HD	105 1/4	2673	1 3/32	28
K080700HD	70 1/2	1789	1 3/32	28	K081051HD	105 3/4	2686	1 3/32	28
K080702HD	70 3/4	1798	1 3/32	28	K081055HD	106 1/8	2694	1 3/32	28
K080708HD	71 1/4	1811	1 3/32	28	K081059HD	106 1/2	2705	1 3/32	28
K080710HD	71 1/2	1816	1 3/32	28	K081065HD	107 1/8	2720	1 3/32	28
K080716HD	72 1/8	1831	1 3/32	28	K081074HD	108	2745	1 3/32	28
K080718HD	72 3/8	1839	1 3/32	28	K081079HD	108 1/2	2756	1 3/32	28
K080720HD	72 5/8	1845	1 3/32	28	K081088HD	109 3/8	2778	1 3/32	28
K080723HD	72 7/8	1851	1 3/32	28	K081092HD	109 3/4	2788	1 3/32	28
K080726HD	73 1/4	1859	1 3/32	28	K081099HD	110 1/2	2807	1 3/32	28
K080730HD	73 1/2	1867	1 3/32	28	K081102HD	110 3/4	2814	1 3/32	28
K080733HD	73 3/4	1874	1 3/32	28	K081124HD	113	2869	1 3/32	28
K080734HD	74	1880	1 3/32	28	K081153HD	116 1/4	2953	1 3/32	28
K080738HD	74 3/8	1889	1 3/32	28	K081177HD	118 1/4	3005	1 3/32	28
K080740HD	74 5/8	1896	1 3/32	28	K081189HD	119 1/2	3034	1 3/32	28
K080745HD	75 1/8	1907	1 3/32	28	K081196HD	120 1/8	3050	1 3/32	28
K080751HD	75 5/8	1921	1 3/32	28	K081207HD	121 3/8	3082	1 3/32	28
K080755HD	76	1931	1 3/32	28	K081213HD	121 7/8	3096	1 3/32	28
K080760HD	76 1/2	1942	1 3/32	28	K081223HD	122 3/4	3117	1 3/32	28
K080765HD	77	1957	1 3/32	28	K081243HD	124 7/8	3172	1 3/32	28
K080770HD	77 1/2	1969	1 3/32	28	K081264HD	127	3227	1 3/32	28
K080774HD	77 3/4	1976	1 3/32	28	K081265HD	127 1/8	3228	1 3/32	28
K080776HD	78 1/8	1985	1 3/32	28	K081298HD	130 3/8	3312	1 3/32	28
K080780HD	78 5/8	1996	1 3/32	28	K081304HD	131	3327	1 3/32	28
K080785HD	79	2007	1 3/32	28	K081325HD	133 1/8	3381	1 3/32	28
K080790HD	79 1/2	2019	1 3/32	28	K081331HD	133 3/4	3396	1 3/32	28
K080794HD	80	2032	1 3/32	28	K081348HD	135 3/8	3439	1 3/32	28
K080797HD	80 1/8	2037	1 3/32	28	K081359HD	136 1/2	3468	1 3/32	28
K080801HD	80 3/4	2050	1 3/32	28	K081362HD	136 3/4	3474	1 3/32	28
K080806HD	81 1/8	2061	1 3/32	28	K081369HD	137 1/2	3492	1 3/32	28
K080810HD	81 5/8	2073	1 3/32	28	K081377HD	138 1/4	3513	1 3/32	28
K080813HD	81 3/8	2067	1 3/32	28	K090490HD	49 1/2	1258	1 7/32	31
K080816HD	82 1/8	2086	1 3/32	28	K090500HD	50 1/2	1282	1 7/32	31
K080817HD	82 3/8	2091	1 3/32	28	K090578HD	58 3/8	1482	1 7/32	31
K080820HD	82 3/4	2100	1 3/32	28	K090586HD	59 1/4	1504	1 7/32	31
K080825HD	83 1/8	2112	1 3/32	28	K090609HD	61 1/2	1562	1 7/32	31
K080830HD	83 3/4	2127	1 3/32	28	K090613HD	62	1573	1 7/32	31
K080834HD	84	2134	1 3/32	28	K100381HD	38 3/4	983	1 3/8	35

FleetRunner® Micro-V® Belts - Listed by Number

Belt No.	Length (in)	Length (mm)	Top Width (in)	Top Width (mm)	Belt No.	Length (in)	Length (mm)	Top Width (in)	Top Width (mm)
K100437HD	44 1/4	1124	1 3/8	35	K100994HD	100	2539	1 3/8	35
K100456HD	46 1/8	1173	1 3/8	35	K101010HD	101 1/2	2579	1 3/8	35
K100465HD	47	1195	1 3/8	35	K101015HD	102	2591	1 3/8	35
K100485HD	48 7/8	1241	1 3/8	35	K101078HD	108 3/8	2753	1 3/8	35
K100495HD	50 1/8	1274	1 3/8	35	K101091HD	109 5/8	2786	1 3/8	35
K100502HD	50 3/4	1288	1 3/8	35	K101096HD	110 1/8	2797	1 3/8	35
K100510HD	51 1/2	1309	1 3/8	35	K101115HD	112	2846	1 3/8	35
K100529HD	53 3/8	1356	1 3/8	35	K120281HD	28 3/4	730	1 21/32	42
K100535HD	54	1373	1 3/8	35	K120360HD	36 5/8	929	1 21/32	42
K100540HD	54 1/2	1385	1 3/8	35	K120390HD	39 3/4	1008	1 21/32	42
K100551HD	55 5/8	1414	1 3/8	35	K120400HD	40 3/4	1034	1 21/32	42
K100554HD	56	1423	1 3/8	35	K120410HD	41 1/2	1054	1 21/32	42
K100557HD	56 3/8	1432	1 3/8	35	K120457HD	46 1/4	1175	1 21/32	42
K100563HD	56 7/8	1444	1 3/8	35	K120477HD	48 1/4	1226	1 21/32	42
K100564HD	57	1448	1 3/8	35	K120525HD	53 1/8	1351	1 21/32	42
K100570HD	57 1/2	1462	1 3/8	35	K120559HD	56 1/2	1436	1 21/32	42
K100572HD	57 7/8	1469	1 3/8	35	K120594HD	60	1523	1 21/32	42
K100575HD	58 1/8	1475	1 3/8	35	K120606HD	61 1/8	1553	1 21/32	42
K100578HD	58 3/8	1482	1 3/8	35	K120610HD	61 3/4	1569	1 21/32	42
K100579HD	58 1/2	1487	1 3/8	35	K120640HD	64 5/8	1641	1 21/32	42
K100582HD	58 3/4	1492	1 3/8	35	K120645HD	65	1651	1 21/32	42
K100594HD	60	1523	1 3/8	35	K120702HD	70 3/4	1798	1 21/32	42
K100600HD	60 1/2	1538	1 3/8	35	K120720HD	72 5/8	1845	1 21/32	42
K100604HD	61 1/8	1550	1 3/8	35	K120729HD	73 1/2	1867	1 21/32	42
K100607HD	61 1/4	1557	1 3/8	35	K120732HD	73 3/4	1873	1 21/32	42
K100610HD	61 5/8	1564	1 3/8	35	K120734HD	74	1880	1 21/32	42
K100615HD	62	1576	1 3/8	35	K120738HD	74 3/8	1889	1 21/32	42
K100618HD	63 3/4	1619	1 3/8	35	K120774HD	78	1982	1 21/32	42
K100630HD	63 5/8	1616	1 3/8	35	K120784HD	79	2007	1 21/32	42
K100637HD	64 1/4	1633	1 3/8	35	K120786HD	79 1/8	2010	1 21/32	42
K100640HD	64 5/8	1642	1 3/8	35	K120815HD	82	2083	1 21/32	42
K100643HD	65	1651	1 3/8	35	K120842HD	84 3/4	2154	1 21/32	42
K100649HD	65 1/2	1664	1 3/8	35	K120852HD	85 3/4	2178	1 21/32	42
K100655HD	66	1678	1 3/8	35	K120855HD	86 1/8	2188	1 21/32	42
K100658HD	66 3/8	1687	1 3/8	35	K120858HD	86 3/8	2194	1 21/32	42
K100661HD	66 3/4	1694	1 3/8	35	K120864HD	86 7/8	2208	1 21/32	42
K100665HD	67 1/8	1704	1 3/8	35	K120866HD	87 1/4	2215	1 21/32	42
K100670HD	67 1/2	1716	1 3/8	35	K120870HD	87 5/8	2225	1 21/32	42
K100675HD	68	1728	1 3/8	35	K120872HD	87 3/4	2230	1 21/32	42
K100677HD	68 1/4	1734	1 3/8	35	K120878HD	88 3/8	2245	1 21/32	42
K100686HD	69 1/4	1758	1 3/8	35	K120891HD	89 5/8	2278	1 21/32	42
K100694HD	70	1778	1 3/8	35	K120895HD	90 1/8	2289	1 21/32	42
K100702HD	70 7/8	1800	1 3/8	35	K120901HD	90 5/8	2301	1 21/32	42
K100706HD	71 1/4	1810	1 3/8	35	K120903HD	90 7/8	2308	1 21/32	42
K100710HD	71 1/2	1816	1 3/8	35	K120910HD	91 5/8	2326	1 21/32	42
K100714HD	72	1829	1 3/8	35	K120911HD	91 3/4	2329	1 21/32	42
K100719HD	72 3/8	1840	1 3/8	35	K120915HD	92 1/8	2340	1 21/32	42
K100720HD	72 5/8	1845	1 3/8	35	K120919HD	92 1/2	2350	1 21/32	42
K100726HD	73 1/8	1859	1 3/8	35	K120924HD	93 1/8	2364	1 21/32	42
K100731HD	73 5/8	1871	1 3/8	35	K120931HD	93 3/4	2381	1 21/32	42
K100739HD	74 1/2	1893	1 3/8	35	K120945HD	95	2415	1 21/32	42
K100745HD	75 1/8	1907	1 3/8	35	K120964HD	97	2463	1 21/32	42
K100749HD	75 1/2	1918	1 3/8	35	K120975HD	98 1/8	2492	1 21/32	42
K100761HD	76 3/4	1949	1 3/8	35	K120980HD	98 1/2	2503	1 21/32	42
K100764HD	77	1957	1 3/8	35	K120985HD	99 1/8	2516	1 21/32	42
K100771HD	77 3/4	1976	1 3/8	35	K120992HD	99 7/8	2537	1 21/32	42
K100780HD	78 5/8	1997	1 3/8	35	K121000HD	100 5/8	2556	1 21/32	42
K100789HD	79 1/2	2019	1 3/8	35	K121039HD	104 1/2	2654	1 21/32	42
K100810HD	81 5/8	2073	1 3/8	35	K121049HD	105 1/2	2680	1 21/32	42
K100814HD	82	2083	1 3/8	35	K121139HD	114 1/2	2909	1 21/32	42
K100818HD	82 1/2	2096	1 3/8	35	K140279HD	28 1/2	723	1 15/16	49
K100822HD	82 3/4	2102	1 3/8	35	K140345HD	35	890	1 15/16	49
K100830HD	83 5/8	2124	1 3/8	35	K140370HD	37 1/2	954	1 15/16	49
K100852HD	85 7/8	2182	1 3/8	35	K140429HD	43 1/2	1106	1 15/16	49
K100860HD	86 5/8	2200	1 3/8	35	K140433HD	43 7/8	1116	1 15/16	49
K100870HD	87 5/8	2226	1 3/8	35	K140451HD	45 5/8	1160	1 15/16	49
K100874HD	88	2235	1 3/8	35	K140496HD	50 1/8	1274	1 15/16	49
K100877HD	88 1/4	2242	1 3/8	35	K140516HD	52 1/8	1325	1 15/16	49
K100879HD	88 1/2	2247	1 3/8	35	K140524HD	53 1/8	1350	1 15/16	49
K100884HD	89	2261	1 3/8	35	K140555HD	56	1422	1 15/16	49
K100885HD	89 1/8	2264	1 3/8	35	K140580HD	58 5/8	1490	1 15/16	49
K100891HD	89 3/4	2278	1 3/8	35	K140594HD	60	1523	1 15/16	49
K100894HD	90	2285	1 3/8	35	K140597HD	60 3/8	1534	1 15/16	49
K100935HD	94	2388	1 3/8	35	K140603HD	60 7/8	1546	1 15/16	49
K100946HD	95 1/4	2419	1 3/8	35	K140618HD	62 3/8	1585	1 15/16	49
K100950HD	95 5/8	2428	1 3/8	35	K140627HD	63 3/8	1609	1 15/16	49
K100953HD	95 7/8	2436	1 3/8	35	K140662HD	66 3/4	1696	1 15/16	49
K100955HD	96	2438	1 3/8	35	K140682HD	68 3/4	1746	1 15/16	49
K100976HD	98 1/4	2496	1 3/8	35	K140700HD	70 1/2	1789	1 15/16	49
K100983HD	98 7/8	2511	1 3/8	35					

Showing Nominal Belt Top Widths and Outside Lengths with Our Corresponding Belt Numbers

Length (in)	Length (mm)	Belt No.	Length (in)	Length (mm)	Belt No.	Length (in)	Length (mm)	Belt No.
9/16" (14mm) Top Width			13/16" (20mm) Top Width			1 3/32" (28mm) Top Width		
38 1/2	978	K040378HD	- Continued			33 3/4	856	K080330HD
39 3/8	999	K040388HD	68	1728	K060675HD	38 1/8	968	K080375HD
43 1/8	1095	K040425HD	68 5/8	1742	K060680HD	38 3/4	983	K080382HD
43 3/4	1111	K040430HD	69 1/8	1756	K060685HD	39	990	K080384HD
45 1/4	1148	K040445HD	69 5/8	1767	K060690HD	39 1/8	992	K080385HD
75 1/8	1907	K040745HD	70 1/8	1781	K060696HD	40 3/4	1034	K080400HD
76 3/4	1950	K040762HD	72	1830	K060716HD	42 1/8	1069	K080415HD
21/32" (17mm) Top Width			72 7/8	1851	K060723HD	43 1/2	1103	K080427HD
33	837	K050323HD	74 1/8	1881	K060735HD	43 7/8	1115	K080433HD
34 1/4	871	K050336HD	74 1/8	1882	K060736HD	44 1/8	1122	K080435HD
34 5/8	881	K050340HD	74 1/2	1893	K060739HD	45 5/8	1160	K080450HD
35 1/4	894	K050345HD	75 3/8	1914	K060747HD	47	1195	K080465HD
35 5/8	905	K050350HD	77 3/4	1975	K060772HD	47 3/8	1203	K080468HD
36 3/4	932	K050360HD	80 1/8	2034	K060795HD	47 3/4	1211	K080471HD
38 1/4	971	K050375HD	81 1/8	2061	K060806HD	48 5/8	1237	K080480HD
38 3/4	983	K050380HD	81 3/4	2076	K060812HD	49 1/8	1249	K080485HD
42 5/8	1084	K050420HD	83 3/8	2118	K060828HD	50 1/8	1274	K080496HD
13/16" (20mm) Top Width			83 3/4	2127	K060832HD	51	1297	K080505HD
34 1/4	871	K060337HD	85 1/4	2164	K060846HD	51 1/2	1309	K080510HD
34 3/4	881	K060340HD	85 1/2	2171	K060849HD	52	1320	K080514HD
37 7/8	962	K060374HD	86 3/8	2193	K060858HD	53 1/8	1351	K080525HD
39 3/4	1008	K060390HD	86 5/8	2201	K060860HD	3 1/2	1359	K080530HD
39 7/8	1012	K060393HD	87 5/8	2225	K060870HD	54 1/4	1379	K080537HD
40 3/4	1034	K060400HD	88 1/8	2238	K060875HD	54 1/2	1384	K080539HD
41 1/2	1054	K060408HD	89	2261	K060883HD	55 1/8	1399	K080545HD
42 1/8	1069	K060415HD	90 7/8	2308	K060905HD	55 3/4	1415	K080550HD
42 1/2	1080	K060420HD	91 1/4	2319	K060908HD	55 7/8	1419	K080553HD
43 1/8	1095	K060425HD	91 5/8	2329	K060910HD	56 5/8	1439	K080560HD
44 1/8	1122	K060435HD	92 7/8	2360	K060923HD	57	1448	K080565HD
44 1/2	1129	K060439HD	93 5/8	2377	K060930HD	57 1/8	1452	K080566HD
46	1170	K060455HD	94	2387	K060935HD	57 1/2	1462	K080570HD
46 3/8	1179	K060458HD	96 1/2	2453	K060960HD	58 1/8	1475	K080575HD
47 5/8	1211	K060470HD	97 5/8	2480	K060970HD	58 5/8	1490	K080580HD
48 1/4	1227	K060478HD	99 1/2	2526	K060988HD	59	1499	K080585HD
48 5/8	1237	K060480HD	99 5/8	2531	K060990HD	59 1/2	1512	K080590HD
48 7/8	1241	K060483HD	99 7/8	2537	K060994HD	60	1523	K080594HD
49 1/2	1258	K060490HD	100 1/4	2546	K060997HD	60 5/8	1538	K080600HD
50 1/8	1274	K060495HD	100 5/8	2555	K061000HD	61 1/8	1553	K080605HD
50 3/4	1288	K060500HD	101 1/8	2568	K061005HD	61 3/4	1569	K080610HD
51	1295	K060505HD	101 5/8	2581	K061010HD	62 1/8	1577	K080615HD
51 1/2	1309	K060509HD	102 1/8	2593	K061015HD	62 5/8	1591	K080620HD
52 1/8	1325	K060516HD	102 5/8	2605	K061020HD	62 7/8	1598	K080623HD
52 3/4	1339	K060520HD	106 3/8	2701	K061058HD	63 1/8	1603	K080626HD
52 7/8	1343	K060523HD	108 3/4	2761	K061080HD	63 5/8	1616	K080630HD
53 3/8	1355	K060525HD	114 1/2	2910	K061140HD	64 3/8	1634	K080638HD
53 1/2	1359	K060529HD	118 1/4	3004	K061177HD	65 1/4	1657	K080645HD
53 7/8	1367	K060532HD	119 1/4	3030	K061187HD	65 1/2	1665	K080649HD
54 1/2	1385	K060539HD	120 1/8	3051	K061195HD	65 7/8	1674	K080653HD
55 1/4	1404	K060547HD	120 7/8	3070	K061203HD	66 1/2	1691	K080660HD
56	1423	K060555HD	122 7/8	3121	K061223HD	67 1/8	1705	K080665HD
56 1/4	1429	K060557HD	127 1/8	3229	K061265HD	67 1/2	1716	K080670HD
56 1/2	1436	K060559HD	136 1/2	3467	K061360HD	67 3/4	1722	K080672HD
56 5/8	1439	K060560HD	137 1/2	3493	K061369HD	68	1728	K080675HD
57 3/8	1459	K060568HD	15/16" (24mm) Top Width			68 1/4	1734	K080677HD
57 1/2	1462	K060569HD	41	1042	K070404HD	68 5/8	1742	K080680HD
58	1473	K060575HD	53	1359	K070529HD	68 7/8	1750	K080683HD
58 3/8	1483	K060578HD	55 7/8	1418	K070553HD	69 1/8	1756	K080685HD
59 1/4	1504	K060586HD	64 5/8	1642	K070640HD	69 5/8	1767	K080690HD
59 3/8	1508	K060588HD	67 3/4	1722	K070673HD	70	1777	K080694HD
60	1523	K060594HD	68 1/4	1734	K070677HD	70 1/2	1789	K080700HD
60 3/8	1534	K060598HD	71 1/8	1807	K070705HD	70 3/4	1798	K080702HD
61 1/8	1553	K060605HD	71 1/2	1816	K070709HD	71 1/4	1811	K080708HD
62 1/8	1577	K060615HD	73 3/4	1874	K070733HD	71 1/2	1816	K080710HD
63 1/8	1603	K060625HD	74 1/8	1883	K070735HD	72 1/8	1831	K080716HD
63 3/8	1610	K060628HD	76 3/4	1949	K070762HD	72 3/8	1839	K080718HD
63 3/4	1619	K060631HD	79 1/8	2011	K070786HD	72 5/8	1845	K080720HD
64 1/8	1627	K060635HD	80 3/4	2051	K070801HD	72 7/8	1851	K080723HD
64 3/8	1634	K060637HD	81 1/8	2061	K070805HD	73 1/4	1859	K080726HD
65 7/8	1674	K060653HD	83 1/8	2112	K070825HD	73 1/2	1867	K080730HD
66 3/8	1687	K060658HD	84	2134	K070835HD	73 3/4	1874	K080733HD
66 3/4	1696	K060660HD	106 1/4	2699	K071056HD	74	1880	K080734HD
67 1/2	1716	K060670HD	125 3/8	3183	K071247HD	74 3/8	1889	K080738HD
67 3/4	1722	K060672HD				74 5/8	1896	K080740HD
						75 1/8	1907	K080745HD
						75 5/8	1921	K080751HD

FleetRunner® Micro-V® Belts - Listed by Size

Length (in)	Length (mm)	Belt No.	Length (in)	Length (mm)	Belt No.	Length (in)	Length (mm)	Belt No.
1 3/32" (28mm) Top Width			1 3/32" (28mm) Top Width			1 3/8" (35mm) Top Width		
- Continued			- Continued			- Continued		
76	1931	K080755HD	119 1/2	3034	K081189HD	75 1/8	1907	K100745HD
76 1/2	1942	K080760HD	120 1/8	3050	K081196HD	75 1/2	1918	K100749HD
77	1957	K080765HD	121 3/8	3082	K081207HD	76 3/4	1949	K100761HD
77 1/2	1969	K080770HD	121 7/8	3096	K081213HD	77	1957	K100764HD
77 3/4	1976	K080774HD	122 3/4	3117	K081223HD	77 3/4	1976	K100771HD
78 1/8	1985	K080776HD	124 7/8	3172	K081243HD	78 5/8	1997	K100780HD
78 5/8	1996	K080780HD	127	3227	K081264HD	79 1/2	2019	K100789HD
79	2007	K080785HD	127 1/8	3228	K081265HD	81 5/8	2073	K100810HD
79 1/2	2019	K080790HD	130 3/8	3312	K081298HD	82	2083	K100814HD
80	2032	K080794HD	131	3327	K081304HD	82 1/2	2096	K100818HD
80 1/8	2037	K080797HD	133 1/8	3381	K081325HD	82 3/4	2102	K100822HD
80 3/4	2050	K080801HD	133 3/4	3396	K081331HD	83 5/8	2124	K100830HD
81 1/8	2061	K080806HD	135 3/8	3439	K081348HD	85 7/8	2182	K100852HD
81 5/8	2073	K080810HD	136 1/2	3468	K081359HD	86 5/8	2200	K100860HD
81 3/8	2067	K080813HD	136 3/4	3474	K081362HD	87 5/8	2226	K100870HD
82 1/8	2086	K080816HD	137 1/2	3492	K081369HD	88	2235	K100874HD
82 3/8	2091	K080817HD	138 1/4	3513	K081377HD	88 1/4	2242	K100877HD
82 3/4	2100	K080820HD				88 1/2	2247	K100879HD
83 1/8	2112	K080825HD	1 7/32" (31mm) Top Width			89	2261	K100884HD
83 3/4	2127	K080830HD	49 1/2	1258	K090490HD	89 1/8	2264	K100885HD
84	2134	K080834HD	50 1/2	1282	K090500HD	89 3/4	2278	K100891HD
84 3/8	2144	K080839HD	58 3/8	1482	K090578HD	90	2285	K100894HD
84 3/4	2154	K080842HD	59 1/4	1504	K090586HD	94	2388	K100935HD
85 1/8	2161	K080845HD	61 1/2	1562	K090609HD	95 1/4	2419	K100946HD
85 3/8	2175	K080850HD	62	1573	K090613HD	95 5/8	2428	K100950HD
85 3/4	2178	K080852HD				95 7/8	2436	K100953HD
86 1/8	2187	K080855HD	1 3/8" (35mm) Top Width			96	2438	K100955HD
86 3/8	2195	K080859HD	38 3/4	983	K100381HD	96	2438	K100955HD
86 5/8	2200	K080860HD	44 1/4	1124	K100437HD	98 1/4	2496	K100976HD
87 1/8	2212	K080865HD	46 1/8	1173	K100456HD	98 7/8	2511	K100983HD
87 3/8	2219	K080868HD	47	1195	K100465HD	100	2539	K100994HD
87 3/4	2230	K080872HD	48 7/8	1241	K100485HD	101 1/2	2579	K101010HD
88 1/8	2240	K080876HD	50 1/8	1274	K100495HD	102	2591	K101015HD
88 3/8	2245	K080878HD	50 3/4	1288	K100502HD	108 3/8	2753	K101078HD
89 1/8	2263	K080885HD	51 1/2	1309	K100510HD	109 5/8	2786	K101091HD
89 1/2	2272	K080889HD	53 3/8	1356	K100529HD	110 1/8	2797	K101096HD
89 7/8	2282	K080893HD	54	1373	K100535HD	112	2846	K101115HD
90 3/8	2295	K080897HD	54 1/2	1385	K100540HD	1 21/32" (42mm) Top Width		
90 7/8	2308	K080903HD	55 5/8	1414	K100551HD	28 3/4	730	K120281HD
91 5/8	2326	K080910HD	56	1423	K100554HD	36 5/8	929	K120360HD
91 7/8	2334	K080913HD	56 3/8	1432	K100557HD	39 3/4	1008	K120390HD
92 1/8	2340	K080915HD	56 7/8	1444	K100563HD	40 3/4	1034	K120400HD
92 3/4	2355	K080922HD	57	1448	K100564HD	41 1/2	1054	K120410HD
93 1/8	2367	K080926HD	57 1/2	1462	K100570HD	46 1/4	1175	K120457HD
93 5/8	2379	K080931HD	57 7/8	1469	K100572HD	48 1/4	1226	K120477HD
93 7/8	2384	K080934HD	58 1/8	1475	K100575HD	53 1/8	1351	K120525HD
94 1/2	2400	K080939HD	58 3/8	1482	K100578HD	56 1/2	1436	K120559HD
95	2412	K080944HD	58 1/2	1487	K100579HD	60	1523	K120594HD
95 3/8	2423	K080948HD	58 3/4	1492	K100582HD	61 1/8	1553	K120606HD
95 3/4	2432	K080952HD	60	1523	K100594HD	61 3/4	1569	K120610HD
96 1/4	2444	K080956HD	60 1/2	1538	K100600HD	64 5/8	1641	K120640HD
96 3/4	2457	K080962HD	61 1/8	1550	K100604HD	65	1651	K120645HD
97	2465	K080964HD	61 1/4	1557	K100607HD	70 3/4	1798	K120702HD
97 1/2	2475	K080968HD	61 5/8	1564	K100610HD	72 5/8	1845	K120720HD
99 1/8	2519	K080986HD	62	1576	K100615HD	73 1/2	1867	K120729HD
99 5/8	2531	K080991HD	63 3/4	1619	K100618HD	73 3/4	1873	K120732HD
100	2540	K080994HD	63 5/8	1616	K100630HD	74	1880	K120734HD
100 5/8	2555	K081000HD	64 1/4	1633	K100637HD	74 3/8	1889	K120738HD
101 1/8	2568	K081005HD	64 5/8	1642	K100640HD	78	1982	K120774HD
102 1/8	2594	K081015HD	65	1651	K100643HD	79	2007	K120784HD
102 5/8	2605	K081020HD	65 1/2	1664	K100649HD	79 1/8	2010	K120786HD
102 7/8	2613	K081023HD	66	1678	K100655HD	82	2083	K120815HD
103 1/8	2619	K081025HD	66 3/8	1687	K100658HD	84 3/4	2154	K120842HD
103 3/4	2635	K081032HD	66 3/4	1694	K100661HD	85 3/4	2178	K120852HD
104	2642	K081035HD	67 1/8	1704	K100665HD	86 1/8	2188	K120855HD
105	2666	K081044HD	67 1/2	1716	K100670HD	86 3/8	2194	K120858HD
105 1/4	2673	K081047HD	68	1728	K100675HD	86 7/8	2208	K120864HD
105 3/4	2686	K081051HD	68 1/4	1734	K100677HD	87 1/4	2215	K120866HD
106 1/8	2694	K081055HD	69 1/4	1758	K100686HD	87 5/8	2225	K120870HD
106 1/2	2705	K081059HD	70	1778	K100694HD	87 3/4	2230	K120872HD
107 1/8	2720	K081065HD	70 7/8	1800	K100702HD	88 3/8	2245	K120878HD
108	2745	K081074HD	71 1/4	1810	K100706HD	89 5/8	2278	K120891HD
108 1/2	2756	K081079HD	71 1/2	1816	K100710HD	90 1/8	2289	K120895HD
109 3/8	2778	K081088HD	72	1829	K100714HD	90 5/8	2301	K120901HD
109 3/4	2788	K081092HD	72 3/8	1840	K100719HD	90 7/8	2308	K120903HD
110 1/2	2807	K081099HD	72 5/8	1845	K100720HD	91 5/8	2326	K120910HD
110 3/4	2814	K081102HD	73 1/8	1859	K100726HD	91 3/4	2329	K120911HD
113	2869	K081124HD	73 5/8	1871	K100731HD	92 1/8	2340	K120915HD
116 1/4	2953	K081153HD	74 1/2	1893	K100739HD	92 1/2	2350	K120919HD
118 1/4	3005	K081177HD						

FleetRunner® Micro-V® Belts - Listed by Size

Length (in)	Length (mm)	Belt No.	Length (in)	Length (mm)	Belt No.	Length (in)	Length (mm)	Belt No.
1 21/32" (42mm) Top Width			1 15/16" (49mm) Top Width			1 15/16" (49mm) Top Width		
- Continued						- Continued		
93 1/8	2364	K120924HD	28 1/2	723	K140279HD	62 3/8	1585	K140618HD
93 3/4	2381	K120931HD	35	890	K140345HD	63 3/8	1609	K140627HD
95	2415	K120945HD	37 1/2	954	K140370HD	66 3/4	1696	K140662HD
97	2463	K120964HD	43 1/2	1106	K140429HD	68 3/4	1746	K140682HD
98 1/8	2492	K120975HD	43 7/8	1116	K140433HD	70 1/2	1789	K140700HD
98 1/2	2503	K120980HD	45 5/8	1160	K140451HD			
99 1/8	2516	K120985HD	50 1/8	1274	K140496HD			
99 7/8	2537	K120992HD	52 1/8	1325	K140516HD			
100 5/8	2556	K121000HD	53 1/8	1350	K140524HD			
104 1/2	2654	K121039HD	56	1422	K140555HD			
105 1/2	2680	K121049HD	58 5/8	1490	K140580HD			
114 1/2	2909	K121139HD	60	1523	K140594HD			
			60 3/8	1534	K140597HD			
			60 7/8	1546	K140603HD			

Showing Belt Numbers with Corresponding Nominal Outside Lengths and Top Widths

Belt No.	Length (in)	Length (mm)	Top Width (in)	Top Width (mm)	Belt No.	Length (in)	Length (mm)	Top Width (in)	Top Width (mm)
2PJ800	31 7/8	810	3/16	4.7	K040285	29 1/4	742	9/16	14
2PJ836	33 1/4	846	3/16	4.7	K040292	29 3/4	756	9/16	14
2PJ845	33 5/8	855	3/16	4.7	K040300	30 3/4	781	9/16	14
2PJ860	34 1/4	870	3/16	4.7	K040305	31 1/4	793	9/16	14
2PJ905	36	915	3/16	4.7	K040310	31 3/4	805	9/16	14
6PK1190	46 27/32	1190	13/16	21	K040315	32 1/4	818	9/16	14
6PK1660	65 1/2	1660	13/16	21	K040319	32 1/2	824	9/16	14
6PK1856	73	1856	13/16	21	K040320	32 3/4	831	9/16	14
6PK1880	74 7/16	1877	13/16	21	K040322	32 7/8	835	9/16	14
6PK1882	73 7/8	1882	13/16	21	K040325	33 1/4	844	9/16	14
6PK1890	74 13/32	1890	13/16	21	K040329	33 3/8	849	9/16	14
6PK2090	82 3/8	2090	13/16	21	K040330	33 3/4	856	9/16	14
7PK1930	76	1930	15/16	24	K040332	33 3/4	857	9/16	14
7PK2164	85 1/8	2164	15/16	24	K040335	34	864	9/16	14
7PK2217	87 9/32	2217	15/16	24	K040336	34 1/8	867	9/16	14
DK050565*	57 3/4	1468	21/32	17	K040337	34 1/4	871	9/16	14
DK050610*	62 1/8	1579	21/32	17	K040338	34 3/8	874	9/16	14
DK060472*	48 1/2	1232	13/16	20	K040340	34 5/8	879	9/16	14
DK060504*	51	1295	13/16	20	K040343	34 7/8	885	9/16	14
DK060519*	53	1348	13/16	20	K040345	35	889	9/16	14
DK060650*	66 1/8	1680	13/16	20	K040346	35 1/4	894	9/16	14
DK060674*	68 1/2	1741	13/16	20	K040347	35 3/8	897	9/16	14
DK060702*	71 1/4	1811	13/16	20	K040350	35 5/8	906	9/16	14
DK060718*	73	1853	13/16	20	K040353	35 7/8	912	9/16	14
DK060725*	73 3/4	1872	13/16	20	K040355	36 1/8	918	9/16	14
DK060729*	74 1/4	1885	13/16	20	K040358	36 3/8	924	9/16	14
DK060791*	80 3/8	2043	13/16	20	K040360	36 3/4	932	9/16	14
DK060867*	87 7/8	2232	13/16	20	K040365	37 1/8	943	9/16	14
DK060901*	90 5/8	2302	13/16	20	K040367	37 3/8	949	9/16	14
DK060956*	95 3/4	2432	13/16	20	K040370	37 1/2	953	9/16	14
DK060973*	98 5/8	2504	13/16	20	K040372	38	964	9/16	14
DK070536*	54 7/8	1394	15/16	24	K040378	38 1/2	977	9/16	14
DK070551*	56 3/8	1432	15/16	24	K040382	38 3/4	983	9/16	14
DK070817*	82 7/8	2105	15/16	24	K040384	39	991	9/16	14
DK071135*	114 1/8	2899	15/16	24	K040385	39 1/8	993	9/16	14
DK080534*	54	1370	1 3/32	28	K040388	39 3/8	999	9/16	14
DK081254*	126	3200	1 3/32	28	K040390	39 3/4	1008	9/16	14
DK081403*	140 7/8	3579	1 3/32	28	K040395	40 1/4	1021	9/16	14
DK100672*	68 3/8	1737	1 3/8	35	K040398	40 3/8	1027	9/16	14
K030195	20	509	13/32	11	K040399	40 5/8	1030	9/16	14
K030220	22 5/8	576	13/32	11	K040400	40 5/8	1032	9/16	14
K030231	23 3/4	603	13/32	11	K040405	41 1/4	1047	9/16	14
K030236	24 1/4	615	13/32	11	K040410	41 5/8	1057	9/16	14
K030240	24 3/4	629	13/32	11	K040413	42	1067	9/16	14
K030243	24 7/8	632	13/32	11	K040415	42	1068	9/16	14
K030245	25 1/4	640	13/32	11	K040418	42 3/8	1076	9/16	14
K030250	25 3/4	654	13/32	11	K040420	42 5/8	1085	9/16	14
K030265	27 1/8	689	13/32	11	K040425	43 1/8	1095	9/16	14
K030267	27 3/8	695	13/32	11	K040430	43 3/4	1110	9/16	14
K030267A	27 1/4	692	13/32	11	K040438	44 3/8	1125	9/16	14
K030280	28 3/4	730	13/32	11	K040440	44 5/8	1133	9/16	14
K030290	29 3/4	755	13/32	11	K040445	45 1/8	1148	9/16	14
K030295	30 1/8	765	13/32	11	K040450	45 3/4	1160	9/16	14
K030299	30 1/2	775	13/32	11	K040457	46 1/4	1175	9/16	14
K030300	30 3/4	781	13/32	11	K040460	46 5/8	1185	9/16	14
K030310	31 5/8	805	13/32	11	K040465	47	1195	9/16	14
K030323	32 7/8	836	13/32	11	K040470	47 5/8	1210	9/16	14
K030328	33 1/2	850	13/32	11	K040476	48 1/8	1223	9/16	14
K030334	34	864	13/32	11	K040488	49 3/8	1255	9/16	14
K030338	34 3/8	874	13/32	11	K040490	49 1/2	1258	9/16	14
K030340	34 5/8	881	13/32	11	K040500	50 5/8	1286	9/16	14
K030350	35 5/8	906	13/32	11	K040506	51 1/8	1299	9/16	14
K030365	37 1/8	943	13/32	11	K040510	51 1/2	1309	9/16	14
K030384	39 1/8	993	13/32	11	K040512	51 3/4	1315	9/16	14
K030390	39 3/4	1008	13/32	11	K040514	52	1320	9/16	14
K030395	40 1/8	1019	13/32	11	K040517	52 1/8	1325	9/16	14
K030415	42 1/8	1068	13/32	11	K040520	52 5/8	1338	9/16	14
K030425	43 1/8	1095	13/32	11	K040525	53 1/8	1351	9/16	14
K030441	44 3/4	1135	13/32	11	K040529	53 1/2	1359	9/16	14
K030455	46	1170	13/32	11	K040535	54	1373	9/16	14
K030471	47 3/4	1212	13/32	11	K040539	54 1/2	1385	9/16	14
K040220	22 5/8	575	9/16	14	K040545	55 1/8	1399	9/16	14
K040233	24 1/2	622	9/16	14	K040551	55 3/4	1415	9/16	14
K040245	25 1/4	640	9/16	14	K040560	56 1/2	1435	9/16	14
K040250	25 3/4	654	9/16	14	K040575	58 1/8	1475	9/16	14
K040270	27 3/4	704	9/16	14	K040595	60	1523	9/16	14
K040274	28	710	9/16	14	K040620	62 5/8	1591	9/16	14
K040275	28 1/4	717	9/16	14	K040630	63 5/8	1615	9/16	14

* Dual Sided Belt.

Century™ Series Micro-V® Belts - Listed by Number

Belt No.	Length (in)	Length (mm)	Top Width (in)	Top Width (mm)	Belt No.	Length (in)	Length (mm)	Top Width (in)	Top Width (mm)
K040635	.64	1627	9/16	14	K050640	.64 5/8	1642	21/32	17
K040685	.69 1/8	1756	9/16	14	K050644	.65	1651	21/32	17
K040745	.75 1/8	1907	9/16	14	K050647	.65 1/4	1657	21/32	17
K040762	.76 3/4	1950	9/16	14	K050650	.65 5/8	1667	21/32	17
K040882	.88 3/4	2255	9/16	14	K050653	.65 7/8	1675	21/32	17
K040940	.94 5/8	2403	9/16	14	K050658	.66 3/8	1687	21/32	17
K050200	.20 3/4	527	21/32	17	K050660	.66 3/4	1696	21/32	17
K050271	.27 3/4	704	21/32	17	K050665	.67 1/8	1704	21/32	17
K050275	.28 1/4	717	21/32	17	K050689	.69 5/8	1768	21/32	17
K050280	.28 3/4	730	21/32	17	K050690	.69 3/4	1772	21/32	17
K050290	.29 3/4	755	21/32	17	K050694	.70	1778	21/32	17
K050316	.32 1/4	818	21/32	17	K050705	.71 1/8	1807	21/32	17
K050317	.32 1/2	824	21/32	17	K050715	.72 1/8	1831	21/32	17
K050321	.32 3/4	831	21/32	17	K050720	.72 5/8	1845	21/32	17
K050323	.33	837	21/32	17	K050750	.75 3/8	1914	21/32	17
K050326	.33 1/4	843	21/32	17	K050755	.76	1932	21/32	17
K050330	.33 3/4	856	21/32	17	K050757	.76 1/4	1937	21/32	17
K050335	.34	864	21/32	17	K050778	.78 3/8	1989	21/32	17
K050336	.34 1/4	871	21/32	17	K050780	.78 1/2	1994	21/32	17
K050340	.34 5/8	881	21/32	17	K050817	.82 1/2	2096	21/32	17
K050344	.35	889	21/32	17	K050825	.83 1/8	2112	21/32	17
K050345	.35 1/4	894	21/32	17	K050835	.84	2134	21/32	17
K050350	.35 5/8	905	21/32	17	K050836	.84 1/8	2138	21/32	17
K050355	.36 1/8	918	21/32	17	K050845	.85 1/8	2164	21/32	17
K050360	.36 3/4	932	21/32	17	K050855	.86 1/8	2187	21/32	17
K050364	.37	939	21/32	17	K050887	.89 1/8	2265	21/32	17
K050365	.37 1/8	943	21/32	17	K060288	.29 1/2	748	13/16	20
K050368	.37 3/8	949	21/32	17	K060295	.30 1/8	765	13/16	20
K050370	.37 5/8	956	21/32	17	K060305	.31 1/4	793	13/16	20
K050375	.38 1/4	970	21/32	17	K060325	.33 1/4	844	13/16	20
K050380	.38 5/8	981	21/32	17	K060331	.33 3/4	856	13/16	20
K050385	.39 1/4	996	21/32	17	K060338	.34 3/8	873	13/16	20
K050390	.39 3/4	1008	21/32	17	K060340	.34 3/4	881	13/16	20
K050396	.40 1/4	1021	21/32	17	K060345	.35 1/4	894	13/16	20
K050398	.40 3/8	1027	21/32	17	K060352	.35 7/8	911	13/16	20
K050400	.40 5/8	1031	21/32	17	K060355	.36 1/8	918	13/16	20
K050402	.40 3/4	1035	21/32	17	K060365	.37 1/8	943	13/16	20
K050404	.41	1041	21/32	17	K060370	.37 3/4	957	13/16	20
K050405	.41 1/4	1047	21/32	17	K060374	.38	964	13/16	20
K050407	.41 3/8	1050	21/32	17	K060376	.38 1/8	968	13/16	20
K050410	.41 3/4	1059	21/32	17	K060378	.38 3/8	975	13/16	21
K050415	.42 1/8	1068	21/32	17	K060380	.38 3/4	983	13/16	20
K050418	.42 3/8	1076	21/32	17	K060385	.39 1/8	993	13/16	20
K050420	.42 5/8	1084	21/32	17	K060388	.39 3/8	999	13/16	20
K050425	.43 1/8	1094	21/32	17	K060390	.39 3/4	1008	13/16	20
K050429	.43 3/8	1102	21/32	17	K060393	.39 7/8	1012	13/16	20
K050433	.43 3/4	1113	21/32	17	K060394	.40	1016	13/16	20
K050435	.44 1/8	1122	21/32	17	K060400	.40 3/4	1034	13/16	20
K050438	.44 1/2	1129	21/32	17	K060405	.41	1043	13/16	20
K050440	.44 3/4	1135	21/32	17	K060406	.41 1/4	1050	13/16	20
K050442	.44 3/4	1137	21/32	17	K060407	.41 3/8	1052	13/16	20
K050446	.45 1/8	1148	21/32	17	K060408	.41 1/2	1054	13/16	20
K050448	.45 3/8	1152	21/32	17	K060409	.41 5/8	1056	13/16	20
K050450	.45 5/8	1160	21/32	17	K060410	.41 3/4	1059	13/16	20
K050455	.46	1170	21/32	17	K060415	.42 1/8	1069	13/16	20
K050459	.46 3/8	1179	21/32	17	K060418	.42 3/8	1076	13/16	20
K050460	.46 5/8	1186	21/32	17	K060420	.42 1/2	1081	13/16	20
K050470	.47 5/8	1211	21/32	17	K060423	.42 7/8	1089	13/16	20
K050474	.47 7/8	1218	21/32	17	K060425	.43 1/8	1095	13/16	20
K050478	.48 3/8	1228	21/32	17	K060426	.43 1/8	1096	13/16	20
K050480	.48 5/8	1237	21/32	17	K060427	.43 1/2	1103	13/16	20
K050486	.49 1/8	1249	21/32	17	K060431	.43 3/4	1111	13/16	20
K050490	.49 1/2	1258	21/32	17	K060434	.43 7/8	1116	13/16	20
K050500	.50 5/8	1286	21/32	17	K060435	.44 1/8	1122	13/16	20
K050505	.51	1297	21/32	17	K060439	.44 1/2	1129	13/16	20
K050507	.51 1/8	1300	21/32	17	K060441	.44 3/4	1135	13/16	20
K050510	.51 3/4	1315	21/32	17	K060445	.45 1/8	1148	13/16	20
K050516	.52 1/4	1327	21/32	17	K060448	.45 3/8	1153	13/16	20
K050520	.52 5/8	1338	21/32	17	K060450	.45 5/8	1160	13/16	20
K050523	.52 7/8	1343	21/32	17	K060455	.46	1170	13/16	20
K050530	.53 1/2	1359	21/32	17	K060458	.46 3/8	1179	13/16	20
K050532	.53 7/8	1367	21/32	17	K060461	.46 5/8	1186	13/16	20
K050538	.54 3/8	1380	21/32	17	K060465	.47	1195	13/16	20
K050545	.55 1/4	1404	21/32	17	K060468	.47 3/8	1204	13/16	20
K050551	.55 3/4	1415	21/32	17	K060470	.47 5/8	1211	13/16	20
K050565	.57	1448	21/32	17	K060473	.47 7/8	1216	13/16	20
K050570	.57 1/2	1462	21/32	17	K060474	.47 7/8	1217	13/16	20
K050586	.59 1/4	1504	21/32	17	K060478	.48 1/4	1227	13/16	20
K050609	.61 1/2	1563	21/32	17	K060480	.48 5/8	1235	13/16	20
K050612	.61 3/4	1568	21/32	17	K060483	.48 7/8	1241	13/16	20
K050618	.62 3/8	1584	21/32	17	K060486	.49 1/8	1248	13/16	20
K050625	.63 1/8	1603	21/32	17	K060490	.49 1/2	1258	13/16	20
K050630	.63 5/8	1616	21/32	17	K060492	.49 3/4	1265	13/16	20
K050635	.64 1/8	1627	21/32	17	K060494	.50	1270	13/16	20

Century™ Series Micro-V® Belts - Listed by Number

Belt No.	Length (in)	Length (mm)	Top Width (in)	Top Width (mm)	Belt No.	Length (in)	Length (mm)	Top Width (in)	Top Width (mm)
K060495	50 1/8	1274	13/16	20	K060760	76 1/2	1942	13/16	20
K060500	50 3/4	1288	13/16	20	K060763	76 7/8	1951	13/16	20
K060505	51	1297	13/16	20	K060764	77	1957	13/16	20
K060507	51 1/8	1300	13/16	20	K060770	77 3/8	1967	13/16	20
K060509	51 1/2	1309	13/16	20	K060771	77 5/8	1971	13/16	20
K060512	51 3/4	1315	13/16	20	K060772	77 7/8	1977	13/16	20
K060514	52	1321	13/16	20	K060775	78	1982	13/16	20
K060516	52 1/8	1325	13/16	20	K060780	78 5/8	1996	13/16	20
K060520	52 3/4	1339	13/16	20	K060785	79	2007	13/16	20
K060523	52 7/8	1343	13/16	20	K060787	79 1/8	2010	13/16	20
K060525	53 3/8	1355	13/16	20	K060790	79 1/2	2018	13/16	20
K060529	53 1/2	1359	13/16	20	K060795	80 1/8	2034	13/16	20
K060532	53 7/8	1367	13/16	20	K060798	80 3/8	2040	13/16	20
K060535	54 1/4	1379	13/16	20	K060802	80 3/4	2051	13/16	20
K060539	54 1/2	1385	13/16	20	K060804	81	2057	13/16	20
K060544	55	1397	13/16	20	K060806	81 1/8	2061	13/16	20
K060547	55 1/4	1404	13/16	20	K060810	81 5/8	2073	13/16	20
K060551	55 3/4	1415	13/16	20	K060812	81 3/4	2076	13/16	20
K060555	56	1423	13/16	20	K060815	82 1/8	2085	13/16	20
K060557	56 1/4	1429	13/16	20	K060819	82 1/2	2093	13/16	20
K060559	56 1/2	1436	13/16	20	K060820	82 1/2	2096	13/16	20
K060560	56 5/8	1439	13/16	20	K060822	82 3/4	2102	13/16	20
K060563	56 7/8	1445	13/16	20	K060824	83	2108	13/16	20
K060569	57 1/2	1462	13/16	20	K060825	83 1/8	2112	13/16	20
K060573	57 7/8	1471	13/16	20	K060827	83 1/4	2116	13/16	20
K060575	58	1473	13/16	20	K060828	83 3/8	2119	13/16	20
K060578	58 3/8	1483	13/16	20	K060832	83 3/4	2127	13/16	20
K060586	59 1/4	1504	13/16	20	K060834	84	2134	13/16	20
K060588	59 3/8	1508	13/16	20	K060837	84 1/4	2140	13/16	20
K060594	60	1523	13/16	20	K060837A	84 1/4	2140	13/16	20
K060598	60 3/8	1534	13/16	20	K060840	84 1/2	2147	13/16	20
K060602	60 3/4	1542	13/16	20	K060840A	84 1/2	2146	13/16	20
K060604	60 7/8	1547	13/16	20	K060841	84 5/8	2149	13/16	20
K060605	61 1/8	1553	13/16	20	K060842	84 3/4	2153	13/16	20
K060609	61 1/2	1563	13/16	20	K060845	85 1/4	2165	13/16	20
K060612	61 3/4	1569	13/16	20	K060849	85 1/2	2171	13/16	20
K060615	62 1/8	1577	13/16	20	K060850	85 5/8	2175	13/16	20
K060620	62 5/8	1591	13/16	20	K060851A	85 5/8	2175	13/16	20
K060623	62 7/8	1598	13/16	20	K060854	85 7/8	2182	13/16	20
K060625	63 1/8	1603	13/16	20	K060858	86 3/8	2193	13/16	20
K060628	63 3/8	1610	13/16	20	K060860	86 5/8	2201	13/16	20
K060630	63 5/8	1616	13/16	20	K060861A	86 5/8	2200	13/16	20
K060631	63 3/4	1619	13/16	20	K060863	86 7/8	2206	13/16	20
K060635	64 1/8	1627	13/16	20	K060864	86 7/8	2208	13/16	20
K060637	64 3/8	1634	13/16	20	K060866	87 1/4	2216	13/16	20
K060640	64 5/8	1642	13/16	20	K060867A	87 1/4	2216	13/16	20
K060642	64 3/4	1646	13/16	20	K060868	87 3/8	2219	13/16	20
K060645	65	1651	13/16	20	K060870	87 5/8	2225	13/16	20
K060650	65 1/2	1665	13/16	20	K060873A	87 7/8	2232	13/16	20
K060651	65 3/4	1669	13/16	21	K060874	87 7/8	2233	13/16	20
K060653	65 7/8	1674	13/16	20	K060875	88 1/8	2238	13/16	20
K060658	66 3/8	1687	13/16	20	K060876	88 1/8	2239	13/16	20
K060660	66 3/4	1696	13/16	20	K060878	88 3/8	2245	13/16	20
K060663	66 7/8	1699	13/16	20	K060880A	88 1/2	2248	13/16	20
K060667	67 1/4	1708	13/16	20	K060882	88 7/8	2257	13/16	20
K060670	67 1/2	1716	13/16	20	K060883	89	2261	13/16	20
K060672	67 3/4	1722	13/16	20	K060885	89 1/8	2263	13/16	20
K060675	68	1728	13/16	20	K060885A	89	2261	13/16	20
K060680	68 5/8	1742	13/16	20	K060886	89 1/8	2265	13/16	20
K060682	68 7/8	1750	13/16	20	K060888	89 1/2	2273	13/16	20
K060685	69 1/8	1756	13/16	20	K060891	89 3/4	2278	13/16	20
K060690	69 5/8	1767	13/16	20	K060895	90 1/8	2289	13/16	20
K060695	70	1777	13/16	20	K060900	90 5/8	2301	13/16	20
K060696	70 1/4	1783	13/16	20	K060905	90 7/8	2308	13/16	20
K060703	70 7/8	1799	13/16	20	K060908	91 1/4	2318	13/16	20
K060705	71 1/8	1807	13/16	20	K060910	91 5/8	2329	13/16	20
K060710	71 1/2	1816	13/16	20	K060911A	91 3/4	2330	13/16	20
K060711	71 5/8	1820	13/16	20	K060915	92 1/8	2340	13/16	20
K060714	72	1829	13/16	20	K060916A	92 1/8	2340	13/16	20
K060716	72	1830	13/16	20	K060919	92 3/8	2347	13/16	20
K060721	72 5/8	1845	13/16	20	K060923	92 7/8	2360	13/16	20
K060722	72 3/4	1848	13/16	20	K060926	93 1/8	2364	13/16	20
K060724	73	1854	13/16	20	K060930	93 5/8	2377	13/16	20
K060725	73 1/4	1859	13/16	20	K060935	94	2387	13/16	20
K060726A	73 1/8	1857	13/16	20	K060938	94 1/2	2400	13/16	20
K060730	73 1/2	1867	13/16	20	K060942	94 3/4	2407	13/16	20
K060733	73 7/8	1876	13/16	20	K060945	95 1/8	2415	13/16	20
K060735	74 1/8	1881	13/16	20	K060947	95 1/4	2419	13/16	20
K060739	74 1/2	1893	13/16	20	K060950	95 5/8	2428	13/16	20
K060744	75	1904	13/16	20	K060952	95 3/4	2432	13/16	20
K060747	75 3/8	1914	13/16	20	K060956	96 1/8	2440	13/16	20
K060750	75 5/8	1921	13/16	20	K060960	96 5/8	2453	13/16	20
K060751	75 3/4	1924	13/16	20	K060962	96 7/8	2460	13/16	20
K060755	76	1932	13/16	20	K060966	97 1/8	2468	13/16	20

Century™ Series Micro-V® Belts - Listed by Number

Belt No.	Length (in)	Length (mm)	Top Width (in)	Top Width (mm)	Belt No.	Length (in)	Length (mm)	Top Width (in)	Top Width (mm)
K060970	.97 5/8	2479	13/16	20	K070663	.66 3/4	1695	15/16	24
K060975	.98 1/8	2492	13/16	20	K070667	.67 1/4	1708	15/16	24
K060980	.98 5/8	2505	13/16	20	K070669	.67 1/2	1716	15/16	24
K060984	.99	2513	13/16	20	K070673	.67 3/4	1722	15/16	24
K060986	.99 1/4	2520	13/16	20	K070677	.68 1/4	1734	15/16	24
K060988	.99 1/2	2526	13/16	20	K070680	.68 5/8	1743	15/16	24
K060990	.99 5/8	2531	13/16	20	K070683	.68 7/8	1750	15/16	24
K060994	.99 7/8	2537	13/16	20	K070685	.69 1/8	1756	15/16	24
K060995	.100	2539	13/16	20	K070690	.69 1/2	1767	15/16	24
K060997	.100 1/4	2546	13/16	20	K070694	.70	1779	15/16	24
K061000	.100 5/8	2555	13/16	20	K070701	.70 3/4	1796	15/16	24
K061002	.100 3/4	2559	13/16	21	K070705	.71 1/8	1807	15/16	24
K061005	.101 1/8	2568	13/16	20	K070709	.71 1/2	1816	15/16	24
K061010	.101 5/8	2581	13/16	20	K070714	.72	1829	15/16	24
K061015	.102 1/8	2593	13/16	20	K070721	.72 3/4	1847	15/16	24
K061016	.102 1/4	2596	13/16	20	K070730	.73 5/8	1870	15/16	24
K061020	.102 5/8	2605	13/16	20	K070733	.73 3/4	1874	15/16	24
K061025	.103	2615	13/16	20	K070735	.74 1/8	1883	15/16	24
K061031	.103 5/8	2633	13/16	20	K070750	.75 5/8	1920	15/16	24
K061033	.103 7/8	2639	13/16	20	K070755	.76 1/8	1933	15/16	24
K061037	.104 1/4	2649	13/16	20	K070763	.76 7/8	1951	15/16	24
K061045	.105	2666	13/16	20	K070776	.78	1982	15/16	24
K061049	.105 1/2	2680	13/16	20	K070786	.79 1/8	2011	15/16	24
K061054	.106	2692	13/16	20	K070795	.80	2033	15/16	24
K061058	.106 3/8	2701	13/16	20	K070801	.80 3/4	2051	15/16	24
K061066	.107 1/8	2722	13/16	20	K070810	.81 5/8	2073	15/16	24
K061073	.107 7/8	2741	13/16	20	K070822	.82 3/4	2102	15/16	24
K061075	.108 1/8	2746	13/16	20	K070825	.83 1/8	2112	15/16	24
K061080	.108 3/4	2761	13/16	20	K070830	.83 5/8	2124	15/16	24
K061093	.109 3/4	2788	13/16	20	K070834	.84	2133	15/16	24
K061098	.109 3/8	2780	13/16	20	K070835	.84	2134	15/16	24
K061099	.110 1/2	2807	13/16	20	K070846	.85 1/4	2164	15/16	24
K061105	.111 1/8	2824	13/16	20	K070852	.85 3/4	2178	15/16	24
K061110	.111 5/8	2835	13/16	20	K070855	.86 1/8	2187	15/16	24
K061115	.111 7/8	2841	13/16	20	K070873	.87 7/8	2232	15/16	24
K061120	.112 1/2	2859	13/16	20	K070880	.88 1/2	2249	15/16	24
K061123	.112 7/8	2869	13/16	20	K070882	.88 3/4	2255	15/16	24
K061130	.113 5/8	2886	13/16	20	K070885	.89 1/8	2263	15/16	24
K061140	.114 1/2	2910	13/16	20	K070886	.89 1/8	2265	15/16	24
K061141	.114 5/8	2911	13/16	20	K070890	.89 3/4	2278	15/16	24
K061145	.115 1/4	2927	13/16	20	K070896	.90 1/8	2289	15/16	24
K061177	.118 1/4	3005	13/16	20	K070901	.90 5/8	2301	15/16	24
K061187	.119 1/4	3030	13/16	20	K070903	.90 7/8	2308	15/16	24
K061195	.120 1/8	3051	13/16	20	K070905	.91 1/8	2314	15/16	24
K061203	.120 7/8	3069	13/16	20	K070916	.92 1/4	2343	15/16	24
K061230	.123 5/8	3137	13/16	20	K070922	.92 3/4	2357	15/16	24
K061247	.125 1/4	3183	13/16	20	K070924	.93	2362	15/16	24
K061251	.125 5/8	3192	13/16	20	K070931	.93 5/8	2378	15/16	24
K061265	.127	3226	13/16	20	K070951	.95 3/4	2431	15/16	24
K061280	.128 5/8	3267	13/16	20	K070961	.96 3/4	2457	15/16	24
K061298	.130 3/8	3312	13/16	20	K070971	.97 3/4	2481	15/16	24
K061360	.136 1/2	3467	13/16	20	K070975	.97 3/4	2484	15/16	24
K061369	.137 1/2	3492	13/16	20	K070976	.98 1/8	2492	15/16	24
K061373	.137 7/8	3502	13/16	20	K071005	.101 1/8	2568	15/16	24
K061380	.138 5/8	3519	13/16	20	K071009	.101 3/8	2576	15/16	24
K061380A	.138 5/8	3519	13/16	20	K071013	.101 7/8	2586	15/16	24
K061420	.142 1/2	3621	13/16	20	K071031	.103 5/8	2633	15/16	24
K061490	.149 1/2	3799	13/16	20	K071037	.104 1/4	2649	15/16	24
K070319	.32 1/2	824	15/16	24	K071040	.104 5/8	2656	15/16	24
K070362	.36 7/8	936	15/16	24	K071045	.105 1/8	2671	15/16	24
K070370	.37 3/4	957	15/16	24	K071056	.106 1/4	2699	15/16	24
K070390	.39 3/4	1008	15/16	24	K071065	.107 1/8	2720	15/16	24
K070407	.41 1/4	1048	15/16	24	K071130	.113 5/8	2886	15/16	24
K070415	.42	1068	15/16	24	K071134	.114	2897	15/16	24
K070425	.43 1/8	1095	15/16	24	K071141	.114 5/8	2912	15/16	24
K070443	.44 7/8	1140	15/16	24	K071150	.115 5/8	2936	15/16	24
K070448	.45 3/8	1153	15/16	24	K071157	.116 1/4	2953	15/16	24
K070491EMD	.49 5/8	1261	15/16	24	K071194	.119 7/8	3046	15/16	24
K070500	.50 5/8	1286	15/16	24	K071247	.125 3/8	3183	15/16	24
K070505	.51 1/8	1300	15/16	24	K080300	.30 3/4	781	1 3/32	28
K070508	.51 3/8	1305	15/16	24	K080330	.33 3/4	856	1 3/32	28
K070539	.54 1/2	1385	15/16	24	K080334	.34	864	1 3/32	28
K070553	.55 7/8	1418	15/16	24	K080360	.36 3/4	932	1 3/32	28
K070566	.57 1/4	1454	15/16	24	K080365	.37 1/8	943	1 3/32	28
K070610	.61 5/8	1564	15/16	24	K080370	.37 3/4	957	1 3/32	28
K070615	.62 1/8	1578	15/16	24	K080375	.38 1/8	968	1 3/32	28
K070622	.62 3/4	1594	15/16	24	K080382	.38 3/4	983	1 3/32	28
K070628	.63 3/8	1609	15/16	24	K080384	.39	990	1 3/32	28
K070630	.63 5/8	1616	15/16	24	K080390	.39 3/4	1008	1 3/32	28
K070640	.64 5/8	1642	15/16	24	K080392	.39 7/8	1014	1 3/32	28
K070644	.65	1651	15/16	24	K080400	.40 3/4	1034	1 3/32	28
K070649	.66 1/2	1688	15/16	24	K080408	.41 3/8	1051	1 3/32	28
K070653	.65 7/8	1675	15/16	24	K080415	.42 1/8	1069	1 3/32	28
K070655	.66	1678	15/16	24	K080424	.43	1091	1 3/32	28

Century™ Series Micro-V® Belts - Listed by Number

Belt No.	Length (in)	Length (mm)	Top Width (in)	Top Width (mm)	Belt No.	Length (in)	Length (mm)	Top Width (in)	Top Width (mm)
K080427	43 1/2	1103	1 3/32	28	K080839	84 3/8	2144	1 3/32	28
K080435	44 1/8	1122	1 3/32	28	K080842	84 3/4	2154	1 3/32	28
K080450	45 5/8	1160	1 3/32	28	K080855	86 1/8	2187	1 3/32	28
K080455	46	1170	1 3/32	28	K080859	86 3/8	2195	1 3/32	28
K080458	46 3/8	1179	1 3/32	28	K080865	87 1/8	2212	1 3/32	28
K080465	47	1195	1 3/32	28	K080872	87 3/4	2230	1 3/32	28
K080471	47 3/4	1211	1 3/32	28	K080876	88 1/8	2240	1 3/32	28
K080485	49 1/8	1249	1 3/32	28	K080878	88 3/8	2245	1 3/32	28
K080491	49 5/8	1260	1 3/32	28	K080893	89 7/8	2282	1 3/32	28
K080496	50 1/8	1274	1 3/32	28	K080897	90 3/8	2295	1 3/32	28
K080505	51	1297	1 3/32	28	K080903	90 7/8	2308	1 3/32	28
K080510	51 1/2	1309	1 3/32	28	K080907	91 1/4	2318	1 3/32	28
K080514	52	1320	1 3/32	28	K080910	91 5/8	2326	1 3/32	28
K080525	53 1/8	1351	1 3/32	28	K080913	91 7/8	2334	1 3/32	28
K080530	53 1/2	1359	1 3/32	28	K080915	92 1/8	2340	1 3/32	28
K080537	54 1/4	1379	1 3/32	28	K080922	92 3/4	2355	1 3/32	28
K080545	55 1/8	1399	1 3/32	28	K080926	93 1/8	2367	1 3/32	28
K080550	55 3/4	1415	1 3/32	28	K080934	93 7/8	2384	1 3/32	28
K080558	56 1/4	1429	1 3/32	28	K080939	94 1/2	2400	1 3/32	28
K080560	56 5/8	1439	1 3/32	28	K080944	95	2412	1 3/32	28
K080565	57	1448	1 3/32	28	K080948	95 3/8	2424	1 3/32	28
K080566	57 1/8	1452	1 3/32	28	K080952	95 3/4	2432	1 3/32	28
K080570	57 1/2	1462	1 3/32	28	K080956	96 1/4	2444	1 3/32	28
K080575	58 1/8	1475	1 3/32	28	K080968	97 1/2	2475	1 3/32	28
K080580	58 5/8	1490	1 3/32	28	K080981	98 5/8	2505	1 3/32	28
K080585	59	1499	1 3/32	28	K080986	99 1/8	2519	1 3/32	28
K080590	59 1/2	1512	1 3/32	28	K080991	99 5/8	2531	1 3/32	28
K080594	60	1523	1 3/32	28	K081000	100 5/8	2555	1 3/32	28
K080600	60 5/8	1538	1 3/32	28	K081005	101 1/8	2568	1 3/32	28
K080605	61 1/8	1553	1 3/32	28	K081020	102 5/8	2605	1 3/32	28
K080610	61 3/4	1569	1 3/32	28	K081023	102 7/8	2613	1 3/32	28
K080615	62 1/8	1577	1 3/32	28	K081035	104	2642	1 3/32	28
K080620	62 5/8	1591	1 3/32	28	K081051	105 3/4	2686	1 3/32	28
K080623	62 7/8	1598	1 3/32	28	K081059	106 1/2	2705	1 3/32	28
K080626	63 1/8	1603	1 3/32	28	K081074	108	2745	1 3/32	28
K080630	63 5/8	1616	1 3/32	28	K081079	108 1/2	2756	1 3/32	28
K080635	64 1/4	1633	1 3/32	28	K081088	109 3/8	2778	1 3/32	28
K080644	65	1651	1 3/32	28	K081092	109 3/4	2788	1 3/32	28
K080645	65 1/4	1657	1 3/32	28	K081102	110 3/4	2814	1 3/32	28
K080649	65 1/2	1665	1 3/32	28	K081124	113	2869	1 3/32	28
K080653	65 7/8	1674	1 3/32	28	K081145	115 1/8	2924	1 3/32	28
K080655	66 1/4	1683	1 3/32	28	K081153	116 1/4	2953	1 3/32	28
K080660	66 1/2	1691	1 3/32	28	K081177	118 1/4	3005	1 3/32	28
K080661A	66 3/4	1695	1 3/32	28	K081189	119 1/2	3035	1 3/32	28
K080665	67 1/8	1705	1 3/32	28	K081196	120 1/8	3050	1 3/32	28
K080670	67 1/2	1716	1 3/32	28	K081207	121 3/8	3082	1 3/32	28
K080672	67 3/4	1722	1 3/32	28	K081213	121 7/8	3096	1 3/32	28
K080675	68	1728	1 3/32	28	K081223	122 3/4	3117	1 3/32	28
K080677	68 1/4	1734	1 3/32	28	K081253	125 7/8	3198	1 3/32	28
K080680	68 5/8	1742	1 3/32	28	K081264	127	3227	1 3/32	28
K080685	69 1/8	1756	1 3/32	28	K081265	127 1/8	3228	1 3/32	28
K080690	69 5/8	1767	1 3/32	28	K081298	130 3/8	3312	1 3/32	28
K080694	70	1777	1 3/32	28	K081325	133 1/8	3381	1 3/32	28
K080700	70 1/2	1789	1 3/32	28	K081331	133 3/4	3396	1 3/32	28
K080702	70 3/4	1798	1 3/32	28	K081348	135 3/8	3439	1 3/32	28
K080708	71 1/4	1811	1 3/32	28	K081359	136 1/2	3468	1 3/32	28
K080710	71 1/2	1816	1 3/32	28	K081362	136 3/4	3499	1 3/32	28
K080716	72 1/8	1831	1 3/32	28	K081377	138 1/4	3513	1 3/32	28
K080720	72 5/8	1845	1 3/32	28	K081490	149 1/2	3799	1 3/32	28
K080726	73 1/4	1859	1 3/32	28	K090500	50 1/2	1282	1 7/32	31
K080730	73 1/2	1867	1 3/32	28	K090609	61 1/2	1562	1 7/32	31
K080733	73 3/4	1874	1 3/32	28	K100381	38 3/4	983	1 3/8	35
K080734	74	1880	1 3/32	28	K100437	44 1/4	1124	1 3/8	35
K080738	74 3/8	1889	1 3/32	28	K100445	45 1/8	1148	1 3/8	35
K080740	74 5/8	1896	1 3/32	28	K100456	46 1/8	1173	1 3/8	35
K080745	75 1/8	1907	1 3/32	28	K100465	47	1195	1 3/8	35
K080751	75 5/8	1921	1 3/32	28	K100485	48 7/8	1241	1 3/8	35
K080755	76	1931	1 3/32	28	K100495	50 1/8	1274	1 3/8	35
K080760	76 1/2	1942	1 3/32	28	K100502	50 3/4	1288	1 3/8	35
K080765	77	1957	1 3/32	28	K100510	51 1/2	1309	1 3/8	35
K080774	77 3/4	1976	1 3/32	28	K100535	54	1373	1 3/8	35
K080776	78 1/8	1985	1 3/32	28	K100540	54 1/2	1385	1 3/8	35
K080780	78 5/8	1996	1 3/32	28	K100554	56	1423	1 3/8	35
K080785	79	2007	1 3/32	28	K100563	56 7/8	1444	1 3/8	35
K080790	79 1/2	2019	1 3/32	28	K100570	57 1/2	1462	1 3/8	35
K080797	80 1/8	2037	1 3/32	28	K100572	57 7/8	1469	1 3/8	35
K080803	80 7/8	2054	1 3/32	28	K100575	58 1/8	1475	1 3/8	35
K080806	81 1/8	2061	1 3/32	28	K100579	58 1/2	1487	1 3/8	35
K080810	81 5/8	2073	1 3/32	28	K100594	60	1523	1 3/8	35
K080816	82 1/8	2086	1 3/32	28	K100607	61 1/4	1557	1 3/8	35
K080817	82 3/8	2091	1 3/32	28	K100610	61 5/8	1564	1 3/8	35
K080820	82 3/4	2100	1 3/32	28	K100618	62 3/8	1585	1 3/8	35
K080825	83 1/8	2112	1 3/32	28	K100630	63 5/8	1616	1 3/8	35
K080830	83 3/4	2127	1 3/32	28	K100637	64 1/4	1633	1 3/8	35

Century™ Series Micro-V® Belts - Listed by Number

Belt No.	Length (in)	Length (mm)	Top Width (in)	Top Width (mm)	Belt No.	Length (in)	Length (mm)	Top Width (in)	Top Width (mm)
K100640	.64 5/8	1642	1 3/8	35	K120784	.79	2007	1 21/32	42
K100655	.66	1678	1 3/8	35	K120815	.82	2083	1 21/32	42
K100658	.66 3/8	1687	1 3/8	35	K120842	.84 3/4	2154	1 21/32	42
K100665	.67 1/8	1704	1 3/8	35	K120852	.85 3/4	2178	1 21/32	42
K100670	.67 1/2	1716	1 3/8	35	K120858	.86 3/8	2194	1 21/32	42
K100675	.68	1728	1 3/8	35	K120864	.86 7/8	2208	1 21/32	42
K100677	.68 1/4	1734	1 3/8	35	K120872	.87 3/4	2230	1 21/32	42
K100694	.70	1778	1 3/8	35	K120878	.88 3/8	2245	1 21/32	42
K100710	.71 1/2	1816	1 3/8	35	K120891	.89 5/8	2278	1 21/32	42
K100719	.72 3/8	1840	1 3/8	35	K120901	.90 5/8	2301	1 21/32	42
K100731	.73 5/8	1871	1 3/8	35	K120903	.90 7/8	2308	1 21/32	42
K100739	.74 1/2	1893	1 3/8	35	K120911	.91 3/4	2329	1 21/32	42
K100749	.75 1/2	1918	1 3/8	35	K120915	.92 1/8	2340	1 21/32	42
K100771	.77 3/4	1976	1 3/8	35	K120919	.92 1/2	2350	1 21/32	42
K100789	.79 1/2	2019	1 3/8	35	K120924	.93 1/8	2364	1 21/32	42
K100810	.81 5/8	2073	1 3/8	35	K120931	.93 3/4	2381	1 21/32	42
K100840	.84 5/8	2149	1 3/8	35	K120964	.97	2463	1 21/32	42
K100852	.85 7/8	2182	1 3/8	35	K120979	.98 1/8	2492	1 21/32	42
K100884	.89	2261	1 3/8	35	K121039	1.04 1/2	2654	1 21/32	42
K100886	.89 1/8	2264	1 3/8	35	K140345	.35	890	1 15/16	49
K100891	.89 3/4	2278	1 3/8	35	K140352	.35 7/8	910	1 15/16	49
K100955	.96	2438	1 3/8	35	K140370	.37 1/2	954	1 15/16	49
K100976	.98 1/8	2492	1 3/8	35	K140429	.43 1/2	1106	1 15/16	49
K101078	1.08 3/8	2753	1 3/8	35	K140433	.43 7/8	1116	1 15/16	49
K110841	.84 3/4	2153	1 1/2	38	K140451	.45 5/8	1160	1 15/16	49
K120281	.28 3/4	730	1 21/32	42	K140496	.50 1/8	1274	1 15/16	49
K120360	.36 5/8	929	1 21/32	42	K140516	.52 1/8	1325	1 15/16	49
K120390	.39 3/4	1008	1 21/32	42	K140524	.53 1/8	1350	1 15/16	49
K120400	.40 3/4	1034	1 21/32	42	K140555	.56	1422	1 15/16	49
K120410	.41 1/2	1054	1 21/32	42	K140580	.58 5/8	1490	1 15/16	49
K120457	.46 1/4	1175	1 21/32	42	K140594	.60	1523	1 15/16	49
K120477	.48 1/4	1226	1 21/32	42	K140597	.60 3/8	1534	1 15/16	49
K120525	.53 1/8	1351	1 21/32	42	K140603	.60 7/8	1546	1 15/16	49
K120559	.56 1/2	1436	1 21/32	42	K140618	.62 3/8	1585	1 15/16	49
K120594	.60	1523	1 21/32	42	K140627	.63 3/8	1609	1 15/16	49
K120606	.61 1/8	1553	1 21/32	42	K140662	.66 3/4	1696	1 15/16	49
K120610	.61 3/4	1569	1 21/32	42	K140682	.68 3/4	1746	1 15/16	49
K120702	.70 3/4	1798	1 21/32	42	K140700	.70 1/2	1789	1 15/16	49
K120720	.72 5/8	1845	1 21/32	42	K150759	.76 3/8	1942	2 1/16	53
K120734	.74	1880	1 21/32	42					
K120738	.74 3/8	1889	1 21/32	42					

Showing Nominal Belt Top Widths and Outside Lengths with Our Corresponding Belt Numbers

Length (in)	Length (mm)	Belt No.	Length (in)	Length (mm)	Belt No.	Length (in)	Length (mm)	Belt No.
3/16" (4.7mm) Top Width			9/16" (14mm) Top Width			21/32" (17mm) Top Width		
			- Continued					
31 7/8	810	2PJ800	36 3/8	924	K040358	33 3/4	856	K050330
33 1/4	846	2PJ836	36 3/4	932	K040360	34	864	K050335
33 5/8	855	2PJ845	37 1/8	943	K040365	34 1/4	871	K050336
34 1/4	870	2PJ860	37 3/8	949	K040367	34 5/8	881	K050340
36	915	2PJ905	37 1/2	953	K040370	35	889	K050344
13/32" (11mm) Top Width						- Continued		
20	509	K030195	38	964	K040372	35 1/4	894	K050345
22 5/8	576	K030220	38 1/2	977	K040378	35 5/8	905	K050350
23 3/4	603	K030231	38 3/4	983	K040382	36 1/8	918	K050355
24 1/4	615	K030236	39	991	K040384	36 3/4	932	K050360
24 3/4	629	K030240	39 1/8	993	K040385	37	939	K050364
24 7/8	632	K030243	39 3/8	999	K040388	37 1/8	943	K050365
25 1/4	640	K030245	39 3/4	1008	K040390	37 3/8	949	K050368
25 3/4	654	K030250	40 1/4	1021	K040395	37 5/8	956	K050370
27 1/8	689	K030265	40 3/8	1027	K040398	38 1/4	970	K050375
27 3/8	695	K030267	40 5/8	1030	K040399	38 5/8	981	K050380
27 1/4	692	K030267A	40 5/8	1032	K040400	39 1/4	996	K050385
28 3/4	730	K030280	41 1/4	1047	K040405	39 3/4	1008	K050390
29 3/4	755	K030290	41 5/8	1057	K040410	40 1/4	1021	K050396
30 1/8	765	K030295	42	1067	K040413	40 3/8	1027	K050398
30 1/2	775	K030299	42	1068	K040415	40 5/8	1031	K050400
30 3/4	781	K030300	42 3/8	1076	K040418	40 3/4	1035	K050402
31 5/8	805	K030310	42 5/8	1085	K040420	41	1041	K050404
32 7/8	836	K030323	43 1/8	1095	K040425	41 1/4	1047	K050405
33 1/2	850	K030328	43 3/4	1110	K040430	41 3/8	1050	K050407
34	864	K030334	44 3/8	1125	K040438	41 3/4	1059	K050410
34 3/8	874	K030338	44 5/8	1133	K040440	42 1/8	1068	K050415
34 5/8	881	K030340	45 1/8	1148	K040445	42 3/8	1076	K050418
35 5/8	906	K030350	45 3/4	1160	K040450	42 5/8	1084	K050420
37 1/8	943	K030365	46 1/4	1175	K040457	43 1/8	1094	K050425
39 1/8	993	K030384	46 5/8	1185	K040460	43 3/8	1102	K050429
39 3/4	1008	K030390	47	1195	K040465	43 3/4	1113	K050433
40 1/8	1019	K030395	47 5/8	1210	K040470	44 1/8	1122	K050435
42 1/8	1068	K030415	48 1/8	1223	K040476	44 1/2	1129	K050438
43 1/8	1095	K030425	49 3/8	1255	K040488	44 3/4	1135	K050440
44 3/4	1135	K030441	49 1/2	1258	K040490	44 3/4	1137	K050442
46	1170	K030455	50 5/8	1286	K040500	45 1/8	1148	K050446
47 3/4	1212	K030471	51 1/8	1299	K040506	45 3/8	1152	K050448
			51 1/2	1309	K040510	45 5/8	1160	K050450
			51 3/4	1315	K040512	46	1170	K050455
			52	1320	K040514	46 3/8	1179	K050459
			52 1/8	1325	K040517	46 5/8	1186	K050460
			52 5/8	1338	K040520	47 5/8	1211	K050470
			53 1/8	1351	K040525	47 7/8	1218	K050474
			53 1/2	1359	K040529	48 3/8	1228	K050478
			54	1373	K040535	48 5/8	1237	K050480
			54 1/2	1385	K040539	49 1/8	1249	K050486
			55 1/8	1399	K040545	49 1/2	1258	K050490
			55 3/4	1415	K040551	50 5/8	1286	K050500
			56 1/2	1435	K040560	51	1297	K050505
			58 1/8	1475	K040575	51 1/8	1300	K050507
			60	1523	K040595	51 3/4	1315	K050510
			62 5/8	1591	K040620	52 1/4	1327	K050516
			63 5/8	1615	K040630	52 5/8	1338	K050520
			64	1627	K040635	52 7/8	1343	K050523
			69 1/8	1756	K040685	53 1/2	1359	K050530
			75 1/8	1907	K040745	53 7/8	1367	K050532
			76 3/4	1950	K040762	54 3/8	1380	K050538
			88 3/4	2255	K040882	55 1/4	1404	K050545
			94 5/8	2403	K040940	55 3/4	1415	K050551
			21/32" (17mm) Top Width			57	1448	K050565
			20 3/4	527	K050200	57 1/2	1462	K050570
			27 3/4	704	K050271	57 3/4	1468	* DK050565
			28 1/4	717	K050275	59 1/4	1504	K050586
			28 3/4	730	K050280	61 1/2	1563	K050609
			29 3/4	755	K050290	61 3/4	1568	K050612
			32 1/4	818	K050316	62 1/8	1579	* DK050610
			32 1/2	824	K050317	62 3/8	1584	K050618
			32 3/4	831	K050321	63 1/8	1603	K050625
			33	837	K050323	63 5/8	1616	K050630
			33 1/4	843	K050326	64 1/8	1627	K050635
						64 5/8	1642	K050640
						65	1651	K050644

* Dual Sided Belt.

Century™ Series Micro-V® Belts - Listed by Size

Length (in)	Length (mm)	Belt No.	Length (in)	Length (mm)	Belt No.	Length (in)	Length (mm)	Belt No.
21/32" (17mm) Top Width			13/16" (20mm) Top Width			13/16" (20mm) Top Width		
- Continued			- Continued			- Continued		
65 1/4	1657	K050647	48 5/8	1235	K060480	72	1830	K060716
65 5/8	1667	K050650	48 7/8	1241	K060483	72 5/8	1845	K060721
65 7/8	1675	K050653	49 1/8	1248	K060486	72 3/4	1848	K060722
66 3/8	1687	K050658	49 1/2	1258	K060490	73	1853	* DK060718
66 3/4	1696	K050660	49 3/4	1265	K060492	73	1854	K060724
67 1/8	1704	K050665	50	1270	K060494	73 1/4	1859	K060725
69 5/8	1768	K050689	50 1/8	1274	K060495	73 1/8	1857	K060726A
69 3/4	1772	K050690	50 3/4	1288	K060500	73 1/2	1867	K060730
70	1778	K050694	51	1295	* DK060504	73 3/4	1872	* DK060725
71 1/8	1807	K050705	51	1297	K060505	73 7/8	1876	K060733
72 1/8	1831	K050715	51 1/8	1300	K060507	74 1/8	1881	K060735
72 5/8	1845	K050720	51 1/2	1309	K060509	74 1/4	1885	* DK060729
75 3/8	1914	K050750	51 3/4	1315	K060512	74 1/2	1893	K060739
76	1932	K050755	52	1321	K060514	75	1904	K060744
76 1/4	1937	K050757	52 1/8	1325	K060516	75 3/8	1914	K060747
78 3/8	1989	K050778	52 3/4	1339	K060520	75 5/8	1921	K060750
78 1/2	1994	K050780	52 7/8	1343	K060523	75 3/4	1924	K060751
82 1/2	2096	K050817	53	1348	* DK060519	76	1932	K060755
83 1/8	2112	K050825	53 3/8	1355	K060525	76 1/2	1942	K060760
84	2134	K050835	53 1/2	1359	K060529	76 7/8	1951	K060763
84 1/8	2138	K050836	53 7/8	1367	K060532	77	1957	K060764
85 1/8	2164	K050845	54 1/4	1379	K060535	77 3/8	1967	K060770
86 1/8	2187	K050855	54 1/2	1385	K060539	77 5/8	1971	K060771
89 1/8	2265	K050887	55	1397	K060544	77 7/8	1977	K060772
			55 1/4	1404	K060547	78	1982	K060775
			55 3/4	1415	K060551	78 5/8	1996	K060780
			56	1423	K060555	79	2007	K060785
			56 1/4	1429	K060557	79 1/8	2010	K060787
			56 1/2	1436	K060559	79 1/2	2018	K060790
			56 5/8	1439	K060560	80 1/8	2034	K060795
			56 7/8	1445	K060563	80 3/8	2040	K060798
			57 1/2	1462	K060569	80 3/8	2043	* DK060791
			57 7/8	1471	K060573	80 3/4	2051	K060802
			58	1473	K060575	81	2057	K060804
			58 3/8	1483	K060578	81 1/8	2061	K060806
			59 1/4	1504	K060586	81 5/8	2073	K060810
			59 3/8	1508	K060588	81 3/4	2076	K060812
			60	1523	K060594	82 1/8	2085	K060815
			60 3/8	1534	K060598	82 1/2	2093	K060819
			60 3/4	1542	K060602	82 1/2	2096	K060820
			60 7/8	1547	K060604	82 3/4	2102	K060822
			61 1/8	1553	K060605	83	2108	K060824
			61 1/2	1563	K060609	83 1/8	2112	K060825
			61 3/4	1569	K060612	83 1/4	2116	K060827
			62 1/8	1577	K060615	83 3/8	2119	K060828
			62 5/8	1591	K060620	83 3/4	2127	K060832
			62 7/8	1598	K060623	84	2134	K060834
			63 1/8	1603	K060625	84 1/4	2140	K060837
			63 3/8	1610	K060628	84 1/4	2140	K060837A
			63 5/8	1616	K060630	84 1/2	2147	K060840
			63 3/4	1619	K060631	84 1/2	2146	K060840A
			64 1/8	1627	K060635	84 5/8	2149	K060841
			64 3/8	1634	K060637	84 3/4	2153	K060842
			64 5/8	1642	K060640	85 1/4	2165	K060845
			64 3/4	1646	K060642	85 1/2	2171	K060849
			65	1651	K060645	85 5/8	2175	K060850
			65 1/2	1665	K060650	85 5/8	2175	K060851A
			65 3/4	1669	K060651	85 7/8	2182	K060854
			65 7/8	1674	K060653	86 3/8	2193	K060858
			66 1/8	1680	* DK060650	86 5/8	2201	K060860
			66 3/8	1687	K060658	86 5/8	2200	K060861A
			66 3/4	1696	K060660	86 7/8	2206	K060863
			66 7/8	1699	K060663	86 7/8	2208	K060864
			67 1/4	1708	K060667	87 1/4	2216	K060866
			67 1/2	1716	K060670	87 1/4	2216	K060867A
			67 3/4	1722	K060672	87 3/8	2219	K060868
			68	1728	K060675	87 5/8	2225	K060870
			68 1/2	1741	* DK060674	87 3/8	2232	* DK060867
			68 5/8	1742	K060680	87 7/8	2232	K060873A
			68 7/8	1750	K060682	87 7/8	2233	K060874
			69 1/8	1756	K060685	88 1/8	2238	K060875
			69 5/8	1767	K060690	88 1/8	2239	K060876
			70	1777	K060695	88 3/8	2245	K060878
			70 1/4	1783	K060696	88 1/2	2248	K060880A
			70 7/8	1799	K060703	88 7/8	2257	K060882
			71 1/8	1807	K060705	89	2261	K060883
			71 1/4	1811	* DK060702	89 1/8	2263	K060885
			71 1/2	1816	K060710	89	2261	K060885A
			71 5/8	1820	K060711	89 1/8	2265	K060886
			72	1829	K060714	89 1/2	2273	K060888
13/16" (20mm) Top Width								
29 1/2	748	K060288						
30 1/8	765	K060295						
31 1/4	793	K060305						
33 1/4	844	K060325						
33 3/4	856	K060331						
34 3/8	873	K060338						
34 3/4	881	K060340						
35 1/4	894	K060345						
35 7/8	911	K060352						
36 1/8	918	K060355						
37 1/8	943	K060365						
37 3/4	957	K060370						
38	964	K060374						
38 1/8	968	K060376						
38 3/8	975	K060378						
38 3/4	983	K060380						
39 1/8	993	K060385						
39 3/8	999	K060388						
39 3/4	1008	K060390						
39 7/8	1012	K060393						
40	1016	K060394						
40 3/4	1034	K060400						
41	1043	K060405						
41 1/4	1050	K060406						
41 3/8	1052	K060407						
41 1/2	1054	K060408						
41 5/8	1056	K060409						
41 3/4	1059	K060410						
42 1/8	1069	K060415						
42 3/8	1076	K060418						
42 1/2	1081	K060420						
42 7/8	1089	K060423						
43 1/8	1095	K060425						
43 1/8	1096	K060426						
43 1/2	1103	K060427						
43 3/4	1111	K060431						
43 7/8	1116	K060434						
44 1/8	1122	K060435						
44 1/2	1129	K060439						
44 3/4	1135	K060441						
45 1/8	1148	K060445						
45 3/8	1153	K060448						
45 5/8	1160	K060450						
46	1170	K060455						
46 3/8	1179	K060458						
46 5/8	1186	K060461						
47	1195	K060465						
47 3/8	1204	K060468						
47 5/8	1211	K060470						
47 7/8	1216	K060473						
47 7/8	1217	K060474						
48 1/4	1227	K060478						
48 1/2	1232	* DK060472						

* Dual Sided Belt.

Century™ Series Micro-V® Belts - Listed by Size

Length (in)	Length (mm)	Belt No.	Length (in)	Length (mm)	Belt No.	Length (in)	Length (mm)	Belt No.
13/16" (20mm) Top Width			13/16" (20mm) Top Width			15/16" (24mm) Top Width		
- Continued			- Continued			- Continued		
89 3/4	2278	K060891	137 7/8	3502	K061373	87 9/32	2217	7PK2217
90 1/8	2289	K060895	138 5/8	3519	K061380	87 7/8	2232	K070873
90 5/8	2301	K060900	138 5/8	3519	K061380A	88 1/2	2249	K070880
90 5/8	2302	*DK060901	142 1/2	3621	K061420	88 3/4	2255	K070882
90 7/8	2308	K060905	149 1/2	3799	K061490	89 1/8	2263	K070885
91 1/4	2318	K060908	13/16" (21mm) Top Width			89 1/8	2265	K070886
91 5/8	2329	K060910	46 27/32	1190	6PK1190	89 3/4	2278	K070890
91 3/4	2330	K060911A	65 1/2	1660	6PK1660	90 1/8	2289	K070896
92 1/8	2340	K060915	73	1856	6PK1856	90 5/8	2301	K070901
92 1/8	2340	K060916A	74 7/16	1877	6PK1880	90 7/8	2308	K070903
92 3/8	2347	K060919	73 7/8	1882	6PK1882	91 1/8	2314	K070905
92 7/8	2360	K060923	74 13/32	1890	6PK1890	92 1/4	2343	K070916
93 1/8	2364	K060926	82 3/8	2090	6PK2090	92 3/4	2357	K070922
93 5/8	2377	K060930	15/16" (24mm) Top Width			93	2362	K070924
94	2387	K060935	37 3/4	957	K070370	93 5/8	2378	K070931
94 1/2	2400	K060938	39 3/4	1008	K070390	95 3/4	2431	K070951
94 3/4	2407	K060942	41 1/4	1048	K070407	96 3/4	2457	K070961
95 1/8	2415	K060945	42	1068	K070415	97 3/4	2481	K070971
95 1/4	2419	K060947	43 1/8	1095	K070425	97 3/4	2484	K070975
95 5/8	2428	K060950	44 7/8	1140	K070443	98 1/8	2492	K070976
95 3/4	2432	*DK060956	45 3/8	1153	K070448	101 1/8	2568	K071005
95 3/4	2432	K060952	49 5/8	1261	K070491EMD	101 3/8	2576	K071009
96 1/8	2440	K060956	50 5/8	1286	K070500	101 7/8	2586	K071013
96 5/8	2453	K060960	51 1/8	1300	K070505	103 5/8	2633	K071031
96 7/8	2460	K060962	51 3/8	1305	K070508	104 1/4	2649	K071037
97 1/8	2468	K060966	54 1/2	1385	K070539	104 5/8	2656	K071040
97 5/8	2479	K060970	54 7/8	1394	*DK070536	105 1/8	2671	K071045
98 1/8	2492	K060975	55 7/8	1418	K070553	106 1/4	2699	K071056
98 5/8	2504	*DK060973	56 3/8	1432	*DK070551	107 1/8	2720	K071065
98 5/8	2505	K060980	57 1/4	1454	K070566	113 5/8	2886	K071130
99	2513	K060984	61 5/8	1564	K070610	114	2897	K071134
99 1/4	2520	K060986	62 1/8	1578	K070615	114 1/8	2899	*DK071135
99 1/2	2526	K060988	62 3/4	1594	K070622	114 5/8	2912	K071141
99 5/8	2531	K060990	63 3/8	1609	K070628	115 5/8	2936	K071150
99 7/8	2537	K060994	63 5/8	1616	K070630	116 1/4	2953	K071157
100	2539	K060995	64 5/8	1642	K070640	119 7/8	3046	K071194
100 1/4	2546	K060997	65	1651	K070644	125 3/8	3183	K071247
100 5/8	2555	K061000	66 1/2	1688	K070649	1 3/32" (28mm) Top Width		
100 3/4	2559	K061002	65 7/8	1675	K070653	30 3/4	781	K080300
101 1/8	2568	K061005	66	1678	K070655	33 3/4	856	K080330
101 5/8	2581	K061010	66 3/4	1695	K070663	34	864	K080334
102 1/8	2593	K061015	67 1/4	1708	K070667	36 3/4	932	K080360
102 1/4	2596	K061016	67 1/2	1716	K070669	37 1/8	943	K080365
102 5/8	2605	K061020	67 3/4	1722	K070673	37 3/4	957	K080370
103	2615	K061025	68 1/4	1734	K070677	38 1/8	968	K080375
103 5/8	2633	K061031	68 5/8	1743	K070680	38 3/4	983	K080382
103 7/8	2639	K061033	68 7/8	1750	K070683	39	990	K080384
104 1/4	2649	K061037	69 1/8	1756	K070685	39 3/4	1008	K080390
105	2666	K061045	69 1/2	1767	K070690	39 7/8	1014	K080392
105 1/2	2680	K061049	70	1779	K070694	40 3/4	1034	K080400
106	2692	K061054	70 3/4	1796	K070701	41 3/8	1051	K080408
106 3/8	2701	K061058	71 1/8	1807	K070705	42 1/8	1069	K080415
107 1/8	2722	K061066	71 1/2	1816	K070709	43	1091	K080424
107 7/8	2741	K061073	72	1829	K070714	43 1/2	1103	K080427
108 1/8	2746	K061075	72 3/4	1847	K070721	44 1/8	1122	K080435
108 3/4	2761	K061080	73 5/8	1870	K070730	45 5/8	1160	K080450
109 3/4	2788	K061093	73 3/4	1874	K070733	46	1170	K080455
109 3/8	2780	K061098	74 1/8	1883	K070735	46 3/8	1179	K080458
110 1/2	2807	K061099	75 5/8	1920	K070750	47	1195	K080465
111 1/8	2824	K061105	76	1930	7PK1930	47 3/4	1211	K080471
111 5/8	2835	K061110	76 1/8	1933	K070755	49 1/8	1249	K080485
111 7/8	2841	K061115	76 7/8	1951	K070763	49 5/8	1260	K080491
112 1/2	2859	K061120	78	1982	K070776	50 1/8	1274	K080496
112 7/8	2869	K061123	79 1/8	2011	K070786	51	1297	K080505
113 5/8	2886	K061130	80	2033	K070795	51 1/2	1309	K080510
114 1/2	2910	K061140	80 3/4	2051	K070801	52	1320	K080514
114 5/8	2911	K061141	81 5/8	2073	K070810	53 1/8	1351	K080525
115 1/4	2927	K061145	82 3/4	2102	K070822	53 1/2	1359	K080530
118 1/4	3005	K061177	82 7/8	2105	*DK070817	54	1370	*DK080534
119 1/4	3030	K061187	83 1/8	2112	K070825	54 1/4	1379	K080537
120 1/8	3051	K061195	83 5/8	2124	K070830	55 1/8	1399	K080545
120 7/8	3069	K061203	84	2133	K070834	55 3/4	1415	K080550
123 5/8	3137	K061230	84	2134	K070835	56 1/4	1429	K080558
125 1/4	3183	K061247	85 1/8	2164	7PK2164	56 5/8	1439	K080560
125 5/8	3192	K061251	85 1/4	2164	K070846	57	1448	K080565
127	3226	K061265	85 3/4	2178	K070852	57 1/8	1452	K080566
128 5/8	3267	K061280	86 1/8	2187	K070855	57 1/2	1462	K080570
130 3/8	3312	K061298				58 1/8	1475	K080575
136 1/2	3467	K061360						
137 1/2	3492	K061369						

* Dual Sided Belt.

Century™ Series Micro-V® Belts - Listed by Size

Length (in)	Length (mm)	Belt No.	Length (in)	Length (mm)	Belt No.	Length (in)	Length (mm)	Belt No.
1 3/32" (28mm) Top Width - Continued			1 3/32" (28mm) Top Width - Continued			1 3/8" (35mm) Top Width - Continued		
58 5/8	1490	K080580	96 1/4	2444	K080956	77 3/4	1976	K100771
59	1499	K080585	97 1/2	2475	K080968	79 1/2	2019	K100789
59 1/2	1512	K080590	98 5/8	2505	K080981	81 5/8	2073	K100810
60	1523	K080594	99 1/8	2519	K080986	84 5/8	2149	K100840
60 5/8	1538	K080600	99 5/8	2531	K080991	85 7/8	2182	K100852
61 1/8	1553	K080605	100 5/8	2555	K081000	89	2261	K100884
61 3/4	1569	K080610	101 1/8	2568	K081005	89 1/8	2264	K100886
62 1/8	1577	K080615	102 5/8	2605	K081020	89 3/4	2278	K100891
62 5/8	1591	K080620	102 7/8	2613	K081023	96	2438	K100955
62 7/8	1598	K080623	104	2642	K081035	98 1/8	2492	K100976
63 1/8	1603	K080626	105 3/4	2686	K081051	108 3/8	2753	K101078
63 5/8	1616	K080630	106 1/2	2705	K081059			
64 1/4	1633	K080635	108	2745	K081074	1 1/2" (38mm) Top Width		
65	1651	K080644	108 1/2	2756	K081079	84 3/4	2153	K110841
65 1/4	1657	K080645	109 3/8	2778	K081088	1 21/32" (42mm) Top Width		
65 1/2	1665	K080649	109 3/4	2788	K081092	28 3/4	730	K120281
65 7/8	1674	K080653	110 3/4	2814	K081102	36 5/8	929	K120360
66 1/4	1683	K080655	113	2869	K081124	39 3/4	1008	K120390
66 1/2	1691	K080660	115 1/8	2924	K081145	40 3/4	1034	K120400
66 3/4	1695	K080661A	116 1/4	2953	K081153	41 1/2	1054	K120410
67 1/8	1705	K080665	118 1/4	3005	K081177	46 1/4	1175	K120457
67 1/2	1716	K080670	119 1/2	3035	K081189	48 1/4	1226	K120477
67 3/4	1722	K080672	120 1/8	3050	K081196	53 1/8	1351	K120525
68	1728	K080675	121 3/8	3082	K081207	56 1/2	1436	K120559
68 1/4	1734	K080677	121 7/8	3096	K081213	60	1523	K120594
68 5/8	1742	K080680	122 3/4	3117	K081223	61 1/8	1553	K120606
69 1/8	1756	K080685	125 7/8	3198	K081253	61 3/4	1569	K120610
69 5/8	1767	K080690	126	3200	* DK081254	70 3/4	1798	K120702
70	1777	K080694	127	3227	K081264	72 5/8	1845	K120720
70 1/2	1789	K080700	127 1/8	3228	K081265	74	1880	K120734
70 3/4	1798	K080702	130 3/8	3312	K081298	74 3/8	1889	K120738
71 1/4	1811	K080708	133 1/8	3381	K081325	79	2007	K120784
71 1/2	1816	K080710	133 3/4	3396	K081331	82	2083	K120815
72 1/8	1831	K080716	135 3/8	3439	K081348	84 3/4	2154	K120842
72 5/8	1845	K080720	136 1/2	3468	K081359	85 3/4	2178	K120852
73 1/4	1859	K080726	136 3/4	3499	K081362	86 3/8	2194	K120858
73 1/2	1867	K080730	138 1/4	3513	K081377	86 7/8	2208	K120864
73 3/4	1874	K080733	140 7/8	3579	* DK081403	87 3/4	2230	K120872
74	1880	K080734	149 1/2	3799	K081490	88 3/8	2245	K120878
74 3/8	1889	K080738	1 7/32" (31mm) Top Width			89 5/8	2278	K120891
74 5/8	1896	K080740	50 1/2	1282	K090500	90 5/8	2301	K120901
75 1/8	1907	K080745	61 1/2	1562	K090609	90 7/8	2308	K120903
75 5/8	1921	K080751	1 3/8" (35mm) Top Width			91 3/4	2329	K120911
76	1931	K080755	38 3/4	983	K100381	92 1/8	2340	K120915
76 1/2	1942	K080760	44 1/4	1124	K100437	92 1/2	2350	K120919
77	1957	K080765	45 1/8	1148	K100445	93 1/8	2364	K120924
77 3/4	1976	K080774	46 1/8	1173	K100456	93 3/4	2381	K120931
78 1/8	1985	K080776	47	1195	K100465	97	2463	K120964
78 5/8	1996	K080780	48 7/8	1241	K100485	98 1/8	2492	K120979
79	2007	K080785	50 1/8	1274	K100495	104 1/2	2654	K121039
79 1/2	2019	K080790	50 3/4	1288	K100502	1 15/16" (49mm) Top Width		
80 1/8	2037	K080797	51 1/2	1309	K100510	35	890	K140345
80 7/8	2054	K080803	54	1373	K100535	35 7/8	910	K140352
81 1/8	2061	K080806	54 1/2	1385	K100540	37 1/2	954	K140370
81 5/8	2073	K080810	56	1423	K100554	43 1/2	1106	K140429
82 1/8	2086	K080816	56 7/8	1444	K100563	43 7/8	1116	K140433
82 3/8	2091	K080817	57 1/2	1462	K100570	45 5/8	1160	K140451
82 3/4	2100	K080820	57 7/8	1469	K100572	50 1/8	1274	K140496
83 1/8	2112	K080825	58 1/8	1475	K100575	52 1/8	1325	K140516
83 3/4	2127	K080830	58 1/2	1487	K100579	53 1/8	1350	K140524
84 3/8	2144	K080839	60	1523	K100594	56	1422	K140555
84 3/4	2154	K080842	61 1/4	1557	K100607	58 5/8	1490	K140580
86 1/8	2187	K080855	61 5/8	1564	K100610	60	1523	K140594
86 3/8	2195	K080859	62 3/8	1585	K100618	60 3/8	1534	K140597
87 1/8	2212	K080865	63 5/8	1616	K100630	60 7/8	1546	K140603
87 3/4	2230	K080872	64 1/4	1633	K100637	62 3/8	1585	K140618
88 1/8	2240	K080876	64 5/8	1642	K100640	63 3/8	1609	K140627
88 3/8	2245	K080878	66	1678	K100655	66 3/4	1696	K140662
89 7/8	2282	K080893	66 3/8	1687	K100658	68 3/4	1746	K140682
90 3/8	2295	K080897	67 1/8	1704	K100665	70 1/2	1789	K140700
90 7/8	2308	K080903	67 1/2	1716	K100670	2 1/16" (53mm) Top Width		
91 1/4	2318	K080907	68	1728	K100675	76 3/8	1942	K150759
91 5/8	2326	K080910	68 1/4	1734	K100677			
91 7/8	2334	K080913	68 3/8	1737	* DK100672			
92 1/8	2340	K080915	70	1778	K100694			
92 3/4	2355	K080922	71 1/2	1816	K100710			
93 1/8	2367	K080926	72 3/8	1840	K100719			
93 7/8	2384	K080934	73 5/8	1871	K100731			
94 1/2	2400	K080939	74 1/2	1893	K100739			
95	2412	K080944	75 1/2	1918	K100749			
95 3/8	2424	K080948						
95 3/4	2432	K080952						

* Dual Sided Belt.

Special Belts - Listed by Number

Showing Belt Numbers with Corresponding Nominal Outside Lengths and Top Widths

Belt No.	Length (in)	Length (mm)	Top Width (in)	Top Width (mm)	Belt No.	Length (in)	Length (mm)	Top Width (in)	Top Width (mm)
811.....	★ 22 1/2	572	1 1/8	29	6007.....	▼ 52	1320	1 3/16	30
813.....	★ 26 3/4	679	1 1/8	29	6012.....	▼ 33 3/8	848	29/32	23
814.....	★ 31 1/2	800	1 1/8	29	6013.....	▼ 36 3/4	933	29/32	23
822.....	★ 36	914	1	25	6021.....	▼ 41 3/4	1059	1 3/16	30
5500.....	▼ 56 1/4	1430	3/4	19	6044.....	▼ 44 1/8	1120	1 3/16	30
5501.....	71	1805	3/4	19	6061.....	▼ 27 1/4	691	5/8	16
5502.....	64 3/4	1645	3/4	19	6069.....	▼ 43 1/8	1095	1 7/32	31
5503.....	52	1320	3/4	19	6077.....	▼ 41 3/4	1060	1 7/32	31
5504.....	65	1650	3/4	19	6078.....	▼ 40 3/4	1035	1 7/32	31
5506.....	132	3355	21/32	17	6079.....	▼ 37 3/8	949	1 1/32	26
5508.....	59	1500	3/8	10	6083.....	▼ 43 1/2	1105	1 3/16	30
5509.....	81	2055	3/8	10	6092.....	▼ 45 1/2	1156	1 1/4	32
5510.....	▼ 35 1/8	890	1/2	13	6096.....	▼ 46 5/8	1186	1 1/4	32
5511.....	54	1370	3/4	19	6098.....	▼ 40 3/8	1026	1 3/16	30
5512.....	67 1/8	1705	3/4	19	6183.....	★ 15 1/2	395	5/16	8
5513.....	55	1395	3/4	19	6224.....	▼ 48 3/8	1229	1/2	13
5516.....	◇ 58 1/2	1485	1/2	13	6234.....	◇ 71 1/2	1815	1/2	13
5517.....	93 5/8	2378	1/2	13	6304.....	▼ 47	1194	1 1/4	32
5518.....	▼ 93 1/8	2365	1/2	13	6312.....	▼ 36 7/8	937	1 1/4	31
5520.....	53	1346	3/4	19	6314.....	▼ 45	1143	1 3/16	30
5521.....	50	1270	3/4	19	6316.....	▼ 56 1/8	1425	1 3/16	30
5522.....	60 1/2	1535	3/4	19	6354 (180 Teeth).....	✱ 56 3/4	1440	25/32	20
5523.....	164	4165	21/32	17	6370.....	31 7/8	810	1/2	13
5524.....	115 1/2	2935	21/32	17	6372.....	38 3/4	974	1/2	13
5525.....	118	3075	21/32	17	6375.....	◇ 74 3/8	1890	1/2	13
5526.....	142	3605	21/32	17	6376.....	36 3/4	933	1/2	13
5527.....	◇ 53 3/4	1363	1/2	13	6377.....	79 3/4	2025	1/2	13
5528.....	58	1475	1/2	13	6378.....	103 1/4	2625	1/2	13
5529.....	▼ 42 7/8	1090	21/32	17	6379.....	108 1/8	2745	1/2	13
5530.....	▼ 67 1/8	1705	1/2	13	6380.....	25 3/8	645	3/8	10
5533.....	51 7/8	1320	21/32	17	6384 (153 Teeth).....	✱ 48 1/4	1225	1	25
5534.....	69	1753	21/32	17	6385 (140 Teeth).....	✱ 44 1/8	1120	1	25
5535.....	155	3935	21/32	17	6386 (130 Teeth).....	✱ 41	1040	1	25
5536.....	34 1/8	865	1/2	13	6387.....	127 1/8	3230	1/2	13
5537.....	86 7/8	2205	21/32	17	6389.....	49 1/8	1245	1/4	6
5538.....	113 1/2	2880	21/32	17	6390.....	34 3/8	873	3/8	10
5539.....	▼ 76 7/8	1955	1 1/4	32	6391.....	32 1/2	825	1/4	6
5700.....	68 1/4	1735	1/2	13	6392.....	32	815	1/4	6
5701.....	110 1/2	2805	1/2	13	6398.....	117 1/8	2975	1/2	13
5707 (167 Teeth).....	✱ 19 3/4	501	19/32	15	6413 (65 Teeth).....	✱ 24 3/8	619	3/8	10
5710.....	▼ 35 3/8	900	1 3/16	30	6414 (61 Teeth).....	✱ 22 7/8	581	3/8	10
5716 (220 Teeth).....	✱ 69 9/32	1760	25/32	20	6421 (68 Teeth).....	✱ 25 1/2	650	5/16	8
5718.....	44 5/8	1135	1 1/4	32	6548.....	83 1/8	2110	1/2	13
5724.....	54 7/8	1395	1/2	13	6550.....	120 1/4	3055	1/2	13
5725.....	48 7/8	1230	7/16	11	6560.....	126 1/8	3205	1/2	13
5726.....	57 3/8	1455	1/2	13	6565.....	107 1/4	2725	1/2	13
5731.....	35 1/2	900	3/8	10	6572.....	▼ 62 7/8	1590	1 1/8	29
5732.....	35 3/4	910	3/8	10	6574.....	64 1/4	1630	1/2	13
5734.....	45 1/4	1150	1/2	13	6575.....	54 1/4	1377	1/2	13
5735.....	37 7/8	960	1/2	13	6582.....	90 5/8	2350	1/2	13
5736.....	39	990	1/2	13	6583.....	34 1/2	875	1/2	13
5737.....	48	1220	1/2	13	6589.....	29 3/4	755	3/8	10
5738.....	49 3/8	1255	1/2	13	6596.....	44	1120	7/16	11
5740.....	54	1370	1/2	13	6597.....	57	1450	7/16	11
5741.....	36 1/2	925	1/2	13	6599.....	▼ 86 5/8	2200	1 15/32	33
5742.....	44 3/4	1135	1/2	13	6601.....	53	1346	1 1/8	29
5743.....	43 7/8	1115	1/2	13	6604.....	157	3988	7/8	22
5744.....	53 3/8	1355	1/2	13	6698.....	48 1/32	1220	9/32	7

◇ Double-V Belt.
★ Flat Belt. Length Given Is Inside Circumference.

▼ Notched Belt.
✱ Synchronous Belt. Length Given is Pitch Length.

Showing Nominal Belt Top Widths and Outside Lengths with Our Corresponding Belt Numbers

Length (in)	Length (mm)	Belt No.	Length (in)	Length (mm)	Belt No.	Length (in)	Length (mm)	Belt No.
3/16" (5mm) Top Width			1/2" (13mm) Top Width			7/8" (22mm) Top Width		
32	815	6392	- Continued			157	3988	6604
32 1/2	825	6391	68 1/4	1735	5700	29/32" (23mm) Top Width		
49 1/8	1245	6389	71 1/2	1815	◇ 6234	33 3/8	848	▼ 6012
9/32" (7mm) Top Width			74 3/8	1890	◇ 6375	36 3/4	933	▼ 6013
48 1/32	1220	6698	79 3/4	2025	6377	1" (25mm) Top Width		
5/16" (8mm) Top Width			83 1/8	2110	6548	36	914	★ 822
15 1/2	395	★ 6183	90 5/8	2350	6582	41	1040	❖ 6386
25 1/2	650	❖ 6421 (68 Teeth)	93 1/8	2365	▼ 5518	44 1/8	1120	❖ 6385 (130 Teeth)
3/8" (10mm) Top Width			103 1/4	2625	6378	48 1/4	1225	❖ 6384 (140 Teeth)
22 7/8	581	❖ 6414 (61 Teeth)	107 1/4	2725	6565	1 1/32" (26mm) Top Width		
24 3/8	619	❖ 6413 (65 Teeth)	108 1/8	2745	6379	37 3/8	949	▼ 6079
25 3/8	645	6380	110 1/2	2805	5701	1 1/8" (29mm) Top Width		
29 3/4	755	6589	117 1/8	2975	6398	22 1/2	572	★ 811
34 3/8	873	6390	120 1/4	3055	6550	26 3/4	679	★ 813
35 1/2	900	5731	126 1/8	3205	6560	31 1/2	800	★ 814
35 3/4	910	5732	127 1/8	3230	6387	53	1346	6601
59	1500	5508	19/32" (15mm) Top Width			62 7/8	1590	▼ 6572
81	2055	5509	19 3/4	501	❖ 5707 (167 Teeth)	1 3/16" (30mm) Top Width		
7/16" (11mm) Top Width			5/8" (16mm) Top Width			35 3/8	900	▼ 5710
44	1120	6596	27 1/4	691	▼ 6061	40 3/8	1026	▼ 6098
48 7/8	1230	5725	21/32" (17mm) Top Width			41 3/4	1059	▼ 6021
57	1450	6597	42 7/8	1090	▼ 5529	43 1/2	1105	▼ 6083
1/2" (13mm) Top Width			51 7/8	1320	5533	44 1/8	1120	▼ 6044
31 7/8	810	6370	69	1753	5534	45	1143	▼ 6314
34 1/8	865	5536	86 7/8	2205	5537	52	1320	▼ 6007
34 1/2	875	6583	113 1/2	2880	5538	56 1/8	1425	▼ 6316
35 1/8	890	▼ 5510	115 1/2	2935	5524	1 7/32" (31mm) Top Width		
36 1/2	925	5741	118	3075	5525	36 7/8	937	▼ 6312
36 3/4	933	6376	132	3355	5506	40 3/4	1035	▼ 6078
37 7/8	960	5735	142	3605	5526	41 3/4	1060	▼ 6077
38 3/4	974	6372	155	3935	5535	43 1/8	1095	▼ 6069
39	990	5736	164	4165	5523	1 1/4" (32mm) Top Width		
43 7/8	1115	5743	3/4" (19mm) Top Width			44 5/8	1135	5718
44 3/4	1135	5742	50	1270	5521	45 1/2	1156	▼ 6092
45 1/4	1150	5734	52	1320	5503	46 5/8	1186	▼ 6096
48	1220	5737	53	1346	5520	47	1194	▼ 6304
48 3/8	1229	▼ 6224	54	1370	5511	76 7/8	1955	▼ 5539
49 3/8	1255	5738	55	1395	5513	1 15/32" (33mm) Top Width		
53 3/8	1355	5744	56 1/4	1430	▼ 5500	86 5/8	2200	▼ 6599
53 3/4	1363	◇ 5527	60 1/2	1535	5522			
54	1370	5740	64 3/4	1645	5502			
54 1/4	1377	6575	65	1650	5504			
54 7/8	1395	5724	67 1/8	1705	5512			
57 3/8	1455	5726	71	1805	5501			
58	1475	5528	25/32" (20mm) Top Width					
58 1/2	1485	◇ 5516	56 3/4	1440	❖ 6354 (180 Teeth)			
64 1/4	1630	6574	69 9/32	1760	5716			
67 1/8	1705	▼ 5530						

◇ Double-V Belt.
★ Flat Belt. Length Given Is Inside Circumference.

▼ Notched Belt.
❖ Synchronous Belt. Length Given is Pitch Length.

Showing Hi-Power® II Belts with Corresponding Top Widths and Nominal Outside Lengths

PLEASE NOTE: V-Belt drives which use the belt as a clutch requires special consideration because the heat generated by belt slip (during engagement and disengagement) on some clutching applications can cause the V-Belt tensile materials in the belts listed below to shrink in length. The shrinkage may cause a belt, which is already engaged and driving, to not de-clutch, or a de-clutched belt may engage itself and start driving the machine unexpectedly. Depending on the machine and circumstances, either situation could prove dangerous to the machine operator or bystanders.

Belts especially designed to minimize or eliminate heat shrinkage may be required.

IMPORTANT: The outside length is determined by placing a steel tape around the outside of the belt. This method should be used because it is the one most commonly used by Dealers and Jobbers when measuring a belt.

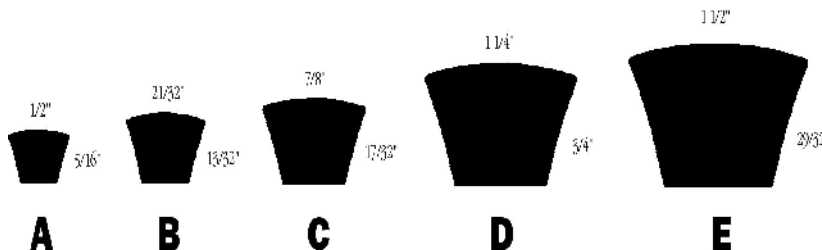

Belt No.	Length (in)	Belt No.	Length (in)	Belt No.	Length (in)	Belt No.	Length (in)	Belt No.	Length (in)
A Section		A Section - Cont.		A Section - Cont.		B Section - Cont.		B Section - Cont.	
A24.....	26	A67.....	69	A115.....	117	B53.....	56	B97.....	100
A25.....	27	A68.....	70	A116.....	118	B54.....	57	B98.....	101
A26.....	28	A69.....	71	A117.....	119	B55.....	58	B99.....	102
A27.....	29	A70.....	72	A118.....	120	B56.....	59	B100.....	103
A28.....	30	A71.....	73	A120.....	122	B57.....	60	BP100 (Aramid).....	103
A29.....	31	A72.....	74	A124.....	126	B58.....	61	B101.....	104
A29.8.....	31 13/16	A73.....	75	A128.....	130	B59.....	62	B102.....	105
A30.....	32	A74.....	76	A130.....	132	B60.....	63	B103.....	106
A31.....	33	A75.....	77	A132.....	134	B61.....	64	B104.....	107
A32.....	34	A76.....	78	A133.....	135	B62.....	65	B105.....	108
A33.....	35	A77.....	79	A134.....	136	B63.....	66	B106.....	109
A34.....	36	A78.....	80	A136.....	138	B64.....	67	B107.....	110
A35.....	37	A79.....	81	A140.....	142	B65.....	68	B108.....	111
A36.....	38	A80.....	82	A144.....	146	B66.....	69	BP108 (Aramid).....	111
A37.....	39	A81.....	83	A148.....	150	B67.....	70	B109.....	112
A38.....	40	A82.....	84	A158.....	160	B68.....	71	B110.....	113
A39.....	41	A83.....	85	A173.....	175	B69.....	72	B111.....	114
A40.....	42	A84.....	86	A180.....	182	B70.....	73	B112.....	115
A41.....	43	A85.....	87	B Section		B71.....	74	B113.....	116
A42.....	44	A86.....	88	B28.....	31	B72.....	75	B114.....	117
A43.....	45	A87.....	89	B29.....	32	B73.....	76	B115.....	118
A44.....	46	A88.....	90	B30.....	33	B74.....	77	B116.....	119
A45.....	47	A89.....	91	B31.....	34	B75.....	78	B117.....	120
A46.....	48	A90.....	92	B32.....	35	B76.....	79	B118.....	121
A47.....	49	A91.....	93	B33.....	36	B77.....	80	B119.....	122
A48.....	50	A92.....	94	B34.....	37	B78.....	81	B120.....	123
A49.....	51	A93.....	95	B35.....	38	B79.....	82	B121.....	124
A50.....	52	A94.....	96	B36.....	39	B80.....	83	B122.....	125
A51.....	53	A95.....	97	B37.....	40	B81.....	84	B123.....	126
A52.....	54	A96.....	98	B38.....	41	B82.....	85	B124.....	127
A53.....	55	A97.....	99	B39.....	42	B83.....	86	B125.....	128
A54.....	56	A98.....	100	B40.....	43	B84.....	87	B126.....	129
A55.....	57	A99.....	101	B41.....	44	B85.....	88	B127.....	130
A56.....	58	A100.....	102	B42.....	45	B86.....	89	B128.....	131
A57.....	59	A101.....	103	B43.....	46	B87.....	90	B129.....	132
A58.....	60	A102.....	104	B44.....	47	B88.....	91	B130.....	133
A59.....	61	A103.....	105	B45.....	48	B89.....	92	B131.....	134
A60.....	62	A105.....	107	B46.....	49	B90.....	93	B132.....	135
A61.....	63	A106.....	108	B47.....	50	B91.....	94	B133.....	136
A62.....	64	A107.....	109	B48.....	51	B92.....	95	B134.....	137
A63.....	65	A108.....	110	B49.....	52	B93.....	96	B135.....	138
A64.....	66	A110.....	112	B50.....	53	B94.....	97	B136.....	139
AP64 (Aramid).....	66	A112.....	114	B51.....	54	B95.....	98	B137.....	140
A65.....	67	A113.....	115	B52.....	55	BP95 (Aramid).....	98	B138.....	141
A66.....	68	A114.....	116			B96.....	99	B139.....	142
								B140.....	143
								B141.....	144
								B142.....	145
								B143.....	146
								B144.....	147
								B145.....	148
								B146.....	149

Size Lists

Hi-Power® II V-Belts - Listed by Number

Belt No.	Length (in)	Belt No.	Length (in)	Belt No.	Length (in)	Belt No.	Length (in)
B Section - Cont.		C Section - Cont.		C Section - Cont.		C Section - Cont.	
B147.....	150	C53.....	57	C101.....	105	C195.....	199
B148.....	151	C54.....	58	C103.....	107	C210.....	214
B150.....	153	C55.....	59	C105.....	109	C225.....	227
B152.....	155	C57.....	61	CP105 (Aramid).....	109	C240.....	242
B154.....	157	C60.....	64	C106.....	110	C255.....	257
B156.....	159	C62.....	66	C107.....	111	C270.....	272
B158.....	161	C63.....	67	C108.....	112	C285.....	287
B162.....	165	C65.....	69	C109.....	113	C300.....	302
B166.....	169	C67.....	71	C110.....	114	C315.....	317
B168.....	171	C68.....	72	C111.....	115	C330.....	332
B173.....	176	C70.....	74	C112.....	116	C345.....	347
B180.....	183	C71.....	75	C115.....	119	C360.....	362
B188.....	191	C72.....	76	C116.....	120	C390.....	392
B190.....	193	C73.....	77	C120.....	124	C420.....	422
B192.....	195	C75.....	79	C122.....	126		
B195.....	198	C78.....	82	C124.....	128	D Section	
B199.....	202	C79.....	83	C126.....	130	D100.....	105
B205.....	208	C80.....	84	C128.....	132	D105.....	110
B210.....	213	C81.....	85	C130.....	134	D112.....	117
B225.....	226	C83.....	87	C136.....	140	D120.....	125
B230.....	231	C84.....	88	C140.....	144	D128.....	133
B240.....	241	C85.....	89	C144.....	148	D136.....	141
B255.....	256	C86.....	90	C148.....	152	D144.....	149
B270.....	271	C87.....	91	C150.....	154	D158.....	163
B285.....	286	C90.....	94	C151.....	155	D162.....	167
B300.....	301	C92.....	96	C152.....	156 3/4	D173.....	178
B315.....	316	C93.....	97	C156.....	160	D180.....	185
		C95.....	99	C158.....	162	D195.....	200
C Section		C96.....	100	C162.....	166	D210.....	215
C48.....	52	C97.....	101	C170.....	174	D225.....	228
C50.....	54	C98.....	102	C173.....	177	D240.....	243
C51.....	55	C99.....	103	C180.....	184	D255.....	258
		C100.....	104	C190.....	194		
						E Section	
						E180.....	187
						E195.....	202
						E210.....	217
						E240.....	244
						E270.....	274
						E300.....	304
						E330.....	334
						E360.....	364
						E390.....	394
						E420.....	424
						E480.....	484
						E540.....	544
						E600.....	604
						E660.....	664

Key to Size Numbering System

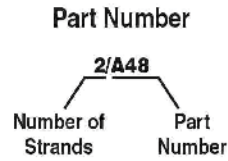

The part number is constructed by placing the number of strands required followed by a slash in front of the size.

In the example above **2/** is the number of strands, **A48** is the belt size.

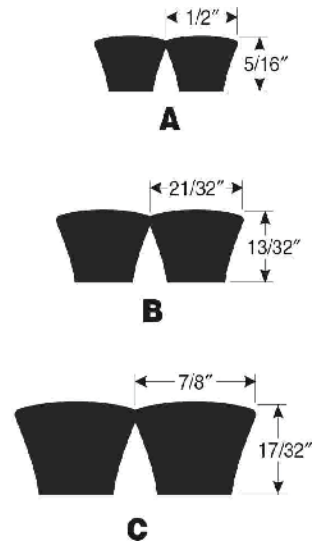

Belt No.	Nominal Outside Length (in)	Belt No.	Nominal Outside Length (in)	Belt No.	Nominal Outside Length (in)
A Section		B Section - Continued		B Section - Continued	
2/A36.....	38	2/B68.....	71	2/B99.....	102
2/A48.....	50	2/B75.....	78	2/B148.....	151
2/A74.....	76	2/B80.....	83	2/B162.....	165
3/A55.....	57	2/B85.....	88	3/B81.....	84
3/A85.....	87	2/B86.....	89	C Section	
B Section		2/B90.....	93	2/C90.....	94
2/B61.....	64	2/B92.....	95		
2/B64.....	67	2/B93.....	96		
		2/B95.....	98		

Showing Super HC® and Super HC® Molded Notch Belts with Corresponding Top Widths and Outside Lengths

IMPORTANT: The outside length is determined by placing a steel tape around the outside of the belt. This method should be used because it is the one most commonly used by Dealers and Jobbers when measuring a belt.

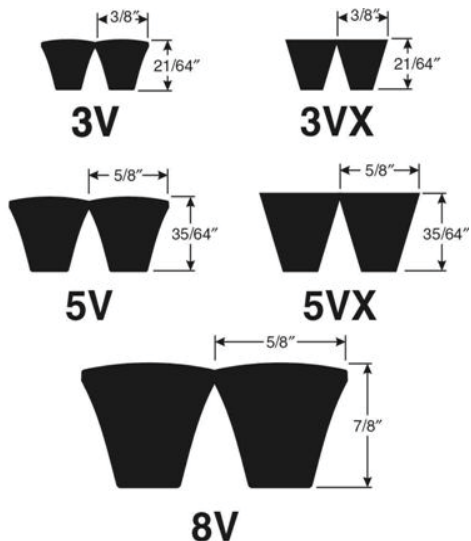

Belt No.	Length (in)	Belt No.	Length (in)	Belt No.	Length (in)	Belt No.	Length (in)	Belt No.	Length (in)
3V/3VX		3V/3VX - Cont.		5V/5VX - Cont.		5V/5VX - Cont.		8V	
3V250	25	3VX355	35 1/2	5V900	90	5VX630	63	8V1000	100
3V265	26 1/2	3VX375	37 1/2	5V950	95	5VX650	65	8V1060	106
3V280	28	3VX400	40	5V1000	100	5VX660	66	8V1120	112
3V300	30	3VX425	42 1/2	5V1060	106	5VX670	67	8V1180	118
3V315	31 1/2	3VX450	45	5V1120	112	5VX680	68	8V1250	125
3V335	33 1/2	3VX475	47 1/2	5V1180	118	5VX690	69	8V1320	132
3V355	35 1/2	3VX500	50	5V1250	125	5VX710	71	8V1400	140
3V375	37 1/2	3VX520	52	5V1320	132	5VX730	73	8V1500	150
3V400	40	3VX530	53	5V1400	140	5VX740	74	8V1600	160
3V425	42 1/2	3VX550	55	5V1500	150	5VX750	75	8V1700	170
3V450	45	3VX560	56	5V1600	160	5VX780	78	8V1800	180
3V475	47 1/2	3VX600	60	5V1700	170	5VX800	80	8V1900	190
3V500	50	3VX630	63	5V1800	180	5VX810	81	8V2000	200
3V530	53	3VX670	67	5V1900	190	5VX830	83	8V2120	212
3V560	56	3VX710	71	5V2000	200	5VX840	84	8V2240	224
3V600	60	3VX750	75	5V2120	212	5VX850	85	8V2360	236
3V630	63	3VX800	80	5V2240	224	5VX860	86	8V2500	250
3V670	67	3VX850	85	5V2360	236	5VX880	88	8V2650	265
3V710	71	3VX900	90	5V2500	250	5VX900	90	8V2800	280
3V750	75	3VX950	95	5V2650	265	5VX930	93	8V3000	300
3V800	80	3VX1000	100	5V2800	280	5VX950	95	8V3150	315
3V850	85	3VX1060	106	5V3000	300	5VX960	96	8V3350	335
3V900	90	3VX1120	112	5V3150	315	5VX1000	100	8V3550	355
3V950	95	3VX1180	118	5V3350	335	5VX1030	103	8V3750	375
3V1000	100	3VX1250	125	5V3550	355	5VX1060	106	8V4000	400
3V1060	106	3VX1320	132	5VX450	45	5VX1080	108	8V4250	425
3V1120	112	3VX1400	140	5VX470	47	5VX1120	112	8V4500	450
3V1180	118			5VX490	49	5VX1150	115	8V4750	475
3V1250	125			5VX500	50	5VX1180	118	8V5000	500
3V1320	132			5VX510	51	5VX1230	123	8V5600	560
3V1400	140			5VX530	53	5VX1250	125		
3V1500	150			5VX540	54	5VX1320	132		
3VX250	25			5VX550	55	5VX1400	140		
3VX265	26 1/2			5VX560	56	5VX1500	150		
3VX280	28			5VX570	57	5VX1600	160		
3VX300	30			5VX580	58	5VX1700	170		
3VX315	31 1/2			5VX590	59	5VX1800	180		
3VX335	33 1/2			5VX600	60	5VX1900	190		
3VX350	35			5VX610	61	5VX2000	200		

Key to Size Numbering System

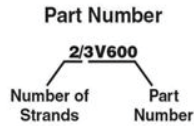

The part number is constructed by placing the number of strands required followed by a slash in front of the size.

In the example above **2** is the number of strands, **3V600** is the belt size.

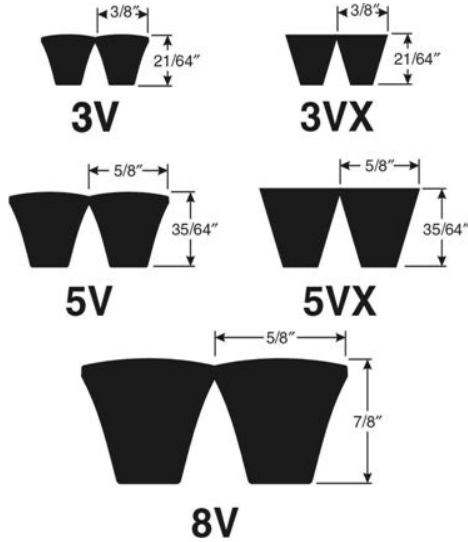

Belt No.	Nominal Outside Length (in)	Belt No.	Nominal Outside Length (in)	Belt No.	Nominal Outside Length (in)
3V/3VX Section		5V/5VX Section		5V/5VX Section - Cont.	
2/3V600.....	60	2/5V950.....	95	2/5VX930.....	93
2/3VX375.....	37 1/2	2/5V975.....	97 1/2	2/5VX950.....	95
2/3VX475.....	47 1/2	2/5VX560.....	56	2/5VX1000.....	100
2/3VX500.....	50	2/5VX600.....	60	2/5VX1042.....	105 1/4
2/3VX630.....	63	2/5VX670.....	67	2/5VX1075.....	108 1/8
3/3V879.....	87 27/32	2/5VX686.....	69 1/4	2/5VX1400.....	140
3/3V910.....	91	2/5VX710.....	71	3/5VP213.68.....	213 11/16
3/3VX500.....	50	2/5VX800.....	80	3/5VP2000.....	200
3/3VX560.....	56	2/5VX830.....	83	5/5VX800.....	80
4/3VX425.....	42 1/2	2/5VX850.....	85		
		2/5VX917.....	91 3/4		

Showing Tri-Power® Belts with Corresponding Top Widths and Outside Lengths

PLEASE NOTE: V-Belt drives which use the belt as a clutch requires special consideration because the heat generated by belt slip (during engagement and disengagement) on some clutching applications can cause the V-Belt tensile materials in the belts listed below to shrink in length. The shrinkage may cause a belt, which is already engaged and driving, to not de-clutch, or a de-clutched belt may engage itself and start driving the machine unexpectedly. Depending on the machine and circumstances, either situation could prove dangerous to the machine operator or bystanders.

Belts especially designed to minimize or eliminate heat shrinkage may be required.

IMPORTANT: The outside length is determined by placing a steel tape around the outside of the belt. This method should be used because it is the one most commonly used by Dealers and Jobbers when measuring a belt.



Belt No.	Length (in)	Belt No.	Length (in)	Belt No.	Length (in)	Belt No.	Length (in)	Belt No.	Length (in)
AX Section		AX Section - Cont.		BX Section - Cont.		BX Section - Cont.		BX Section - Cont.	
AX21.....	23	AX65.....	67	BX34.....	37	BX79.....	82	BX240.....	242
AX22.....	24	AX66.....	68	BX35.....	38	BX80.....	83	BX255.....	257
AX23.....	25	AX67.....	69	BX36.....	39	BX81.....	84	BX270.....	272
AX24.....	26	AX68.....	70	BX37.....	40	BX82.....	85	BX300.....	302
AX25.....	27	AX69.....	71	BX38.....	41	BX83.....	86	CX Section	
AX26.....	28	AX70.....	72	BX40.....	43	BX84.....	87	CX51.....	55
AX27.....	29	AX71.....	73	BX41.....	44	BX85.....	88	CX60.....	64
AX28.....	30	AX72.....	74	BX42.....	45	BX86.....	89	CX68.....	72
AX29.....	31	AX73.....	75	BX43.....	46	BX87.....	90	CX75.....	79
AX30.....	32	AX74.....	76	BX44.....	47	BX88.....	91	CX81.....	85
AX31.....	33	AX75.....	77	BX45.....	48	BX89.....	92	CX85.....	89
AX32.....	34	AX76.....	78	BX46.....	49	BX90.....	93	CX90.....	94
AX33.....	35	AX77.....	79	BX47.....	50	BX91.....	94	CX96.....	100
AX34.....	36	AX78.....	80	BX48.....	51	BX92.....	95	CX100.....	104
AX35.....	37	AX79.....	81	BX49.....	52	BX93.....	96	CX101.....	105
AX36.....	38	AX80.....	82	BX50.....	53	BX94.....	97	CX105.....	109
AX37.....	39	AX81.....	83	BX51.....	54	BX95.....	98	CX106.....	110
AX38.....	40	AX82.....	84	BX52.....	55	BX96.....	99	CX109.....	113
AX39.....	41	AX85.....	87	BX53.....	56	BX97.....	100	CX112.....	116
AX40.....	42	AX86.....	88	BX54.....	57	BX99.....	102	CX115.....	119
AX41.....	43	AX87.....	89	BX55.....	58	BX100.....	103	CX120.....	124
AX42.....	44	AX88.....	90	BX56.....	59	BX103.....	106	CX123.....	127
AX43.....	45	AX90.....	92	BX57.....	60	BX105.....	108	CX128.....	132
AX44.....	46	AX91.....	93	BX58.....	61	BX108.....	111	CX133.....	137
AX45.....	47	AX92.....	94	BX59.....	62	BX112.....	115	CX136.....	140
AX46.....	48	AX93.....	95	BX60.....	63	BX113.....	116	CX144.....	148
AX47.....	49	AX94.....	96	BX61.....	64	BX115.....	118	CX150.....	154
AX48.....	50	AX96.....	98	BX62.....	65	BX116.....	119	CX158.....	162
AX49.....	51	AX97.....	99	BX63.....	66	BX120.....	123	CX162.....	166
AX50.....	52	AX98.....	100	BX64.....	67	BX124.....	127	CX173.....	177
AX51.....	53	AX103.....	105	BX65.....	68	BX128.....	131	CX180.....	184
AX52.....	54	AX105.....	107	BX66.....	69	BX133.....	136	CX187.....	191
AX53.....	55	AX110.....	112	BX67.....	70	BX136.....	139	CX190.....	194
AX54.....	56	AX112.....	114	BX68.....	71	BX140.....	143	CX195.....	199
AX55.....	57	AX120.....	122	BX69.....	72	BX144.....	147	CX210.....	214
AX56.....	58	AX128.....	130	BX70.....	73	BX150.....	153	CX225.....	227
AX57.....	59	AX144.....	146	BX71.....	74	BX158.....	161	CX240.....	242
AX58.....	60	AX173.....	175	BX72.....	75	BX162.....	165	CX255.....	257
AX59.....	61			BX73.....	76	BX173.....	176	CX270.....	272
AX60.....	62			BX74.....	77	BX180.....	183	CX300.....	302
AX61.....	63			BX75.....	78	BX195.....	198	CX330.....	332
AX62.....	64			BX76.....	79	BX205.....	208	CX360.....	362
AX63.....	65			BX77.....	80	BX210.....	213		
AX64.....	66			BX78.....	81	BX225.....	227		

Showing Nominal Belt Top Widths and Outside Lengths with Our Corresponding Belt Numbers

Both Truflex® and PoweRated® belts are listed for your convenience. Standard series Truflex® V-Belts are available in four different sizes: the "0000" series, "1000" series, "2000" series and "3000" series V-Belts. The second and third digits in a standard series belt number indicates the outside circumference of the belt, in inches and the fourth digit indicates additional tenths of an inch of belt length, if any.

IMPORTANT: The top width shown is the width obtained by placing a steel tape across the top of the belt. The outside length is determined by placing a steel tape around the outside of the belt. These methods have been used because they are the ones most commonly used by Dealers and Jobbers when measuring a belt.

Length (in)	Truflex® Belt No.	PoweRated® Belt No.	Length (in)	Truflex® Belt No.	PoweRated® Belt No.	Length (in)	Truflex® Belt No.	PoweRated® Belt No.
1/4" (6mm) Top Width			3/8" (10mm) Top Width - Cont.			1/2" (13mm) Top Width - Cont.		
10.....	0100		38.....	1380	6738	29.5.....	2295	
11.....	0110		39.....	1390	6739	30.....	2300	6830
12.....	0120		40.....	1400	6740	30.5.....	2305	
13.....	0130		41.....	1410	6741	31.....	2310	6831
14.....	0140		41.5.....	1415		31.75.....	2318	
15.....	0150		42.....	1420	6742	32.....	2320	6832
16.....	0160		43.....	1430	6743	32.75.....	2328	
17.....	0170		44.....	1440	6744	33.....	2330	6833
18.....	0180		45.....	1450	6745	33.25.....	2333	
19.....	0190		46.....	1460	6746	33.75.....	2338	
20.....	0200		47.....	1470	6747	34.....	2340	6834
21.....	0210		48.....	1480	6748	34.5.....	2346	
23.....	0230		49.....	1490	6749	35.....	2350	6835
24.....	0240		50.....	1500	6750	36.....	2360	6836
25.....	0250		51.....	1510	6751	37.....	2370	6837
26.....	0260		52.....	1520	6752	38.....	2380	6838
27.....	0270		53.....	1530	6753	39.....	2390	6839
28.....	0280		54.....	1540	6754	40.....	2400	6840
29.....	0290		55.....	1550	6755	40.5.....	2405	
31.....	0310		56.....	1560	6756	41.....	2410	6841
34.....	0340		57.....	1570	6757	42.....	2420	6842
35.....	0350		58.....	1580	6758	43.....	2430	6843
36.....	0360		59.....	1590	6759	44.....	2440	6844
38.....	0380		60.....	1600	6760	45.....	2450	6845
46.....	0460		61.....	1610	6761	46.....	2460	6846
3/8" (10mm) Top Width			62.....	1620	6762	47.....	2470	6847
11.....	1110		63.....	1630	6763	47.5.....	2475	
12.....	1120		64.....	1640	6764	48.....	2480	6848
13.....	1130		65.....	1650	6765	49.....	2490	6849
14.....	1140		66.....	1660	6766	50.....	2500	6850
15.....	1150		67.....	1670		51.....	2510	6851
16.....	1160	6716	67.5.....	1675		52.....	2520	6852
17.....	1170	6717	68.....	1680		53.....	2530	6853
18.....	1180	6718	69.....	1690		54.....	2540	6854
19.....	1190	6719	70.....	1700		55.....	2550	6855
20.....	1200	6720	71.....	1710		56.....	2560	6856
21.....	1210	6721	73.....	1730		57.....	2570	6857
22.....	1220	6722	74.....	1740	6774	58.....	2580	6858
23.....	1230	6723	1/2" (13mm) Top Width			59.....	2590	6859
24.....	1240	6724	15.....	2150		60.....	2600	6860
24.5.....	1245		16.....	2160		61.....	2610	6861
25.....	1250	6725	17.....	2170	6817	62.....	2620	6862
25.5.....	1255		18.....	2180	6818	63.....	2630	6863
26.....	1260	6726	18.75.....	2188		64.....	2640	6864
26.5.....	1265		19.....	2190	6819	65.....	2650	6865
27.....	1270	6727	20.....	2200	6820	66.....	2660	6866
27.5.....	1275		21.....	2210	6821	67.....	2670	6867
28.....	1280	6728	21.5.....	2215		68.....	2680	6868
28.5.....	1285		22.....	2220	6822	69.....	2690	6869
29.....	1290	6729	23.....	2230	6823	70.....	2700	6870
29.25.....	1293		23.5.....	2235		71.....	2710	6871
30.....	1300	6730	24.....	2240	6824	72.....	2720	6872
31.....	1310	6731	25.....	2250	6825	73.....	2730	6873
32.....	1320	6732	25.5.....	2255		74.....	2740	6874
33.....	1330	6733	26.....	2260	6826	75.....	2750	6875
34.....	1340	6734	27.....	2270	6827	76.....	2760	6876
34.25.....	1345		27.5.....	2275		77.....	2770	6877
35.....	1350	6735	28.....	2280	6828	78.....	2780	6878
36.....	1360	6736	28.5.....	2285		79.....	2790	6879
37.....	1370	6737	29.....	2290	6829	80.....	2800	6880
						81.....	2810	6881

Truflex® and PowerRated® - Listed by Size

Length (in)	Truflex® Belt No.	PowerRated® Belt No.	Length (in)	Truflex® Belt No.	PowerRated® Belt No.	Length (in)	Truflex® Belt No.	PowerRated® Belt No.
1/2" (13mm) Top Width - Cont.			21/32" (17mm) Top Width - Cont.			21/32" (17mm) Top Width - Cont.		
82	2820	6882	33	3330	6933	67	3670	6967
83	2830	6883	34	3340	6934	68	3680	6968
84	2840	6884	35	3350	6935	69	3690	6969
85	2850	6885	35.5	3355		70	3700	6970
86	2860	6886	36	3360	6936	71	3710	6971
87	2870	6887	37	3370	6937	72	3720	6972
88	2880	6888	38	3380	6938	73	3730	6973
89	2890	6889	39	3390	6939	74	3740	6974
90	2900	6890	40	3400	6940	75	3750	6975
91	2910	6891	41	3410	6941	76	3760	6976
92	2920	6892	42	3420	6942	77	3770	6977
93	2930	6893	43	3430	6943	78	3780	6978
94	2940	6894	44	3440	6944	79	3790	6979
95	2950	6895	45	3450	6945	80	3800	6980
96	2960	6896	46	3460	6946	81	3810	6981
97	2970	6897	47	3470	6947	82	3820	6982
98	2980	6898	48	3480	6948	83	3830	6983
99	2990	6899	49	3490	6949	84	3840	6984
100	2999	68100	50	3500	6950	85	3850	6985
105		68105	51	3510	6951	86	3860	6986
107		68107	52	3520	6952	87	3870	6987
117		68117	53	3530	6953	88	3880	6988
21/32" (17mm) Top Width			54	3540	6954	89	3890	6989
23	3230	6923	55	3550	6955	90	3900	6990
24	3240	6924	56	3560	6956	91	3910	6991
25	3250	6925	57	3570	6957	92	3920	6992
26	3260	6926	58	3580	6958	93	3930	6993
26.5	3265		59	3590	6959	94	3940	6994
27	3270	6927	60	3600	6960	95	3950	6995
28	3280	6928	61	3610	6961	96	3960	6996
29	3290	6929	62	3620	6962	97	3970	6997
30	3300	6930	63	3630	6963	98	3980	6998
31	3310	6931	64	3640	6964	99	3990	6999
32	3320	6932	65	3650	6965	100	3999	69100
			66	3660	6966			

Showing Vulco-Flex® Coolant Hose Numbers
with Corresponding Hose Inside Diameters and Lengths

Hose No.	I.D. (in)	I.D. (mm)	Length (in)	Length (mm)	Hose No.	I.D. (in)	I.D. (mm)	Length (in)	Length (mm)
26501.....	1 3/4	44	13 1/2	343	26523.....	2 1/4	57	19	483
26502.....	1 3/4	44	16 1/2	419	26524.....	2 1/4	57	24	610
26503.....	1 3/4, 2	44, 51	10	254	26525.....	2 1/4	57	27	686
26504.....	1 3/4, 2	44, 51	16 1/2	419	26526.....	2 1/4, 2 1/2	57, 64	18	457
26505.....	1 3/4, 2	44, 51	19	483	26527.....	2 1/4, 2 1/2	57, 64	21	533
26506.....	1 3/4, 2	44, 51	23 1/2	597	26528.....	2 1/4, 2 1/2	57, 64	25	635
26507.....	2	51	9 1/2	241	26529.....	2 1/2	64	11	279
26508.....	2	51	12 3/16	310	26530.....	2 1/2	64	14	356
26509.....	2	51	14 1/2	368	26531.....	2 1/2	64	16	406
26510.....	2	51	17	432	26532.....	2 1/2	64	24	610
26511.....	2	51	20	508	26533.....	2 1/2	64	28	711
26512.....	2	51	24	610	26534.....	2 3/4	70	7	178
26513.....	2	51	33	838	26535.....	2 3/4	70	14	356
26514.....	2, 2 1/4	51, 57	8 1/2	216	26536.....	2 3/4	70	18	457
26515.....	2, 2 1/4	51, 57	15	381	26537.....	2 3/4	70	32	813
26516.....	2, 2 1/4	51, 57	17 1/2	445	26538.....	3	76	37	940
26517.....	2, 2 1/4	51, 57	25	635	26601.....	1 3/4	44	6	152
26518.....	2, 2 1/2	51, 64	20	508	26602.....	1 3/4	44	8 1/2	216
26519.....	2 1/4	57	9	229	26603.....	1 3/4	44	11	279
26520.....	2 1/4	57	11	279	26611.....	1 3/4	44	19	483
26521.....	2 1/4	57	14	356	26612.....	1 3/4	44	23 1/2	597
26522.....	2 1/4	57	17	432					

Length is Centerline Length.

Showing Inside Diameters and Lengths
with Corresponding Vulco-Flex® Coolant Hose Numbers

Length (in)	Length (mm)	Hose No.	Length (in)	Length (mm)	Hose No.	Length (in)	Length (mm)	Hose No.
1 3/4" (44mm) I.D.			2" (51mm), 2 1/4" (57) I.D.			2 1/2" (64mm) I.D.		
6.....	152	26601	8 1/2.....	216	26514	11.....	279	26529
8 1/2.....	216	26602	15.....	381	26515	14.....	356	26530
11.....	279	26603	17 1/2.....	445	26516	16.....	406	26531
13 1/2.....	343	26501	25.....	635	26517	24.....	610	26532
16 1/2.....	419	26502	2" (51mm), 2 1/2" (64) I.D.			28.....	711	26533
19.....	483	26611	20.....	508	26518	2 3/4" (70mm) I.D.		
23 1/2.....	597	26612	2 1/4" (57mm) I.D.			7.....	178	26534
1 3/4" (44mm), 2" (51mm) I.D.			9.....	229	26519	14.....	356	26535
10.....	254	26503	11.....	279	26520	18.....	457	26536
16 1/2.....	419	26504	14.....	356	26521	32.....	813	26537
19.....	483	26505	17.....	432	26522	3" (76mm) I.D.		
23 1/2.....	597	26506	19.....	483	26523	37.....	940	26538
2" (51mm) I.D.			24.....	610	26524			
9 1/2.....	241	26507	27.....	686	26525			
12 3/16.....	310	26508	2 1/4" (57mm), 2 1/2" (64) I.D.					
14 1/2.....	368	26509	18.....	457	26526			
17.....	432	26510	21.....	533	26527			
20.....	508	26511	25.....	635	26528			
24.....	610	26512						
33.....	838	26513						

Length is Centerline Length.

Showing Vulco-Flex® II Coolant Hose Numbers with Corresponding Hose Inside Diameters and Lengths

Hose No.	I.D. (in)	I.D. (mm)	Length (in)	Length (mm)	Hose No.	I.D. (in)	I.D. (mm)	Length (in)	Length (mm)
25150.....	1 1/8	28	12	305	25384.....	1 3/8	35	25	635
25152.....	1 1/8	28	15	381	25409.....	1 3/8, 1 1/2	35, 38	26	660
25154.....	1 1/8	28	18	457	25428.....	1 3/8, 1 5/8	35, 41	17	432
25157.....	1 1/8	28	23	584	25472.....	1 1/2	38	8	203
25180.....	1 1/8, 1 1/4	28,32	19	483	25473.....	1 1/2	38	10 1/2	267
25249.....	1 1/4	32	7 1/2	191	25474.....	1 1/2	38	12	305
25250.....	1 1/4	32	9 1/2	241	25476.....	1 1/2	38	14	356
25251.....	1 1/4	32	13	330	25477.....	1 1/2	38	15 1/2	394
25252.....	1 1/4	32	15	381	25478.....	1 1/2	38	17	432
25253.....	1 1/4	32	17	432	25480.....	1 1/2	38	20	508
25254.....	1 1/4	32	18 1/2	470	25482.....	1 1/2	38	22	559
25255.....	1 1/4	32	20	508	25484.....	1 1/2	38	25	635
25257.....	1 1/4	32	23	584	25487.....	1 1/2	38	30	762
25260.....	1 1/4	32	26 1/2	673	25490.....	1 1/2	38	35	889
25262.....	1 1/4	32	30	762	25499.....	1 1/2	38	48	1219
25265.....	1 1/4	32	35	889	25526.....	1 1/2, 1 3/4	38, 44	13 3/16	335
25269.....	1 1/4	32	41	1041	25527.....	1 1/2, 1 3/4	38, 44	15	381
25284.....	1 1/4, 1 3/8	32,35	26	660	25528.....	1 1/2, 1 3/4	38, 44	16 1/2	419
25300.....	1 1/4, 1 1/2	32, 38	12	305	25530.....	1 1/2, 1 3/4	38, 44	20	508
25302.....	1 1/4, 1 1/2	32, 38	15 1/2	394	25532.....	1 1/2, 1 3/4	38, 44	22	559
25305.....	1 1/4, 1 1/2	32, 38	19 1/2	495	25535.....	1 1/2, 1 3/4	38, 44	27	686
25307.....	1 1/4, 1 1/2	32, 38	23	584	25582.....	1 1/2, 2	38, 51	22	559
25309.....	1 1/4, 1 1/2	32, 38	26	660	25804.....	▲ 1 1/2	38	20	508
25311.....	1 1/4, 1 1/2	32, 38	29	737	25806.....	▲ 1 1/2	38	23 3/16	589
25321.....	1 1/4, 1 1/2	32, 38	44	1118	25808.....	▲ 1 1/2	38	25 11/16	653

▲ 90° Molded Elbow on One End.

Length is Centerline Length.

Showing Inside Diameters and Lengths
with Corresponding Vulco-Flex® II Coolant Hose Numbers

Length (in)	Length (mm)	Hose No.	Length (in)	Length (mm)	Hose No.	Length (in)	Length (mm)	Hose No.
1 1/8" (28mm) I.D.			1 1/4" (32mm), 1 1/2" (38mm) I.D.			1 1/2" (38mm) I.D. - Cont.		
12	305	25150	12	305	25300	20	508	25480
15	381	25152	15 1/2	394	25302	20	508	▲ 25804
18	457	25154	19 1/2	495	25305	22	559	25482
23	584	25157	23	584	25307	23 3/16	589	▲ 25806
1 1/8" (28mm), 1 1/4" (32mm) I.D.			26	660	25309	25	635	25484
19	483	25180	29	737	25311	25 11/16	653	▲ 25808
1 1/4" (32mm) I.D.			44	1118	25321	30	762	25487
7 1/2	191	25249	1 3/8" (35mm) I.D.			35	889	25490
9 1/2	241	25250	25	635	25384	48	1219	25499
13	330	25251	1 3/8" (35mm), 1 1/2" (38mm) I.D.			1 1/2" (38mm), 1 3/4" (44mm) I.D.		
15	381	25252	26	660	25409	13 3/16	335	25526
17	432	25253	1 3/8" (35mm), 1 5/8" (41mm) I.D.			15	381	25527
18 1/2	470	25254	17	432	25428	16 1/2	419	25528
20	508	25255	1 1/2" (38mm) I.D.			20	508	25530
23	584	25257	8	203	25472	22	559	25532
26 1/2	673	25260	10 1/2	267	25473	27	686	25535
30	762	25262	12	305	25474	1 1/2" (38mm), 2" (51mm) I.D.		
35	889	25265	14	356	25476	22	559	25582
41	1041	25269	15 1/2	394	25477			
1 1/4" (32mm), 1 3/8" (35mm) I.D.			17	432	25478			
26	660	25284						

▲ 90° Molded Elbow on One End.

Length is Centerline Length.

Showing Manufacturers' Part Numbers for Air Vent Hose With Our Corresponding Replacement Numbers

Mfr. Part No.	Hose No.	Mfr. Part No.	Hose No.	Mfr. Part No.	Hose No.	Mfr. Part No.	Hose No.
0172332	24317	2339H21	23005	3827885	24324	66RU213	23002
0172340	24324	2364673	24324	3829421	24317	66RU226P12	23002
027015631	23218	2389H2	23002	3834561	24324	66RU226P2	23006
027015792	23005	2434355	23005	3839436	24314	66RU226P22	23107
027016847	23106	2489039	24327	3839761	24314	66RU27P1	23005
027105709	23215	2489075	24327	3839762	24314	66RU27P4	23101
027115989	23300	2494361	24327	3845511	24317	66RU27P7	23106
03117220	23218	2505990	23005	3845512	24317	672313	23216
039177	≈ 23005	255162C2	23005	3853336	24311	672889	23005
0391772	23002	2694361	24327	3856649	24310	686775C1	≈ 23201
0505639BA	23218	2788H216	23218	3856988	24324	688261	23215
0508332RA	23221	2825685	23005	3858411	24316	699884	≈ 23005
0510199	23218	288343C1	23005	3858412	24316	6CA01222	23005
055637	23215	301467R1	23005	3858649	24317	6CD01222	23002
055639	23218	30146R1	23005	3858650	24317	6CM01222	23106
055641	23005	302699	23218	3861379	24316	6CS01221	23218
055646	23106	3030788	23002	3861442	24316	70590906	≈ 23201
055649	23006	304056	23002	3861680	24316	713069	23300
056332	23004	304058	23005	3862819	24324	722964	23221
056540	23216	304874R1	23005	3864640	24316	724301	23002
058332	23221	3132144R1	24326	3867080	24312	724477	≈ 23005
1030227	23221	314902R1	23006	3867081	24312	764713C1	23218
103807	23002	319119C1	23005	3870215	24317	792925	23107
103808	≈ 23005	319119CC1	23005	3870283	24324	757755	23004
105314	23221	321891R1	23106	3875861	24316	8713132	23002
105315	23202	329060R1	23005	3885138	≈ 24310	88163R1	≈ 23002
109181	23005	3295H2	≈ 23005	3895470	24310	9002889	23106
10A19587	≈ 23201	345467C1	23006	3895482	24316	9036168	23221
124159	≈ 23005	362943C1	23006	3895939	≈ 24316	985203R1	23005
14017	23002	362946C7	23215	3897882	24314	986634R1	23002
140171	23002	3745593	24324	3899722	24316	C3TZ 9B613 A	23002
142483	23202	3746662	24324	3902109	24317	C6TZ 9B613 C	23218
151614	23106	3747133	24310	3904060	23101	C6TZ 9B613 D	23209
1522449	23100	3747134	24310	3905094	24317	C6TZ 9C681 E	23006
1522454	23106	3747316	24310	3906412	24326	C8HA 9B699 C	23209
1522457	23005	3747347	24317	3906480	≈ 24324	DOHA 9B699 H	23215
1529295	23215	3747348	24317	3924539	24306	DOHA 9C681 E	23218
1529315	23218	3747475	24326	3937902	24312	DOHA 9C682 B	23004
1531808	23209	3747476	24314	3946963	24308	DOHZ 9B613 H	23004
15MD1254	23221	3751123	24324	3946964	24308	DOHZ 9B613 K	23215
162206	23005	3752275	24324	396313C1	23218	DOHZ 9C681 E	23218
1701570	23005	3756896	24314	407026C1	23218	GBK11272	23402
1712171	23002	3758482	24317	407524	23002	K123143	23300
1718522	23005	3758483	24317	414974C1	23300	K12350	23218
174608	23005	3765549	24310	425309R1	23006	K12351	23215
176034	23002	3766764	24317	427305R1	23221	K12381	23216
177174	23106	3766765	24324	431714R1	≈ 23203	K12384	23209
177174H1	23106	3766816	24317	439682C1	23006	K12385	23208
198811R1	23005	3768178	24310	44Z867D5	23218	K123A51	23215
1AAA04	23209	3771019	24324	481374C1	23004	K123B140	23221
1AAA06	23218	3773811	24317	508694	23002	K123B150	23218
1AAA13	23208	3777947	24310	513864	23005	K123B50	23218
1AAA15	23215	3777948	24310	515424	23002	K123B51	23218
1AAA23	23002	3785921	24314	536798	23006	K123B65	23215
1AAA25	23004	3785923	24314	538459	23002	K123B78	23400
1AAA26	23005	3786410	24324	542060	23005	K123B81	23216
1AAA27	23006	3789169	24312	590906	≈ 23201	K123B84	23209
1AAA36	23106	3791182	24314	5MD1224	23218	K123B85	23208
1AAA51	23216	3791183	24314	5MD2528	23201	K123C104	23218
2014372	23208	3791184	24314	5MD2589	23216	K34211	23005
2039929	23006	3792425	24314	603961C1	23005	K34212	23002
2041705	23006	3794411	24310	638459	23002	K34225	23106
2070456	23218	3796657	24310	638967A	23400	K34227	23006
2084361	23221	3812768	24324	643348C1	23218	K34260	23004
20MD19311	23106	3818479	≈ 24324	657996	23006	N50204C	23002
20MD29306P2	23218	3821940	24312	657997	23218	N50204E	23005
20MD29306P3	23215	3827026	24314	658162	23106	NA005906	23218
20MD29320P1	23300	3827027	24314	66RU180	23215	R29405R	23005
221229	23218	3827550	24312	66RU188	23006	S87805	23005
223150002	23006	3827552	24312	66RU198	23006	SR35222	23005

≈ Cut to Fit.

Air Vent Hose Dimensions

Use the chart below to locate the part number or hose type required. The column heading titled Row No. refers to the row an illustration and dimensions appear in the following pages.

Part No.	Hose Type	Row No.
23002	Hump	2
23004	Hump	2
23005	Hump	2
23006	Hump	2
23100	Reducer Hump	3
23101	Reducer Hump	3
23106	Reducer Hump	3
23107	Reducer Hump	3
23201	90° Elbow	7
23202	45° Elbow	5
23203	90° Elbow	7
23208	45° Elbow	5
23209	90° Elbow	7
23215	45° Elbow (Ribbed)	4
23216	54° Elbow (Ribbed)	6
23218	90° Elbow (Ribbed)	8
23221	90° Elbow (Ribbed)	8
23300	90° Reducing Elbow	9
23400	Straight Flexible	1
23401	Straight Flexible	1
23402	Straight Flexible	1

1. Straight Flexible

A I.D. (In.)	B Lgth. (In.)	Part No.	Wt. Per Piece (Lbs.)
4	22	23400	.96
6	19	23401	1.46
6-1/8	19	23402	1.47

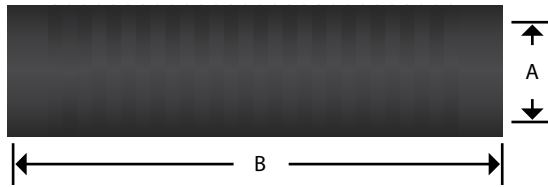

2. Hump

A I.D. (In.)	B Lgth. (In.)	Part No.	Wt. Per Piece (Lbs.)
4	5	23002	.63
5	6	23004	1.21
5-1/2	6	23005	1.32
6	5	23006	1.22

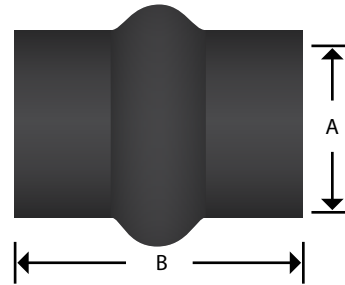

3. Reducer Hump

I.D. (In.)		B Lgth. (In.)	Part No.	Wt. Per Piece (Lbs.)
From A	To C			
3-1/2	3	5-1/4	23100	1.38
4	3	5-1/4	23101	1.06
6	5-1/2	6	23106	1.69
7	6	6	23107	1.92

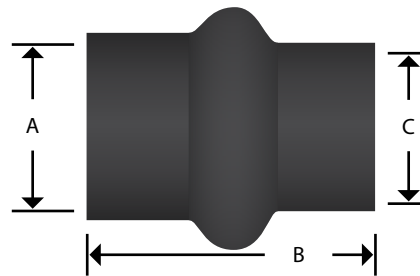

4. 45° Elbow (Ribbed Construction)

A I.D. (In.)	Part No.	Wt. Per Piece (Lbs.)
6	23215	2.48

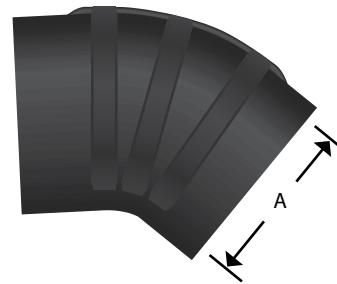

5. 45° Elbow

A I.D. (In.)	Part No.	Wt. Per Piece (Lbs.)
3-1/2	23202	.85
5	23208	1.27

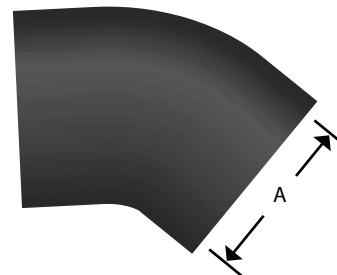

6. 54° Elbow (Ribbed Construction)

A I.D. (In.)	Part No.	Wt. Per Piece (Lbs.)
6	23216	3.10

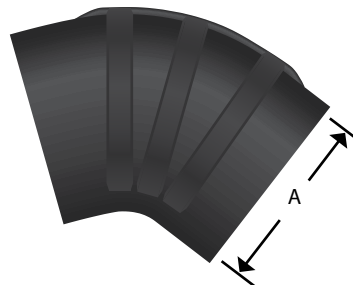

7. 90° Elbow

A I.D. (In.)	Part No.	Wt. Per Piece (Lbs.)
3	23201	1.23
3-1/2	23203	1.31
5	23209	2.51

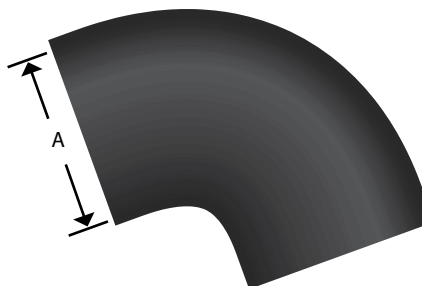

8. 90° Elbow (Ribbed Construction)

A I.D. (In.)	Part No.	Wt. Per Piece (Lbs.)
6	23218	4.08
7	23221	6.55

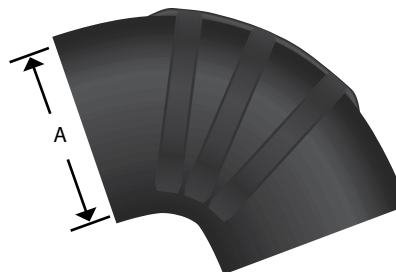

9. 90° Reducing Elbow (Ribbed Construction)

A I.D. (In.)	B Lgth. (In.)	Part No.	Wt. Per Piece (Lbs.)
5-1/2	6	23300	3.50

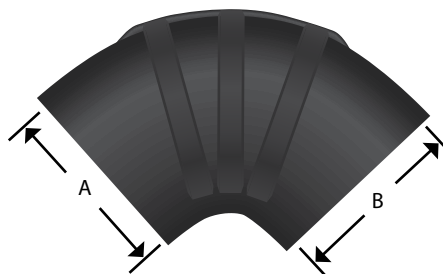

Changeover Listing - FleetRunner®

FleetRunner® V-Belt to XL® V-Belt Numbers

FleetRunner® HD V-Belt Part No.	XL® V-Belt Part No.	FleetRunner® HD V-Belt Part No.	XL® V-Belt Part No.	FleetRunner® HD V-Belt Part No.	XL® V-Belt Part No.	FleetRunner® HD V-Belt Part No.	XL® V-Belt Part No.
9290HD	9290	9400HD	9400	9495HD	9495	9620HD	9620
9305HD	9305	9403HD	9403	9500HD	9500	9625HD	9625
9309HD	9309	9405HD	9405	9505HD	9505	9630HD	9630
9313HD	9313	9412HD	9412	9510HD	9510	9635HD	9635
9319HD	9319	9415HD	9415	9520HD	9520	9640HD	9640
9325HD	9325	9420HD	9420	9525HD	9525	9650HD	9650
9330HD	9330	9425HD	9425	9530HD	9530	9660HD	9660
9335HD	9335	9430HD	9430	9540HD	9540	9670HD	9670
9341HD	9341	9435HD	9435	9545HD	9545	9680HD	9680
9345HD	9345	9440HD	9440	9550HD	9550	9690HD	9690
9350HD	9350	9447HD	9447	9555HD	9555	9700HD	9700
9355HD	9355	9451HD	9451	9560HD	9560	9710HD	9710
9360HD	9360	9455HD	9455	9565HD	9565	9720HD	9720
9365HD	9365	9463HD	9463	9570HD	9570	9730HD	9730
9370HD	9370	9465HD	9465	9580HD	9580	9740HD	9740
9375HD	9375	9470HD	9470	9585HD	9585	9745HD	9745
9380HD	9380	9476HD	9476	9590HD	9590	9755HD	9755
9385HD	9385	9480HD	9480	9600HD	9600		
9390HD	9390	9485HD	9485	9605HD	9605		
9395HD	9395	9490HD	9490	9610HD	9610		

FleetRunner® Micro-V® to Century™ Series Micro-V® Belt Numbers

FleetRunner® Micro-V® Part No.	Micro-V® Belt Part No.	FleetRunner® Micro-V® Part No.	Micro-V® Belt Part No.	FleetRunner® Micro-V® Part No.	Micro-V® Belt Part No.	FleetRunner® Micro-V® Part No.	Micro-V® Belt Part No.
K040378HD	K040378	K060483HD	K060483	K060658HD	K060658	K060970HD	K060970
K040388HD	K040388	K060490HD	K060490	K060660HD	K060660	K060988HD	K060988
K040425HD	K040425	K060495HD	K060495	K060670HD	K060670	K060990HD	K060990
K040430HD	K040430	K060500HD	K060500	K060672HD	K060672	K060994HD	K060994
K040445HD	K040445	K060505HD	K060505	K060675HD	K060675	K060997HD	K060997
K040745HD	K040745	K060509HD	K060509	K060680HD	K060680	K061000HD	K061000
K040762HD	K040762	K060516HD	K060516	K060685HD	K060685	K061005HD	K061005
K050323HD	K050323	K060520HD	K060520	K060690HD	K060690	K061010HD	K061010
K050336HD	K050336	K060523HD	K060523	K060696HD	K060696	K061015HD	K061015
K050340HD	K050340	K060525HD	K060525	K060716HD	K060716	K061020HD	K061020
K050345HD	K050345	K060529HD	K060529	K060735HD	K060735	K061058HD	K061058
K050350HD	K050350	K060532HD	K060532	K060739HD	K060739	K061080HD	K061080
K050360HD	K050360	K060539HD	K060539	K060747HD	K060747	K061140HD	K061140
K050375HD	K050375	K060547HD	K060547	K060772HD	K060772	K061177HD	K061177
K050380HD	K050380	K060555HD	K060555	K060795HD	K060795	K061187HD	K061187
K050420HD	K050420	K060557HD	K060557	K060806HD	K060806	K061195HD	K061195
K060340HD	K060340	K060559HD	K060559	K060812HD	K060812	K061203HD	K061203
K060374HD	K060374	K060560HD	K060560	K060828HD	K060828	K061265HD	K061265
K060390HD	K060390	K060569HD	K060569	K060832HD	K060832	K061360HD	K061360
K060393HD	K060393	K060575HD	K060575	K060849HD	K060849	K061369HD	K061369
K060400HD	K060400	K060578HD	K060578	K060858HD	K060858	K070553HD	K070553
K060408HD	K060408	K060586HD	K060586	K060860HD	K060860	K070640HD	K070640
K060415HD	K060415	K060594HD	K060594	K060870HD	K060870	K070673HD	K070673
K060420HD	K060420	K060598HD	K060598	K060875HD	K060875	K070677HD	K070677
K060425HD	K060425	K060605HD	K060605	K060883HD	K060883	K070705HD	K070705
K060435HD	K060435	K060615HD	K060615	K060905HD	K060905	K070709HD	K070709
K060439HD	K060439	K060625HD	K060625	K060908HD	K060908	K070733HD	K070733
K060455HD	K060455	K060628HD	K060628	K060910HD	K060910	K070735HD	K070735
K060458HD	K060458	K060631HD	K060631	K060923HD	K060923	K070786HD	K070786
K060470HD	K060470	K060635HD	K060635	K060930HD	K060930	K070801HD	K070801
K060478HD	K060478	K060637HD	K060637	K060935HD	K060935	K070825HD	K070825
K060480HD	K060480	K060653HD	K060653	K060960HD	K060960	K070835HD	K070835

FleetRunner® Micro-V® to Century™ Series Micro-V® Belt Numbers

FleetRunner® Micro-V® Part No.	Micro-V® Belt Part No.	FleetRunner® Micro-V® Part No.	Micro-V® Belt Part No.	FleetRunner® Micro-V® Part No.	Micro-V® Belt Part No.	FleetRunner® Micro-V® Part No.	Micro-V® Belt Part No.
K071056HD	K071056	K080726HD	K080726	K081092HD	K081092	K100885HD	K100886
K071247HD	K071247	K080730HD	K080730	K081102HD	K081102	K100891HD	K100891
K080330HD	K080330	K080733HD	K080733	K081124HD	K081124	K100955HD	K100955
K080375HD	K080375	K080734HD	K080734	K081153HD	K081153	K100976HD	K100976
K080382HD	K080382	K080738HD	K080738	K081177HD	K081177	K101078HD	K101078
K080384HD	K080384	K080740HD	K080740	K081189HD	K081189	K120281HD	K120281
K080400HD	K080400	K080745HD	K080745	K081196HD	K081196	K120360HD	K120360
K080415HD	K080415	K080751HD	K080751	K081207HD	K081207	K120390HD	K120390
K080427HD	K080427	K080755HD	K080755	K081213HD	K081213	K120400HD	K120400
K080435HD	K080435	K080760HD	K080760	K081223HD	K081223	K120410HD	K120410
K080450HD	K080450	K080765HD	K080765	K081265HD	K081265	K120457HD	K120457
K080465HD	K080465	K080774HD	K080774	K081298HD	K081298	K120477HD	K120477
K080471HD	K080471	K080776HD	K080776	K081325HD	K081325	K120525HD	K120525
K080485HD	K080485	K080780HD	K080780	K081331HD	K081331	K120559HD	K120559
K080496HD	K080496	K080785HD	K080785	K081348HD	K081348	K120594HD	K120594
K080505HD	K080505	K080790HD	K080790	K081359HD	K081359	K120606HD	K120606
K080510HD	K080510	K080797HD	K080797	K081377HD	K081377	K120610HD	K120610
K080514HD	K080514	K080806HD	K080806	K090500HD	K090500	K120702HD	K120702
K080525HD	K080525	K080810HD	K080810	K090609HD	K090609	K120720HD	K120720
K080530HD	K080530	K080816HD	K080816	K100381HD	K100381	K120734HD	K120734
K080537HD	K080537	K080817HD	K080817	K100437HD	K100437	K120738HD	K120738
K080545HD	K080545	K080820HD	K080820	K100456HD	K100456	K120784HD	K120784
K080550HD	K080550	K080825HD	K080825	K100465HD	K100465	K120815HD	K120815
K080560HD	K080560	K080830HD	K080830	K100485HD	K100485	K120842HD	K120842
K080565HD	K080565	K080839HD	K080839	K100495HD	K100495	K120852HD	K120852
K080566HD	K080566	K080842HD	K080842	K100502HD	K100502	K120858HD	K120858
K080570HD	K080570	K080855HD	K080855	K100510HD	K100510	K120864HD	K120864
K080575HD	K080575	K080859HD	K080859	K100535HD	K100535	K120872HD	K120872
K080580HD	K080580	K080865HD	K080865	K100540HD	K100540	K120878HD	K120878
K080585HD	K080585	K080872HD	K080872	K100554HD	K100554	K120891HD	K120891
K080590HD	K080590	K080876HD	K080876	K100563HD	K100563	K120901HD	K120901
K080594HD	K080594	K080878HD	K080878	K100570HD	K100570	K120903HD	K120903
K080600HD	K080600	K080893HD	K080893	K100572HD	K100572	K120911HD	K120911
K080605HD	K080605	K080897HD	K080897	K100575HD	K100575	K120915HD	K120915
K080610HD	K080610	K080903HD	K080903	K100579HD	K100579	K120919HD	K120919
K080615HD	K080615	K080910HD	K080910	K100594HD	K100594	K120924HD	K120924
K080620HD	K080620	K080913HD	K080913	K100607HD	K100607	K120931HD	K120931
K080623HD	K080623	K080915HD	K080915	K100610HD	K100610	K120964HD	K120964
K080626HD	K080626	K080922HD	K080922	K100618HD	K100618	K120975HD	K120979
K080630HD	K080630	K080926HD	K080926	K100630HD	K100630	K121039HD	K121039
K080645HD	K080645	K080934HD	K080934	K100637HD	K100637	K140345HD	K140345
K080649HD	K080649	K080939HD	K080939	K100640HD	K100640	K140370HD	K140370
K080653HD	K080653	K080944HD	K080944	K100655HD	K100655	K140429HD	K140429
K080660HD	K080660	K080948HD	K080948	K100658HD	K100658	K140433HD	K140433
K080665HD	K080665	K080952HD	K080952	K100665HD	K100665	K140451HD	K140451
K080670HD	K080670	K080956HD	K080956	K100670HD	K100670	K140496HD	K140496
K080672HD	K080672	K080968HD	K080968	K100675HD	K100675	K140516HD	K140516
K080675HD	K080675	K080986HD	K080986	K100677HD	K100677	K140524HD	K140524
K080677HD	K080677	K080991HD	K080991	K100694HD	K100694	K140555HD	K140555
K080680HD	K080680	K081000HD	K081000	K100710HD	K100710	K140580HD	K140580
K080685HD	K080685	K081005HD	K081005	K100719HD	K100719	K140594HD	K140594
K080690HD	K080690	K081020HD	K081020	K100731HD	K100731	K140597HD	K140597
K080694HD	K080694	K081023HD	K081023	K100739HD	K100739	K140603HD	K140603
K080700HD	K080700	K081035HD	K081035	K100749HD	K100749	K140618HD	K140618
K080702HD	K080702	K081051HD	K081051	K100771HD	K100771	K140627HD	K140627
K080708HD	K080708	K081059HD	K081059	K100789HD	K100789	K140662HD	K140662
K080710HD	K080710	K081074HD	K081074	K100810HD	K100810	K140682HD	K140682
K080716HD	K080716	K081079HD	K081079	K100852HD	K100852	K140700HD	K140700
K080720HD	K080720	K081088HD	K081088	K100884HD	K100884		



OUR WORK IS OUR BOND



CENTURY SERIES MICRO-V® BELTS

The culmination of a century of hard work is embodied by Gates Century Series. We've taken the best belt technology and advanced it with superior construction, exceptional fit, durability and value. Century Series is our commitment that we've created the right belt for the right application. Our work is our bond.

GatesCenturySeries.com



Manufacturing Facilities, Distribution Centers, Technical Centers, and Sales/Service Centers Worldwide



POWERING PROGRESS™

Fleet + Heavy Duty Applications, including:

School Buses
[All Years]

Refrigeration
Units [All Years]

Transit Buses
[All Years]

Lift + Industrial
Equipment [All Years]

Road + Construction
Equipment [All Years]

Power Units
[All Years]

GATES CORPORATION - WORLD HEADQUARTERS
1551 Wewatta Street / P.O. Box 5887
Denver, Colorado 80217, U.S.A.
800.366.3128 / Fax 303.744.4499
Gates.com

431-2030

2016



Please recycle this catalog!

Printed in the U.S.A.